

“ONE” A NEW TOOL FOR SUPPLY CHAIN NETWORK OPTIMIZATION AND SIMULATION

Hongwei Ding
Lyès Benyoucef
Xiaolan Xie

INRIA-Lorraine, MACSI Project
ISGMP, Bat. A, Ile du Saulcy
Metz, 57000, FRANCE

Carl Hans
Jens Schumacher

BIBA
Hochschulring 20, D-28359
P.O.Box 330560 D-28335
Bremen, GERMANY

ABSTRACT

Nowadays, in a hotly competitive environment, companies are continuously trying to provide products and/or services to customers faster, cheaper, and better than the competitors do. Managers have learned that they cannot do it alone; rather, they must work on a cooperative basis with other organizations in order to succeed. Although the resulting enterprise networks are more competitive, the tasks for planning, management and optimization are much more difficult and complex. In this paper, we present a newly developed toolbox “ONE” to support decision makers for the assessment, design and improvement of such supply chain networks. The toolbox comprises innovative and user-friendly concepts related to the modeling, simulation and optimization of enterprise networks by additionally taking into account social and environmental impacts as well as uncertainty and risk that are always inherent within modern enterprise networks.

1 CONTEXT AND MOTIVATIONS

The global economy and the recent developments in IC technologies have significantly modified the business organization of enterprises and the way that they do business. New forms of organizations such as extended enterprises and virtual enterprises turn to appear and they are quickly adopted by most leading enterprises. It is noticed that “competition in the future will not be between individual organizations but between competing supply chains” (Christopher, 1992). Thus, business opportunities are captured by groups of enterprises in the same enterprise network. The main reason for this change is the global competition that forces enterprises to focus on their core competences (i.e. to do what you do the best and let others do the rest). According to a visionary report of Manufacturing Challenges 2020 conducted in USA, this trend will continue and one of the six grand challenges of this visionary report is the ability to re-configure manufacturing enterprises rapidly in response to changing needs and opportunities.

While alliances like enterprise networks with the underlying supply network represent tremendous business opportunities, they also make the involved enterprises face greater uncertainties and risks. Firstly, networks or some of the underlying supply chains have to be modified or dissolved once the business opportunities evolve or disappear. Secondly, changes or major perturbations at one enterprise may propagate through the whole network to other enterprises and hence influence on their performances. The evolution from single enterprise with a high vertical range of manufacture towards enterprise networks offers new business opportunities especially for Small and Medium Enterprises (SME) that are usually more flexible than larger companies are. However, in order to be successful existing risks and uncertainties as well as possible bottlenecks, performances and expected benefits have to be carefully evaluated and balanced in order to become a partner of the right network for the right task. All these issues have to be taken into account in order to find an efficient, flexible, robust and sustainable solution.

In the area of production, these networks involve transformation processes from raw material through several stages of manufacturing, assembly and distribution to finished products, which are finally delivered to customers. It also includes flows of information and finance in addition to the material flow. Each stage of material transformation or distribution may involve inputs coming from several suppliers and outputs going to several intermediate customers. Each stage may also involve information and material flows connected with some intermediate and distant stages. The underlying supply chains are complex and their analysis requires a carefully defined approach. Moreover, as technological complexity has increased, supply chains and thus such production networks have become more dynamic and complex to handle. Consequently, it is easy to get lost in details and spend a large amount of efforts for analyzing the supply chain without meaningful results. On the other hand, it is also possible to execute too simplistic analysis and miss critical issues, particularly us-

ing tools excluding simulation. This is particularly the case where uncertainty and risk are largely involved.

Another issue coming along with the design and management of enterprise networks is the great variety of available policies and alternatives for each of these problems (design and management), by the need to assess complex trade-offs between conflicting objectives (cost, product quality, delivery time, etc.). Hence, a comprehensive and efficient strategic design of enterprise networks requires the determination of:

- The number, location, capacity, and type of manufacturing plants, warehouses, and distribution centers to be used.
- The set of suppliers to be engaged.
- The transportation modes to be used.
- The quantity of raw materials and finished products to purchase, produce, store and transport modes among suppliers, plants, warehouses, distribution centers, and customers.

All the decisions listed above are not trivial, especially at the international level and have to be taken under consideration of risks and uncertainties in order to come to network configurations that are not only efficient but also robust. Clearly, a suitable software environment is needed to support the decision-maker in the performance evaluation task of the whole supply chain.

Simulation has been identified as one of the best means to analyze and deal with stochastic facets existing in supply chain (Schunk and Plott, 2000; Ingalls, 1998). Its capability of capturing uncertainty and, complex system dynamics makes it well suited for supply chain studies. It can help the optimization process by evaluating the impact of alternative policies. Therefore, many tools have been developed to facilitate the use of simulation in designing, evaluating, and optimizing supply chains, such as IBM Supply Chain Analyzer, Autofat, Supply Chain Guru, Simflex, etc. Supply chain simulation involves the simulation of the flow of material and information through multiple stages of manufacturing, transportation and distribution. It further includes the simulation of the replenishments of inbound inventory and operations at each manufacturing stage as well as outbound shipments for the products from one stage to the next. Running a supply chain simulation requests many decisions including: raw material supply, production planning/scheduling, inventory control, distribution planning. Numerous random factors influence on the performances like random transportation times, demand fluctuations, supply disruptions.

On the other hand, thanks to several decades of theoretical and tool developments, state-of-the-art optimization engines such as ILOG-CPLEX and DASH-XPRESS have been proven to be able to solve programming problems with millions of variables and millions of constraints. These optimization engines are now used to power advanced Supply

Chain Management tools (I2, Manugistics, Peoplesoft, SAP, etc.) for solving complex supply chain planning/scheduling problems. The optimization engine providers and SCM tool providers frequently report impressive success stories. The strength of SCM tools rests in their capability to efficiently coordinate activities through the whole supply chain: from demand planning to procurement, manufacturing, inventory control and distribution. The activities that were optimized locally in the past are now considered in a global context using of current SCM tools.

In the aforementioned industrial context, we have developed a new toolbox “ONE” for supply chain network simulation and optimization. The toolbox is the result of a European research project named ONE (Optimization methodology for Networked Enterprise). In Section 2, we give a brief presentation of the project, dedicated to enterprise network modeling and optimization. A simulation-based multi-objective optimization approach, which is the core module of the presented toolbox, is described in Section 3. Section 4 shows how the approach is applied on a real-life case study. In Section 5, we conclude with some remarks and perspectives for further research of network design and improvement.

2 ONE ‘OPTIMIZATION METHODOLOGIES FOR NETWORKED ENTERPRISES’ PROJECT

In this section, we present the context and objectives of the project ONE, and the architecture of the resulting toolbox.

2.1 ONE Context and Objectives

The scientific and technical objectives of ONE request the development of a fully validated decision support tool for the assessment, design and optimization of enterprise networks with respect to economic, social and environmental criteria. The tool focuses on decision-making at the strategic/tactical level. It allows a holistic approach with a continuous view on the whole network, realizes the coupling of simulation and optimization and supports the consideration of social and environmental impacts coming along with certain network configurations as well as the explicit management of uncertainty and risk. These objectives were achieved by constructing and integrating different components covering: statistical data mining and validation, modeling, simulation and optimization of enterprise networks.

2.2 ONE Architecture

The ONE architecture, shown in Figure 1, reflects the aforementioned functionalities by comprising the following modules:

- The Network Module supporting an interactive development of enterprise network models and

their underlying supply chains under the consideration of stochastic aspects and variability.

- The Optimization Module offering a set of optimization methods including mathematical programming (MP) and genetic algorithm (GA).
- The Statistical Data Miner offering a set of data mining methods for applications in order to improve the supply chain network evaluation with company-specific data.
- The Simulation module for the evaluation of enterprise network models.

All of these modules have been realized and integrated within a user-friendly toolbox that addresses in particular the needs of decision makers for the design and management of enterprise networks.

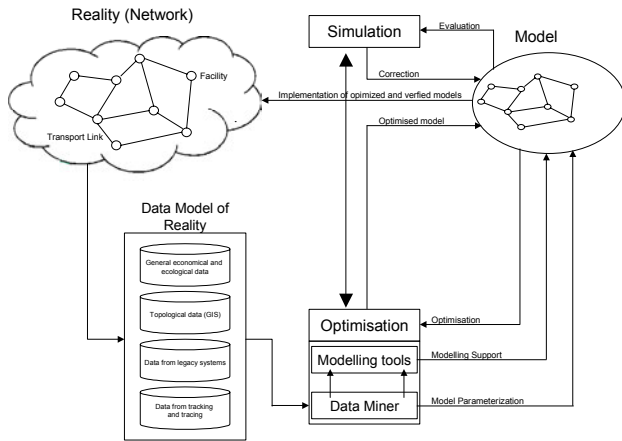

Figure 1: Architecture of ONE

3 ONE APPROACH

3.1 Overview

The main characteristics of ONE approach, with respect to the commercial software, are respectively:

- The modeling of variability, uncertainty and risks and their impact on the supply chains processes.
- The inclusion of dynamic forecasting in addition to simulation.
- The incorporation of social/environmental criteria in addition to economics.
- The use of global, multi-objective and real time dynamic optimization.
- The coupling of optimization with simulation.
- The possibility to use and define default cost models for transportation costs and social/environmental criteria.

While using the ONE tool the following, main logical steps should be performed as illustrated in Figure 2. The

first step is the identification of the problem and scenario (number and location of possible plants, suppliers, distribution centers, etc.). It is important to include in this scenario all of the elements for other possible configurations which shall be considered by ONE, because the system finds the optimal solution only between the specified elements.

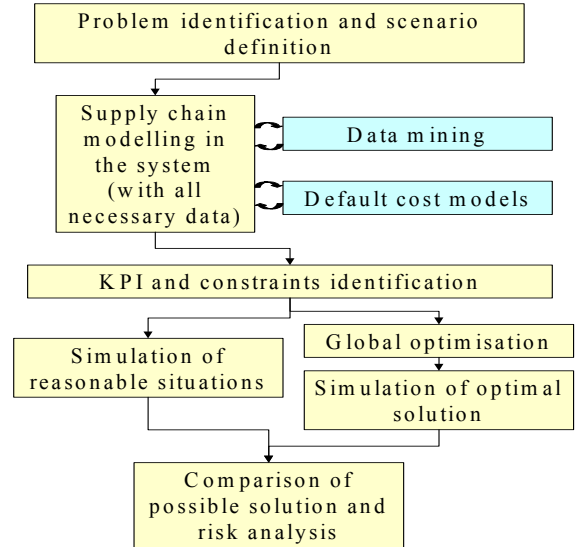

Figure 2: Main Logical Steps of the ONE Tool

The second step consists in the modeling of the scenario using a special Network Module. For this step, it is necessary to specify the input data related to all of the various elements of the enterprise network, such as production lines characteristics, demand, costs, time, uncertainties, global risks etc. Most often, the input data is not completely available. In this case, default values are specified automatically. Furthermore, ONE contains a data-mining module that could be used to forecast demands and manage other available information related to costs, etc. In addition, default cost models, covering economic, social and environmental aspects, can be specified or adapted in order to make the model more realistic. The whole modeling process is supported by an object-oriented approach in combination with user-friendly GUI components addressing in particular the requirements of domain experts for network modeling.

The third step consists in the identification of some Key Performance Indicators (KPI) that the end-user wants to evaluate for the assessment of different alternatives, usually the total costs. However, other KPIs might be emphasized separately representing, for example costs related to transportation or warehousing, or the quality of service, environmental or social impacts.

After the specification of the KPIs, different configurations can be simulated and evaluated. The results can be used by the end-user for comparison with specific configuration, for example the present configuration or theoretically good solutions. In addition, the end-user could use

the optimization module to select the best configuration within the defined scenario according to selected KPIs. It is, however, a good habit to use simulation to compare the present situation (if exists) or other reasonable configurations with the proposed optimum in order to evaluate related risk and uncertainty indicators for a robust solution.

3.2 Simulation-Based Optimization

Simulation-based optimization is referred as an effective method that adapts simulation to applications requiring optimization. For enterprise network or supply chain optimization, one major obstacle is uncertainty, which is especially important for the dynamics within the underlying supply chains. Its stochastic nature makes most traditional analytical models either over simplistic or mathematically unsolvable. Therefore simulation-based optimization, because of its capability for handling such variability, is become more and more popular as an analysis method for such systems.

In the ONE project, a simulation-based multi-objective optimization method has been developed and integrated for joint optimization of enterprise network structure and operational parameters (inventory control parameters, transportation allocation, etc.). More specifically, a multiobjective genetic algorithm (MOGA) is adapted to perform stochastic search for solutions, which achieves a trade-off regarding conflicting criteria, e.g. costs and customer service level. Decisions are incorporated into discrete-event simulation models for the evaluation of KPIs. The structure of the proposed simulation-based optimization framework is also shown in Figure 1.

The uniqueness of the proposed method is that it not only makes decision at the strategic level, but more importantly, it addresses the operational aspects of each solution through simulation. In the following sub-sections, three main modules of the ONE tool, respectively network module, simulation module and optimization module will be described in more detail.

3.3 Network Module

The network module is the base component containing all of the data and information required by the other components of the toolbox. In order to fulfill the requirements resulting from the applicability of the ONE tool for domain experts which are usually neither experts in modeling or in simulation or mathematical optimization specific concepts were realized. First of all the modeling process is supported by an object oriented approach. This means that a set of relevant objects (each of which contains an object-specific parameter set) for the representation of enterprise networks and the underlying supply chains are offered by the system. During modeling, the end-user has to combine these objects and to specify the associated parameters. If the user does not know certain parameters, default values can be used instead. Addi-

tionally data mining can be applied in order to get meaningful values out of real data (e.g. out of ERP-Systems). Following this approach the model building starts with the definition of the different products and materials which will be moved and processed in between or within certain facilities or by the different processes (transportation, warehousing, manufacturing etc.).

Afterwards defining the different facilities and links of the enterprise network will specify the topology of the underlying network. Finally, enhanced aspects like costs related to certain processes or activities as well as risks or uncertainties have to be specified. Figure 3 shows a screenshot of the tool during the model building.

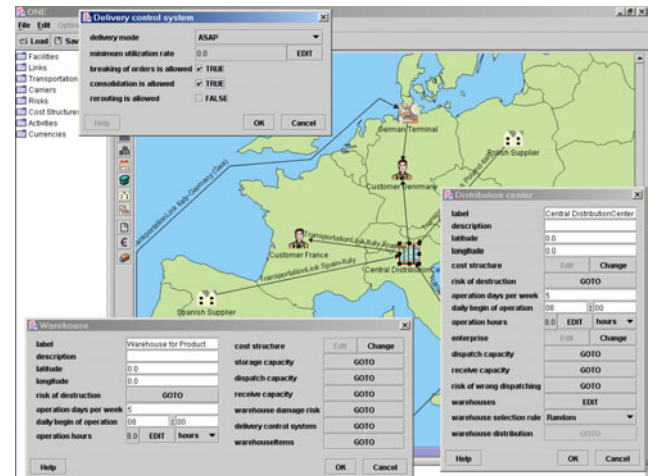

Figure 3: Network Modeling

Although one could think that the determination of a fixed set of modeling objects restricts the applicability it prohibits the creation of models which are too simplistic or complex at the same time and therefore supports an adequate modeling style.

3.4 Simulation Module

After a model is available, it can be executed within the discrete, event-driven simulation module as another major component of the ONE toolbox. Again user-friendliness was an important issue for the development of the simulation module which is mainly addressed by a set of GUI components for the specification of parameters related to simulation, control of simulation, execution, animation and finally the assessment of simulation data (see Figure 4 and Figure 5).

Beside the component that allows an interactive simulation, the simulator provides another interface to the optimization module. In order to be platform independent a file-based approach was implemented for the communication between these components whereas both parts will provide the required input in a cyclic way after an initial launching of the optimization process.

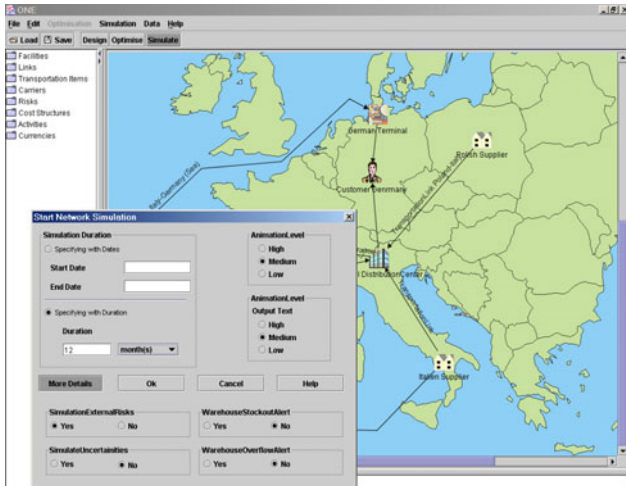

Figure 4: Simulation Start

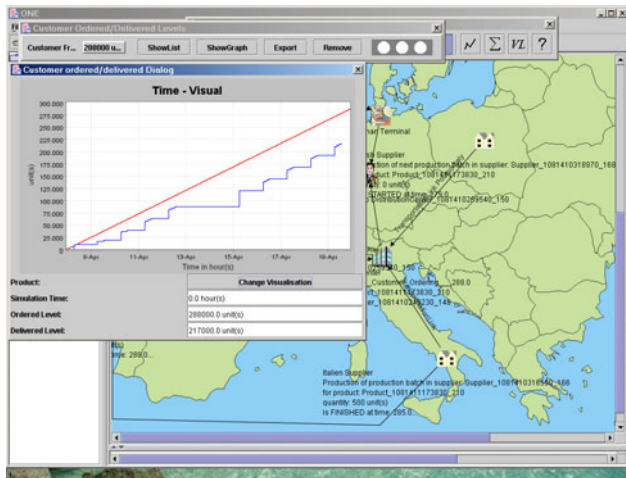

Figure 5: Analysis of Simulation Data

The role of the simulator mainly covers the evaluation of a fitness of a certain network configuration that is proposed by the optimization module. In fact, there are a large number of configurations (so-called network candidates) which have to be assessed by the simulation system during an optimization run. Thus, the performance must be considered as an important issue in this context.

This optimization process will be depicted in more detail within the following section.

3.5 Optimization Module

Although this module contains two types of techniques, respectively Genetic Algorithms (GA) and Mathematical Programming (MP), we focus on the description of the GA-based optimization approach.

For a multiobjective optimization problem (MOP), the notion of optimality is not as obvious as that of a single objective optimization problem. There does not exist an absolute value indicating the quality of solutions for a MOP, in

the absence of preference information. Solutions are compared using the notion of Pareto dominance.

3.5.1 Multi-Objective Genetic Algorithm

A genetic algorithm is a parallel and evolutionary search algorithm based on the Darwinian evolution theory (Goldberg, 1989). It is used to search large, nonlinear solution space where expert knowledge is lacking or difficult to encode. Moreover it requires no gradient information, evolves from one population to another and produces multiple optima rather than single local one. These characteristics make GA a well-suited tool for multi-objective optimization, which attracts more and more attentions of researchers and practitioners.

A number of MOGA variants have been developed in the past decade. In a pioneer in the field of Pareto-based MOGA, Fonseca and Fleming (1993) developed an approach that is relatively easy to implement. However, its performance is highly dependent on a parameter named “niche size”, which is hard to define. Srinivas and Deb (1994) proposed a non-dominated sorting genetic algorithm (NSGA), which performs fitness sharing in the parameter space to ensure a better distribution of solutions. However, it is less effective than Fonseca and Fleming’s MOGA and more sensitive to the niche size. Horn, Nafpliotis, and Goldberg (1994) proposed a niched Pareto GA (NPGA) that does not use ranking method. Rather, Pareto domination tournaments are used to select individuals for crossover. NPGA runs very fast but its performance also depends on a specific parameter which are hard to set. Recently, Deb *et al.* (2002) presented an improved elitist genetic algorithm named NSGA-II. It outperforms over other MOGA variants by introducing a fast non-dominated sorting algorithm, elitism and a parameter-free sharing operator.

For more details about GA basics and characteristics of different MOGAs, reader is directed to (Coello, 2000). For industrial application, MOGA is proving to be an increasingly popular technique in solving realistic industrial problems (Griffin *et al.*, 2000 and Cheng and Li, 1998). Figure 6 illustrates the computation flowchart of the proposed simulation-based MOGA optimization method.

3.5.2 Network Checking and Repairing Procedure

In order to guarantee the feasibility of all chromosomes (candidate network configurations), a chromosome repair procedure is necessary because some bad genes are occasionally generated (i.e. genes that violate any of the restrictions) during crossover and mutation.

In this study, we define the concept of network feasibility from the connectivity point of view. Obviously, it is not possible to forward or backward the material flow for an unconnected facility. The network repair procedure guarantees that each facility in the candidate network can receive commodities that it needs and deliver commodities

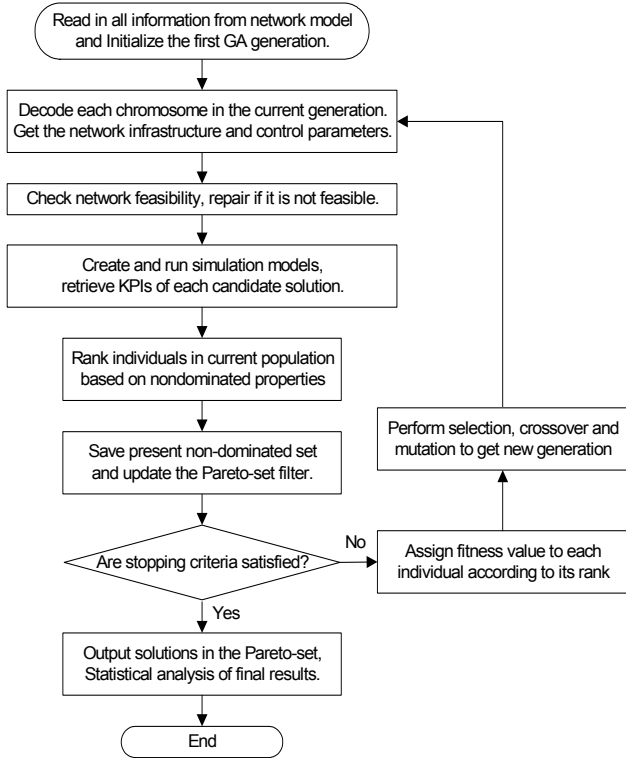

Figure 6: Flowchart of the Simulation-Optimization Method

that it produces. More specifically, two conditions are defined as compulsory requirements for a feasible network:

- Each of the non-source facilities in the candidate network should have at least one upstream facility.
- Each of non-sink facilities in the candidate network should have at least one downstream facility.

For an infeasible network, a facility will be randomly chosen from the adjacent list of the unconnected facility. Then it is added in the candidate network by simply flip the corresponding binary decision gene from “0” to “1”. The check and repair procedure will be iteratively performed until all the facilities in the candidate network are connected.

Figure 7 illustrates an example where the original network contains 3 suppliers (S1, S2 and S3), 3 plants (P1, P2 and P3) and 2 customers (C1 and C2). Given a binary string, for instance [0,0,1,1,1,1], the network checking subroutine starts to traverse all the nodes and verify the two aforementioned conditions. Subsequently it discovers that P1 that is not a source node and it has no predecessor. Referring to the original network, the repairing subroutine adds one predecessor of P1, namely supplier S2, to the candidate network. Regarding the repaired binary string [0,1,1,1,1,1], a simulation model is generated by extending the simulation framework of the proposed methodology.

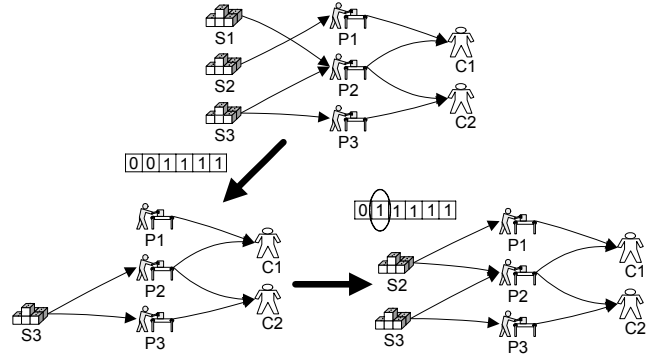

Figure 7: Network Checking and Repairing Illustration

4 A REAL-LIFE CASE STUDY

A real-life case study is proposed by one of our industrial partners for validation of the developed tool. The case study has been successfully handled by the tool and the validity of corresponding results is recognized by the company’s logistic department. Due to confidentiality, in this paper we only briefly present the model of the case study while numerical results are excluded.

The objective of this case study is to improve the profitability and responsiveness of the company’s supply chain by redesigning its production-distribution network. Figure 8 shows the network representation of the studied supply chain. It consists of three plants, four distribution centers and six customers. The three plants produce one type of car and finished products are transported, via various transportation modes, to serve customers located in another country.

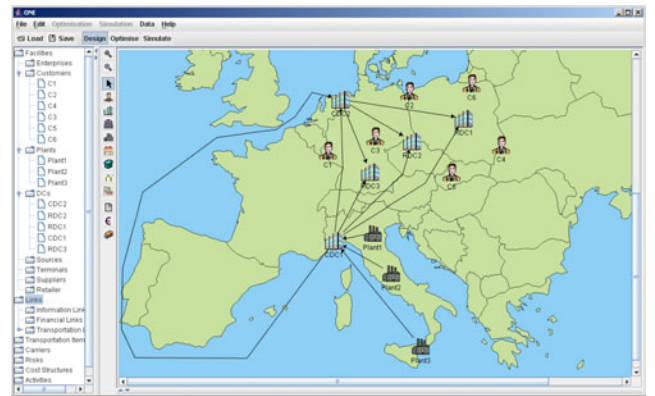

Figure 8: Network Representation of the Supply Chain

The decision variables are respectively i) the open/close decisions related to the three plants and the distribution centers; ii) the inventory control policy plus corresponding parameters for each valid distribution center; iii) the production capacity allocated to each valid plant. Note that the optimization variables include both qualitative variables, i.e. inventory control policy and variables related to the supply chain structure, i.e. open/close decisions on

supply chain facilities. Using the developed ONE tool, such decision variables can be handled efficiently.

Regarding to the profitability and responsiveness of the studied supply chain, we have defined two KPIs in the model representing the quality of candidate solution. The two KPIs are respectively: i) the total costs occurred during the simulation, including the engagement cost, production cost, inventory cost and transportation cost; ii) the average demand cycle time. The total costs reflect a supply chain's profitability. While the demand cycle time, which is defined as the time span from the demand generation moment until when corresponding products are received, addresses exactly the responsiveness of a supply chain.

Optimization results provide the decision makers a set of Pareto-optimal solutions, which achieve best-so-far trade-off between the two criteria. Regarding to the company's various targets on demand cycle time, appropriate solutions are identified and further studied by more detailed simulations.

5 CONCLUSIONS AND PERSPECTIVES

An overview of the ONE system as an integrated toolbox for a holistic assessment and optimization of enterprise networks has been provided. In addition, the tool and the associated approach were applied to a small but realistic problem for the design and optimization of such networks. It was shown, that the tool can be helpful in particular for decision makers because it allows the assessment of existing configurations as well as their optimization whereas the risk for making wrong decisions, usually coming along with huge costs, can be considerably decreased by applying simulation.

While there is still a significant potential for optimizing existing enterprise networks or supply chains many other innovative concepts addressing this field are currently under research. An interesting and promising approach deals with self-controlled logistics processes whereas the transportation entities are intelligent enough in order to define their way from through a network from the source to the target on their own. This approach is covered by a German research initiative "SFB 637: Self control of logistics processes – A paradigm shift and its limitations" which is currently conducted at the University of Bremen <<http://www.sfb637.uni-bremen.de/>>.

Because the dynamic of a system comprising a huge number of more or less independent acting self-controlled entities within a network is hardly to predict and evaluate in real operation, appropriate tools are required for this purpose. Beside an assessment of the overall network, other aspects related to individual facilities or entities like specific control strategies can be tested and improved by using such a tool.

Due to its open and flexible architecture, ONE seems to be a perfect base for an adaptation/enhancement necessary in order to support such scenarios as well.

ACKNOWLEDGMENTS

This research is partially supported by the European Community research program, through the project ONE (Optimization methodology of Networked Enterprises, Project No. GRD1-2000-25710). These supports are gratefully acknowledged.

REFERENCES

- Cheng F.Y., and D. Li. 1998. Genetic algorithm development for multiobjective optimization of structures. *American Institute of Aeronautics and Astronautics Journal*, vol. 36, 1105-1112.
- Christopher M. 1992. Logistics and supply chain management: Strategies for reducing costs and improving services. *Financial Times*. London : Pitman Publishing.
- Coello C.A.C. 2000. An updated survey of ga-based multiobjective optimization techniques. *ACM Computing Surveys*, vol. 32, 109-143.
- Deb K., A. Pratap, S. Agarwal and T. Meyariva. 2002. A fast and elitist multiobjective genetic algorithm: NSGA-II. *IEEE Transactions on Evolutionary Computation*, vol. 6, 182-197.
- Fonseca C.M., and P. J. Fleming. 1993. Genetic algorithm for multiobjective optimization: formulation, discussion and generalization. *Proceedings of the Fifth International Conference on Genetic Algorithms*, S. Forrest, ed. Morgan Kaufmann, San Mateo, 416-423. California : Morgan Kaufmann.
- Goldberg D. 1998. *Genetic algorithm in search, optimization & machine learning*. Massachusetts : Addison-Wesley.
- Griffin A., P. Schroder, A. J. Chipperfield and P.J. Fleming. 2000. Multi-objective optimization approach to the ALSTOM gasifier problem. *Proceedings of the Institution of Mechanical Engineers*, vol. 214, 453-468.
- Horn J., N. Nafpliotis and D.E. Goldberg. 1994. A niched Pareto genetic algorithm for multiobjective optimization. *Proceedings of the First IEEE Conference on Evolutionary Computation*, 82-87.
- Ingalls R.G. 1998. The value of simulation in modeling supply chains. *Proceedings of the 1998 Winter Simulation Conference*, ed., D.J. Medeiros, E.F. Watson, J.S. Carson, and M.S. Manivannan, 1371-1375. Institute of Electrical and Electronics Engineers, Piscataway, New Jersey.
- Schunk D., and B. Plott. 2000. Using simulation to analyze supply chains. *Proceedings of the 2000 Winter Simulation Conference*, ed., J.A. Joines, R.R. Barton, K. Kang and P.A. Fishwick, 1211-1216, Institute of Electrical and Electronics Engineers, Piscataway, New Jersey.
- Srinivas N., and K. Deb. 1994. Multiobjective optimization using nondominated sorting in genetic algorithms. *Evolutionary Computation*, vol. 2, 221-248.

AUTHOR BIOGRAPHIES

HONGWEI DING is a Ph.D. student at INRIA (The French National Institute for Research in Computer Science and Control). He received a Bachelor of Science in Mechanical Engineering from Tsinghua University, China in 1999 and a Master of Science in Mechanical Engineering from Tsinghua University, China in 2001. His research interests include supply chain modeling, optimization and simulation. His e-mail address is <ding@loria.fr>.

LYES BENYOUCEF is a researcher at INRIA (The French National Institute for Research in Computer Science and Control). He received a M.S. and Ph.D. degrees both in Operations Research from the National Polytechnic Institute of Grenoble-France in 1997 and 2000. Prior to re-joining INRIA, he was a member of the logistic department of THALES-Avionics-France. His research interests include modeling-optimization of manufacturing systems and simulation and optimization techniques applied to supply chain design and management. His e-mail address is <benyoucef@loria.fr>.

XIAOLAN XIE received the Ph.D. degree from University of Nancy I, Nancy, France, in 1989, and the Habilitation à Diriger des Recherches degree from University of Metz, Metz, France, in 1995. Dr. Xie is a research director at INRIA (The French National Institute for Research in Computer Science and Control) since September 2002. His research interests include modeling, performance evaluation, management and design of manufacturing systems. He is co-author of three books on Petri nets and has authored/co-authored about 50 journal papers in related fields. He has served as a Guest Editor of a 2001 special issue of International Journal of Production Research on modeling, specification and analysis of manufacturing systems, and a 2001 special issue of IEEE Transactions on Robotics and Automation on semiconductor manufacturing systems. He is an Associate Editor of *IEEE Transactions on Robotics & Automation*. His e-mail address is <xie@loria.fr>.

CARL HANS is a researcher at BIBA (Bremen Institute of Industrial Technology and Applied Work Science). He received a Master of Science in Computer Science in 1998 at the University of Bremen, Germany. His research interests include the modeling, simulation and optimization of production networks. His e-mail address is <han@biba.uni-bremen.de>.

JENS SCHUMACHER started as researcher at BIBA in 1992. He received the PH.D. degree from the University of Bremen, Germany in 2001. In 1997, he became Manager of the “Centre of Research for Electronic Commerce in logistics” (FOLO) at the University of Bremen. From 1998 until 2003 he was Head of Department “Logistics and

Globally Distributed Production” and since 2003 he is head of department IKAP (Application of Information and Communication Technologies in Production) at BIBA. His research interests include the modeling, simulation and optimization of production networks. His e-mail address is <jsr@biba.uni-bremen.de>.