

SL740-AE-RPT-010

0910-LP-984-3509

U.S. NAVY SALVAGE REPORT USS GUARDIAN (MCM 5) REMOVAL

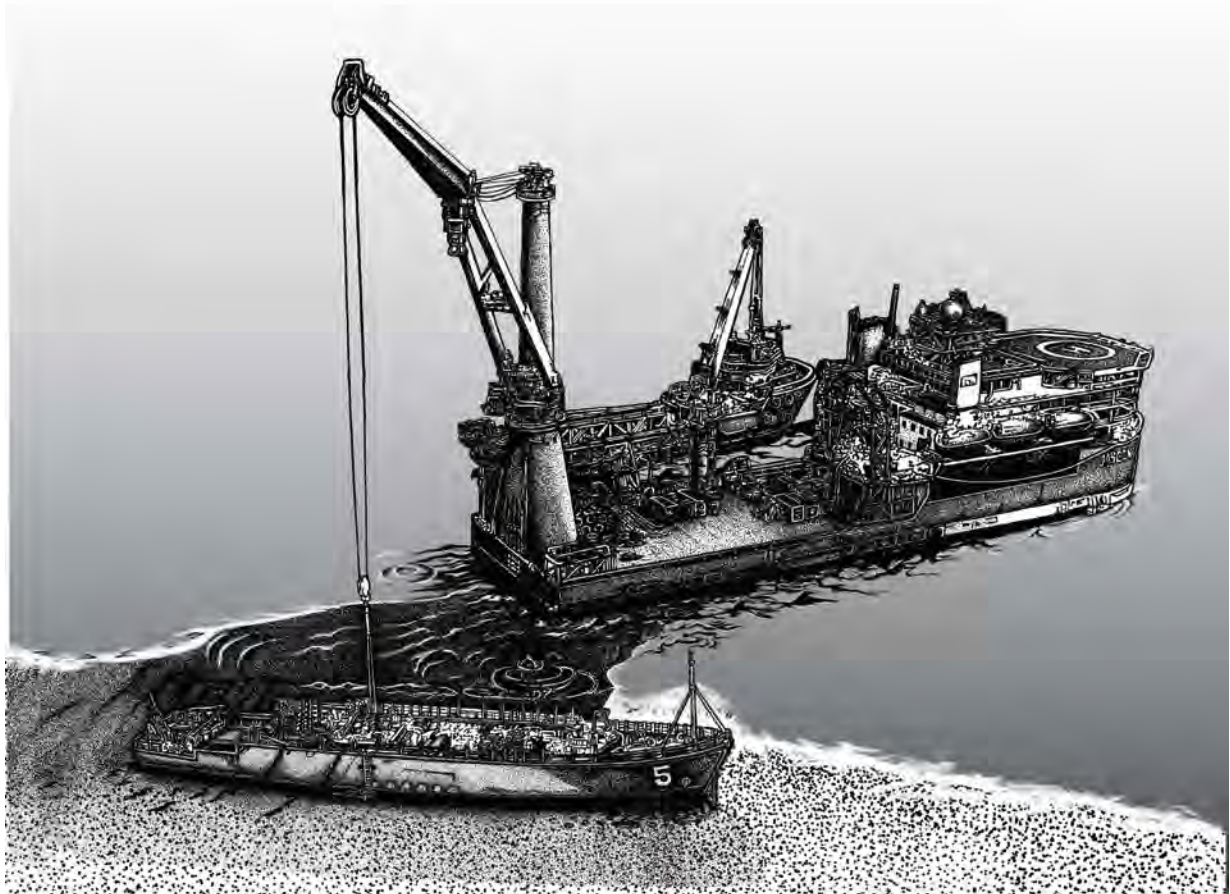

DISTRIBUTION STATEMENT A: This document has been approved for public release and sale, its distribution is unlimited

Published by Direction of Commander, Naval Sea Systems Command

March 2014

Foreword

In the early morning hours of January 17, 2013 USS GUARDIAN (MCM 5) ran aground on a coral reef in Tubbataha Reef Marine Park about 90 miles SW of Palawan Island in the western portion of the Philippines archipelago. Her situation quickly went from bad to worse as the heavy seas forced her hull to breach onto the reef, severely damaging her wooden hull. This report describes the Navy's response to the grounding of the ship and efforts of a very capable team to remove the hull from the reef without further impacting the United Nations World Heritage site.

Seventh Fleet issued an Operations Order on 19 January establishing CTG OP GUARDIAN. CTF-76, CTF-73 and CTF-72 provided command and control, planning, and environmental support for the organization. The salvors included: SUPSALV and their Western Pacific Salvage Contractor, SMIT Singapore, MDSU ONE, MSC, and SWRMC's Battle Damage Repair Team. NAVSEA HQ provided technical support from PEO LCS, SEA 05, and MCM Planning Shipyard. As the operation transitioned from Crisis and Control Phase to Stabilization and then Recovery Phase, this team adapted to the requirements and achieved the desired results.

There were significant challenges facing the salvage team. The winter monsoon season in Sula Sea lasted past the middle of March. Many of those February and March days were too rough to transfer personnel to GUARDIAN thus severely limiting salvage operations. The seas also sealed the fate of GUARDIAN. By the second week of the operation, the action of the waves grinding the hull into the reef eliminated any chance the hull would survive the grounding and subsequent recovery.

Because of sensitivity to the Philippines Government's concern about the environmental damage to the Tubbahala Reef, the salvor's options were limited. The vessel needed to be lifted clear of the reef to avoid damaging it further. Additionally, due to GUARDIAN's weight, the presence of the reef preventing a lift vessel's immediate access to the wreck, and the requirement to protect the reef, the hull had to be sectioned for removal. This course of action was planned carefully and executed without incident in five quick days at the end of March.

As this report demonstrates, the salvor's response was quick and efficient. The whole salvage team's actions were commendable. I congratulate all members of the OPGUARDIAN team for a job well done.



Mark M. Matthews
Supervisor of Salvage and Diving
Director of Ocean Engineering, USN

This page intentionally left blank.

Table of Contents

SECTION - 1. INTRODUCTION AND BACKGROUND.....	1
1.1. USS GUARDIAN Grounding and Damage Details	1
1.2. Purpose of Report.....	3
1.3. SUPSALV Tasking and Scope of Mission	4
1.4. Operational Considerations	5
1.4.1. Safety of Personnel.....	5
1.4.2. Weather / Monsoon Season.....	6
1.4.3. Environmental sensitivity of reef / park.....	7
1.4.4. Public Scrutiny and Press.....	8
1.4.5. Relationship with Republic of Philippines	9
1.5. Overview of Operations.....	9
SECTION - 2. COMMAND AND ORGANIZATION	2-1
2.1. US Navy Organization	2-1
2.1.1. Commander Seventh Fleet (C7F).....	2-1
2.1.2. MDSU ONE	2-3
2.1.3. SWRMC Battle Damage Repair Team (BDR)	2-3
2.1.4. NAVSEA HQ.....	2-4
2.2. US Navy and Philippine Government Coordination.....	2-4
2.2.1. Philippine Liaison Officers	2-4
2.3. SUPSALV / SMIT Team	2-5
SECTION - 3. TASKING AND FUNDING	3-1
3.1. SUPSALV Initial Tasking – Immediate Response.....	3-1
3.2. COMSEVENTHFLT Operation Order (OPORD).....	3-1
3.2.1. Mission Statement:.....	3-2
3.2.2. Commander's Intent.....	3-2
3.2.3. Concept of Operations.....	3-3
3.3. SMIT task.....	3-3
3.4. Funding.....	3-3

U.S. Navy Salvage Report – Operation GUARDIAN

3.4.1. Funding Sources 3-3

3.4.2. Funding Summary..... 3-4

3.5. Cost Accounting.....3-4

SECTION - 4. MOBILIZATION.....4-1

4.1. SUPSALV Mobilization4-1

4.2. SMIT Mobilization.....4-1

4.2.1. Salvage Team 4-1

4.2.2. Salvage Support Vessels 4-1

4.2.3. Salvage Support Equipment 4-2

4.3. MDSU-1 Mobilization4-2

4.4. Transportation / Logistics Issues.....4-2

SECTION - 5. OPERATIONS.....5-1

5.1. Immediate Response5-1

5.1.1. POSSE Support..... 5-1

5.2. Planning / Discovery – Evolving Salvage Plan.....5-2

5.2.1. Defining the Task 5-2

5.2.2. Salvage Plan..... 5-3

5.3. Loose Items Recovery5-6

5.4. Fuel / Hydrocarbon Removal5-8

5.5. Permitting.....5-8

5.6. Weight Removal5-9

5.7. Superstructure Removal5-12

5.8. Structural Sectioning and Removal5-15

5.9. Reef Cleanup5-18

SECTION - 6. CONCLUSION.....6-1

6.1. Demobilization6-1

6.1.1. S-7000 / Guardian off-load Sasebo, Japan..... 6-1

6.2. Accomplishments6-5

SECTION - 7. LESSONS LEARNED7-1

7.1. Navy Issues and Recommendations7-1

7.2. Observations7-4

Appendices

- A. Engineering Analysis (NAVSEA, PCCI, SMIT)
- B. SITREPS Documenting Key Events
- C. Key Tasking Documents
- D. Timeline of Events
- E. Vessels Supporting Operation
- F. MDSU ONE and SWRMC BDR After Action Report
- G. Salvage Plan Rev 1.5
- H. SMIT Lifting Plan V3 SMIT - 20 March 2013

Table of Figures

Figure 1-1. Sulu Sea, Republic of the Philippines showing USS GUARDIAN's grounding site in the Tubbataha Reef Marine Park.....	1
Figure 1-2. USS GUARDIAN (MCM 5) aground on Tubbataha Reef on morning of 17 January 2013.....	2
Figure 1-3. MDSU ONE divers working to remove machinery prior to hull sectioning.....	5
Figure 1-4. Strong wind and surf throughout the winter monsoon season at times restricted the salvors ability to access the vessel and weakened the hull's structure.	7
Figure 1-5: Bathymetry of Tubbataha Reefs and Grounding Site (Soundings in Meters), Courtesy NAMRIA (National Mapping and Resource Information Authority), Philippines.....	8
Figure 2-1. Command and Control Organization Chart – Phase I and II.....	2-2
Figure 2-2. Command and Control Organization Chart - Phase III and IV	2-3
Figure 2-3. Command and Control Organization Chart - Afloat	2-6
Figure 5-1. Screenshot of POSSE modeling performed after receiving reports on USS GUARDIAN's initial grounded condition.....	5-2
Figure 5-2. SMIT BORNEO anchoring plan.....	5-4
Figure 5-3. SMIT Borneo crane capacity curve. Note the reduced lift capacity when 0.5 meter or 1.0 meter wave conditions are present.	5-4
Figure 5-4. USS GUARDIAN hull section cuts in first draft of Salvage Plan.	5-5
Figure 5-5. JASCON 25 positioned next to the reef. Note the close proximity to the reef in order to retain maximum lift capacity.	5-6
Figure 5-6. Sensitive / High value item recovery. USNS SALVOR's workboat, crewed by MDSU One, alongside USS MUSTIN unloading high value material removed from USS GUARDIAN.	5-7
Figure 5-7. VOS APOLLO in DP mode positioned next to the reef taking fuel and oily waste from GUARDIAN. Note buoyed hose running between the ships.	5-8
Figure 5-8. Tubbataha Protected Area Management Board letter to Philippine Coast Guard announcing concurrence with the SMIT Salvage Plan.....	5-10
Figure 5-9. Smit salvors riding Bully Pugh from JASCON to GUARDIAN	5-11
Figure 5-10. SMIT and MDSU ONE team members standing forward on 02 level while the stack is lifted off GUARDIAN.	5-12
Figure 5-11. 02 level plan drawing with lift sling path in red overlay.	5-13
Figure 5-12. 02 level being transferred from JASCON 25 to Archon Tide for further transfer to barge S-7000. Note GUARDIAN in background with 01 level remaining.	5-14
Figure 5-13. 01 level plan showing cut lines in blue and sling paths in red.	5-14
Figure 5-14. 01 level forward being lifted off GUARDIAN. Note waves breaking on hull. This lift followed a number of days where high waves prevented operations on GUARDIAN.....	5-15
Figure 5-15 – Auxiliary Machinery Room lifting arrangement	5-17
Figure 5-16. Bow section being tensioned prior to lift on 26 March 2013. Note access holes cut in the remaining hull sections and slings which had already been run for the AMR lift.	5-17
Figure 5-17. Stern section lift, conducted on 30 March, cleared the reef for a final cleanup.	5-18

Figure 5-18. MDSU ONE divers swimming the wrecksite on 1 April. Note salvage basket positioned on reef for collection of debris.5-19

Figure 6-1. VOS Hercules receiving CONEX boxes from SMIT Borneo. Note cable reel and stack already loaded.....6-2

Figure 6-2. An aerial view of S-7000 barge alongside SMIT Borneo.6-3

Figure 6-3. Bow section cradle.....6-4

Figure 6-4. AMR Sea Fastening.....6-4

Figure 6-5. GUARDIAN sections being offloaded in Sasebo, Japan.....6-5

This page intentionally left blank.

SECTION 1

INTRODUCTION AND BACKGROUND



This page intentionally left blank.

Section - 1. Introduction and Background

1.1. USS GUARDIAN Grounding and Damage Details

At 0222 on 17 January, 2013, USS GUARDIAN (MCM-5) grounded on Tubbataha Reef in the Sulu Sea at position: 08 48.53N - 119 48.57E. The Tubbataha Reef is an atoll extending straight up from the sea floor at nearly 90 degrees from 150 m depth to 1 m. The reef is about 90 miles east-southeast of Palawan Island in the western portion of the Philippine archipelago. Figure 1-1 shows the grounding site relative to the Sulu Sea. The ship had departed Olongapo City in Subic Bay, and was heading south, en route to Indonesia when she struck the reef.

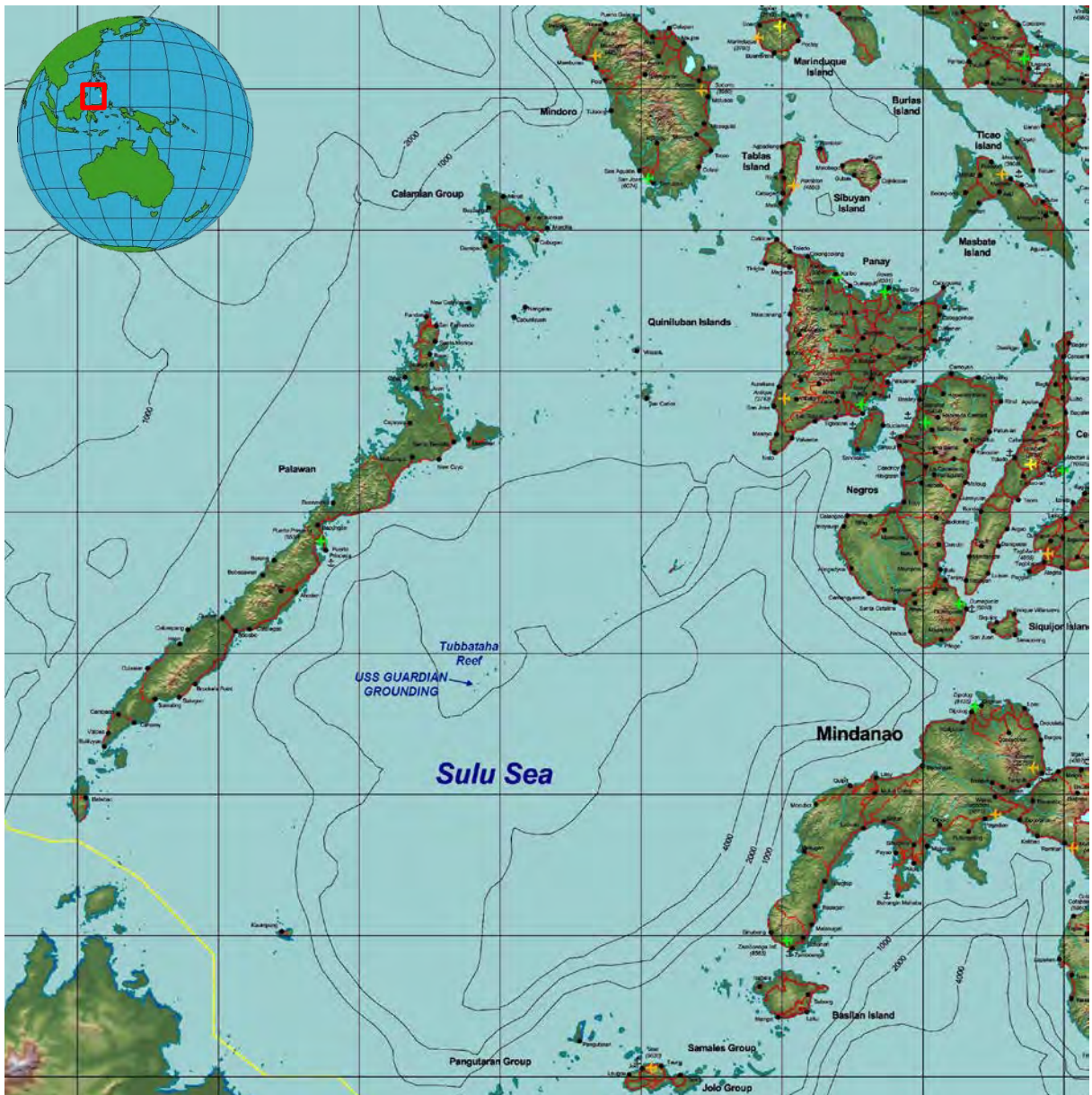

Figure 1-1. Sulu Sea, Republic of the Philippines showing USS GUARDIAN's grounding site in the Tubbataha Reef Marine Park.

Upon initial grounding, GUARDIAN became stranded bow on, perpendicular to the reef wall on a heading of 192° T. Figure 1-2 is an aerial view of GUARDIAN, bow on to the reef. Reports from the ship, as summarized from the DC log, indicated that Auxiliary Machinery Room



Figure 1-2. USS GUARDIAN (MCM 5) aground on Tubbataha Reef on morning of 17 January 2013.

(AMR, 3-41-0-E) had suffered severe impact and a hole was noted under NR 1 Air Conditioner and flooding was estimated to be about 4 gal/min. About 5 min later a second hole was seen under NR 2 Air Conditioner (AC) with the same flooding rate. A third hole was reportedly seen in the AMR with a total flooding rate estimated to be 11 gal/min and the water level had risen to 5 feet. Additionally, the bulkhead between the AMR and Main Machinery Room (MMR, 3-63-0-E) at frame 63 was noticed to be lifting allowing free communication between the two compartments. At the forward end of the ship in the forward hold (3-1-0-V) there were no noticeable hull breaches or cracking with an initial water level of about 2 in. The forward pump room (3-28-0-E) was ordered shut by the Damage Control Assistant (DCA) despite unknown structural damage as the space was flooded to capacity. Additionally, the bow thruster (3-14-0-E) had noticeable movement from the flexing of the hull with a water level of 4 in and rising. In the after end of the ship minimal flooding was reported as water was seeping through the transom in Aft Steering (3-107-0-V). Significant structural damage was reported by the DCA on the mess decks located on the main deck above the AMR and MMR due to cracks on the bulkheads. Furthermore, the Quick Acting Watertight Hatch (QAWTH) located between engineering passageway and the crew's mess on the main deck twisted and partially jammed evident from the hatch powerfully springing open in the DCA's face.

In the early morning hours on the 18th a strong northeasterly sea pushed GUARDIAN further onto the reef and began swinging her stern to starboard. GUARDIAN restarted her engines in an attempt to back off and/or limit the breaching motion caused by the seas. Although

the engines were employed, the ship pivoted on her keel, moving from an initial heading of 192 degrees to 119 degrees where she remained, broached, nearly parallel to the reef.

Hull cracks caused by the pivot on the reef increased the flooding of several forward spaces as well as the Auxiliary Machinery Room. She was progressively flooding in her main machinery room and the ship eventually lost power. With deteriorating conditions and not knowing how much further conditions were going to deteriorate, the Commanding Officer began making preparations to abandon ship if that became necessary.

Meanwhile, MSC's Submarine and Special Warfare Support Vessel (SSV) C-CHAMPION was just 20 NM away and estimated arrival in approximately two hours. She had established bridge to bridge communications with GUARDIAN as she was preparing to launch her two 11 meter RIBs for a high-speed transit to provide assistance as soon as possible.

On late morning of 18 JAN, the decision was made to evacuate GUARDIAN's crew for safety reasons and emergency destruction was begun. The crew was evacuated onto the reef. MSV CHAMPION and USNS BOWDITCH were in near vicinity and quickly launched boats to take evacuated crew members onboard.

GUARDIAN had been pushed by the seas into a breached position with her starboard side to the reef. Her final resting position was in approximately 1 - 2 m of water with a 5-6 degree port list. The entire length of her keel rested upon the reef, with several propeller blades having been shorn off. Additionally, the stern was supported by the rudders, which had become embedded into the reef as well. While still head-on to the reef it was thought that a possibility existed to refloat GUARDIAN and or back off the reef at the next high tide with the help of tugs, but because of the breaching and the combination of hull damage, flooded conditions, inoperable engineering plant, and large ground reaction forces quickly ruled that an impossibility. SUPSALV began shifting its plan from retraction to wreck removal with a floating crane/salvage barge.

1.2. Purpose of Report

This report discusses the technical and operational aspects of the salvage efforts associated with the dismantling and removal of the USS GUARDIAN (MCM 5) from the Tubbahata Reef, in the Sulu Sea, off of the coast of Palawan Island, Philippines. This report details the scope of operation from initial mobilization of personnel to the site, through the disposition of GUARDIAN and remediation of the reef. As all salvage operations present unique conditions and challenges, this report serves to describe as a means to capture the successes and lessons learned, while providing reports, technical data, and on-site challenges such that each can be applied for future operations.

The report is organized into various sections that describe the organization, operations, and challenges associated with all phases of the salvage. Section 2 details the establishment of a command and organizational structure that incorporated both military and civilian salvage groups as well as Navy Fleet leadership and support organizations. Section 3 addresses the mission of each organization, including SUPSALV, MDSU1, and SMIT Singapore; and, the funding associated with all non-organic assets used in the salvage operation. Section 4 discusses how each organization involved in the operation was mobilized and the logistics of getting equipment and personnel on station. Section 5 details all phases of the salvage operation from start (first on-site response) to finish (completion on-site). Section 6 discusses the demobilization of equipment and personnel, and it provides a summary of accomplishments of the operation. Section 7 captures lessons learned associated with all aspects of the salvage operation. Multiple appendices provide substantiating details, data, documentation for items discussed in each section of this report.

1.3. SUPSALV Tasking and Scope of Mission

Operational tasking of assets and organizations for the entire project was defined in a series of messages from Chief of Naval Operations (CNO) and CINCPACFLT. These messages defined the role of all of the participants in the areas such as:

- Logistics
- Communications
- Salvage
- Diving
- Medical Support
- Meteorology and Oceanography Support
- Logistics
- CONOPS
- Public Affairs
- Environmental Protection

CINCPACFLT tasked Commander Seventh Fleet (COMSEVENFLT) to develop an overall salvage plan for the coordination and management of assets associated with salvage efforts. This salvage plan addressed complete removal of GUARDIAN from the Tubbahata Reef and reef remediation, including provisions for logistics, communications, diving, oil spill preparedness, and response. The plan also included estimated force requirements, timeline, and cost of operations. COMSEVENTHFLT designated SUPSALV (NAVSEA 00C) as the afloat On Scene Commander with daily reporting to COMSEVENTHFLT via shore-based Task Unit Commander. Feedback to daily SITREPs was provided from COMSEVENTHFLT and phases of the salvage operation were monitored in reference to planned timelines. Appendix B provides two example SITREPS which were issued by the Task Force. The SITREPS evolved from basic quad chart at the outset (example 19 January 2013) to more involved SITREP (28 March 2013) which added a projected schedule, identified Naval units and assets on scene, and included an image of the day's events to the quad chart. COMSEVENTHFLT was tasked to provide forces and resources for the purposes of salvage operations and SUPSALV executed the standing salvage contract with the prime salvage contractor in the Pacific, SMIT Singapore.

CNO and CINCPACFLT tasked SUPSALV to mobilize necessary salvage assets in conjunction with SMIT Salvage in order to meet the objectives and requirements of the developed salvage plan. The U.S. Navy made the commitment to the Philippines that priority would be given to preserve the reef and prevent further damage during the salvage efforts. In order to arrive at the salvage plan that would best execute these objectives, the SUPSALV and SMIT Salvage teams went through several iterations of operational plans. Plans were presented to Philippine officials for explanation and approval prior to proceeding. Modifications to the agreed upon salvage plan were made as operational conditions required and submitted for review as they arose.

The primary objective of this mission was to safely remove the GUARDIAN from the Tubbahata Reef while protecting against damage to the reef as much as practicable. To accomplish this, a team of military, civilian, and contractor personnel were assembled to assess the situation and develop a salvage and recovery plan.

As with most major salvage operations, the scope of this mission included more than just completing the salvage. International relations, environmental issues, and media relations were all major elements that required significant attention. A number of these considerations are outlined in the following section.

1.4. Operational Considerations

1.4.1. Safety of Personnel

Safety of personnel was considered one of the highest priority objectives of the GUARDIAN Wreck Removal operation. Every day the SITREP was issued with a reminder to all that safety of personnel was a priority. GUARDIAN's operation site was approximately 90 nm from the nearest hospital. An accident on the reef site would require extraordinary measures to safely and quickly transport a patient to that hospital so every effort was made to avoid that possibility. Conditions on GUARDIAN were treacherous and required constant vigilance. Inboard the skin of the ship was dark and required lights to be strung and portable generators for powering those lights. Heavy seas often complicated the climb aboard from small boats. The decks were slippery and often wet from sea spray. Much work had to be done in the ship's lower levels which were flooded to chest height and oil covered. Diving or snorkeling conditions were less than ideal. Figure 1-3 shows the working conditions at the base of the hull in one of GUARDIAN's machinery spaces.

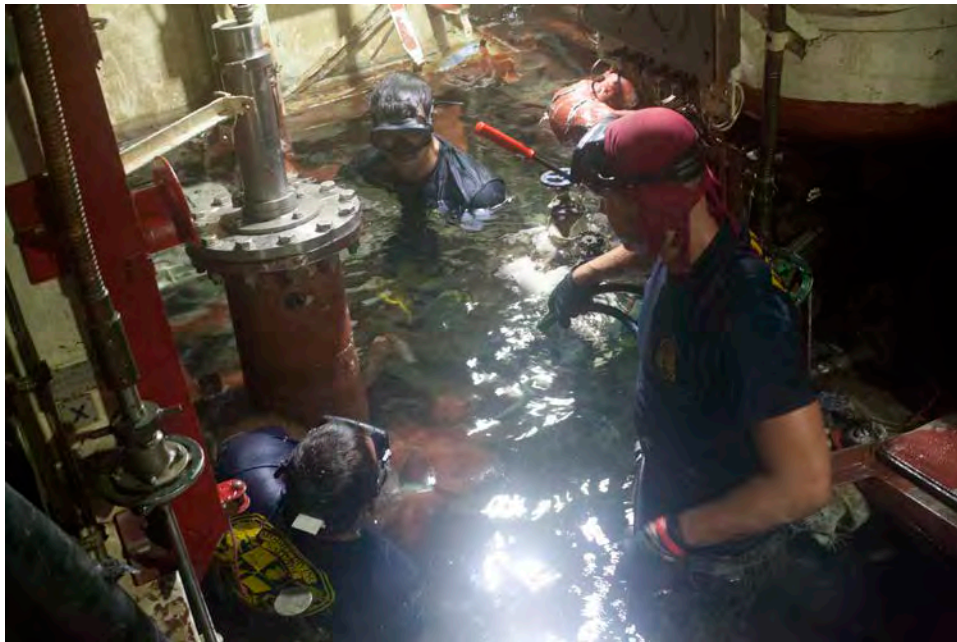

Figure 1-3. MDSU ONE divers working to remove machinery prior to hull sectioning.

To reduce the likelihood of personnel injury, each morning began with a safety brief and a high ratio of supervision was applied at the deck plate level.

Medical facilities and qualified staff were available at the site. Both SMIT BORNEO and JASCON 25 maintained well-stocked sickbays but a decision was made to utilize the USNS WALLY SCHIRRA (T-AKE 8) medical facilities in the event of a more critically injured patient. A Medevac plan was developed that outlined the movement of a patient from the injury site to the WALLY SCHIRRA or to Puerto Princesa depending on the extent of injury. The specifics of the plans were:

Minor Medical

- a) Assessment/stabilization by IDC onboard GUARDIAN
- b) Transport to JASCON 25, WALLY SCHIRRA or Puerto Princesa for further care as needed

Major Medical

- a) Assessment/stabilization by IDC onboard GUARDIAN
- b) Notify WALLY SHIRRA of medical emergency
- c) Transport stricken person and IDC via crane or small boat from GUARDIAN to JASCON 25 for assessment and then if required onward to WALLY SCHIRRA or Puerto Princesa for additional medical services

A Medevac drill was conducted on 26 February where a “patient” was transferred from the GUARDIAN deck via crane to JASCON 25 where a brief initial evaluation was conducted. The patient was then transported to JASCON 25 medical and phone communications were established and consultation provided by the duty Physician located on WALLY SCHIRRA. After “stabilization”, the patient was then transported to the JASCON 25 helo deck for further transportation by a waiting helicopter. The drill demonstrated a satisfactory medevac capability and acceptable times during the transport of the patient.

Even with the safety planning and daily emphasis placed on safe operations, an injury did occur on 13 March. A MDSU diver slipped and struck his forearm on installed machinery in the Auxiliary Machinery Room. Immediate assistance was provided by a Corpsman on site and the diver was transported to JASCON 25 for further medical evaluation by a Fleet Medical Officer. A decision was made to transport the service member to Puerto Princesa for x-ray and further evaluation to rule out a possible fracture. The whole medical response team, including the Puma Air Detachment from USNS WALLY SCHIRRA responded superbly, proving the established medevac plan was appropriate. In the end, the MDSU diver suffered a severe sprain; no fracture was found during x-rays in Puerto Princesa. This was the most significant injury that occurred during the operation.

1.4.2. Weather / Monsoon Season

Tubbataha Reefs National Marine Park lies near the center of the Sulu Sea some 90 nautical miles Southeast from Puerto Princesa, Palawan. The reefs are close to the equator, between 8° 45' and 9° N Latitude and are subject to both annual monsoon patterns and tropical cyclones or typhoons. The timing of the salvage operation, February – April, placed it at the end of the winter monsoon season (November – March) and outside the typhoon season (July – October). As the salvage progressed, a gradual calming of sea state and winds permitted accelerating lifting and recovery operations. Safe transfer of personnel and rigging was limited to wind speeds of less than 20 knots and the absence of significant sea spray over the fantail of the ship.

Following the initial grounding by the bow, GUARDIAN was broached broadside and pushed up onto the reef by the prevailing wave action running parallel to the atoll. During salvage, her hull's port side was buffeted by beam seas resulting in deterioration of her Glass Reinforced Plastic (GRP) and wood hull construction. Wave and wind action works to transversely rock and weaken the hull members, producing continued deterioration of the intact strength of the hull girder. Figure 1-4 is an image of waves impacting GUARDIAN on 24 February.

Extreme temperature and humidity and high angle sun exposure were major risks to personnel safety and were successfully mitigated by the proper wear of protective equipment and sunscreen and by the hydration of working personnel.



Figure 1-4. Strong wind and surf throughout the winter monsoon season at times restricted the salvors ability to access the vessel and weakened the hull's structure.

1.4.3. Environmental sensitivity of reef / park

The Tubbataha Reefs were inscribed on the United Nations Education, Scientific, and Cultural Organization (UNESCO) World Heritage List in 1993. The reefs are renowned for their tremendous natural beauty, biodiversity, and the annual draw of divers and sightseers. The site features extensive reef flats with perpendicular walls descending approximately 100 meters. Tubbataha is home to some 374 species of corals, 479 species of fish, as well as numerous other endangered seabirds, turtles, and sharks.

A key factor in the salvage operation, then, was ensuring that efforts to remove GUARDIAN minimized further damage to the reef ecosystem. This led to the selection of cutting and dismantling techniques that would make for a speedy removal of the ship without further impact to the reef and its habitat. Initial salvage efforts focused on the removal of ordnance, hydrocarbons (fuel oils and lubricants), and other hazardous materials. Accordingly it was planned to maintain the intact strength of the project for as far into the salvage as possible while internal spaces were cleared of major components, superstructure removal was completed, and spaces to be opened to the sea were cleared of debris and any oil from equipment was recovered. The salvage efforts then proceeded to dismantle the hull in intact sections to the maximum extent possible to limit the migration of additional material onto the reef. The final phases of the salvage include detailed surveys of the affected reef and the recovery of components and debris washed away from the GUARDIAN.

The Tubbataha reefs sit atop volcanic atolls and the seafloor of these seamounts rise rapidly from the surrounding Sulu Sea basin. The atolls are shown in Figure 1-5 below.

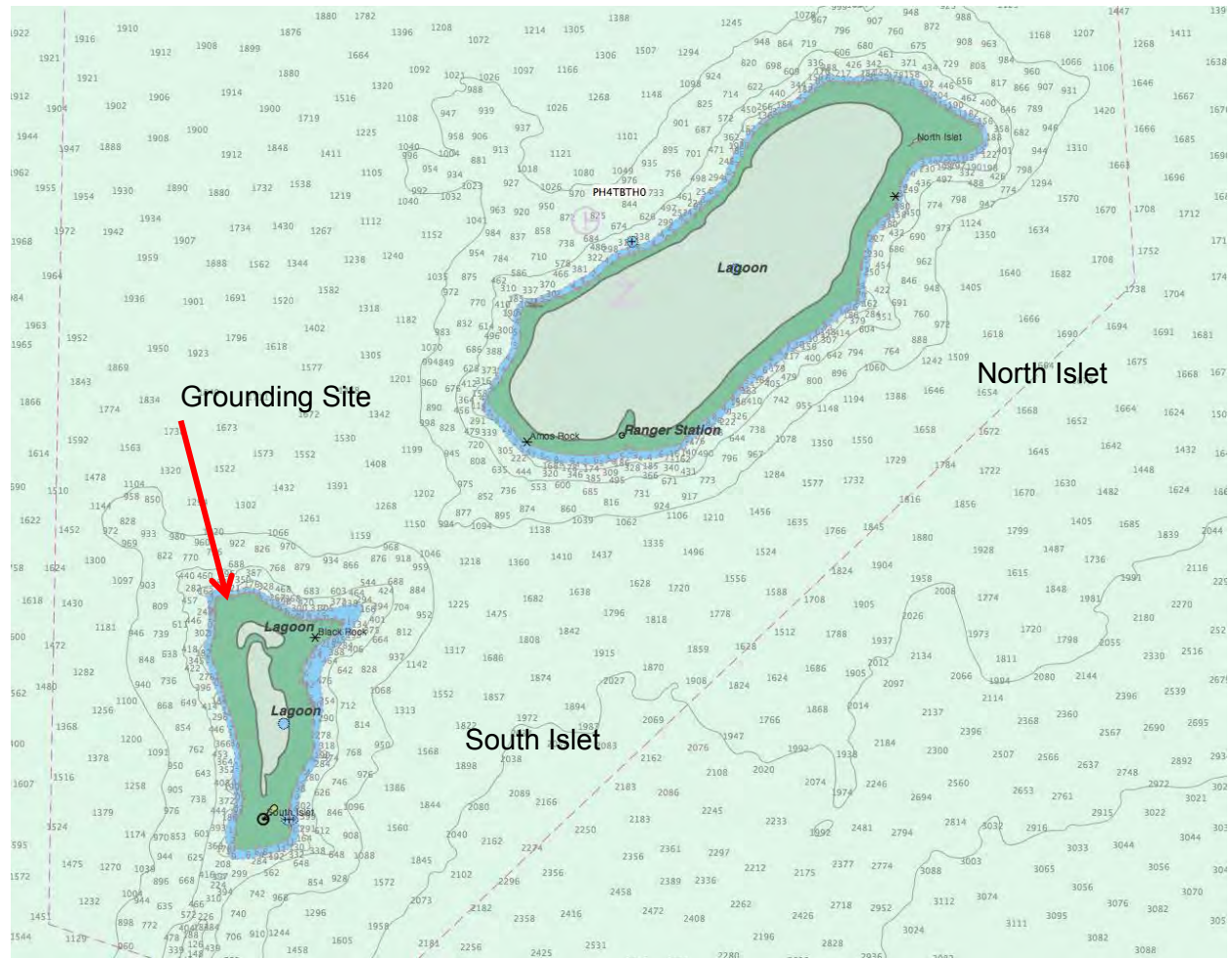

Figure 1-5: Bathymetry of Tubbataha Reefs and Grounding Site (Soundings in Meters), Courtesy NAMRIA (National Mapping and Resource Information Authority), Philippines

This bathymetry presented a unique scenario for the salvage. Were the shoaling more gradual, GUARDIAN may well have been driven far beyond the effective employment of heavy lift assets. With the ship on the edge of an approximate 100 meter drop-off, a large crane could be safely employed effectively from deep water and provide lifting coverage of the entire casualty. The stark changes in depth of water prevented the salvage from incorporating beach gear in attempting to pull GUARDIAN off the reef. Similarly, this prevented using a moored crane because of the difficulty in setting even a two point moor. Accordingly the use of a dynamic positioning ship (DP3) was necessary to facilitate salvage efforts. These highly capable barges like the JASCON-25 can maintain position just off the shoal under all sea conditions while working the salvage operation.

1.4.4. Public Scrutiny and Press

The grounding of USS GUARDIAN was a significant story in the US and in the Philippines. In order to control the release of information, COMSEVENTHFLT specified that they were solely responsible for information released to the public. A portion of the 25 Jan COMSEVENTHFLT Op Order discusses this topic.

PUBLIC AFFAIRS POSTURE IS ACTIVE. COMPACFLT IS PA LEAD. COMSEVENTHFLT HAS RELEASE AUTHORITY FOR ALL IMAGERY AND PRESS RELEASES AFTER BEING APPROVED BY COMPACFLT. COMSEVENTHFLT WILL SYNCHRONIZE ALL PA AND COMMUNICATION ACTIVITIES WITH CTF-73, CTF-76

AND THE ON-SCENE PUBLIC AFFAIRS RESPONSE TEAM, AND BRIEF COMPACFLT AS NEEDED. DUE TO HOST NATION SENSITIVITIES, AMEMB MANILA HAS THE PUBLIC AFFAIRS LEAD FOR DIRECT ENGAGEMENT WITH THE RP MEDIA AND WITH DIRECT SUPPORT U.S. NAVY PA ASSETS AS NEEDED.

COMPACTFLT DIRECTS COMSEVENTHFLT TO BE THE PRIMARY PA COORDINATOR WITH AMEMB MANILA.

ALL SCHEDULED PRESS CONFERENCES WILL BE A JOINT ENGAGEMENT WITH U.S. AND PHILIPPINE GOVERNMENT OFFICIALS. NO U.S. ONLY PRESS CONFERENCES WITHOUT APPROVAL FROM COMSEVENTHFLT AND COMPACFLT PUBLIC AFFAIRS.

1.4.5. Relationship with Republic of Philippines

The grounding incident had the potential to strain international relations between the U.S. and the Philippines. Protests organized by activists at the US Embassy in Manila demonstrated the tenuous nature of Filipino public support for the current bi-lateral Visiting Forces Agreement (VFA). Due to the sensitive nature of the salvage and the desire to mitigate damage to American-Filipino relations, the U.S. Navy salvage plan was provided to the Philippine Coast Guard for clearance and approval and shared with the Tubbataha Management Office. This close coordination was furthered through the embarkation of Philippine Coast Guard Liaison Naval Officers (LNO's) on the salvage station to observe planning and execution of the salvage.

1.5. Overview of Operations

Commander Seventh Fleet Operation Order issued 19 January 2013 divided the operation into four phases. They are listed and described below.

Phase 1 – Crisis Control. The incident's initial response was described in section 1.1 of this chapter. It primarily involved getting the GUARDIAN crew safely off the vessel and establishing a Navy presence in the vicinity of the reef.

Phase 2 – Stabilization. This included removal of the hydrocarbons and other hazardous materials. Additionally, communications equipment, small arms, and other sensitive or loose material was removed from the vessel during this phase. The primary goal was to reduce the possibility of polluting the reef with fuel or lubricating oils or of sensitive material being washed into the ocean if the ship began to breakup.

Phase 3 – Salvage and Recovery. This phase involved the removal of items on deck, items within the ship, and then removal of the 02 and 01 level. Lastly, the hull was sectioned and individual hull sections were removed by crane and placed on an oceangoing barge for transportation to the disposal site. Additionally, MDSU ONE divers swam the reef collecting GRP sheathing and any other ship or salvage debris that had been washed onto the reef.

Phase 4 – Transition. This phase included disposition of GUARDIAN and environmental assessment and mitigation. SUPSALV was responsible for arranging to have GUARDIAN's hull sections, decks, and removed material towed over to Sasebo, JA for further processing.

SUPSALV arrived as the Crisis Control phase was transitioning to Stabilization. The SUPSALV team worked with SMIT, the Western Pacific Salvage contractor, and MDSU ONE to execute a salvage plan that covered Phases 2 – 4. SUPSALV was not involved with the reef mitigation or assessment but did support the disposition of GUARDIAN material in Sasebo, JA. A graphic Timeline of Events is provided as Figure 1-6 and a more detailed timeline is contained in Appendix D.

This page intentionally left blank.

Timeline of Events

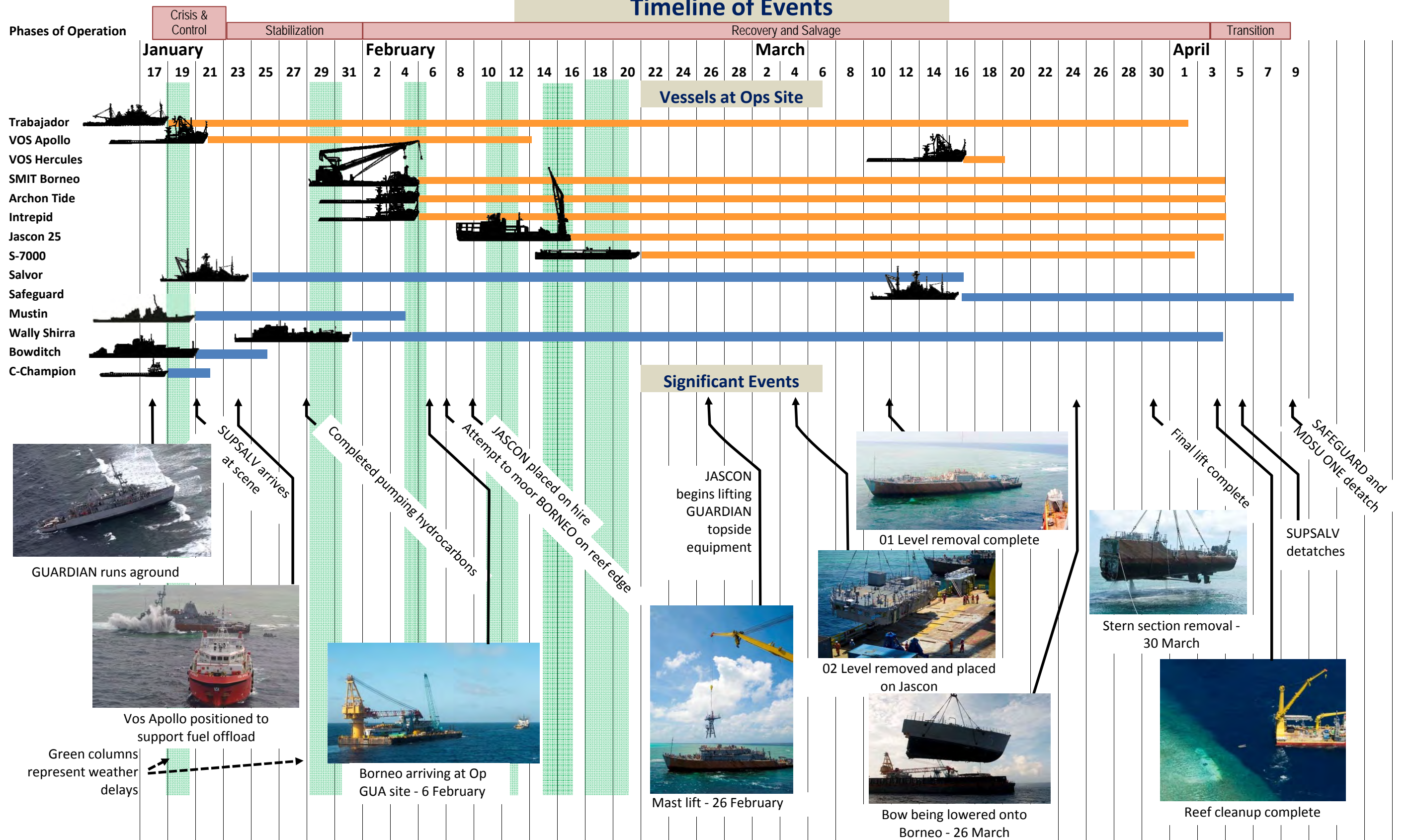

This page intentionally left blank.

SECTION 2

COMMAND AND ORGANIZATION



This page intentionally left blank.

Section - 2. Command and Organization

2.1. US Navy Organization

Many organizations within the United States Navy responded to the reported grounding of USS GUARDIAN. Witness the first ship on the scene was a Military Sealift ship, Submarine and Special Warfare Support Vessel C-CHAMPION. This section documents the major initiatives from Naval Sea Systems Command – Headquarters and Supervisor of Salvage and Diving (SEA00C) and, Commander Seventh Fleet with Mobile Diving and Salvage Unit ONE, and Battle Damage Repair Unit from Southwest Regional Maintenance Center, San Diego.

2.1.1. Commander Seventh Fleet (C7F)

Responding to the USS GUARDIAN's initial Navy Blue OPREP message, C7F issued an Operations Order (OPORD) directing COMSEVENTHFLT assets and actions during the recovery and salvage of USS GUARDIAN in the Sula Sea. The initial OPORD was issued on 19 January and Fragmentary Orders (FRAGO's) were issued periodically, beginning with FRAGO 001 issued on 20 January through FRAGO 007 issued on 3 April. The majority of these orders are contained in Appendix C. In this section, we will highlight the original OPORD and FRAGO 004 issued on 31 January which changed the structure of the supporting C7F organization.

19 Jan OPORD:

During Phase I of operation, the 19 January OPORD established CTG Op GUARDIAN. The primary tasks were to establish forward command element, assume OPCON USS GUARDIAN, USS MUSTIN, USNS BOWDITCH, and MDSU ONE

CTF-76 – Assume duties as Commander CTG OP GUARDIAN

CTF-73 – Conduct planning and coordination in order to conduct recovery and salvage operations

CTF-72 – Conduct environmental survey operations

MDSU ONE – Deploy to Puerto Princesa

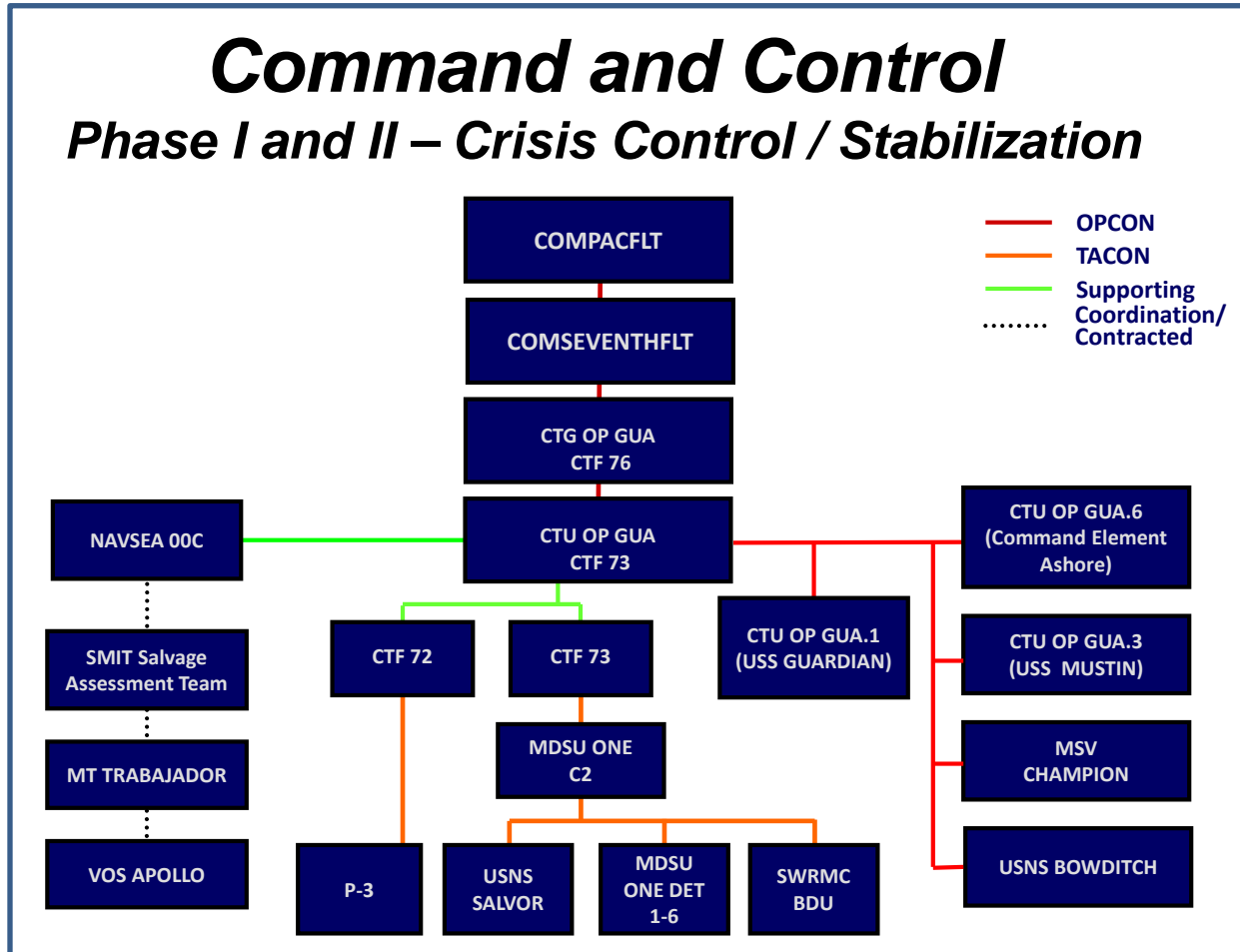

Figure 2-1. Command and Control Orgization Chart – Phase I and II

31 Jan OPORD:

After Phase II, Stabilization was complete, FRAGO 004 was issued on 31 January 2013. This document established C7F as CTG OP GUA and tasks C7F to execute the salvage plan to remove USS GUARDIAN from the reef.

CTF-73 Assume duties and responsibilities as CTU OP GUARDIAN Command Element Ashore. CTU OP GUA was tasked to organize CTU OP GUA Salvage Element.

CTU OP GUARDIAN Salvage Element (On Scene Commander), lead by NAVSEA 00C, Supervisor of Salvage, was tasked to execute the salvage plan to remove USS GUARDIAN from the reef.

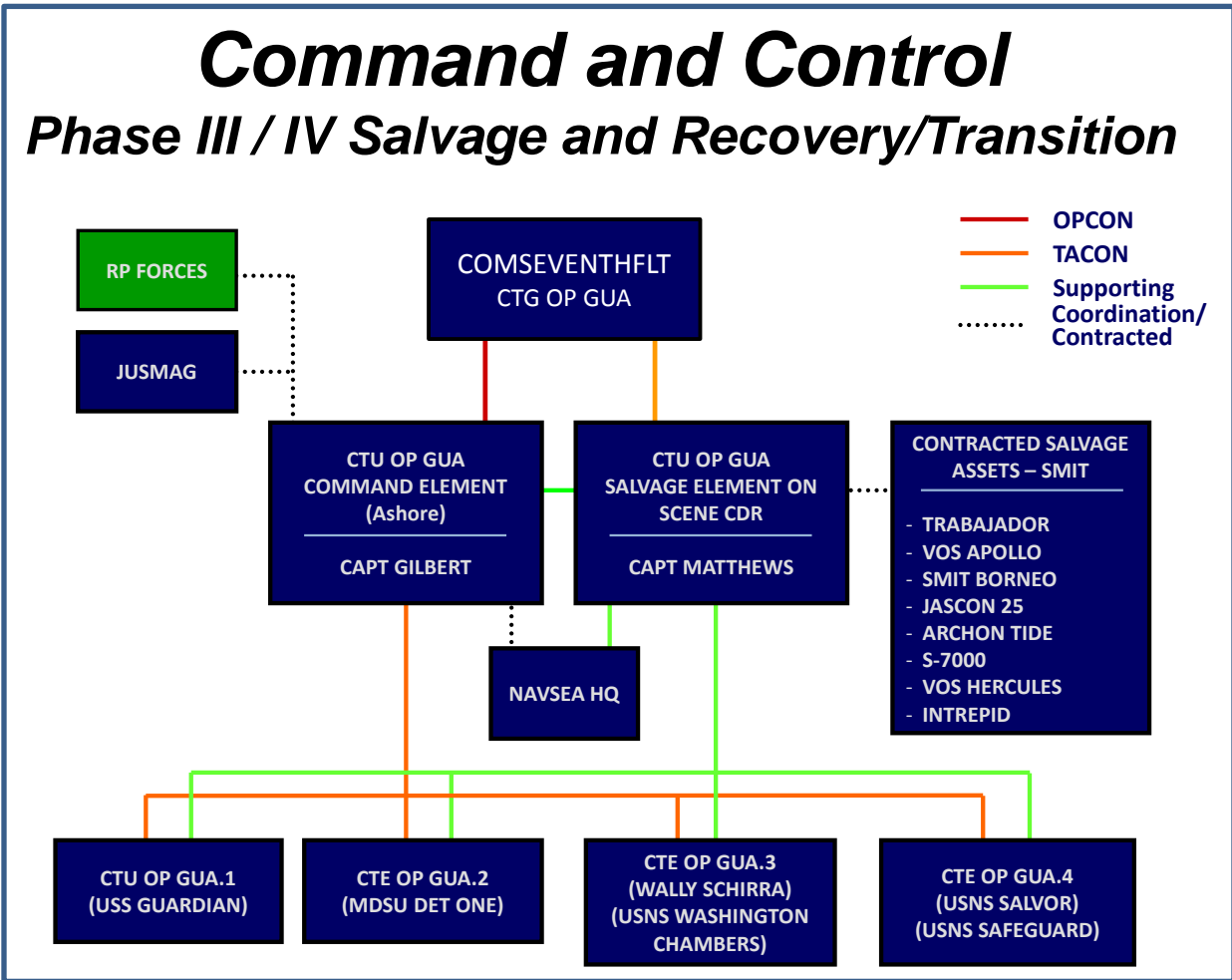

Figure 2-2. Command and Control Organization Chart - Phase III and IV

2.1.2. MDSU ONE

MDSU One deployed in support of the GUARDIAN salvage on 20 January through 09 April 2013. The Command and Control (C2) Element was comprised of MDSU ONE Commanding Officer, CDR Tom Murphy, with additional support of his XO, Operations Officer, several MDSU Master Divers and a Command Hospital Corpsman Chief. Throughout the nearly four month operation, MDSU ONE had two of its companies, 1-6 and 1-2 on-scene to assist in recovery, salvage and wrecking efforts. The command elements MDV's helped coordinate the daily tasking on the deck-plate level with SUPSALV Assistants for Salvage, LT Cunningham (00C2A) and LCDR Addington (00C2B).

2.1.3. SWRMC Battle Damage Repair Team (BDR)

Southwest Regional Maintenance Center's (SWRMC) Battle Damage Repair (BDR) team was deployed on 18 January to provide salvage efforts as part of the initial response. The team arrived to Puerta Princesa via commercial air and was taken to the grounding site aboard VOS Apollo. The 7-man team was led by LT Eric Brege and MDV Kenefic and reported to the CTF73 Salvage Officer, LCDR Derek Peterson.

2.1.4. NAVSEA HQ

Several key players contributed to the GUARDIAN operation from NAVSEA headquarters at the Washington Navy Yard, Washington, D.C. NAVSEA05 Op Center - NAVSEA Ships Incident Response Center (NSIRC) was stood up the day of the grounding through 11 February. They issued SITREPS daily (four times a day thru 24 Jan).

Participated in NSIRC technical bridge and SIPR chat.

PMS 470 gathered info including weight, location, and photos of critical items on the ship. Also kept the configuration control of the list.

SEA 05P/D discuss ways to lift sections of the ship, section cutting options, system isolation requirements, and hull lift points recommendations (chain plate design).

PSNS coordinate with 05P on weight removal plans

Generated list of Hazmat and Ammo. Worked with NAVSUP to obtain updated load out.

SEA00C – Deployed CAPT Matthews (00C) and LCDR Addington (00C2B) on 19 January for initial salvage coordination with Fleet and SMIT Contractors. 00C continued to provide logistic and salvage support both from on-site, and from their offices at the Navy Yard. Additional support was provided by 00C in Singapore, at the offices of SMIT Salvage.

2.2. US Navy and Philippine Government Coordination

Immediately following the grounding of USS GUARDIAN, coordination between the Philippine government and the US Navy was conducted through the US Embassy in Manila.

As response teams were mobilized and deployed to the area, coordination was directed through the Commander, Task Unit Operation GUARDIAN Ashore team, led by CAPT Gilbert as a representative of Commander, US Forces Seventh Fleet, and including the Commander, US Coast Guard National Strike Force (for oil spill response), and NOAA Marine Biologist Lee Shannon. As the operation continued and the fuel and oil contaminants had been removed from the ship, and that the ship's position had become static causing no significant further damage to the reef, both the USCG presence and Lee Shannon departed. The remaining shore contingent consisted of CAPT Gilbert, who was relieved by CAPT Kacher, Deputy Commodore of DESRON 7, on 13FEB13, the Seventh Fleet PAO, a communications technician, and several other active duty personnel on a rotation as Liaison Officers (LNOs) and logistical support personnel.

As the initial On-scene Element was established, it was commanded by RDML Carney embarked on USS MUSTIN (DDG89) and included SUPSALV (CAPT Mark Matthews and LCDR Chris Addington), CTF73 Salvage Officer LCDR Derek Peterson, MDSU-1 Command Element under CDR Murphy, and the Battle Damage Repair Team from SWRMC under LT Brege as well as a contracted SMIT salvage team under Salvage Master Jan Willem Duit.

The Philippine Government established the Philippine Coast Guard (PCG), under the authority of the Department of Transportation and Communication, as the lead for their response and oversight of the removal of USS GUARDIAN. Commodore Evangelista, PCG, was placed in charge of the Philippine oversight. Included in the Philippine oversight was the Philippine Navy (PN) under Commodore Pena, the Tubbataha Management Organization (TMO) under Mrs. Songco, and the local government in Puerto Princesa.

2.2.1. Philippine Liaison Officers

The Philippine Government had close involvement with the operation from the start. Initially, they were only observing salvage work from their own Coast Guard (PCG), Navy (PN), or Tubbataha Management Organization (TMO) ranger platforms.

With the arrival of the SMIT BORNEO, which would serve as the USN On-Scene Command (OSC) platform, all three organizations embarked Liaison Officers (LNOs) to observe and report on the daily progress. The numbers varied but on average there was one PN rank O2 or O3, one PCG O4, three PCG enlisted and two TMO rangers (some of the rangers were PCG enlisted). The LNOs were first given berth on the SMIT BORNEO on 5FEB13, and they transferred over with the OSC to the JASCON 25 on 18FEB13, where they were also provided with dedicated office space and internet connection.

The LNOs all changed out regularly throughout the operation. It was established that transportation for LNO crew swaps would be arranged by their own organizations. There was normally no notice given of when a crew swap would occur, which caused some difficulty with small boats coming alongside unexpectedly, and at least once the PCG LNOs changed out without anyone in the OSC aware of it until the next day. The main concern for these lapses in communication was the difficulty of keeping accountability of embarked personnel, and the coordination of boats coming alongside during crane operations. It did not cause any setbacks in the operational pace of the salvage.

After a pattern of these events occurred, a “welcome aboard” letter was generated for distribution to the oncoming LNOs. This letter included a brief introduction to the vessel, a basic explanation of the salvage plan, and expectations for how they would interact with the salvage team, including the coordination of transportation. This information had previously been briefed in a semi-formal meeting with CAPT Matthews. The letter was also given to the senior LNO who was asked to ensure that all incoming LNOs understood the language of the letter.

At one point, a TMO ranger embarked on the JASCON 25 had a medical issue that warranted rapid transportation back to shore. In this case, CAPT Matthews determined it appropriate to use the USNS Helicopter to fly the LNO to Puerto Princesa to receive further medical treatment. Approval to transport Philippine Government personnel had already been established with visits from VIPs earlier in the operation, so there was no difficulty in arranging this transportation.

2.3. SUPSALV / SMIT Team

OPNAVINST 4740.2 instructs SUPSALV to maintain and execute worldwide salvage contracts to respond to national tasking and to provide support for Navy Fleet OPS. SMIT Singapore (NAVSEA’s WESTPAC Salvage Contractor) was directed and managed by SUPSALV in response to this CNO tasking. SMIT Salvage was responsible for providing commercial salvage assets as directed by SUPSALV to include two main heavy lift cranes and several support vessels. JASCON 25, a pipe-laying construction vessel, was the primary salvage platform capable of positioning itself within 40 meters of Guardian. This vessel functioned as main asset to dismantle the USS GUARDIAN and as an accommodation platform for the salvage crews of the US Navy and SMIT Salvage crew. With her dynamic positioning system, Jascon 25 can operate her 800 MT crane without the need to set anchors for mooring. The second crane, Smit Borneo (with 500 MT revolving crane), arrived on-site on 5 February and supported the loading of salvaged sections onto an ocean-going barge for transport to a shore facility. Other commercial support vessels included; ARCHON TIDE, TRABAJADOR-1, INTREPID, VOS APOLLO, and VOS HERCULES. Military Sealift Command and US Forces Seventh Fleet provided USNS SALVOR and USNS SAFEGUARD for Command and Control and salvage support. A complete list of vessels supporting the operation is provided in Appendix E.

SMIT provided a team to support the Navy’s response to GUARDIAN’s grounding. At approximately 0800 17 January (Philippine time) SMIT Singapore received notification the USS GUARDIAN had run aground on the Tubbataha Reef in the Sulu Sea and that SUPSALV was tasking SMIT with to support the salvage task. SMIT immediately mobilized a salvage team and

who flew to Puerto Princesa, the closest commercial airfield to the grounding site. The salvage team met with LCDR Peterson, the Seventh Fleet Salvage Officer, Philippine Coast Guard and Philippine Navy representatives in Puerto Princesa and then were then transported to the site by Philippine vessel AS-71. In the meantime, SMIT Singapore contracted with salvage tug Trabajador which departed Subic with an ETA of late 18 January. By the 19th, the SMIT team was on site, onboard vessels USNS BOWDITCH and Salvage Tug TRABAJADOR monitoring the situation. The timely response and proactive support was representative of the effective team SMIT provided throughout the operation.

With the arrival of additional and larger vessels VOS APOLLO, SMIT BORNEO, and later JASCON 25, the SMIT team and the SUPSALV team co-habituated the same vessels and worked hand in hand in the planning the salvage operation. The salvage master at the outset of the operation was Jan Willem Duit. He was replaced by Wytse Huismans on 3 February and returned to the site on 20 March. These two salvage masters coordinated to provide overall planning and management of the contracted vessels and team. Additionally, SMIT hired two Bleyenbergh technicians from The Grab Specialists to provide specialized expertise in the event the hydraulic salvage grabs were needed and four Demolition Engineers from Koole, a Netherlands based firm with expertise in wreck removal, to provide deck-plate support during the hull sectioning phase.

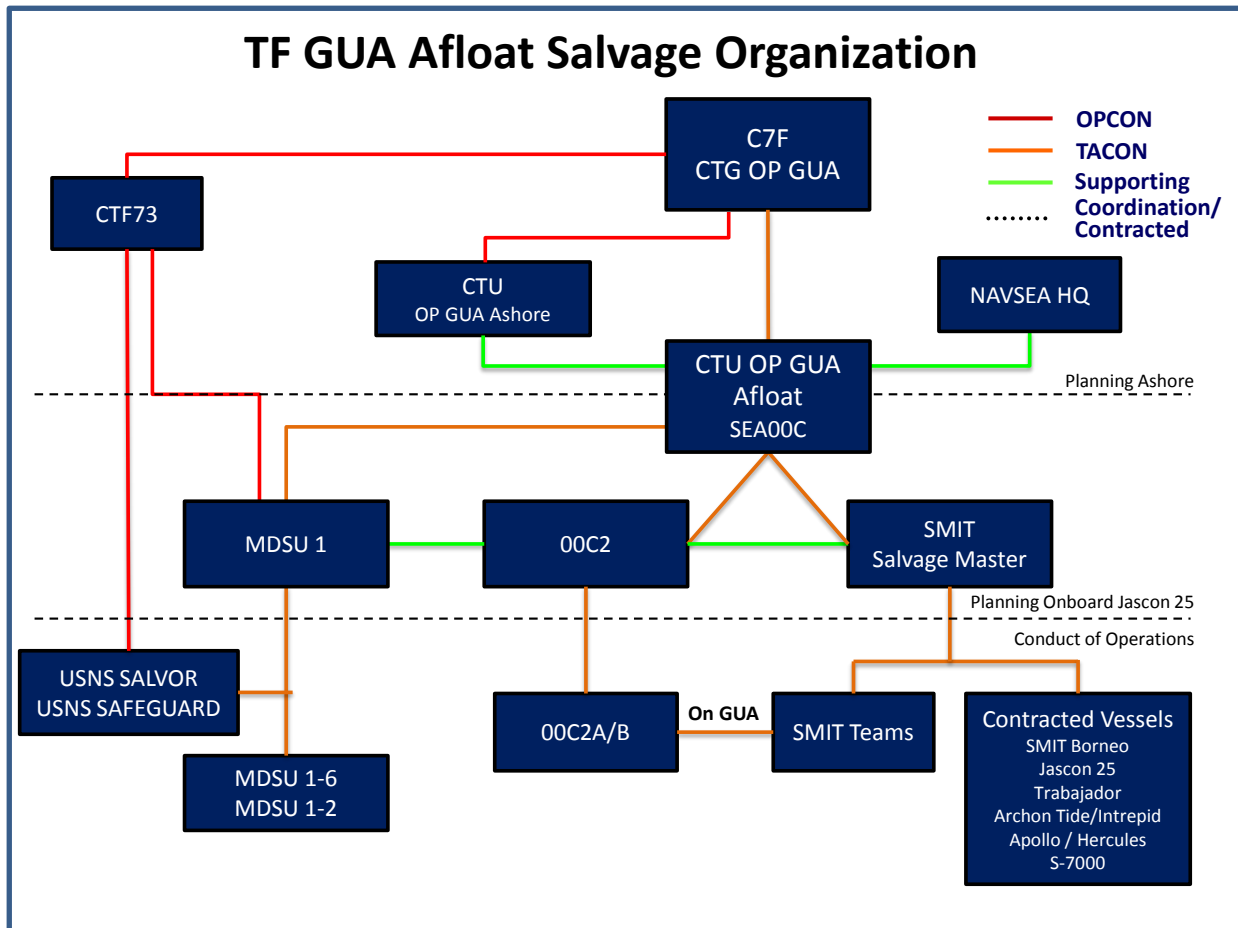
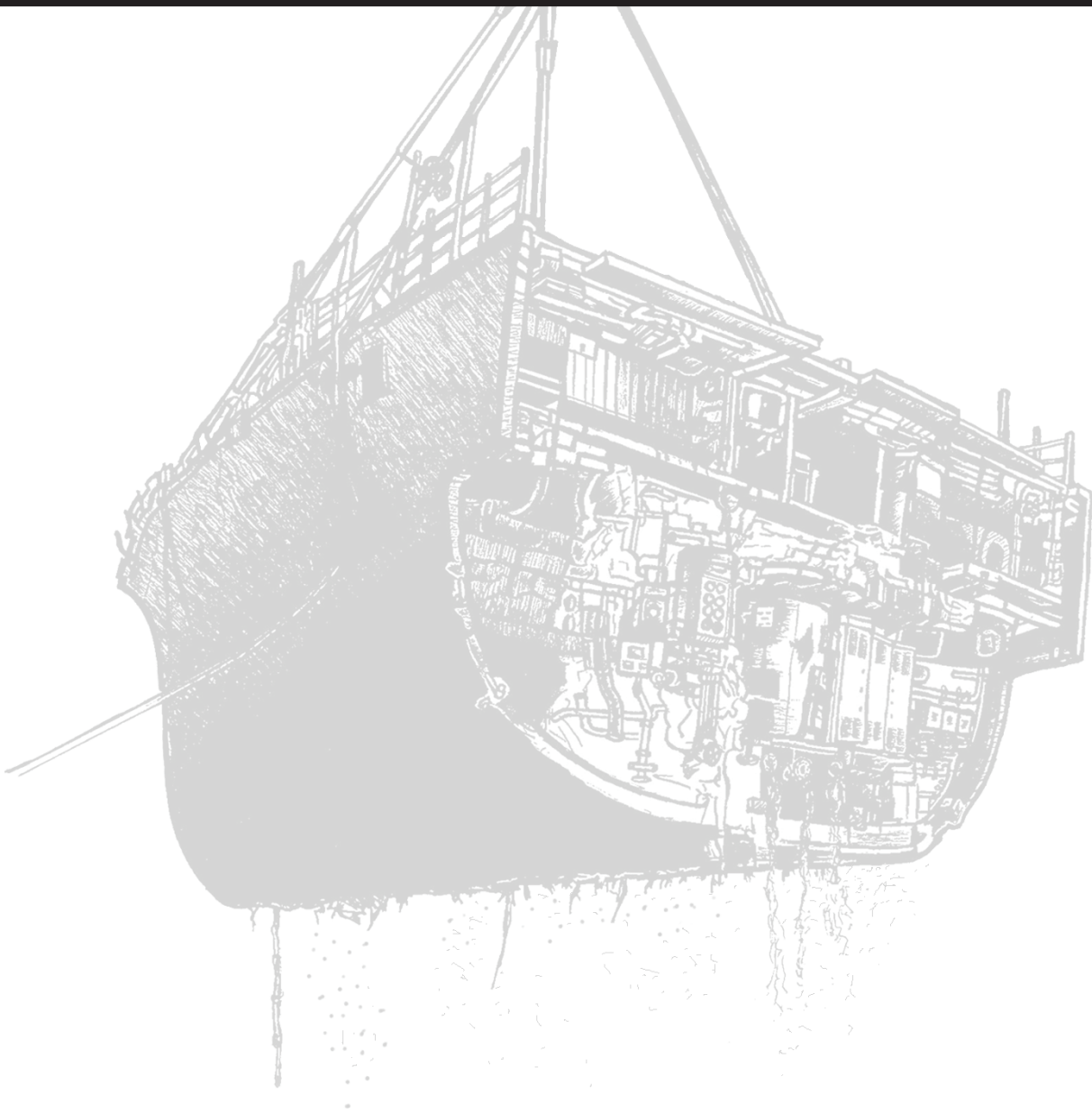

Figure 2-3. Command and Control Organization Chart - Afloat

SECTION 3

TASKING AND FUNDING



This page intentionally left blank.

Section - 3. Tasking and Funding

3.1. SUPSALV Initial Tasking – Immediate Response

USS GUARDIAN drove onto the Tubbataha Reef around 2:25 am on 17 January, Philippine Time (+8). SUPSALV was made aware of the grounding through a telephone call a few minutes after 1700 on 16 January, Eastern Standard Time (-5). At 1721, Mr. Michael Dean reported the grounding to VADM Kevin McCoy (SEA00). At that time, Dean had already spoke with C7F Salvage Officer, stationed in Singapore, and connected them with SMIT, SUPSALV's Westpac Salvage Contractor which is also based Singapore. Mr. Dean's email to VADM McCoy also specified that funding will be required to cover any initial response prior to Fleet funding. Mr. Dean had also been in contact with the NAVSEA Comptroller (Maggie Maguire) and discussed this requirement.

By 1800 16 January (EST -5), the NAVSEA Comptroller committed \$.5M in NAVSEA funds to allow SUPSALV to initiate tasking and response. Mr. Dean contacted Mr. Michael Herb, SUPSALV's Director for Salvage Operations, and informed him that funds were available to engage SMIT. By 2000 EST, Mr. Herb provided CTF 73 Salvage Engineer, Derrick Peterson, authority to engage SMIT for an assessment team.

On the morning of 17 January, NAVSEA 05 began standing up the NAVSEA Incident Response Center and during a phone call between Mr. Dean and PACFLT N43, Mr. Dean indicated that \$10M in initial funds were required for SUPSALV to continue its salvage effort. By 1800, (Hawaii time, -10) VADM Swift (Commander Seventh Fleet) reported GUARDIAN conditions had turned for the worse. GUARDIAN was broaching and high waves were pushing her further onto the reef. ADM McCoy responded by informing ADM Swift that SEA00C was engaged and was sending SUPSALV to AOR to lead the salvage operation. VADM Swift replied that a "full on effort needed" and "to start the search for nearest crane".

PACFLT N43 pushed \$10M funding document on 18 January 18th. At this point, SUPSALV was responding to degrading conditions on the reef and recognized that the potential tow to repair facility task had evolved to a long term wreck removal with floating crane/barge task. The SMIT assessment team was in the operations area but had not yet been aboard GUARDIAN due to weather conditions.

Commander Seventh Fleet direction on the 17th and the \$10M funding document which SUPSALV received on the 18th became the basis for SUPSALV's nearly 4 month long engagement in on the Tubbataha Reef in the Sula Sea.

3.2. COMSEVENTHFLT Operation Order (OPORD)

Commander Seventh Fleet issued the OPORD on 19 January directing COMSEVENTHFLT assets actions during recover and salvage operations of USS GUARDIAN in the Sulu Sea. At that point in time, the GUARDIAN had been aground nearly 48 hours, its crew had transferred to MSV C-CHAMPION, USS MUSTIN and USNS BOWDITCH. USNS SAFEGUARD, VOS APOLLO, and MT TRABAJADOR were on station or enroute to provide assistance. There was imminent danger of a more significant hull breach, which could cause significant environmental damage to the Tubbataha Reef and surrounding area. Essential elements of the OPORD follow:

3.2.1. Mission Statement:

“CTG OP GUARDIAN conducts expeditious recovery and salvage operations on USS GUARDIAN in order to minimize the negative environmental impacts on the Tubbataha Reef and Sulu Sea while ensuring the security of us interest, property, and capabilities”.

3.2.2. Commander's Intent.

The purpose of this operation is to recover the USS GUARDIAN, maintaining the safety of the crew and salvage team, and minimizing the environmental impacts due to grounding on Tubattaha Reef.

3.2.2.1. Method:

“My desire is to secure USS GUARDIAN with three primary focus areas:

- a) Essential manning and crew accountability;
- b) Enablers for stability and containment such as command and control and logistics;
- c) USN assets (CTF 72, 73, 76) and Republic of the Philippines civilian and naval forces staged to conduct a safe and successful salvage and recovery operation.

This operation must preserve the strategic alliance with the Republic of the Philippines and take all necessary steps to minimize damage to Republic of the Philippines sovereign territory.

We will execute this operation through a supported/supporting relationship, which will be inclusive and accommodating of Republic of the Philippines interests. We will integrate our operation with U. S. Governmental and international non-governmental organizations that are exercising other means to bring this crisis to conclusion. Our command structure will be clear, and our control will permit full and effective coordination among subordinate elements.

We will leverage all the capabilities in SEVENTH Fleet. Speed and timing are essential-take full advantage of every opportunity in order to gain momentum to control the crisis and accelerate actions without compromising safety. I expect my subordinate commanders to provide thorough solutions that are practical and timely.

Operation GUARDIAN will be conducted through four phases:

- 1) Crisis control and immediate - CTF 76 is the main effort and the supported Commander.
- 2) Stabilization - CTF 76 is the main effort and supported Commander.
- 3) Salvage and recovery - CTF 73 is the main effort and supported Commander.
- 4) Transition – Commander Seventh Fleet is that main effort and transitions the role of lead agent to COMPACFLT.

Endstate:

The end state for our operation is the safe recovery and salvage of the USS GUARDIAN and any environmental impact is appropriately mitigated. Opportunities to advance and build trust with the Republic of the Philippines

Throughout this operation should be sought and capitalized, and long term mitigation efforts are appropriately transitioned to Commander, U.S. Pacific Fleet.

D. Limitations:

- 1) Protect any remaining classified material and vital U.S. Government property.
- 2) Minimize impact to other COMSEVENTHFLT operations.
- 3) Conduct planning at the unclassified level to the maximum extent possible.
- 4) Do not cause unnecessary environmental damage during recovery/salvage operations.

- 5) Do not put other assets in extremis during recover operations.”

3.2.3. Concept of Operations.

- A. Phase I. Crisis control and immediate actions. During this Phase, CTG OP GUARDIAN is designated as the main effort (ME). My priorities for this phase are
- (1) Safety of the crew;
 - (2) Mitigation of environmental damage; and,
 - (3) Establishment of command and control. The essential tasks during this phase are the establishment of command and control, security, and environmental protection. This phase ends when environmental protection measures are in place and a forward command element is established and functional.
- B. Phase II. Stabilization. During this phase, CTG OP GUARDIAN remains the main effort. My priority for this phase is prevention of any additional environmental damage beyond the initial grounding of GUARDIAN. The essential tasks are to develop a salvage plan and environmental control measures. This phase ends once there is an approved salvage plan, the crew is safely returned to homeport with counseling provided, risk of wide-spread environmental damage is mitigated, and ship has been defueled and otherwise secured.
- C. Phase III. Recovery and salvage. During this phase, CTF 73 is designated as commander, CTG OP GUARDIAN. My priority for this phase is removal of USS GUARDIAN from the reef. The essential tasks during this phase are to remove GUARDIAN from the reef and develop a final disposition and environmental recovery plan. This phase ends with the removal of USS GUARDIAN from the reef and the environmental recovery plan is approved.
- D. Phase IV. Transition. During this phase, COMSEVENTHFLT is the main effort. My priority for this phase is the transition to normal operations. The essential tasks are to support all legal and safety Investigations, implement an environmental recovery plan, resolve claims against the U.S. Government, and continue public affairs (PA) efforts. This phase ends when COMPACFLT has assumed duties and responsibilities as the lead agent.

3.3. SMIT task

SUPSALV issued verbal tasking to SMIT Singapore, PTE LTD on 17 January authorizing an assessment team to travel to the GUARDIAN and provide a recommended course of action. Additionally, SMIT was asked to engage the nearest salvage tug and dispatch it to the GUARDIAN Op area. After the assessment team was authorized, SUPSALV contacted COMPACFLT and obtained a funding commitment for \$10M, SUPSALV’s initial cost estimate. The Delivery Order identified Deputy Fleet Comptroller, COMPACFLT N00FB, as Funding POC. The Statement of Work read:

CONTRACTOR TO PROVIDE SUPPORT FOR EMERGENCY RESPONSE AND RECOVERY OPERATIONS FOR USS GUARDIAN (MCM-5) GROUNDING ON TUBBATAHA REEF, SULU SEA, PHILIPPINES. SUPPORT TO INCLUDE PERSONNEL, VESSELS, AND EQUIPMENT REQUIRED FOR ASSESSMENT, PLANNING, STABILIZATION, OIL REMOVAL, AND VESSEL RECOVERY.

3.4. Funding

3.4.1. Funding Sources

After the \$0.5M in seed money was committed by NAVSEA Comptroller on 16 January, the operation funds were solely provided by Commander Pacific Fleet - N43.

3.4.2. Funding Summary

Funding documents were received incrementally as the estimate progressed. Funding summary is provided below.

Date	Estimate	Increment
18 January	\$10,000,000	\$10,000,000
8 March	\$25,000,000	\$15,000,000
29 March	\$40,000,000	\$15,000,000

3.5. Cost Accounting

Initial cost accounting was begun in person with SMIT, at their Singapore office, by 00C24, Vince Jarecki. During the initial establishment of requirements, daily cost figures were developed, and subsequently referred to as the “daily burn rate.” The daily rate fluctuated wildly over the first few weeks of the operation due to the hiring/chartering of numerous assets, and the mobilization of several organizations. SMIT and 00C24 scoured South East Asia for suitable vessels for charter that would meet the dynamic and complex requirements to help remove the GUARDIAN from the Tubbataha Reef. By using estimated figures for the anticipated hiring of vessels, equipment, and a base line daily burn rate, 00C was able to provide a funding forecast to PACFLT to help planning for funding increments. Once the operation settled into a daily battle rhythm, SMIT Singapore published daily costing spreadsheets that enabled SUPSALV to track and monitor costing on a daily basis. On-scene, 00C2, Mr Mike Herb, coordinated logistics vessel hiring with the SMIT Salvage Master. In the 00C offices at the Washington Navy Yard, Vince Jarecki coordinated delivery order modification and funding increases with 00CB, Mr. Mike Dean, and 00C1, Mrs. Tina Bender.

At the conclusion of the operation, the final close out costing and invoice review was conducted at the SMIT Singapore offices. 00C2A, LT Dustin Cunningham attended to review the final expenses spreadsheets, invoices and to inspect all procured equipment during the operation. The equipment that was in good working condition was delivered to the ESSM Senoko Warehouse, Sembawang, Singapore for storage and use in future operations.

SECTION 4

MOBILIZATION

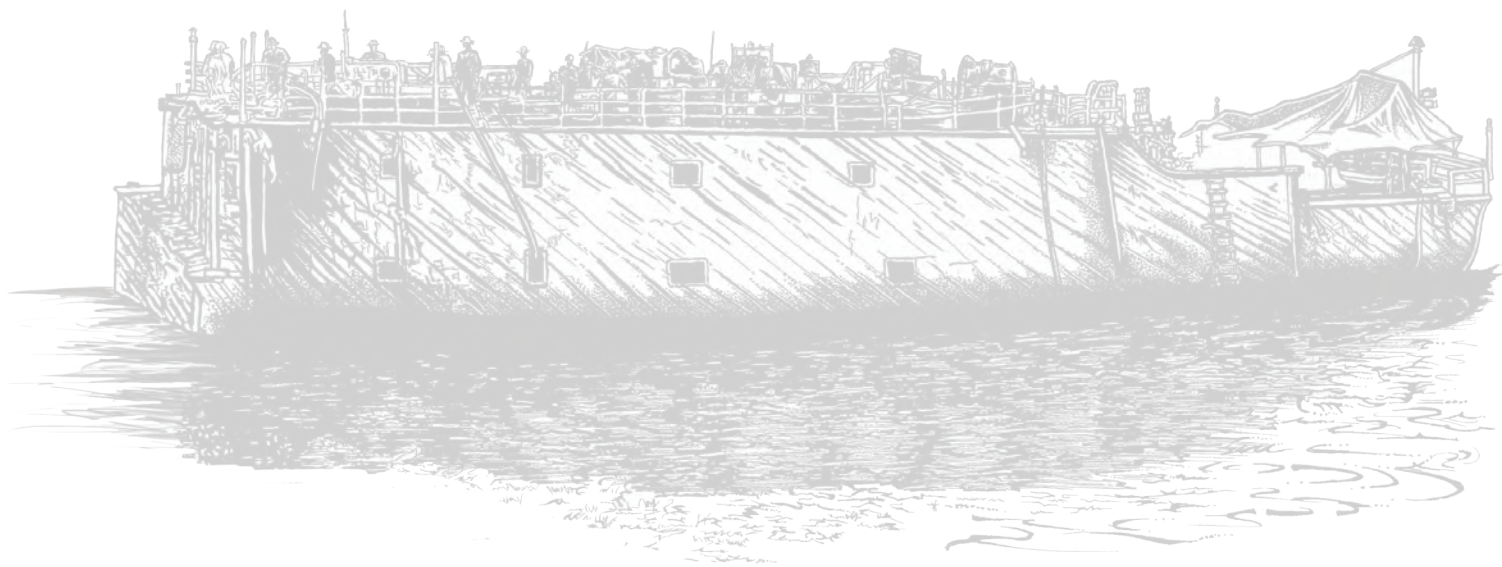

This page intentionally left blank.

Section - 4. Mobilization

4.1. SUPSALV Mobilization

SUPSALV, CAPT Mark Matthews, deployed from Washington, DC on 18 January along with LCDR Chris Addington, (SEA 00C2OB) arriving in Puerto Princesa on 20 January. At this point, the GUARDIAN crew was transferring from MSC vessels C-CHAMPION and BOWDITCH to the recently arrived USS MUSTIN (DDG 89). MDSU ONE Co 1-6 arrived the same day from Pearl Harbor. SUPSALV and MDSU 1 teams were transported to GUARDIAN Op site by VOS APOLLO on 21 January.

SUPSALV's naval architect, Vince Jarecki, (SEA00C24) deployed on 23 Jan to Singapore to work with SMIT's salvage planning team to ensure the proper mix of salvage assets and equipment were identified.

SUPSALV's Head of Operations and Ocean Engineering, Michael Herb, (SEA00C2) oversaw the development of the salvage solution from SUPSALV headquarters, managing SMIT tasking and aligning Navy assets and funding before deploying. He departed Washington, DC on 31 January and after arrival on the Guardian op site, remained for the duration.

LT Dustin Cunningham (00C2OA) replaced LCDR Addington when he flew out on 15 February and both Assistants for Salvage rotated in theater over the course of the operation. The SUPSALV team were quartered on SMIT contracted vessels; VOS APOLLO, SMIT BORNEO and then JASCON 25.

Following the completion of the wreck removal and reef clean-up phases, LCDR Addington supervised the Barge S-7000 offload in Sasebo, Japan from April 15th -25th, while LT Cunningham traveled to Singapore 27 April until 05 May to take custody of government procured equipment for stowage in the ESSM Senoko Warehouse, and review final invoices with SMIT.

4.2. SMIT Mobilization

4.2.1. Salvage Team

The initial Salvage Assessment Team was made up of 7 SMIT employees who flew in to Puerto Princesa on 17 January on a charter aircraft. They were transported to GUARDIAN Operations Site onboard C-CHAMPION and transferred to Trabajador to begin scoping the salvage operation. This crew was supplemented by 7 additional SMIT divers and engineers on 19 January.

4.2.2. Salvage Support Vessels

SMIT's immediate response, after being tasked to support the GUARDIAN salvage task was to identify what salvage assets were in the immediate area. They placed a Malayan salvage tug, TRABAJADOR, on contract and it sailed on 17 January from Subic arriving at the salvage site on 18 January. Additional salvage assets were mobilized from Singapore. The first was VOS APOLLO, which arrived at Puerto Princesa on 19 January. ARCHON TIDE and SMIT BORNEO were placed on hire 21 January and departed from Singapore on 24 January.

Initially, SUPSALV asked SMIT to begin preparing two cranes for mobilization. They were SMIT BORNEO and SMIT CYCLONE. BORNEO is a 500T revolving crane on a DP0 barge. CYCLONE is a 1000T floating sheerleg crane also on a DP0 barge. When it became clear that GUARDIAN was going to be cut up and not lifted and refloated or moved onto a barge in one

piece, SUPSALV asked SMIT to cease CYCLONE's mobilization. This order was given on 25 January.

Based on the geography of the reef and the proximity of the deep water drop off, the salvage team estimated that a large crane, capable of maintaining position within 30 meters off GUARDIAN and the capacity to lift large sections of GUARDIAN was required. They did not think SMIT BORNEO was going to be capable of making the large lifts and did not know if she was going to be able to set a 4 point moor on that close to the reef. SMIT sourced a DP3 Pipe Laying vessel, JASCON 25, from Sea Trucks and on 8 February, placed her on hire.

SMIT identified a large oceangoing barge for transporting GUARDIAN's sections to port. It was a Malayan barge identified as S-7000. Salvage Tug Trabajador left Puerto Princesa on 13 February enroute Subic to pick up S-7000. The tug departed Subic on 15 February and arrived at GUARDIAN Site on 22 February towing S-7000.

4.2.3. Salvage Support Equipment

SMIT chartered a B-737 aircraft to carry equipment airfreighted into Puerto Princesa on 20 January where it was loaded onto VOS APOLLO. Additional gear was laid on SMIT BORNEO prior to its departure and JASCON 25 received an outfitting of gear transferred from the SMIT yard prior to her departure. During JASCON's transit, conditions on GUARDIAN were deteriorating and with the strength of the hull's structure in question, it was decided that a possible fallback salvage alternative would be to excavate the interior of the ship in the vicinity of Auxiliary Machinery Room and Main Engine Room using salvage grabs. This equipment was sourced from The Grab Specialists in the Netherlands. This equipment was placed on hire on 16 February and transported to Puerto Princesa in 3 Antonov AN-12 aircraft chartered from Ukraine Air Alliance.

4.3. MDSU-1 Mobilization

Mobile Diving and Salvage Unit One, based in Pearl Harbor, HI supported the GUARDIAN salvage operation from 21 January through 09 April 2013. MDSU 1 Company 1-6 arrived in Puerto Princesa on 20 January and proceeded to the GUARDIAN site on VOS APOLLO. They were berthed on available ships in the operation area until USNS SALVOR arrived where they made their base of operations. MDSU Company 1-2 flew into Singapore and rode VOS HERCULES to Puerto Princesa and arrived on 15 March. Company 1-2 relieved Company 1-6 on 17 March and Company 1-6 departed on VOS HERCULES. MDSU's base of operations shifted from USNS SALVOR to USNS SAFEGUARD on 16 March.

4.4. Transportation / Logistics Issues

4.4.1 Customs Clearances

The contracted vessels that were not Filipino-flagged were required to clear customs in Puerto Princesa prior to proceeding out to the Tubbataha Reef. Only in specific circumstances, were the vessels able to clear customs on-site. Additionally, all equipment that was air-freighted into the Philippines had to clear customs in Puerto Princesa, prior to be loaded for delivery out at the wreck site.

4.4.2 Government Travel Country Clearance/Requests

All U.S. Military/Government personnel were required to have country clearances prior to entering the Philippines. These requests were conducted as per PACFLT travel requirements, and ensured all personnel had valid ATRF, SERE 100 training and had received the appropriate country briefings regarding travel. However, halfway through the operation, it was discovered that air travel on Philippine Airlines was restricted. This

required an operational waiver, due to the fact that Philippine Airlines was the sole provider of air transport in and out of Puerto Princesa.

4.4.3 Helicopter Coordination

The initial need for helicopter support was identified due to the remote location of the GUARDIAN. The helicopter detachment organic to USNS WALLY SCHIRRA was a civilian contracted Puma crew, and required clearance to be able to land on hired vessels SMIT BORNEO and JASCON 25. This clearance was coordinated through SUPSALV and MSC, and came in the form of a signed endorsement from SMIT/Sea Trucks stating their flight deck details, and that they would allow the helicopters to use their flight decks for equipment and personnel transfers as required throughout the operation.

On site, all helicopter coordination was centralized with the Ashore Command maintaining the master flight plan for Operation GUARDIAN. A military point of contact was established at the On Scene Command, and flight requests for both the military and contractor elements were directed through the OSC POC to the Ashore Team to de-conflict with any other requirements or restraints. The Ashore Command was responsible for submitting official flight requests to the USNS WALLY SCHIRRA Puma Detachment at least 24 hours out. To ensure a broader understanding of upcoming flight requests and requirements, all emails regarding flight operations included the POCs for each of those three entities.

Occasional difficulties arose in the flight scheduling process due to additional tasking for the Puma detachment outside of OPGUA, poor satellite communications flow with the WALLY SCHIRRA, and lack of passenger information from the contractors on scene. None of these difficulties had an impact on operations because of the effort on all ends to find solutions.

All flight operations to the on scene platforms were scheduled in such a way as to minimize the impact on crane operations. Any platform receiving a helicopter had to suspend crane operations for a period of time before and during flight operations. Because of these constraints, an effort was made to combine requests to reduce the number of flights, and when possible minimize the number of stops at the OSC (i.e. combining drop-off and pick-up of personnel at OSC, often requiring two stops at the airport).

All helicopter flights to shore landed at the Philippine Air Force base adjacent to the Puerto Princesa commercial airport. Logistics to and from the Air Force base were directed by the Ashore Command.

4.4.4 Medical Detachment

A CTF 76 medical team arrived onboard USNS WALLY SCHIRRA. The 4 person surgical team consisting of a General Surgeon, Nurse Anesthetist, Critical Care Nurse, and an Operating Room Technician. After SMIT BORNEO's arrival on February 4, they made inquiries about the medical facilities on SMIT BORNEO including the staffing of those facilities. After a ship visit and assessment of BORNEO's facilities, they committed to operating from and remaining on WALLY SCHIRRA for the duration of the operation. They assessed JASCON 25's capabilities as well and accommodated that into a comprehensive Medevac Plan. That plan is summarized in Chapter 1, Section 1.4.1 - Safety of Personnel.

This page intentionally left blank.

SECTION 5

OPERATIONS



This page intentionally left blank.

Section - 5. Operations

5.1. Immediate Response

SUPSALV's immediate response was to task SMIT to send an assessment team to evaluate USS GUARDIAN's grounded condition. Additionally, SUPSALV task SMIT to engage the nearest salvage asset (ocean tug) to deploy to the site and standby for direction. In response, SMIT engaged Malaysian salvage tug TRABAJADOR-1 which was mobilized from Subic around 1300 17 January. (Philippine Time). A charter flight carrying the SMIT assessment team departed Singapore at 1600, 17 Jan and arrived in Puerto Princesa at 2000 the same day. The team contained a Salvage Master, Jan Willem Duit, three salvage supervisors and three divers.

The 18th was an eventful day for GUARDIAN, her crew and the salvage team. GUARDIAN had broached the evening before and GUARDIAN crew abandoned their ship, transferring onto MSC Champion and USNS Bowditch which remained on site in the vicinity of GUARDIAN. The SMIT team, still in Puerto Princesa met with C7F Salvage Officer, LCDR Derrick Peterson, and CAPT Tanada, a Malaysian salvage master and the Philippian Coast Guard, prior to departing to the GUARDIAN op site on Philippine Naval vessel AS-71. The Salvage Tug TRABAJADOR arrived at the GUARDIAN site and SMIT placed a second vessel on charter, DP-1 vessel VOS APOLLO, which prepared for departure from Labuan, late pm on 18 January. Finally, on that same day, SUPSALV, CAPT Mark Matthews and Assistant for Salvage, LCDR Chris Addington departed Washington, DC, enroute Puerto Princesa.

On the 19th, the SMIT team had arrived at the GUARDIAN site and, although the weather conditions did not support boarding, their consultation with GUARDIAN's crew and view of the wreck from the sea made it clear that the ship would not be retracted from the reef and towed to port and that a heavy lift of one kind or another would be necessary. SUPSALV began conversations with SMIT about mobilizing SMIT BORNEO and SMIT CYCLONE, a 1000 MT derrick type crane barge.

Over the next 24 hours, SUPSALV and Assistant for Salvage would arrive at Puerto Princesa and would join a second SMIT salvage team and embark aboard VOA APOLLO for transport to GUARDIAN site. A charter aircraft would depart Singapore with fuel lightering hoses, pumps, and absorbent materials bound for Puerto Princesa. High waves and strong winds prevented boarding GUARDIAN on the 20th but on the 21st, the first team of salvors entered the water, swam onto the reef and climbed aboard GUARDIAN for a first-hand assessment of the condition of the vessel.

5.1.1. POSSE Support

With USS GUARDIAN initially aground bow onto the reef and stern in deep water the preferred course of action was to pursue refloating the vessel. Reports from the vessel stated the forward 30ft of the ship, to Frame 17, was out of the water and the stern was down with approximately 3ft of freeboard remaining at the transom. Flooding was reported as occurring but controllable. Program of Ship Salvage Engineering (POSSE) analysis using a pre-defined MCM-1 Class model and an assumed full load displacement resulted in an estimated 575LT aground. As the draft report was taken approaching high tide and there is less than 100LT of liquid load on an MCM, refloating GUARDIAN with the only tug en route, TRABAJADOR-1, was unlikely.

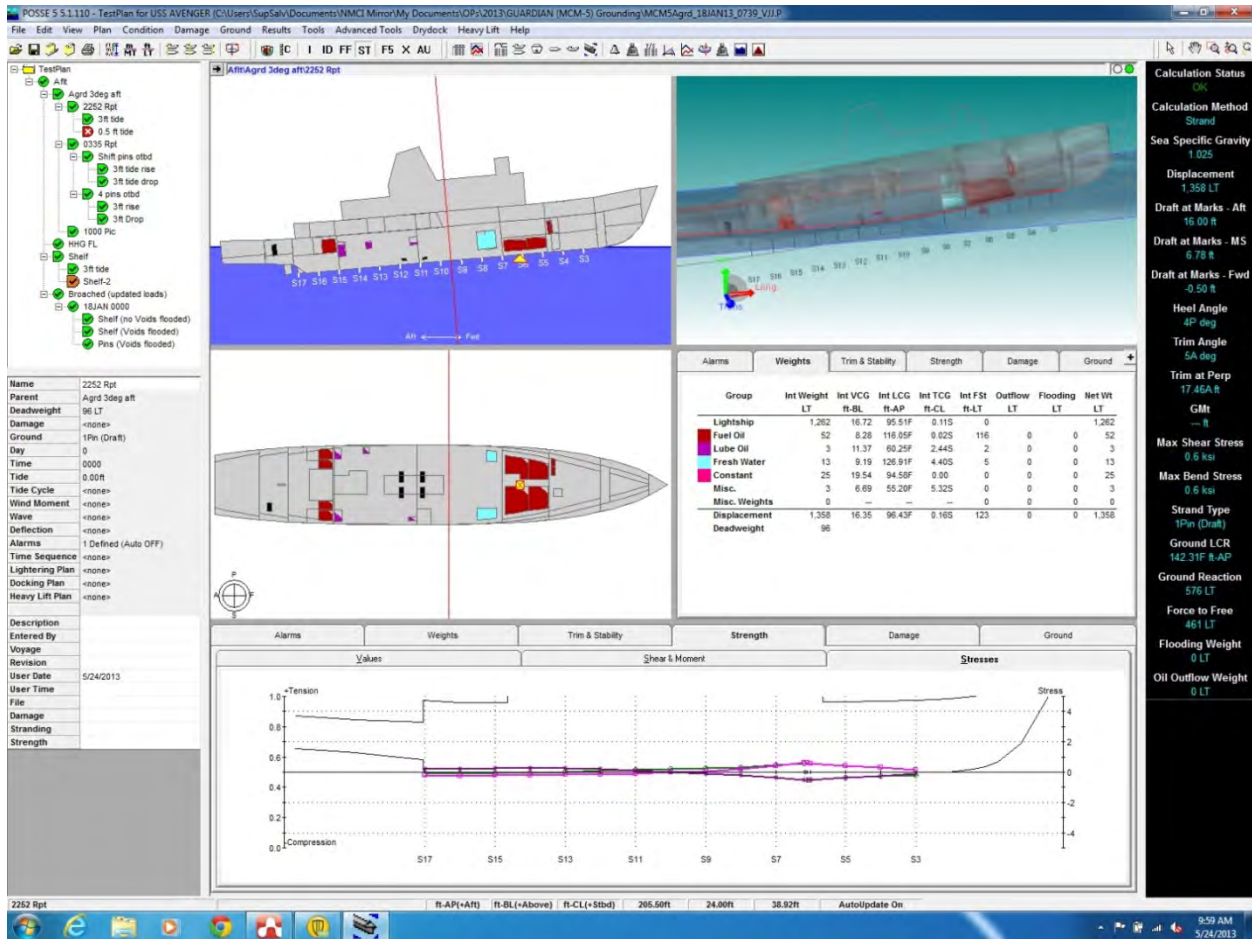

Figure 5-1. Screenshot of POSSE modeling performed after receiving reports on USS GUARDIAN’s initial grounded condition.

After broaching, additional POSSE analysis were performed but once the machinery spaces flooded and became tidal it quickly became apparent that GUARDIAN had minimal remaining buoyancy and was aground by her full weight of approximately 1200LT. Limited additional POSSE work reviewed and determined acceptable longitudinal stresses in the grounded condition and the risk of GUARDIAN being driven farther up the reef during the anticipated weather conditions.

5.2. Planning / Discovery – Evolving Salvage Plan

5.2.1. Defining the Task

The situation that presented itself to the salvage team on 22 January was bleak. The following conditions were relevant:

- GUARDIAN was on shallow reef but next to a steep drop off.
- GUARDIAN was severely damaged and had the potential for breaking up. She wouldn't float and therefor couldn't be pulled off the reef.
- GUARDIAN weight was roughly 1200 tons and was expected to increase due water absorption. The nearest heavy lift asset (SMIT CYCLONE) has a calm water capacity of 1000 tons.
- Weather was rough and not expected to abate until March (NE monsoon).

Based on the above described conditions, SUPSALV faced a daunting challenges to extract USS GUARDIAN from the Tubbataha Reef without causing additional environmental damage. Those challenges included:

- Heavy lift barges/cranes are low inventory/high demand. There would be a long transit distance/time involved in getting the asset to the GUARDIAN operations site.
- Getting a lift barge moored close enough to reach GUARDIAN without going aground itself or damaging the reef.
- There would be an estimated 20m – 30m distance between barge and GUARDIAN based on reef / dropoff geometry. Possible ~15% reduction in lift capacity depending on crane barge selected.
- Cranes are rated statically, swell astern is dynamic. Ocean swell would result in de-rating the maximum capacity of a lift asset of up to 30-50%. This is often a judgment call.
- Mooring or positioning a lift barge requires anchors in up to 1600' of water or ability to hold using a very robust DP capability.
- Ultimately, the plan would require placing GUARDIAN on the lift platform or other barge also position adjacent to the reef.

Overcoming these challenges would require a joint effort between SUPSALV, SMIT, NAVSEA HQ, and other Navy activities. Various analysis contributed to the success. Appendix A provides a number of the engineering planning and analysis documents

5.2.2. Salvage Plan

The development of the salvage plan was a fluid process because neither the material condition of the wreck nor the environmental constraints were easy to assess or predict. Both factors were difficult to evaluate, and the first iterations of the plan were an attempt to keep up with the ever changing predictions of what conditions would be present when the assets arrived on scene.

The first draft of the SMIT salvage plan was prepared for distribution on 28 January. It was based on early inspections of the material condition of USS GUARDIAN. It was determined that due to the amount of bottom damage, development of cracks in the structure and the current position of the vessel on the reef, refloating was not an option. It also recognized that removal of GUARDIAN was desired at the earliest convenience possible.

Other conditions which were recognized included:

- All hydrocarbons and hazardous materials had already been removed from the vessel.
- Routine North East monsoon conditions and sea/swell impacts to GUARDIAN's port side were causing the ship to continually deteriorate.
- The bottom had been severely damaged from stem to stern.
- Engines were push out of true.
- Frame 63 had been displaced and opened a connection between the main engine and the auxiliary machinery room.
- Cracks had been observed in the superstructure and these cracks were widening as the ship moved during wave impacts.

At this point in time, SMIT BORNEO, a 500T revolving crane barge, was due on station on 4 February. It was envisioned that Borneo could drop two stern anchors in deep water and two bow anchors close to the edge of the reef on either side of the casualty's position. SMIT BORNEO would be assisted by vessels available on site and possibly a small pusher tug to simplify positioning adjacent the reef. The anchoring plan is provided in figure 5-2.

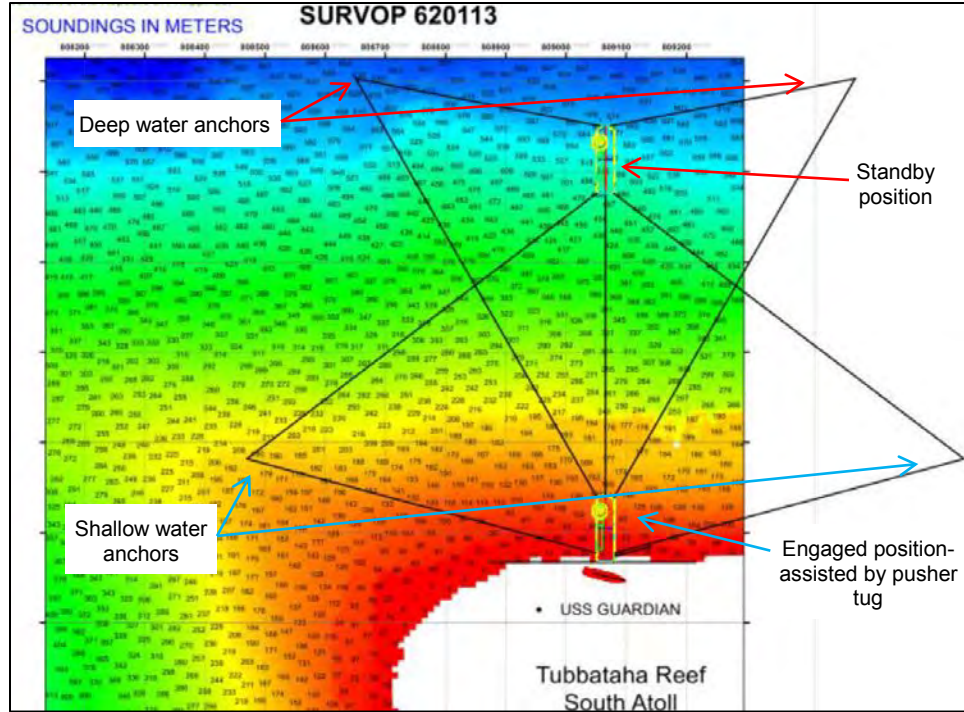

Figure 5-2. SMIT BORNEO anchoring plan.

Borneo’s task was to begin removing heavy equipment from GUARDIAN’s fantail and topsides. Following that, they would begin removing the mast, the funnel, the cable reel, and then the superstructure (02 level then the 01 level). BORNEO’s main boom was capable of a 500MT lift at a maximum reach of 16m but that capacity dropped off with additional distance and with a raise in wave height. BORNEO’s Main Hoist capacity curves are provided as figure 5-3

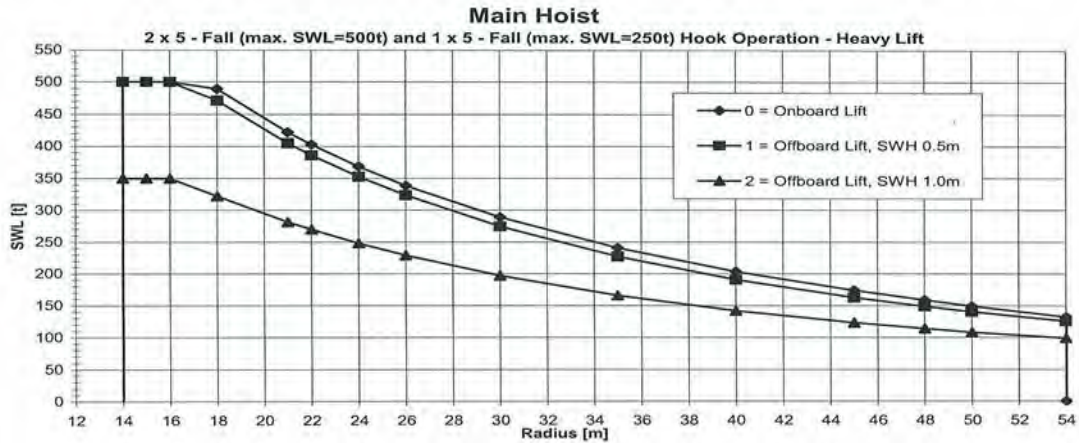

Figure 5-3. SMIT Borneo crane capacity curve. Note the reduced lift capacity when 0.5 meter or 1.0 meter wave conditions are present.

SMIT was also negotiating with a DP3 capable pipe-lay construction vessel, JASCON 25 with an 800T crane which would be capable of lifting heavier sections of the hull and position itself with ease close to the reef using its DP3 capability. At this time, it was not known what SMIT BORNEO would be capable of lifting and what would be left for JASCON 25 to lift.

After the removal of the superstructure, it was envisioned the hull would be cut at frames 44, 63, and 86. Hull cross section and cut lines are provided in the figure 5-4. Consideration was given to making more cuts to reduce the size and weight of the sections. Rigging plans were formulated.

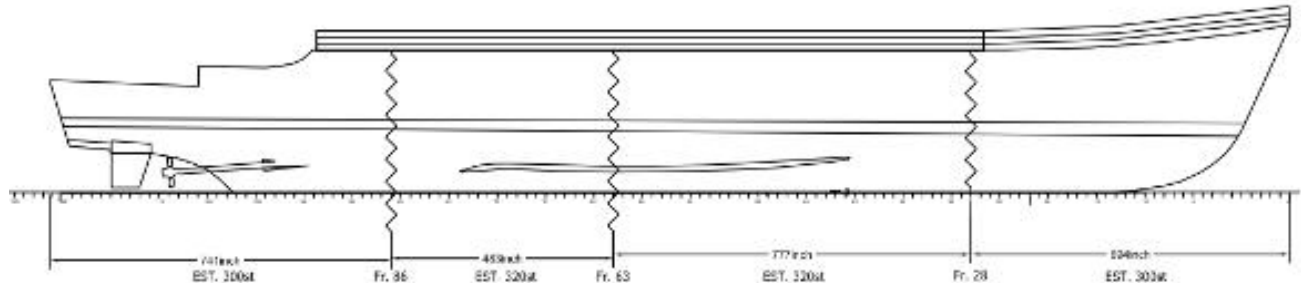

Figure 5-4. USS GUARDIAN hull section cuts in first draft of Salvage Plan.

Salvage Plan Revision 1.2 was issued on 31 January. It generally filled in blanks that were left open in the original draft. Some of those details included the following:

- Provision of a deck barge to hold the material, superstructure, and hull sections removed from GUARDIAN.
- Assumption that JASCON 25 would be required to lift the heavier portions of GUARDIAN.
- Rigging options were addressed including a plan to run webbing or wire rope under hull and the option to use Hoeksma Insert Bollards as attachment points for rigging the hull.

Salvage Plan Revision 1-3 was issued on 1 February. This plan continued to fill in gaps in the earlier versions. Those added details included:

- The barge designated for carrying GUARDIAN sections was identified as S-7000.
- Weight estimates were refined and tonnage estimates were included for each of the 4 hull sections with machinery still inside.
- Weight estimate were provided for a two cut option as well. The three lifts would include:
 - Bow
 - Auxiliary machinery room
 - Engine room and stern (in one lift).

Salvage Plan Revision 1-4 was issued on 3 February. This was the first version to be submitted for and receive NAVSEA approval. It removed all reference to using shaped charges as an option to separate the hull sections.

Salvage Plan Revision 1-5 was the final plan issued. It was released on 9 February and approved on 10 February. It reflected a change in approach due the continued structural degradation of GUARDIAN. The plan also reflected the fact that attempts to put SMIT BORNEO into a 4-point moor adjacent to the reef on 7 February had failed. They were unable to set an anchor on the steep slope nearest to the reef. Based on this, the plan identified JASCON 25 as the single salvage crane to be utilized to remove GUARDIAN equipment and structure. Figure 5-4 shows JASCON 25 relative to the reef and GUARDIAN.

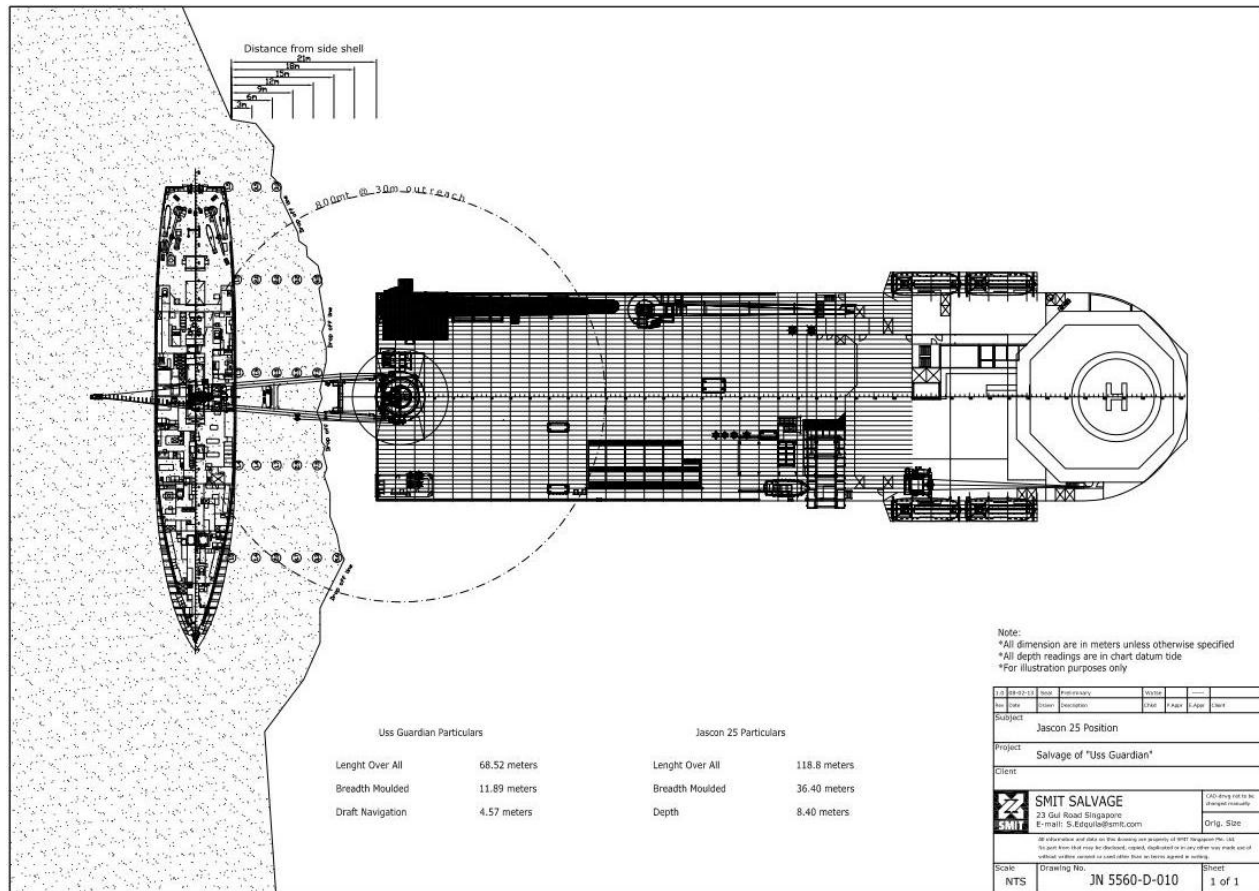

Figure 5-5. JASCON 25 positioned next to the reef. Note the close proximity to the reef in order to retain maximum lift capacity.

SMIT BORNEO would be anchored with the barge S-7000 at a safe distance from the reef and used to transfer material from the DP platform, ARCHON TIDE, to S-7000. An additional change in the salvage plan was the requirement to remove machinery from the AMR and MMR. The plan indicated that they would attempt to retain as many of the structural cross members as possible while removing the machinery. After bow removal, it was anticipated that the MMR and AMR sections could not be lifted as complete sections as they may have disintegrated significantly by then. For that reason, salvage grabs would be sourced and transported to the site in case they were needed. Appendix G is a complete copy of the final approved Salvage Plan.

5.3. Loose Items Recovery

Since the GUARDIAN's grounding, the salvage forces worked meticulously to recover any reusable equipment and remove any potentially harmful materials including petroleum-based products and human wastewater. Ordnance and ammunition were accounted for and removed immediately after the salvage assessment on 22 January 2013. As far as practicable, all loose items from within the hull and on deck were removed by RHIB to other vessels to mitigate possible environmental impact and to safeguard any sensitive items or high value items that can be returned to the fleet.

5.3.1 Personal Item Recovery

On 21 January 2013, The salvage team boarded the USS GUARDIAN for the first time to perform a salvage survey. After the survey was completed, the team split up into recovery mission areas, to include, classified material, weapons and ammo, high value government items and high value personal items.

A team of MDSU One and SWRMC BDR divers swept each berthing compartment and stateroom to collect any personal items of value on 22 January. Items included wallets, cameras, passports and identification. These items were taken to the USS MUSTIN for the GUARDIAN crew to recover. All personal items recovery efforts were suspended after that day. From then on, everything on the GUARDIAN that was not considered classified or weapons/ammo was taken to the TRABAJADOR for collection, sorting and inventorying.

After all of the initial high value items were recovered, the teams swept through each compartment removing everything that could possibly escape and contaminate the reef if the ship broke apart. Garbage bags were inadequate for the weight of the debris, so bed sheets were used to collect and dispose of the items. Due to the sea state and low efficient method of transport (RHIB) to USS MUSTIN, the loose item removal process took approximately 10 days to accomplish.

5.3.2 Sensitive/High Value Item Recovery

The salvage teams recovered any reusable equipment and any potentially sensitive or classified material. Ordnance and ammunition were accounted for and removed immediately after the salvage assessment on 22 January 2013. All sensitive or high value items from within the hull and on deck were removed by RHIB to other vessels to be inventoried and returned to the fleet. All classified material that was not destroyed by the GUARDIAN crew, was removed and taken to the USS MUSTIN for inventory. This process took approximately five days to accomplish due to sea state and small boat transport inefficiencies.



Figure 5-6. Sensitive / High value item recovery. USNS SALVOR's workboat, crewed by MDSU One, alongside USS MUSTIN unloading high value material removed from USS GUARDIAN.

5.4. Fuel / Hydrocarbon Removal

Since the initial salvage survey, the SUPSALV and SMIT engineers, with SWRMC BDR, immediately worked to remove any potentially harmful materials including petroleum-based products and human wastewater. SUPSALV oversaw the removal of fuel, lubricating oils, and hazardous material that could be salvaged from the ship. No fuel had leaked since the grounding and all of the approximately 15,000 gallons aboard GUARDIAN were safely transferred off the ship.

VOS APOLLO arrived Puerto Princesa, Philippines from Singapore on 20 January and was the primary platform for removing the hazardous material. SMIT and OOC engineers embarked onboard VOS APOLLO and began the fuel offload from USS GUARDIAN via a portable pneumatic pump on 22 January 2013. After all fuel was removed, taking approximately two days, the team proceeded to skimming operations within the main engine spaces. This method was inefficient due to the spaces being tidal and unknown oily discharge locations. Once all systems were flushed, it became easier to remove the oily waste. This was an ongoing process for the first two weeks of the salvage operation.

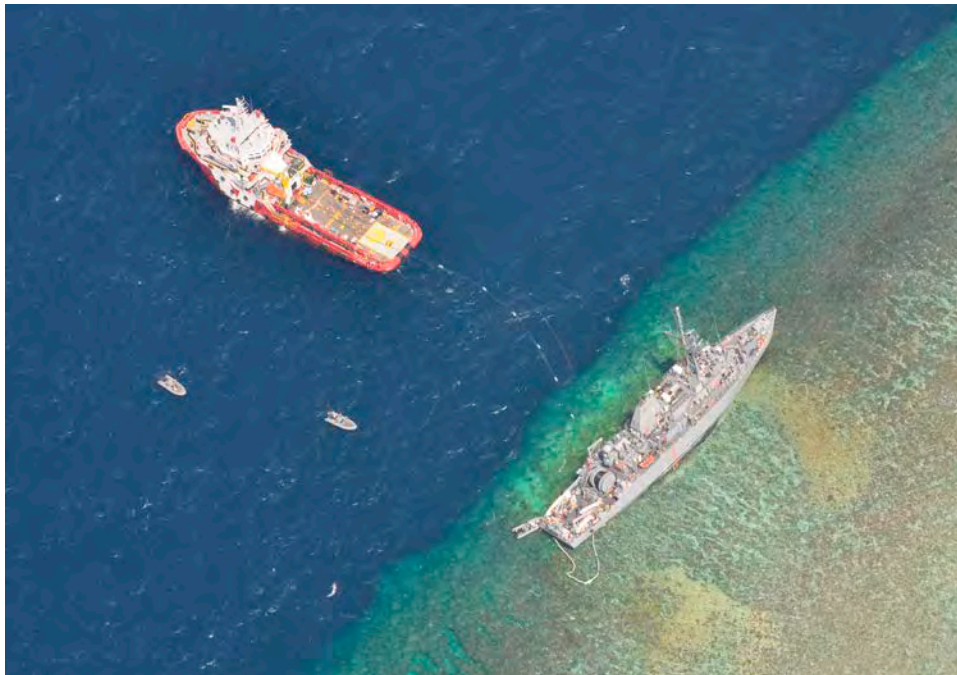

Figure 5-7. VOS APOLLO in DP mode positioned next to the reef taking fuel and oily waste from GUARDIAN. Note buoyed hose running between the ships.

5.5. Permitting

On 3 February, CAPT Gilbert, CTU OPGUA, met with Mrs. Songco, Tubтатаha Reef Board, and Ms. Chan, Philippine Dept. of Tourism, to discuss the GUARDIAN progress and plans. CAPT Gilbert was accompanied by Mr. Lee Shannon (NAVFAC Environmental) who had just completed an environmental assessment video survey of the reef. A copy of that video was provided as well as a draft of the Salvage Plan. Based on concerns expressed by Mrs. Songco, it was recognized that formally requesting and receiving a Philippine Salvage Permit would be advisable prior to beginning the weight removal and disassembly process.

NAVSEA approved Version 1.4 of SMIT's salvage plan on 3 February and SMIT formally submitted it to Philippine Coast Guard for permitting. While awaiting Philippine action, SUPSALV/SMIT continued with the salvage process. SMIT BORNEO had arrived at Puerto Princessa and was in port making preparations prior to transiting to the GUARDIAN operations site to begin setting her moor adjacent to the reef. RADM Isorena and CMDRE Evangelista had been briefed on BORNEO's mooring plan and it was understood that neither wanted the Navy/SMIT team to delay the salvage process while permitting was taking place.

On 4 February, Philippine Coast Guard announced plan for a stakeholder meeting with Tubbataha Reef Board on 5 February to discuss the salvage plan. CMDRE Evangelista, PCG Palawan District Commander, informed CAPT Gilbert that the salvage team should wait to begin mooring BORNEO until after approval of the permit had been issued. RADM Isorena's Stakeholder's meeting took place at 1400 on 5 February. In attendance were BGEN Amon, Commodore Pena, Mrs. Songco, salvage masters (SMIT and Malayan), CAPT Gilbert, LT Martin (CTU OPGUA PAO), Mr. Lee Shannon, and CAPT Haynes (USCG Environmental).

SMIT representatives led the discussion to present and brief details of the salvage plan. SMIT presented the salvage plan and explained how SMIT BORNEO will moor. Other topics discussed regarded impact on tourism, oil spill response and debris in the water. Meeting ended with no objections from those present. RADM Isorena recommended approval and others indicated that they would concur as well unless they had an alternative plan to propose. The Tubbataha Reef Board wanted to discuss the plan within their group and with additional members that were not present. It was announced that the Board would notify the Philippine Coast Guard (PCG) of their approval by 1200H 06 FEB. On 6 February, they issued a letter to RADM Isorena recommending approval of the salvage permit. The letter expressed some concerns that needed to be addressed and the emphasized the importance of avoiding further damage to the reefs. That letter is provided as Figure 5- 8.

5.6. Weight Removal

Once JASCON 25 was able to take position alongside GUARDIAN the salvage team began the task of lightening the ship. Some items were removed because they were identified as high value spares for the remaining MCM Class ships and other items were removed to simplify the eventual superstructure removal. All had the result of removing weight from the hull which would lighten the hull sections during the lifts. SEA 05, PMS 495 & 470 provided their lists of equipment. Many of these items were less weight intensive but were high demand items and removal items.

On 21 February, after setting DP transponders on GUARDIAN, (providing necessary redundancy to DGPS) JASCON 25 was cleared to operate safely in close proximity to the reef. The next day, the first items were transferred using JASCON 25's crane. They were salvage support items going onto GUARDIAN (generators, lights, pumps, exhaust fans, and cutting and safety equipment) and refrigerated stores being removed from GUARDIAN.

The addition of JASCON 25 changed the dynamic and pace of salvage operations. Better weather also contributed but the addition of JASCON 25 meant that salvors did not need to board GUARDIAN from small boats, a tricky and potentially dangerous task when the seas started building.

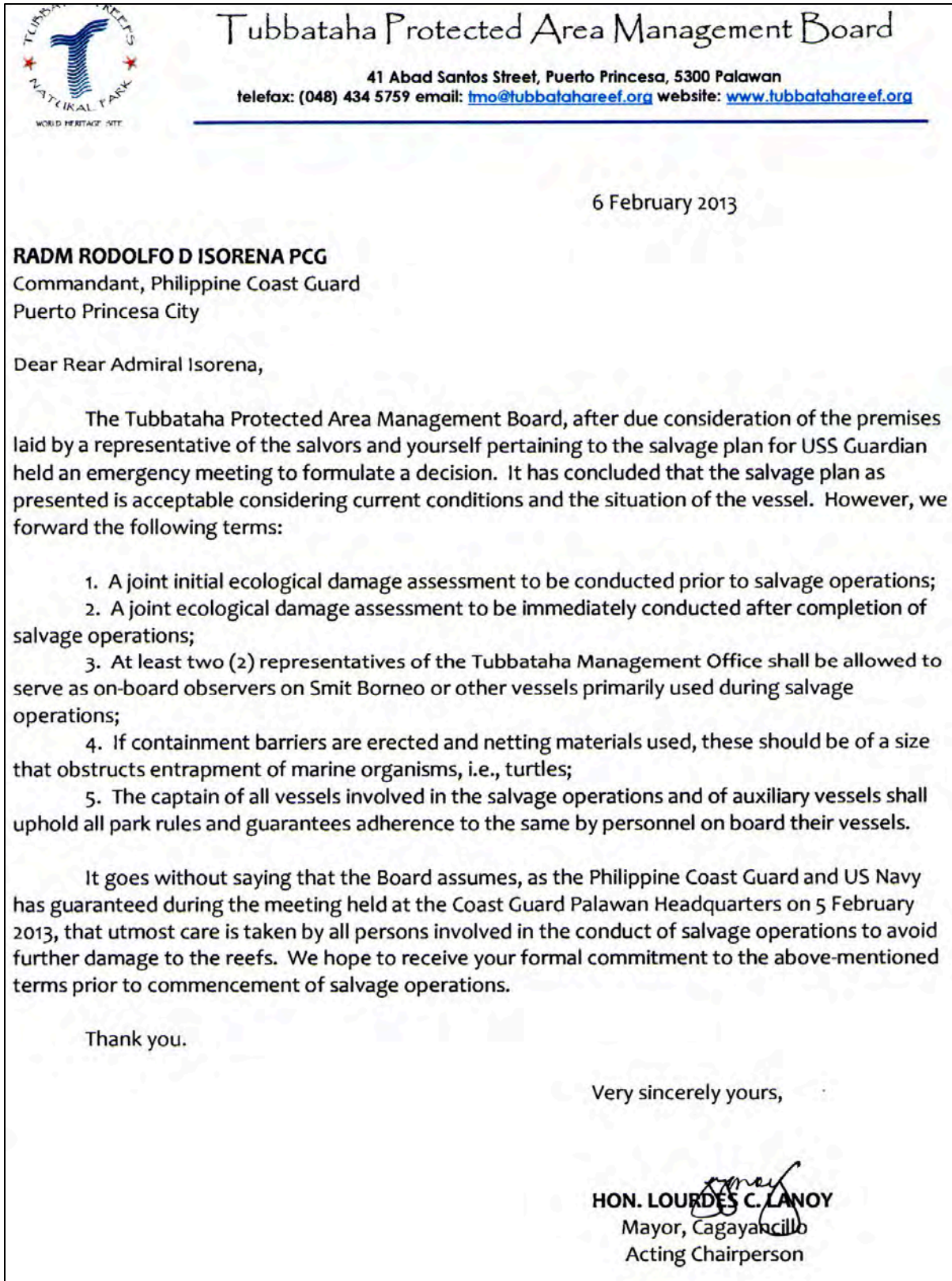

Figure 5-8. Tubbataha Protected Area Management Board letter to Philippine Coast Guard announcing concurrence with the SMIT Salvage Plan.

With JASCON 25, a Bully Pugh was used to transfer personal and salvors could be deposited on the upper decks of GUARDIAN without regard to moderate waves. Use of the Billy Pugh was also incorporated into the evacuation plan in case of injury on GUARDIAN. Figure 5-9 is an image of two SMIT salvors riding the Billy Pugh between ships.

Table 5-1. Weight Removal candidates and calculated weights.

Weight Removal Item	Weight (Itons)
LIGHT SHIP (no fluids, stores, ammo, etc)	1257.3
Aft Deck Equipment	-22.4
03 Level Equipment	-0.2
OK-520 Winch & towed body	-13.7
Weapons	-0.3
Anchor & chain	-7.3
Lifeboats	-1.2
Stack	-4.3
Mast	-2.0
Deckhouse	-36.4
CIC Eqpt	-4.8
	<hr/> 1164.8
Batteries	-1.0
Lead Ballast Forward	-13.1
Lead Ballast Machinery Spaces	-8.5
Engines	-9.8
MRGs	-19.2
SSDGs	-13.5
	<hr/> 1099.8



Figure 5-9. Smit salvors riding Bully Pugh from JASCON to GUARDIAN

In the days following, many topside items were removed including the significant items such as the magnetic cable reel assembly (23 Feb), the stack (26 Feb), and the mast (27 Feb). Figure 5-10 is an image of the stack or funnel being removed from GUARDIAN. Additional topside equipment that was removed during this phase included the dipping sonar, fantail winch, MNV davits and the small boat/slewing arm davit.

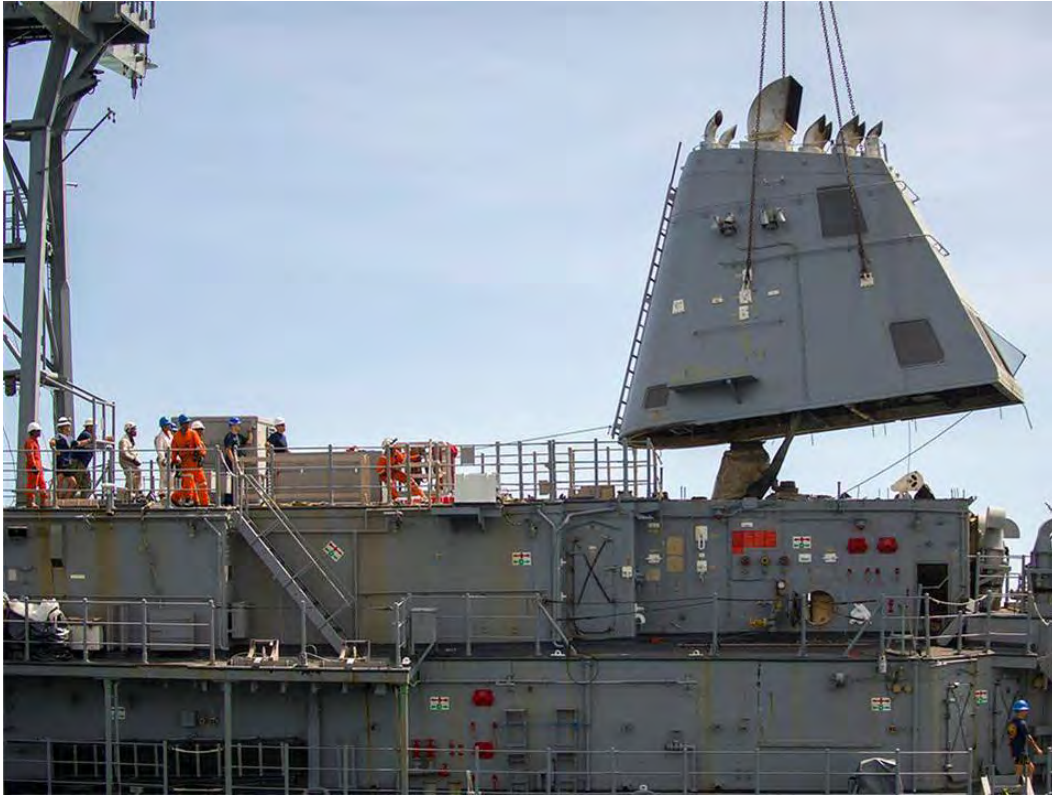

Figure 5-10. SMIT and MDSU ONE team members standing forward on 02 level while the stack is lifted off GUARDIAN.

5.7. Superstructure Removal

After the funnel, mast and major deck equipment were removed; the preparations to remove the 02 and 01 level superstructure began. The plan was to cut the bulkheads, and lift the overhead and bulkheads of the level intact as a single piece. The initial part of this process was identifying where bulkhead cuts were going to be made, what equipment was to be removed in the cutting preparation (or left in place), the cutting process, and the location required for slings to be passed for rigging.

Because of the 02 levels compartmentalization, all internal bulkheads that were not transversers were prepared for cuts first. This process involved clearing all obstructions from the deck up the bulkhead to a height of approximately two feet. This would enable the individual cutting the bulkheads to have ample working area and freedom to maneuver the cutting equipment. While the cut line preps for these bulkheads were nearing completion, preparations for the remainder of the transverse and exterior bulkheads began. Additionally, most heavy equipment pieces, and Fan Coil Units were left in place, to save prep time for the bulkheads. These items would later be removed by a focused team of personnel after the overhead and

bulkhead structure was removed. Once all cut lines were cleared, the next step was to clear any obstructions for the sling paths.

An initial survey by SUPSALV rep and the SMIT Naval Architect showed multiple Watertight Doors (WTD) that could be used as sling entry points, and supplemented with wooden dunnage to prevent heavy point loading. A total of four slings were to be run, in pairs, each pair crossing each other to form an “X” through the length of the 02 level. This preparation required several bulkheads to be opened 2-3 feet to allow for the 52mm wire slings to be passed through. The slings ran from frame 34 to frame 42 (forward “X”) and frame 50 to 59 (aft “X”). Figure 5-11 shows the sling paths for the 02 level.

With slings in place, the final requirement was making the bulkhead and support beam cuts. The order of the cuts was as follows: Interior non-transverse bulkheads, interior transverse bulkheads, exterior forward bulkhead, exterior aft bulkhead, exterior port bulkhead, and the final cuts were made along the exterior starboard bulkhead. All the exterior bulkheads consisted of major support beams (8”x”8 with a 1’ steel rod in the center), bulkhead framing (2”x4”) and the bulkhead surface (Marine grade plywood, 2” thick). Because of the multiple components of the design, the bulkhead framing and the bulkhead itself were cut first, with the 8x8 support beams left as final cuts for all sections. From planning to lift, the 02 level removal took 3 days. Figure 5-11 shows the 02 level plan with the sling paths annotated. Figure 5-12 shows the 02 level being transferred to ARCHON TIDE from JASCON 25 after it was removed from GUARDIAN.

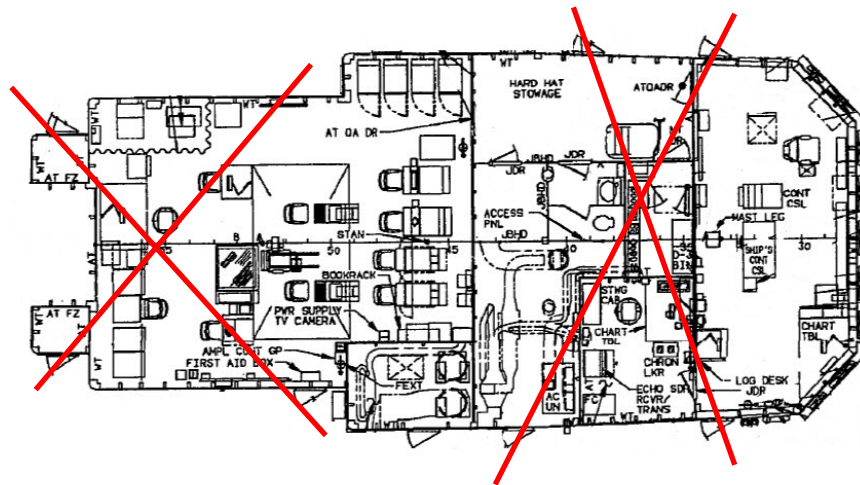

Figure 5-11. 02 level plan drawing with lift sling path in red overlay.



Figure 5-12. 02 level being transferred from JASCON 25 to Archon Tide for further transfer to barge S-7000. Note GUARDIAN in background with 01 level remaining.

The 01 level was prepared in the same manner as the 02 level. However, because the 01 level was almost twice the length of the 02 level deck house, it was decided that two major sections would be lifted: Forward 01 section (frames 28 to 56) and Aft 01 section (frames 72 to 86). The 01 level portion surrounding the stack (frame 57 to 68, port and starboard) were left in place to provide work areas for the eventual stack/exhaust duct clearing. The forward 01 level proved to be more of a challenge, namely passing of slings through Radio, required removal of several communications gear racks and the cutting and removing of thousands of feet of wire and conduit. The sling paths for the 01 level sections can be seen in Figure 5-13.

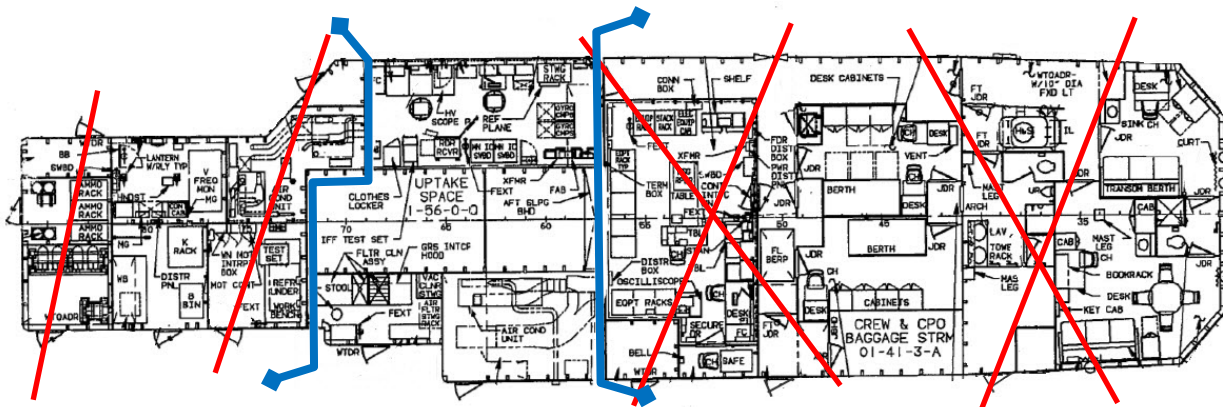

Figure 5-13. 01 level plan showing cut lines in blue and sling paths in red.

The process of cut preps and lifts of the 01 level took 6 days although two of those days weather conditions prevented transferring salvors to GUARDIAN due to high waves. Figure 5-14 is an image of the 01 level (forward section) being lifted off GUARDIAN on 8 March. The final lifted weights of the superstructure pieces were: 02 level - 24 mT, and 01 Level - 38 mT.



Figure 5-14. 01 level forward being lifted off GUARDIAN. Note waves breaking on hull. This lift followed a number of days where high waves prevented operations on GUARDIAN.

5.8. Structural Sectioning and Removal

Beginning in mid-February, the weather began to hold and the structural integrity of GUARDIAN was found to be better than originally estimated. It still had significant damage in AMR and MMR spaces, however, it was determined that an attempt to lift the hull in pieces, rather than use hydraulic grabbers, would be pursued. After a rather dynamic evolution of the Salvage Plan, the ultimate decision was to proceed with three cuts and the planned lifts of four hull sections.

After the final section of superstructure was removed on 11 March, the team concentrated on removing exhaust ducting from the stack opening, and heavy components within the hull. All heavy machinery removed from AMR and MMR was craned out through the stack opening, or the bolted access panel located on the mess-decks. The components removed included the main propulsion engines, diesel generators, port and starboard shaft sections, fire pumps, compressors and electrical distribution panels.

A second major task was to identify and clear cut lines and paths for the lift slings. In order to clear the cut lines, MDSU and SMIT/Koole crews removed deck plating, angle iron, ladder ways, electrical panels, HALON systems, sea chests, oily waste tanks and miscellaneous machinery foundations in the machinery spaces. In both AMR and MMR, the majority of the equipment sat beneath 1-6 feet of sea water, depending upon the tide. SMIT divers wore Kirby Morgan band masks and ran two dive teams using BROCO underwater cutting tools to remove any obstructions that were not easily unbolted. On the main deck, Sailors and Contractors worked feverishly to remove bulkhead mounted equipment; exhaust and ventilation ducts and piping systems in the paths identified and cut access holes in the hull, just beneath the gunnels.

Loss of oily waste was a concern for the hull lifts. The salvage team took steps to prevent a loss of oil but a fair bit of uncertainty still existed. To reduce the risk for oil loss, salvage forces continuously skimmed AMR and MMR spaces to remove as much oil residue as

practical. Additionally, they planned to utilize oil spill response craft with absorbent containment barriers and offshore oil boom to contain and absorb these sheens once they have passed over the shallow area of the reef. Deploying a containment or absorbent boom on the reef in the vicinity of Ex-USS GUARDIAN was not practical as the boom mooring system would mechanically damage the reef and cause any oil sheen to be held in place over the coral. The designated Oil Spill Response Vessel was M/V INTREPID. She was loaded with response equipment and was positioned to respond as appropriate when the final cuts made and lift conducted. While the Philippine observers were briefed on the worst case scenario, the actual release of oil during the section lifts was insignificant. The removal of oily waste from the bilge in the proceeding weeks proved effective.

On 20 March, SMIT issued the Lifting Plan for Hull Sections 1- 4. This plan (Appendix H) detailed the rigging and remaining preparations needed for cutting and lifting the 4 hull sections. Rigging was designed to ensure load was placed simultaneously on the first deck and main deck wire slings. Dunnage was to be used to distribute load appropriately to the gunnels and other strength members. Cuts were to be made as follows:

Table 5-2. GUARDIAN section cuts and lift details

Section	Frames	Dry weight	Lift Arrangement	Sling Paths
Bow Section	00 – 42	314 mT	71mm wire slings run longitudinally under 01 level deck gunnel 71mm wire slings run longitudinally under main deck gunnel	Fwd sling between frames 12 & 13 Aft sling between frames 34 & 35
AMR	42 – 62	181 mT	71mm slings run in "X" under 01 deck 71mm slings run longitudinally under main deck gunnel	Fwd sling between frames 46 & 47 Aft sling between frames 58 & 59
MMR	62 – 85	224 mT	71mm slings run in "X" under 01 deck 71mm slings run longitudinally under main deck gunnel	Fwd sling between frames 65 & 66 Aft sling between frames 81 & 82
Stern Section	85 – onward	314 mT	4 x 71mm wire slings run under the belly of the stern	4 slings at frames: 89 95 102 110

The plan was to crisscross two continuous 71mm wire slings for the AMR and MMR lifts. A single sling was run both athwartships and diagonally. This ensured the sling load was equalized across two decks levels and three corners of the hull section. Figure 5-15 shows a cutaway illustration of the AMR lifting arrangements.

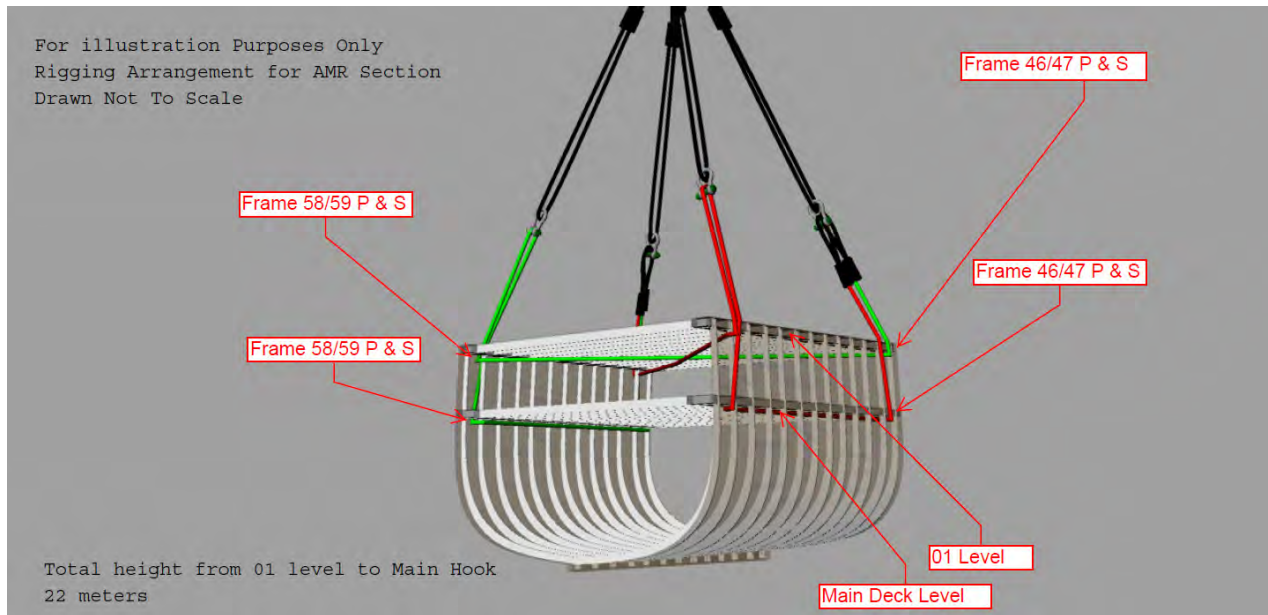

Figure 5-15 – Auxiliary Machinery Room lifting arrangement

After access holes were cut and paths were cleared for running the wire rope slings, other non-structural cuts were made. These included cuts in the deck, hull bottom, and hull sides. The first lift took place on March 26. SMIT and Koole workers completed final deck cuts and JASCON 25 tensioned the lift rig. Figure 5-16 shows the bow section at the tension point, prior to the beginning the lift.

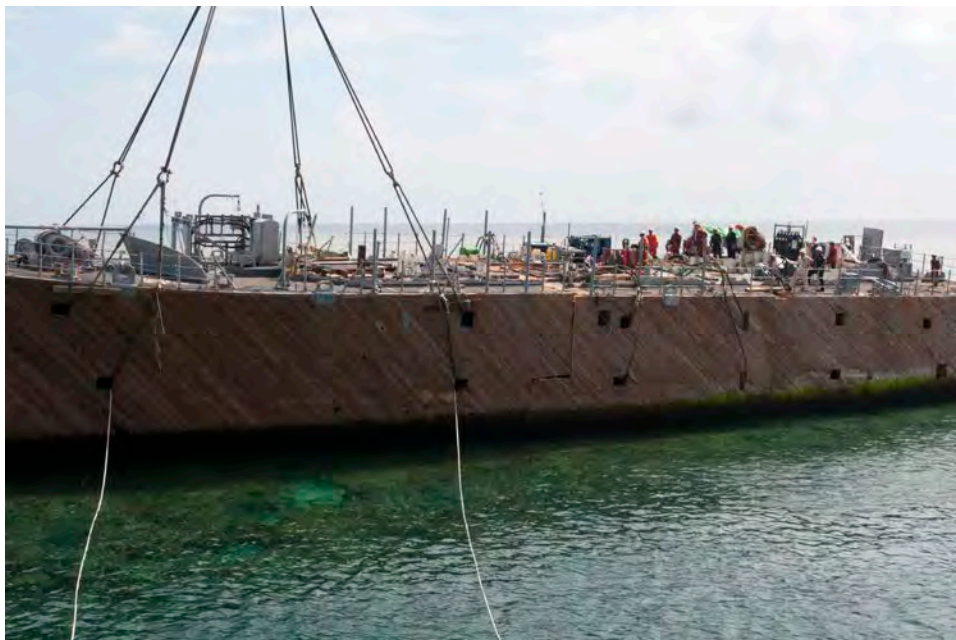

Figure 5-16. Bow section being tensioned prior to lift on 26 March 2013. Note access holes cut in the remaining hull sections and slings which had already been run for the AMR lift.

Upon tensioning, the bow section shifted slightly then inched up and began draining seawater from its bilge. The bow lift, as it was configured, was at the maximum capacity for JASCON 25. It required the furthest reach because the reef protruded further out at the forward end of GUARDIAN. This reef extension is clearly seen in Figure 5-5, which shows the arrangement of JASCON 25 as it approached GUARDIAN. After the lift was clear of the water, JASCON 25 moved away from the reef and proceeded, using its dynamic positioning system, to the S-7000 barge which was moored alongside of SMIT Borneo. Tag lines were transferred to S-7000 and the bow was lowered onto dunnage prepared on the deck of S-7000. The lift came off without a hitch and was followed up by lifts of the AMR, MMR and stern sections on March 27, 28 and 30.

For the stern section, the salvage team was successful running messenger lines under the hull and pulling 4 lift slings under the hull planking. The slings were tied to deck fixtures on at the gunnel to prevent them from slipping forward or aft. Figure 5-17 shows the stern section after it had been raised and the 4 slings passing under the hull.



Figure 5-17. Stern section lift, conducted on 30 March, cleared the reef for a final cleanup.

5.9. Reef Cleanup

The reef cleanup was the final stage of the GUARDIAN salvage operation. The Salvage Plan had allocated 7 days to complete the cleaning stage. Reef inspections would be conducted during the final cleanup and the Philippine Park service would be certifying the completion. The stern section of the hull was raised from the reef at approximately 1350 on 30 March. The stern was landed on S-7000 at 1530. By 0730 the following morning, JASCON had delivered a debris basket onto the footprint of the GUARDIAN and US Navy divers were swimming the reef looking for debris left over from the operation. The divers were delivered to the reef by RHIB and swam using SCUBA rig in water between waist deep to 15 feet deep. The divers were focusing on find any manmade objects including: dropped tools, sections of hull sheathing (GRP or glass reinforced plastic) wood debris and hardware. The salvage basket was collected at 1620 via the JASCON crane. On 1 April, the process was repeated except, in addition, the Philippine Coast Guard and Tubbataha Reef Management officials conducted an inspection of the site. JASCON

25 delivered the debris basket to the reef one final day, April 2. The Navy divers completed their final sweep of the reef and were out of the water by 1450 having finished the reef cleanup phase 4 days early.

The success of this cleanup was due to a number of factors including:

- The Navy team conducted a nearly continuous cleaning of the reef over the course of the entire operation
- The salvage process was tailored to reduce reef damage and the spread of debris
- The monsoon season finally ended and improved weather arrested the deterioration of the ship

Figure 5-18 is an overhead view of the GUARDIAN footprint with divers conducting a cleanup swim. Note the RHIB is standing off in deeper water and the damaged coral in the shape of the hull is clearly visible.

JASCON 25 remained on site through 4 April to support aerial photography of the reef. Tubbataha Reef Management and USN MEA representative remained to develop the Reef Assessment Plan. MDSU One and USNS SAFEGUARD remained on site to support the assessment process.

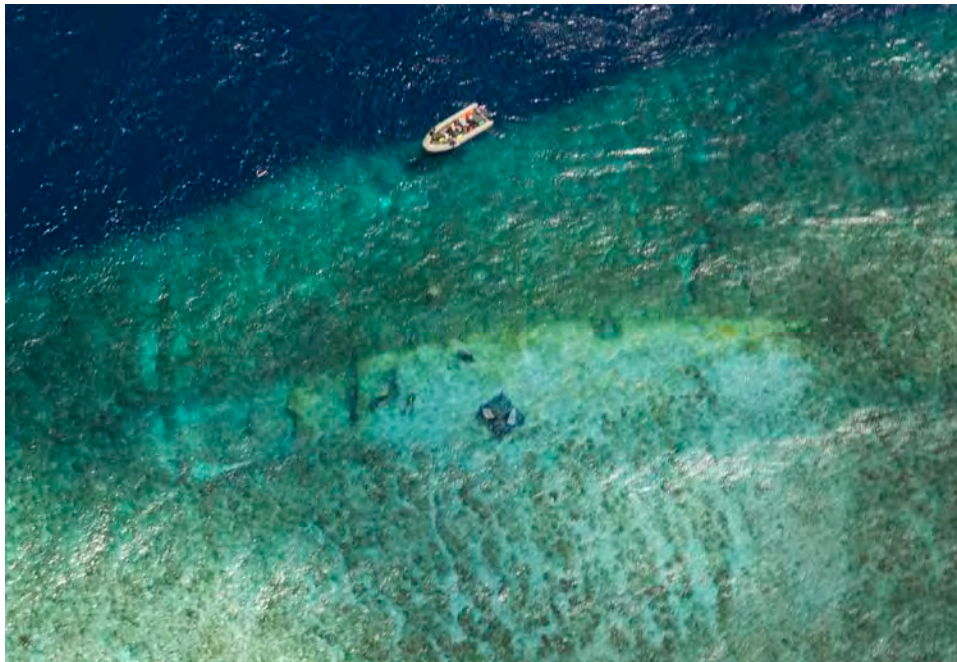
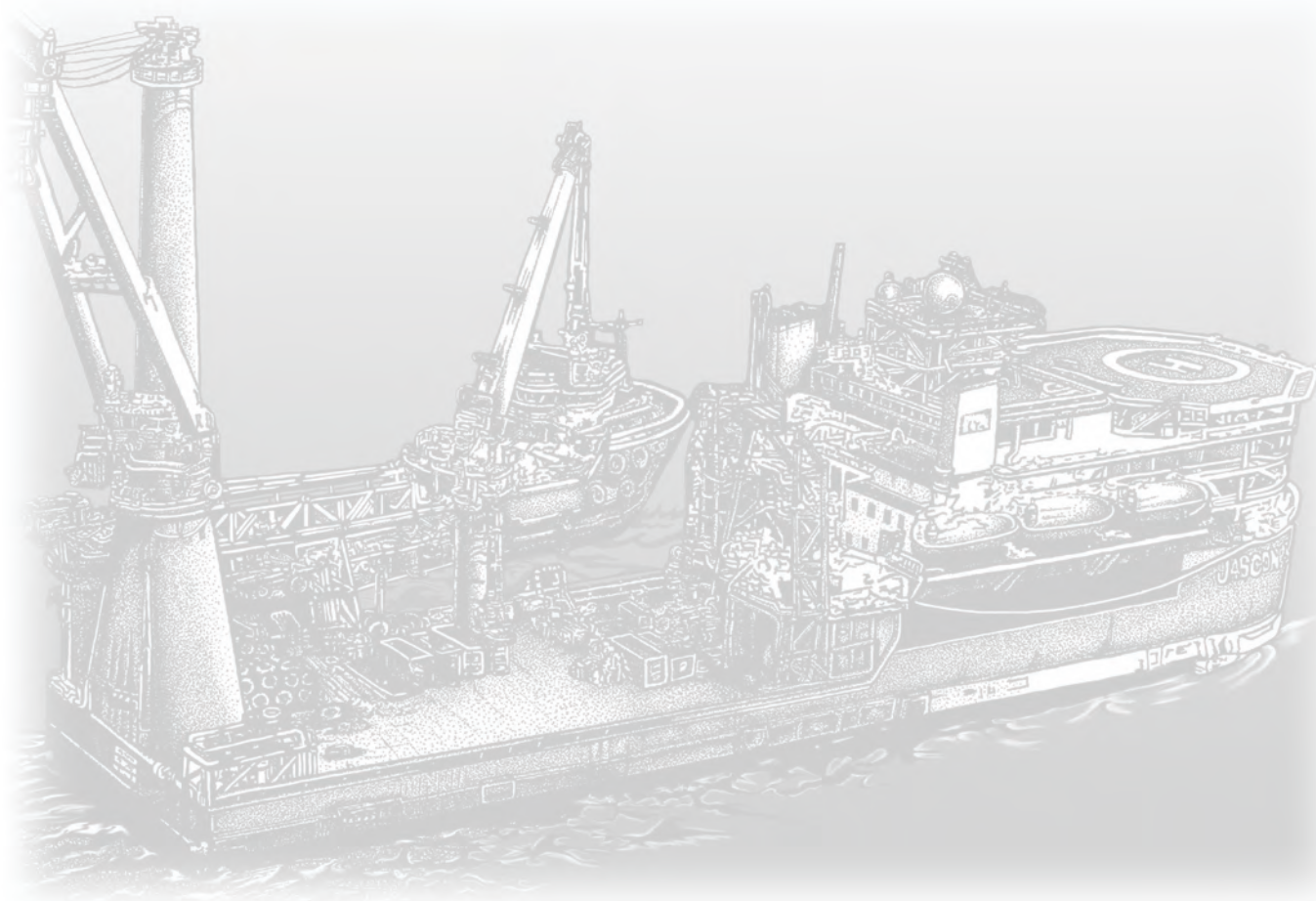

Figure 5-18. MDSU ONE divers swimming the wrecksite on 1 April. Note salvage basket positioned on reef for collection of debris.

This page intentionally left blank.

SECTION 6

CONCLUSION



This page intentionally left blank.

Section - 6. Conclusion

6.1. Demobilization

6.1.1. S-7000 / Guardian off-load Sasebo, Japan

Secretary of the Navy signed a Strike and Disposal memorandum prepared by CNO on 12 February. In summary, the memo stated that the vessel had sustained significant damage, and the ability to repair her was not considered cost effective. The CNO further noted that to minimize further environmental impact on the Tubbataha Reef, NAVSEA recommended dismantling the vessel into sections which could be placed on barges and delivered to a location under Navy control for salvage of all equipment and material that can be cost effectively removed.

On 02 March, ADM Haney approved a plan to transport GUARDIAN to Sasebo, Japan for disposition citing significant cost saving and shorter duration at sea over transport GUARDIAN to San Diego. The shorter duration at sea increased the likelihood that material from GUARDIAN could be salvaged. With this decision made, SUPSALV was able to plan the transport to Sasebo.

After the completion of the final lift, the Ex-USS GUARDIAN carcass, onboard S-7000 barge, was towed to Sasebo, Japan for further dismantling by SRF Sasebo contractors. The operation was divided into three phases; Phase I - Offload VOS HERCULES, move equipment to Bldg 6000 lay down Area. Phase II - Remove Ex-USS GUARDIAN hull sections and CONEX boxes from barge – Completed 4/26/2013. Phase III - Dismantle, salvage and dispose of hull sections, final disposition and shipping of re-usable items

Phase I summary: VOS HERCULES DELIVERY of conex boxes and deck gear

On 17 and 18 March, Six CONEX boxes, the magnetic cable reel, the exhaust funnel or stack and other mine hunting equipment was loaded onto VOS HERCULES and after clearing customs, departed for Sasebo, JA. After arriving on 28 March, all six containers and remaining gear were removed and cleared. All contents were processed in bldg 6000. Material issue requests in support of MCM1, MCM7, and MCM10 have been received and authorized by CNSP. Figure 6-1 shows the VOS HERCULES load out of the CONEX boxes and equipment.



Figure 6-1. VOS Hercules receiving CONEX boxes from SMIT Borneo. Note cable reel and stack already loaded.

Phase II summary: S7000 Barge with Ship Carcass

On 30MAR2013, the last section of the Ex-USS GUARDIAN was removed from Tubbataha Reef, about 70 NM SE of Palawan, Philippines. The S-7000 barge was on scene to transport the sections and various debris from the salvage site to final disposal in Sasebo, Japan. The S-7000 barge is 270 ft. (90M) long, 72 ft. (24M) beam, and 5 ft. (1.6M) draft. The barge also has 15 ft. vertical bulkheads enclosing the material removed from the salvage site. There were 8 major sections that were loaded onto the S7000 barge:

GUARDIAN Component	Weight
Bow section	314 mT
AMR	181 mT
MMR	224 mT
Stern	314 mT
01 Level	<42 mT
02 level (A)	<30 mT
02 level (B)	<30 mT
Mast	< 8 mT

Note: The 02 Level was originally removed as one section, but was cut to make room on the barge for larger sections. 18 CONEX boxes, various debris and 2 OE-82 Antenna that were also on-loaded to the S-7000 barge.

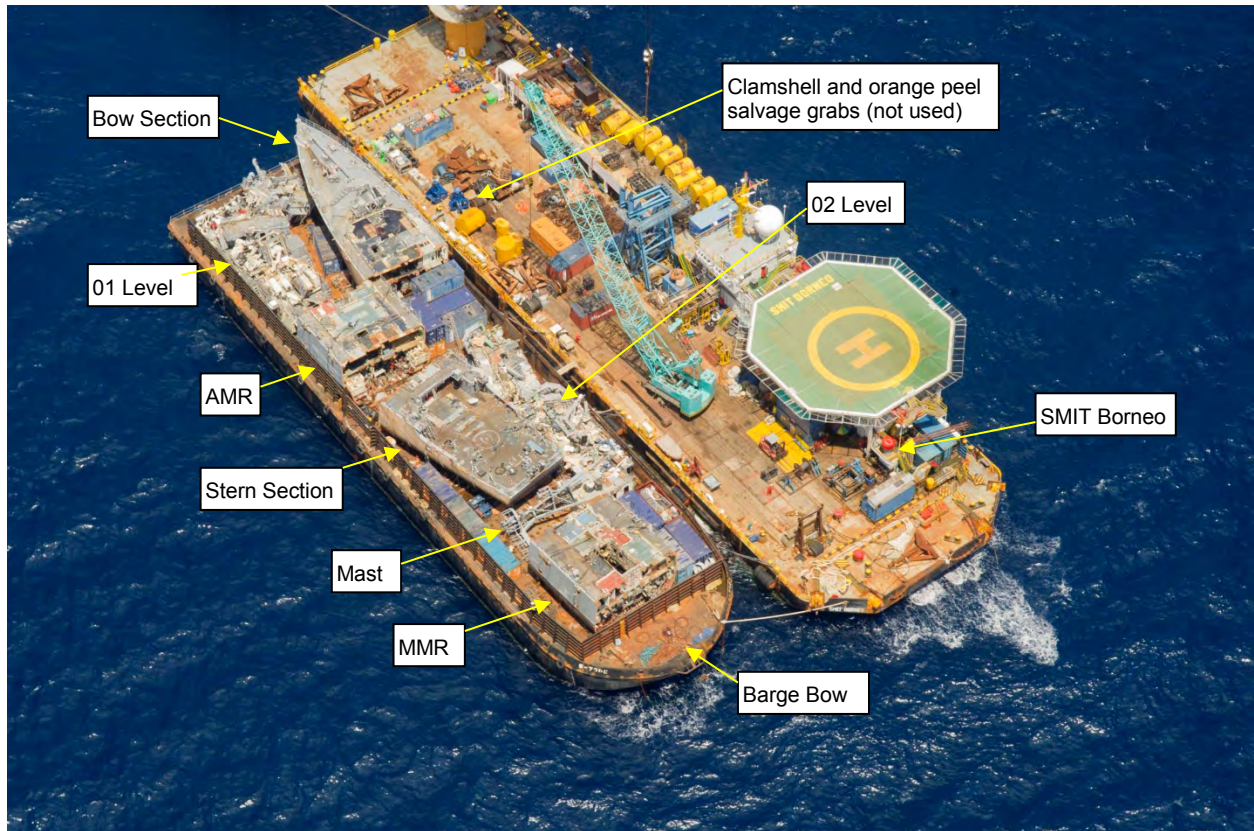

Figure 6-2. An aerial view of S-7000 barge alongside SMIT Borneo.

After all sections were on-loaded to the S-7000 barge, the Salvage Master inspected the pieces for stability and safety. I-beams were welded to the deck of the S-7000 barge to provide a cradle for the larger sections and to prevent movement during the transit.



Figure 6-3. Bow section cradle



Figure 6-4. AMR Sea Fastening

After satisfactory inspection, TRABAJADOR 1 came into position to connect the tow to the S-7000 barge. Ship's crew connected the bridle chain from the S-7000 barge to TRABAJADOR 1 and readied the ship for transit to Subic Bay, Philippines.

TRABAJADOR 1 began towing the S-7000 barge from the Tubbataha Reef OPAREA on 02 April 2013 at approximately 1500. Towing speed was approx 8 kts. The ship and tow traveled to Puerto Princesa, Palawan, Philippines and dropped off the

vessel Master and began transiting to Subic Bay. After a 2.5 day transit, the ship and tow arrived at approx 1500 on 05 April 2013 in Subic Bay, Philippines. TRAJABADOR 1 disconnected the tow and both were moored near Bravo Wharf.

On 06 - 07 April, additional sea fastening was performed on the sections. LT David Armandt was on scene and inspected the additional sea fastening. At 2100 on 07 April, S-7000 barge cast off, at 2200 TRAJABADOR 1 cast off. At 2330, outside Subic Roads, TRAJABADOR 1 hooked the bridle chain, paid out 1000 ft of tow length and began transiting to Sasebo, Japan with a transit speed of 8 kts arriving on 15 April. The GUARDIAN carcass sections and loose debris were safely offload along with the remaining CONEX boxes on 25 April. S-7000 barge was released from Sakibe for return on 4/26. Sakibe area had been approved as the lay down area for dismantle and disposal efforts. Figure 6-5 shows the derrick barge conducting the offload in Sasebo, Japan on 25 April.



Figure 6-5. GUARDIAN sections being offloaded in Sasebo, Japan.

Phase III summary: Dismantle and salvage

Statement of Work for the dismantling, salvage and staging waste for disposal is at FLC for legal review. Revised IGE estimated cost for Phase III is ~\$1.8M. Hull sections are staged at Sakibe. Estimate for Phase III was approximately 9 months which includes up to 60 days for legal review, contract solicitation and award.

6.2. Accomplishments

USS GUARDIAN's grounding on the South Atoll of the Tubbataha Reefs Natural Park presented an unusual and challenging task for the Navy. Once the hull had

breached and was holed to the point where refloating was not a possibility, SUPSALV had to determine a way to extract the ship without further damaging the reef or releasing petroleum products or other harmful material into the environment. The Philippine Government representatives were closely monitoring the operation and US Navy salvage plan had to be coordinated and approved by the Philippine officials.

A challenge the team worked through was the requirement of the final plan which involved placement of a heavy lift ship directly adjacent to the reef and relying on the vessel's DP-3 positioning system to maintain station without the aid of anchors. Attempting this with a conventional barge/lift platform without DP-3 proved to be impossible due to the sharp drop off of the sea floor and our desire not to damage the reef with the placement of anchors.

A second challenge worked through was the lift rigging arrangements that supported the lift and carrying of diminished strength hull sections. The Avenger Class minesweeper is a wooden hulled vessel. Traditional lifting techniques would involve steel strength members and welded padeyes. The wooden framing and hull of GUARDIAN had been battered, breached and warped and sat on the reef for more than 2 months of monsoon season. She was showing signs of deterioration. The lift and rigging plan devised took advantage of the remaining framing and hull strength and set the section cuts in locations that the wire rope would not rip through the wooden ship when fully loaded.

This operation demonstrated the flexibility and capability of the Navy Salvage Triad - Two companies of Navy divers and Command Element from Mobile Diving and Salvage Unit One and the SWRMC BDR; SUPSALV operational management, salvage engineering and contracted salvage assets and team (including a Salvage Master) from SMIT Singapore; and USNS SALVOR and USNS SAFEGUARD from Military Sealift Command. Additionally, SUPSALV's (SEA00C) assignment as CTU OPGUA OSC was a milestone for SUPSALV in an operational leadership role.

Lastly, this operation was conducted in a very remote part of the world. It was at the end of a long supply chain and many supporting assets needed to be identified and shipped from distant locations. The forethought and insight of the salvage team, uniformed, Navy civilian and contracted proved to be up for the task.

SECTION 7

LESSONS LEARNED

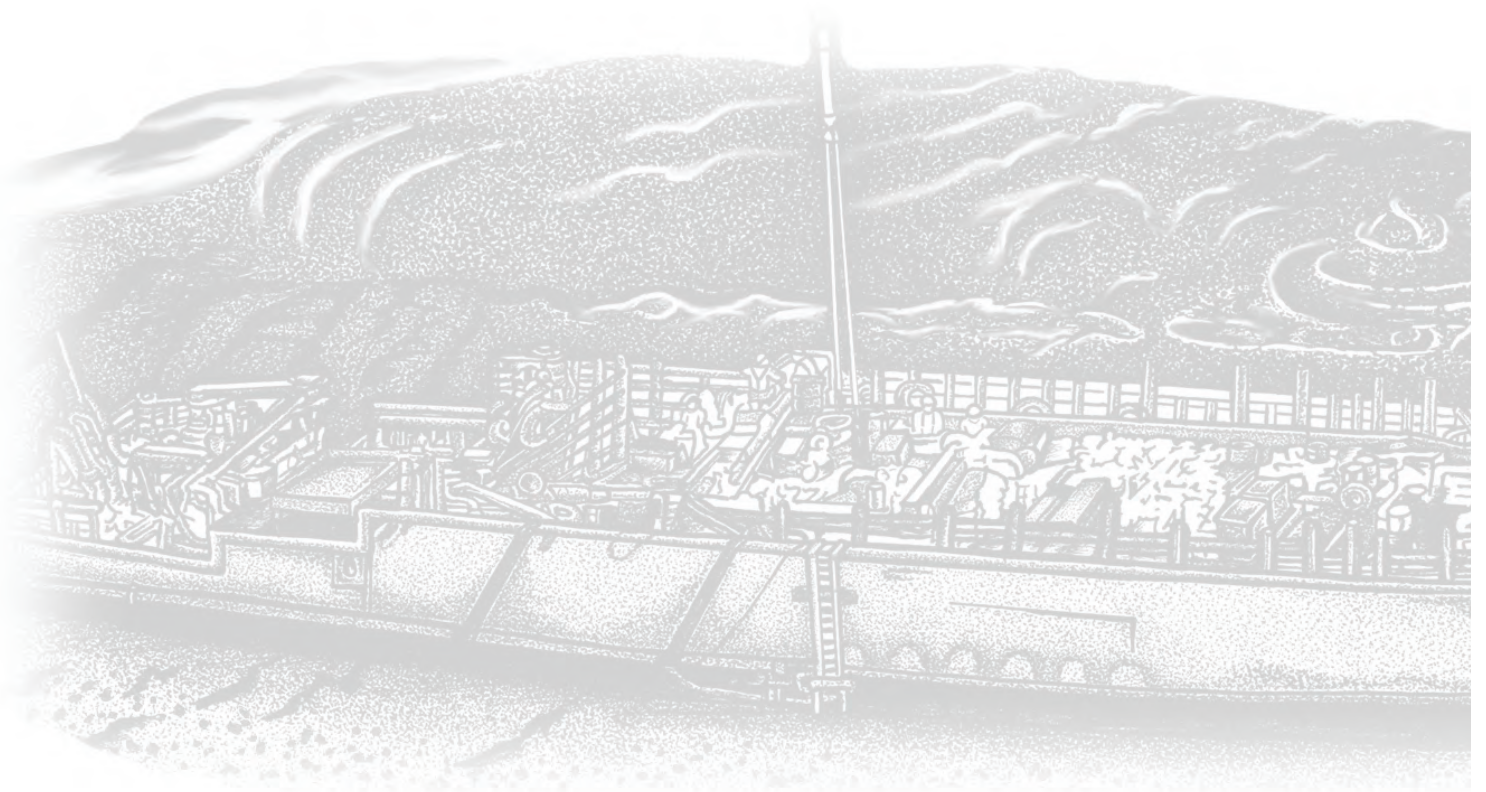

This page intentionally left blank.

Section - 7. Lessons Learned

SUPSALV hosted a GUARDIAN Lessons Learned meeting on 15 May 2013 to discuss issues and concerns identified during and after the response effort. Participants included: SUPSALV, SEA 05, CPF (N43), EODGRU ONE, and MDSU ONE. Issues were categorized into Navy Issues and Recommendations and Observations. Written inputs from MDSU ONE and SWRMC BDR are provided in Appendix F The combined Issues, observations, discussions and recommendations follow.

7.1. Navy Issues and Recommendations

1. **ISSUE: Connectivity inadequate.**

- a) Salvage platforms bandwidth capability limited.
- b) MSC has a low tolerance for web access.

DISCUSSION: Deployed personnel had to utilize commercial email addresses or addresses created by host ships (SALVOR, MUSTIN, etc.). When commercial communications were available, BuRAS greatly impacted data rate forcing users to rely on less-capable webmail. Also, the ability to utilize mobile VOIP would have improved voice communications at lower costs. MSC needs to understand throughput limitations; many files were too big for transmittal.

RECOMMENDATIONS:

- a) HQ needs to understand limitations. File size too large.
- b) MSC ships need increased bandwidth, hardware.
- c) procure a number of additional non-nmci computers and enable w/ cac reading/certs/VOIP, etc.

ACTIONS:

- a) 00C Discuss with MSC to ID hardware limitations and bandwidth options. COMPLETE
- b) S-ESC agenda item to investigate feasibility as a surge capability. 4-5 SEP '13

2. **ISSUE: T-ARs not manned for sustained OPS – Rhib ops, extended meal hours, extended close-in NAV.**

DISCUSSION:

- a) Manpower requirements - Sal/Saf reluctant to operate in close proximity to reef. Drain on cooks/staff.
- b) MDSU had to operate RHIBS as well as conduct salvage tasks - MDSU working 12 hour shifts then making logistics runs.
- c) Would have had to set-up add'l. nav details - Watch team couldn't support this op for a long duration.
- d) Adding crew will require additional costs

RECOMMENDATIONS: Develop a requirement for a surge capability during major salvage operations.

ACTIONS:

- a) 00C address with MSC for surge capability of personnel. COMPLETE
- b) S-ESC agenda item to investigate feasibility for surge capability. 4-5 SEP '13
- c) MDSU 1 to provide input to NECC/MSC MOU. COMPLETE – DRAFT in REVIEW
- d) PACFLT to ID requirement for a surge cap.

3. ISSUE: Initial prioritization of effort during offload (personal effects, AA&E, classified material, etc) was unclear/changing. Probably a communications ISSUE?

DISCUSSION:

- a) Personal item recovery. Redirected in middle.
- b) Remaining Gua crew members on hand were very helpful. The ship's crew DCA/MPA/CO helped guide actions WRT high value items.
- c) A list of additional classified material was located and sent to scene when we were already halfway through the entire op.

RECOMMENDATIONS: MCMRON rep would have been helpful to ID AA&E and classified material.

ACTIONS: CPF – work 4740 change to include ISIC participation for comsec/other concerns.

4. ISSUE: OPERATION GUARDIAN Command and Control (C2) was created ad hoc and was not as efficient or effective as a standing C7F expeditionary C2 element.

DISCUSSION: OPERATION GUARDIAN C2 was established and disestablished for this operation. The process of standing up a new C2 and operating together for the first time creates inefficiencies that are normally avoided by having standing C2 with established relationships, proper resources, and operational experience.

RECOMMENDATIONS:

- a) Establish a standing, deployable expeditionary battle staff under a C7F Task Force capable. Future operations would be conducted under this staff and augmented with the proper subject matter experts.
- b) Make sure all fleet salvage officers are incorporated into C2 system.

ACTIONS:

- a) 00C add as S-ESC discussion item for NECC. 4-5 SEP '13

5. ISSUE: Memorandum of Agreement between Navy Expeditionary Combat Command (NECC) and Military Sealift Command (MSC) is outdated.

BACKGROUND: During OPERATION GUARDIAN, issues arose around MSC's responsibility to have adequate manning and supplies to conduct small boat operations and provide meals for embarked personnel; in addition MSC ship schedules trumped operational needs - requiring USN sailors to depart via foreign vessel of opportunity from operational area.

RECOMMENDATION:

- a) Needs to be updated and enforced aboard MSC vessels.
- b) Address these ISSUES by ISIC and TYCOM.

- c) Continue to highlight these ISSUES with commands that have a vested interest in MDSU-1 capabilities.

ACTION: Addressed in Issue 2 above – Draft MOU being reviewed.

6. ISSUE: MDSU commands are not manned with equal capability; an Engineering Duty Officer(EDO) enhances salvage capability and is provided to MDSU-2 in Little Creek, VA but unavailable to MDSU-1.

DISCUSSION: During OPERATION GUARDIAN, MDSU-1 required outside EDO assistance to safely plan and execute disassembly of EX-USS GUARDIAN. An additional EDO assigned to MDSU ONE would have assisted in the planning, coordination, and execution of this operation. Such a resource could be permanently assigned to MDSU or have a habitual training relationship with MDSU ONE. Defunding any current officer AMD authorizations is not an option as all are required for MDSU ONE to meet operational requirements.

RECOMMENDATION: Either fund an EDO billet or develop an MOA with EDO community to assign an EDO in the Pearl Harbor region that would train and be available to deploy on salvage and diving operations when tasked by chain of command. Less palatable options include (1) getting an ED diver from CPF or shipyard for training and (2) training from SUPSALV's Assistants for Salvage.

ACTION: 00C include/re-open S-ESC item. NECC billet, or ED diver at SY or PACFLT to train together. w/in Core Competency ST-02 (new)

7. ISSUE: Delay in receiving flushing procedures from 05

DISCUSSION: Bandwidth contributing factor

RECOMMENDATIONS:

- a) Push upfront regardless of scenario. Develop the ship flushing procedure early-on. This should have been something that was started before we needed to flush.
- b) 00C f/u w/ 05

RESOLVED

8. ISSUE: BDR role undefined

DISCUSSION:

- a) There was a conflict b/t MDSU salvage mission and BDR.
- b) Load-out questions were not answered before departure.
- c) BDR role and equipment requirements must be more precisely defined
- d) How do you separate the mission between the two organizations?
- e) C2 – where do they plug in?

RECOMMENDATION: Determine integration/interface/overlap between BDR Team and MDSU.

ACTION: CPF to work N43 item to define role. Completed.

Role is addressed in USFF/PACFLT INST 4740.1 pg7 and RMC ltr 4740 SER C1100/113 dtd 27 SEP '12.

7.2. Observations

1. OBSERVATION: Salvage TRIAD effective. Combined contractor and USN salvage ship and MDS team was very effective.

DISCUSSION:

- a) Improved timeline, flag presence.
- b) Having a military presence helps reduce costs and assists in keeping to timelines.

2. OBSERVATION: Having 00C as afloat OSC was effective to operationally coordinate combined contractor and Uniformed Navy salvage team.

DISCUSSION:

- a) Different ops may have different roll requirements.
- b) Unrestricted line officer was assigned as OSC Ashore.
- c) Communications issues separate issue.
- d) MCMRON should have coordinated classified material Off-load.

3. OBSERVATION: Data call schedules were not aligned with local work schedules.

DISCUSSION:

- a) Report generated in middle of afternoon. Unable to provide end of day status.
- b) We had to guess how we would progress by the end of the day.
- c) We walked the line on how long we could wait to provide upstream data.

4. OBSERVATION: Shore Det in PP was critical for support in this/similar foreign environment.

DISCUSSION:

- a) Provided daily interface with local administrations relieving OSC with that responsibility.
- b) Shore det. conducted daily interface with local admin, relieving on-scene workers of that responsibility.
- c) This allowed us to focus our efforts on salvage.

RECOMMENDATIONS: Include in all future major salvage efforts, have local regional commander representation handle civ/pol/mil interface.

5. OBSERVATION: PUMA/COMMHELO for air logistics was very effective.

DISCUSSION:

- a) Being that far offshore, helo transport essential.
- b) Hoist capability missed.
- c) Large salvage efforts must include helo support for logistic and medical emergency response.

RECOMMENDATIONS:

Include helo support as requirement for logistics / medical emergency.

6. OBSERVATION: Salvage assets directed to sail immediately resulted in inadequate load-out.

DISCUSSION:

- a) The rush to 'get assets moving' prior to proper survey/assessment and salvage plan created problems:
 - i. Cost – almost sailed SMIT Cyclone – no use in that scenario
 - ii. Borneo loaded with 'best guess' kit – some overload and some under
- b) Lift assets premature
- c) Shows value of having salvage officer on staff.

7. OBSERVATION: DP was essential for fuel offload and removal operations in protected environments.

8. OBSERVATION: Concrete good for slick surfaces.

DISCUSSION: We need to look at sand/concrete for hazard mitigation.

9. OBSERVATION: Dependency on "local suppliers" resulted in number of issues – bad gas, improper slings, shackles, etc.

DISCUSSION: Fact of life...Contract item

RECOMMENDATIONS: Award fee feedback

This page intentionally left blank.

APPENDIX A

ENGINEERING ANALYSIS



This page intentionally left blank.

Appendix A. Engineering Analysis

Hull Cuts

SEA 05 worked with SUPSALV to develop recommendations on cutting the hull to achieve successful lifts. Concerns included weights of the sections and interferences associated with the cutting points. In this 29 January document (following) SEA 05P reviewed the two cutting plans SMIT was considering, applying the most accurate weight estimates to each option giving SUPSALV as accurate a picture as possible to make their decision on.

The actual cuts that were made most closely matched SMIT Option B where the bow cut was made at frame 42 and included the pump room. SMIT Option B indicated the entire topsides 01 level, 02 level, mast and stack as a single unit (cut A). In actuality, these sections were taken individually. SMIT's Lifting Plan (Appendix H) dated 20 March 2013 provides the most detailed summary of the cuts and lift plan.

MCM-5 Salvage Support; SEA 05P Input dated 29 January, 2013, 1300 hrs

The following lift weights are provided for your information and use. This updates previous estimates.

NAVSEA CUTS

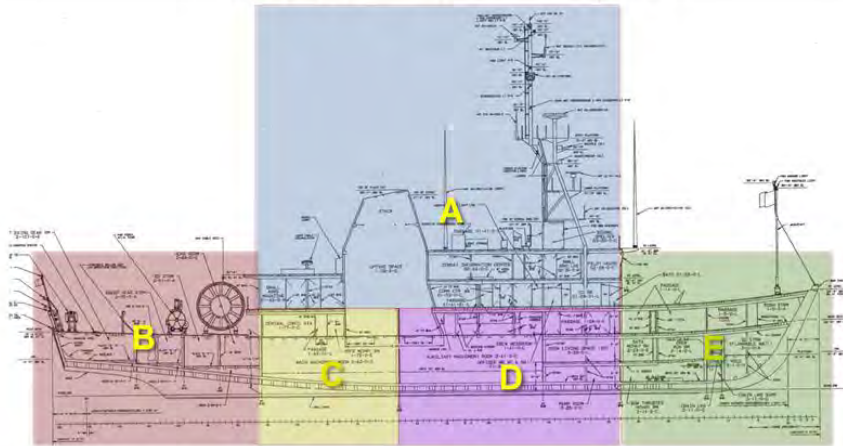

NOTE*****
 This is a lightship model. There will be load items on board ship. The majority of the loads will be liquid weight
 These are only approximations built off the MCM 10 Dated 1992weight model. These may not reflect the MCM 5 configuration in its entirety
 These Calculations do not account for water weight

	Ltons	Tons	Tonnes	VCG	LCG	TCG	T-sign
A	215	241	219	32.61	96.03	-0.36	S
B	266	297	270	14.06	178.58	0.03	P
C	282	316	287	13.53	154.58	0.01	P
D	288	322	293	14.13	108.49	0.00	S
E	150	168	152	18.64	47.72	-0.21	S

SMIT Option A CUTS

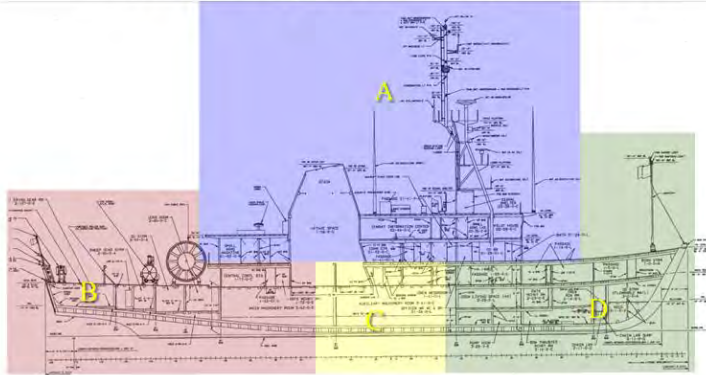

NOTE*****

This is a lightship model. There will be load items on board ship. The majority of the loads will be liquid weight
 These are only approximations built off the MCM 10 Dated 1992weight model. These may not reflect the MCM 5 configuration in its entirety
 These Calculations do not account for water weight

	Ltons	Tons	Tonnes	VCG	LCG	TCG
A	215	241	219	32.61	96.03	-0.36 S
B	511	573	520	12.45	154.19	0.02 P
C	229	256	233	10.87	96.34	-0.08 S
D	235	264	239	13.21	42.02	0.05 P

SMIT Option B CUTS

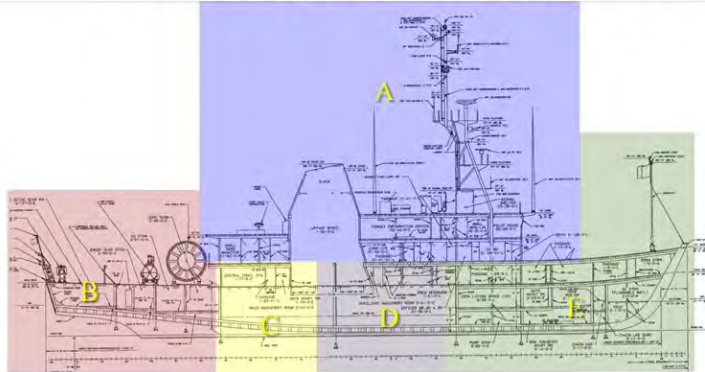

NOTE*****

This is a lightship model. There will be load items on board ship. The majority of the loads will be liquid weight
 These are only approximations built off the MCM 10 Dated 1992weight model. These may not reflect the MCM 5 configuration in its entirety
 These Calculations do not account for water weight

	Ltons	Tons	Tonnes	VCG	LCG	TCG
A	215	241	219	32.61	96.03	-0.36 S
B	274	307	279	13.99	178.09	0.03 P
C	237	266	241	13.95	163.46	0.00 S
D	229	257	233	10.90	96.36	-0.08 S
E	235	264	239	13.21	42.02	0.05 P

Mass properties data is obtained from the MCM-10 Detailed Weight Estimate dated 1992. Data has been sorted within longitudinal delimiters noted in the figure above provided by NAVSEA and the contractor, SMIT as noted in each figure.

The following concerns and questions prepared by NAVSEA address the contractor's lift proposals; responses will permit our assisting them in the execution of their plan.

- 1) What side of transverse Bulkhead at Frame 63 is the 01 level cracked/separated?
- 2) Are the stanchions and end connections to decks and shell longitudinal structure intact forward and aft of Bulkhead at Frame 63? What about in way of the stanchions lines near other proposed cut points?
- 3) What does the salvage team envision for lift points? Temporary attachments or girth belt/strap type lifts, and if temporary attachments, how many points, and how attached?
- 4) If answer to 3 is temporary attachments, what on-site fabrication capacity does the salvage ship have in terms of fabricating bolted padeye type attachments, what fastener hardware, welding capacity, and inventory of steel stock is available? If none available, who would be the fabricators, and is the salvage team intending to provide sketching/scheming these items?
- 5) What inventory of spreader beams are available and rigging gear (i.e. cables, shackles, etc.) is available and what are their capacities or limitations?
- 6) What assets/methods are to be used for sectioning/cutting the hull?
- 7) What are the plans for stabilizing the sectioned portions after/while cuts are made, or said another way will lift rigging and crane be in place during cutting operations for main hull segments?
- 8) Once cutting/rigging process is finalized, can the salvage team provide sketches for the proposed scheme?
- 9) Are there any plans to add internal reinforcement to lift points not centered over main subdivision bulkheads, and what is the scheme for this reinforcement?
- 10) Has a recent below water survey been performed along the length of the GUARDIAN's keel? Initial damage surveys included photographic evidence suggesting the aft region of the ship being cantilevered from the AMR/MMR region with a point support from rudders/propellers.

Equipment Removal

After the determination that USS GUARDIAN would not be salvaged as a single refloatable ship, TYCOM and the class life cycle manager began identifying equipment from GUARDIAN that they would like to have to maintain the rest of the MCM Class ships. Inputs centered on equipment they desired SUPSALV to recover and provide as usable spares. The following list was consolidated from PMS 495 & 470 and provided on 1/25/2013 by CPF Salvage Officer.

SLQ-48

Interior- Consoles (drawers minimum), UCHS components (if possible), VBTF, support test equipment, MP support equipment, Mission Packages 1,2 ,3
Exterior- MNVs, deck cameras, HVT

SQQ-32

Unit 1 Towed Body,
Unit 4, CGA
Unit 3 PCC
Unit 10 Winch and tow cable
Unit 7 & 8 consoles and 11 from CIC
Unit 67/68 Winch Control System
Stow and Hull Lock Assemblies
SQQ-32/OK-520 winch and tow cable

SSN-2

PINS V5 consoles
PINS V5 Racks 1-3
DAGR
VMS1 and VMS2 Display and Keyboard/Trackball
VMS3 Laptop
RDI Doppler Transducer (if not damaged)

SQH-4

BSP Winch
BSP CTD Recorder
XBT Launcher

SSQ-94

SSQ-94 Rack

SLQ-37

Interior- AAG support equipment
Exterior- AAG, IAAG, floats, Mag cable AAG device, Oropesa Gear (floats, cutters, et al) Sweep winch hydraulic components Mine Sweep Gas Turbine and Controller

SLQ-48 All MAMS including UCHS and SQQ-32 All store room items.

Klein Sonar equipment if equipped.

Security

Channel Finder components (transducers, REU, CIC equip) Sweep Wave Generator (Reuse too)
Crypto

Other (HM&E)

MDG 1701 Marconi Magnetometer Degaussing System modules and magnetometer on mast
Medium Pressure Air Compressors All radios

SUPSALV's directive was to remove GUARDIAN without further damaging the reef. Given the lift capacity of JASCON 25, weight reduction from the hull became the guiding factor to determine what equipment was actually removed. All equipment that was easily removed from the weather decks was removed. This included a number of large structural pieces like the mast and exhaust stack but inside the ship was another story. The MMR and AMR spaces were the two primary spaces where weight reduction was needed to ensure the section lifts would be successful. SEA 05 identified the major machinery in each of those spaces and interior paths for equipment removal that would least impact structural integrity of the hull. Also included were equipment lift points and recommendations for disconnecting the machinery. Those plans, provided on 21 February, follow.

Section Lifts

A number of connection methods were proposed for lifting the sectioned USS GUARDIAN from the reef. These options are presented in chronological order.

NAVSEA 05 Lift Plan

SEA 05 recommended lift concept included bolting 4 lifting plates to each side of the hull and using a spreader beams both athwartships and fore and aft to lift the MMR and AMR hull sections.

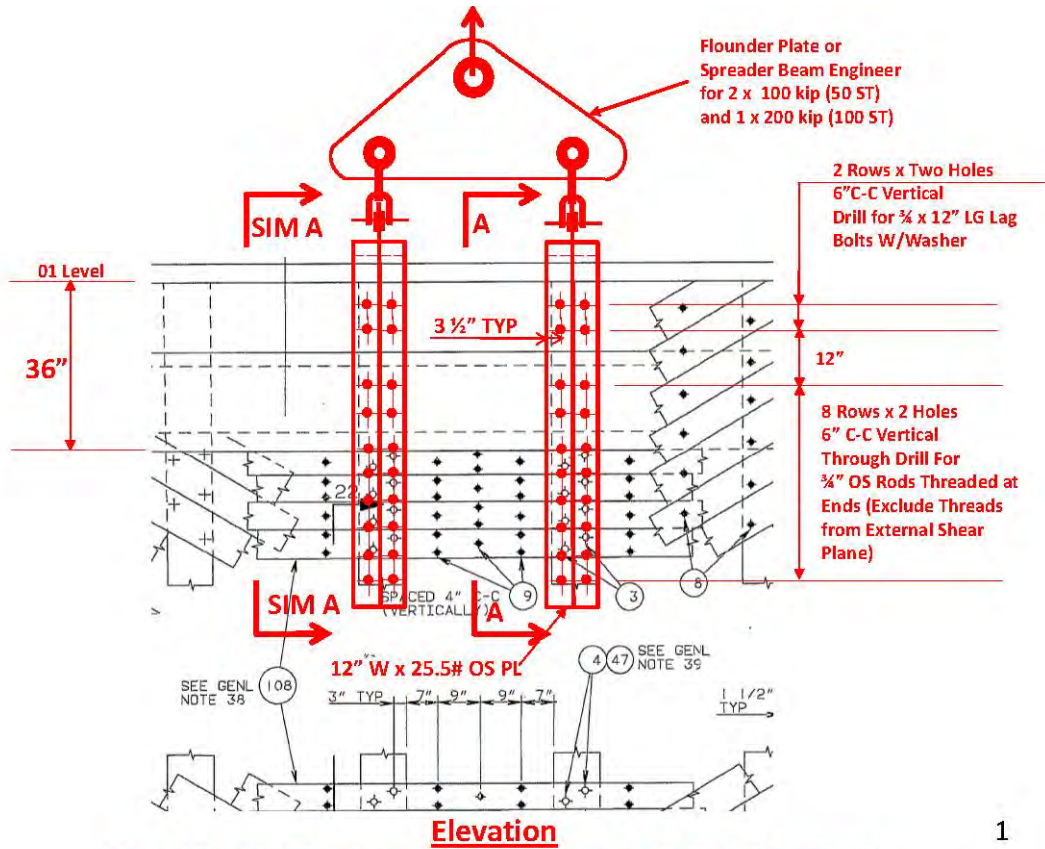

Elevation
Typical Side Shell Reinforcement Lift Point (Four Sets Per Lift Required)

1

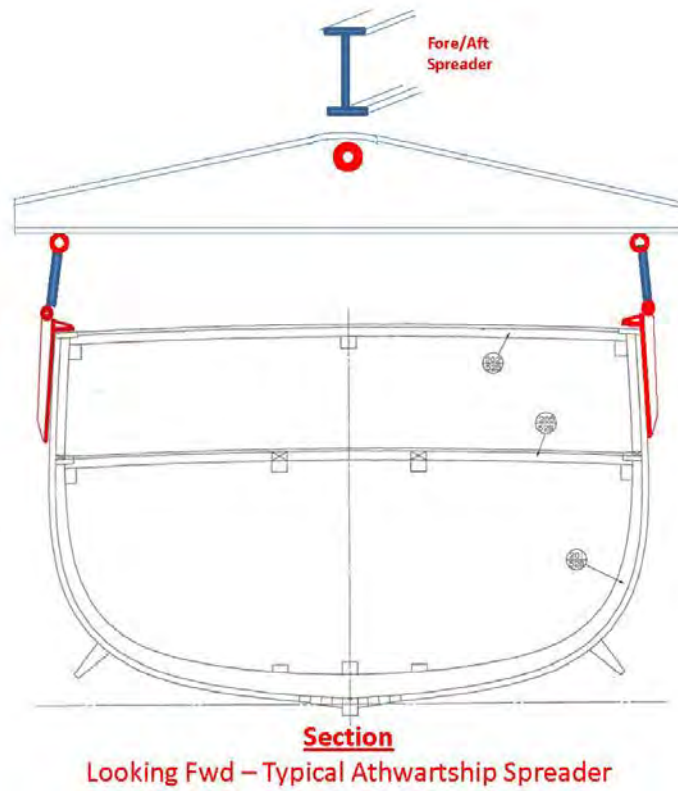
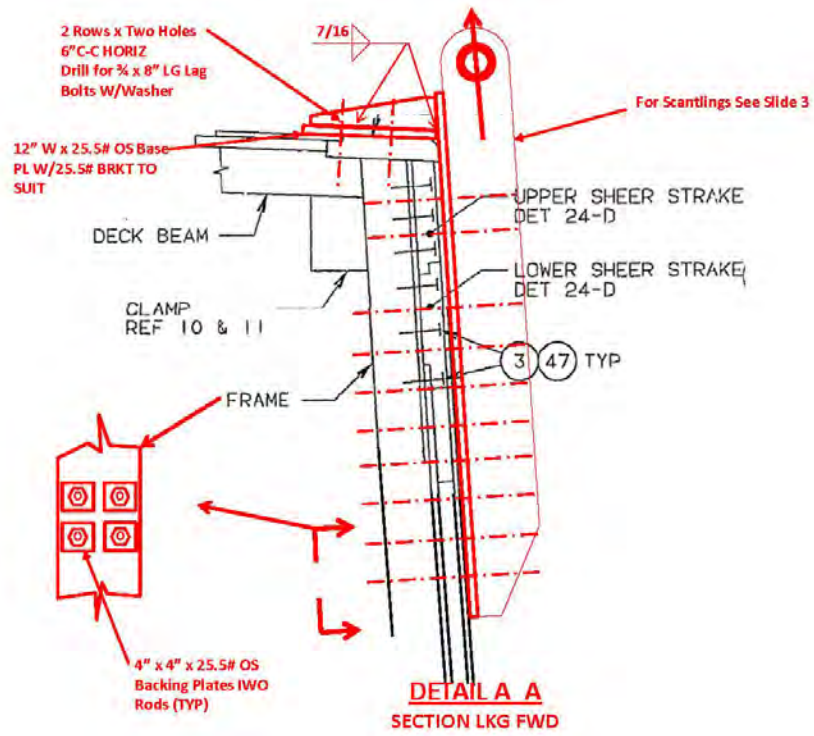

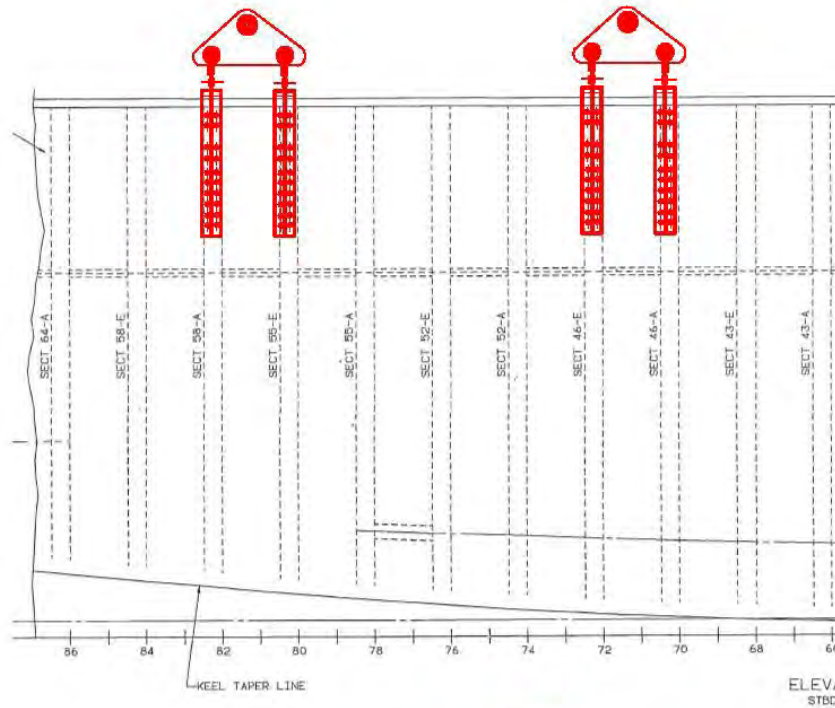

Elevation
Typical Segment Arrangement

ASSUMPTIONS:

- 4 Point Straight Pull Lift Per Hull Segment
- SMIT Option B Only, Max Section Lift = 307 Short Tons (ST)
- Requires Spreader Beams/Fixtures
- Allowable Stresses From Builder Spec increased for lift calculations
- Typical Transverse Web Frame Can Distribute Segment Shear Forces From Hull Sides Provided Tensile Capacity Not Exceeded *
- Tongue and Groove GLULAM of Planking in Fore/AFT and 45 Degree Layers Act As Composite Section
- length to depth ratio of the hull segments - will behave more as shear panels (i.e. Longitudinal stresses acting in the hull & through lift connection are neglected)
- flexure induced by eccentricity of lift point with web frame not considered:
 - May require extension of chain plate just below main deck
 - Other alternatives may be possible including local blocking of webs at main deck from internals of ship
- Transom may be able to be band lifted
- Bow segment extraction will require further investigation

* Edge shear strength of longitudinals, axial tensile & compressive strengths of diagonals require investigation

- Axial Tensile Capacity of Typical Oak Frame
 - 10" x 7" White Oak GLULAM, $A = 70 \text{ in}^2$ (may require reduction to account for bolt holes in same horizontal plane)
 - $F_t = 1.086 \text{ ksi (specs) for GLULAM} = 1.2 \text{ (specs)} \times 1.086 \text{ ksi} = 1.303 \text{ ksi}$
 - $P_{\text{max}} = 70 \text{ in}^2 \times 1.303 \text{ k.in}^2 = 91.2 \text{ kip}$, given FS on new design, use 100 kips for design basis, or $P_d = 100 \text{ kip/attachment}$
 - Maximum segment lift weight for SMIT Option B = 307 ST or 614 kip
 - For a four point lift $R_{\text{max}} = 614\text{k}/4 = 154 \text{ k}$
 - Number of Transverse Web Frames required = $154 \text{ k}/100\text{k}$ or 2 web frames per lift point (minimum)

PCCI Hull Lift Plan

On 8 February, PCCI recommended a hull section lift plan that included 24” wide slings under the clamp beam. The clamp was braced against the deck edge longitudinal beam to increase the lift strength of the slings. The drawings and calculations are provided in the following section.

The concept was sound but finding the 24” wide slings was going to prove difficult and the fitted bracing construction would also be a challenge with the material and labor required as well as the interferences that would be encountered.

**MCM-5 Lift Sling Attachment
Loading Analysis - Rev A**

G. Ruetenik
PCCI, Inc.
7 Feb 2013

Douglas fir properties:

From Wood LAM DOUG worksheet for MCM-5 dtd 2/1/2013
prepared by C. Thorene, PSNS PY

$F_b := 2133 \cdot \text{psi}$	Bending stress extreme fiber
$F_t := 1216 \cdot \text{psi}$	Tension stress parallel to grain
$F_c := 1565 \cdot \text{psi}$	Compression stress to grain
$F_{cT} := 385 \cdot \text{psi}$	Compression stress T to grain
$F_v := 150 \cdot \text{psi}$	Shear stress
Stress modification factors from MCM builder's specs	
$C_{s1} := 0.69$	Slope of grain factor for bending or tension
$C_{s2} := 0.82$	Slope of grain factor for compression
$C_m := 1.0$	Wet Service Factor
$C_l := 1.2$	Lamination factor for stresses
$C_{IE} := 1.1$	Lamination factor for modulus of elasticity
$C_d := 1.25$	Duration of load factor for 7-day loading
$E := 1.6 \cdot 10^6 \cdot \text{psi}$	Nominal modulus of elasticity

Laminated oak properties: From Wood LAM OAK worksheet for MCM-5 dtd 2/1/2013 prepared by C. Thorene, PSNS PY

Fbo := 1866·psi	Bending stress extreme fiber
Fto := 1064·psi	Tension stress parallel to grain
Fco := 0·psi	Compression stress to grain
FcTo := 500·psi	Compression stress T to grain
Fvo := 120·psi	Shear stress

Stress modification factors from
MCM builder's specs

Cs1o := 0.76	Slope of grain factor for bending or tension
Cs2o := 1.0	Slope of grain factor for compression
Cmo := 1.0	Wet Service Factor
Clo := 1.2	Lamination factor for stresses
CIEo := 1.1	Lamination factor for modulus of elasticity
Cdo := 1.25	Duration of load factor for 7-day loading
Eo := $1.5 \cdot 10^6$ ·psi	Nominal modulus of elasticity

Sling attachment overview - 24-inch web sling rigged in basket thru hull.

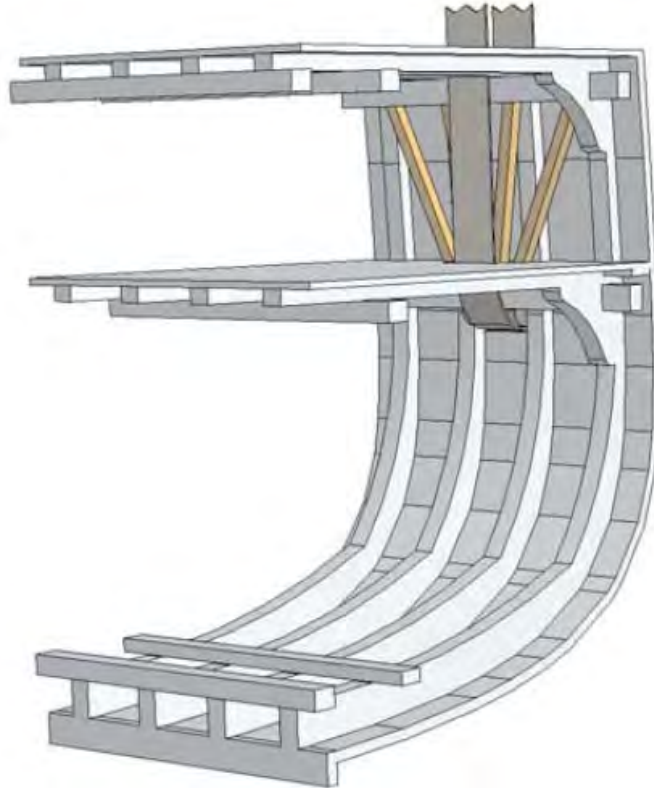

Tensile Strength of two adjacent transverse frames

Frames are laminated oak, continuous from keel to O1 level. This calculation looks at the tensile capacity of the frame cross section.

$$A_{FR} := 7 \cdot \text{in} \cdot 10 \cdot \text{in} = 70 \cdot \text{in}^2$$

Frame 7" molded x 10" sided

$$F_{to}' := F_{to} \cdot C_s \cdot C_{1o} \cdot C_{mo} \cdot C_{lo} \cdot C_{do} = 1213 \cdot \text{psi}$$

Factored allowable tensile stress

$$\text{Load}_{FR} := A_{FR} \cdot F_{to}' = 84907 \cdot \text{lbf}$$

Load Capacity per frame

$$2 \cdot \text{Load}_{FR} = 169814 \cdot \text{lbf}$$

Load Capacity per two frames

Strength of glue joint between Clamp Long'l and Transverse Frame

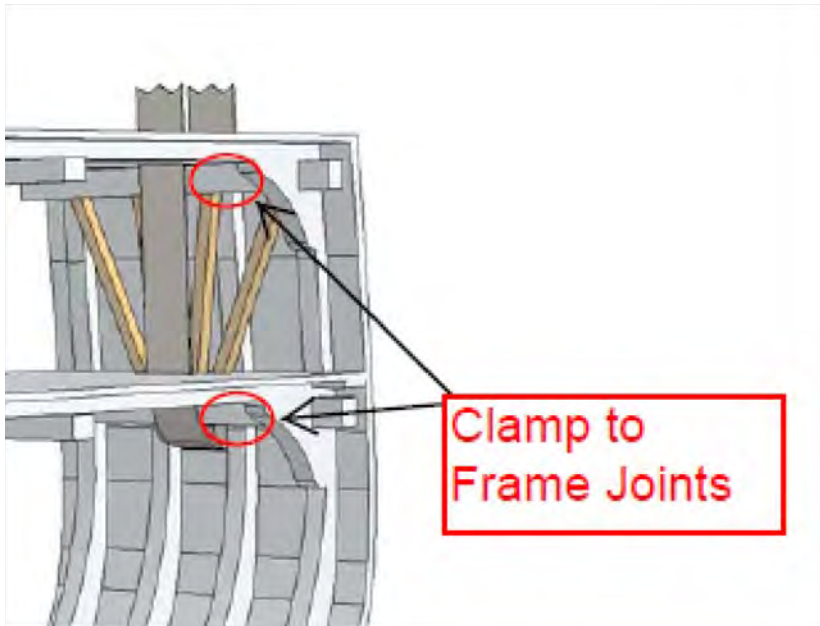

$$A_{\text{clamp}} := 10 \cdot \text{in} \cdot 12 \cdot \text{in}$$

Clamp Long'l dimensions 12"S x 9"M
Transv Frame dimensions 10"S x 7"M

$$F_v' := F_v \cdot C_1 \cdot C_d = 225 \cdot \text{psi}$$

Shear stress capacity of lam Doug Fir.

$$A_{\text{clamp}} \cdot F_v' = 27000 \cdot \text{lbf}$$

Load capacity of one clamp-to-frame glued joint, based on glue stronger than wood.

$$4 \cdot (A_{\text{clamp}} \cdot F_v') = 108000 \cdot \text{lbf}$$

Load capacity of 4 clamp intersections, based on using 2 column braces to the 01 level.

$$6 \cdot (A_{\text{clamp}} \cdot F_v') = 162000 \cdot \text{lbf}$$

Load capacity of 6 clamp intersections, based on using 4 column braces to the 01 level.

Load capacity of diagonal brace of 4" sch40 pipe as a column,
and compare to the load capacity of the Clamp Long'l glue joint.

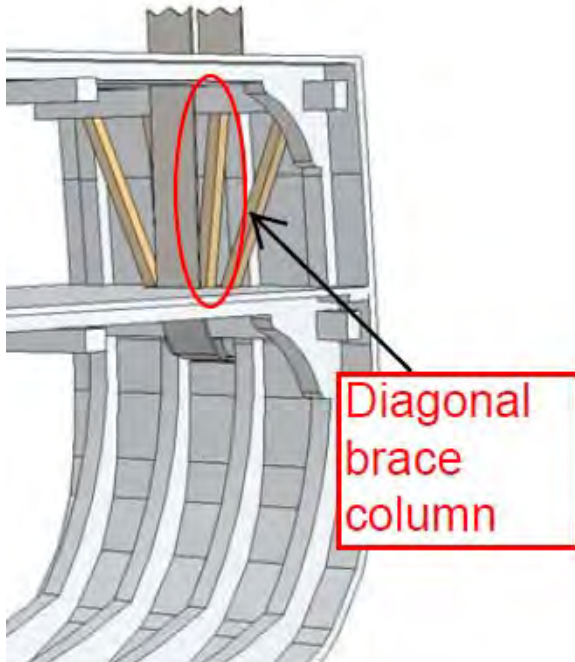

Braces were first designed as timbers. Only the two center braces are required. **The diagonal brace columns must be steel pipe columns or column jacks** to provide enough axial stiffness to effectively relieve the load on the clamp beam.

$$E_{\text{stl}} := 29 \cdot 10^6 \cdot \text{psi}$$

Laminated modulus of elasticity

$$F_{c_{\text{stl}}} := 35000 \cdot \text{psi}$$

Allowable compression stress,
A53 Gr B pipe

$$C_c := \sqrt{\frac{2 \cdot \pi^2 \cdot E_{\text{stl}}}{F_{c_{\text{stl}}}}} = 128$$

Critical slenderness ratio

$$K := 1$$

Effective length factor for condition:
pinned at both ends

$$L := 7.167 \cdot \text{ft}$$

Length of the column

Dimensions of the bracing:

Properties of 4-in Sch40 pipe, AISC SCM Table 4-6

$$A := 2.97 \cdot \text{in}^2$$

Cross sectional area

$$I := 6.82 \cdot \text{in}^4$$

Area moment of inertia

$$r := 1.51 \cdot \text{in}$$

Radius of gyration, 4" sch40,
AISC SCM table 4-6

$$\frac{K \cdot L}{r} = 57$$

Slenderness ratio; less than C_c above
so the below equation is used.

$$P_a := \frac{\left[1 - \frac{\left(\frac{K \cdot L}{r} \right)^2}{2 \cdot C_c^2} \right] \cdot F_{c_{\text{stl}}}}{\frac{5}{3} + \frac{3 \left(\frac{K \cdot L}{r} \right)}{8 \cdot C_c} - \frac{\left(\frac{K \cdot L}{r} \right)^3}{8 \cdot C_c^3}} = 1.73 \times 10^4 \cdot \text{psi}$$

Critical buckling stress for a noncompact
column, per AISC ASD Chapter E.

$$P_a \cdot A = 51376.69 \cdot \text{lbf}$$

Critical buckling load for the bracing

$$\frac{P_a \cdot A}{A_{\text{clamp}} \cdot F_{v'}} = 1.9$$

Compare critical buckling load of brace to
the load capability of the clamp long'l glue joint

The column braces can be made of 4-inch pipe with a screw-jack end fitting.
A catalog cut for a suitable jacking column is included below.

MONO POSTS

ICC-ESR-1767 - Complies with 2009 IBC and IRC Building Codes

Manufacturing Specifications New 11 gauge, carbon steel tubing, minimum yield strength of 42,000 psi, complies with ASTM A500. Meets all FHA/HUD requirements. Finished with corrosion resistant coating that exceeds ASTM-B117-85. One year limited warranty.

Model: 4" O.D., 11 Gauge Standard Tube End Plate: 4/4" x 7/2" x .120" / "H" Series: 4/4" x 7/4" x .120" - Adj./Swivel End Plate 4" x 6" x .120"

Model #	Adjustment Range	UPC "M" Series	Allowable Strength Load Lbs. (ASD)*	Design Strength Load Lbs. (LRFD)*	Weight	Unit Cube
400	6 ft. 0 in. - 6 ft. 4 in.	72" - 76"	7-16733-41400-6	20,400	30,700	37 lbs. 1.37
401	6 ft. 3 in. - 6 ft. 7 in.	75" - 79"	7-16733-41401-3	20,200	30,400	38 lbs. 1.42
402	6 ft. 6 in. - 6 ft. 10 in.	78" - 82"	7-16733-41402-0	20,000	30,000	40 lbs. 1.48
403	6 ft. 9 in. - 7 ft. 1 in.	81" - 85"	7-16733-41403-7	19,700	29,700	41 lbs. 1.53
404	7 ft. 0 in. - 7 ft. 4 in.	84" - 88"	7-16733-41404-4	19,500	29,300	42 lbs. 1.59
405	7 ft. 3 in. - 7 ft. 7 in.	87" - 91"	7-16733-41405-1	19,300	28,900	43 lbs. 1.64
406	7 ft. 6 in. - 7 ft. 10 in.	90" - 94"	7-16733-41406-8	19,000	28,600	45 lbs. 1.70
407	7 ft. 9 in. - 8 ft. 1 in.	93" - 97"	7-16733-41407-5	18,700	28,200	46 lbs. 1.75
408	8 ft. 0 in. - 8 ft. 4 in.	96" - 100"	7-16733-41408-2	18,500	27,800	47 lbs. 1.81
409	8 ft. 3 in. - 8 ft. 7 in.	99" - 103"	7-16733-41409-9	18,200	27,400	48 lbs. 1.86
410	8 ft. 6 in. - 8 ft. 10 in.	102" - 106"	7-16733-41410-5	17,900	26,900	50 lbs. 1.92
411	8 ft. 9 in. - 9 ft. 1 in.	105" - 109"	7-16733-41411-2	17,600	26,500	51 lbs. 1.97
412	9 ft. 0 in. - 9 ft. 4 in.	108" - 112"	7-16733-41412-9	17,400	26,100	52 lbs. 2.03
413	9 ft. 3 in. - 9 ft. 7 in.	111" - 115"	7-16733-41413-6	17,100	25,700	53 lbs. 2.08
414	9 ft. 6 in. - 9 ft. 10 in.	114" - 118"	7-16733-41414-3	16,800	25,200	55 lbs. 2.14
415	9 ft. 9 in. - 10 ft. 1 in.	117" - 121"	7-16733-41415-0	16,500	24,800	56 lbs. 2.20
416	10 ft. 0 in. - 10 ft. 4 in.	120" - 124"	7-16733-41416-7	16,200	24,300	57 lbs. 2.25
417	10 ft. 3 in. - 10 ft. 7 in.	123" - 127"	7-16733-41417-4	15,900	23,900	58 lbs. 2.31
418	10 ft. 6 in. - 10 ft. 10 in.	126" - 130"	7-16733-41418-1	15,600	23,400	60 lbs. 2.36
419	10 ft. 9 in. - 11 ft. 1 in.	129" - 133"	7-16733-41419-8	15,300	22,900	61 lbs. 2.42
420	11 ft. 0 in. - 11 ft. 4 in.	132" - 136"	7-16733-41420-4	14,900	22,500	62 lbs. 2.47
421	11 ft. 3 in. - 11 ft. 7 in.	135" - 139"	7-16733-41421-1	14,600	22,000	63 lbs. 2.53
422	11 ft. 6 in. - 11 ft. 10 in.	138" - 142"	7-16733-41422-8	14,300	21,500	64 lbs. 2.58
423	11 ft. 9 in. - 12 ft. 1 in.	141" - 145"	7-16733-41423-5	14,000	21,000	66 lbs. 2.64

Model: Schedule 40 Series Standard Tube End Plate: 4/4" x 7/2" x .120" / "H" Series: 4/4" x 7/4" x .120" - Adj./Swivel End Plate 4" x 6" x .120"

300-40	6 ft. 0 in. - 6 ft. 4 in.	72" - 76"	7-16733-61200-6	29,300	44,000	52 lbs. 1.37
301-40	6 ft. 3 in. - 6 ft. 7 in.	75" - 79"	7-16733-61201-3	28,800	43,300	54 lbs. 1.42
302-40	6 ft. 6 in. - 6 ft. 10 in.	78" - 82"	7-16733-61202-0	28,400	42,600	56 lbs. 1.48
303-40	6 ft. 9 in. - 7 ft. 1 in.	81" - 85"	7-16733-61203-7	27,900	41,900	58 lbs. 1.53
304-40	7 ft. 0 in. - 7 ft. 4 in.	84" - 88"	7-16733-61204-4	27,400	41,200	60 lbs. 1.59
305-40	7 ft. 3 in. - 7 ft. 7 in.	87" - 91"	7-16733-61205-1	26,900	40,500	62 lbs. 1.64
306-40	7 ft. 6 in. - 7 ft. 10 in.	90" - 94"	7-16733-61206-8	26,400	39,700	64 lbs. 1.70
307-40	7 ft. 9 in. - 8 ft. 1 in.	93" - 97"	7-16733-61207-5	25,900	39,000	65 lbs. 1.75
308-40	8 ft. 0 in. - 8 ft. 4 in.	96" - 100"	7-16733-61208-2	25,400	38,200	67 lbs. 1.81
309-40	8 ft. 3 in. - 8 ft. 7 in.	99" - 103"	7-16733-61209-9	24,900	37,400	69 lbs. 1.86
310-40	8 ft. 6 in. - 8 ft. 10 in.	102" - 106"	7-16733-61210-5	24,400	36,600	71 lbs. 1.92
311-40	8 ft. 9 in. - 9 ft. 1 in.	105" - 109"	7-16733-61211-2	23,800	35,800	73 lbs. 1.97
312-40	9 ft. 0 in. - 9 ft. 4 in.	108" - 112"	7-16733-61212-9	23,300	35,000	75 lbs. 2.03
313-40	9 ft. 3 in. - 9 ft. 7 in.	111" - 115"	7-16733-61213-6	22,700	34,100	77 lbs. 2.08
314-40	9 ft. 6 in. - 9 ft. 10 in.	114" - 118"	7-16733-61214-3	22,200	33,300	79 lbs. 2.14
315-40	9 ft. 9 in. - 10 ft. 1 in.	117" - 121"	7-16733-61215-0	21,600	32,500	81 lbs. 2.20
316-40	10 ft. 0 in. - 10 ft. 4 in.	120" - 124"	7-16733-61216-7	21,000	31,600	83 lbs. 2.25
317-40	10 ft. 3 in. - 10 ft. 7 in.	123" - 127"	7-16733-61217-4	20,500	30,800	85 lbs. 2.31
318-40	10 ft. 6 in. - 10 ft. 10 in.	126" - 130"	7-16733-61218-1	19,900	29,900	87 lbs. 2.36
319-40	10 ft. 9 in. - 11 ft. 1 in.	129" - 133"	7-16733-61219-8	19,300	29,100	89 lbs. 2.42
320-40	11 ft. 0 in. - 11 ft. 4 in.	132" - 136"	7-16733-61220-4	18,800	28,200	90 lbs. 2.47
321-40	11 ft. 3 in. - 11 ft. 7 in.	135" - 139"	7-16733-61221-1	18,200	27,400	92 lbs. 2.53
322-40	11 ft. 6 in. - 11 ft. 10 in.	138" - 142"	7-16733-61222-8	17,600	26,500	94 lbs. 2.58
323-40	11 ft. 9 in. - 12 ft. 1 in.	141" - 145"	7-16733-61223-5	17,100	25,700	96 lbs. 2.64

*Consult a registered professional engineer for column selection based on ASD or LRFD methodologies.



Made in the U.S.A. © 2011 The Akron Products Company - 10004109/00111

11

Strength of Hull Planking for 24-inch web sling

The load capacity of the slot cut through the side planking is believed to be limited by crushing failure of the wood fibers in the bearing surface underneath the sling. The hull planking is 4.50-inch thick in the area of the main deck, as listed below.

Inner diagonal planking: 0.75-inch @ 30-deg
 mid diagonal planking: 0.75-inch @ -30-deg
 long'l planking T&G: 2.5-inch horizontal
 outer diagonal planking: 0.5-inch @30-deg

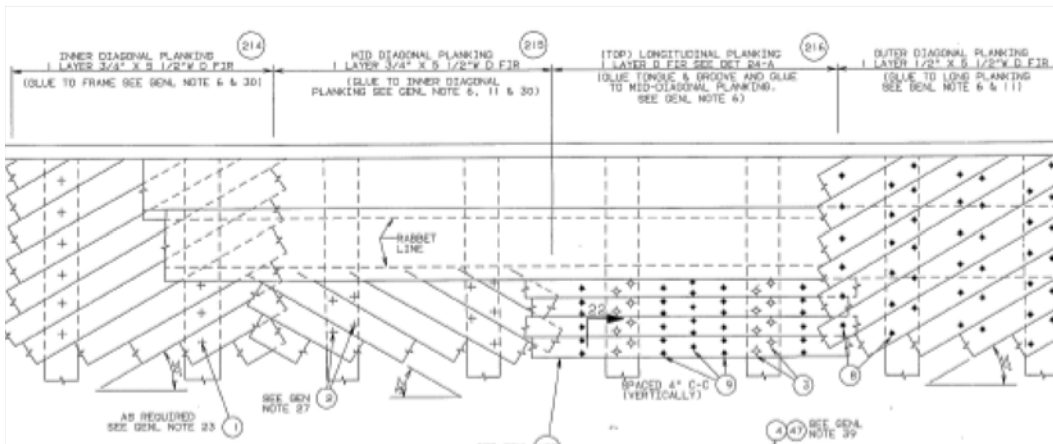

From NAVSEA Dwg 111-6134059, Detail 17-A

- | | |
|---|--|
| $T_{diag} := 0.75 \cdot \text{in} + 0.75 \cdot \text{in} + 0.5 \cdot \text{in} = 2 \cdot \text{in}$ | Total diagonal planking thickness |
| $T_{lon} := 2.5 \cdot \text{in}$ | Long'l planking thickness |
| $L_{saddle} := 31 \cdot \text{in}$ | Length of sling saddle bearing opening in hull |
| $F_c T := F_c T \cdot C_m \cdot C_l = 462 \cdot \text{psi}$ | Compressive stress capacity (T-to grain) of Douglas Fir side planking. |

Note: compressive failure stress of Doug Fir perp to grain is 800-850 psi.

However, the elastic modulus of Douglas Fir in the direction perpendicular to the grain is only about 5% of the elastic modulus parallel to the grain. Therefore, the long'l hull planking does not provide its full compressive capacity to the matrix of planking. Due to their elasticity, the long'l planks will compress and will absorb only an insignificant portion of the total load on the planking.

Therefore, the contribution of $F_c T$ has been ignored in the 2.5-inch thick long'l hull planking.

$$F_c' := F_c \cdot C_m \cdot C_l = 1878 \cdot \text{psi}$$

Compressive stress capacity (|| to grain)
of Douglas Fir diagonal hull planking.

The compressive load capacity of the slot thru the planking is estimated below, taking into account **only** the compressive stress capacity of the diagonal planking at 30-degree angle, and **setting to -0- the contribution of the long'l planking**.

$$\text{Load}_{\text{plank}} := L_{\text{saddle}} \cdot (T_{\text{diag}} \cdot F_c' \cdot \sin(30 \cdot \text{deg}) + 0 \cdot T_{\text{lon}} \cdot F_c T') = 58218 \cdot \text{lbf}$$

The load applied to the opening in the hull is presumed to be carried by the combined capacity of the clamp beam and the hull planking working together.

Estimated capacity of one sling connection at one thru-hull penetration based on loading the clamp beam and the hull to their full capacity:

$$F_{\text{total}} := 4 \cdot (A_{\text{clamp}} \cdot F_v') + \text{Load}_{\text{plank}} = 166218 \text{ lbf}$$

$$\frac{4 \cdot (A_{\text{clamp}} \cdot F_v')}{F_{\text{total}}} = 0.65$$

$$\frac{\text{Load}_{\text{plank}}}{F_{\text{total}}} = 0.35$$

The 65/35 load split between the clamp and the hull planks cannot be assured with the proposed sling arrangements. The sling saddle and geometry suggests that a 50/50 load split is more likely. At this point, the limiting structure for a 50/50 split appears to be the compression loading on the hull planking.

PCCI suggests assuming a 50/50 load distribution, and the capacity of the sling connection would be limited to:

$$F_{5050} := 2 \cdot \text{Load}_{\text{plank}} = 116436 \text{ lbf}$$

The local hull structure of planking, transverse frames, clamp beams, and diagonal braces must be checked by FEA to confirm the load path and load distribution throughout these components. Points to review in the FEA:

1. Check the loads on the clamp-to-transverse glue joints.
2. Check tension loads in the transverse frames.
3. Check diagonal brace loads.
4. Check shear stresses in the hull planking as it diffuses the load into shear stresses in the areas radiating outward from the hole in the hull.

Estimate of shear stress capacity of MCM-5 hull planking.

From POSSE Ship Characteristics Data File
for USS Avenger MCM 1 Class
File updated 3/19/98

The general notes address the shear capacity of the hull as follows: "A design shear load of 225 tons hogging and 125 tons sagging shall act at the quarter points. These loads shall extend two stations forward and aft of the quarter points and taper to zero at amidships and perpendiculars."

$LT := 2240 \cdot \text{lb} \cdot \text{f}$

$\text{Shear} := 225 \cdot LT$ Max design shear load on hull due to hogging load.

$A_5 := 1185.9 \cdot \text{in}^2$ Shear area at station 5 = fwd quarter point, from USS Avenger strength stations in POSSE model shown below.

$A_{15} := 919.3 \cdot \text{in}^2$ Shear area at station 15 = aft quarter point, from POSSE model.

$F_{sh} := \frac{\text{Shear}}{A_{15}} = 548.24 \text{ psi}$ Maximum design shear stress based on the lesser shear area at Sta 15.

Suggested design shear stress capacity of the planking is:

$F_{sh} = 548.24 \text{ psi}$

PCCI - 2014
USS AVENGER

POSSE Ship Project Editor 4.9.0beta
1/15/2013 4:15:35 PM

Strength Stations

STRENGTH STATIONS

* Name	Location Long ft-MS	Shear Area		Moment of Inertia		Section Modulus		Extreme Fiber from NA	
		Ay in ²	Ixx ft ⁴	Top ft ³	Bottom ft ³	Top Ft	Bottom Ft		
S3	71.92F	1,154.4	1,823	123	169	--	--		
S4	61.65F	1,157.8	1,750	123	158	--	--		
S5	51.37F	1,185.9	2,181	158	190	--	--		
S6	41.10F	1,188.6	2,404	178	206	--	--		
S7	30.82F	1,195.6	2,490	190	206	--	--		
S8	20.55F	1,184.3	2,488	197	196	--	--		
S9	10.28F	1,187.4	2,484	207	187	--	--		
S10	0.00	1,163.3	2,336	201	171	--	--		
S11	10.28A	1,158.9	2,151	196	150	--	--		
S12	20.55A	1,125.5	1,945	185	131	--	--		
S13	30.82A	1,063.8	1,893	179	129	--	--		
S14	41.10A	932.9	1,490	148	115	--	--		
S15	51.37A	919.3	1,187	126	106	--	--		
S16	61.65A	839.7	870	99	104	--	--		
S17	71.92A	810.4	733	81	89	--	--		

SMIT Hull Lift Plan

SMIT salvage plan drafts addressed the hull lift but specific lifting plans were unclear through 30 January. Discussion of rigging concepts included rigging slings under the hull after cuts were completed or attaching slings to a number of Hoeksma Insert Bollards cut into the side shell of the vessel. By Rev 5 of the salvage plan, issued on 11 February, it was assumed the hull may have “disintegrated significantly” in the vicinity of the MMR and AMR and that the mechanical and hydraulic grabs would be used to scoop out the interior of the hull to the shell plating after the bow and stern lifts were accomplished. This concept was further discussed in a 9 February “Removal Process” document where the term canoing was used.

As equipment removal continued and the weather quieted down, the team realized the hull sections were likely to retain enough strength to allowing lifting SMIT proposed the lift sling concept. A drawing of that follows:

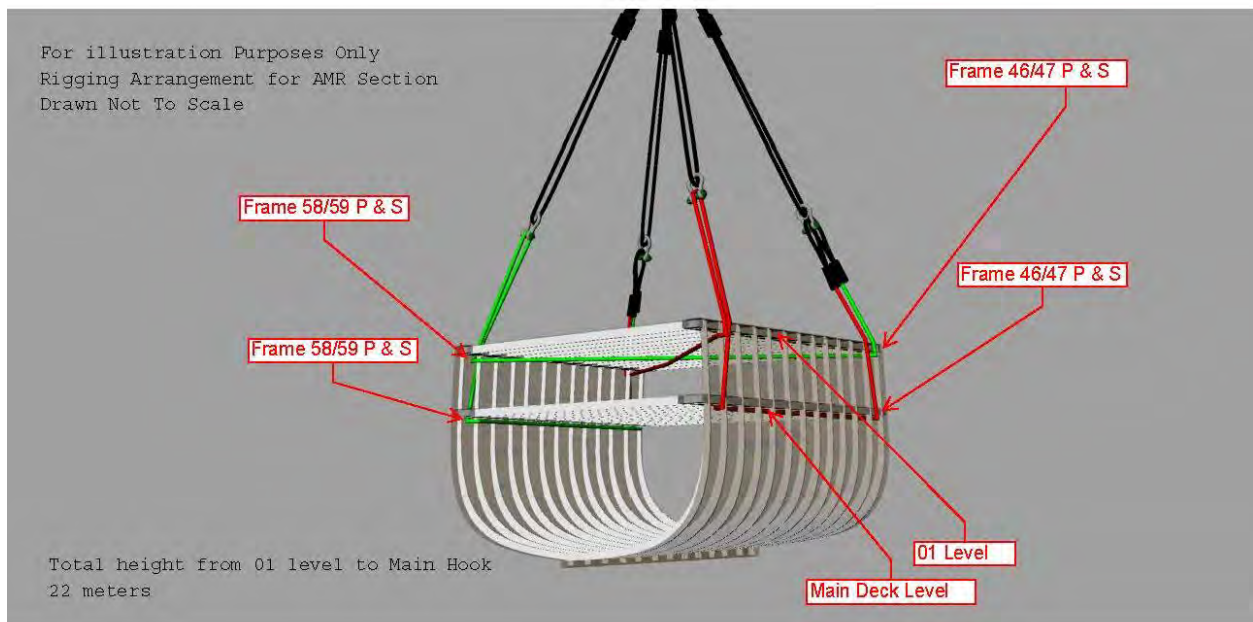

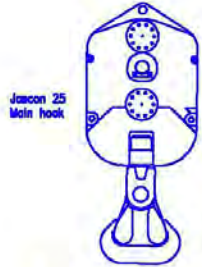

Rigging Materials for Lifting				
Designation	Materials	Sizes	Quantity	SWL
A	Wire Sling	Ø71mm X 50m Length	2	64 MT
B	Shackles	125 ton	4	125 MT
C	Wire Sling	Ø71mm X 20m Length	4	64 MT

*note: Lifting height: from 01 level of AMR & MMR section to hook is 22 meters

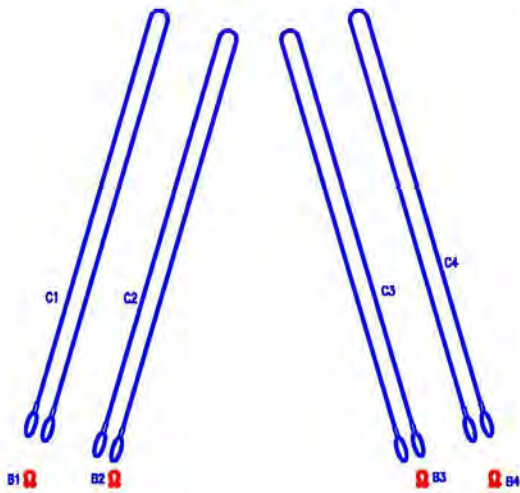

Exit Points on Side Shell		
Legend	AMR Section	MMR Section
①	Main Deck Level Fr. 46/47 P	Main Deck Level Fr. 65/66 P
②	01 Level Fr. 46/47 P	01 Level Fr. 65/66 P
③	01 Level Fr. 46/47 S	01 Level Fr. 65/66 S
④	Main Deck Level Fr. 46/47 S	Main Deck Level Fr. 65/66 S
⑤	Main Deck Level Fr. 56/59 P	Main Deck Level Fr. 81/82 P
⑥	01 Level Fr. 56/59 P	01 Level Fr. 81/82 P
⑦	01 Level Fr. 56/59 S	01 Level Fr. 81/82 S
⑧	Main Deck Level Fr. 56/59 S	Main Deck Level Fr. 81/82 S

*note: dunnages will be installed on lifting/contact points for additional support.

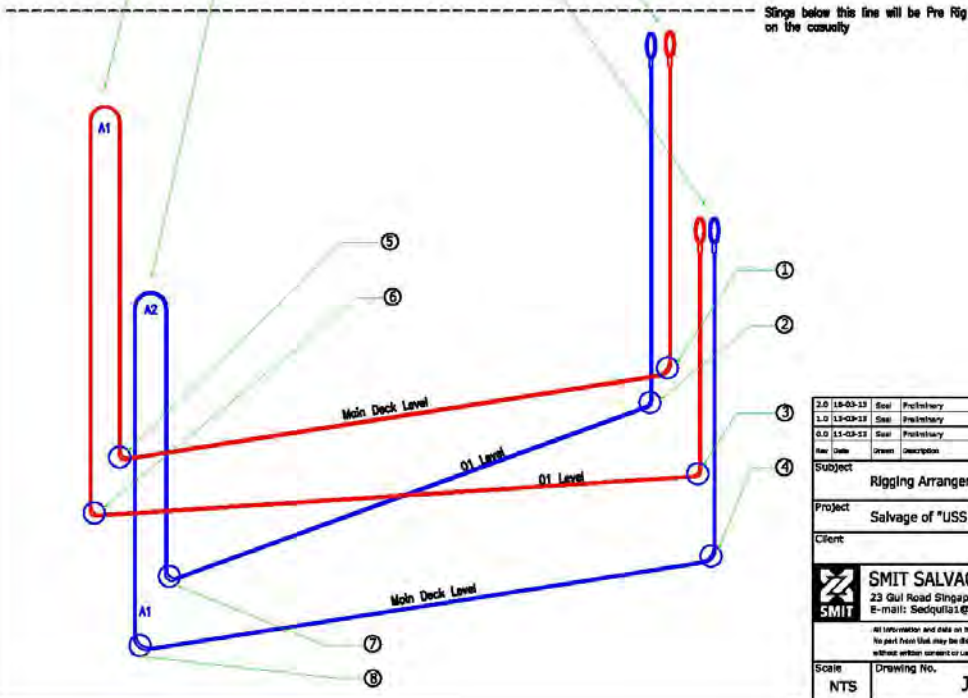

3.0	18-03-13	Rev	Pre/Revisy	Wy/By/Rev	
1.0	18-03-13	Rev	Pre/Revisy	Wy/By	
0.0	13-03-13	Rev	Pre/Revisy	Wy/By	
Rev	Issue	Drawn	Description	Client	CLAPP Client
Subject Rigging Arrangement (AMR & AMR)					
Project Salvage of "USS Guardian"					
Client					
SMIT SALVAGE 23 Gul Road Singapore E-mail: Sedqulst@smit.com				CAD-Drawg needs to be checked manually Orig. Size	
All information and data on this drawing are property of SMIT Salvage Pte. Ltd. No part thereof may be disclosed, copied, duplicated or in any other way made use of without written consent or leave other than on terms agreed to writing.					
Scale	Drawing No.				Sheet
NTS	J5560-D-007				

PCCI Review of SMIT Plan

PCCI reviewed the lift sling concept on 13 March and the following was considered.

The major concern is that at least initially the entire vertical load will be taken by the hull planking and clamp beams at the eight places the wires enter the hull. This structure may fail completely before the rest of the frames effectively spread the load and progressively fail to essentially “unzip” the framing along the deck.

PCCI has reviewed the sling arrangement shown in SMIT Dwg J5560-D-007 and sketch Mid 3d Drawing-1.

We are concerned that the 71mm dia (2.8-in) wire rope will progressively cut through the Douglas Fir planking and beam members under the loading of 53.75LT per lift point. (430 LT total / 8 lift points). The Doug Fir has a failure crush strength of 800psi in compression perpendicular to the grain. In order to distribute the wire loading to below 800-psi, the wire will have to be engaged in wood structure for a length of 53.84-inches.

The hull is 4.5-inches thick. The clamp beam is 9-inches wide. The deck transverse beams are 10-inches wide. The wire would have to effectively engage and lift on a combination of the side plank, the clamp beam, and four of the deck transverse beams at each of the 8 lift points, in order to develop 53.5-inches of contact length to distribute the pressure to less than the 800-psi crush failure of the Douglas Fir. It is doubtful that this much lumber in the structure could be simultaneously engaged before the wire cuts totally through the members that initially took the load.

PCCI modeled the side planking being loaded at one of the 8 lift points, and a progression of pictures is attached. The upper stress limit is set for 800-psi. When an element reached 800-psi in compression, that element was reduced to virtually no-strength, and the loading applied again. What we see in the series of images is that as the 800-psi limit is exceeded and elements break, the load travels upward and sideways through the side shell and overloads the neighboring elements. In slides 4a through 5a the failure stress has spread to the transverse frame itself. This suggests that the side shell planking will progressively fail before reaching the anticipated load on the lift wire.

This progressive failure is most important when considering loading the side shell and clamp beams at the 01 Level. There is no additional planking or structure above the 01 Level that would prevent an early tear-out of the lift points.

SMIT's sling arrangement may be successful, in that the basket-rigged slings pass under all the deck beams and thereby lift on 15 transverse frames. Even as the hull fails locally, and perhaps fails in some sagging mode, the slings may be able to capture these 15 frames and the attached deck, and lift that away. It will not be a neat lift. The bottom of the ship may remain on the reef, especially if there are major weight items remaining.

PCCI notes that our analysis of the damaged hull structure indicates that the transverse frames appear to be broken at the turn of bilge on the port side, and perhaps the starboard side as well. These breaks are indicated by our modelling the field-reported movement of the port side shell in the region MMR/AMR, and the amount of racking of the hull that seems to occur in waves. If the side shell is moving 6 to 8 inches in waves, then the stresses in the transverse frames likely exceed their bending strength. These broken frames would allow the bottom to fall out of the hull as it is lifted from the main deck level as suggested by the SMIT sling arrangement - especially if there remains a lot of heavy machinery in the MMR/AMR.

Lift Plan Conclusion

The on-site salvage team evaluated the options proposed and based on the evolving conditions on site and concluded a modified version of the SMIT plan would succeed. The locations and patterns of the slings were modified a number of times during the planning process. Ultimately, the lift slings were run longitudinally below the clamp beam under the Main Deck and in an X pattern under the 01 Level. This ensured the structurally significant Hanging Knee braces were fully engaged by the lower lifting slings to more effectively distribute the loading. The keel, keelson, and other bottom structure were also discovered to be largely intact and facilitated the sectional lift. Using this modified solution, the SUPSALV – SMIT team rigged the bow section with 71mm slings and lifted it on March 26 and successfully transported it to Barge S7000. The following 4 days saw the successful lift of the remaining hull sections.

APPENDIX B

SITREPS DOCUMENTATION KEY EVENTS

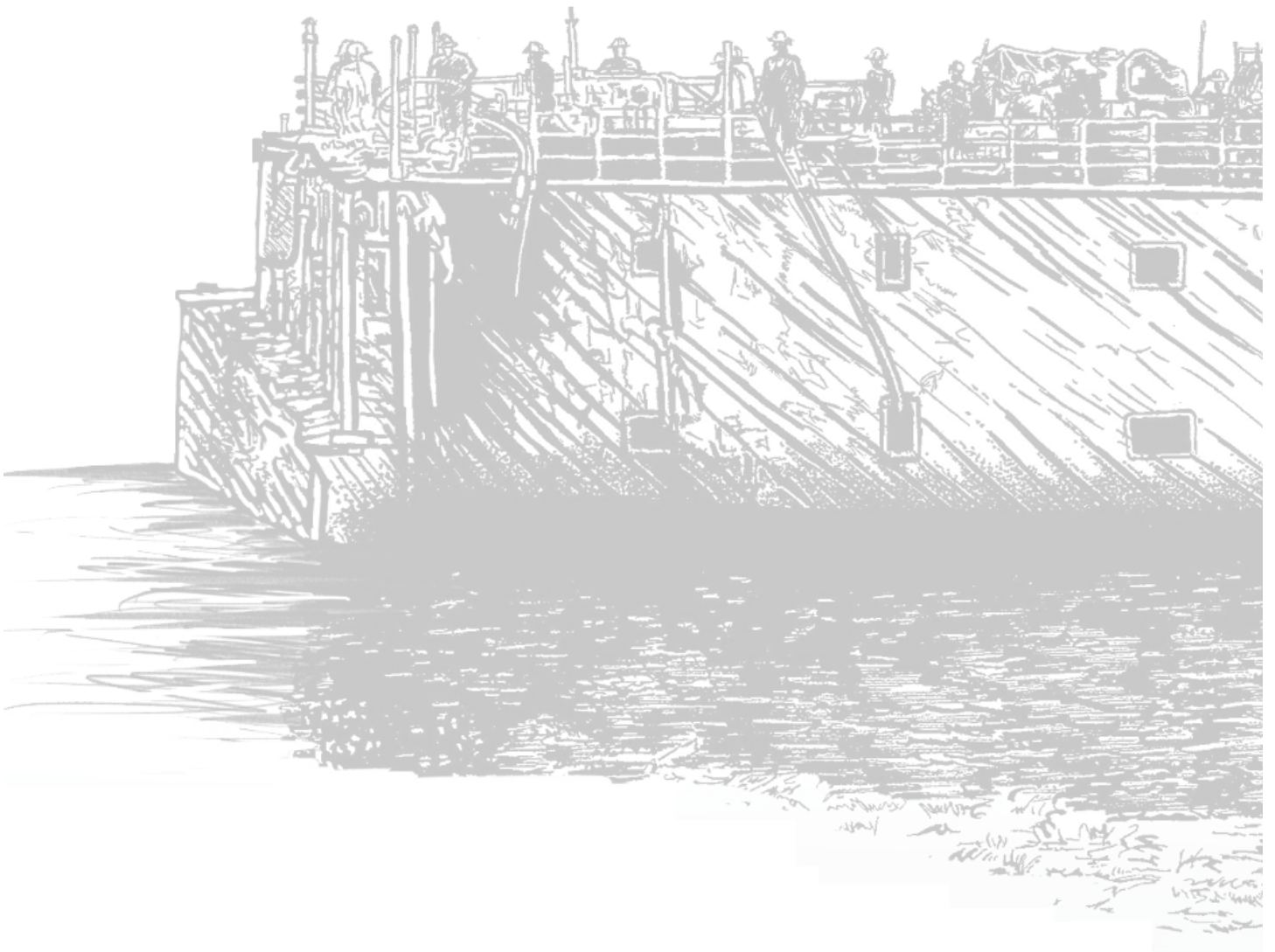

This page intentionally left blank.

GUARDIAN Crisis Action Team

N434 Salvage Summary

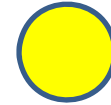

Context

- GUA assessed hard aground, **no rolling movement**, resting with stbd side to reef, **slight increase to port list**, multiple spaces flooded.
- Recovery Stages
 - Stage 1 – Conduct Ship Condition Assessment **and mitigate Enviro Risk**.
 - Stage 2 – remove from reef – waterborne stability.
 - Stage 3 – **Assess scope of necessary permanent repairs, determine maint. Facility, and transport to maint. facility.**
- Possible Salvage Scenarios
 1. Crane Off Reef (most probable)
 - A. Temp repairs at sea to make towable.
 - B. Place on Barge to transport.
 2. Tow Off Reef (unlikely)
 - Assessing feasibility given ground reaction.
 3. Other as required.

Concerns:

- GUA Stability & Integrity.
- Deploy oil boom from M/V TRABAJADOR weather permitting
- M/V VOS APOLLO (salvage tug) ENR PPS; ETA AM 20 Jan(W).
- After onload, will move equipment from PPS to GUA

Issues:

- Puerto Princesa (PPS) as logistics base.
- **Reduced capacity of 1000T crane based on required boom reach; limitation is depth of water close to GUA.**
- **Dry Dock availability for permanent repairs. CPF N43 & SURFPAC N43 are working issue.**
- Ensuring GUA seaworthiness for tow. Requires adequate temporary repair method for wood hull.
- Ensuring SMIT cranes and barges leave Singapore Wednesday.

Last 24 Hours

- GUA: **no movement relative to reef, no rolling, no oil sheen. GRP delaminated along port side of ship.**
- SAL & VOS APOLLO enroute.
- **1000T & 500T cranes and barge contracted.**
- Salvage Team personnel transferred to **MSV-C AND M/V TRABAJADOR** complete.
- **Aircraft enroute to Singapore to pick up Salvage gear; has clearance to PPS.**

Next 24 Hours

- Salvage & Dive team commence assessment, wx permitting
- Salvage C2 team from MDSU-1 **ENR PPS: ETA 20/0300(W).**
- SWRMC Battle Damage Repair team ENR PPS: 19/2200(W)
- Develop draft Salvage COAs w/ CTF 73
- EOD coordination for initial inspection

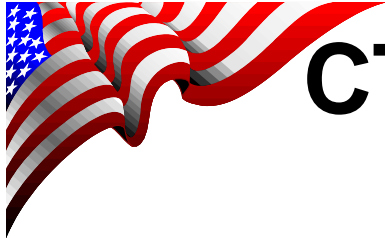

CTU OPERATION GUARDIAN

28 MAR 2013



- **Current**

- Weather conditions supported continued salvage operations (seas 0-1ft, winds 045T at 7-12 kts)
- Completed non-structural hull cuts for MMR Section
- Completed rigging MMR section for hull lift
- Commenced rigging Stern for hull lift, intend to complete later today
- Commenced reef clean-up
- VOS HERCULES with initial shipment of material offloaded in Sasebo (BZ to SRF-JRMC Sasebo)

- **Issues**

- NSTR

- **Next 24 Hours**

- Complete hull cuts for MMR lift
- Lift MMR section and transfer it to BORNEO/S7000 Barge
- Continue reef clean-up

- **Next 72 Hours**

- Continue reef clean-up

- **Next 48 Hours**

- Lift Stern and transfer it to BORNEO/S7000 Barge
- Continue reef clean-up

Unclassified

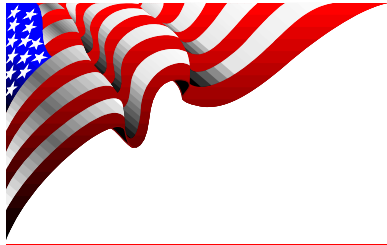

Projected Schedule

Event/Activity	Duration	Early Complete	Late Complete	Current Estimate
Engineering space equipment removal	2-5 days	20-Mar	23-Mar	23-Mar
Clear hull cut paths	2-5 days	20-Mar	23-Mar	25-Mar
Clear rigging paths	2-5 days	20-Mar	23-Mar	23-Mar
Skim/abate oil in AMR/MMR	(ongoing)	20-Mar	23-Mar	25-Mar
Place slings for Bow Lift	2-4 days	22-Mar	27-Mar	24-Mar
Place slings for AMR Lift	2-4 days	22-Mar	27-Mar	25-Mar
Preliminary hull cuts for Bow Lift	2-4 days	22-Mar	27-Mar	25-Mar
Preliminary hull cuts for AMR Lift	2-4 days	22-Mar	27-Mar	27-Mar
Final cut and lift for Bow Section	1-2 days	23-Mar	29-Mar	26-Mar
Final cut and lift for AMR Section	1-2 days	24-Mar	31-Mar	27-Mar
Place slings for MMR Lift	2-4 days	26-Mar	4-Apr	28-Mar
Place slings for Stern Lift	2-4 days	26-Mar	4-Apr	28-Mar
Preliminary hull cuts for MMR Lift	2-4 days	26-Mar	4-Apr	28-Mar
Final cut and lift for MMR Section	1-2 days	27-Mar	6-Apr	29-Mar
Lift Stern Section	1-2 days	28-Mar	8-Apr	30-Mar
Manual debris removal from reef	5-7 days	2-Apr	15-Apr	3-Apr

Events lined out are complete. Items with a "Current Estimate" of today that are not lined out are projected to complete today but were not complete at the time of SITREP submittal.

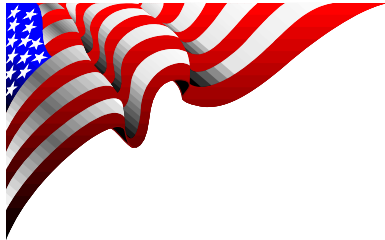

28 MAR



C2 and LNO Placement

- ON SCENE (IVO GUARDIAN)
- USNS SAFEGUARD
- JASCON (800 TON CRANE)
- NAVSEA 00C
 - CAPT MATTHEWS
 - LCDR ADDINGTON
 - LT CUNNINGHAM
 - LT URBANCZYK
 - LT NEVEROSKY
 - MR HERB
- MDSU ONE
 - NDC ROFF (MDV)
 - HMC WACHTER
 - EN1 SNOWDEN
 - MDS CO 1-2 (17)
- FLEET MEDICAL TEAM
 - CDR PRATT
 - LCDR FULLER
- PAO
 - MC3 SANDERS
 - MC3 STEPANIK
- RP NAVY LNO
 - LCDR PACHECO, PCG
 - SN1 IBANEZ, PCG
 - SN1 CABRESTAHE, PCG
- M/V SMIT BORNEO (500 TON CRANE) w/ S7000 Barge
- M/V ARCHON TIDE
- M/V INTREPID
- M/V TRABAJADOR
- USNS WASHINGTON CHAMBERS
- FLEET MEDICAL TEAM
 - LT STORZ
 - HM2 LOHMAN

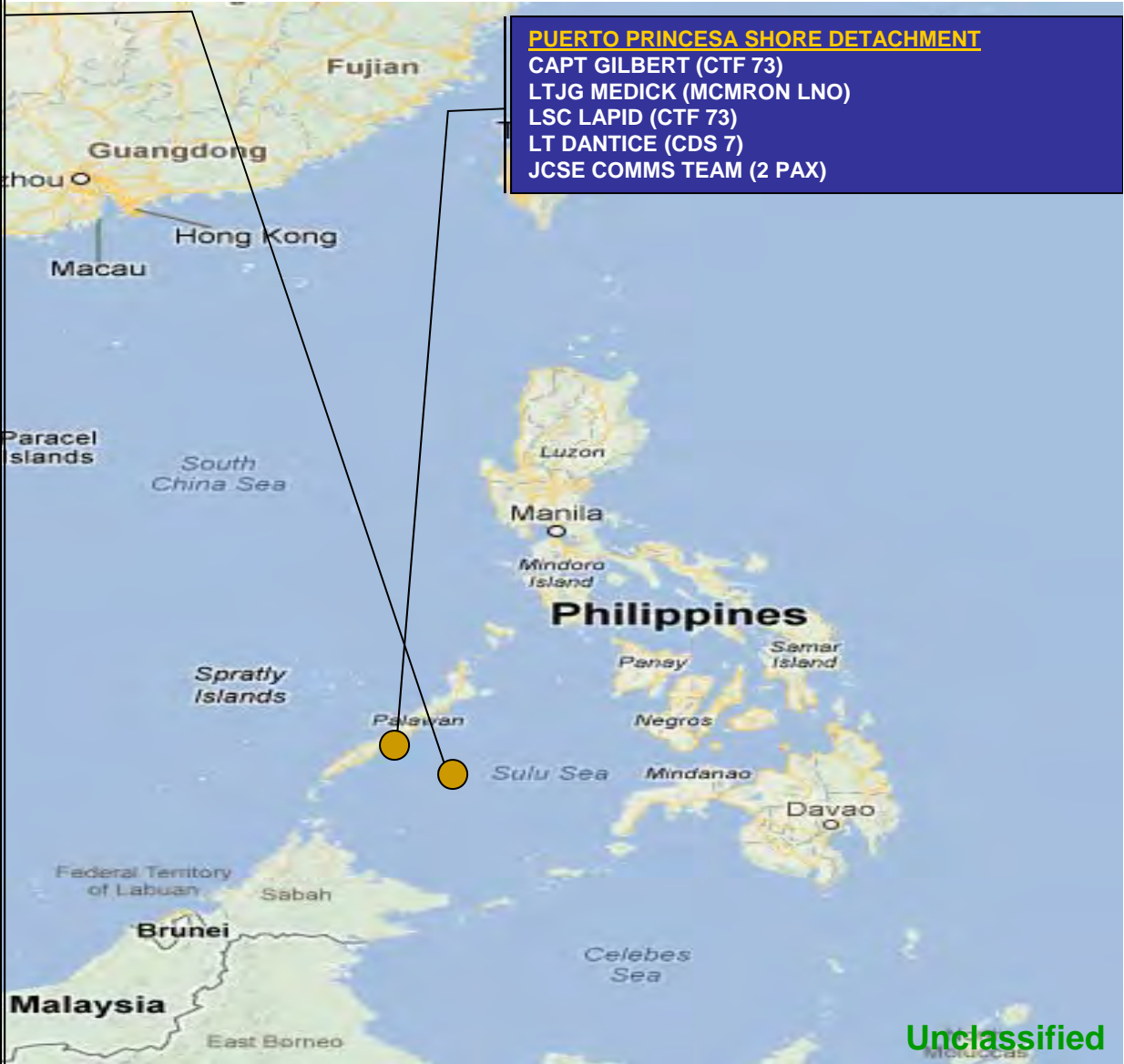

Unclassified



Unclassified

This page intentionally left blank.

APPENDIX C

KEY TASKING DOCUMENTS



This page intentionally left blank.

Appendix C – Tasking Messages

O 191021Z JAN 13 ZEL PSN 570831K24

FM COMSEVENTHFLT

TO RHOVNGW/CTF 70

RHMFISS/CTF 72

RUOIAAA/CTF 73

RUAYIAA/CTF 74

RHMFISS/CTF 76

INFO RHMFISS/HQ USPACOM HONOLULU HI

RUOIAAA/COMPACFLT PEARL HARBOR HI

RHMFISS/COMPACFLT PEARL HARBOR HI

RUOIAAA/COMNAVSURFPAC SAN DIEGO CA

RUALSFJ/COMUSJAPAN YOKOTA AB JA

RUALSFJ/COMUSJAPAN COMMAND CENTER YOKOTA AB JA

RUOIAEB/COMNAVFORJAPAN YOKOSUKA JA

RUOIAAA/COMEXSTRIKGRU SEVEN

RUOIAAA/COMLOG WESTPAC

RHOVHHL/COMPHEBRON ELEVEN

RUOIAAA/COMCMRON SEVEN

RUZDEAK/USDAO MANILA RP

RUEHML/USDAO MANILA RP

RUOIAAA/COMNAVSEASYS COM WASHINGTON DC

RHMFISS/COMNAVSEASYS COM WASHINGTON DC

RUOIAAA/JSOTF PHILIPPINES

RHOVVKG/COMSEVENTHFLT

BT

UNCLAS

MSGID/OPORD/COMSEVENTHFLT/008//

SUBJ/OPERATION ORDER - OPERATION GUARDIAN//

REF/A/DOC/COMSEVENTHFLT/19AUG12//

REF/B/MSG/GUARDIAN/162046ZJAN2013//

NARR/ REF A IS COMSEVENTHFLT OPORD 201. REF B IS GUARDIAN INITIAL

NAVY BLUE OPREP MESSAGE.

POC/LUDWIG, MATTHEW, LCDR//LOC: USS BLUE RIDGE, YOKOSUKA

JAPAN/SECTEL: DSN 315-453-2112

POC/C7F MOC CHIEF/C7FMOCCHIEF(AT)C7F.NAVY.SMIL.MIL//

GENTEXT/AUTHORITY/

1. THIS IS AN OPERATIONS ORDER DIRECTING COMSEVENTHFLT ASSETS ACTIONS DURING RECOVER AND SALVAGE OPERATIONS OF USS GUARDIAN IN THE SULU SEA.//

/TASK ORGANIZATION//

/UNIT /UNITLOC/COMMENTS

/COMSEVENTHFLT /YOKOSUKA, JAPAN /USS BLUE RIDGE

/CTF 76/OKINAWA, JAPAN

/CTF 73/SINGAPORE/FORWARD CE TBD

/CTF 72/ATSUGI, JAPAN

/CTG OP GUARDIAN /SULU SEA/FORWARD CE

/CTU GUARDIAN.1 /SULU SEA/USS GUARDIAN

/CTU GUARDIAN.2 /SULU SEA/USS BOWDITCH

/CTU GUARDIAN.3 /SULU SEA/USS MUSTIN

/CTU GUARDIAN.4 /SULU SEA/MDSU ONE

GENTEXT/SITUATION//

2. GENERAL

AT 170223HJAN13 USS GUARDIAN RAN AGROUND IN THE SULU SEA AND IS IN IMMINENT DANGER OF A HULL BREACH, WHICH COULD CAUSE SIGNIFICANT ENVIRONMENTAL DAMAGE TO THE TUBATTAHA REEF AND SURROUNDING AREA. MSV SEA CHAMPION IS ON STATION AND HAS SAFELY RECEIVED THE CREW. SOCPAC AND CDR, JSOTF-P RESPONDED TO A REQUEST FROM C7F TO PROVIDE IMMEDIATE ASSISTANCE TO THE GUA. SUBSEQUENTLY, CDR,JSOTF-P LAUNCHED THE MSV C-CHAMPION ON 17 JAN 13 THE FOLLOWING VESSELS ARE ON STATION OR TRANSITING TO THE AREA TO PROVIDE ASSISTANCE:

- USS MUSTIN
- MSV CHAMPION
- USNS BOWDITCH
- USNS SAFEGUARD
- MOV APOLLO
- MT TRABAJADOR

WEATHER AND SEA STATE ARE LESS THAN OPTIMUM FOR RECOVERY AND SALVAGE OPERATIONS, SEAS FORECASTED TO EXCEED 8FT. CTF 72 MPRA AIRCRAFT WILL PROVIDE OVER HEAD IMAGERY.

// GENTEXT/MISSION// 3. MISSION STATEMENT. CTG OP GUARDIAN CONDUCTS EXPEDITIOUS RECOVERY AND SALVAGE OPERATIONS ON USS GUARDIAN IOT MINIMIZE THE NEGATIVE ENVIRONMENTAL IMPACTS ON THE TUBATTAHA REEF AND SULU SEA WHILE ENSURING THE SECURITY OF US INTEREST, PROPERTY, AND CAPABILITIES. GENTEXT/EXECUTION//

4. COMMANDER'S INTENT.

A. PURPOSE:

THE PURPOSE OF THIS OPERATION IS TO RECOVER THE USS GUARDIAN, MAINTAINING THE SAFETY OF THE CREW AND SALVAGE TEAM, AND MINIMIZING THE ENVIRONMENTAL IMPACTS DUE TO GROUNDING ON TUBATTAHA REEF.

B. METHOD:

1) MY DESIRE IS TO SECURE USS GUARDIAN WITH THREE PRIMARY FOCUS AREAS:

- A) ESSENTIAL MANNING AND CREW ACCOUNTABILITY;
- B) ENABLERS FOR STABILITY AND CONTAINMENT SUCH AS COMMAND AND CONTROL AND LOGISTICS;
- C) USN ASSETS (CTF 72, 73, 76) AND RP CIVILIAN AND NAVAL FORCES STAGED TO CONDUCT A SAFE AND SUCCESSFUL SALVAGE AND RECOVERY OPERATION.

2) THIS OPERATION MUST PRESERVE THE STRATEGIC ALLIANCE WITH THE RP AND TAKE ALL NECESSARY STEPS TO MINIMIZE DAMAGE TO RP SOVEREIGN TERRITORY.

3) WE WILL EXECUTE THIS OPERATION THROUGH A SUPPORTED/SUPPORTING RELATIONSHIP, WHICH WILL BE INCLUSIVE AND ACCOMMODATING OF RP INTERESTS. WE WILL INTEGRATE OUR OPERATION WITH U.S. GOVERNMENTAL AND INTERNATIONAL NON-GOVERNMENTAL ORGANIZATIONS THAT ARE

EXERCISING OTHER MEANS TO BRING THIS CRISIS TO CONCLUSION. OUR COMMAND STRUCTURE WILL BE CLEAR, AND OUR CONTROL WILL PERMIT FULL AND EFFECTIVE COORDINATION AMONG SUBORDINATE ELEMENTS.

4) WE WILL LEVERAGE ALL THE CAPABILITIES IN SEVENTH FLEET. SPEED AND TIMING ARE ESSENTIAL-TAKE FULL ADVANTAGE OF EVERY OPPORTUNITY IOT GAIN MOMENTUM TO CONTROL THE CRISIS AND ACCELERATE ACTIONS WITHOUT COMPROMISING SAFETY. I EXPECT MY SUBORDINATE COMMANDERS TO PROVIDE THOROUGH SOLUTIONS THAT ARE PRACTICAL AND TIMELY.

D) OPERATION GUARDIAN WILL BE CONDUCTED THROUGH FOUR PHASES: 1- CRISIS CONTROL AND IMMEDIATE - CTF 76 IS THE MAIN EFFORT AND THE SUPPORTED COMMANDER. 2- STABILIZATION - CTF 76 IS THE MAIN EFFORT AND SUPPORTED COMMANDER. 3- SALVAGE AND RECOVERY - CTF 73 IS THE MAIN EFFORT AND SUPPORTED COMMANDER. 4- TRANSITION - C7F IS THAT MAIN EFFORT AND TRANSITIONS THE ROLE OF LEAD AGENT TO COMPACLFT.

C. ENDSTATE:

THE END STATE FOR OUR OPERATION IS THE SAFE RECOVERY AND SALVAGE OF THE USS GUARDIAN AND ANY ENVIRONMENTAL IMPACT IS APPROPRIATELY MITIGATED. OPPORTUNITIES TO ADVANCE AND BUILD TRUST WITH THE RP THROUGHOUT THIS OPERATION SHOULD BE SOUGHT AND CAPITALIZED, AND LONG TERM MITIGATION EFFORTS ARE APPROPRIATELY TRANSITIONED TO COMMANDER, U.S. PACIFIC FLEET.

D. LIMITATIONS:

- 1) PROTECT ANY REMAINING CLASSIFIED MATERIAL AND VITAL U.S. GOVERNMENT PROPERTY.
 - 2) MINIMIZE IMPACT TO OTHER COMSEVENTHFLT OPERATIONS.
 - 3) CONDUCT PLANNING AT THE UNCLASSIFIED LEVEL TO THE MAXIMUM EXTENT POSSIBLE.
 - 4)DO NOT CAUSE UNNECESSARY ENVIRONMENTAL DAMAGE DURING RECOVERY/SALVAGE OPERATIONS.
 - 5)DO NOT PUT OTHER ASSETS IN EXTREMIS DURING RECOVER OPERATIONS.
5. CONCEPT OF OPERATIONS.
- A. PHASE I. CRISIS CONTROL AND IMMEDIATE ACTIONS. DURING THIS PHASE, CTG OP GUARDIAN IS DESIGNATED AS THE MAIN EFFORT (ME). MY PRIORITIES FOR THIS PHASE ARE (1) SAFETY OF THE CREW; (2) MITIGATION OF ENVIRONMENTAL DAMAGE; AND, (3) ESTABLISHMENT OF COMMAND AND CONTROL. THE ESSENTIAL TASKS DURING THIS PHASE ARE THE ESTABLISHMENT OF COMMAND AND CONTROL, SECURITY, AND ENVIRONMENTAL PROTECTION. THIS PHASE ENDS WHEN ENVIRONMENTAL PROTECTION MEASURES ARE IN PLACE AND A FORWARD COMMAND ELEMENT IS ESTABLISHED AND FUNCTIONAL.
- B. PHASE II. STABILIZATION. DURING THIS PHASE, CTG OP GUARDIAN REMAINS THE MAIN EFFORT. MY PRIORITY FOR THIS PHASE IS PREVENTION OF ANY ADDITIONAL ENVIRONMENTAL DAMAGE BEYOND THE INITIAL GROUNDING OF GUARDIAN. THE ESSENTIAL TASKS ARE TO DEVELOP A SALVAGE PLAN AND ENVIRONMENTAL CONTROL MEASURES. THIS PHASE ENDS ONCE THERE IS AN APPROVED SALVAGE PLAN, THE CREW IS SAFELY RETURNED TO HOMEPORT WITH COUNSELING PROVIDED, RISK OF WIDE-SPREAD ENVIRONMENTAL DAMAGE IS MITIGATED, AND SHIP HAS BEEN DEFUELED AND OTHERWISE SECURED.
- C. PHASE III. RECOVERY AND SALVAGE. DURING THIS PHASE, CTF 73 IS DESIGNATED AS COMMANDER, CTG OP GUARDIAN. MY PRIORITY FOR THIS PHASE IS REMOVAL OF USS GUARDIAN FROM THE REEF. THE ESSENTIAL TASKS DURING THIS PHASE ARE TO REMOVE GUARDIAN FROM THE REEF AND DEVELOP A FINAL DISPOSITION AND ENVIRONMENTAL RECOVERY PLAN. THIS PHASE ENDS WITH THE REMOVAL OF USS GUARDIAN FROM THE REEF AND THE ENVIRONMENTAL RECOVERY PLAN IS APPROVED.
- D. PHASE IV. TRANSITION. DURING THIS PHASE, COMSEVENTHFLT IS THE MAIN EFFORT. MY PRIORITY FOR THIS PHASE IS THE TRANSITION TO NORMAL OPERATIONS. THE ESSENTIAL TASKS ARE TO SUPPORT ALL LEGAL AND SAFETY INVESTIGATIONS, IMPLEMENT AN ENVIRONMENTAL RECOVERY PLAN, RESOLVE CLAIMS AGAINST THE U.S. GOVERNMENT, AND CONTINUE PUBLIC AFFAIRS (PA) EFFORTS. THIS PHASE ENDS WHEN COMPACFLT HAS ASSUMED DUTIES AND RESPONSIBILITIES AS THE LEAD AGENT.
6. TASKS
- A. PHASE I. CRISIS CONTROL AND IMMEDIATE ACTIONS.
- 1) CTG OP GUARDIAN
 - A) ESTABLISH A FORWARD COMMAND ELEMENT.
 - B) ASSUME OPCON OF USS GUARDIAN, USS MUSTIN, AND USNS BOWDITCH
 - C) O/O ASSUME OPCON OF MDSU ONE
 - 2) CTF-76
 - A) ASSUME DUTIES AND RESPONSIBILITIES AS COMMANDER, CTG OP GUARDIAN.
 - B) CONDUCT PLANNING IOT REDEPLOY THE USS GUARDIAN CREW.
 - C) SHIFT OPCON OF USS GUARDIAN TO CTG OP GUARDIAN.
 - 3) CTF-73
 - A) CONDUCT PLANNING AND COORDINATION IOT CONDUCT RECOVERY AND SALVAGE OPERATIONS.
 - 4) CTF-72
 - A) CONDUCT ENVIRONMENTAL SURVEY OPERATIONS ISO OPERATION GUARDIAN.
 - B) ESTABLISH A FORWARD OPERATING BASE IOT MAINTAIN PRESENCE AND AWARENESS.
 - 5) MDSU ONE
 - A) O/O DEPLOY TO PUERTO PRINCESA IOT SUPPORT OPERATION GUARDIAN.
 - B) O/O SHIFT TACON TO CTF 73.
 - 6) CTF-70
 - A) SHIFT OPCON OF USS MUSTIN TO CTG OP GUARDIAN.
 - 7) CTF-74
 - A) SHIFT OPCON OF USNS BOWDITCH TO CTG OP GUARDIAN.

B. PHASE II. STABILIZATION.

1) CTG OP GUARDIAN

A) ESTABLISH ENVIRONMENTAL PROTECTION AND CONTAINMENT MEASURES SUCH AS BOOMS AND DIAPERS IOT PREPARE FOR RECOVERY AND SALVAGE OPERATIONS.

B) CONDUCT SECURITY OPERATIONS ISO OPERATION GUARDIAN.

2) CTF-73

A) SUBMIT SALVAGE PLAN CONOPS TO C7F FOR APPROVAL.

B) O/O ASSUME DUTIES AND RESPONSIBILITIES AS COMMANDER CTG OP GUARDIAN.

3) CTF-72

A) CONDUCT ENVIRONMENTAL SURVEY OPERATIONS ISO OPERATION GUARDIAN.

4) CTF-76

A) REDEPLOY NON ESSENTIAL CREW OF USS GUARDIAN.

C. PHASE III. RECOVERY AND SALVAGE.

1) CTG OP GUARDIAN

A) EXECUTE SALVAGE PLAN IOT REMOVE USS GUARDIAN FROM REEF.

B) CONDUCT ENVIRONMENTAL PROTECTION AND CONTAINMENT MEASURES IOT MINIMIZE ENVIRONMENTAL IMPACT.

2) CTF-73

A) ASSUME DUTIES AND RESPONSIBILITIES AS COMMANDER, CTG OP GUARDIAN.

B) CONDUCT PLANNING AND COORDINATION IOT TO CREATE ENVIRONMENTAL RECOVERY PLAN.

3) CTF-72

A) CONDUCT ENVIRONMENTAL SURVEY OPERATIONS ISO OPERATION GUARDIAN.

D. PHASE IV. TRANSITION.

1) C7F

A) EXECUTE ENVIRONMENTAL RECOVERY PLAN IOT MITIGATE ENVIRONMENTAL IMPACT.

B) SUPPORT ALL INVESTIGATIONS.

2) CTF 73

A) O/O DISESTABLISH CTG OP GUARDIAN.

7. COORDINATING INSTRUCTIONS

A. PROPOSED C-DAY, L-HOUR: TBD.

B. ANTICIPATED LENGTH OF OPERATION: TBD.

C. ROE. CJCS SROE AND USPACOM THEATER ANNEX TO THE SROE ARE IN EFFECT.

D. FORCE PROTECTION. CONSIDERATION WILL BE GIVEN TO FORCE PROTECTION AND THREATS IN THE THEATER OF OPERATIONS. COMSEVENTHFLT WILL DESIGNATE APPROPRIATE BRIEFINGS AND ACTIONS NEEDED TO BE TAKEN TO MINIMIZE POTENTIAL THREAT TO PERSONNEL.

E. ASSUMPTIONS

1) PARTIES FROM OTHER THAN U.S. AND CONTRACTORS WILL NOT INTERFERE WITH RECOVERY OR SECURITY OPERATIONS.

2) USS GUARDIAN PERSONNEL WILL BE OUT OF HARMS WAY PRIOR TO THE COMMENCEMENT OF RECOVERY/SALVAGE OPERATIONS.

3) USS GUARDIAN WILL REMAIN INTACT AND UPRIGHT LONG ENOUGH TO ALLOW FOR RECOVERY OPERATIONS.

4) ENVIRONMENTAL DAMAGE WILL BE LIMITED TO DAMAGE TO THE REEF CAUSED BY GROUNDING AND SUBSEQUENT MOVEMENT OF GUARDIAN.

F. OPERATIONS AREA. SULU SEA.

G. DIRLAUTH ALCON. KEEP COMSEVENTHFLT INFORMED.

GENTEXT/ADMIN AND LOG//

8. ADMIN

A. PUBLIC AFFAIRS GUIDANCE. PUBLIC RELEASE OF INFORMATION ABOUT THIS OPERATION IS NOT AUTHORIZED UNTIL ANNOUNCEMENT AND AUTHORIZATION OF THE OPERATION IS GRANTED BY COMSEVENTHFLT. UPON PUBLIC ANNOUNCEMENT, PLAN FOR AN ACTIVE PA POSTURE. PUBLIC AND NEWS MEDIA INQUIRIES CONCERNING THIS OPERATION SHOULD BE TAKEN AND REFERRED TO COMSEVENTHFLT. PROPOSED PA GUIDANCE WILL BE PROVIDED SEPCOR.

B. PERSONNEL. CTF 76 SUBMIT DAILY REPORT OF USS GUARDIAN SAILORS LOCATION AND EMPLOYMENT.

C. REPORTING CRITERIA. CTFS ARE TO PROVIDE CTG OP GUARDIAN A STANDARD QUAD SLIDE DETAILING THEIR CURRENT ACTIONS AND PLANNED FUTURE ACTIONS ISO OPERATION GUARDIAN FOR CONSOLIDATION AND INCLUSION IN THE DAILY C7F CUB. CTG OP GUARDIAN SHALL SUBMIT THE CONSOLIDATED SLIDE WITH THE REGULAR CUB SUBMISSION.

D. INFORMATION OPERATIONS GUIDANCE. PLAN TO CONDUCT OPERATIONS TO GAIN AND MAINTAIN INTERNATIONAL AND DOMESTIC SUPPORT FOR THE RECOVERY OF THE VESSEL AND CREW. PLANNING WILL ALSO ADDRESS POST-MISSION INFORMATION OPERATIONS CONSIDERATIONS.

E. CLASSIFICATION GUIDANCE. PLANNING FOR THIS OPERATION IS UNCLASSIFIED. DISCLOSURE OF INFORMATION REGARDING THIS PLANNING IS AT THE DISCRETION OF THE SUPPORTED COMMANDER OR HIS DESIGNATED REPRESENTATIVE.

9. LOGISTICS.

A. KNOWN LOGISTICS RESTRAINTS: NONE.

B. CTF 73 WILL COORDINATE RAS FOR U/W UNITS.

C. NO ESCORTS OR EVASIVE ACTIONS ARE EXPECTED FOR LOG FORCE ASSETS.

D. CTFS WILL IDENTIFY AND REPORT SHORTFALLS OF CRITICAL SUPPLY ITEMS AND MAINTENANCE TO COMSEVENTHFLT.

E. SOCPAC AND JSOTF-P WILL CAPTURE COSTS AND REPORT THROUGH APPROPRIATE CHANNELS.
GENTEXT/COMMAND AND SIGNAL//

10. COMMAND AND CONTROL. DURING PHASE I AND PHASE II CTF 76 IS CTG OP GUARDIAN. UPON THE TRANSITION TO PHASE III CTF 73 BECOMES CTG OP GUARDIAN.

11. COMMUNICATIONS

A. CONNECTIVITY. ALL RECOVERY AND SALVAGE OPERATIONS WILL BE COORDINATED IN THE CTF 76 CHATROOM.
DECL/19JAN2036//

BT

O 240230Z JAN 13 PSN 628956K36

FM COMPACFLT PEARL HARBOR HI
TO RUCOWCA/CCGDFOURTEEN HONOLULU HI
INFO ZEN/HQ USPACOM HONOLULU HI
RUENAAA/CNO WASHINGTON DC
RUWDQAA/COMPACAREA COGARD ALAMEDA CA
RHOVVKG/COMSEVENTHFLT
ZEN/COMTHIRDFLT
RHOVNGW/CTF 70
ZEN/CTF 72
ZEN/CTF 73
ZEN/CTF 74
ZEN/CTF 76
ZEN/COMNAVSURFPAC SAN DIEGO CA
RUALSFJ/COMUSJAPAN YOKOTA AB JA
RUALSFJ/COMUSJAPAN COMMAND CENTER YOKOTA AB JA
ZEN/COMNAVFORJAPAN YOKOSUKA JA
ZEN/COMEXSTRIKGRU SEVEN
ZEN/COMLOG WESTPAC
RHOVHHL/COMPHIBRON ELEVEN
ZEN/COMCMRON SEVEN
RUZDEAK/USDAO MANILA RP
RULSSEA/COMNAVSEASYS COM WASHINGTON DC
RHOVBTX/USS GUARDIAN
ZEN/COMPACFLT PEARL HARBOR HI

BT

UNCLAS

MSGID/GENADMIN/COMPACFLT/-/JAN//

SUBJ/OPERATION GUARDIAN REQUEST FOR SUPPORT (U)//

REF/A/GENADMIN/C7F/ 220730ZJAN13//

REF/B/EMAIL/D14/22JAN13//

AMPN/REF A IS C7F REQUEST FOR CG LNO. REF B IS FEASIBILITY OF
SUPPORT COORDINATION EMAIL WITH D14 COMMAND CENTER.//

RMKS/

TIMEZONE/Z//

GENTEXT/SITUATION/

1. AT 170223HJAN13 USS GUARDIAN RAN AGROUND IN THE SULU SEA AND IS IN IMMINENT DANGER OF A HULL BREACH WHICH COULD CAUSE SIGNIFICANT ENVIRONMENTAL DAMAGE TO THE TUBATTAHA REEF AND SURROUNDING AREA.

1.A. AS THE TUBATTAHA REEF IS A UNESCO DESIGNATED WORLD HERITAGE SITE, ACTIONS WILL BE TAKEN TO MINIMIZE THE ENVIRONMENTAL IMPACT TO THE REEF DURING RECOVERY OPERATIONS. IAW REF A AND AS COORDINATED VIA REF B, A USCG MARINE ENVIRONMENTAL RESPONSE OFFICER IS REQUIRED TO ADVISE COMMANDER, TASK GROUP OP GUARDIAN, ON ENVIRONMENTAL ISSUES.

1.B. USCG LIAISON WILL REPORT DIRECTLY TO COMMANDER, TG OP GUARDIAN.

1.C. DEPLOYMENT WILL BE UNDER TITLE 10 AUTHORITIES.//

GENTEXT/MISSION/

2. MISSION. CTG OP GUARDIAN CONDUCTS EXPEDITIOUS RECOVERY AND SALVAGE OPERATIONS ON USS GUARDIAN IOT MINIMIZE THE NEGATIVE ENVIRONMENTAL IMPACTS ON THE TUBATTAHA REEF AND SULU SEA WHILE ENSURING THE SECURITY OF U.S. INTERESTS, PROPERTY, AND CAPABILITIES.

3. FORCE REQUIREMENTS.

3.A. ONE (1) USCG O-6 ENVIRONMENTAL RESPONSE OFFICER CAPABLE OF ASSESSING THE USS GUARDIAN GROUNDING ENVIRONMENTAL IMPACT AND ABLE TO ADVISE COMMANDER, TG GUARDIAN ON TTPS TO MINIMIZE ENVIRONMENTAL DAMAGE DURING RECOVERY OPERATIONS.

4. DESTINATION. PUERTO PRINCESA, RP.
GEOLOC: RPVP.

5. DATE REQUIRED. AS SOON AS POSSIBLE, NO LATER THAN 24 JAN 13.

6. DURATION. UNTIL COMPLETION OF USS GUARDIAN RECOVERY OR UNTIL DETERMINED BY COMMANDER, TG GUARDIAN.

7. MISSION JUSTIFICATION. RISK: H - HIGH PROFILE MISSION.

8. SIMILAR CAPABILITIES. NONE, C7F HAS NO ORGANIC ENVIRONMENTAL RESPONSE CAPABILITY.

9. SPECIALIZED REQUIREMENTS: NONE.//
GENTEXT/ADMIN AND LOGISTICS/

10. ESTIMATED LOGISTICS REQUIREMENTS: GTR, TRANSPORTATION, LODGING, SUBSISTENCE.

10.A. POC AND COMMERCIAL NUMBER IN COUNTRY IS LSC (Removed to protect PII).

10.B. DEPLOYING PERSONNEL SHOULD EXPECT TO EMBARK A U.S. NAVY SHIP TO INSPECT THE INCIDENT AREA.

11. FUNDING. CPF WILL FUND TDY COSTS ASSOCIATED WITH 1 X CG LNO THROUGH CROSS ORDER LOA FOR DTS USE. CONTACT (Removed to protect PII)

12. THREAT INFORMATION / FORCE PROTECTION GUIDANCE. THE TERRORIST THREAT FOR AREAS IN WHICH INDIVIDUALS OR UNITS WILL DEPLOY HAS BEEN REVIEWED. DEPLOYMENT OF PERSONNEL IS CERTIFIED TO BE NECESSARY FOR MISSION ACCOMPLISHMENT. ALL DEPLOYED PERSONNEL WILL COMPLY WITH APPLICABLE FP MEASURES IAW USPACOM OPOD 5050-08. REFER TO USPACOM WEB SITE HTTP ://PSP.HQ.PACOM.SMIL.MIL/ORGAREAS/J3/J34/PAGES/DEFAULT.ASPX FOR ADDITIONAL INFORMATION.//

13. PUBLIC AFFAIRS GUIDANCE. NO PUBLIC RELEASE OF INFORMATION REGARDING THIS RFS IS AUTHORIZED. REFER ALL QUERIES WITHOUT COMMENT TO COMSEVENTHFLT PAO FOR COORDINATION.//
GENTEXT/COMMAND AND SIGNAL/

14. CDRUSPACOM IS THE SUPPORTED COMBATANT COMMANDER. COMPACFLT IS THE SUPPORTED COMPONENT COMMANDER. C7F IS THE SUPPORTED OPERATIONAL COMMANDER. CTG OPERATION GUARDIAN IS THE SUPPORTED MISSION COMMANDER.

15. POINTS OF CONTACT

15.A COMPACFLT

15.A.1. CPF N336 (Removed to protect PII)

15.B. SEVENTHFLT

15.B.1. SEVENTHFLT N3: (Removed to protect PII)

15.B.2. SEVENTHFLT N3B: (Removed to protect PII)

15.B.3. SEVENTHFLT FUTURE OPS: (Removed to protect PII)

15.B.4. SEVENTHFLT WATCH CAPTAIN, DSN 315-453-2898; EMAIL: BWC(AT)C7F.NAVY.SMIL.MIL//

BT

O 310146Z JAN 13 PSN 747683K35

FM COMSEVENTHFLT

TO RHOVNGW/CTF 70

RHMFISS/CTF 72

RUOIAAA/CTF 73

RUAYIAA/CTF 74

RHMFISS/CTF 76

INFO RHMFISS/HQ USPACOM HONOLULU HI

RUOIAAA/COMPACFLT PEARL HARBOR HI

RHMFISS/COMPACFLT PEARL HARBOR HI

RUOIAAA/COMPACFLT PEARL HARBOR HI

RHMFISS/COMPACFLT PEARL HARBOR HI

RUOIAAA/COMNAVSURFPAC SAN DIEGO CA

RUALSFJ/COMUSJAPAN YOKOTA AB JA

RUBDPLA/COMUSJAPAN COMMAND CENTER YOKOTA AB JA RHMFISS

RUOIAEB/COMNAVFORJAPAN YOKOSUKA JA

RUOIAAA/COMEXSTRIKGRU SEVEN

RUOIAAA/COMLOG WESTPAC

RHOVHHL/COMPHIBRON ELEVEN

RUOIAAA/COMCMRON SEVEN

RUZDEAK/USDAO MANILA RP

RUEHML/USDAO MANILA RP

RUZDEAK/USDAO MANILA RP

RUEHML/USDAO MANILA RP

RUOIAAA/COMNAVSEASYS COM WASHINGTON DC

RHMFISS/COMNAVSEASYS COM WASHINGTON DC

RUOIAAA/COMNAVSEASYS COM WASHINGTON DC

RHMFISS/COMNAVSEASYS COM WASHINGTON DC

RUOIAAA/JSOTF PHILIPPINES

RHOVVKG/COMSEVENTHFLT

BT

UNCLAS

MSGID/OPORD/COMSEVENTHFLT/016//

SUBJ/FRAGMENTARY ORDER 004 TO OPERATION GUARDIAN OPORDER//

REF/A/DOC/COMSEVENTHFLT/19AUG12//

REF/B/MSG/GUARDIAN/162046ZJAN2013//

REF/C/MSG/COMSEVENTHFLT/191021ZJAN2013//

REF/D/MSG/COMSEVENTHFLT/201008ZJAN2013//

REF/E/MSG/COMSEVENTHFLT/221009ZJAN2013//

REF/F/MSG/COMSEVENTHFLT/251000ZJAN2013//

RMV/ REF A IS COMSEVENTHFLT OPORD 201. REF B IS GUARDIAN INITIAL NAVY BLUE OPREP MESSAGE. REF C IS OP GUARDIAN OPORDER. REF D IS OP GUARDIAN FRAGORD 001. REF E IS OP GUARDIAN FRAGORD 002. REF F IS OP GUARDIAN FRAGORD 003.//

POC/WEBER/CDR/COMSEVETHFLT/USS BLUE RIDGE/TEL: DSN 315-243-7719

EMAIL: C7F BWC/C7FBWC(AT)C7F.NAVY.(SMIL).MIL//

ORDTYP/FRAGORD/COMSEVENTHFLT//

NARR/THIS SEVENTHFLT FRAGMENTARY ORDER MODIFIES REF C//

TIMEZONE/Z//

GENTEXT/AUTHORITY/

1. THIS IS AN OPERATIONS ORDER DIRECTING COMSEVENTHFLT ASSET ACTIONS DURING SALVAGE OPERATIONS OF USS GUARDIAN IN THE SULU SEA.//

/TASK ORGANIZATION - CHANGE TO FOLLOWING:// /UNIT /UNITLOC /COMMENTS

/CTG OP GUARDIAN /YOKOSUKA, JAPAN /VADM SWIFT /CTU OP GUARDIAN /PALAWAN, RP /CAPT GILBERT
COMMAND ELEMENT (ASHORE)

/CTU OP GUARDIAN /EN ROUTE SULU SEA/CAPT MATTHEWS, OSC
SALVAGE ELEMENT

/CTU OP GUARDIAN.1 /SULU SEA/USS GUARDIAN

/CTU OP GUARDIAN.2 /SULU SEA /MUDSU DET ONE

/CTU OP GUARDIAN.3 /SULU SEA /USNS WALLY SCHIRRA

/CTU OP GUARDIAN.4 /SULU SEA /USNS SALVOR

/CTU OP GUARDIAN.5 /EN ROUTE SULU SEA/FRSS (IF REQ'D)

GENTEXT/SITUATION//

2. GENERAL. NO CHANGE.//

GENTEXT/MISSION//

3. MISSION STATEMENT. NO CHANGE.

GENTEXT/EXECUTION//

4. COMMANDER'S INTENT. NO CHANGE.

A. PURPOSE: NO CHANGE.

B. METHOD: NO CHANGE.

C. ENDSTATE: NO CHANGE.

D. LIMITATIONS: NO CHANGE.

5. CONCEPT OF OPERATIONS. NO CHANGE.

A. PHASE I. CRISIS CONTROL AND IMMEDIATE ACTIONS. NO CHANGE.

B. PHASE II. STABILIZATION. NO CHANGE.

C. PHASE III. RECOVERY AND SALVAGE. NO CHANGE.

D. PHASE IV. TRANSITION. NO CHANGE.

6. TASKS. NO CHANGE.

A. PHASE I. CRISIS CONTROL AND IMMEDIATE ACTIONS. NO CHANGE.

1) CTG OP GUARDIAN. NO CHANGE.

A) NO CHANGE.

B) NO CHANGE.

C) NO CHANGE.

2) CTF-76. NO CHANGE.

A) NO CHANGE.

B) NO CHANGE.

C) NO CHANGE.

3) CTF-73. NO CHANGE.

A) NO CHANGE.

4) CTF-72. NO CHANGE.

A) NO CHANGE.

B) NO CHANGE.

5) MDSU ONE. NO CHANGE.

A) NO CHANGE.

B) NO CHANGE.

6) CTF-70. NO CHANGE.

A) NO CHANGE.

7) CTF-74. NO CHANGE.

A) NO CHANGE.

B. PHASE II. STABILIZATION. NO CHANGE.

1) CTG OP GUARDIAN. NO CHANGE.

A) NO CHANGE.

B) NO CHANGE.

2) CTF-73. NO CHANGE.

A) NO CHANGE.

B) NO CHANGE.

3) CTF-72. NO CHANGE.
A) NO CHANGE.

4) CTF-76. NO CHANGE.
A) NO CHANGE.

C. PHASE III. RECOVERY AND SALVAGE.
1) CTG OP GUARDIAN. CHANGE TO READ:
A) C7F ASSUMES DUTIES AS CTG OP GUA.
B) EXECUTE SALVAGE PLAN IOT REMOVE USS GUARDIAN FROM REEF.
C) CONDUCT ENVIRONMENTAL PROTECTION AND CONTAINMENT MEASURES IOT MINIMIZE ENVIRONMENTAL IMPACT.

2) CTF-73. CHANGE TO READ:
A) ASSUME DUTIES AND RESPONSIBILITIES AS CTU OP GUARDIAN COMMAND ELEMENT ASHORE LED BY AN O-6.
B) ORGANIZE CTU OP GUA SALVAGE ELEMENT LEAD BY THE ON SCENE COMMANDER, THE NAVSEA SALVAGE OFFICER.
C) CONDUCT PLANNING AND COORDINATION IOT CREATE ENVIRONMENTAL RECOVERY PLAN.
D) EXECUTE SALVAGE PLAN IOT REMOVE USS GUARDIAN FROM REEF.

3) CTF-72. NO CHANGE.
A) NO CHANGE.

D. PHASE IV. TRANSITION. NO CHANGE.
1) C7F. NO CHANGE.
A) O/O DISESTABLISH CTG OP GUARDIAN.
B) NO CHANGE.

2) CTF 73. CHANGE TO READ:
A) O/O DISESTABLISH CTU OP GUARDIAN COMMAND ELEMENT ASHORE AND SALVAGE ELEMENT.

7. COORDINATING INSTRUCTIONS. NO CHANGE.
A. PROPOSED C-DAY, L-HOUR: TBD. NO CHANGE.
B. ANTICIPATED LENGTH OF OPERATION: TBD. NO CHANGE.
C. ROE. NO CHANGE.
D. FORCE PROTECTION. NO CHANGE.
E. ASSUMPTIONS. NO CHANGE.

1) NO CHANGE.
2) NO CHANGE.
3) NO CHANGE.
4) NO CHANGE.

F. OPERATIONS AREA. SULU SEA. NO CHANGE.
G. DIRLAUTH ALCON. KEEP COMSEVENTHFLT INFORMED. NO CHANGE.
H. ALL SITUATIONAL REPORTS WILL BE MADE VIA CHAIN OF COMMAND WATCH FLOORS FOR OFFICIAL RECORD KEEPING PURPOSES AND BATTLE RHYTHM. NO CHANGE.
I. RFI GUIDANCE. NO CHANGE.
1) NO CHANGE.
2) NO CHANGE.

GENTEXT/ADMIN AND LOG//

8. ADMIN. NO CHANGE.
A. PUBLIC AFFAIRS GUIDANCE. NO CHANGE.
1) NO CHANGE.
2) NO CHANGE.
3) NO CHANGE.
4) NO CHANGE.
5) NO CHANGE.

B. PERSONNEL. NO CHANGE.
C. REPORTING CRITERIA. CTU OP GUARDIAN COMMAND ELEMENT ASHORE WILL PROVIDE A COMBINED (WITH CTU OP GUA SALVAGE ELEMENT) SITUATIONAL REPORT UPDATE VIA EMAIL TO CPF AND C7F BWC BY 0900ZAS

WELL AS POST THE DAILY UPDATE BRIEF TO THE CTF 73 CAS PAGE BY 0800Z. THERE WILL NO LONGER BE A REQUIREMENT FOR A DAILY VTC. CTU OP GUA COMMAND ELEMENT WILL LEAD A DAILY TELCON TO CPF AND CTG OP GUARDIAN AT 0100Z, WITH REPRESENTATION FROM NAVSEA.

D. INFORMATION OPERATIONS GUIDANCE. NO CHANGE.

E. CLASSIFICATION GUIDANCE. NO CHANGE.

9. LOGISTICS. NO CHANGE.

A. NO CHANGE.

B. NO CHANGE.

C. NO CHANGE.

D. NO CHANGE.

E. NO CHANGE.

GENTEXT/COMMAND AND SIGNAL//

10. COMMAND AND CONTROL. CHANGE TO READ:

A. DURING PHASE 1 AND 2 COMSEVENTHFLT IS THE SUPPORTED COMMANDER. CTG OP GUA, CTF76, IS OPCON TO COMSEVENTH FLT. CTU OP GUA, CTF73, IS OPCON TO CTG OP GUA. CTU OP GUA.1, USS GUARDIAN; CTU OP GUA.3, USS MUSTIN; AND CTU OP GUA.6, COMMAND ELEMENT ASHORE, ARE OPCON TO CTU OP GUA. CTF 72 IS TACON OF P-3 DET GUA AND SUPPORTING CTU OP GUA. CTF 73 IS TACON OF USNS SALVOR AND MDSU DET ONE, WHILE SUPPORTING CTU OP GUA. NAVSEA IS SUPPORTING CTU OP GUA AND COORDINATING/CONTRACTING MSV CHAMPION AND MT TRABAJADOR.

B. DURING PHASE 3 AND 4 COMSEVENTHFLT WILL BE CTG OP GUA, THE SUPPORTED COMMANDERS ARE CTU OP GUA COMMAND ELEMENT (ASHORE), CAPT GILBERT OF CTF73, OPCON TO CTG OP GUA; AND CTU OP GUA SALVAGE ELEMENT (ON SCENE COMMANDER), CAPT MATTHEWS, NAVSEA SUPSALVAGE, ISTACON TO CTG OP GUA. CTU OP GUA.1, USS GUARDIAN; CTE OP GUA.2, MDSU DET ONE; CTE OP GUA.3, USNS WALLY SHIRRA; CTE OP GUA.4, USNS SALVOR; AND CTE OP GUA.5, FRSS, ARE TACON TO CTU OP GUA COMMAND ELEMENT ASHORE AND SUPPORTING CTU OP GUA SALVAGE ELEMENT. NAVSEA IS SUPPORTING CTU OP GUA SALVAGE ELEMENT AND COORDINATING WITH CTU OP GUA COMMAND ELEMENT ASHORE. JUSMAG AND RP FORCES ARE COORDINATING WITH CTU OP GUA COMMAND ELEMENT. SALVAGE ASSETS, MT TRABAJADOR, VOS APOLLO, BORNEO AND JASCON ARE CONTRACTED TO CTU OP GUA SALVAGE ELEMENT.

C. COMMAND AND CONTROL SLIDES POSTED ON THE OPERATION GUARDIAN CAS WEBSITE.

11. COMMUNICATIONS. NO CHANGE.

A. NO CHANGE.

B. NO CHANGE.

12. KNOWLEDGE AND INFORMATION MANAGEMENT. NO CHANGE.

A. NO CHANGE.

B. NO CHANGE.

C. NO CHANGE.

D. NO CHANGE.//

DECL/28JAN36//

BT

O 010053Z APR 13 PSN 831733K25

FM COMSEVENTHFLT

TO RHOVNGW/CTF 70

RHMFISS/CTF 72

RUOIAAA/CTF 73

RUAYIAA/CTF 74

RHMFISS/CTF 76

INFO RHMFISS/HQ USPACOM HONOLULU HI

RUOIAAA/COMPACFLT PEARL HARBOR HI

RHMFISS/COMPACFLT PEARL HARBOR HI

RUOIAAA/COMPACFLT PEARL HARBOR HI

RHMFISS/COMPACFLT PEARL HARBOR HI

RUOIAAA/COMNAVSURFPAC SAN DIEGO CA

RUALSFJ/COMUSJAPAN YOKOTA AB JA

RUALSFJ/COMUSJAPAN COMMAND CENTER YOKOTA AB JA

RUOIAEB/COMNAVFORJAPAN YOKOSUKA JA

RUOIAAA/COMEXSTRIKGRU SEVEN

RUOIAAA/COMLOG WESTPAC

RHOVHHL/COMPHIBRON ELEVEN

RUOIAAA/COMCMRON SEVEN

RUZDEAK/USDAO MANILA RP

RUEHML/USDAO MANILA RP

RUZDEAK/USDAO MANILA RP

RUEHML/USDAO MANILA RP

RUOIAAA/COMNAVSEASYS COM WASHINGTON DC

RHMFISS/COMNAVSEASYS COM WASHINGTON DC

RUOIAAA/COMNAVSEASYS COM WASHINGTON DC

RHMFISS/COMNAVSEASYS COM WASHINGTON DC

RUOIAAA/JSOTF PHILIPPINES

RHOVVKG/COMSEVENTHFLT

BT

UNCLAS

MSGID/OPORD/COMSEVENTHFLT/051/APR//

SUBJ/FRAGMENTARY ORDER 006 TO OPERATION GUARDIAN OPORDER//

REF/A/DOC/COMSEVENTHFLT/13FEB13//

REF/B/MSG/GUARDIAN/162046ZJAN2013//

REF/C/MSG/C7F/191021ZJAN2013//

REF/D/MSG/C7F/201008ZJAN2013//

REF/E/MSG/C7F/221009ZJAN2013//

REF/F/MSG/C7F/251000ZJAN2013//

REF/G/MSG/C7F/310146ZJAN2013//

REF/H/MSG/C7F/132202ZFEB2013//

NARR/ REF A IS COMSEVENTHFLT OPORD 201. REF B IS GUARDIAN INITIAL NAVY BLUE OPREP MESSAGE. REF C IS COMSEVENTHFLT OPERATION GUARDIAN OPORD. REF D IS COMSEVENTHFLT OPERATION GUARDIAN OPORD FRAGO ONE. REF E IS COMSEVENTHFLT OPERATION GUARDIAN OPORD FRAGO TWO. REF F IS COMSEVENTHFLT OPERATION GUARDIAN OPORD FRAGO THREE. REF G IS COMSEVENTHFLT OPERATION GUARDIAN OPORD FRAGO FOUR. REF H IS COMSEVENTHFLT OPERATION GUARDIAN OPORD FRAGO FIVE.

POC/(Removed to protect PII)//LOC: USS BLUE RIDGE, YOKOSUKA

JAPAN/(Removed to protect PII)//

POC/C7F MOC CHIEF/C7FMOCCHIEF(AT)C7F.NAVY.SMIL.MIL//

ORDTYP/FRAGORD/COMSEVENTHFLT//

REPLACE ALL PARAGRAPHS IN REFS C-H WITH BELOW UNLESS OTHERWISE NOTED.

GENTEXT/AUTHORITY/

1. THIS IS A CONSOLIDATED OPERATIONS ORDER DIRECTING COMSEVENTHFLT ASSETS ACTIONS DURING RECOVER AND SALVAGE OPERATIONS OF USS GUARDIAN IN THE SULU SEA.//

/TASK ORGANIZATION//

/UNIT /UNITLOC /COMMENTS

/CTG OP GUARDIAN /YOKOSUKA, JAPAN/VADM SWIFT

/CTU OP GUARDIAN/PALAWAN, RP/CTF 73 DESIGNATED O-6

COMMAND ELEMENT

(ASHORE)

/CTU OP GUARDIAN/SULU SEA/CAPT MATTHEWS, OSC SALVAGE ELEMENT

/CTU OP GUARDIAN.1 /SULU SEA /USS GUARDIAN

/CTU OP GUARDIAN.2 /SULU SEA /MUDSU DET

/CTU OP GUARDIAN.3 /SULU SEA /USNS WASHINGTON CHAMBERS

/CTU OP GUARDIAN.4 /SULU SEA /USNS SAFEGUARD

GENTEXT/SITUATION//

2. GENERAL

AT 170223HJAN13 USS GUARDIAN RAN AGROUND IN THE SULU SEA AND IS HARD AGROUND, WHICH COULD CAUSE SIGNIFICANT ENVIRONMENTAL DAMAGE TO THE TUBATTAHA REEF AND SURROUNDING AREA. THE CREW IS SAFELY REMOVED. THE FOLLOWING VESSELS OR UNITS ARE ON STATION OR TRANSITING TO THE AREA TO PROVIDE ASSISTANCE:

-USNS SAFEGUARD

-USNS WASHINGTON CHAMBERS AND HELICOPTERS

-MDSU ONE

-MV INTREPID

-MV TRABAJADOR

-MV ARCHON TIDE

-SMIT BORNEO

-BARGE S-7000

-MV JASCON 25//

GENTEXT/MISSION//

3. MISSION STATEMENT. CTG OP GUARDIAN CONDUCTS EXPEDITIOUS RECOVERY AND SALVAGE OPERATIONS ON USS GUARDIAN IOT MINIMIZE THE NEGATIVE ENVIRONMENTAL IMPACTS ON THE TUBATTAHA REEF AND SULU SEA WHILE ENSURING THE SECURITY OF US INTEREST, PROPERTY, AND CAPABILITIES.

GENTEXT/EXECUTION//

4. COMMANDER'S INTENT.

A. PURPOSE:

THE PURPOSE OF THIS OPERATION IS TO RECOVER THE USS GUARDIAN, MAINTAINING THE SAFETY OF THE CREW AND SALVAGE TEAM, AND MINIMIZING THE ENVIRONMENTAL IMPACTS DUE TO GROUNDING ON TUBATTAHA REEF.

B. METHOD:

1) MY DESIRE IS TO SECURE USS GUARDIAN WITH THREE PRIMARY FOCUS AREAS:

A) ESSENTIAL MANNING AND CREW ACCOUNTABILITY;

B) ENABLERS FOR STABILITY AND CONTAINMENT SUCH AS COMMAND AND CONTROL AND LOGISTICS;

C) USN ASSETS AND RP CIVILIAN AND NAVAL FORCES STAGED TO CONDUCT A SAFE AND SUCCESSFUL SALVAGE AND RECOVERY OPERATION.

2) THIS OPERATION MUST PRESERVE THE STRATEGIC ALLIANCE WITH THE RP AND TAKE ALL NECESSARY STEPS TO MINIMIZE DAMAGE TO RP SOVEREIGN TERRITORY.

3) WE WILL EXECUTE THIS OPERATION THROUGH A SUPPORTED/SUPPORTING RELATIONSHIP, WHICH WILL BE INCLUSIVE AND ACCOMMODATING OF RP INTERESTS. WE WILL INTEGRATE OUR OPERATION WITH U.S. GOVERNMENTAL AND INTERNATIONAL NON-GOVERNMENTAL ORGANIZATIONS THAT ARE EXERCISING OTHER MEANS TO BRING THIS CRISIS TO CONCLUSION. OUR COMMAND STRUCTURE WILL BE CLEAR, AND OUR CONTROL WILL PERMIT FULL AND EFFECTIVE COORDINATION AMONG SUBORDINATE ELEMENTS.

4) WE WILL LEVERAGE ALL THE CAPABILITIES IN SEVENTH FLEET. SPEED AND TIMING ARE ESSENTIAL-TAKE FULL ADVANTAGE OF EVERY OPPORTUNITY IOT GAIN MOMENTUM TO CONTROL THE CRISIS AND ACCELERATE ACTIONS

WITHOUT COMPROMISING SAFETY. I EXPECT MY SUBORDINATE COMMANDERS TO PROVIDE THOROUGH SOLUTIONS THAT ARE PRACTICAL AND TIMELY.

5) OPERATION GUARDIAN WILL BE CONDUCTED THROUGH FOUR PHASES: 1- CRISIS CONTROL AND IMMEDIATE - CTF 76 IS THE MAIN EFFORT AND THE SUPPORTED COMMANDER. 2- STABILIZATION - CTF 76 IS THE MAIN EFFORT AND SUPPORTED COMMANDER. 3- SALVAGE AND RECOVERY - C7F IS THE MAIN EFFORT AND SUPPORTED COMMANDER. 4- TRANSITION - C7F IS THAT MAIN EFFORT AND TRANSITIONS THE ROLE OF LEAD AGENT TO COMPACFLT.

C. ENDSTATE:

THE END STATE FOR OUR OPERATION IS THE SAFE RECOVERY AND SALVAGE OF THE USS GUARDIAN AND ANY ENVIRONMENTAL IMPACT IS APPROPRIATELY MITIGATED. OPPORTUNITIES TO ADVANCE AND BUILD TRUST WITH THE RP THROUGHOUT THIS OPERATION SHOULD BE SOUGHT AND CAPITALIZED, AND LONG TERM MITIGATION EFFORTS ARE APPROPRIATELY TRANSITIONED TO COMMANDER, U.S. PACIFIC FLEET.

D. LIMITATIONS:

- 1) PROTECT ANY REMAINING CLASSIFIED MATERIAL AND VITAL U.S. GOVERNMENT PROPERTY.
- 2) MINIMIZE IMPACT TO OTHER COMSEVENTHFLT OPERATIONS.
- 3) CONDUCT PLANNING AT THE UNCLASSIFIED LEVEL TO THE MAXIMUM EXTENT POSSIBLE.
- 4) DO NOT CAUSE UNNECESSARY ENVIRONMENTAL DAMAGE DURING RECOVERY/SALVAGE OPERATIONS.
- 5) DO NOT PUT OTHER ASSETS IN EXTREMIS DURING RECOVER OPERATIONS.

5. CONCEPT OF OPERATIONS.

A. PHASE I. CRISIS CONTROL AND IMMEDIATE ACTIONS. DURING THIS PHASE, CTG OP GUARDIAN IS DESIGNATED AS THE MAIN EFFORT (ME). MY PRIORITIES FOR THIS PHASE ARE (1) SAFETY OF THE CREW; (2) MITIGATION OF ENVIRONMENTAL DAMAGE; AND, (3) ESTABLISHMENT OF COMMAND AND CONTROL. THE ESSENTIAL TASKS DURING THIS PHASE ARE THE ESTABLISHMENT OF COMMAND AND CONTROL, SECURITY, AND ENVIRONMENTAL PROTECTION. THIS PHASE ENDS WHEN ENVIRONMENTAL PROTECTION MEASURES ARE IN PLACE AND A FORWARD COMMAND ELEMENT IS ESTABLISHED AND FUNCTIONAL.

B. PHASE II. STABILIZATION. DURING THIS PHASE, CTG OP GUARDIAN REMAINS THE MAIN EFFORT. MY PRIORITY FOR THIS PHASE IS PREVENTION OF ANY ADDITIONAL ENVIRONMENTAL DAMAGE BEYOND THE INITIAL GROUNDING OF GUARDIAN. THE ESSENTIAL TASKS ARE TO DEVELOP A SALVAGE PLAN AND ENVIRONMENTAL CONTROL MEASURES. THIS PHASE ENDS ONCE THERE IS AN APPROVED SALVAGE PLAN, THE CREW IS SAFELY RETURNED TO HOMEPORT WITH COUNSELING PROVIDED, RISK OF WIDE-SPREAD ENVIRONMENTAL DAMAGE IS MITIGATED, AND SHIP HAS BEEN DEFUELED AND OTHERWISE SECURED.

C. PHASE III. RECOVERY AND SALVAGE. DURING THIS PHASE, C7F IS DESIGNATED AS COMMANDER, CTG OP GUARDIAN. MY PRIORITY FOR THIS PHASE IS REMOVAL OF USS GUARDIAN FROM THE REEF. THE ESSENTIAL TASKS DURING THIS PHASE ARE TO REMOVE GUARDIAN FROM THE REEF AND CONDUCT A MARINE ECOLOGICAL ASSESSMENT (MEA) THAT WILL INFORM AN ENVIRONMENTAL RECOVERY PLAN. THIS PHASE ENDS WITH THE REMOVAL OF USS GUARDIAN FROM THE REEF AND THE MEA IS COMPLETE.

D. PHASE IV. TRANSITION. DURING THIS PHASE, COMSEVENTHFLT IS THE MAIN EFFORT. MY PRIORITY FOR THIS PHASE IS THE TRANSITION TO NORMAL OPERATIONS. THE ESSENTIAL TASKS ARE TO SUPPORT ALL LEGAL AND SAFETY INVESTIGATIONS, IMPLEMENT AN ENVIRONMENTAL RECOVERY PLAN, RESOLVE CLAIMS AGAINST THE U.S. GOVERNMENT, AND CONTINUE PUBLIC AFFAIRS (PA) EFFORTS. THIS PHASE ENDS WHEN COMPACFLT HAS ASSUMED DUTIES AND RESPONSIBILITIES AS THE LEAD AGENT.

6. TASKS

A. PHASE I. NO CHANGE

B. PHASE II. NO CHANGE

C. PHASE III. RECOVERY AND SALVAGE.

1) CTG OP GUARDIAN.

A) C7F ASSUMES DUTIES AS CTG OP GUA.

B) EXECUTE SALVAGE PLAN IOT REMOVE USS GUARDIAN FROM REEF.

C) CONDUCT ENVIRONMENTAL PROTECTION AND CONTAINMENT MEASURES IOT MINIMIZE ENVIRONMENTAL IMPACT.

D) SUPPORT EXECUTION OF MARINE ECOLOGICAL ASSESSMENT.

E) O/O DISESTABLISH CTU OP GUARDIAN SALVAGE ELEMENT ONCE EXGUARDIAN SALVAGE IS COMPLETE.

2) CTF-73.

- A) ASSUME DUTIES AND RESPONSIBILITIES AS CTU OP GUARDIAN COMMAND ELEMENT ASHORE LED BY AN O-6.
 - B) ORGANIZE CTU OP GUA SALVAGE ELEMENT LEAD BY THE ON SCENE COMMANDER, THE NAVSEA SALVAGE OFFICER. CTU OP GUA SALVAGE ELEMENT LEAD IS ONLY REQUIRED FOR EXGUARDIAN SALVAGE, NOT FOR THE MARINE ECOLOGICAL ASSESSMENT (MEA).
 - C) CONDUCT PLANNING AND COORDINATION IOTSUPPORT DEVELOPMENT OF AN ENVIRONMENTAL RECOVERY PLAN.
 - D) EXECUTE SALVAGE PLAN IOT REMOVE USS GUARDIAN FROM REEF.
 - E) SUPPORT EXECUTION OF MEA.
- 3) CTF-72
- A) CONDUCT ENVIRONMENTAL SURVEY OPERATIONS ISO OPERATION GUARDIAN AS REQUIRED.
- D. PHASE IV. TRANSITION.
- 1) C7F
- A) O/O DISESTABLISH CTG OP GUARDIAN.
 - B) SUPPORT ALL INVESTIGATIONS.
- 2) CTF 73
- A) O/O DISESTABLISH CTU OP GUARDIAN COMMAND ELEMENT ASHORE.
7. COORDINATING INSTRUCTIONS
- A. PROPOSED C-DAY, L-HOUR: TBD.
 - B. ANTICIPATED LENGTH OF OPERATION: 08APR13.
 - C. ROE. CJCS SROE AND USPACOM THEATER ANNEX TO THE SROE ARE IN EFFECT.
 - D. FORCE PROTECTION. CONSIDERATION WILL BE GIVEN TO FORCE PROTECTION AND THREATS IN THE THEATER OF OPERATIONS. COMSEVENTHFLT WILL DESIGNATE APPROPRIATE BRIEFINGS AND ACTIONS NEEDED TO BE TAKEN TO MINIMIZE POTENTIAL THREAT TO PERSONNEL.
 - E. ASSUMPTIONS
 - 1) PARTIES FROM OTHER THAN U.S. AND CONTRACTORS WILL NOT INTERFERE WITH RECOVERY OR SECURITY OPERATIONS.
 - 2) ENVIRONMENTAL DAMAGE WILL BE LIMITED TO DAMAGE TO THE REEF CAUSED BY GROUNDING AND SUBSEQUENT MOVEMENT OF GUARDIAN.
 - F. OPERATIONS AREA. SULU SEA.
 - G. DIRLAUTH ALCON. KEEP COMSEVENTHFLT INFORMED.
 - H. ALL SITUATIONAL REPORTS WILL BE MADE VIA CHAIN OF COMMAND WATCH FLOORS FOR OFFICIAL RECORD KEEPING PURPOSES AND BATTLE RHYTHM.
 - I. RFI GUIDANCE. NO CHANGE.
- GENTEXT/ADMIN AND LOG//
8. ADMIN
- A. PUBLIC AFFAIRS GUIDANCE.
 - 1) PROVIDE COMPLETE VISUAL IMAGERY DOCUMENTATION OF THE ENTIRE DISMANTLING AND SALVAGE OPERATIONS OF USS GUARDIAN (MCM 5) FOR COMMUNICATION AND LEGAL PURPOSES. COVERAGE AUTHORIZED FOR DOCUMENTATION PURPOSES ONLY. PUBLIC RELEASE OF IMAGERY IS NOT AUTHORIZED WITHOUT PRIOR APPROVAL OF C7F PUBLIC AFFAIRS.
 - 2) THE ON-SCENE MASS COMMUNICATION SPECIALISTS (MCS) SHOULD BE INCLUDED IN THE PLANNING PROCESS TO DOCUMENT ALL ASPECTS OF THE SALVAGE OPERATIONS. MCS SHOULD BE PRESENT WITH THE SALVAGE TEAMS WHERE SAFETY ALLOWS IN ORDER TO OBTAIN CRITICAL VISUAL INFORMATION OF THE SALVAGE AND DISMANTLING OF USS GUARDIAN (MCM 5).
 - 3) FOCUS OF VISUAL IMAGERY DOCUMENTATION EFFORT WILL BE THE SALVAGE AND DISMANTLING OF THE GUARDIAN AND PROVIDE DAILY DIGITAL PHOTOS AND WHEN PRACTICAL, VIDEO IMAGERY OF THE OPERATIONS.
 - 4) ON-SCENE COMMANDER WILL PROVIDE THE ON-SCENE MCS ACCESS TO THE SALVAGE SITE AND MAKE AVAILABLE NETWORK SYSTEMS ABLE TO TRANSMIT DAILY IMAGERY AND SITREP REQUIREMENTS TO C7F AND PACFLT PUBLIC AFFAIRS.
 - 5) ALL DIGITAL PHOTOS AND VIDEO PACKAGES WILL BE PROVIDED TO C7F, VIA PA CHANNELS, FOR POSSIBLE FURTHER DISTRIBUTION.
 - 6) POINTS OF CONTACT: C7F PAO: (Removed to protect PII)
 - B. REPORTING CRITERIA.

CTU OP GUARDIAN COMMAND ELEMENT ASHORE WILL PROVIDE A COMBINED (WITH CTU OP GUA SALVAGE ELEMENT) SITUATIONAL REPORT UPDATE VIA EMAIL TO CPF AND C7F BWC BY 0900Z AS WELL AS POST THE DAILY UPDATE BRIEF TO THE CTF 73 CAS PAGE BY 0800Z. THERE WILL NO LONGER BE A REQUIREMENT FOR A DAILY VTC. CTG OP GUARDIAN WILL LEAD A DAILY TELCON TO CPF AT 0100Z, WITH REPRESENTATION FROM NAVSEA. NO DAILY SITREP OR TELCON WILL BE REQUIRED IN PHASE IV.

C. INFORMATION OPERATIONS GUIDANCE. PLAN TO CONDUCT OPERATIONS TO GAIN AND MAINTAIN INTERNATIONAL AND DOMESTIC SUPPORT FOR THE RECOVERY OF THE VESSEL AND CREW. PLANNING WILL ALSO ADDRESS POST-MISSION INFORMATION OPERATIONS CONSIDERATIONS.

D. CLASSIFICATION GUIDANCE. PLANNING FOR THIS OPERATION IS UNCLASSIFIED. DISCLOSURE OF INFORMATION REGARDING THIS PLANNING IS AT THE DISCRETION OF THE SUPPORTED COMMANDER OR HIS DESIGNATED REPRESENTATIVE.

9. LOGISTICS.

A. KNOWN LOGISTICS RESTRAINTS: NONE.

B. CTF 73 WILL COORDINATE RAS FOR U/W UNITS.

C. NO ESCORTS OR EVASIVE ACTIONS ARE EXPECTED FOR LOG FORCE ASSETS.

D. CTFS WILL IDENTIFY AND REPORT SHORTFALLS OF CRITICAL SUPPLY ITEMS AND MAINTENANCE TO COMSEVENTHFLT.

GENTEXT/COMMAND AND SIGNAL//

10. COMMAND AND CONTROL.

A. DURING PHASE 1 AND 2 COMSEVENTHFLT IS THE SUPPORTED COMMANDER. CTG OP GUA, CTF76, IS OPCON TO COMSEVENTH FLT. CTU OP GUA, CTF 73, IS OPCON TO CTG OP GUA. CTU OP GUA.1, USS GUARDIAN; CTU OP GUA.3, USS MUSTIN; AND CTU OP GUA.6, COMMAND ELEMENT ASHORE, ARE OPCON TO CTU OP GUA. CTF 72 IS TACON OF P-3 DET GUA AND SUPPORTING CTU OP GUA. CTF 73 IS TACON OF USNS SALVOR AND MDSU DET ONE, WHILE SUPPORTING CTU OP GUA. NAVSEA IS SUPPORTING CTU OP GUA AND COORDINATING/CONTRACTING MSV CHAMPION AND MT TRABAJADOR.

B. DURING PHASE 3 AND 4 COMSEVENTHFLT WILL BE CTG OP GUA, THE SUPPORTED COMMANDERS ARE CTU OP GUA COMMAND ELEMENT (ASHORE), A CTF 73 0-6, OPCON TO CTG OP GUA; AND CTU OP GUA SALVAGE ELEMENT (ON SCENE COMMANDER), NAVSEA SUPSALVAGE, IS TACON TO CTG OP GUA. CTU OP GUA.2, MDSU DET ONE; CTU OP GUA.3, USNS WASHINGTON CHAMBERS; AND CTU OP GUA.4, USNS SAFEGUARD, ARE TACON TO CTU OP GUA COMMAND ELEMENT ASHORE AND SUPPORTING CTU OP GUA SALVAGE ELEMENT. NAVSEA IS SUPPORTING CTU OP GUA SALVAGE ELEMENT AND COORDINATING WITH CTU OP GUA COMMAND ELEMENT ASHORE. JUSMAG AND RP FORCES ARE COORDINATING WITH CTU OP GUA COMMAND ELEMENT ASHORE. SALVAGE ASSETS, MV TRABAJADOR, MV VOS APOLLO, MV ARCHON TIDE, SMIT BORNEO, BARGE S-7000 AND MV JASCON 25 ARE CONTRACTED TO CTU OP GUA SALVAGE ELEMENT.

C. COMMAND AND CONTROL SLIDES POSTED ON THE OPERATION GUARDIAN CAS WEBSITE.

11. COMMUNICATIONS

A. CONNECTIVITY. ALL RECOVERY AND SALVAGE OPERATIONS WILL BE COORDINATED IN THE C7F CHATROOM.

12. KNOWLEDGE AND INFORMATION MANAGEMENT.

A. SIPR COLLABORATION PORTAL. THE PRIMARY INFORMATION SHARING AND COLLABORATION PORTAL ON SIPRNET FOR OPERATION GUARDIAN SUPPORT IS LINKED TO IN RED LETTERING ON THE SEVENTHFLT REAL-WORLD CAS SITE, TOP RIGHT SIDE UNDER SITUATION AWARENESS. THE URL IS [HTTP://WWW.PR.CAS.NAVY.SMIL.MIL/FLEET/C7F/SITE.NSF](http://www.pr.cas.navy.smil.mil/fleet/c7f/site.nsf).

1) THERE ARE SEVERAL SECTIONS FOR VARIOUS PRODUCTS.

A) ORDERS

B) COMMANDER'S CRITICAL INFORMATION REQUIREMENTS (CCIR)

C) PLANS

D) MISSION UPDATES

E) POST MISSION PRODUCTS

F) WEATHER

G) OPERATIONAL REPORTS (OPREPS)

H) RELATED LINKS

I) SITUATION AWARENESS

B. A CAS ACCOUNT IS NOT REQUIRED TO ACCESS AND READ INFORMATION POSTED TO THE SITE, HOWEVER AN ACCOUNT WILL BE REQUIRED TO ADD OR MODIFY FILES AND INFORMATION. A LINK AT THE BOTTOM LEFT OF THE PAGE HAS A LINK TO REQUEST AN ACCOUNT, OR REQUEST PERMISSIONS FOR THOSE WHO MAY ALREADY HAVE AN ACCOUNT YET REQUIRE SPECIFIC PERMISSIONS.

C. NIPR COLLABORATION PORTAL. TO FACILITATE UNCLASS INFORMATION AND PICTURE SHARING, AN OPERATION USS GUARDIAN WIKI PAGE HAS BEEN CREATED ON INTELLIPEDIA AT:

[HTTPS://INTELLIPEDIA.INTELINK.GOV/WIKI/OPERATION_USS_GUARDIAN](https://intellipedia.intelink.gov/wiki/operation_uss_guardian). THIS SITE REQUIRES AN INTELINK ACCOUNT OR CAC CARD TO ACCESS.

D. CHAT. ALL PARTICIPATING UNITS SHALL MONITOR AND CONTRIBUTE TO THE CHAT ROOM #OPERATION_GUARDIAN THAT IS HOSTED ON THE PACFLT IRC CHAT SERVER AT 198.55.1.66. CHAT WILL BE USED TO SUPPORT TIME- SENSITIVE OFFICIAL TASKING, OPERATIONAL REPORTS, AND SHARED SITUATION AWARENESS.

E. KNOWLEDGE AND INFORMATION MANAGEMENT POINTS OF CONTACT.

- 1) MOC KNOWLEDGE MANAGEMENT OFFICER/(Removed to protect PII)
- 2) FLEET INFORMATION MANAGEMENT OFFICER/(Removed to protect PII)
- C) IM SUPPORT STAFF/EMAIL:IM(AT)C7F.NAVY.MIL//

BT

O 030651Z APR 13 ZEL PSN 869036K32

FM COMSEVENTHFLT

TO RHOVNGW/CTF 70

RHMFSS/CTF 72

RUOIAAA/CTF 73

RUAYIAA/CTF 74

RHMFSS/CTF 76

INFO RHMFSS/HQ USPACOM HONOLULU HI

RUOIAAA/COMPACFLT PEARL HARBOR HI

RHMFSS/COMPACFLT PEARL HARBOR HI

RUOIAAA/COMNAVSURFPAC SAN DIEGO CA

RUALSFJ/COMUSJAPAN YOKOTA AB JA

RUALSFJ/COMUSJAPAN COMMAND CENTER YOKOTA AB JA

RUOIAEB/COMNAVFORJAPAN YOKOSUKA JA

RUOIAAA/COMEXSTRIKGRU SEVEN

RUOIAAA/COMLOG WESTPAC

RHOVHHL/COMPHIBRON ELEVEN

RUOIAAA/COMCMRON SEVEN

RUZDEAK/USDAO MANILA RP

RUEHML/USDAO MANILA RP

RUOIAAA/COMNAVSEASYS COM WASHINGTON DC

RHMFSS/COMNAVSEASYS COM WASHINGTON DC

RUOIAAA/JSOTF PHILIPPINES

RHOVVKG/COMSEVENTHFLT

BT

UNCLAS

MSGID/OPORD/COMSEVENTHFLT/055/APR//

SUBJ/FRAGMENTARY ORDER 007 TO OPERATION GUARDIAN OORDER//

REF/A/DOC/COMSEVENTHFLT/19AUG12//

REF/B/MSG/GUARDIAN/162046ZJAN2013//

REF/C/MSG/C7F/191021ZJAN2013//

REF/D/MSG/C7F/201008ZJAN2013//

REF/E/MSG/C7F/221009ZJAN2013//

REF/F/MSG/C7F/251000ZJAN2013//

REF/G/MSG/C7F/310146ZJAN2013//

REF/H/MSG/C7F/132202ZFEB2013//

REF/I/MSG/C7F/010053ZAPR2013//

NARR/ REF A IS COMSEVENTHFLT OPO RD 201. REF B IS GUARDIAN INITIAL
NAVY BLUE OPREP MESSAGE. REF C IS COMSEVENTHFLT OPERATION GUARDIAN
OPO RD. REF D IS COMSEVENTHFLT OPERATION GUARDIAN OPO RD FRAGO ONE.
REF E IS COMSEVENTHFLT OPERATION GUARDIAN OPO RD FRAGO TWO. REF F
IS COMSEVENTHFLT OPERATION GUARDIAN OPO RD FRAGO THREE. REF G IS
COMSEVENTHFLT OPERATION GUARDIAN OPO RD FRAGO FOUR. REF H IS
COMSEVENTHFLT OPERATION GUARDIAN OPO RD FRAGO FIVE. REF I IS
COMSEVENTHFLT OPERATION GUARDIAN OPO RD FRAGO SIX.

POC/WEBER/CDR/COMSEVENTHFLT/USS BLUE RIDGE/TEL: DSN 315-243-7719//

POC/-/C7F MOC CHIEF/COMSEVENTHFLT/-/-/

C7FMOCCHIEF(AT)C7F.NAVY.SMIL.MIL//

ORDTYP/FRAGORD/COMSEVENTHFLT//

RMKS/GENTEXT/AUTHORITY/

1. THIS IS AN OPERATIONS ORDER DIRECTING COMSEVENTHFLT ASSET ACTIONS DURING RECOVERY AND
DISESTABLISHES CTU OP GUARDIAN SALVAGE ELEMENT WITH THE COMPLETION OF SALVAGE OPERATIONS OF
EXGUARDIAN IN THE SULU SEA./

/TASK ORGANIZATION/

/UNIT/UNITLOC/COMMENTS

/CTG OP GUARDIAN/YOKOSUKA, JAPAN/VADM SWIFT

/CTU OP GUARDIAN/PALAWAN, RP/CTF 73 DESIGNATED O-6 COMMAND ELEMENT (ASHORE)

/CTU OP GUARDIAN.2 /SULU SEA /MUDSU DET OIC (OSC)

/CTU OP GUARDIAN.3 /SULU SEA/USNS WASHINGTON CHAMBERS

/CTU OP GUARDIAN.4 /SULU SEA /USNS SAFEGUARD

GENTEXT/SITUATION/

2. GENERAL. CHANGE TO READ:

AT 170223HJAN13 USS GUARDIAN RAN AGROUND IN THE SULU SEA, WHICH COULD CAUSE SIGNIFICANT ENVIRONMENTAL DAMAGE TO THE TUBATTAHA REEF AND SURROUNDING AREA. THE CREW IS SAFELY REMOVED. THE FOLLOWING VESSELS OR UNITS ARE ON STATION TO PROVIDE ASSISTANCE:

-USNS SAFEGUARD

-USNS WASHINGTON CHAMBERS AND HELICOPTERS

-MDSU ONE

-MV INTREPID

-MV ARCHON TIDE

-SMIT BORNEO

-MV JASCON 25

CONTRACTED SALVAGE VESSELS AND USNS WASHINGTON CHAMBERS WITH HELICOPTERS CAN BE RELEASED BY CTU COMMAND ELEMENT ASHORE WHEN NO LONGER REQUIRED FOR ENVIRONMENTAL SURVEY SUPPORT./

GENTEXT/MISSION/

3. MISSION STATEMENT. NO CHANGE.

GENTEXT/EXECUTION/

4. COMMANDER'S INTENT.NO CHANGE.

5. CONCEPT OF OPERATIONS. NO CHANGE.

A. PHASE I. NO CHANGE.

B. PHASE II. NO CHANGE.

C. PHASE III. NO CHANGE.

D. PHASE IV. NO CHANGE.

6. TASKS

A. PHASE I. NO CHANGE.

B. PHASE II. NO CHANGE.

C. PHASE III. RECOVERY AND SALVAGE. CHANGE TO READ:

1) NO CHANGE.

A) NO CHANGE.

B) NO CHANGE.

C) NO CHANGE.

D) NO CHANGE.

E) DELETE, ORDER IS GIVEN.

2) CTF-73. NO CHANGE.

A) NO CHANGE.

B) DISESTABLISH CTU OP GUA SALAVAGE ELEMENT.

C) NO CHANGE.

D) DELETE PARA 6.C.2.D.

E) NO CHANGE.

3) CTF-72. NO CHANGE.

A) NO CHANGE.

D. PHASE IV. TRANSITION. NO CHANGE.

7. COORDINATING INSTRUCTIONS. NO CHANGE.

A. PROPOSED C-DAY, L-HOUR: TBD. NO CHANGE.

B. ANTICIPATED LENGTH OF OPERATION: 13APR13.

C. ROE. NO CHANGE.

D. FORCE PROTECTION. NO CHANGE.
E. ASSUMPTIONS. NO CHANGE.
1) NO CHANGE.
2) NO CHANGE.
F. OPERATIONS AREA. SULU SEA. NO CHANGE.
G. DIRLAUTH ALCON. KEEP COMSEVENTHFLT INFORMED. NO CHANGE.
H. ALL SITUATIONAL REPORTS WILL BE MADE VIA CHAIN OF COMMAND WATCH FLOORS FOR OFFICIAL RECORD KEEPING PURPOSES AND BATTLE RHYTHM. NO CHANGE.
I. RFI GUIDANCE. NO CHANGE.
GENTEXT/ADMIN AND LOG/
8. ADMIN. NO CHANGE.
A. NO CHANGE.
B. NO CHANGE.
C. NO CHANGE.
D. NO CHANGE.
9. LOGISTICS. NO CHANGE.
A. NO CHANGE.
B. NO CHANGE.
C. NO CHANGE.
D. NO CHANGE.
GENTEXT/COMMAND AND SIGNAL/
10. COMMAND AND CONTROL. CHANGE TO READ:
A. NO CHANGE.
B. CHANGE PARA B. TO READ: DURING PHASE 3 AND 4 COMSEVENTHFLT WILL BE CTG OP GUA, THE SUPPORTED COMMANDER IS CTU OP GUA COMMAND ELEMENT (ASHORE), A CTF 73 0-6, OPCON TO CTG OP GUA; CTU OP GUA.2, MDSU DET ONE; AND CTU OP GUA.4, USNS SAFEGUARD, ARE TACON TO CTU OP GUA COMMAND ELEMENT ASHORE. JUSMAG AND RP FORCES ARE COORDINATING WITH CTU OP GUA COMMAND ELEMENT ASHORE.
C. NO CHANGE.
11. COMMUNICATIONS. NO CHANGE.
A. NO CHANGE.
12. KNOWLEDGE AND INFORMATION MANAGEMENT. NO CHNAGE.
A. NO CHANGE.
B. NO CHANGE.
C. NO CHANGE.
D. NO CHANGE.
E. NO CHANGE.//
BT

APPENDIX D

TIMELINE OF EVENTS



This page intentionally left blank.

Appendix D- Timeline of Events

Date	Event
17-Jan	Guardian ran aground on Tubbataha Reef (5 pm EST 16 Jan)
17-Jan	NAVSEA Ship Incident Response Center (NSIRC) has been activated
17-Jan	00C tasked SMIT to assess casualty and provide tug/salvor asap
17-Jan	3pm US Time, Guardian secures attempt to back off.
17-Jan	Ship broached and is almost parallel to reef - hull cracks and flooding of several forward spaces
17-Jan	Salvage Tug Trambajador mobilized from Subic
17-Jan	MSV Champion on scene, USNS BOWDITCH arrives on scene.
17-Jan	SMIT salvage team arrives Puerto Princesa
18-Jan	Guardian abandons ship. Crew transferred to Champion/Bowditch.
18-Jan	M/T TRABAJADOR-1 (SMIT salvage tug) on station
18-Jan	SMIT Salvage Assessment Team departs Puerto Princesa enroute Guardian on Philippine ship AS-71
18-Jan	VOS APOLLO placed on contract - mobilized from Labuan
19-Jan	CTF 73 OORDER issued directing CTF 7th Fleet assets
19-Jan	USS MUSTIN (DDG 89) arrives on station
19-Jan	SMIT Salvage Assessment Team on station - weather preventing transfer to GUARDIAN
19-Jan	SWRMC arrives Puerto Princesa
19-Jan	VOS APOLLO in transit Malasia to Puerto Princesa.
20-Jan	Detailed structural damage reported by DCA before ship was evacuated
20-Jan	MDSU ONE Command Element arrives Puerto Princesa
20-Jan	Guardian Crew being transferred from MSV Champion to USS MUSTIN (DDG 89).
20-Jan	SUPSALV arrive Puerto Princesa
20-Jan	Chartered 737 flt from Singapore to Puerto Princesa with salv gear
21-Jan	VOS APPOLLO arrives Puerto Princesa (PPS) loads salvage equipment and departs proceeding to GUARDIAN
21-Jan	Salvage party unable to board guardian due to sea state conditions. Three USN Crew enter water, climb reef and over side to conduct inspection
21-Jan	MSV Champion detached
21-Jan	Begin mobilizing SMIT Cyclone and Borneo in Singapore
22-Jan	VOS Apollo departs Puerto Princesa
23-Jan	VOS Apollo arrives on site
23-Jan	SWRMC Battle Damage Team arrives on station onboard USS Mustin
23-Jan	Transfer hoses and pumps to Guardian. Prepare for pumping fuel from forward tanks.
24-Jan	USNS SALVOR arrives on station with MDSU ONE Company 1-6
24-25 Jan	Begin pumping diesel and oils from GUARDIAN to VOS Apollo

Date	Event
25-Jan	VOS APOLLO unable to maintain position - move to deeper water to trouble shoot forward thruster
25-Jan	Ceased mobilization of SMIT Cyclone in Singapore
26-Jan	Continue HAZMAT transfer of hand liftable items from GUARDIAN to USS MUSTIN
26-Jan	MUSTIN and Apollo techs repair Apollo bow thruster
27-Jan	Resume pumping hydrocarbons. Completed pumping stored oils. Began skimming ops in machinery spaces
29-Jan	Trabajador arrives Puerto Princesa for reprovisioning and discharge of Guardian garbage
3-Feb	V 1.4 of SMIT salvage plan approved for permit submission
3-Feb	V 1.4 of SMIT salvage plan forwarded to PR for permitting
3-Feb	Ordered Jascon 25 on Charter
3-Feb	Archon Tide - SMIT Borneo arrives at Puerto Princesa
4-Feb	Jascon 25 Charter agreement executed
4-Feb	Archon Tide - SMIT Borneo depart Puerto Princesa enroute Tubbataha Reef
5-Feb	Stakeholders meeting Puerto Princesa to address anchoring Boreno alongside reef
5-Feb	Archon Tide and Smit Borneo arrive Tubbataha Reef begin rigging for mooring
5-Feb	USS MUSTIN departs for SASEBO with GUARDIAN crew
6-Feb	Tubbataha Reef Board issued letter approving plan to conduct salvage and requiring continuous environmental monitoring of site
7-Feb	SMIT Borneo attempts mooring adjacent to Guardian
7-Feb	SMIT Borneo ceases mooring attempts. Unable to set anchor on slope closest to Reef
8-Feb	Jascon 25 placed on hire
9-Feb	Jascon 25 Underway from Singapore to Tubbataha Reef
10-Feb	Salvage plan V1.5 approved - Jascon 25 for whole project and use of wreck grab
11-Feb	Sea 05 Incident Command Center (NSIRC) stands down
12-Feb	Configure High line from Guardian to Archon Tide for transferring materials
12-Feb	VOS APOLLO completes tank cleaning and departed Puerto Princesa for port of Labuan
14-Feb	Begin loading and configuring Barge S-7000 in Subic (15 containers, wood, steel beams, and wire rope)
14-Feb	SMIT reps inspected 3 yards in Singapore for Orange Peel Grab with no success
15-Feb	Off Hire VOS APOLLO in port of Labuan
15-Feb	Barge S-7000 depart Subic (towed by Trabajador)
16-Feb	Jascon 25 arrived Guardian Op area
18-Feb	Transfer crew from SMIT Borneo to Jascon 25 in PP anchorage.
19-Feb	Jascon 25 testing DP in vicinity of Guardian
19-Feb	Tropical Depression Crising causes ships to take safe position 25 NM North of Guardian
20-Feb	Salvage "grabs" arrive in Puerto Princesa. After assembly will be transferred to Borneo
20-Feb	Jascon 25 and Salvor depart PP for Guardian

Date	Event
21-Feb	Salvage Grabs loaded onto SMIT Borneo
21-Feb	SMIT Boreno depart Puerto Princesa under tow by Archon Tide with salvage grabs enroute Guardian
21-Feb	Barge S 7000 departs Puerto Princesa under tow by Trabajador enroute Guardian
21-Feb	Jascon and Salvor arrive Guardian Op Area
21-Feb	Weather did not permit salvage operations
22-Feb	Conduct damage assessment and place DP transponders IVO Guardian
22-Feb	Jascon 25 positioned to engage GUARDIAN
22-Feb	Commence lifting of equipment from USS GUARDIAN fantail
22-Feb	Begin removal of refrigerated stores and equip/parts staged on deck
22-Feb	SMIT Borneo and Barge S7000 arrive at site of Guardian with salvage grabs and provisioned salvage gear
23-Feb	Transferred Clamshell and orange peel salvage grabs to Jascon 25
24-Feb	Weather did not permit salvage operations
25-Feb	On load salvage support equipment onto Guardian
26-Feb	Removed VDS winch and Funnel from GUARDIAN
27-Feb	Removed Guardian Mast
2-Mar	02 level removed from Guardian and transferred to and landed on Jascon 25 deck.
5-Mar	Weather conditions did not permit salvage operations
6-Mar	Weather conditions did not permit salvage operations
7-Mar	Lifted stern section of 01 level from Guardian and transferred to and landed on Jascon 25 deck.
8-Mar	Lifted forward section of 01 level from Guardian and transferred to and landed on Jascon 25 deck.
9-Mar	Mobilized VOS Hercules in Singapore, loaded 17 MDSU One Crew, UW for Palawan
10-Mar	Removed starboard side 01 Funnel section from Guardian
11-Mar	Removed port side 01 Funnel section from Guardian
12-13 Mar	Removed MPDE and Generators from MMR and AMR
14-18 Mar	Removing equipment and interferences, clearing paths for section cuts for MMR AMR lift
15-Mar	VOS HERCULES / MDSU Co 1-2 arrived in Puerto Princesa
16-Mar	VOS HerCULES / MDSU Co 1-2 arrived at Guardian Op Area
16-Mar	USNS SAFEGUARD relieves USNS SALVOR which is released from Operation
17-Mar	Senior Salvage Master Wytse Huismans departing - replaced by Jan Willem Duit
17-18 Mar	Loading VOS Hercules with USN Containers from S7000 and J25
18-Mar	VOS Hercules underway to Puerto Princesa with MDSU Co 1-6.
18-21 Mar	Cutting Bow, AMR, MMR access holes for lift slings
18-Mar	Detaching port and stbd shafts forward of stern tubes in prep for stern cut
18-Mar	VOS Hercules / MDSU Co 1-6 clear customs Puerto Princesa en route Subic for fuel and passenger offload

Date	Event
21-Mar	Removed Stbd shaft from MMR
22-Mar	VOS HERCULES depart Subic enroute Sasebo, JA.
23-Mar	Began rigging bow section with 71mm slings for lifting
23-25 Mar	Making non-structural cuts in decks
25-Mar	Commenced cutting hull bottom for Bow removal
25-Mar	Began rigging AMR section with 71mm slings for lifting
25-Mar	Repositioned transponders off Guardian and on S7000
26-Mar	Complete final cut to lift bow section. Lifted bow and transferred to S7000
27-Mar	AMR lifted and transferred to S7000
29-Mar	MMR lifted and transferred to S7000
30-Mar	Stern lifted and transferred to S7000
31 Mar - 2 Apr	Conducted Debris removal on reef
1-Apr	DV Visit [RADM Isorena (PCG Commandant), CMDRE Evangelista (PCG District Palawan), Mrs. Songco (TMO), Mr. Tima (Press, GMA 7)
2-Apr	Debris cleanup is complete
2-Apr	Barge S7000 and Trabajador depart for Subic Bay for sea fastenings inspection and certificate
3-Apr	Aerial photography conducted
3-Apr	SUPSALV Departs Tubbataha Reef
4-Apr	MDSU CO 1-2 and USN Team moved to Safeguard from Jascon
4-Apr	All commercial assets (Jascon 25, SMIT Borino towed by Archon Tide, and VOS Hercules) depart - begin transit to Singapore
7-Apr	Barge S7000 and Trabajador depart Subic Bay for SASEBO
8-Apr	USS SAFEGUARD Detached
9-Apr	CTU OPGUA disestablished
9-Apr	VOS Hercules off hire
11-Apr	JASCON 25 off hire
13-Apr	Archon Tide off hire
15-Apr	SMIT Borneo off hire
15-Apr	Trabajador and S7000 arrive Sasebo, JA. Last Progress Report Issued.
25-Apr	GUARDIAN sections offloaded from S-7000 in SASEBO
26-Apr	Trabajador depart for Subic with S7000 in tow

APPENDIX E

VESSELS SUPPORTING OPERATION



This page intentionally left blank.

APPENDIX E. Vessels used in USS GUARDIAN Operation

US Navy Vessels

USS MUSTIN (DDG 89)

USS MUSTIN arrived on station 19 January. Served as Flag vessel for CTG OPGUA through 5 February. Helicopter detachment provided helicopter support while on site. Received GUARDIAN crew from C Champion on 20 January. On 26 January, MUSTIN crew members supported repairs to VOS APOLLO's dynamic positioning system.

Class:	DDG 51	Fleet:	Pacific
Status:	Active, in commission	Homeport:	YOKOSUKA, JAPAN
Date status changed:	07/26/2003	Builder:	NGSS INGALLS OP
Award Date:	03/06/1998	Delivery Date:	02/28/2003
Keel Date:	01/15/2001	Commission Date:	07/26/2003
Launch Date:	12/12/2001		
Overall Length:	510 ft	Waterline Length:	471 ft
Extreme Beam:	66 ft	Waterline Beam:	59 ft
Maximum Navigational Draft:	32 ft	Draft Limit:	22 ft
Light Displacement:	7134 tons	Full Displacement:	9515 tons
Dead Weight:	2381 tons		
Hull Material:	Steel hull, steel superstructure	Number of Propellers:	2
Propulsion Type:	Gas Turbines		
Accommodations:	Officers: 30, Enlisted: 282		



MSC Vessels

SSV C-Champion

SSV C-Champion is one of the eight Submarine and Special Warfare Support Vessels that are part of the 24 ships in Military Sealift Command's Special Mission Ships Program. This was the first vessel to arrive on the scene after USS GUARDIAN's grounding. C-Champion took a portion of GUARDIAN's crew aboard on 18 January when Guardian crew disembarked. C-Champion detached on 21 January.

- Length: 220 feet
- Beam: 56 feet
- Draft: 16.5 feet
- Displacement: 2,106 tons
- Speed: 12 knots
- Civilian: 14 crew/30 sponsor personnel
contract mariners
- Government-Owned/
Chartered: Chartered



USNS Bowditch

USNS Bowditch is one of the six Oceanographic Survey Ships that are part of the 24 ships in Military Sealift Command's Special Mission Ships Program. USNS Bowditch arrived at grounding site on 17 January. She took a portion of GUARDIAN's crew aboard on 18 January when Guardian crew disembarked.

- Length: 329 feet
- Beam: 58 feet
- Draft: 19 feet
- Displacement: 4,762 long tons
- Speed: 16.0 knots
- Civilian: 26 contract mariners
- Military: 27 military/sponsor personnel
- Government-Owned/Chartered: Government-owned



USNS WALLY SCHIRRA

USNS WALLY SCHIRRA is one of Military Sealift Command's fourteen Dry Cargo/Ammunition Ships and is part of the 34 ships in Military Sealift Command's Combat Logistics Force. USNS WALLY SCHIRRA arrived at the OPGUA site in early February (2 or 3) and provided a large able platform to support the Navy run operations. She supported air operations with her chartered Puma helicopter and her medical team and doctors managed the OPGUA medical needs and developed the MEDIVAC procedures used throughout the rest of the operation. She was replaced by USNS WASHINGTON CHAMBERS (T-AKE 11) toward the end of the operation.

- Length: 689 feet
- Beam: 105.6 feet
- Draft: 29.9 feet
- Displacement: 41,000 long tons
- Speed: 20 knots
- Civilian: 124 civilian service mariners
- Military: 11
- Government-Owned / Chartered: Government-owned



USNS SAFEGUARD (T-ARS 50)

USNS Safeguard is one of Military Sealift Command's four Rescue and Salvage Ships and one of the 15 ships in Military Sealift Command's Service Support Program. Arrived on station and relieved USNS SALVOR on 16 March and remained throughout the remainder of the operation.

- Length: 255 feet
- Beam: 51 feet
- Draft: 17 feet
- Displacement: 3,282 tons, full load
- Speed: 14 knots
- Civilian: 26 civil service mariners
- Military: 4
- Government-Owned / Chartered: Government-owned



USNS SALVOR (T-ARS 52)

USNS SALVOR is one of Military Sealift Command's four Rescue and Salvage Ships and one of the 15 ships in Military Sealift Command's Service Support Program. USNS SALVOR arrived on station 24 January and held the MDSU team. Replaced by USNS SAFEGUARD on 16 March.

- Length: 255 feet
- Beam: 51 feet
- Draft: 17 feet
- Displacement: 3,282 tons, full load
- Speed: 14 knots
- Civilian: 26 civil service mariners
- Military: 4
- Government-Owned / Chartered: Government-owned



Chartered Vessels

Archon Tide

Towed SMIT Borneo from Singapore to Puerto Princesa and onto OPGUA site. Shuttled GUARDIAN debris from JASCON to SMIT Borneo/S-7000 and cargo from Puerto Princesa to OPGUA site.

Ship Type: Anchor handling vessel

Year Built: 2011

Length x Breadth: 70 m X 17 m

Gross Tonnage: 2605, DeadWeight: 2572 t

Speed recorded (Max / Average): 8 / 7.9 knots

Flag: Vanuatu [VU] 

Call Sign: YJQV3

IMO: 9605762, MMSI: 576498000



Jascon 25

Placed on hire February 8. Underway from Singapore February 9. Arrived Puerto Princessa, February 16. With DP-3 capability, Jascon became the primary salvage platform for the removal task. Salvage Team moved aboard and directed salvage ops from Jascon 25 on February 18. Took position adjacent to reef and began weight removal ops on February 22 and superstructure lifts and hull sectioning on March 2. Left op area April 4 2013.

Ship Type: Pipelay crane vessel

Year Built: 2007

Length x Breadth: 118 m X 30 m

Gross Tonnage: 14829, **DeadWeight:** 606 t

Speed recorded (Max / Average): 6.7 / 6.7 knots

Flag: Gibraltar [GI] 

Call Sign: ZDIS3

IMO: 8770106, **MMSI:** 236478000

Machinery: Direct driven diesel propulsion thrusters – DPS-3

Crane: 72M main boom with max lifting capacity of 800 MT.

Accommodation: 351 persons



Smit Borneo

Underway from Singapore 4 February and at OPGUA site evening of 5 February. Attempts to place in 4 point moor adjacent to GUARDIAN unsuccessful. Took station in deeper water and managed debris removed by JASCON, staging it on barge S-7000.

Ship Type: Work pontoon

Year Built: 1974

Length x Breadth: 110 m X 30 m

Gross Tonnage: 7323, DeadWeight: 5228 t

Speed recorded (Max / Average): 6.6 / 5.6 knots

Flag: Dominica [DM] 

Call Sign: J7AS2

IMO: 8757348, MMSI: 325163000

Crane: 54M main boom with max lifting capacity of 500 MT.

Accommodation: 152 persons



VOS APOLLO

VOS APOLLO, a SMIT owned anchor handling tug, arrived at the OPGUA site on 23 January. She had picked up a number of passengers in Puerto Princesa including: SUPSALV (CAPT Matthews) and LCDR Addington 00C2OB, SWRMC Battle Damage Team, and Mobile Diving and Salvage Unit 1 -2. VOS APOLLO played significant roles throughout the operation including fuel offload, transferring crew and cargo to Puerto Princesa,.

Ship Type: Anchor handling vessel

Year Built: 2011

Length x Breadth: 60 m X 16 m

Gross Tonnage: 1678, **DeadWeight:** 1324 t

Speed recorded (Max / Average): 6.5 / 6.5 knots

Flag: Singapore [SG] 

Call Sign: 9V8667

IMO: 9552185, **MMSI:** 566159000



VOS Hercules

Shuttled GUARDIAN debris to and from JASCON – S-7000 and took an early load (22 March) of GUARDIAN equipment including CONEX boxes and the funnel to Sasebo, Japan.

Ship Type: Anchor handling vessel

Year Built: 2006

Length x Breadth: 59 m X 16 m

Gross Tonnage: 1690, **DeadWeight:** 1360 t

Speed recorded (Max / Average): 5.2 / 5.1 knots

Flag: Singapore [SG] 

Call Sign: 9V7941

IMO: 9401702, **MMSI:** 563236000



M/T Trabajador

Salvage Tug Trabajador was the first SMIT hired vessel on the scene of the GUARDIAN grounding. She was placed on hire on January 17 and arrived on station on January 18, one day after GUARDIAN broached.

Ship Type: Tug

Year Built: 1979

Length x Breadth: 69 m X 12 m

Gross Tonnage: 1449, DeadWeight: 1039 t

Speed recorded (Max / Average): 9 / 9 knots

Flag: Philippines [PH] 

Call Sign: DUAA

IMO: 7817945, MMSI: 548800000



S-7000 Barge

Barge S-7000 was placed on hire on 14 February and began outfitting and mobilization. She was towed to Puerto Princesa and on to the Operation Guardian site by M/T Trabajador and was moored alongside SMIT Borneo. Barge S-7000 was used to hold GUARDIAN debris and the 4 major hull sections. S-7000 departed for Subic Bay on 2 April and after seafastening and inspections, towed to Sasebo, arriving on 15 April for offloading.

Ship Type: Cargo Deck Barge

Owner/Operator: Seabridge, Inc. Piti, Guam

Length x Breadth: 90 m X 24 m x 1.6 m

Clear Deck Space: 1,755 m² Sides: 4 m high

Gross Tonnage: 3,105, DeadWeight: 7,000 t



APPENDIX F

MDSU ONE AND SWRMC BDR AFTER ACTION REPORT



This page intentionally left blank.

Appendix F: After Action Reports – SWRMC and MDSU ONE

SWRMC AAR

14 MAR 2013

From: Ship Salvage and Diving Officer, Southwest RMC San Diego, CA
To: Command Officer, Southwest RMC San Diego, CA
Via: Command Diving Officer, Southwest RMC San Diego, CA
Diving Operations Officer, Southwest RMC San Diego, CA
Command Master Diver, Southwest RMC San Diego, CA

Subj: AAR 13-02; AFTER ACTION REPORT, OPERATION GUARDIAN

1. Mission. Provide Battle Damage Repair (BDR) in support of Operation GUARDIAN.

a. SWRMC Personnel:

1. LT Brege
2. NDCS Kenefic
3. HMCS Lariscy
4. ND1 Casey
5. ND1 Dojaquez
6. ND1 Buttler
7. ND2 Griggs

b. Equipment:

1. Personal Dive equipment
2. Portable Medical Equipment.

c. Vessels:

1. USS MUSTIN, DDG 89
2. USNS BOWDITCH
3. USNS SALVOR
4. VOS Apollo

2. Sequence of Events. All times are approximate.

18JAN2013

- Departed San Diego via commercial air.
- Arrived Los Angeles (LAX)
- Departed LAX

19JAN2013

- Travel Day. En route from Los Angeles to Puerto Princesa, Philippines via ,
Inchon, Korean and Manila, Philippines.

20JAN2013

- Arrived Puerto Princesa, Philippines.
- BDR Team greeted by Seabee Detachment OIC, CMMC Gonzalez.
- CMMC Gonzalez provided transportation from airport to Hotel Centro.
- 2200 LT Brege/MDV Kenefic met with CTF 73, SUPSALV, MDSU CO, and CTF 73
Staff outlining transportation to salvage site and initial priorities.

21JAN2013

- 1000 Departed hotel Centro and met VOS Apollo at Puerto Princesa Commercial Port.
- 1100 LT Brege and HMCS Lariscy transported to USS MUSTIN via small boat
- 1600 Remainder of BDR Team transported to USS MUSTIN via small boat

22JAN2013

- 0700 Initial transport to USS GUARDIAN salvage site via RHIB
- Conducted internal and external surveys of hull, running gear, and topside structural assessment.
- Conducted AA&E inventory
- Located and collected personnel identification and irreplaceable effects identified by GUARDIAN crew members

23JAN2013

- Continued Ammo inventory and offload.
- Started food and stores offload.
- Started equipment offload
- Conducted calculations to estimate ground reaction and loading/bending stress

24 JAN 2013

- Built tide gage and started stranded log
- Started GPS fixes on bow/stern to track movement
- 2000 SALVOR arrived on station

25 JAN 2013

- Took onboard 2 - P100 pumps for firefighting capabilities
- Assessed the structural damage of the USS GUARDIAN
- Gathered most hazmat together onto the forecastle of the ship for off load
- Gathered all full CO2 and AFFF bottles and divided amongst the 4 - P100 stations
- Went through all DC lockers to gather all useful gear needed for the DC efforts
- Gathered and offloaded 75% ammo and demo

26 JAN 2013

- Cleaned and cleared all passage ways 01 and above
- Cleaned and cleared 80% of galley and store room locker
- Cleaned and cleared all of the main medical space
- A team went through 02-03 levels to gather COMSEC equipment

27 JAN 2013

- Rigged up lights throughout the main deck for better work quality
- Took inventory of inert MN & AA&E
- Trash off load from main deck (mainly galley and 02 +03 levels)
- COMSEC clean up
- IPDS removal
- MNV lithium batteries (8-big ones) 20+
- Dry and canned good transfer to USNS SALVOR
- CBR kit removal, 2-PAM/Atropine (IDCs)

- ET's from USS Muston came over with the assist of saving \$1 million on CIC repair parts
- Started AFFF drain/flush
- Started CHT drain/flush
- Sonar assessment
- Galley goods complete
- Main deck, all spaces 80% complete
- CIC 80%
- Radio 20%
- DC lockers complete

28 JAN 2013

- Identified MN removal
- Cleared out COMSEC
- Main deck is complete
- 2X MK29 MOD1, cable cutters inert
- 95 CBR kits removed
- 6X (blue M4), 4X (shotgun), 4X knives, 9X (M9)
- All NALC removed
- CIC (secret) 95%
- Radio room (and portable hand held) 100%
- Gyro room complete
- Chart room complete
- Low Mu Extinguishers
- Force protection locker 95%
- IPDS offloaded
- Bridge 90%

29 JAN 2013

- Rough seas, but swam half of the crew on board
- Mast was structurally un-secured, so in turn it was re-secured to eliminate it from breaking off onto the reef
- started below decks to gather all gear and trash for clean up on for 1 hour before called off the ship due to heavy seas.
- Came back to USNS SALVOR to re-assess and clean up gear and trash brought over from USS GUARDIAN

30 Jan 2013

- Rough seas, no boats launched due to the safety factor and ORM no work done on USS GUARDIAN
- Put all wire rope away except for two 300 foot lengths of wire rope
- Conducted oxy-acetylene cutting training for cutting off main deck and above structures and any other cutting needed on the USS GUARDIAN
- SWRMC BDR Conducted a walkthrough of all SALVOR spaces to get familiar with the ship and its capabilities
- Gathered a list of any extra gear needed for the job
- Assisted in field day of spaces onboard USNS SALVOR

01 Feb 2013

- PAC transfer to and from the USS MUSTIN (DDG 89) and USNS SALVOR
- Gathered all USNS SALVOR trash and off-loaded it to Philippine Tug (Trabahador) via 7 meter RHIB
- Launched 7 meter RHIB work boat to the USS MUSTIN for the pickup of (3) brand new generators

- Participated as well as assisted in the fuel UNREP (50,000 gallons) from USNS WALLY SCHIRRA - T-AKE-8 to the USNS SALVOR.
- Launched both 7 meter RHIB (SALVOR's) and 5 meter RHIB (USS GUARDIAN's) to the WALLY SCHIRRA for a PAC transfer as well as 5 meter RHIB change of custody to WALLY SCHIRRA.

2 FEB 2013

- Launched the RHIB and made 4 runs (PAC and Gear) to USS GUARDIAN from USNS SALOVR to start our daily cleanup/salvage efforts
- Offloaded all paper navigational charts from the USS GUARDIAN to the USNS SALVOR
- Completed the 6 man berthing below main deck
- Cleaned up 75% of the 40 man berthing
- Safely took down the unstable mast on the USS GUARDIAN
- Made multiple trash runs with both the RHIB and 35' work boat from GUARDIAN to VOS APOLO (support tug).
- Assisted in the stores UNREP and the PAC transfer for USNS SALVOR
- COMSEC 100% complete
- Fuel 100% complete
- found more HAZMAT stowed in one location for proper offload
- Crew library 100% complete
- AC + REEFER installed system bled down
- Bow 45" STBD list less
- Bridge and chart room 100% complete
- AFFF flush 100% complete

3 FEB 2013

- Launched both the 7 meter RHIB and the 35' work boat with all essential personnel to GUARDIAN
- Completed 40 Man berthing 100%
- Main Deck complete 100%
- Gathered other MISC-hazmat as well as more trash to be taken out at a later date
- Took a survey on which parts are to be taken off ship via oxy-acetylene cutting

4 FEB 2013

- Launched RHIB for the transport of LT (Cooper), to USNS WALLY SCHIRRA for medical treatment.
- Sea state was too rough to conduct Salvage Operations

5 FEB 2013

- Sea state was too rough to conduct Salvage Operations
- Prepared salvage briefs, conducted additional structural analysis on bending moments/wave slap.

6 FEB 2013

- Launched RHIB with assessment team to deem the area safe for us divers to conduct the rest of the trash pickup/removal process as well as the marking off of items to be cut from the weather decks for removal once the crane arrives on station tonight after customs clears it
- Did a reef walk and swim around picking up GRP and random trash around the area
- Finishing up the trash in all the forward rooms

- Aft Engineering store room (lower level) 30% complete
- BDR Team Departed GUARDIAN Salvage Site via VOS Apollo.

07 FEB 2013

- Arrived Puerto Princesa
- Arranged transportation from VOS Apollo to shore using Philippine Coast Guard RHIB.
- Transported from Coast Guard Pier to Starlight Hotel Puerto Princesa
- Arranged transportation to local travel agency to purchase tickets from Puerto Princesa to Manila via Zest Air.

08 FEB 2013

- Departed Puerto Princess via Zest Air
- Arrived Manila, Philippines
- Arranged transportation to Best Western (Oxford) hotel in Manila

09 FEB 2013

- Departed Manila; continued travel via Narita, Japan, and Los Angeles, CA.
- Arrived San Diego, CA
- Transported to SWRMC for debrief.

3. Diving Statistics.

No dives conducted.

4. Job Description.

- As first responders, BDR team conducted initial internal and external damage surveys of hull and running gear.
- BDR Team conducted accountability of weapons/AA&E to ensure
- More than 9000 lbs ammunition by hand
- More than 15000 lb stores by hand
- Fuel Offload
- Drain flush isolation of 10 potentially hazardous systems
- Thorough structural analysis
- Secured and offloaded COMSEC Gear
- Storage Room Offload
- Damage Control Gear collection and transfer
- Collecting / loading GRP
- 20000 lb personal effects

5. Lessons Learned.

a. When executing any mission, the ability to maintain reliable external communication with other units and parent command is essential. In this case, the BDR team deployed with limited communication. An Iridium SATPHONE was procured from local command, but reception was limited while transiting and inport Philippines. To mitigate the lack of communication, BDR OIC and LCPO procured local phones and sim cards to communicate with CTF 73, SUPSALV, and other units in the Philippines. Recommendation: SWRMC should procure a minimum of two worldwide capable phones that can be activated for assets like BDR, or incorporate these phones into the BDR mission loadout.

b. During OP GUARDIAN the roles of supported and supporting roles were and overall chain of command was complex and unclear. The BDR team was initially folded under MDSU-1 during initial stage of operation. After arriving on scene, BDR took direction from SUPSALV and CTF 73 Salvage Officer which helped clarify specific roles and responsibilities for the BDR team. Recommendation: The BDR team should take direction and fall directly beneath the cognizant Fleet Salvage Officer.

c. Because each salvage operation is inherently unique, the equipment needed for each operation varies greatly. In this case, specific items would have been useful as standard issue for BDR personnel. Specific items include:

1. Waterproof Headlamps
2. Waterproof bags (Diving Dry Bags)
3. Quick drying shorts
4. Safety Glasses
5. Hard Hats

d. Although not required to enter the Philippines on official orders, several BDR members did not have official government passports. Recommendation: Issue official government passports to all SWRMC divers upon arrival to SWRMC.

e. Salvage Operations are inherently dangerous. The SWRMC BDR Team included an IDC DMT. Although no major injuries occurred, the BDR corpsmen provided necessary malaria medication, treated minor injuries, served as safety observer for high risk evolutions, and provided valuable insight when formulating MEDEVAC plan. Recommendation: Ensure IDC is included in BDR Team.

6. Points of Contact.

- a. SWRMC BATTLE DAMAGE REPAIR
LT Eric Brege

Email: eric.brege@navy.mil
COMM: 619-556-2036

- b. CTF 73 SALVAGE OFFICER
LCDR Derek Peterson

Email: Derek.peterson@fe.navy.mil

Very Respectfully,

ED Brege
LT USN



DEPARTMENT OF THE NAVY
MOBILE DIVING AND SALVAGE UNIT ONE
FPO AP 96601-7005

3000
N00
3 May 13

From: Commanding Officer, Mobile Diving and Salvage Unit ONE

Subj: DISCUSSION POINTS ON OPERATION GUARDIAN

1. SCOPE OF MISSION

a. MDSU-1 supported OPERATION GUARDIAN from 21 January to 09 April, providing an 05-level Command and Control element and two 17-man Mobile Diving and Salvage Companies (MDS Co).

b. Removed 10,000 pounds of arms, ammunition, and explosives.

c. Removed 20 tons of fuel covered waste and hazardous material.

d. Ensured 100 percent accountability of all communication security (COMSEC) material.

e. Recovered \$1 million in repair parts.

f. Cleared 22,000 pounds of dry, frozen, and refrigerated stores.

g. Salvaged all damage control equipment.

h. Cleared 127 spaces onboard EX-USS GUARDIAN.

i. Removed 550 tons of superstructure material.

j. Lifted EX-USS GUARDIAN, 1328 tons, off Tubbataha Reef.

k. Provided dive, personnel, equipment support to the marine ecological assessment.

2. ISSUES/BACKGROUND/RECOMMENDATION

a. ISSUE: OPERATION GUARDIAN Command and Control (C2) was created ad hoc and was not as efficient or effective as a standing C7F expeditionary C2 element.

b. BACKGROUND: OPERATION GUARDIAN C2 was established and disestablished for this operation. The process of standing up a new C2 and operating together for the first time creates inefficiencies that are normally avoided by having standing C2 with established relationships, proper resources, and operational experience.

c. RECOMMENDATION: Establish a standing, deployable expeditionary battle staff under a C7F Task Force capable. Future operations would be conducted under this staff and augmented with the proper subject matter experts.

Subj: DISCUSSION POINTS ON OPERATION GUARDIAN

3. ISSUES/BACKGROUND/RECOMMENDATION

a. ISSUE: Memorandum of Agreement between Navy Expeditionary Combat Command (NECC) and Military Sealift Command (MSC) is outdated, needs to be updated and enforced aboard MSC vessels.

b. BACKGROUND: During OPERATION GUARDIAN, issues arose around MSC's responsibility to have adequate manning and supplies to conduct small boat operations and provide meals for embarked personnel; in addition MSC ship schedules trumped operational needs - requiring USN Sailors to depart via foreign vessel of opportunity from operational area.

c. RECOMMENDATION: Address these issues by ISIC and TYCOM, continue to highlight these issues with commands that have a vested interest in MDSU-1 capabilities.

4. ISSUES/BACKGROUND/RECOMMENDATION

a. ISSUE: MDSU commands are not manned with equal capability; an Engineering Duty Officer (EDO) enhances salvage capability and is provided to MDSU-2 in Little Creek, VA but unavailable to MDSU-1.

b. BACKGROUND: During OPERATION GUARDIAN, MDSU-1 required outside EDO assistance to safely plan and execute disassembly of EX-USS GUARDIAN. An additional EDO assigned to MDSU ONE would have assisted in the planning, coordination, and execution of this operation. Such a resource could be permanently assigned to MDSU or have a habitual training relationship with MDSU ONE. Defunding any current officer AMD authorizations is not an option as all are required for MDSU ONE to meet operational requirements.

c. RECOMMENDATION: Either fund an EDO billet or develop an MOA with EDO community to assign an EDO in the Pearl Harbor region that would train and be available to deploy on salvage and diving operations when tasked by chain of command.

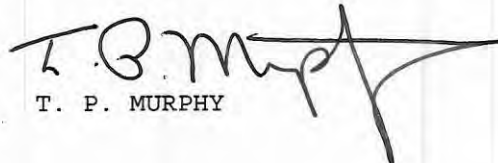
T. P. MURPHY

APPENDIX G

SALVAGE PLAN REV 1.5



This page intentionally left blank.



SALVAGE

SALVAGE PLAN WRECK REMOVAL “USS GUARDIAN”



DATE	09th February 2013
PROJECT NAME	Wreck removal “USS Guardian”
PROJECT NUMBER	5560
CLIENT	US Navy
DRAFTED BY	Wytse Huismans
VERSION/REVISION	1.5

Appendix G - Salvage Plan

TABLE OF CONTENTS.

1	INTRODUCTION.....	4
1.1	GENERAL	4
1.2	CURRENT CONDITION USS GUARDIAN:	5
1.3	CURRENT SALVAGE ACTIVITIES.....	6
1.4	VESSEL SPECIFICATIONS	7
2	METHODOLOGY.....	9
2.1	SUMMARY	9
2.2	TASKS AND DUTIES OF ONSITE CRAFT.....	10
2.3	ARRIVAL OF JASCON 25 AND BARGE "S-7000" ON SITE	11
2.4	REMOVAL EQUIPMENT FROM SUPERSTRUCTURE AND WEATHER DECK	13
2.5	FURTHER REMOVAL OF INVENTORY	13
2.6	REMOVAL OF SUPERSTRUCTURE	14
2.7	REMOVAL OF MACHINERIES AND STRUCTURES BELOW THE MAIN DECK ..	14
2.8	REMOVAL FROM THE HULL	15
2.8.1	General	15
2.8.2	Cutting and slinging the bow forward of AMR.....	15
2.8.3	Removal of MMR and AMR.....	16
2.8.4	Removal of the stern aft of frame 81	16
2.9	SEAFASTENING OF HULL SECTIONS.....	16
3	RECOURCES	17
3.1	MARINE SPREAD.....	17
3.2	EQUIPMENT.....	17
3.3	PERSONNEL	18
4	SAFETY HEALTH & ENVIRONMENT	19
4.1	SAFETY.....	19
4.2	ENVIRONMENTAL.....	19
5	COMMUNICATION.....	21
5.1	GENERAL COMMUNICATION	21
5.2	ON SITE COMMUNICATION	21
5.3	WORKING LANGUAGE.....	21
6	POINTS OF CONSIDERATIONS	22
7	TIMELINE	24

1 INTRODUCTION

1.1 GENERAL

On the 17th January 2013 MCM (Mine Counter Measures) "USS Guardian" ran aground on the Northwestern tip of the Tubbataha Reef in the Sulu Sea/Philippines.

Although the vessel initially had been aground in way of the bow area it twisted due to the then present wind/sea conditions and had been pushed up further on the reef to a distance of approximately 20 meters from the edge.

Under under NAVSEA, SUPSALV contract (N00024-12-D-4120) between SMIT and the US Navy a team had been mobilized from Singapore at the earliest convenience but only arrived on scene 19th January. The vessel had been subject to adverse weather conditions since the grounding and continued to be so until the 24th January.

First opportunity for inspection and assessment had been on 22nd January. Hydrocarbon recovery commenced on 24th January.

Due to the amount of bottom damage, development of cracks in the structure and the current position of the vessel on the reef, refloating is not an option. Although several options for recovery have been discussed it has been decided by the US Navy that the vessel needs to be removed at the earliest convenience.

The method statement is to be considered as a living document and is subject to discussion between parties. Due to progressive insights methodology may change over time in close conjunction between SMIT and the US Navy.

Some works may be conducted simultaneously and will be determined at a later stage.

1.2 CURRENT CONDITION USS GUARDIAN:

The vessel is resting on the NW-tip of the Tubbataha Reef heading approximately 090° and has a list of 5° to the port side.

The vessel is subject to the prevailing North East monsoon conditions and sea/swell are impacting the port side of the hull causing motion of the vessel and therefore slowly deteriorating its condition.

The rudders are partly embedded in the coral/sand and port and starboard propellers have broken off lying beside the shaft. The shafts are embedded on the seabed.

From the stern forward the bottom is severely damaged by the coral and in several places has breached the hull causing ingress of water and compartments are tidal. Due to the continuous motions on the coral, engines in the engine room are out of true and elevated.

Frame 63 has shifted out of true. Keel deformation is evident between frame 41 and 76.

On 02 level (superstructure) several cracks have been observed from frame 55 to 72 around exhaust stack. Due to the motion in the structure the cracks are widening slowly during adverse weather conditions and continuous impact of the waves against the portside hull.

The hull is made of 4 layers of wood laminated with GRF (Glass Reinforced Fibre). Due to the impact of the waves the GRF on the portside of the hull has come off and is scattered on the leeside of the vessel on the reef.

The wooden hull is splintering to the second layer in places and some bronze nails are protruding.

All bulk hydrocarbons and hazardous materials have been taken off the vessel whereas the hydrocarbons have been pumped to the VOS Apollo.

Ordnance and ammunition has been taken off from the vessel by the US Navy. Furthermore all loose items from within the hull and on deck has been removed by RHIB to other vessels as far as practicable to mitigate possible environmental impact. The more heavy items will be removed once a crane barge is on site.

1.3 CURRENT SALVAGE ACTIVITIES

All the bunkers have been removed from the tanks and machineries apart from 2 small pitch propeller tanks, which are inaccessible at the moment.

An attempt to put the SMIT Borneo in a 4 point mooring pattern has failed as the first anchor nearest to the reef could not properly laid due to the steepness of the underwater slope of the reef. **(See fig.2)**

For this reason the it has been decided to accelerate the mobilization of the **DP vessel "Jascon 25"** , which will be able to position her selves next to the reef.

In meantime combined salvage crews from the NAVY and SMIT Salvage are actively working on the recovery of the inventory of rooms and spaces and are making preparations to remove machineries from the Fantail once the Jascon 25 arrives on location.

1.4 VESSEL SPECIFICATIONS



Fig. 1 (general specifications)

HULL:

- ✘ Hull consists of four (4) layers of wood planking covered with several layers of fiberglass. First, there are two (2) crisscrossing layers of three-quarter-inch (3/4") Alaskan yellow cedar that are nailed, screwed, and glued together. These are covered by a horizontal layer of three-inch (3") thick Douglas fir covered by a half-inch (1/2") layer of fir planks laid on the diagonal.
- ✘ Over the final layer of planks are several layers of fiberglass cloth impregnated with epoxy resin.

DECKS:

☒ Wood and Fiberglass

SUPERSTRUCTURE:

☒ Wood only

UNCLASSIFIED: Distribution limited to DOD and DOD Contractors only. Foreign Government Information, (21 January 2013). Other requests must be referred to the Commanding Officer, Naval Oceanographic Office. This information may not be released to a third country/ party without prior approval of the Commanding Officer, Naval Oceanographic Office and the Government of the Republic of Philippines.



NAVAL OCEANOGRAPHIC OFFICE

NOT FOR NAVIGATION
 -PRELIMINARY DATA-

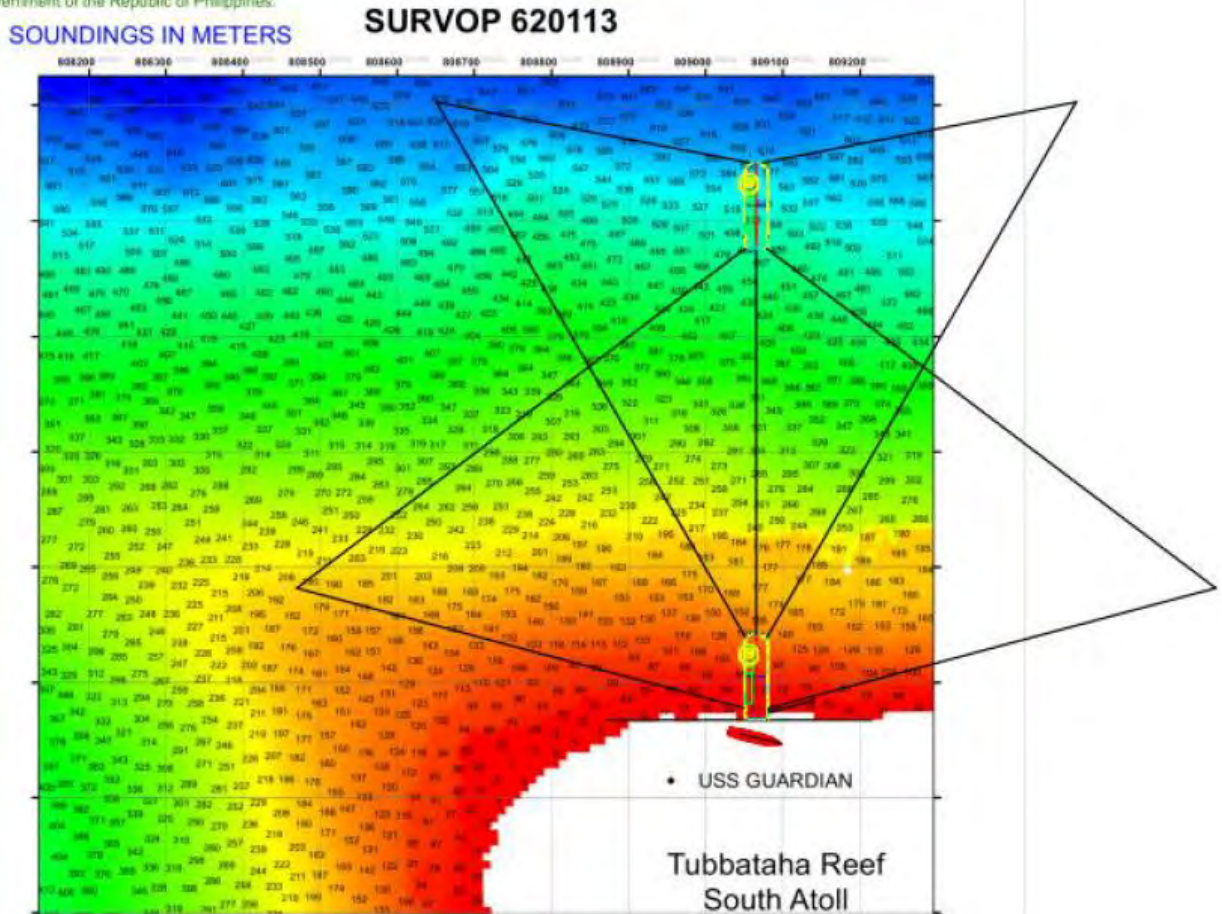

Fig. 2(proposed mooring spread SMIT Borneo)

2 METHODOLOGY

2.1 SUMMARY

Summarized the envisioned works will consist of the following.

- ✘ Crane Barge SMIT Borneo (with 500 MT revolving crane) is anchored on one anchor wire on a safe distance from the reef and the USS Guardian.
- ✘ Mobilization of Jascon 25 from Singapore to site estimated ETA the 15th of February (onsite custom clearance).
- ✘ Mobilization of deck barge from Subic
- ✘ Remove main mast
- ✘ Remove funnel
- ✘ Remove cable reel on fantail
- ✘ Remove 02 level of superstructure
- ✘ Removal equipment 02 level
- ✘ Remove 01 level in two parts
- ✘ Removal of heavy machineries and structures below the main deck
- ✘ Depending on weight distribution cut hull in sizable sections and lift off the reef one by one on to a barge.
- ✘ Rigging hull sections on the barge.

2.2 TASKS AND DUTIES OF ONSITE CRAFT

Designated tasks of all craft involved will be summarized below, in order to get a good understanding of onsite activities after the Jascon 25 has arrived on site.

Jascon 25

This vessel will function as main asset to dismantle the USS GUARDIAN and will also function as an accommodation platform for the salvage crews of the US Navy and SMIT Salvage.

Barge S-7000*(double banked with Barge SMIT Borneo)*

Storage of wreck sections.

SMIT Borneo*(double banked with Barge S-7000)*

Handling and processing of wreck sections on the barge S-7000

Archon Tide

Loading wreck sections and waste from the Jascon 25 and transfer this material to the SMIT Borneo, which will load it on to the barge

Trabajador

Handling tug for the Barge S-7000 and general support

Initrepid

Handling tug for the barge S-7000 and general support

2.3 ARRIVAL OF JASCON 25 AND BARGE "S-7000" ON SITE

The Jascon 25 will set up on site after onsite custom and immigration formalities have been completed and after having performed DP trials.

The Barge "S-7000" will be moored starboard alongside the SMIT Borneo.

See fig. 3 and 4.

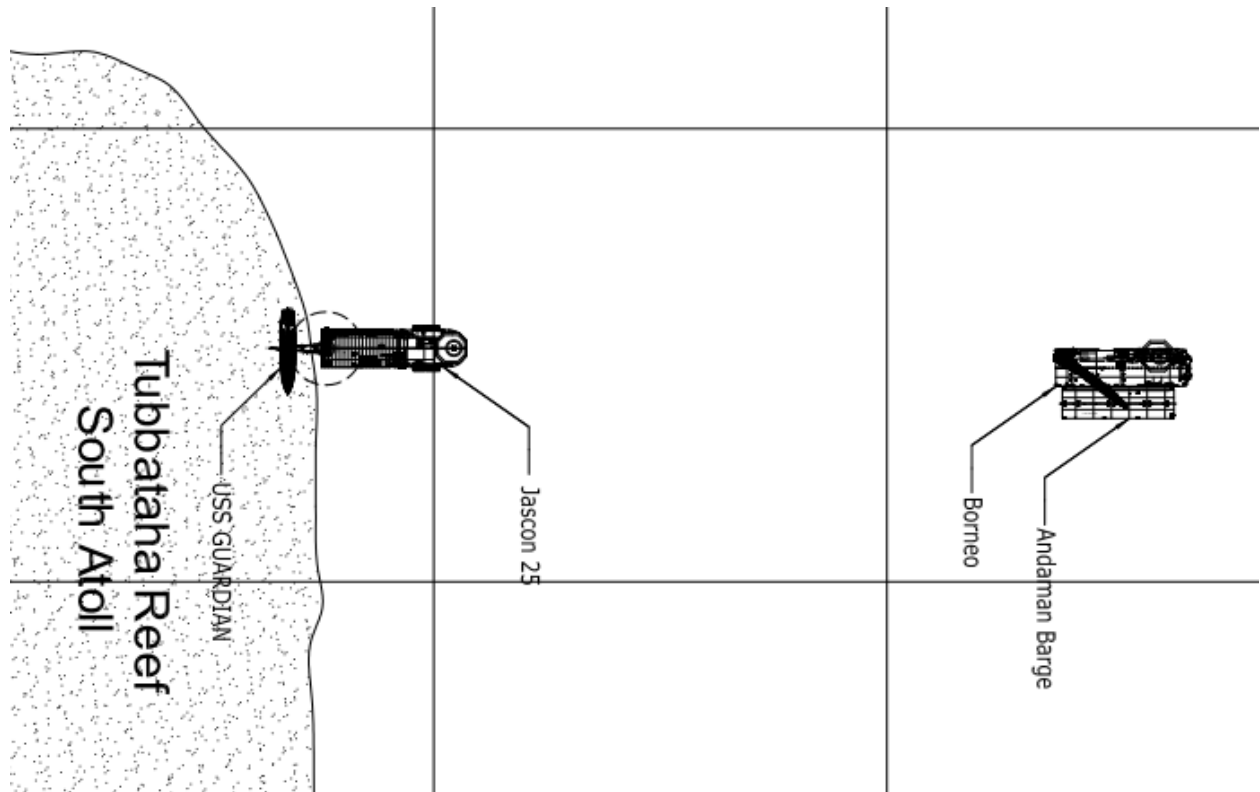

Fig.4 (field layout during dismantling of the casualty)

2.4 REMOVAL EQUIPMENT FROM SUPERSTRUCTURE AND WEATHER DECK

Directly after setting up on site, the Jascon 25 will commence with the offloading of the equipment on the fantail, masts funnel and all other accessible heavy parts from superstructure and main deck and transfer those to the stern of the Archon 25.

2.5 FURTHER REMOVAL OF INVENTORY

After all heavy and dismountable objects have been removed from the superstructure and the weather deck, attention will be given to further removal of all loose inventory inside the superstructure and below the

weather deck. All this material will be disposed in an open top containers, which will be hung off the side of the USS Guardian with the Jascon 25 crane.

2.6 REMOVAL OF SUPERSTRUCTURE

Once level 2 has been emptied out, slings will be installed in and through the level 2 section where after this level will be separated from level 1 working from the inside out. Near to completion of the final cuts, the slings will be connected to the crane.

Once the crane is connected, the last remaining cuts will be made to separate level 2 from level 1.

Once being cut, level 2 will be lifted up one meter and being kept in that position to inspect the integrity and stability of the lift. When it is deemed that the lift is safe and that there are no loose sections, which may fall off on the reef, this section will be swung over from the USS Guardian to the Archon Tide.

Level 1 will be removed in two sections and the same removal method applies for those sections as for level 2.

If for any reason those sections cannot be taken onboard of the Archon tide, this section will be swung over to the Jascon 25 deck where after she will be moved 300 meters clear of the reef. The barge will then be maneuvered in front of the Jascon 25, where after the section can be landed on the barge.

2.7 REMOVAL OF MACHINERIES AND STRUCTURES BELOW THE MAIN DECK

If not already, the machineries from the AMR and MMR will be disconnected from foundations, where after they can be lifted from the machinery spaces. Structural cross members will be kept intact as far as reasonable and practicable.

Depending on the structural condition of the bow section from (forward frame 41) and stern section (aft of frame 81) it may be decided to continue

removing the interior with leaving structural cross members as much as possible intact. Caution will be exercised using absorbents to mitigate residual hydrocarbons.

2.8 REMOVAL FROM THE HULL

2.8.1 General

It is important that the critical structure of the hull be removed within a good weather period of at least 3 to 4 days, this is to avoid the hull for breaking up when the interior becomes exposed to open sea after the removal of the first hull section.

2.8.2 Cutting and slinging the bow forward of AMR

Prior to the commencement of the cutting of the bow, it will be attempted to install a belly slings from frame 35 to forward. One forward sling can already be taken through the bow thruster opening. This specific sling may assist in the partly lifting of the bow to facilitate the installation of messengers and later installation of belly slings.

If the partial lifting of the bow will not be possible for any reason, it may be attempted after the keel and lower parts of the side shell have been cut

The bow will be cut in the vicinity of frame 41, leaving the bulkhead of the AMR intact. The cutting will be done with hydraulic chain saws, hydraulic cutoff saws and pneumatic grinders.

Once the slings are around, the bow will be lifted above the waterline and carefully observed. Once the lift is deemed to be safe, it will be lifted higher and swung over to the main deck of the Jascon 25, where it will lowered till it touches the main deck slightly. The Jascon 25 will now move backward on a safe distance from the reef of 300 meter. The barge will then be maneuvered alongside of the Jascon 25, where the bow section can be landed on the barge.

2.8.3 Removal of MMR and AMR

It is also anticipated that the sections of the MMR and AMR cannot be lifted as one section as they may have been disintegrated significantly by that time. The actual situation by that time will dictate how the removal of those sections can be performed.

For this reason there are mechanical and hydraulic grabs on site, which may assist in the removal of those sections between frames 81 and 41.

2.8.4 Removal of the stern aft of frame 81

Due to the shape of this section it is expected that the installment of belly slings will be relatively easy.

Once the slings are around, the stern will be lifted above the waterline and carefully observed. Once the lift is deemed to be safe, it will be lifted higher and swung over to the main deck of the Jascon 25, where it will be lowered till it touches the main deck slightly. The Jascon 25 will now move backward on a safe distance from the reef of 300 meter. The barge will then be maneuvered in front of the Jascon 25, where after the section can be landed on the barge.

2.9 SEAFASTENING OF HULL SECTIONS

The hull sections will be laid down on dunnage where after the sections will be sea fastened with studs.

3 REOURCES

In order to perform the operation; personnel, craft and equipment has been mobilised and part of it is already working at location. The marine spread will further be extended with the DP crane barge "Jascon 25" and the flat top barge "S-7000" are. Resources may be extended and will be done in close consultation with the US Navy prior mobilization.

3.1 MARINE SPREAD

The marine spread will consist of the following assets;

Description	Detail
Trabajador	Tug Towing barge S-7000 and general assistance
SMIT Borneo	Crane barge
Intrepid	Handling barge S-7000 and general assistance
Archon Tide	DP2 tug towing SMIT Borneo, anchor handling and general assistance
Barge S-7000	To accommodate hull sections
Jascon25	DP crane barge

Description	Detail
USNS T-ARS	US Navy salvage support vessel

3.2 EQUIPMENT

A broad equipment will be shown below and it may very well be possible that more equipment will be required during the process of dismantling

Description	Detail
Hydraulic Chain saws	Cutting superstructure and hull
Hydraulic cutoff saws	Cutting superstructure and hull
Pneumatic grinders	Cutting superstructure, hull, metal alloy structures
Variety of pneumatic drills	
Variety of pneumatic hammers	
Hydraulic cutters	Cutting metal alloy structures

Decompression chamber	When diving over 15 meter
Complete diving spread	When material needs to be recovered from reef
LARS system	To launch divers safely from the crane barge
Closed Hydraulic grabs	To remove disintegrated wreck sections
Wreck grab HDW 2	To remove disintegrated wreck sections
Variety of open to containers	To load recovered inventory and debris
Variety webbing slings	To lift wreck sections
Variety wire slings	To lift wreck sections and machineries

3.3 PERSONNEL

The current amount of personnel on location is;

Description	No.
Salvage Master	1
Salvage Superintendant	3
Naval Architect	1
Salvage Engineer	1
Diver foreman	1
Diver/riggers	8
Shore coordinator through agent	1
Total	16

Description
NAVSEA SUPSALV Task Unit
Mobile Diving and Salvage Unit 1 Command Element and Company 1-6 and 1-2

The amount of personnel will most likely be expanded when the wreck removal works will commence. This will be done in consultation with the US Navy who are also making personnel available.

4 SAFETY HEALTH & ENVIRONMENT

4.1 SAFETY

The project will be executed whilst adhering to safety policy and procedures as laid down in SMIT Group Corporate Safety Manual and applicable clauses and conditions of NAVSEA SUPSALV contract (N00024-12-D-4120).

Furthermore all applicable laws, rules and regulations and common procedures applicable to location, nature and type of work will be taken into consideration and abided by after review with owners. SMIT is dedicated to Safety and Safe working practices. Safety and provision of a safe working environment are business objective for all SMIT companies worldwide.

The general safety procedures will be effected and follow project specific safety regulations/ issues.

During the project a qualified Medic will be on board the SMIT Borneo and/or JASCON 25.

A portable pump is available on board for supply of water in case of fire. Furthermore there are multiple fire extinguishers and SCBA-sets available.

4.2 ENVIRONMENTAL

The project will be executed whilst adhering to environmental policy and procedures as laid down in SMIT Group Corporate Safety Manual and applicable clauses and conditions of NAVSEA SUPSALV contract (N00024-12-D-4120).

At the time of submitting this draft methodology nearly all hydrocarbons have been transferred from the casualty to the VOS Apollo. Some smaller tanks needs to be emptied and will be done as soon as practically possible since these are submerged in the engine room spaces. Skimming of the engine- and hold spaces will continue as and when required.

Loose items on board of the vessel have been removed as far as practicable and this process will continue until the vessel is empty so that the

environmental impact has been mitigated if the condition of the vessel further deteriorates.

The freezer and cold stores containing perishables have been damaged and the contents will be re-packed in plastic bags and being send ashore for disposal.

As most of the works for removal of the vessel will be done on deck and inside the hull it is anticipated that the amount of debris entering the water is minimal. During the daily toolbox meetings the environmental issue will be addressed so that all team members are aware of their responsibility.

When cutting the hull it is anticipated that water will flow out which had been trapped inside. To avoid debris spreading over the reef if it comes out of a section it is anticipated that a containment barrier will be placed on the reef to collect it.

On the Borneo anti-pollution equipment is readily available such as oil booms, absorbent oil booms, skimming equipment etc.

5 COMMUNICATION

5.1 GENERAL COMMUNICATION

A daily work report with a summarized list of present and scheduled activities will be prepared on site and submitted by the SMIT office in Singapore. The report will be distributed daily to the Clients via our SMIT Singapore office.

Salvors will communicate all relevant information to Client and concerned parties.

5.2 ON SITE COMMUNICATION

Team communication on site is verbal and through hand-held VHF radios.

Daily toolbox meetings will be held prior commencement of the works. Additional toolbox meetings will be held as and where required.

5.3 WORKING LANGUAGE

Working language on site is English.

6 POINTS OF CONSIDERATIONS

At this stage in the project numerous items still needs to be adressed and worked out. A number of items are adressed in this section but will not be complete as more issues will arise while time progresses.

1. Prevailing Northeast-monsoon conditions and associated weather and sea state inducing increased dynamic motions on vessels and crane barges for the foreseeable future.
2. Structural integrity of the vessel. This will most likely deteriorate over time and especially during adverse weather conditions during NE-monsoon.
3. Full assessment of the bottom damage to be made once skimming has been completed.
4. While the vessel is becoming lighter during removal of the structure it will become increasing subject to the elements.
5. Casualty is approximately 15 meters upon the reef causing reduced closing in of vessels and crane barge.
6. (Dis)-embarking of personnel. During calm sea state conditions casualty can be boarded on port quarter by pilot ladder. When not possible due to the sea state, team members need to jump in the water, swim over the reef and board casualty on starboard site.
7. Evacuation of team members if an incident occurs.
8. Remaining liquids in lines to be cut in engine room.
9. Working method for cutting the hull into sections.
10. Stability of the remaining casualty after cutting of a section.
11. Positioning of crane barges close to the edge of the reef.
12. Remote location, long supply chain.
13. Environmentally sensitive and protected area.
14. Composition of the hull with nails through the layers. During sawing these may obstruct the sawing line.
15. Apparently the inside of the hull in way of the engine rooms are painted and in the upper part laminated with GRF. This will obstruct

the visibility of the nails and need to be visible prior cutting for safety reasons.

16. Prior making a cut inside the hull items need to be removed.
17. Thickness of the strong points and in particular the keel.
18. As the engines are submerged in salt water the US Navy may wish to consider treatment of the engines, gearboxes etc. once relevant sections have been lifted to temporarily postpone corrosion while being exposed to air.

7 TIMELINE

The timeline is for indication purposes only and partly based on assumptions. Activities may be combined reducing the time required to execute the works. Assumptions are subject availability of the amount of personnel and based on uninterrupted workability of assets. Waiting on weather is not accounted for. Timeline is based on daylight working hours only. While more details become known the timeline will be finetuned. Restoration of the reef after the wreck is gone has not been accounted for.

The time line will not show the past works, which haven been executed already



SMIT SINGAPORE PTE LTD

SMIT Singapore Pte Ltd
23 Gul Road
Singapore 629356

PHONE:

+65 666 84 222

FAX:

+65 666 84 333

E-MAIL:

SALVAGE.SIN@SMIT.COM

URL:

WWW.SMIT.COM

This page intentionally left blank.

APPENDIX H



This page intentionally left blank.



SALVAGE

LIFTING PLAN OF HULL SECTIONS “USS GUARDIAN”

DATE	20th March 2013
PROJECT NAME	Wreck removal “USS Guardian”
PROJECT NUMBER	5560
CLIENT	US Navy
DRAFTED BY	Wytse Huisman
VERSION/REVISION	3

Appendix H - Lifting Plan

TABLE OF CONTENTS.

1	INTRODUCTION.....	4
1.1	GENERAL	4
2	GENERIC LIFTING PLAN FOR HULL SECTIONS	6
2.1	SUMMARY	6
2.2	TASKS AND DUTIES OF ONSITE CRAFT.....	9
3	SAFETY HEALTH & ENVIRONMENT	10
3.1	SAFETY	10
3.2	ENVIROMENTAL	10
4	OIL SPILL RESPONSE	11
4.1	General	11
4.2	Oil spill response plan.....	12
5	COMMUNICATION	14
5.1	GENERAL COMMUNICATION	14
5.2	ON SITE COMMUNICATION	14
5.3	WORKING LANGUAGE.....	14
6	Attachments	15
6.1	RIGGING PLAN AND ARTIST IMPRESSION OF THE BOW LIFT.....	16
6.2	RIGGING PLAN AND ARTIST IMPRESSION MMR and AMR LIFT	17
6.3	RIGGING PLAN OF STERN LIFT	18
6.4	FIELD LAYOUT	19
6.5	HULL SECTIONS ON JASCON25 DECK.....	20
6.6	CALCULATIONS STERN SECTION	21

1 INTRODUCTION

1.1 GENERAL

The USS Guardian has been lightened already substantially since the on-site arrival of the Jascon 25 as the whole superstructure, substantial engineering machinery, and material inventory has largely been removed.

Special attention has been given to the AMR and MMR section with regards to the removal of marine pollutants and the prevention of objects falling from underneath the casualty as the bottom of the engine room is holed as a result of the grounding.

Despite the fact that thorough attention has been given to the removal of hydrocarbons, a situation may arise where oil escapes from the hull as oil may be trapped in small pockets inside the machinery spaces and ships structures. For this particular reason there is an oil pollution response craft on site, ready to combat sheens of oil, escaping from recovered hull sections. The oil spill response plan is described in chapter 4

The hull will be cut into 4 sections and the weight of the hull sections are varying around 200 to 250 ton. The hull sections are divided as follows:

- Section 1 → Bow → Frame 00 to 42
- Section 2 → AMR → Frame 42 to 62
- Section 3 → MMR → Frame 62 to 85
- Section 4 → Stern → From frame 85 onward.

The cut lines are illustrated in the figure 1.

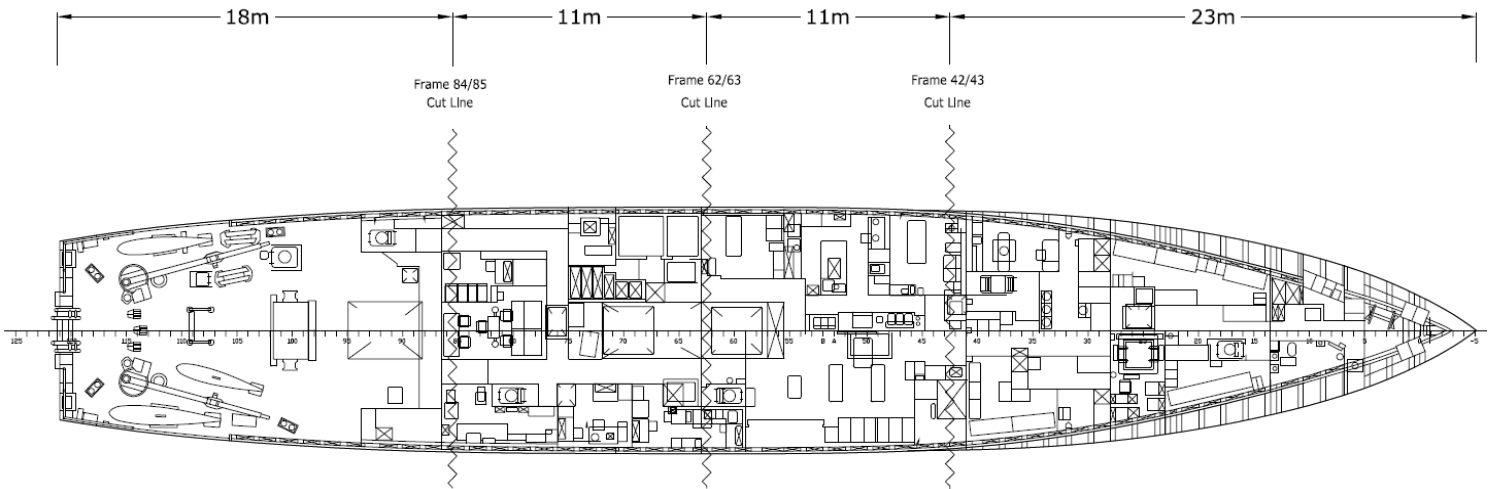

Fig. 1(cut lines of hull sections)

Except for the stern section, the slings are taken through the hull section and are taken around the gunnels and are also supported by the transverse beams. The stern will be lifted by making use of belly slings only.

The rigging arrangements can be found in attachments: 6.1 to 6.3

2 GENERIC LIFTING PLAN FOR HULL SECTIONS

2.1 SUMMARY

The work will consist of the following.

1. The approximate weight of hull section is 200 metric tons but not exceeding 250 metric ton.
2. The Jascon 25 will position itself as much as possible on a 90 degrees angle towards the lift to obtain the optimal lifting position of the crane and to minimize the lifting radius. The exact positioning of the vessel is solely up to the Jascon 25 Master's discretion.
3. Four 20 meter 71 mm slings will be pre-installed on the main hoist of the Jascon 25 Huisman crane as indicated in the schematic drawing in attachments 6.1 to 6.3.
4. The crane will position the slings over the hull section of USS Guardian where the slings will be connected to the pre- installed sling arrangement as indicated in the attached schematic drawing in attachments 6.1 to 6.3.
5. Once connected, the crane will tension the sling arrangement slightly and position itself correctly towards the lift.
6. Tag lines will be made to the port side of the center section. The port side tag lines will be transferred to the Jascon 25.
7. Prior to the final cut, there will be a minimum of crew present onboard of the USS Guardian, which are two cutters, three Navy personnel and four salvage crew.
8. The oil spill response crafts will position themselves downstream of the casualty, ready to combat oil pollution if there is any.

-
9. During the lift, the Salvor RHIB will be standby down current of the USS Guardian.
 10. Radio communications during the lifting procedures will use UHF Channel 1.
 11. Once all is in place and radio checks are completed the crane will tension up to slightly, just enough to take the slack out rigging.
 12. The hull section will be lifted, suspended, and held momentarily to allow possible loose hanging parts to drop down on the previous foot print of the hull section. This is to minimize the risk of debris falling on the reef when the lift is transferred to the Jascon 25 deck.
 13. The lift will be swung over to the designated landing area on the Jascon 25 deck, which is prepared with dunnage, where it will be lowered until it is just resting on the deck with the crane still hooked up to the load, as indicated in the attached drawings in *attachments 6.5*
 14. The Jascon 25 will move away from the reef on ADP and proceed to the S-7000 barge, which is moored alongside the SMIT Borneo. The SMIT Borneo is at anchor near the reef as shown on the attached drawing in attachment 6.4 It is up to the Jascon 25 Master's competence and discretion how the Jascon 25 will be positioned towards the barge S-7000 when landing the section.
 15. Six salvage crew will proceed to the barge S-7000 to assist during the landing of the hull section. They will prepare the dunnage on deck, such that it can be landed directly once the Jascon 25 reaches the barge S-7000.
 16. A reference beacon will be pre-installed on the SMIT Borneo, such that there is a good DP reference during the landing of the section on to the barge.

17. The tug Archon Tide will be connected to the stern of the SMIT Borneo. This to maintain a steady heading during the landing of the hull section onto the barge.

18. The slings will be disconnected from the main block and laid down on the lift, where after they can be recovered by the SMIT Borneo crane.

2.2 TASKS AND DUTIES OF ONSITE CRAFT

Designated tasks of all craft involved are summarized below.

Jascon 25

To lift each section and land them on the barge S-7000.

Barge S-7000 *(double banked with Barge SMIT Borneo)*

Storage of wreck sections.

SMIT Borneo *(at anchor near reef)*

Handling and processing of wreck sections on the barge S-7000

Archon Tide

General assistance and support during the lifting operation and being connected to the stern of the SMIT Borneo to maintain a steady heading during the landing of the center section on the bare S-7000.

Intrepid

This tug is dedicated to oil spill response activities.

SMIT Rescue

This RHIB will assist the Intrepid in oil spill response activities and infield transportation of crew.

Salvor RHIB

This RHIB is present as standby and safety craft and infield transportation of crew.

3 SAFETY HEALTH & ENVIRONMENT

3.1 SAFETY

The project will be executed whilst adhering to safety policy and procedures as laid down in SMIT Group Corporate Safety Manual and applicable clauses and conditions of NAVSEA SUPSALV contract (N00024-12-D-4120).

Furthermore all applicable laws, rules and regulations and common procedures applicable to location, nature and type of work will be taken into consideration and abided by after review with owners. SMIT is dedicated to Safety and Safe working practices. Safety and provision of a safe working environment are business objective for all SMIT companies worldwide. The general safety procedures will be effected and follow project specific safety regulations/issues.

During the project a qualified Medic will be on board the SMIT Borneo and/or JASCON 25.

3.2 ENVIROMENTAL

The project will be executed whilst adhering to environmental policy and procedures as laid down in SMIT Group Corporate Safety Manual and applicable clauses and conditions of NAVSEA SUPSALV contract (N00024-12-D-4120).

Loose items on board of the vessel have been removed as far as practicable

Despite the fact that utmost attention has been given to remove all marine pollutants prior to the lift, oil absorbent containment barriers and an offshore oil boom will be kept ready for immediate deployment. This oil spill response material will be positioned on an oil spill response craft, which will be positioned downstream of the casualty.

4 OIL SPILL RESPONSE

4.1 General

All the bunkers from the USS Guardian and have been removed prior to the commencement of the wreck removal activities.

Utmost attention has been given to clean machinery spaces but still there may be some small pockets of trapped oil inside those machinery spaces. This oil may escape from the hull section after those have been separated or being lifted. For that reason an oil spill response craft will be ready during the cutting of the hull and the lifting of hull sections.

The oil spill response craft will be positioned downstream of the casualty and the oil spill equipment will be ready for immediate deployment.

The oil containment barrier will not be placed around the casualty for the following reasons:

1. When there is any oil or debris escaping from the hull section it will always be floating down stream along the reef in southerly directions. For this reason the crafts can recover the oil on a safe distance from the reef, without any contact risk with the reef.
2. When the containment barrier is placed around the casualty, the chains attached to this barrier may contact the reef, which should be prevented.

4.2 Oil spill response plan

The craft involved in the oil spill response activities are the tug "Intrepid" and the RHIB "SMIT Rescue"

The oil spill response equipment onboard of the tug Intrepid includes:

- 2 x 50 meter sections of RO boom including power pack
- 1 x air compressor.
- 1 x skimmer
- 2 x diaphragm pumps.
- 1 x 1m³ holding tank.
- 5 x empty drums of 220 liter.
- Oil absorbent pads.
- Oil absorbent booms.
- Heavy duty plastic waste bags.

As stated earlier, the OSR equipment will be ready for immediate deployment when oil is seen escaping from wreck sections.

It is not expected that large quantities of oil will escape from the casualty and it is anticipated that smaller spills can be handled from the RHIB using oil absorbent booms and pads.

The absorbent booms and pads can be disposed of in the heavy duty waste bags.

In the unlikely event of a larger spill, the RO Boom will be deployed from the Intrepid. The boom will be kept in a U shape position between the Intrepid and the SMIT RHIB. (See below illustration fig.2) The oil can be recovered from within the boom, using the skimmer and absorbent materials.

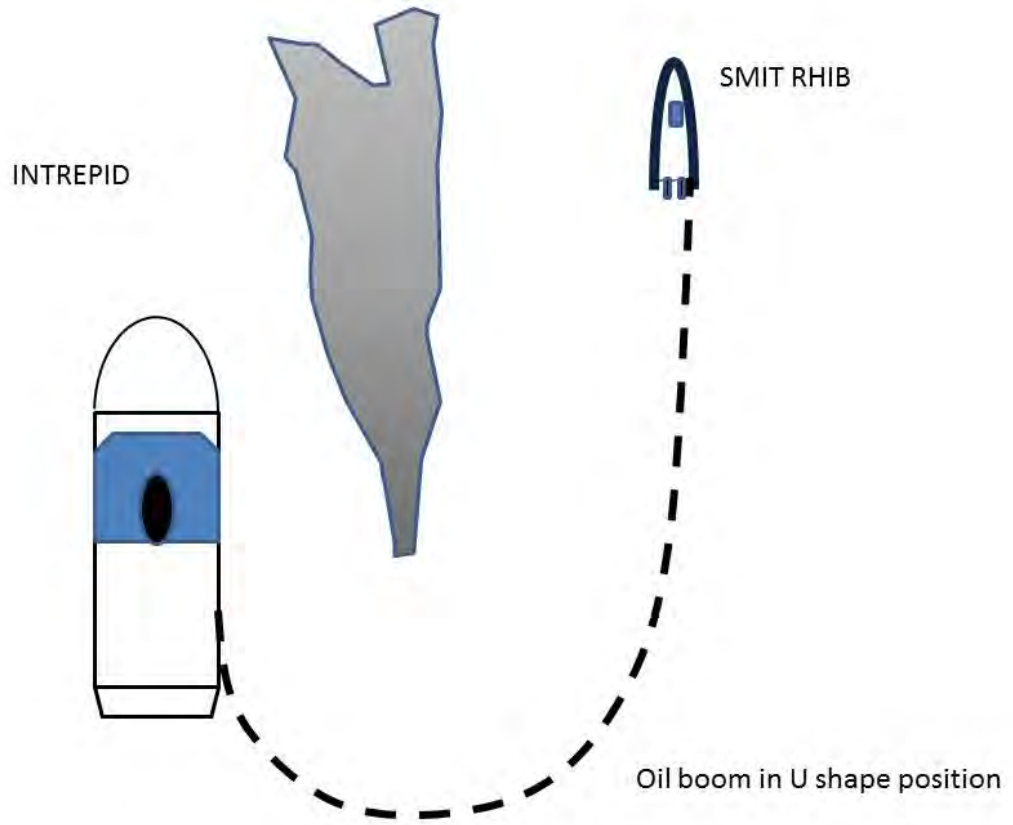

Fig. 2 (OSR vessels keeping boom in U shape)

5 COMMUNICATION

5.1 GENERAL COMMUNICATION

Toolbox meetings will be held prior to the commencement of the lifts.

5.2 ON SITE COMMUNICATION

Team communication on site is verbal and through VHF and UHF radios on the following channels:

- Private SMIT VHF channel 92 for all salvage activities
- UHF channel 1 for the crane operations
- VHF channel 12 for intership communication

5.3 WORKING LANGUAGE

Working language on site is English.

6 Attachments

6.1 RIGGING PLAN AND ARTIST IMPRESSION OF THE BOW LIFT

Rigging Materials for Lifting				
Designation	Materials	Sizes	Quantity	SWL
A	Wire Sling	Ø71mm X 50m Lenght	2	64 MT
B	Shackles	125 ton	4	125 MT
C	Wire Sling	Ø71mm X 20m Lenght	4	64 MT

*note: Lifting height from 01 level of Bow section to hook is 24 meters

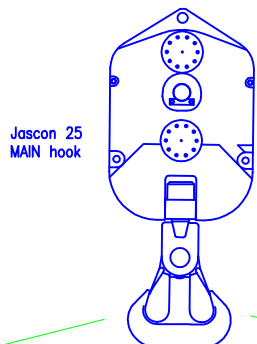

Exit Points on Side Shell	
Legend	Bow Section
①	01 Level Fr. 12/13 P
②	Main Deck Level Fr. 12/13 P
③	01 Level Fr. 34/35 P
④	Main Deck Level Fr. 34/35 P
⑤	01 Level Fr. 12/13 S
⑥	Main Deck Level Fr. 12/13 S
⑦	01 Level Fr. 34/35 S
⑧	Main Deck Level Fr. 34/35 S

*note: dunnages will be installed on lifting / contact points for additional support

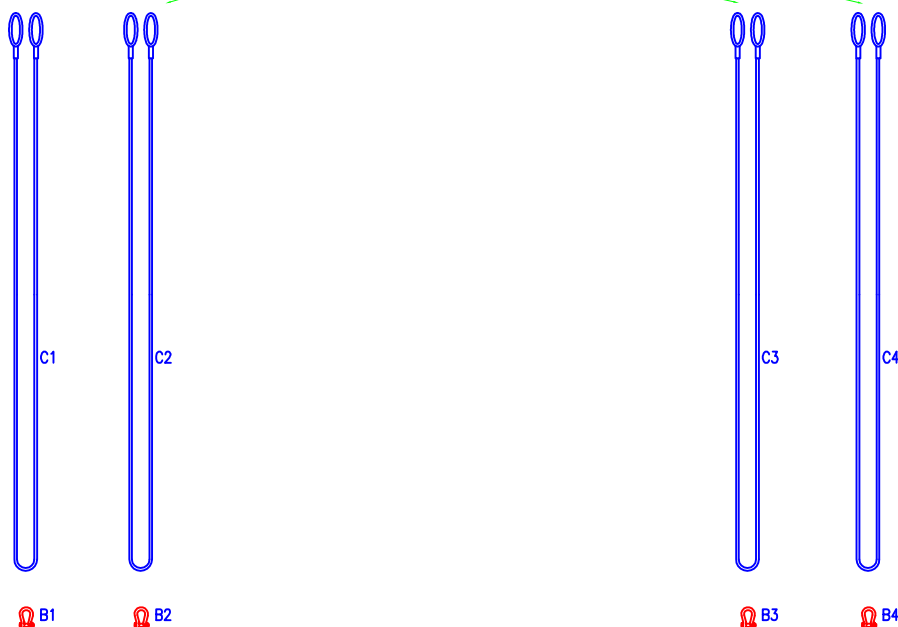

Slings below this line will be Pre Rig on the casualty

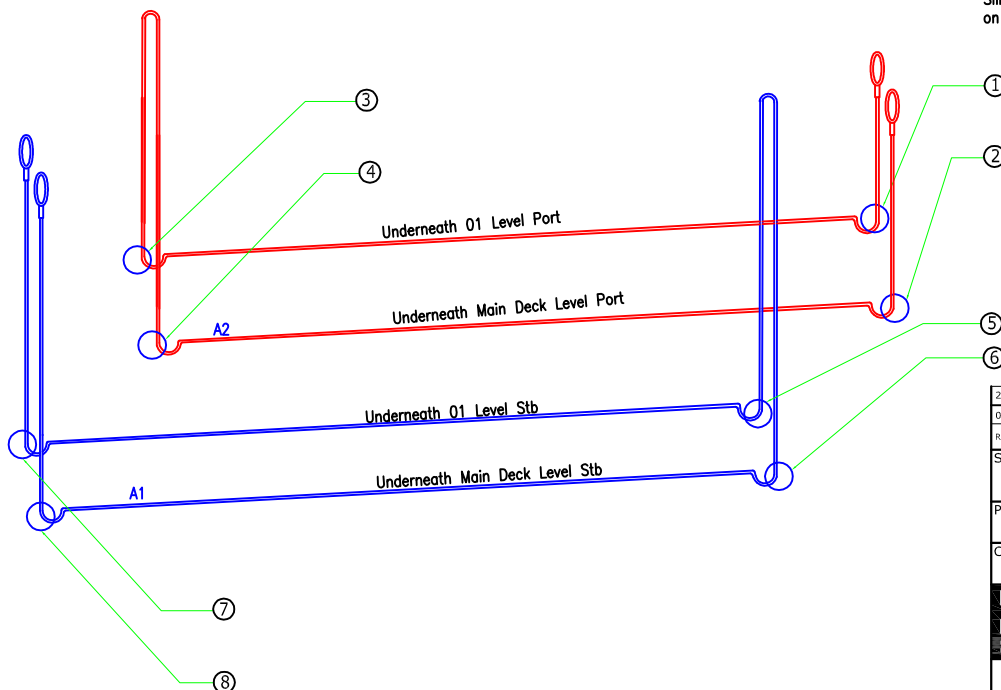

2.0	15-03-13	Seal	Preliminary	Wytse	-----	
0.0	11-03-13	Seal	Preliminary	Wytse	-----	
Rev	Date	Drawn	Description	Chkd	P.Appr	E.Appr

Subject
Rigging Arrangement (Bow)

Project
Salvage of "USS Guardian"

Client

SMIT SALVAGE
23 Gul Road Singapore
E-mail: Sedqufa1@smit.com

CAD-dwg not to be changed manually

Orig. Size

All information and data on this drawing are property of SMIT Singapore Pte. Ltd. No part from that may be disclosed, copied, duplicated or in any other way made use of without written consent or used other than on terms agreed in writing.

Scale
NTS

Drawing No.
J5560-D-007

Sheet

For illustration Purposes Only
Typical Rigging Arrangement for Bow Section
Drawn Not To Scale

Frame 12/ 13 P & S

Frame 12/13 P & S

Frame 34/35 P & S

01 Level

Main Deck Level

Frame 34/35 P & S

Total height from 01 level to Main Hook
24 meters

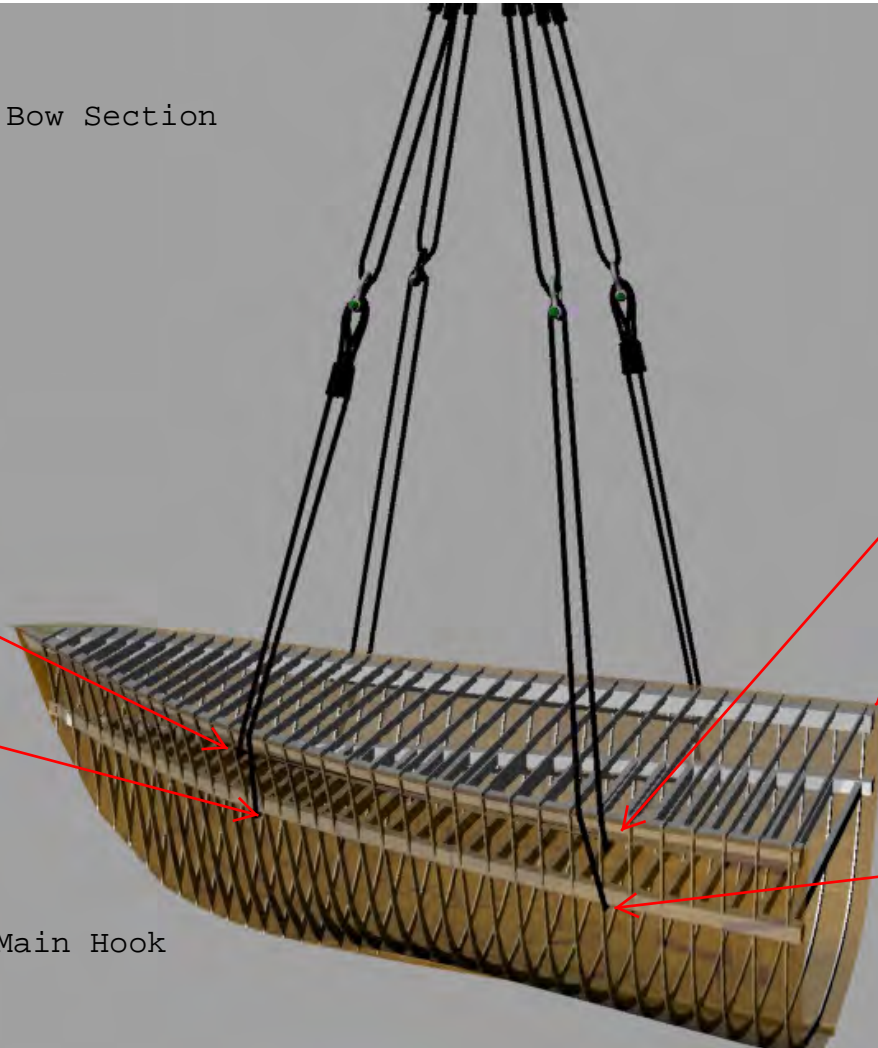

6.2 RIGGING PLAN AND ARTIST IMPRESSION MMR and AMR LIFT

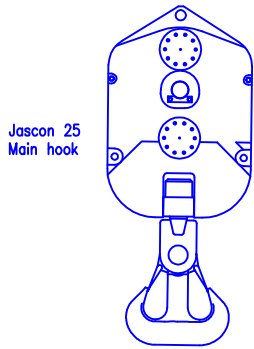

Rigging Materials for Lifting				
Designation	Materials	Sizes	Quantity	SWL
A	Wire Sling	ø71mm X 50m Lenght	2	64 MT
B	Shackles	125 ton	4	125 MT
C	Wire Sling	ø71mm X 20m Lenght	4	64 MT

*note: Lifting height from 01 level of AMR & MMR section to hook is 22 meters

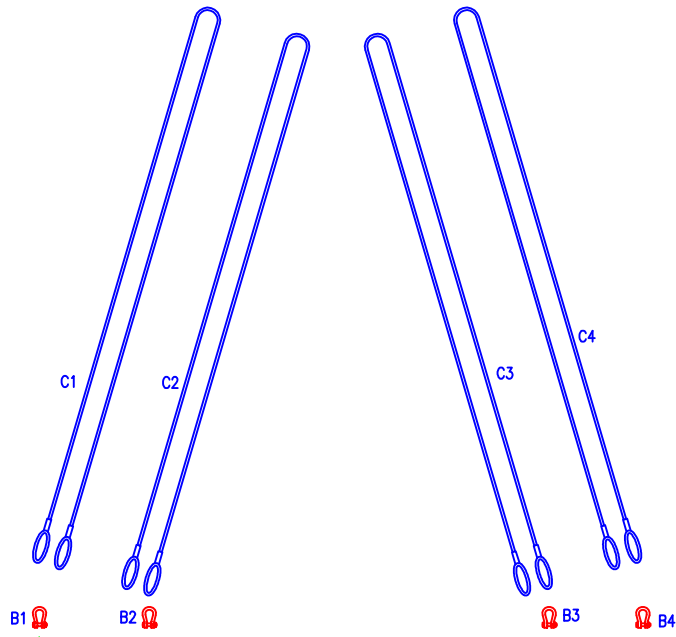

Exit Points on Side Shell		
Legend	AMR Section	MMR Section
①	Main Deck Level Fr. 46/47 P	Main Deck Level Fr. 65/66 P
②	01 Level Fr. 46/47 P	01 Level Fr. 65/66 P
③	01 Level Fr. 46/47 S	01 Level Fr. 65/66 S
④	Main Deck Level Fr. 46/47 S	Main Deck Level Fr. 65/66 S
⑤	Main Deck Level Fr. 58/59 P	Main Deck Level Fr. 81/82 P
⑥	01 Level Fr. 58/59 P	01 Level Fr. 81/82 P
⑦	01 Level Fr. 58/59 S	01 Level Fr. 81/82 S
⑧	Main Deck Level Fr. 58/59 S	Main Deck Level Fr. 81/82 S

*note: dunnages will be installed on lifting/contact points for additional support.

Slings below this line will be Pre Rig on the casualty

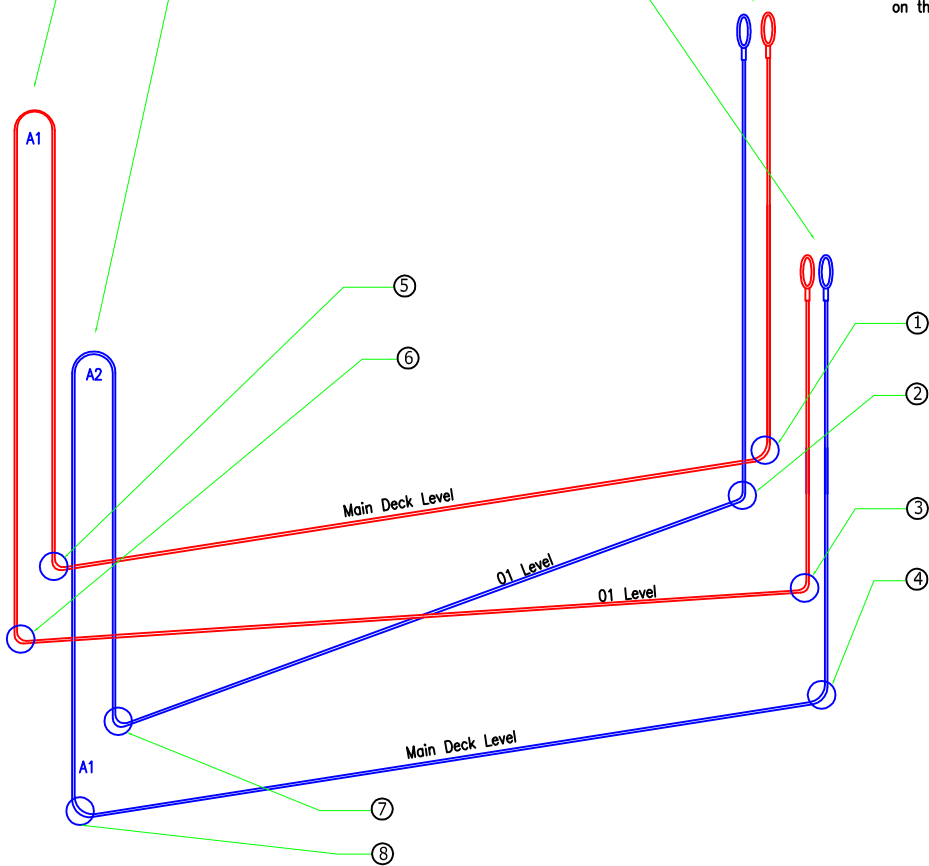

2.0	16-03-13	Seal	Preliminary	Wytse/Jan		
1.0	13-03-13	Seal	Preliminary	Wytse		
0.0	11-03-13	Seal	Preliminary	Wytse	-----	
Rev	Date	Drawn	Description	Chkd	E.Appr	Client
Subject Rigging Arrangement (AMR & AMR)						
Project Salvage of "USS Guardian"						
Client						
SMT SALVAGE 23 Gul Road Singapore E-mail: Sedqulla1@smt.com				CAD-drvng not to be changed manually Orig. Size		
All information and data on this drawing are property of SMT Singapore Pte. Ltd. No part from that may be disclosed, copied, duplicated or in any other way made use of without written consent or used other than on terms agreed in writing.						
Scale	Drawing No.		Sheet			
NTS	J5560-D-007					

For illustration Purposes Only
Rigging Arrangement for AMR Section
Drawn Not To Scale

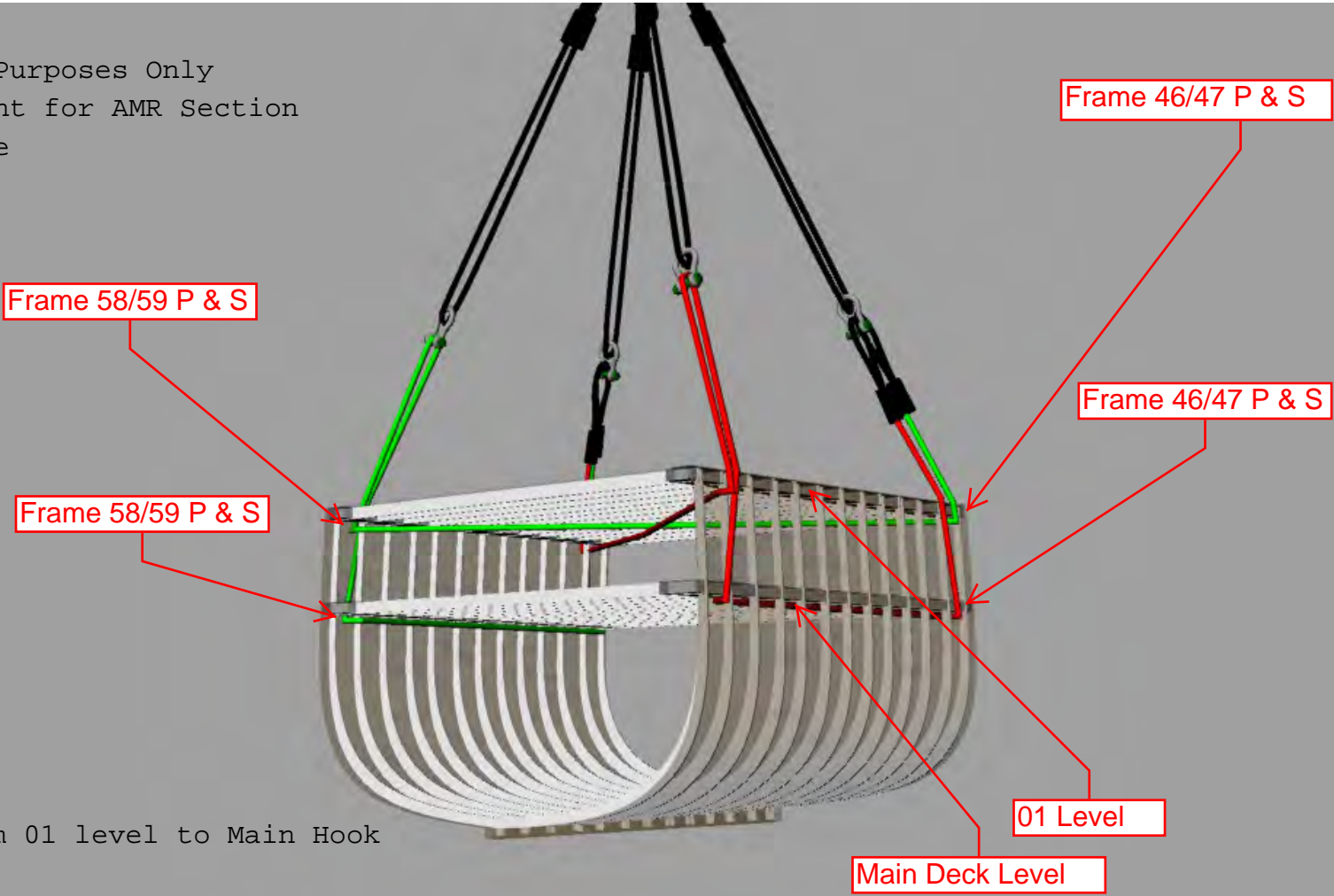

Total height from 01 level to Main Hook
22 meters

For illustration Purposes Only
Rigging Arrangement for MMR Section
Drawn Not To Scale

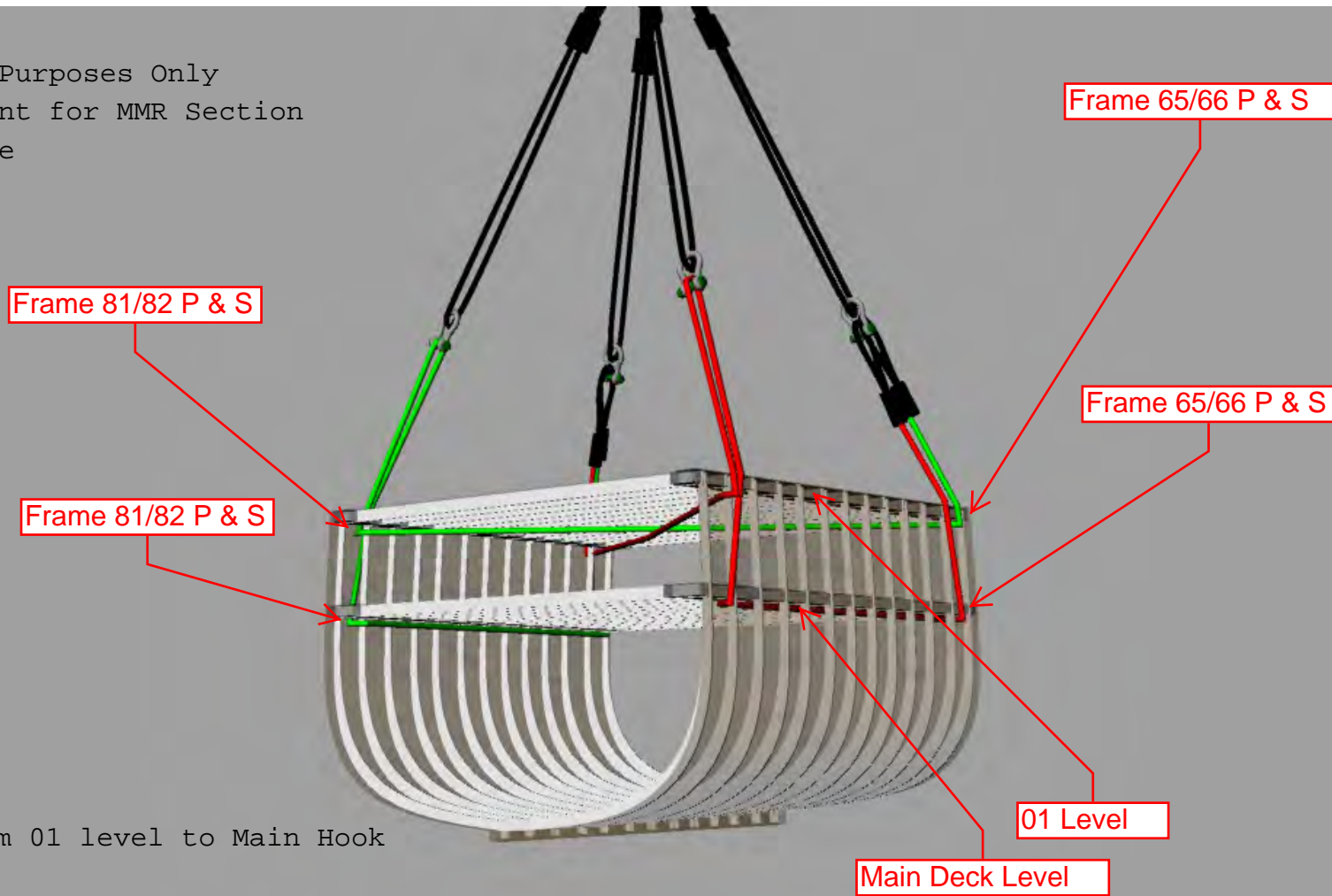

Total height from 01 level to Main Hook
22 meters

6.3 RIGGING PLAN OF STERN LIFT

Jacson 25
Main hook

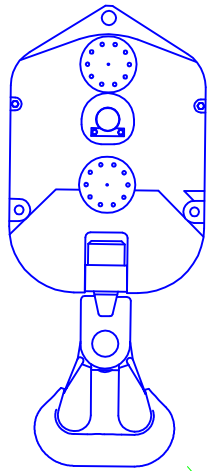

Rigging Materials for Lifting				
Designation	Materials	Sizes	Quantity	SWL
A	Wire Sling	ø71mm X 50m Lenght	2	64 MT
B	Shackles	125 ton	4	125 MT
C	Wire Sling	ø71mm X 20m Lenght	6	64 MT
D	Roller Shackles	200 ton	2	200 MT

*note: Lifting height from 01 level of AMR & MMR section to hook is 20 meters

Exit Points on Side Shell	
Legend	Bow Section
①	Bottom Hull Fr. 110/111 S
②	Main Deck Level Fr. 110/111 P
③	01 Level Fr. 102/103 S
④	Main Deck Level Fr. 102/103 P
⑤	01 Level Fr. 95/96 S
⑥	Main Deck Level Fr. 95/96 P
⑦	01 Level Fr. 89/88 S
⑧	Main Deck Level Fr. 89/88 P

*note: * Dunnages will be installed on lifting / contact points for additional support

* C1 to C6 slings and shackles B and D will be pre rig on the Main hook of Jascon 25

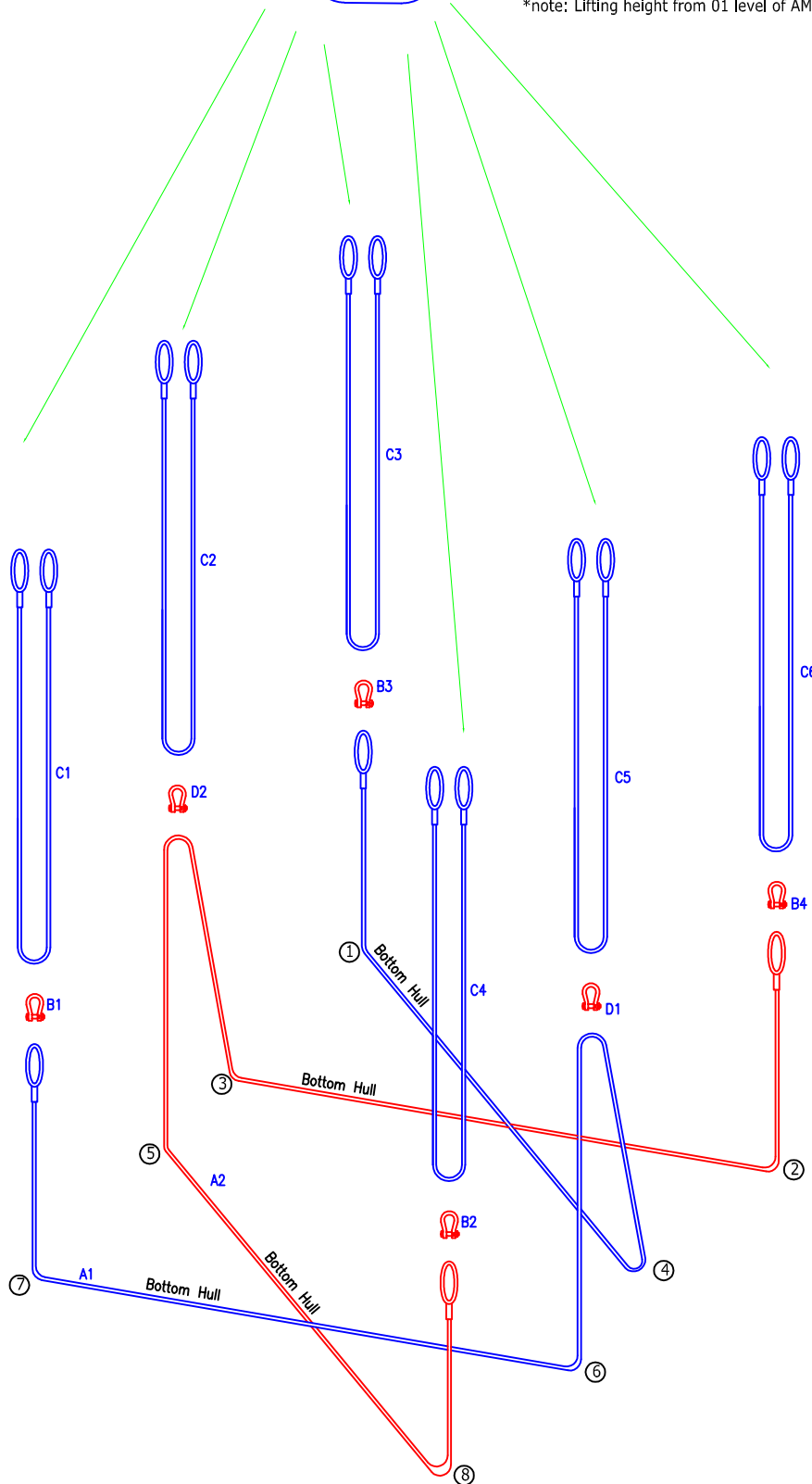

3.0	19-03-13	Seal	Preliminary	Jan		
1.0	13-03-13	Seal	Preliminary	Wytse		
0.0	11-03-13	Seal	Preliminary	Wytse	-----	
Rev	Date	Drawn	Description	Chkd	E,Appr	Client
Subject Rigging Arrangement (Stern)						
Project Salvage of "USS Guardian"						
Client						
SMIT SALVAGE 23 Gul Road Singapore E-mail: Sedqufa1@smit.com				CAD-dwg not to be changed manually Orfg. Size		
All information and data on this drawing are property of SMIT Singapore Pte, Ltd. No part from that may be disclosed, copied, duplicated or in any other way made use of without written consent or used other than on terms agreed in writing.						
Scale NTS		Drawing No. J5560-D-007			Sheet	

6.4 FIELD LAYOUT

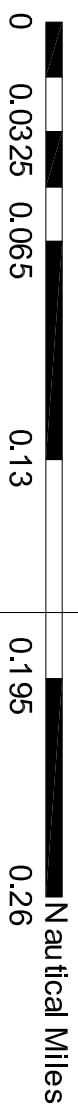

8°48'48"N

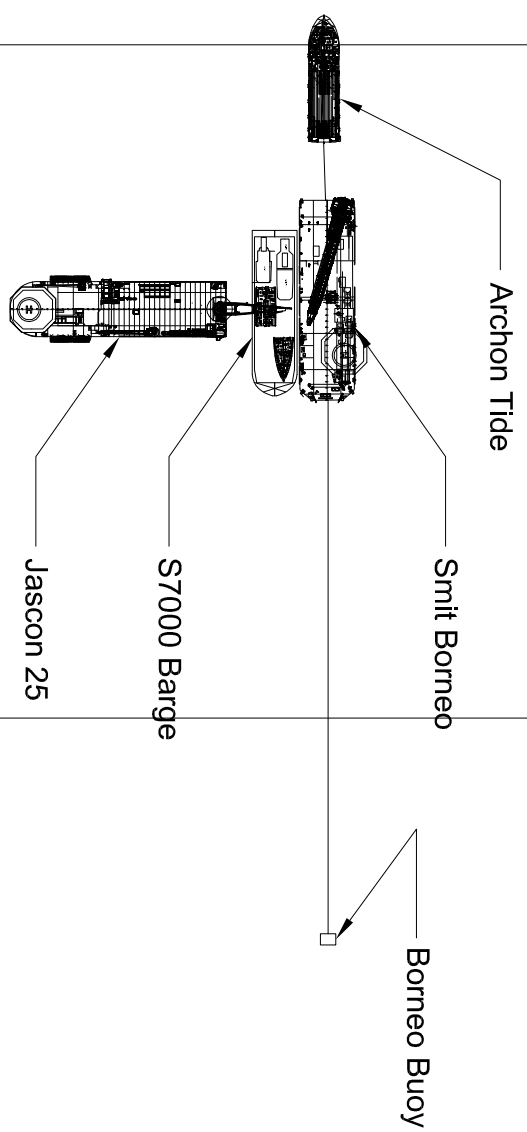

Note
1. For illustration purposes only.

8°48'36"N

USS GUARDIAN

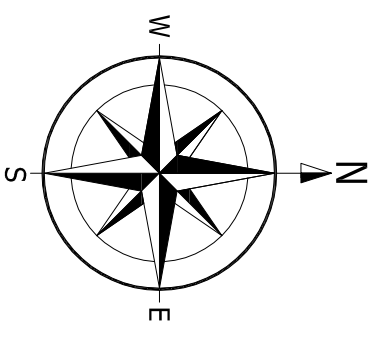

8°48'24"N

Tubbataha Reef
South Atoll

119°48'12"E

119°48'24"E

119°48'36"E

0.0	14-03-13	SEAL	PRELIMINARY	WYSE			
Rev	Date	Drawn	Description	Chkd	P-Appr	E-Appr	Client
Subject: Vessels Spread Lay-out (Landing of Hull Sections)							
Project: Salvage of "USS Guardian"							
Client:							



SMIT SALVAGE
23 Gull Road Singapore
E-mail: S.Edquill@smiit.com

CAD-dwg not to be changed manually
Orig. Size

All information and data on this drawing are property of SMIT Singapore Pte. Ltd.
No part from that may be disclosed, copied, duplicated or in any other way made use of without written consent or used other than on terms agreed in writing.

Scale: NTS
Drawing No. JN 5560-D-012

6.5 HULL SECTIONS ON JASCON25 DECK

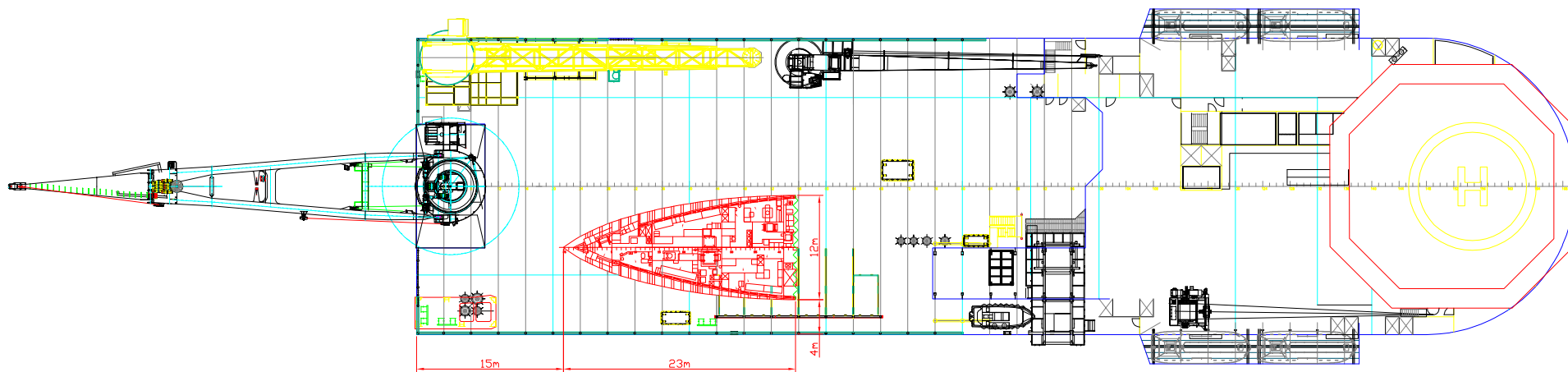

Bow Section Dimension

Lenght O	23meters
Breadth	12 meters
Height	9 meters

Jascon 25 Particulars

Lenght Over All	118.8 meters
Breadth Moulded	36.40 meters
Depth	8.40 meters

Note:
 *All dimension are in meters unless otherwise specified
 *For illustration purposes only
 *Dunnage will be put in place on deck of Jascon before landing

0,0	14-03-13	Seal	Preliminary	Wytse	-----	
Rev	Date	Drawn	Description	Chkd	P.Appr	E.Appr

Subject
 Landing on Jascon 25 (Bow Section)

Project
 Salvage of "Uss Guardian"

Client

	SMIT SALVAGE 23 Gul Road Singapore E-mail: S.Edquila@smit.com	CAD-Drwg not to be changed manually
		Orig. Size

All Information and data on this drawing are property of SMIT Singapore Pte. Ltd.
 No part from that may be disclosed, copied, duplicated or in any other way made use of
 without written consent or used other than on terms agreed in writing.

Scale	Drawing No.	Sheet
NTS	JN 5560-D-012	1 of 4

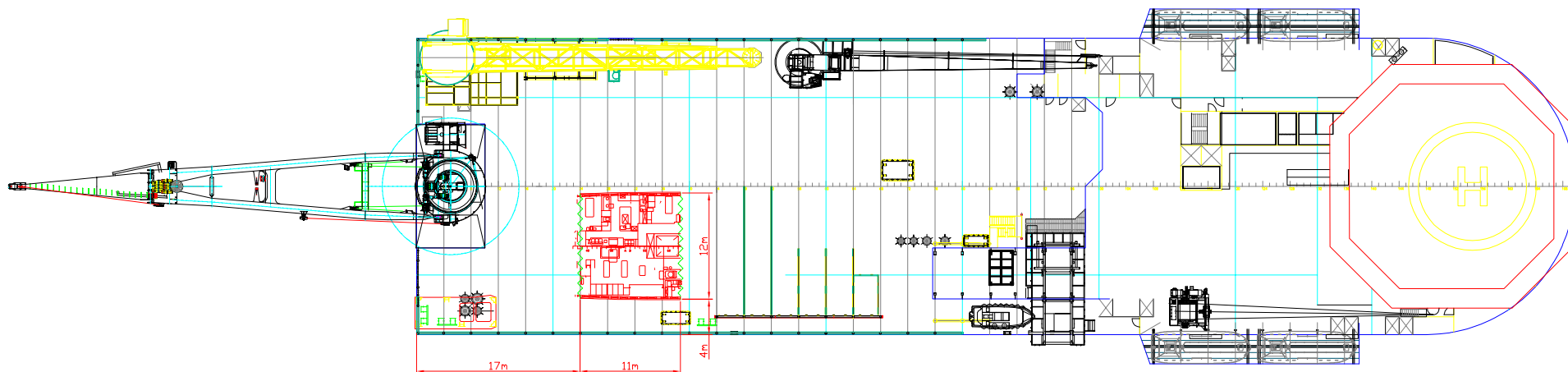

AMR Dimension

Lenght	11meters
Breadth	12 meters
Height	9 meters

Jascon 25 Particulars

Lenght Over All	118.8 meters
Breadth Moulded	36.40 meters
Depth	8.40 meters

Note:
 *All dimension are in meters unless otherwise specified
 *For illustration purposes only
 *Dunnage will be put in place on deck of Jascon before landing

0,0	14-03-13	Seal	Preliminary	Wytse		-----	
Rev	Date	Drawn	Description	Chkd	P.Appr	E.Appr	Client
Subject Landing on Jascon 25 (AMR)							
Project Salvage of "Uss Guardian"							
Client							
	SMIT SALVAGE 23 Gul Road Singapore E-mail: S.Edquila@smit.com						CAD-Drwg not to be changed manually
							Orig. Size
All information and data on this drawing are property of SMIT Singapore Pte. Ltd. No part from that may be disclosed, copied, duplicated or in any other way made use of without written consent or used other than on terms agreed in writing.							
Scale	Drawing No.		Sheet				
NTS	JN 5560-D-012		2 of 4				

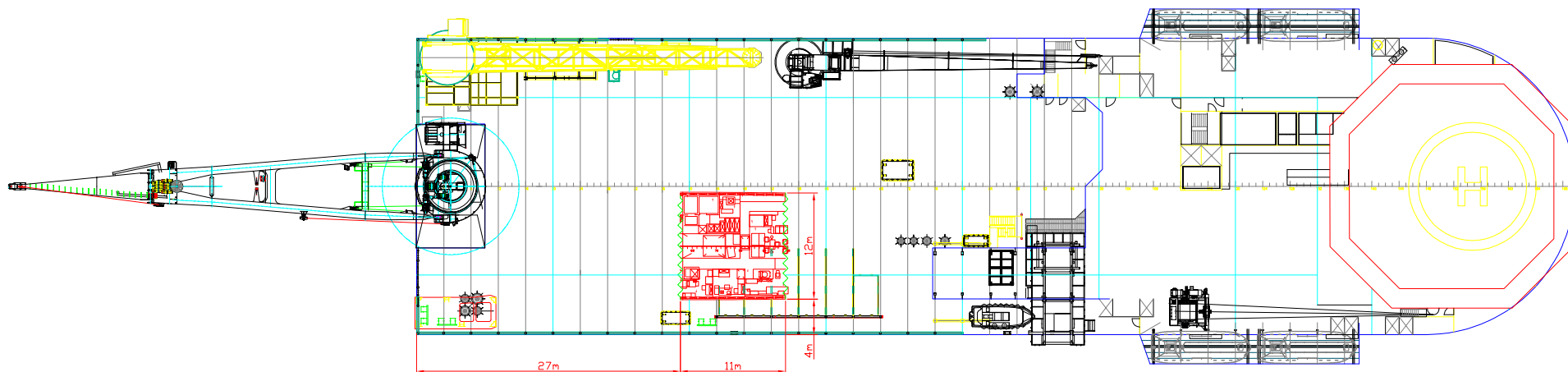

MMR Dimension

Lenght	11meters
Breadth	12 meters
Height	9 meters

Jascon 25 Particulars

Lenght Over All	118.8 meters
Breadth Moulded	36.40 meters
Depth	8.40 meters

Note:
 *All dimension are in meters unless otherwise specified
 *For illustration purposes only
 *Dunnage will be put in place on deck of Jascon before landing

0,0	14-03-13	Seal	Preliminary	Wytse	-----	
Rev	Date	Drawn	Description	Chkd	P.Appr	E.Appr

Subject
 Landing on Jascon 25 (MMR)

Project
 Salvage of "Uss Guardian"

Client

	SMIT SALVAGE 23 Gul Road Singapore E-mail: S.Edquila@smit.com	CAD-Drawg not to be changed manually
		Orig. Size

All information and data on this drawing are property of SMIT Singapore Pte. Ltd.
 No part from that may be disclosed, copied, duplicated or in any other way made use of
 without written consent or used other than on terms agreed in writing.

Scale	Drawing No.	Sheet
NTS	JN 5560-D-012	3 of 4

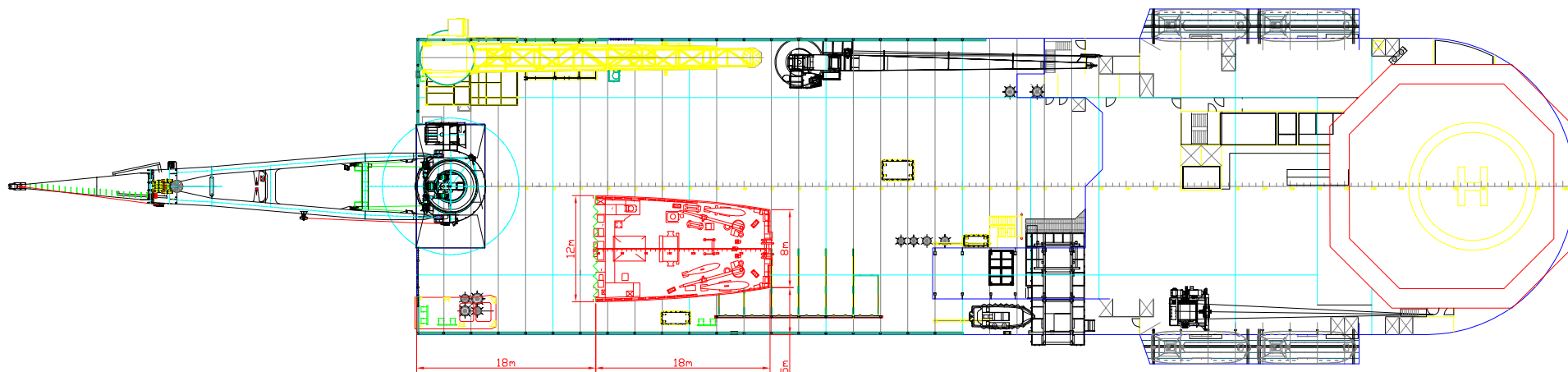

Stern Section Dimension

Jascon 25 Particulars

Lenght	18meters	Lenght Over All	118.8 meters
Breadth	12 meters	Breadth Moulded	36.40 meters
Height	9 meters	Depth	8.40 meters

Note:
 *All dimension are in meters unless otherwise specified
 *For illustration purposes only
 *Dunnage will be put in place on deck of Jascon before landing

00	14-03-13	Seal	Preliminary	Wytse		-----	
Rev	Date	Drawn	Description	Chkd	P.Appr	E.Appr	Client
Subject Landing on Jascon 25 (Stern Section)							
Project Salvage of "Uss Guardian"							
Client							
	SMIT SALVAGE 23 Gul Road Singapore E-mail: S.Edquila@smit.com						CAD-Drwg not to be changed manually
							Orig. Size
<small>All information and data on this drawing are property of SMIT Singapore Pte. Ltd. No part from that may be disclosed, copied, duplicated or in any other way made use of without written consent or used other than on terms agreed in writing.</small>							
Scale	Drawing No.		Sheet				
NTS	JN 5560-D-012		4 of4				

6.6 CALCULATIONS STERN SECTION

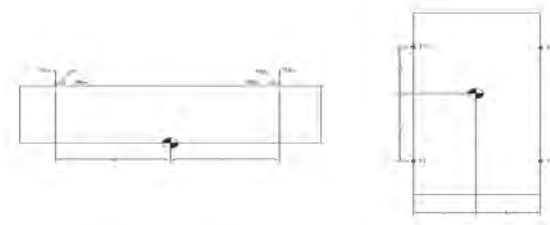

Module Weight	211	t	a	6000	mm	
Contingency Factor	1.05		b	6000	mm	
Gross Weight	221.55		c	5000	mm	
DAF	1.2		d	5500	mm	
Lift Weight	265.86		SKL	1.25	mm	Tilt Factor 1.1

	Plane	Angle	Sine
T1 Rigging Weight	T1 Plane	71	0.945519
T2 Rigging Weight	T2 Plane	71	0.945519
T3 Rigging Weight	T3 Plane	71	0.945519
T4 Rigging Weight	T4 Plane	71	0.945519
Total Rigging Weight			
Total Rigging Weight with DAF			

Hook Load	271.14	Crane Capacity	800	OK
-----------	--------	----------------	-----	----

Taking Moment @ C.G

Resolved Vertical Sling Tension

	Horizontal Plane	T1	T2	T3	T4
Rby (T1 + T2)	139.26				
Ray (T3 + T4)	126.6	69.63	69.63	63.3	63.3

Vertical Sling Tension = Resolved Vertical Sling Tension x SKL

	Horizontal Plane	T1	T2	T3	T4
Rby (T1 + T2)	174.075				
Ray (T3 + T4)	158.25	87.0375	87.0375	79.125	79.125

Resolved Sling Tension = Vertical Sling Tension / Sling Angle

Horizontal Plane	T1	T2	T3	T4
	92.05266	92.05266	83.68424	83.68424

Sling Force = (Vertical Sling Tension + Rigging Weight) / Sling Angle

Horizontal Plane	T1	T2	T3	T4
	93.44872	93.44872	85.0803	85.0803

Max: Sling Force Considering Tilt Factor

Horizontal Plane	T1	T2	T3	T4
	102.7936	102.7936	93.58833	93.58833

2 part sling factor 0.55

Max: Sling Force Considering 2 part sling factor

Horizontal Plane	T1	T2	T3	T4
	56.53648	56.53648	51.47358	51.47358

Double Sling

Min required MBL = Sling Load x 2.25 / Min (Termination Effcy., Bending Effcy.)

Factor of Safety = Sling MBL x Min (Termination Effcy., Bending Effcy.) / Sling Load

Bending Factor (According to Noble Denton Guidelines)

1 - 0.5 / sqrt (pin dia / rope dia)

Pin dia / Rope dia	1	1.5	2	3	4	5
Bending Factor	0.5	0.59	0.65	0.71	0.75	0.78

Lift Point	Sling dia. mm	*Pin dia. mm	Pin / Rope dia.	Bending Factor	Termination Efficiency	Governing Factor
T1	71	80	1.13	0.53	0.75	0.53
T2	71	80	1.13	0.53	0.75	0.53
T3	71	80	1.13	0.53	0.75	0.53
T4	71	80	1.13	0.53	0.75	0.53

Shackle 125T (Wide Body Shackle)

Lift Point	Sling Load	Sling Diameter (mm)	Min: Factor (Term, Bend)	Min Reqd MBL (m.t)	Used MBL (m.t)	FOS	Comments
T1	56.53648	71	0.53	360.00	360.00	3.37	ok
T2	56.53648	71	0.53	360.00	360.00	3.37	ok
T3	51.47358	71	0.53	360.00	360.00	3.70	ok
T4	51.47358	71	0.53	360.00	360.00	3.70	ok

Project Number: 5560
Project Name: "USS Guardian"
Document Name: Lifting plan hull sections 1 to 4
Version: 2



SMIT SINGAPORE PTE LTD

SMIT Singapore Pte Ltd
23 Gul Road
Singapore 629356

PHONE: +65 666 84 222
FAX: +65 666 84 333
E-MAIL: SALVAGE.SIN@SMIT.COM
URL: WWW.SMIT.COM

This page intentionally left blank.