

McCray Lumber Millwork



**Serving the
Professional Builder
for Over 65 Years**

www.mccraylumber.com

NEED LUMBER? WE'VE GOT IT!

McCray Lumber has been serving you and the building community for over sixty-five years. The goal for our future is a high standard of excellence and the ever present desire to improve our products and overall offering!

Our Lumber operations with our tremendous amount of lumber inventory are represented with 90 acres of open yard, over a half a million sq. ft. of covered storage, 100 trucks and over 200 dedicated employees to get what you want when you want.

McCray Lumber also has a sales staff that is your resource for building science needs, technical information, Blueprint take-offs and regular site visits to help manage your jobs and help contribute to your success!

With five metro location, as well as Lawrence and Topeka, we can ensure timely deliveries and pickups to and from your job site.

Value-Added Services

- Timely Pickups
- Emergency Shipping Response
- Centralized Deliveries
- GPS-Equipped Trucks
- Engineered Lumber Design Services



Studs

2x4 KD Doug Fir	92-5/8", 104-5/8", 116-5/8"
2x6 KD Doug Fir	92-5/8", 104-5/8", 116-5/8"

Plate

2x4 #3 SPF	8'-20'
2x4 #2 SPF	8'-20'
2x4x14' Borate Treated Sill Plate	
2x6x14' Borate Treated Sill Plate	

Framing Lumber

2x4 #2 Doug Fir	8'-20'
2x6 #2 Doug Fir	8'-32'
2x8 #2 Doug Fir	8'-32'
2x10 #2 Doug Fir	8'-32'
2x12 #2 Doug Fir	8'-24'
2x8 #2 KD Fir	8'-20'
2x10 #2 KD Fir	8'-20'
2x12 #2 KD Fir	8'-20'

4x8 Sheathing Panels

7/16" OSB (Also 4x9, 4x10)
19/32" OSB
15/32" Plywood
19/32" Plywood
23/32" Plywood
7/16" Zip Wall (Also 4x9, 4x10)
1/2" Zip Panel
5/8" Zip Panel

4x8 Subfloor

23/32" T&G Plywood
23/32" T&G OSB
23/32" T&G Edge Gold OSB
23/32" T&G Advantech OSB

4x8 Specialty Panels

23/32" Concrete Form Plywood
15/32" Treated Plywood
23/32" Treated Plywood
Fire Treated Plywood

LP Smart Siding and Trim

4x8, 4x9, 4x10, 8" OC Panels
6", 8" Lap Siding 7/16"
4x8 and 12" Soffit
4/4 Trim in 2", 3", 4", 6", 8", 10", 12" Width
5/4 Trim in 4", 6", 8", 10", 12" Width

Materials listed on this page are only available at our lumber yard locations. See page 1 for all locations.

Your Total Source for Framing

Boise Engineered Wood Products

9-1/2"	I-Joists
11-7/8"	I-Joists
3-1/2"x9-1/2"	LVL Beams
3-1/2"x11-7/8"	LVL Beams
3-1/2"x14"	LVL Beams
5-1/4"x9-1/2"	LVL Beams
5-1/4"x11-7/8"	LVL Beams
5-1/4"x14"	LVL Beams
5-1/4"x16"	LVL Beams
5-1/4"x18"	LVL Beams

Treated Lumber 8'-20'

2x4	#2 Prime
2x6	#1 Prime
2x8	#2 Pine
2x10	#2 Pine
2x12	#1 Pine
4x4	#1 Pine
6x6	#1 Pine

Cedar Lumber

Smooth or Rough

2x4	1x2
2x6	1x3
2x8	1x4
2x10	1x6
2x12	1x8
4x4	1x12
6x6	Timbers
1x6	Lap
1x8	Lap

Composite Decking & Accessories

Deckorators, TREX, Evergrain, OZCO, Fortress, Cable Rail, Westbury

Framing Hardware

Pneumatic Nails and Staples
Simpson Strongtie Lumber Connectors
Sub-Floor Adhesive
Hand Drive Nails
DAP Smart Bond Adhesive

Other Siding and Accessories

James Hardie Fiber Cement
ABTCO Hardboard Siding
Tyvek Housewrap and Flashing
Dow Foam Sheathing
Aluminum Drip Cap and Z-Bar
Soffit Vents and Rolled Flashing
Sill Sealer

DuPont™ Weatherization Systems

How are you protecting your buildings and your reputation?

Consider the advantages of DuPont™ Tyvek® Weatherization Systems products - a relatively simple solution to a potentially serious problem. If you're not currently using a water resistive barrier - if you're not flashing window and door openings - take a minute to see what a difference DuPont™ Tyvek® makes for building in quality protection that's proven itself on millions of structures.

DuPont™
Tyvek®
HomeWrap™

Weather resistive barrier designed for new construction and re-siding with traditional materials
9' x 100' • 9' x 150' • 10' x 100' • 10' x 150' • 5' x 200'



DuPont™
Flashing Tape

Butyl - based adhesive flashing tape designed for window heads and jambs
4" x 100' • 6" x 100' • 9" x 100'



DuPont™
Tyvek®
DrainWrap™

The unique properties of Tyvek® DrainWrap™ combined with an additional drainage system
9' x 125' • 10' x 125'



DuPont™
StraightFlash™

Premium butyl flashing, with greater durability, designed for straight window heads and jambs
4" x 150' • 9" x 125'



DuPont™
Tyvek®
StuccoWrap™

Designed expressly for construction with stucco and synthetic stucco facades
5' x 200'



DuPont™
StraightFlash™ VF

Dual sided flashing that integrates non-flanged windows, brick mold & exterior doors with the building envelope
6" x 125'



DuPont™
Tyvek®
COMMERCIALWRAP™

A thicker, stronger, higher performance wrap, designed specifically for commercial construction
10' x 125' • 5' x 200'



DuPont™
FlexWrap™ NF

Flexible flashing tape for superior protection of window sills and sealing of curved windows and wall penetrations
6" x 75' • 9" x 75'



DuPont™
Tyvek®
ThermaWrap™

Low-e-wrap increases the R-value of a wall system by reducing radiant heat flow, minimizing summer heat gain and winter heat loss
5' x 150' • 9' x 100'



DuPont™
Tyvek®
Tape

The final step for maximum reduction of air infiltration through the wall system
2" x 55 yd • 3" x 55 yd



DuPont™
Tyvek®



The miracles of science™

SINGLE-HUNG WINDOW

The popular Silver Line[®] 2900 Series single-hung window pairs an elegant exterior appearance with sturdy construction. It combines the classic look of colonial molding with energy efficient construction to keep out the elements.

Features & Benefits

- Colonial brickmold design adds a touch of classic style to your home
- Tilt-in bottom sash for easier cleaning
- Specially designed balance system makes this window effortless to open
- Fusion-welded, heavy duty vinyl for low-maintenance convenience
- Integral "J" channel allows for neat, easy trimming of exterior siding to the window
- Interlocking sash offer an effective seal against drafts
- Integral lift rail makes lifting the sash simple
- ENERGY STAR[®] qualified with the appropriate energy efficient options^{††}



†† Visit www.silverlinewindows.com for performance information.

STANDARD

SINGLE-HUNG WINDOW

If a quality window at an affordable price is what you're looking for, then the Silver Line® 2200 Series single-hung window is the answer. This simple, no-nonsense window is easy to install and is virtually maintenance-free.

Features & Benefits

- Simple, flat design blends with any décor
- Tilt-in bottom sash for easier cleaning
- Fusion-welded vinyl offers low-maintenance convenience
- Interlocking sash help create a weathertight seal
- ENERGY STAR® qualified with the appropriate energy efficient options††



18 †† Visit www.silverlinewindows.com for performance information.

CHOOSE THE FEATURES & OPTIONS THAT ARE RIGHT FOR YOU.

COLOR

These Silver Line® windows and doors are available in white and beige. The color is consistent throughout the frame and sash, making scratches virtually invisible.

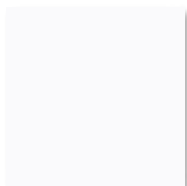

White



Beige

HARDWARE

All of our durable hardware is designed to attractively coordinate with the window or door and to provide smooth, easy operation. We offer low profile locks and handles to secure our windows and doors so you can feel safe while enjoying a clear view of the outdoors.

CAM LOCK

Our color coordinated cam lock is designed to bring the window sash closer together for a snug and secure hold.



White | Beige

PATIO DOOR HANDLE

The Silver Line 5500 Series Standard patio door comes with color coordinated lever locking handles.



White | Beige

GLASS OPTIONS

These Silver Line® windows and doors are available with energy efficient, dual-pane glass options to achieve the level of comfort and energy savings you are looking for.

LOE2 GLASS

Designed to efficiently and transparently reflect heat, this glass helps keep your home warmer in the winter and cooler in the summer. This can help reduce your energy bills while still ensuring exceptional clarity.

LOE3 GLASS

This highly efficient glass helps reflect even more heat, resulting in increased comfort and energy savings year-round.

ARGON GAS FILL

An odorless, non-toxic gas that helps reduce heat loss, helping to save on heating costs.

TEMPERED GLASS

Heat treated glass that shatters into pebble-sized pieces instead of larger shards to reduce the risk of injury.



Tempered Glass

OBSCURE GLASS

Textured glass that provides a translucent effect for added privacy.

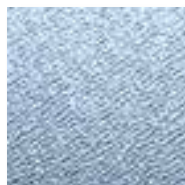

Obscure Glass

GRILLES

Grilles are available in several different types and patterns that can add style to any home.

GRILLES-BETWEEN-THE-GLASS

Our grilles-between-the-glass options are specially designed to enhance your home's décor and make cleaning your windows and doors a breeze.

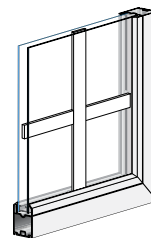

Flat

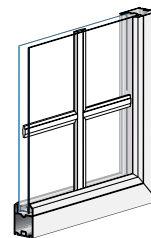

Contour

GRILLE PATTERNS

Our windows and doors are available with a wide variety of grille patterns. Choose from standard patterns such as Colonial, Prairie or Diamond as well as a number of specialty patterns.

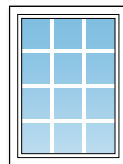

Colonial

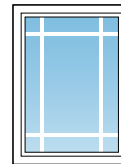

Prairie

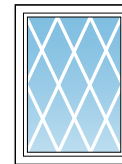

Diamond

FEATURES

TILT-IN SASH

Tilt-in sash offer easy cleaning from inside your home. Simply slide the tilt latch open and tilt the sash in to easily clean the outside of your window sash. Once you're finished cleaning, just tilt the sash back into place.



Printing limitations prevent exact color duplication. See your Silver Line dealer for actual color samples. Silver Line reserves the right to change product designs, specifications, details and pricing at any time without prior notification. Silver Line does not warrant that inert gas infills (such as Argon gas), sealed in the insulated glass unit at the point of manufacture, will not dissipate over time. Not all options are available on all products and in all areas.

Dark Bronze Color Offering

Available for select Silver Line[®] windows



Add a splash of color to your home with the dark bronze exterior color option on select Silver Line[®] windows. This unique solution offers an attractive and durable color choice from the name you know and trust.

This innovative color option covers the exterior of the window with a durable, fade-resistant[†] coating of a deep, rich, dark bronze tone. Industry-leading technology is used to prevent peeling, fading, cracking and blistering.[†]

The factory painted surface is cured to a hard finish that offers resistance to scrapes, scratches and scuffs. The cutting edge polyurethane coating technology used will help keep your windows the same attractive color year after year.[†]

THIS ATTRACTIVE FINISH OFFERS:

- All-season durability
- Complete, opaque coverage
- Resistance to scrapes and scuffs
- Withstands heat and cold
- Easy to clean convenience
- Market-leading performance
- Limited warranty on exterior color finish[†]

COLORS

This color combination includes a solid white vinyl sash and frame with a painted dark bronze exterior.[†]

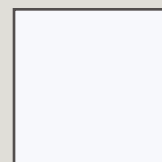

White
Interior

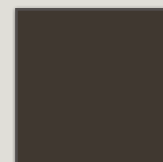

Dark Bronze
Exterior

Printing limitations prevent exact color duplication. See your Silver Line representative for actual color samples.

Not all options are available on all products and in all areas. See your dealer for availability.
[†] Painted exteriors have a 10 year warranty. Please see the Limited Lifetime Warranty for details.

CHOOSE THE FEATURES & OPTIONS THAT ARE RIGHT FOR YOU.

COLOR

Most Silver Line® windows and doors are available in white and beige while select products are available in sandtone. The color is consistent throughout the frame and sash, making scratches virtually invisible.



GLASS OPTIONS

These Silver Line® windows and doors are available with energy efficient, dual-pane glass options to achieve the level of comfort and energy savings you are looking for.

LOE2 GLASS

Designed to efficiently and transparently reflect heat, this glass helps keep your home warmer in the winter and cooler in the summer. This can help reduce your energy bills while still ensuring exceptional clarity.

LOE3 GLASS

This highly efficient glass helps reflect even more heat, resulting in increased comfort and energy savings year-round.

ARGON GAS FILL

An odorless, non-toxic gas that helps reduce heat loss, helping to save on heating costs.

TEMPERED GLASS

Heat treated glass that shatters into pebble-sized pieces instead of larger shards to reduce the risk of injury.

OBSCURE GLASS

Textured glass that provides a translucent effect for added privacy.

GRILLE OPTIONS

Grilles are available in several different types and patterns that can add style to any home.

GRILLES-BETWEEN-THE-GLASS

Our grilles-between-the-glass options are specially designed to enhance your home's décor and make cleaning your windows and doors a breeze.

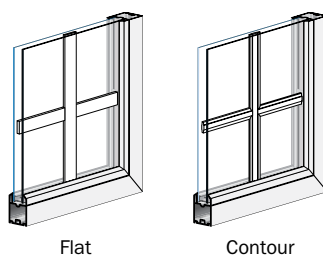

GRILLES OUTSIDE THE GLASS

Many Preferred windows and doors offer Simulated Divided Lites (SDL) with grilles attached to the outside of the glass to give the traditional look of individual panes of glass. We also offer a Check Rail on Preferred casement windows with horizontal grilles attached to the outside of the glass to give the look of either a hung window or a mullied window with a transom.

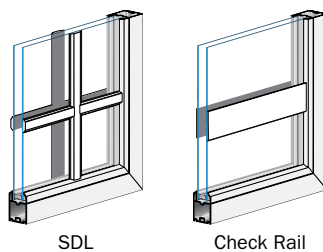

GRILLE PATTERNS

Our windows and doors are available with a variety of grille patterns. Choose from patterns such as:

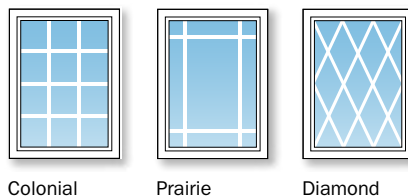

HARDWARE

All of our durable hardware is designed to attractively coordinate with the window and to provide smooth, easy operation. We offer low profile locks and handles to secure our windows so you can feel safe while enjoying a clear view of the outdoors.

CAM LOCK

Our color coordinated cam lock is offered on these Preferred double-hung, single-hung and sliding windows. It is designed to bring the window sash closer together for a snug and secure hold.



FOLDING HANDLE AND LOCK

These Silver Line® casement and awning windows come standard with a color coordinated folding handle that eliminates interference with shades and blinds. The coordinating, slim profile lock offers easy and secure operation.



*Not available on all products or in all areas.

Printing limitations prevent exact color duplication. See your Silver Line dealer for actual color samples. Silver Line reserves the right to change product designs, specifications, details and pricing at any time without prior notification. Silver Line does not warrant that inert gas infills (such as Argon gas), sealed in the insulated glass unit at the point of manufacture, will not dissipate over time. For additional features and options, visit www.silverlinewindows.com. Not all options are available on all products and in all areas.

PREFERRED

SLIDING PATIO DOOR

The popular Silver Line® 5800 Series sliding patio door offers a sturdy, elegant and energy efficient design. Built to provide smooth, reliable performance this durable door is an ideal choice for your home.



Features & Benefits

- A thicker, wider profile creates a traditional appearance
- Designed with durable, self-leveling rollers to make opening this door smooth and effortless
- Fusion-welded, heavy duty vinyl frame and panels make a sturdy and durable door
- Interlocking panels help provide an effective seal against drafts
- Tempered glass helps reduce the risk of injury
- Steel reinforced panels offer added strength
- A multi-point lock operates from a single lever for easy and secure locking
- Optional PG rating upgrade is available on many sizes for additional strength and durability
- Fully assembled for fast and easy installation
- Industry-leading limited lifetime warranty†
- ENERGY STAR® qualified with the appropriate energy efficient options††

PATIO DOOR HANDLES

This door offers color coordinated, key-lock handles as well as a stylish satin nickel option.



White | Beige | Sandtone | Satin Nickel



ENHANCE YOUR VIEW

Create an eye-catching view to the outdoors by adding coordinating side lites or transoms to your door. Side lites placed near or next to your door widen your view while transoms stacked on top of the door draw your eyes up and out to virtually expand the height of your room. We offer the sizes and options you need to create a welcoming space in your home.

† See the limited lifetime warranty for details.
†† Visit www.silverlinewindows.com for performance information.

CHOOSE THE FEATURES & OPTIONS THAT ARE RIGHT FOR YOU.

COLOR

Most Silver Line® windows and doors are available in white and beige while select products are available in sandtone. The color is consistent throughout the frame and sash, making scratches virtually invisible.



White

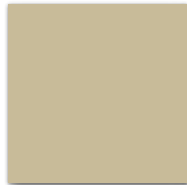

Beige

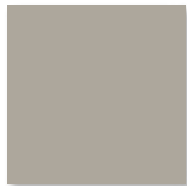

Sandtone*

FEATURES

TILT-IN SASH

Tilt-in sash offer easy cleaning from inside your home. Simply slide the tilt latch open and tilt the sash in to easily clean the outside of your window sash. Once you're finished cleaning, just tilt the sash back into place.



HARDWARE

All of our durable hardware is designed to attractively coordinate with the window or door and to provide smooth, easy operation. We offer low profile locks and handles to secure our windows and doors so you can feel safe while enjoying a clear view of the outdoors.

CAM LOCK

Our color coordinated cam lock is offered on these double-hung, single-hung and sliding windows. It is designed to bring the window sash closer together for a snug and secure hold.



White | Beige | Sandtone

FOLDING HANDLE AND LOCK

Silver Line® casement and awning windows come standard with a color coordinated folding handle that eliminates interference with shades and blinds. The coordinating, slim profile lock offers easy and secure operation.



White | Beige

White | Beige

PREFERRED PATIO DOOR HANDLE

The Silver Line 5800 Series Preferred patio door offers color coordinated, key-lock handles as well as a stylish satin nickel option.



White | Beige | Sandtone | Satin Nickel

STANDARD PATIO DOOR HANDLE

The Silver Line 5500 Series Standard patio door comes with color coordinated lever locking handles.



White | Beige

* Not available in all areas.

Not all options are available on all products and in all areas. Printing limitations prevent exact color duplication. See your Silver Line dealer for actual color samples.

PREFERRED

CASEMENT WINDOW

The Silver Line® 70 Series casement window offers a balance of style and convenience in an energy efficient window. With many configurations to choose from, this casement window offers design flexibility to complement virtually any style home.

Features & Benefits

- Optional colonial brickmold design adds a touch of classic style to your home
- Opens effortlessly for effective ventilation
- Multi-point locking system operates from a single, low profile lever for easy use and added safety
- Folding operator handle eliminates interference with shades and blinds
- Fusion-welded, heavy duty vinyl for low-maintenance convenience
- Dual weatherstripping virtually eliminates drafts for a more comfortable, energy efficient home
- Optional integral “J” channel allows for neat, easy trimming of exterior siding to the window
- ENERGY STAR® qualified with the appropriate energy efficient options††



†† Visit www.silverlinewindows.com for performance information.

Choose Your Silver Line® Window In 5 Easy Steps

1 Choose your project type.

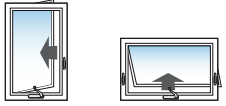

REPLACE	REMODEL & BUILD	
 <p>Replacement Frame</p>	 <p>Nailing Fin with "J" Channel</p>	 <p>Nailing Fin Only</p>
<p><i>Easily replace old, drafty window sash without disturbing the existing frame.</i></p>	<p><i>Offers easy weathertight installation for new homes and additions with the "J" channel for exterior siding.</i></p>	<p><i>Offers easy weathertight installation for new homes and additions to fit with any exterior house finish.</i></p>

2 Choose your window style.



70 Series Casement or Awning
Sash opens out for easy ventilation

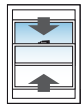
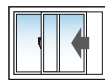

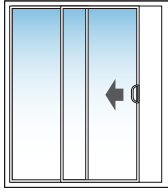
Looking for something else?
These coordinating products are also available:

 <p>Double-Hung</p>	 <p>Sliding</p>	 <p>Picture</p>	 <p>Shapes</p>	 <p>Patio Door</p>
--	--	--	---	---

3 Choose your color.

 White	 Beige	 Dark Bronze Exterior*
--	--	--

4 Choose your glass.

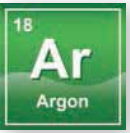
 <p>LoE 2</p> <p><i>Outstanding overall thermal performance for climates where both heating and cooling costs are a concern.</i></p>	 <p>LoE 3</p> <p><i>Excellent thermal performance in warmer climates transmits less heat from the sun to help lower cooling costs further.</i></p>	 <p>LoE LS</p> <p><i>Superior thermal performance in warm climates blocks additional heat from the sun and helps minimize glare.</i></p>	 <p>Ar Argon</p> <p><i>Offers additional insulation in colder climates to help lower heating bills more.</i></p>
--	---	--	--

Other glass options are also available. See your Silver Line dealer for details.

5 Personalize with optional grilles.

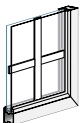
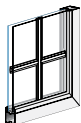
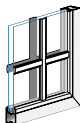
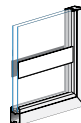
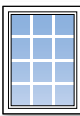
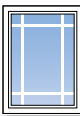
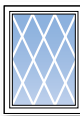
Types				Patterns		
 Flat	 Contour	 SDL	 Check Rail	 Colonial	 Prairie	 Diamond

Silver Line®
by Andersen 
WINDOWS • DOORS

silverlinewindows.com

*Dark bronze painted exterior with white vinyl interior is not available in all areas. See your dealer for availability. Drawings are provided for general reference only. Please refer to installation instructions and local building codes when installing windows and doors. Printing limitations prevent exact color duplication. See your Silver Line dealer for actual color samples. For additional features and options and for performance data, visit www.silverlinewindows.com. Not all options are available on all products and in all areas. All marks where denoted are trademarks of their respective owners. © 2014 Silver Line Building Products LLC. All rights reserved.



Whatever you can dream, Andersen can help you build.

The possibilities for building and remodeling are virtually endless, and so are your choices with Andersen® windows and patio doors. From simple, economical double-hung windows to dramatic custom combinations, Andersen is sure to have the perfect solution for your home.

Why Choose Andersen Products?

Reputation The Andersen brand is the most recognized and most used brand in the window and patio door industry. Reliability and craftsmanship have set Andersen products apart for more than 100 years, so you can trust them to give you lasting value.

Warranty Most other window and patio door warranties end when a home is sold. Andersen coverage* — twenty years on glass and ten on non-glass parts — is completely transferable from each owner to the next. And, because it is not prorated, the coverage offers full benefits year after year, so it may add real resale value.



Performance Andersen has always been known for energy-efficient products. Units are tested rigorously, including exposure to temperature extremes from -20°F to 180°F and wind speeds up to 155 miles per hour. Plus, revolutionary High-Performance™ Low-E4® and High-Performance Low-E4 Sun glass is 35% more energy efficient than ordinary dual-pane glass in the winter and 41% more energy efficient in the summer.



Products with the ENERGY STAR® label are designed to use less energy, help save money on utility bills and help protect the environment.

Service A warranty is only as valuable as the service behind it. With Andersen, that service is just a phone call away. Call the Andersen service center at 1-888-888-7020.

* Visit andersenwindows.com or contact your builder to obtain a copy of the complete Andersen Owner-2-Owner® limited warranty.

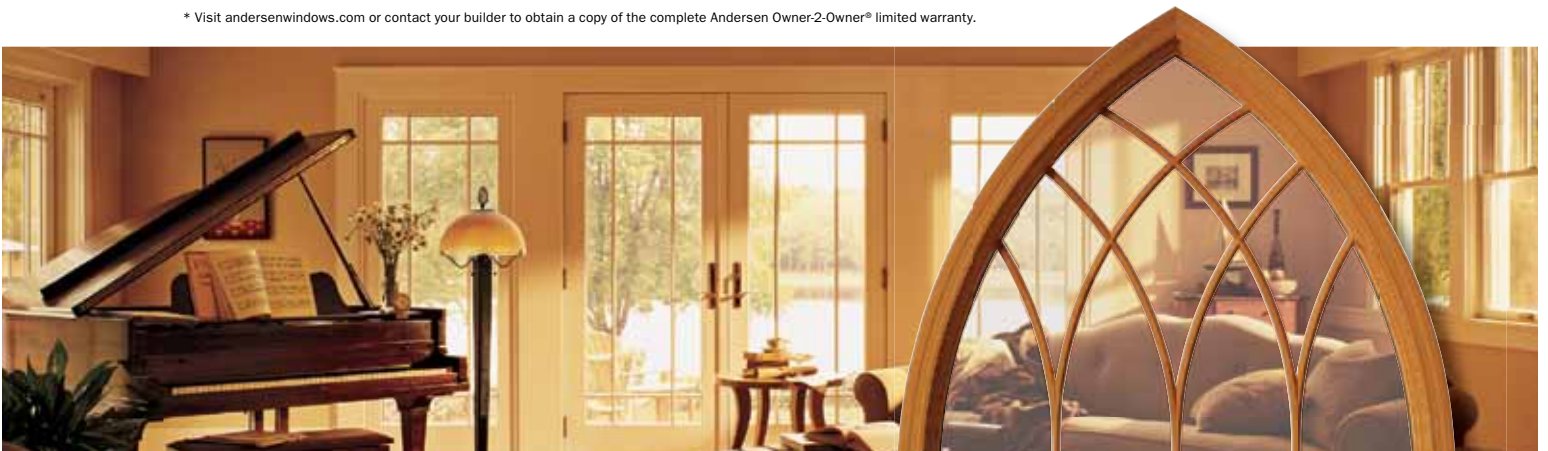

**CONSIDERING VINYL WINDOWS?
 CONSIDER 100 SERIES
 WINDOWS
 MADE WITH FIBREX® MATERIAL.**

Andersen® 100 Series windows and patio doors are made of our patented, revolutionary Fibrex® composite material that is stronger, more beautiful and environmentally responsible – **all at a very likeable price.**

STRONGER THAN VINYL

- Made with our Fibrex® material, an engineered composite material that is 2x stronger than vinyl.
- Won't bend, rust, pit or corrode*. Even in extreme cold or heat.

MORE BEAUTIFUL THAN VINYL

- More exterior colors, including dark tones that won't fade, flake, blister or peel*.



Dark Bronze Cocoa Bean Terratone® Sandtone White

- A low-maintenance premium matte finish that isn't shiny like vinyl.
- Clean, attractive corner seams.

Our 100 Series corner seam



Their Vinyl corner seam



ENVIRONMENTALLY RESPONSIBLE

- Designed for energy efficiency.
- Made with 40% reclaimed wood fiber by weight.

*See the limited warranty for details



"ENERGY STAR" is a registered trademark of the U.S. Environmental Protection Agency. "Andersen" and all other marks where denoted are trademarks of Andersen Corporation. ©2011 Andersen Corporation. All rights reserved. 03/11

To learn more about our full line of products for your replacement, remodeling & new construction projects go to andersenwindows.com/100series

200 SERIES



Tilt-Wash Double-Hung Windows

Beauty

Natural wood complements your home's interior with solid craftsmanship.

Weathertight Performance

Durable weatherstripping helps create a tight seal against air and water, and Low-E insulating glass helps lower heating and cooling costs.

Durability

Andersen® windows combine the strength and insulation of natural wood on the inside with seamless, low-maintenance cladding on the outside.

Smooth Operation

Open and close the sash with ease, thanks to patented weatherstripping that reduces friction and a specially engineered counter-balance system.

Owner-2-Owner® Limited Warranty

Glass is covered for 20 years and non-glass parts are covered for 10. Coverage is not pro-rated and can add real value when the home is sold.

features & options



With Low-E glass, these products are designed to use less energy, help you save money on utility bills and help protect the environment.



The tilt-wash design makes it easy to clean the exterior glass from inside your home.



Optional Andersen® Finelight™ grilles are factory-installed between the panes of glass, out of the way for easy cleaning.



Optional TruScene® insect screens feature micro-fine mesh that lets more light and fresh air into your home, yet keeps even the smallest insects out.

400 SERIES



Casement & Awning Windows

Beauty

The rich wood interior adds beauty and charm to any home.

Weathertight Performance

High-Performance™ Low-E4® glass helps insulate against heat and cold, which can help cut energy bills. It also filters UV rays that can fade fabric and damage furniture. In addition, durable weatherstripping helps create a tight seal against air and water.

Durability

Andersen® windows combine the strength and insulation of natural wood on the inside with seamless, low-maintenance cladding on the outside. The vinyl-encased sash prevents warping, too.

Smooth Operation

Smooth Control™ hardware features stainless steel hinges and nylon glides that make opening and closing the window extra smooth.

Easy Cleaning

High-Performance Low-E4 glass has an exterior coating that stays cleaner, dries faster for easy cleaning and has up to 99% less water spots (exterior pane only when activated by sunlight). And the split-arm operator moves the sash away from the frame for easier cleaning.

Owner-2-Owner® Limited Warranty

Glass is covered for 20 years and non-glass parts are covered for 10. Coverage is not pro-rated and can add real value when the home is sold.

features & options



With High-Performance™ Low-E4® glass, these products are designed to use less energy, help you save money on utility bills and help protect the environment.



Choose from a variety of grille options: standard, specified equal light and custom patterns are available.



Optional TruScene® insect screens feature micro-fine mesh that lets more light and fresh air into your home, yet keeps even the smallest insects out.



Classic Series™ hardware available in white or stone finish. *Optional folding hardware also available.*



“Andersen,” the AW logo and all other marks where denoted are trademarks of Andersen Corporation. © 2009 Andersen Corporation. All rights reserved.

400 SERIES WINDOWS

WINDOW TYPES

- Double-hung windows
- Casement windows
- Awning windows
- Picture windows
- Specialty windows
- Bay and bow windows



Most 400 Series windows are available with Stormwatch® protection for coastal areas.

GLASS OPTIONS

LOW-E4® GLASS

- Three Low-E glass options help control heating and cooling costs in any climate

PATTERNED GLASS

- Four patterns ideal for letting light into the home while obscuring vision
- Can be ordered as Low-E or SmartSun™ Low-E glass

GRILLES

Choose from popular grille designs or work with Andersen to create custom patterns.

INTERIOR OPTIONS

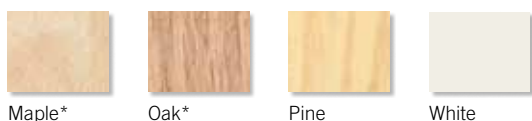

Printing limitations prevent exact color and finish duplication. See your Andersen dealer for actual finish samples.

*Maple and oak wood species are available on 400 Series Woodwright® double-hung windows only.

"ENERGY STAR" is a registered trademark of the U.S. Environmental Protection Agency. "Andersen" and all other marks where denoted are trademarks of Andersen Corporation. ©2013 Andersen Corporation. All rights reserved. 11/13

EXTERIOR TRIM STYLES & COLORS



2" Brick Mould with sill nose
Dove Gray trim with Terratone® window



4 ½" Flat with sill nose
Canvas trim with Forest Green window



3 ½" Flat with sill nose
Dark Bronze trim with White window

AVAILABLE EXTERIOR TRIM COLORS



HARDWARE FINISHES

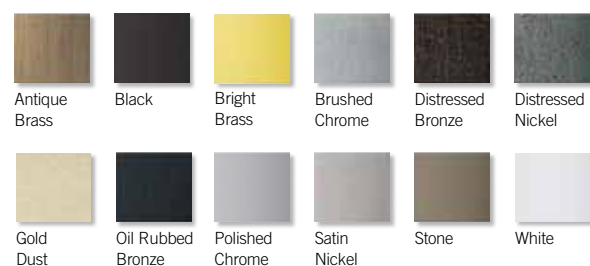

For more information visit andersenwindows.com/400series

400 SERIES



Woodwright® Insert Windows

Simple Replacement

Woodwright® insert windows are made to fit the existing window opening for fast installation with minimal disruption. You keep the existing frame and trim.

Beauty

The all-wood interior is precisely crafted with classic details to seamlessly blend with traditional homes.

Weathertight Performance

High-Performance™ Low-E4® glass helps insulate against heat and cold, which can help cut energy bills. It also filters UV rays that can fade fabric and damage furniture. In addition, durable weatherstripping helps create a tight seal against air and water.

Durability

Perma-Shield® exterior cladding and Fibrex® sash exteriors offer low maintenance and long-lasting performance.*

Easy Cleaning



High-Performance Low-E4 glass has an exterior coating that stays cleaner, dries faster for easy cleaning and has up to 99% less water spots (exterior pane only when activated by sunlight). And the tilt-wash design makes it easy to clean the exterior glass from inside your home.

Owner-2-Owner® Limited Warranty

Glass is covered for 20 years and non-glass parts are covered for 10. Coverage is not pro-rated and can add real value when the home is sold.

*For complete information on our limited warranties, visit andersenwindows.com or contact your Andersen supplier.

features & options



With High-Performance™ Low-E4® glass, these products are designed to use less energy, help you save money on utility bills and help protect the environment.



Three sill angles are available to closely match existing sill in window replacement applications.



Optional TruScene® insect screens feature micro-fine mesh that lets more light and fresh air into your home, yet keeps even the smallest insects out.



Optional Estate™ hardware lets you match your décor.



"Andersen," the AW logo and all other marks where denoted are trademarks of Andersen Corporation. © 2009 Andersen Corporation. All rights reserved.

WHEN STYLE AND
PERFORMANCE
MATTER.

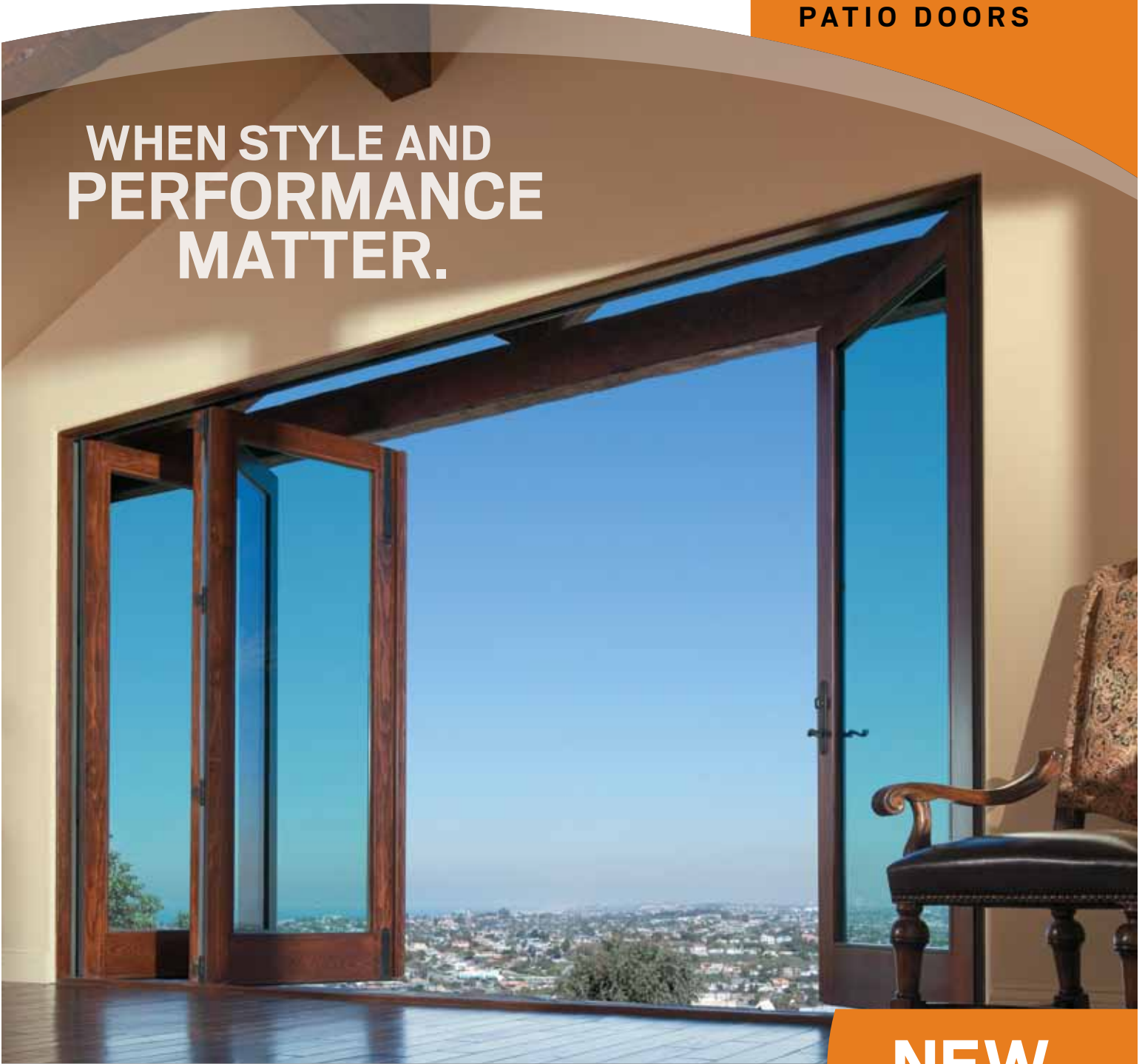

NEW

THE ONLY THING THAT SHOULD BE
BETWEEN YOU AND THE OUTDOORS
IS AN ANDERSEN[®] PATIO DOOR,
WHEN YOU WANT IT TO BE.

Andersen® outswing folding patio doors bring the outdoors in.

Construction

The standard construction of the outswing folding patio door is an aluminum clad exterior with a rich wood interior. The aluminum cladding comes in 21 color options and has an AAMA 2605 finish on the panel and frame. There are 7 standard wood species to choose from. A wood exterior panel and frame construction is also available as a special request product.

Design Criteria

To allow for proper performance and operation, verify the structural integrity of the header such that the maximum deflection with live and dead loads is limited to the lesser of L/750 of the span and ¼". The maximum weight per panel with Low-E4®, SmartSun™ or Sun glass is 200 lbs. per panel. Weights using alternate glazings will need to be provided by Andersen.

Exterior Colors



Interior Options



Printing limitations prevent exact duplication of exterior colors and wood species, please see actual samples.

† Actual wood is Sapele, also known as African mahogany, a non endangered hardwood with color and characteristics similar to American mahoganies.

Features

- Built to fit openings up to 48 ft. wide by 10 ft. tall
- Top hung system allows for easy operation
- High-Performance™ Low-E4® glass means energy performance
- 21 Exterior aluminum clad colors* and 7 wood species
- Multi-Point Locking
- Traditional or contemporary panel styles
- Optional retractable insect screen**
- Choice of many hardware styles and finishes

Three sill options available



Standard
(PG30*** rated)

Low Profile

Flush Track

Panel and Size Ranges

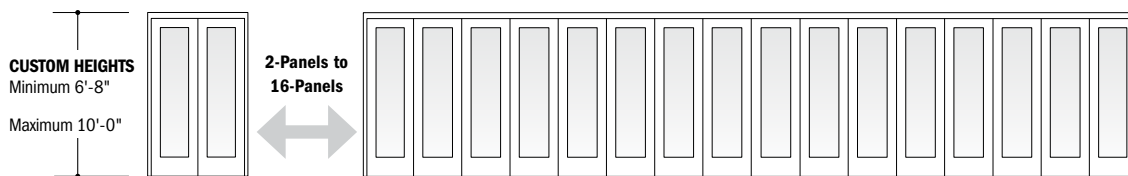

CUSTOM WIDTHS

Number of Panels	Minimum to Maximum	Number of Panels	Minimum to Maximum	Number of Panels	Minimum to Maximum
2-Panel	3'-2 1/4" to 6'-8 1/8"	7-Panel	10'-9 1/4" to 22'-11 1/8"	12-Panel	18'-5 1/8" to 39'-4 1/8"
3-Panel	4'-8 5/8" to 9'-11 1/4"	8-Panel	12'-4 1/2" to 26'-3 1/8"	13-Panel	19'-10 1/4" to 42'-7 1/8"
4-Panel	6'-3 1/8" to 13'-2 1/4"	9-Panel	13'-9 5/8" to 29'-6 1/2"	14-Panel	21'-5 3/8" to 45'-10 1/2"
5-Panel	7'-9" to 16'-5 3/8"	10-Panel	15'-4 3/4" to 32'-9 1/8"	15-Panel	22'-10 1/4" to 48'-0"
6-Panel	9'-9 1/8" to 19'-8 3/4"	11-Panel	16'-9 1/8" to 36'-0 3/4"	16-Panel	24'-4 1/8" to 48'-0"

* "Minimum to Maximum" door width dimensions refers to frame to frame dimension.



Custom sizes in 1/8" increments.

Doors open to the exterior.
Traditional panel shown.

Scale 1/8" = 1'-0" (1:96)

* AAMA 2605 finish standard on the frame and panel components.

** Architectural Folding Outswing patio door insect screens are available for purchase through an authorized Andersen dealer. These insect screens are supplied by Centor Architectural, an award winning manufacturer of folding patio door insect screen systems.

*** Performance Grade SP-PG30 4059 x 3035 (159 x 119) for door with standard sill; doors with other sill options not yet rated.

"Andersen" and all other marks where denoted are trademarks of Andersen Corporation. ©2011 Andersen Corporation. All rights reserved. 02/11

WINDOWS • DOORS
Andersen

Come home to Andersen.®



A-Series

WINDOWS AND PATIO DOORS

Authentic to Style. Authentic to You.

Your home's architectural style says a lot about you. Andersen® A-Series products allow it to speak with authenticity and clarity.

From French Eclectic to Modern to Spanish Colonial, you can create it with A-Series windows and patio doors. And you can do so knowing you're choosing the best-performing, most energy-efficient products Andersen has ever offered.



Interior finishes: A-Series windows and doors offer six different factory stains, two paint choices or a primed finish to complement any look.

Exterior colors: With 11 different colors, you can mix and match sash, frame and trim to achieve hundreds of combinations.



A-Series double-hung windows and Frenchwood® outswing patio doors. Prairie grilles.



Flat exterior trim with cornice head, color: Canvas

Frame exterior color: Sandtone

Sash exterior color: Cocoa Bean



Architectural Style Made Easy.





E-Series/Eagle® rectangular and trapezoidal picture windows and awning windows.

E-Series/Eagle®

WINDOWS AND DOORS

Windows to Your Imagination. Doors to Your World.

With E-Series/Eagle® windows and doors, the home you've always imagined can be more than a dream. More than a vision. It can be reality.

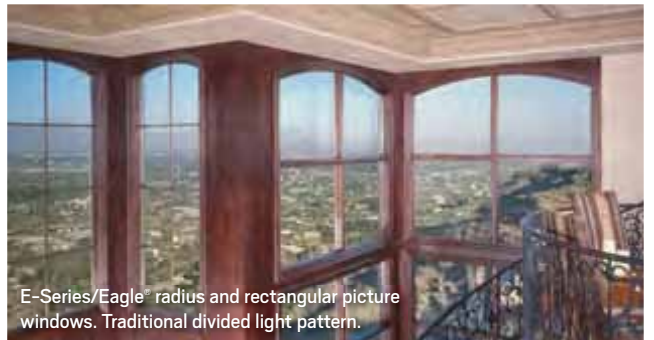

E-Series/Eagle® radius and rectangular picture windows. Traditional divided light pattern.

Custom colors. Unlimited design options. Dynamic sizes and shapes. Every E-Series/Eagle® window and door is made to your exact specifications, giving you unmatched freedom. You can even work directly with a window specialist to get the product you want with the performance you need.

The inspiration for your home can come from anywhere. The ability to fulfill it comes from E-Series/Eagle® windows and doors.



Unlimited Possibilities.



Southwest Collection

The Southwest Collection includes a selection of stainable woodgrain urethane millwork pieces inspired by the rustic landscape and regions of the west. With its realistic woodgrain textures, this collection provides a bold but naturalistic feel to any home.

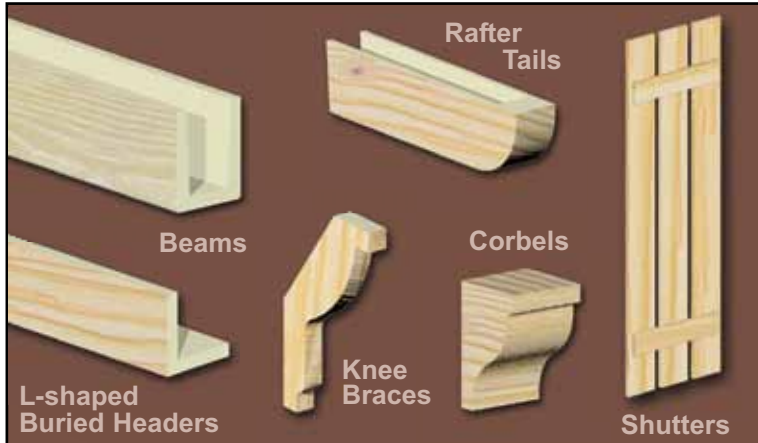

Products Shown: L-shaped Buried Headers



William E. Poole Cupolas

Fypon's Cupolas are the definition of hybrid, beautifully combining urethane and PVC into spectacular designs created by architect William E. Poole. Topped with a hand-crafted copper roof, Fypon's Cupolas provide a unique finishing touch to any home. A variety of copper weather vanes are also available to complement our cupola styles.



PVC Column Wraps

Fypon's PVC Column Wraps provide classic style with today's performance. The unique semi-assembled two piece design cuts installation time to 15 minutes and allow more flexibility.



Entrance Systems

Nothing can make a statement and enhance architectural style like Window & Door Trim from Fypon. From Pilasters to Pediments and Crossheads to Arches, the options are virtually endless.



Features & Benefits

Durable and Waterproof - High density urethane that won't absorb moisture, rot, warp or splinter.

Created from precision-crafted masters, reproducing exact duplicates with crisp detail.

Finished with a double coat of paintable UV resistant primer.

Covered by a Limited Lifetime Warranty.



Decorative Millwork

When you want to add the ultimate finishing touch, Decorative Millwork from Fypon is the perfect choice for either interior or exterior applications. Our architecturally accurate pieces provide a collection that will expand your design possibilities.

The Right Stuff.

The right stuff. It's everything we are. Everything we make. And how we go about making it. At Fypon, our goal is to have the right product for every possible application. From our lead times that set the industry standard to our dedicated service that allows us to respond to the ever-changing needs of our customers to our innovative new products, no matter what the project, you can trust Fypon to have the right stuff.

FYPON
The Right Stuff.™

www.fypon.com

Fypon™ is a registered trademark of Fypon, Ltd. Printed in the U.S.A.

ENTRY SYSTEMS

6'-8" DOOR HEIGHT

Sizes and Rough Openings

Description	Size	Actual Unit Size	Rough Opening
Single Door Unit	2'-6"	31-1/2" x 82"	32" x 82-1/2"
(Inswing)	2'-8"	33-1/2" x 82"	34" x 82-1/2"
	2'-10"	35-1/2" x 82"	36" x 82-1/2"
	3'-0"	37-1/2" x 82"	38" x 82-1/2"
	3'-6"	43-1/2" x 82"	44" x 82-1/2"
Double Door Unit	5'-0"	62" x 82"	62-1/2" x 82-1/2"
	5'-4"	66" x 82"	66-1/2" x 82-1/2"
	6'-0"	74" x 82"	74-1/2" x 82-1/2"

Note: Outswing Sill Height

Outswing, Bumper, Thermal Break, Saddle, Tile Back

Description	Size	Actual Unit Size	Rough Opening
	2'-6"	31-1/2" x 81"	32" x 81-1/2"
	2'-8"	33-1/2" x 81"	34" x 81-1/2"
	2'-10"	35-1/2" x 81"	36" x 81-1/2"
	3'-0"	37-1/2" x 81"	38" x 81-1/2"
	3'-6"	43-1/2" x 81"	44" x 81-1/2"
Double Door Unit	5'-0"	62" x 81"	62-1/2" x 81-1/2"
	5'-4"	66" x 81"	66-1/2" x 81-1/2"
	6'-0"	74" x 81"	74-1/2" x 81-1/2"

Description	Size	Actual Unit Size	Rough Opening
Sidelites	12"	13-1/2" x 82"	14" x 82-1/2"
(Inswing)	14"	15-1/2" x 82"	16" x 82-1/2"
	32"	33-1/2" x 82"	34" x 82-1/2"
	36"	37-1/2" x 82"	38" x 82-1/2"

Note: Outswing height

	12"	13-1/2" x 81"	14" x 81-1/2"
	14"	15-1/2" x 81"	16" x 81-1/2"
	32"	33-1/2" x 81"	34" x 81-1/2"
	36"	37-1/2" x 81"	38" x 81-1/2"

Continuous Sill Systems

Description	Size	Actual Unit Size	Rough Opening
w/(1) 12" Sdl	3'-0"	51" x 82"	51-1/2" x 82-1/2"
w/(2) 12" Sdl	3'-0"	64-1/2" x 82"	65" x 82-1/2"
w/(1) 14" Sdl	3'-0"	53" x 82"	53-1/2" x 82-1/2"
w/(2) 14" Sdl	3'-0"	68-1/2" x 82"	69" x 82-1/2"

Note: Outswing height

w/(1) 12" Sdl	3'-0"	51" x 81"	51-1/2" x 81-1/2"
w/(2) 12" Sdl	3'-0"	64-1/2" x 81"	65" x 81-1/2"
w/(1) 14" Sdl	3'-0"	53" x 81"	53-1/2" x 81-1/2"
w/(2) 14" Sdl	3'-0"	68-1/2" x 81"	69" x 81-1/2"

8'-0" DOOR HEIGHT

Sizes and Rough Openings

Description	Size	Actual Unit Size	Rough Opening
Single Door Unit	2'-6"	31-1/2" x 98"	32" x 98-1/2"
(Inswing)	2'-8"	33-1/2" x 98"	34" x 98-1/2"
	2'-10"	35-1/2" x 98"	36" x 98-1/2"
	3'-0"	37-1/2" x 98"	38" x 98-1/2"
	3'-6"	43-1/2" x 98"	44" x 98-1/2"
Double Door Unit	5'-0"	62" x 98"	62-1/2" x 98-1/2"
	5'-4"	66" x 98"	66-1/2" x 98-1/2"
	6'-0"	74" x 98"	74-1/2" x 98-1/2"

Note: Outswing Sill Height

Outswing, Bumper, Thermal Break, Saddle, Tile Back

Description	Size	Actual Unit Size	Rough Opening
	2'-6"	31-1/2" x 97"	32" x 97-1/2"
	2'-8"	33-1/2" x 97"	34" x 97-1/2"
	2'-10"	35-1/2" x 97"	36" x 97-1/2"
	3'-0"	37-1/2" x 97"	38" x 97-1/2"
	3'-6"	43-1/2" x 97"	44" x 97-1/2"
	5'-0"	62" x 97"	62-1/2" x 97-1/2"
	5'-4"	66" x 97"	66-1/2" x 97-1/2"
	6'-0"	74" x 97"	74-1/2" x 97-1/2"

Description	Size	Actual Unit Size	Rough Opening
Sidelites	12"	13-1/2" x 98"	14" x 98-1/2"
(Inswing)	14"	15-1/2" x 98"	16" x 98-1/2"

Note: Outswing height

Sidelites	12"	13-1/2" x 97"	14" x 97-1/2"
(Inswing)	14"	15-1/2" x 97"	16" x 97-1/2"

Continuous Sill Systems

Description	Size	Actual Unit Size	Rough Opening
w/(1) 12" Sdl	3'-0"	51" x 98"	51-1/2" x 98-1/2"
w/(2) 12" Sdl	3'-0"	64-1/2" x 98"	65" x 98-1/2"
w/(1) 14" Sdl	3'-0"	53" x 98"	53-1/2" x 98-1/2"
w/(2) 14" Sdl	3'-0"	68-1/2" x 98"	69" x 98-1/2"

Note: Outswing height

w/(1) 12" Sdl	3'-0"	51" x 97"	51-1/2" x 97-1/2"
w/(2) 12" Sdl	3'-0"	64-1/2" x 97"	65" x 97-1/2"
w/(1) 14" Sdl	3'-0"	53" x 97"	53-1/2" x 97-1/2"
w/(2) 14" Sdl	3'-0"	68-1/2" x 97"	69" x 97-1/2"

Center Hinged Patio Door Units

Description	Size	Rough Opening
Double Door Unit	63" x 82"	63-1/2" x 82-1/2"
	75" x 82"	75-1/2" x 82-1/2"

1 - There is no allowance in any of the height dimensions for a carpet shim – please add accordingly.

2 - Brick openings are 3" wider and 1-1/2" higher than actual unit size.

3 - For 7'-0" doors, add 4" to the actual unit size and rough opening height dimensions.

*NOTE—McCray uses wider mulls in continuous sill systems, so Rough Openings do not match ThermaTru information.

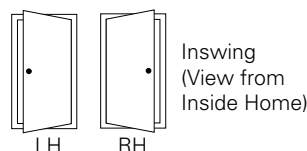
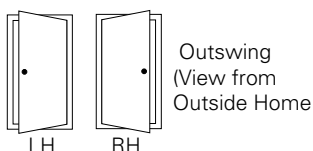

HANDING FOR PATIO DOORS

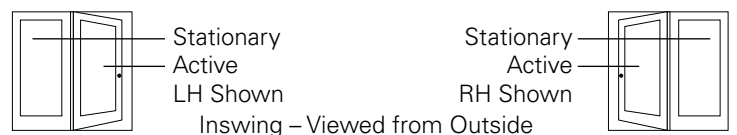

Note: For actual brickmould dimension add 1-1/4" to actual height and 2-1/2" to actual width.



Any Door, Any Style, Any Size



We design our doors with separate components that fit together precisely to create crisp, distinct lines. Each door's precision-engineered profile creates depth and shadow lines that enhance its architectural setting, rather than simply filling an opening.

Design & Size Options



PALAZZO SERIES*		PASSAGE											BIFOLDS											
		12"	14"	15"	16"	18"	20"	24"	26"	28"	30"	32"	34"	36"	18"	24"	28"	30"	32"	36"	48"	60"	72"	
	BELLAGIO® (2 ARCHED PANELS)																							
	smooth 80"																							
	smooth 84"																							
	CAPRI® (2 SQUARE PANELS)																							
	smooth 80"																							
	smooth 84"																							
	TREVISO® (3 PANELS)																							
	smooth 80"																							
	smooth 84"																							

*These Palazzo bifolds are shipped as two units.

WEST END COLLECTION*		PASSAGE											BIFOLDS											
		12"	14"	15"	16"	18"	20"	24"	26"	28"	30"	32"	34"	36"	18"	24"	28"	30"	32"	36"	48"	60"	72"	
	BERKLEY®																							
	smooth 80"																							
	smooth 84"																							
	HAMEL®																							
	smooth 80"																							
	smooth 84"																							
	MELROSE®																							
	smooth 80"																							
	smooth 84"																							

new

HERITAGE SERIES		PASSAGE											BIFOLDS											
		12"	14"	15"	16"	18"	20"	24"	26"	28"	30"	32"	34"	36"	18"	24"	28"	30"	32"	36"	48"	60"	72"	
	LINCOLN PARK® (1 PANEL)																							
	smooth 80"																							
	smooth 84"																							
	LOGAN® (2 PANELS)																							
	smooth 80"																							
	smooth 84"																							
	WINSLOW® (3 PANELS)																							
	smooth 80"																							
	smooth 84"																							

COMING SOON Q3

Commercial 10" Bottom Rail

MASONITE SELECT™		PASSAGE											BIFOLDS											
		12"	14"	15"	16"	18"	20"	24"	26"	28"	30"	32"	34"	36"	18"	24"	28"	30"	32"	36"	48"	60"	72"	
	CHEYENNE®																							
	smooth 80"																							
	RIVERSIDE®																							
	smooth 80"																							
	smooth 84"																							
	SADDLEBROOK®																							
	smooth 80"																							
	smooth 96"																							

MASONITE® INTERIOR DOORS

STOCK DOOR SIZES ONLY ARE MARKED AS INDICATED ABOVE - ALL OTHER SIZES ARE SPECIAL ORDER - NON-STOCK

MASONITE CLASSICS™

MOLDED PANEL SERIES		PASSAGE												BIFOLDS											
		12"	14"	15"	16"	18"	20"	24"	26"	28"	30"	32"	34"	36"	42"	16"	18"	24"	28"	30"	32"	36"	48"	60"	72"
	2 PANEL ARCH-TOP																								
	smooth 80"																								
	textured 80"																								
	smooth 84"																								
	2 PANEL ROMAN SMOOTH																								
	smooth 80"																								
	smooth 84"																								
	2 PANEL ROMAN SMOOTH																								
	smooth 80" Commercial 10" Bottom Rail																								
	2 PANEL																								
	smooth 80"																								
	smooth 84"																								
	2 PANEL																								
	smooth 80" Commercial 10" Bottom Rail																								
	3 PANEL																								
	textured 80"																								
	smooth 84"																								
	4 PANEL ARCH-TOP																								
	textured 80"																								
	4 PANEL																								
	smooth 80"																								
	smooth 84"																								
	6 PANEL																								
	smooth 80"																								
	textured 80"																								
	smooth 84"																								
	textured 84"																								
	smooth 96"																								
	6 PANEL COMMERCIAL																								
	smooth 80" Commercial 10" Bottom Rail																								

FLUSH SERIES		PASSAGE												BIFOLDS											
		12"	14"	15"	16"	18"	20"	24"	26"	28"	30"	32"	34"	36"	18"	24"	28"	30"	32"	36"	48"	60"	72"		
80", 84" & 96" Heights																									
HARDBOARD																									
Primed																									
VENEER																									
Oak, Birch, Hardwood																									

*Thinner outer stile will not affect functionality. Double doors and bifolds are not recommended. Due to manufacturing processes, a 1/8" tolerance is acceptable on horizontal lines.
 Note: 48", 60" & 72" bifolds are achieved by doubled 24", 30" & 36" bifolds.

Molded Panel Series & Masonite Select™ Collection Notes: Please note that some sizes are only available as a result of being trimmed from a larger facing. The trimming process may result in a stile width that is too narrow to accommodate a standard bore. To machine a standard bore with a 2-3/8" backset on the lock hole and a 2-1/8" diameter bore, the outer stile measurements must be no less than 3-7/16" wide. Many facings have a lockrail that will accommodate a standard bore even when the stile width is too narrow. Please refer to Masonite Molded Door Facing Dimensional Specifications to verify the outer stile measurements or contact your Masonite Interior Door servicing plant. Textured refers to embossed wood-grain. Pre-finished white is available textured only. Not all molded panel designs and sizes are available in all regions as stock products. Please check for special order availability. *Molded Panel actually measures 1'7-13/16".

STOCK DOOR SIZES ONLY ARE MARKED AS INDICATED ABOVE - ALL OTHER SIZES ARE SPECIAL ORDER - NON-STOCK

WOODGRAIN DOORS



SELECT THE DOOR THAT ENDURES

Fine doors dramatically transform homes. With seven wood species, factory primed wood doors, a line of MDF doors, and the ability to produce many custom door sizes and designs, Woodgrain offers the selection you need. The doors are designed to capture a distinct ambiance in every room, allowing you to create a true expression of individuality.

GLASS OPTIONS



Wood Muntin

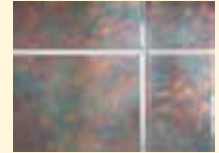

V-Groove

McCRA Y STOCK ITEMS:



RAD 108

Pine Interior Door

- 1'4" x 6'8" 1 3/8"
- 1'6" x 6'8" 1 3/8"
- 1'8" x 6'8" 1 3/8"
- 2'0" x 6'8" 1 3/8"
- 2'4" x 6'8" 1 3/8"
- 2'6" x 6'8" 1 3/8"
- 3'0" x 6'8" 1 3/8"



RAD 627

French Interior Door

- 2'0" x 6'8" 10lt
- 2'4" x 6'8" 15lt
- 2'6" x 6'8" 15lt
- 2'8" x 6'8" 15lt
- 3'0" x 6'8" 15lt



RAD 670

V-Groove Interior Door

- 2'0" x 6'8" 10lt
- 2'4" x 6'8" 15lt
- 2'6" x 6'8" 15lt
- 2'8" x 6'8" 15lt
- 3'0" x 6'8" 15lt



RAD 652

Pantry

- 2'4" x 6'8" 1 3/8"

SPECIAL ORDER DOORS:



Ponderosa Pine 634



Ponderosa Pine 822



Radiata Pine 102



Poplar 604



Knotty Alder 20 Planke
w/6702 Sidelite



French 6627



Mahogany 6532

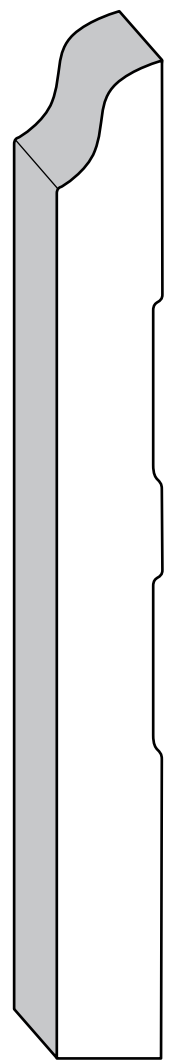
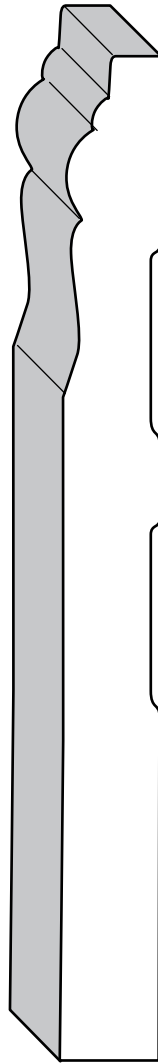
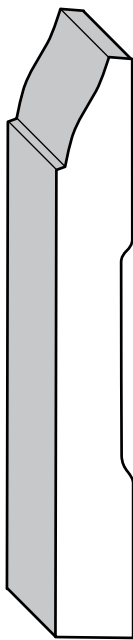
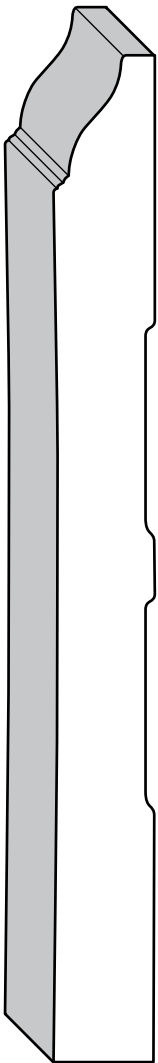

618

Colonial Base
 9/16" x 5 1/4"
 FJ (FJ618)
 Clear Pine (P618)
 Oak (O618)
 Flex Moulding (F618)

634

Colonial Base
 7/16" x 3"
 FJ (FJ634)
 Clear Pine (P634)
 Birch (B634)
 Oak (O634)
 Flex Moulding (F634)

647

Designer Base
 1/2" x 5 1/4"
 FJ (FJ647)
 Clear Pine (P647)
 Birch (B647)
 Knotty Alder (KA647)
 Oak (O647)

FJ658

Base
 9/16" x 5 1/4"
 FJ (FJ658)
 Clear Pine (P658)
 Birch (B658)
 Knotty Alder (KA658)
 Oak (O658)

Casing, Apron

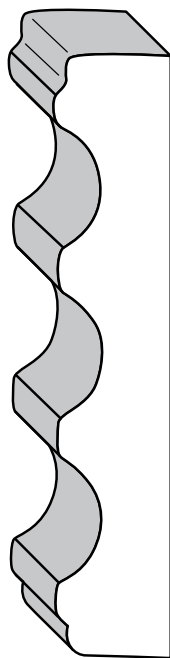

305
Fluted Casing
1 1/16" x 3 1/2"
Clear Pine (P305)
Oak (O305)

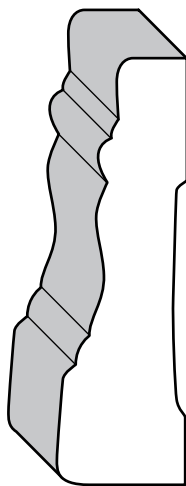

347
Casing
5/8" x 2 1/4"
FJ (FJ347)
Clear Pine (P347)
Oak (O347)

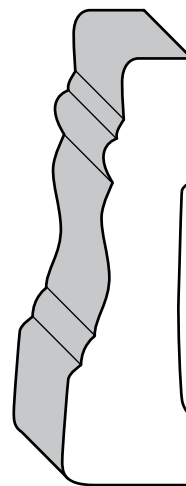

3477
Casing
5/8" x 2 1/4" (7' Piece)
FJ (FJ3477)

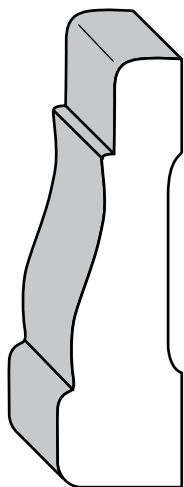

356
Casing
1 1/16" x 2 1/4"
FJ (FJ356)
Clear Pine (P356)
Birch (B356)
Oak (O356)

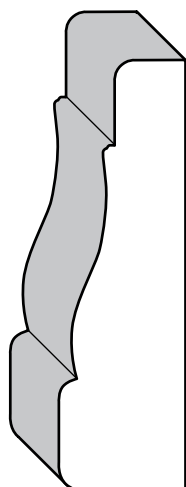

356A
Apron
1 1/16" x 2 1/4"
Clear Pine (P356A)

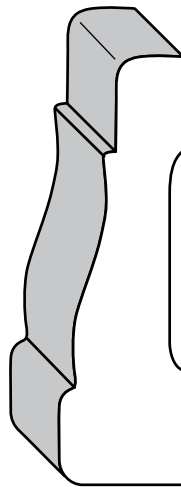

3567
Casing
1 1/16" x 2 1/4" (7' Piece)
FJ (FJ3567)
Clear Pine (P3567)
Oak (O3567)

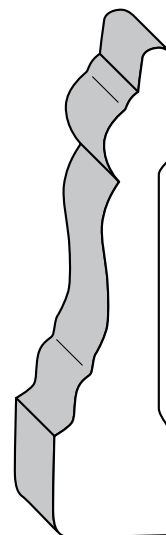

400
Casing
1 3/16" X 3 1/4"
FJ (FJ400)
Clear Pine (P400)
Birch (B400)
Knotty Alder (KA400)
Oak (O400)
Flex Moulding (F400)

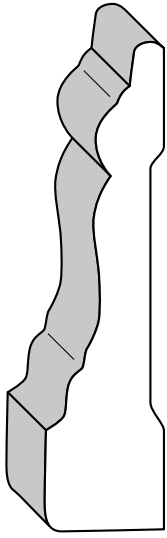

400
Casing
13/16" X 3 1/4" (7' Piece)
FJ (FJ4007)

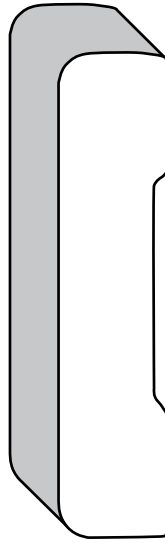

433
Hook Strip Casing
9/16" x 3 1/4"
FJ (FJ433)

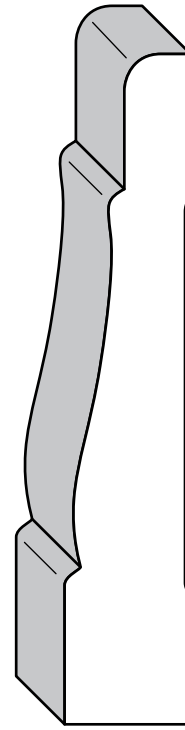

444
Casing
11/16" x 3 1/2"
FJ (FJ444)
Clear Pine (P444)
Knotty Alder (KA444)
Oak (O444)
Flex Moulding (F444)

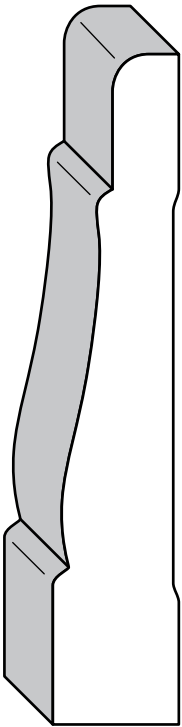

4447
Casing
11/16" x 3 1/2" (7'
Piece)
FJ (FJ4447)
Clear Pine (P4447)

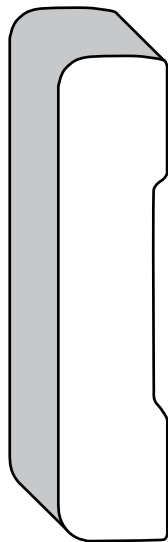

472
Hook Strip Casing
9/16" x 2 1/2"
FJ (FJ472)

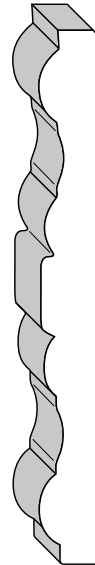

514B
Butterfly
Casing
9/16" x 5 1/8"
Clear Pine
(P514B)

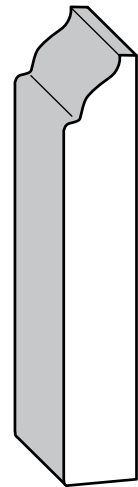

933
Apron
7/16" x 2 1/4"
Clear Pine (P933)

Crown

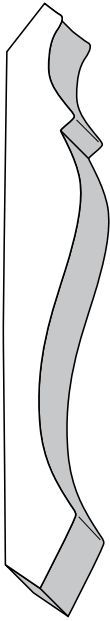

46
Crown
11/16" x 5 1/4"
Oak (O46)

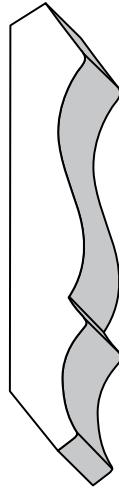

51
Crown
11/16" x 3 1/4"
FJ (FJ51)
Clear Pine (P51)
Maple (M51)
Knotty Alder (KA51)
Oak (O51)
Flex Moulding (F51)

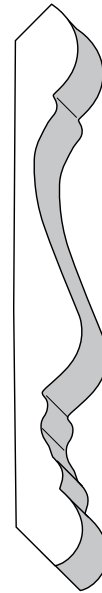

260
Crown
13/16" x 5 3/4"
FJ (FJ260)
Clear Pine (P260)
Knotty Alder (KA260)

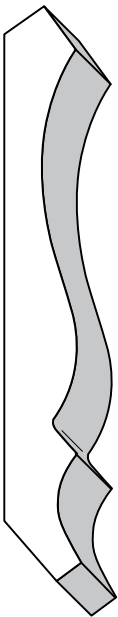

48
Crown
9/16" x 4 1/4"
FJ (FJ48)
Clear Pine (P48)
Maple (M48)
Knotty Alder (KA48)
Oak (O48)
Flex Moulding (F48)

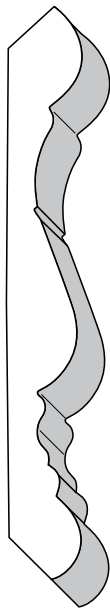

514C
Museum Crown
13/16" x 5 1/4"
Clear Pine (P514C)

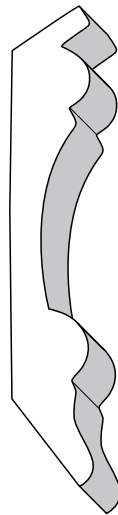

40
Designer Crown
13/16" x 4 1/2"
FJ (FJ40)
Clear Pine (P40)
Maple (M40)
Oak (O40)

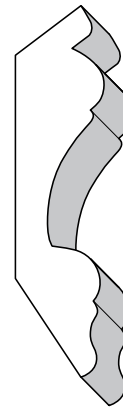

50
Designer Crown
3/4" x 3 1/4"
FJ (FJ50)
Oak (O50)

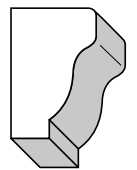

102
Cabinet Crown
11/16" x 1 1/16"
Oak (O102)

Lattice, Dentil Mould, Base Shoe, ShoeCap

LATTICE

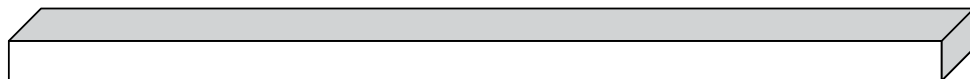

8L
Lattice
9/32" x 7 1/4"
Clear Pine (P8)



264
Lattice
9/32" x 2"
Clear Pine (P2640)
Oak (O264)

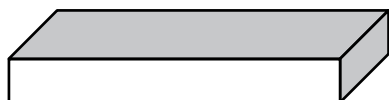

265
Lattice
9/32" x 1 3/4"
Clear Pine (P265)

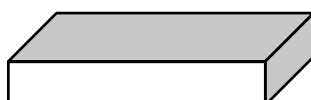

267
Lattice
9/32" x 1 3/8"
Clear Pine (P267)

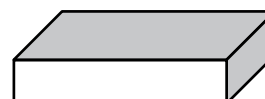

268
Lattice
9/32" x 1 1/8"
Clear Pine (P268)

DENTIL MOULD

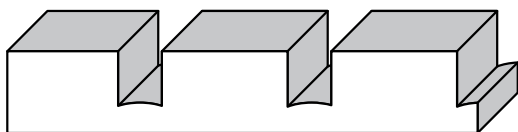

70
Dentil Mould
7/16" x 5/8"
Clear Pine (P70)

BED MOULD



74
Bed Mould
9/16" x 1 3/4"
Clear Pine (P74)

BASE SHOE

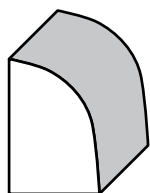

126
Base Shoe
1/2" x 3/4"
Clear Pine (P126)
Knotty Alder (KA126)
Flex Moulding (F126)

BASE CAP

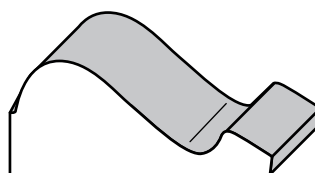

163
Base Cap
1 1/16" x 1 3/8"
Clear Pine (P163)
Maple (M163)
Knotty Alder (KA163)
Oak (O163)
Flex Moulding (F163)

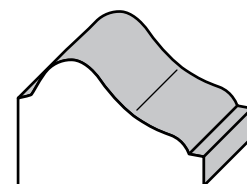

1100
Base Cap
3/4" x 1"
FJ (FJ1100)
Clear Pine (P1100)
Maple (M1100)
Knotty Alder (KA1100)
Oak (O1100)
Flex Moulding (F1100)

Cove, Back Band, Glass Bead

Cove

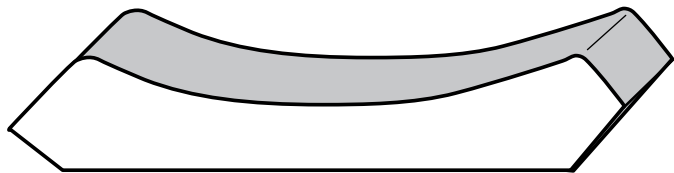

81
Cove
9/16" x 3 1/4"
Knotty Alder (KA81)

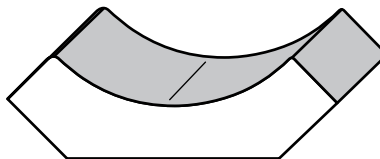

85
Cove
9/16" X 1 3/4"
Maple (M85)

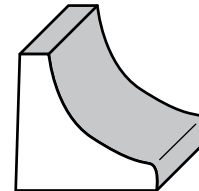

93
Cove
3/4" x 3/4"
Clear Pine (P93)
Oak (O93)

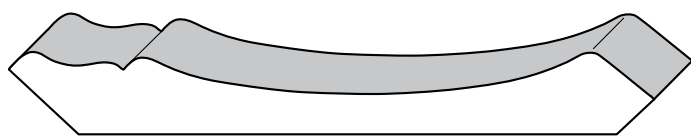

414
Cove
9/16" x 4 1/4"
FJ (FJ414)
Clear Pine (P414)
Knotty Alder (KA414)

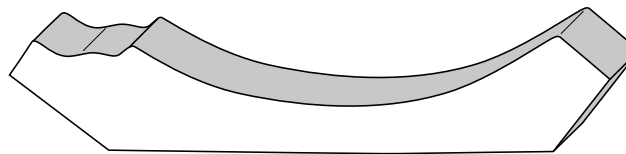

2008
Cove
1" x 5 1/4"
Clear Pine (P2008)
Oak (O2008)

BACK BANK

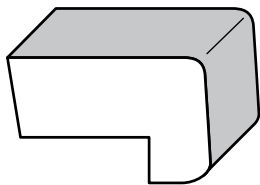

280
Back Band
11/16" x 1-1/16"
Clear Pine (P280)

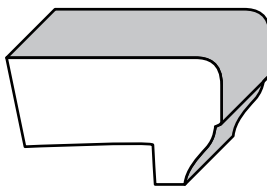

281
Back Band
11/16" x 1-1/16"
Clear Pine (P281)
Clear Pine (For 3/4" P281A)

GLASS BEAD

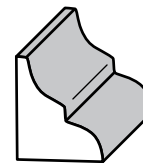

147
Glass Bead
1/2" x 9/16"
Clear Pine (P147)

SCREEN MOULD

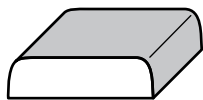

142

Screen Mould
1/4" x 3/4"
Clear Pine (P142)

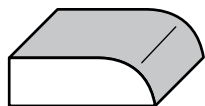

143

Screen/Scribe Mould
1/4" x 3/4"
Oak (O143)

DECCA

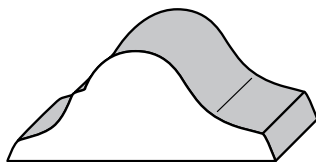

182

Decca C
1 1/16" x 1 5/8"
FJ (FJ182)
Clear Pine (P182)
Maple (M182)
Knotty Alder (KA182)
Oak (O182)
Flex Moulding (F182)

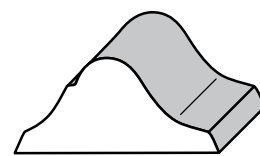

183

Decca B
9/16" X 1 1/8"
FJ (FJ183)
Clear Pine (P183)
Maple (M183)
Knotty Alder (KA183)
Oak (O183)
Flex Moulding (F183)

OUTSIDE CORNER

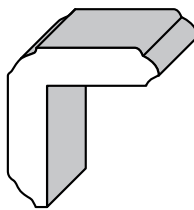

202

Outside Corner
1 1/8" x 1 1/8"
Clear Pine (P202)
Maple (M202)
Oak (O202)

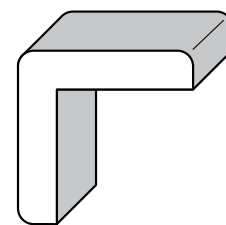

205

Outside Corner
1 1/8" x 1 1/8"
Oak (O205)

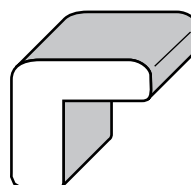

206

Outer Corner
3/4" x 3/4"
Clear Pine (P206)

HAND RAIL

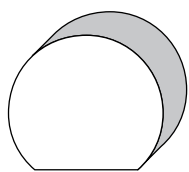

231

Hand Rail
1 1/2" x 1 11/16"
Clear Pine (P231)

SCREEN STOCK

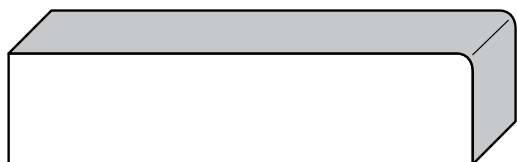

246

Screen Stock
3/4" x 2 3/4"
Clear Pine (P246)

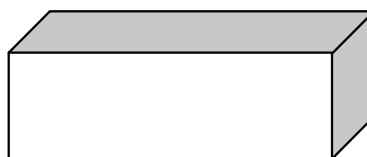

247

Screen Stock
3/4" x 2"
Clear Pine (P247)

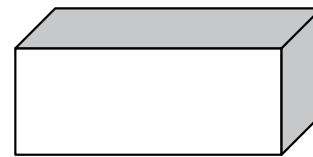

249

Screen Stock
3/4" x 1 5/8"
Clear Pine (P249)

Quarter & Half Round, Closet Pole, Stop, Beam Bottom

QUARTER ROUND

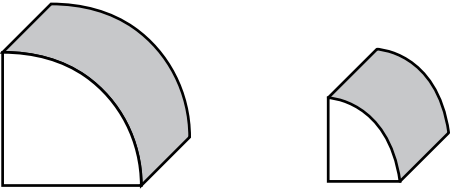

105
Quarter Round
3/4" x 3/4"
Clear Pine (P105)
Oak (O105)

108
Quarter Round
1/2" x 1/2"
Clear Pine (P108)

HALF ROUND

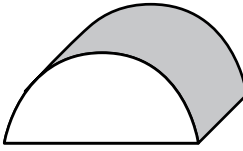

120
Half Round
1/2" x 1"
Clear Pine (P120)

CLOSET POLE

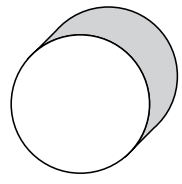

233
Closet Pole
1 5/16"
Clear Pine (P233)

STOP

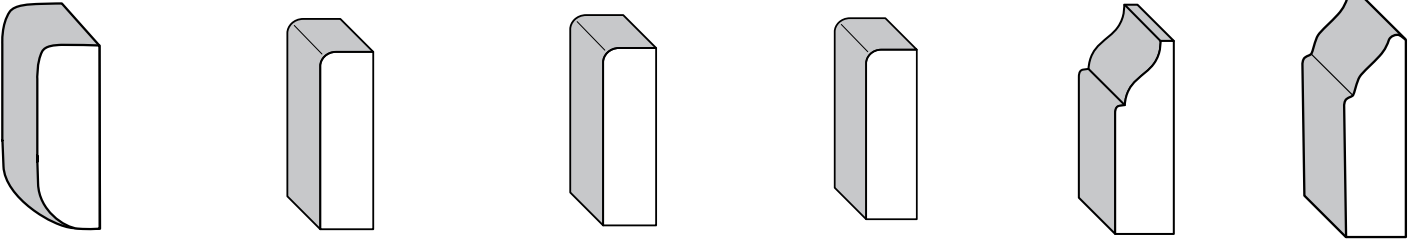

118
Stop
1 1/8" X 5/16"
Clear Pine (P118)

876
Stop
7/16" x 1 3/8"
Clear Pine (P876)
Maple (M876)
Knotty Alder (KA876)

8767
Stop 7' Piece
7/16" x 1 3/8"
Clear Pine (P8767)

8768
Stop (8' Piece)
7/16" x 1 3/8"
FJ (FJ8768)

936
Stop
7/16" x 1 3/8"
Clear Pine (P936)

937
Stop
7/16" x 1 1/4"
Oak (O937)

PARTING STOP

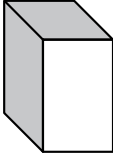

254
Parting Stop
1/2" x 3/4"
Clear Pine
(P254)

BULL NOSE STOP

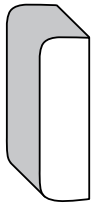

887
Bull Nose Stop
3/8" x 1 1/4"
Oak (O887)

SCANT STOP

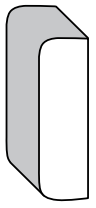

3017
Scant Stop 7' Piece
3/8" x 1 1/16"
Oak (O3017)

BEAM BOTTOM

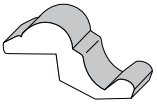

287
Beam Bottom
3/4" x 1 7/8"
Clear Pine (P287)
Knotty Alder (KA287)
Oak (O287)
Flex Moulding (F287)

MANTEL MOULD

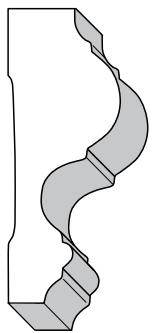

234

Small Mantel Mould
1" x 2 3/4"
FJ (FJ234)
Clear Pine (P234)
Knotty Alder (KA234)

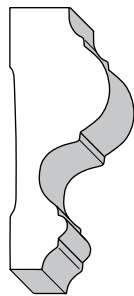

301

Small Mantel Mould
1" x 2 3/4"
Oak (O301)

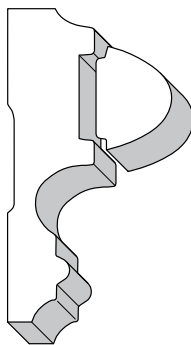

302

2-Piece Mantel Mould
1 1/4" x 3 5/8"
Oak (O302)

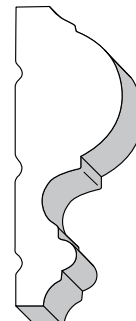

358

1 Piece Mantel Mould
1 1/4" x 3 5/8"
FJ (FJ358)
Clear Pine (P358)
Maple (M358)
Knotty Alder (KA358)
Oak (O358)
Flex Moulding (F358)



514

Mantel Mould
1 3/8" x 5 1/4"
Clear Pine (P514)
Maple (M514)
Oak (O514)
Flex Moulding (F514)

PICTURE MOULD

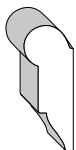

273

Picture Mould
1 1/16" X 1 3/4"
Clear Pine (P273)

CLOVERLEAF MOULD



137

Cloverleaf Mould
3/8" x 3/4"
Clear Pine (P137)
Oak (O137)

LIBRARY PANEL MOULD



286

Library Panel Mould
1/2" x 1 7/8"
Clear Pine (P286)
Oak (O286)

NOSING & COVE

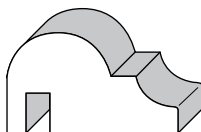

8081K

Nosing & Cove
1 1/8" x 1 3/4"
Oak (O8081)

CHAIR RAIL

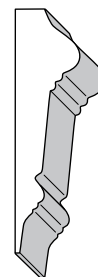

70

Chair Rail
9/16" x 2 1/2"
Knotty Alder
(KA70)

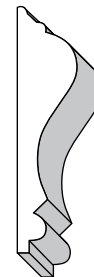

390

Chair Rail
1 1/16" x 2 5/8"
FJ (FJ390)
Clear Pine (P390)
Oak (O390)
Flex Moulding
(F390)

PLINTH

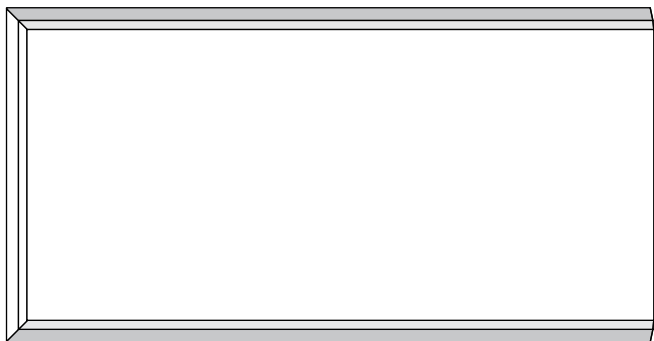

P13
Plain Plinth
5 1/2" x 9"
Clear Pine (PP5129P)



PP54
Plain Plinth
3 1/2" x 7"
Clear Pine (PP3127P)

BULLS EYE

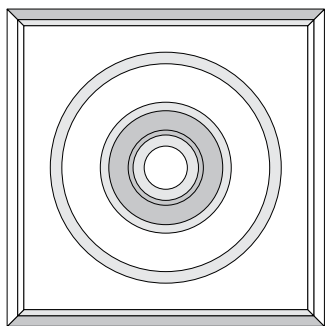

P15
Bulls Eye
5 1/2" x 5 1/2"
Clear Pine (PBE512)

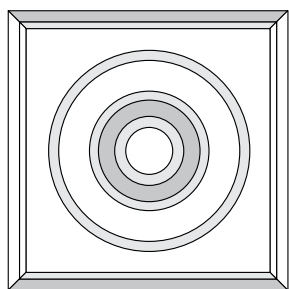

PR51
Bulls Eye
3 1/2" x 3 1/2"
Clear Pine (PBE312)

JAMB

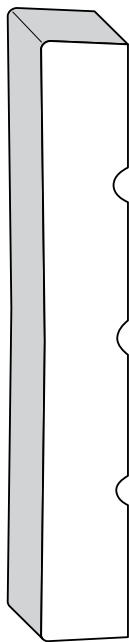

49
Flat Jamb Lineal
4 9/16" x 6'8" Pr
FJ (FJ49)
Clear Pine (P49)
Flex Moulding (F49)

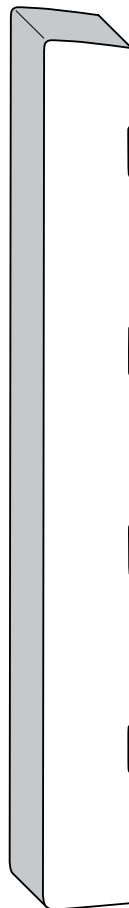

69
Flat Jamb Pair
6 9/16" x 6'-8"
FJ (69)
Clear Pine (CFJ69)

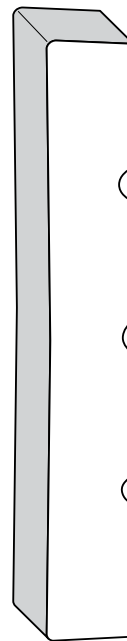

L49
Flat Jamb Lineal
4 9/16"
Clear Pine (CFJ49L)
Oak (OF49L)



CAPITALS



COLUMNS



crafting inspiration



DuraCast Round Fiberglass Columns

*Round Stock Columns come standard with
Tuscan Cap & Base/Plinth as shown.*

Product	Item #	Code #
8" x 8' plain	88COLPC	COL0808
8" x 10' plain	810COLPC	COL0810
10" x 8' plain	108COLPC	COL1008
10" x 10' plain	1010COLPC	COL1010
10" x 12' plain	1012COLPC	COL1012
12" x 8' plain	128COLPC	COL1208
12" x 10' plain	1210COLPC	COL1210
12" x 12' plain	1212COLPC	COL1212

**Additional column sizes and styles are available
by Special Order including fluted, barrel, square,
non-tapered, and wood.**



www.crowncolumn.com

NEWELS

BALUSTERS

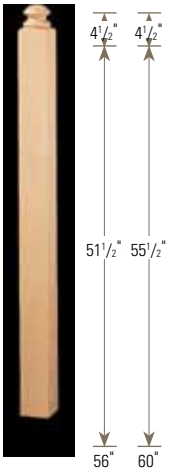

4005
Spade Top Newel
M4005 (56")
O4005 (56")
H4005 (60")



4015 (62")
Pin Top Landing Newel
M4015
O4015

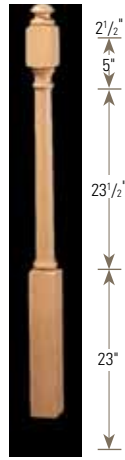

4042 (54")
Mushroom Top Newel
M4042
O4042

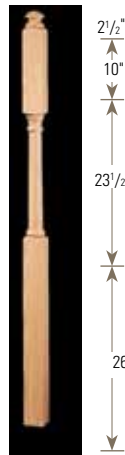

4045 (62")
Mushroom Top Newel
M4045
O4045

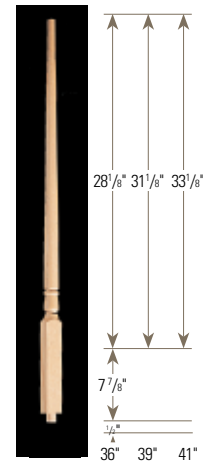

5015
1 1/4" Baluster
PR501536
PR501539
PR501541

All McCray's stock iron profiles are powder coated for beauty & durability.



■ McCray's Stock Iron Balusters & Shoe

658
SB1T
ORB1T

533
SB2T
ORB2T

482
SB1B
ORB1B

McCray's
Stock Finishes

SB
Satin Black
SBS

ORCX
Oil Rubbed
Copper
ORCS

■ Box Newel Program

4091 Recessed Panel
M4091RP
O4091RP

3-1/2"
5"
22-1/2"
24"
Plain 55"
M4091
O4091

3-1/2"
5"
55-1/4"
Plain 63"
M4075
O4075

M4091 | M4075
Interchangeable
pyramid and flat
caps included

Please contact your McCray salesperson for a complete brochure.

7010
Starting Easing



M7010
O7010

7011
Level



M7011
O7011

7011S-LH/RH
LH Turn/RH Turn
Quarterturn



M7047-LH
M7048-RH
O7047-LH
O7048-RH

7012
Up Easing
(RH pictured)



M7012
O7012

7013
Over Easing



M7013
O7013

7015
Starting Easing



O7015

7019
Opening Cap



M7019
O7019

7020
Tandem Cap



M7020
O7020

7021
Level
Quarterturn w/ Cap



M7021
O7021

7030
Left-Hand Volute



M7030
O7030

7035
Right-Hand Volute



M7035
O7035

7040
Left-Hand Turnout



M7040
O7040

7045
Right-Hand Turnout



M7045
O7045

7026
Round Rosette
4 1/4" Diameter



M7026
O7026

7027
Oval Rosette
4 1/16" x 6 1/2"



M7027
O7027
H7027



7060
Left-Hand
2 Riser
With Cap
M7060
O7060



7065
Right-Hand
2 Riser
With Cap
M7065
O7065



7081
Left-Hand
2 Riser
With Cap
M7081
O7081



7086
Right-Hand
2 Riser
With Cap
M7086
O7086



7088-2
2 Riser
With Cap
M7088-2
O7088-2



7099
2 Riser
No Cap
O7099

HANDRAILS
SHOERAILS
FILLETS
TREADS



6010
No Plow Handrail

8-0 PC O60108
M60108
10-0 PC O601010
12-0 PC O601012
14-0 PC O601014
16-0 PC O601016
Maple Maple
Oak Oak



6010P
Plowed w/ Fillet

8-0 PC OP60108
10-0 PC OP601010
12-0 PC OP601012
14-0 PC OP601014
16-0 PC OP601016
Oak Oak



6010B
Bending Rail w/ Mould

8-0 PC MB60108
OB60108
10-0 PC MB601010
12-0 PC MB601012
14-0 PC MB601014
16-0 PC MB601016
OB601016
Maple Maple
Oak Oak



6011B
Supertight Handrail

8-0 PC MST60108
OST60108
10-0 PC MST601010
OST601010
12-0 PC MST601012
OST601012
14-0 PC MST601014
OST601014
16-0 PC MST601016
OST601016
Maple Maple
Oak Oak

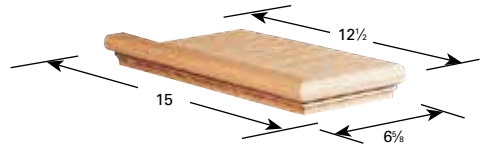

8071
Right-Hand and Left-Hand False Tread Cap

O8071L M8071L
O8071R M8071R



6006
Lineal Plowed
Shoerail w/Fillet

O6006



6045
Plowed Shoerail
w/ Fillet

M6045
O6045



6050
Lineal Fillet
1/4" x 1/4"

M6050



6042
Wall Rail

16-0 PC H6042
Hemlock



8080
Lineal Return
1 1/2" x 1 1/8"

O8080
M8080



8066
Nosing and Cove
1 1/4" x 1 1/8"

M8081
O8081

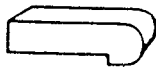

8090
Landing Tread
5 1/4" or 3 1/2"

M8090514 O8090312
O8090514 POP8090312

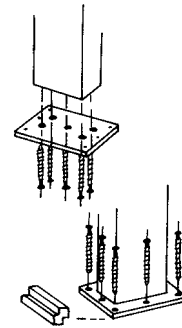

3006
Newel Plate Kit w/ Trim

NPM
NPO

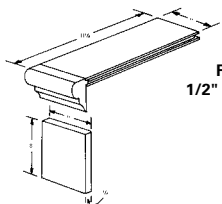

False Tread Cap
1/2" X 5 1/2" X 12 5/8"

O8072
M8072

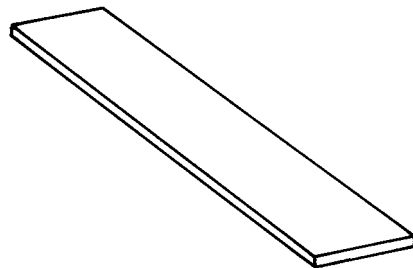

8070
Plain Tread
48" x 11 1/2"

M8070148
O8070148

8070
Plain Tread
60" x 11 1/2"

O8070160

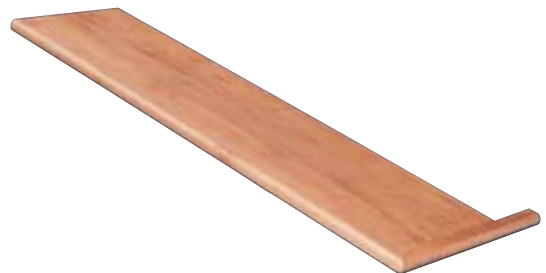

8070MR
Mitered Return Tread
Reversible
48" x 11 1/2"
60" x 11 1/2"

MR8070148
MR8070160
OR8070148

8070MR
Mitered Return Tread
Reversible
48" x 11 1/2"
60" x 11 1/2"

OR8070148
OR8070160

STAIR PARTS TERMS ILLUSTRATED AND DEFINED

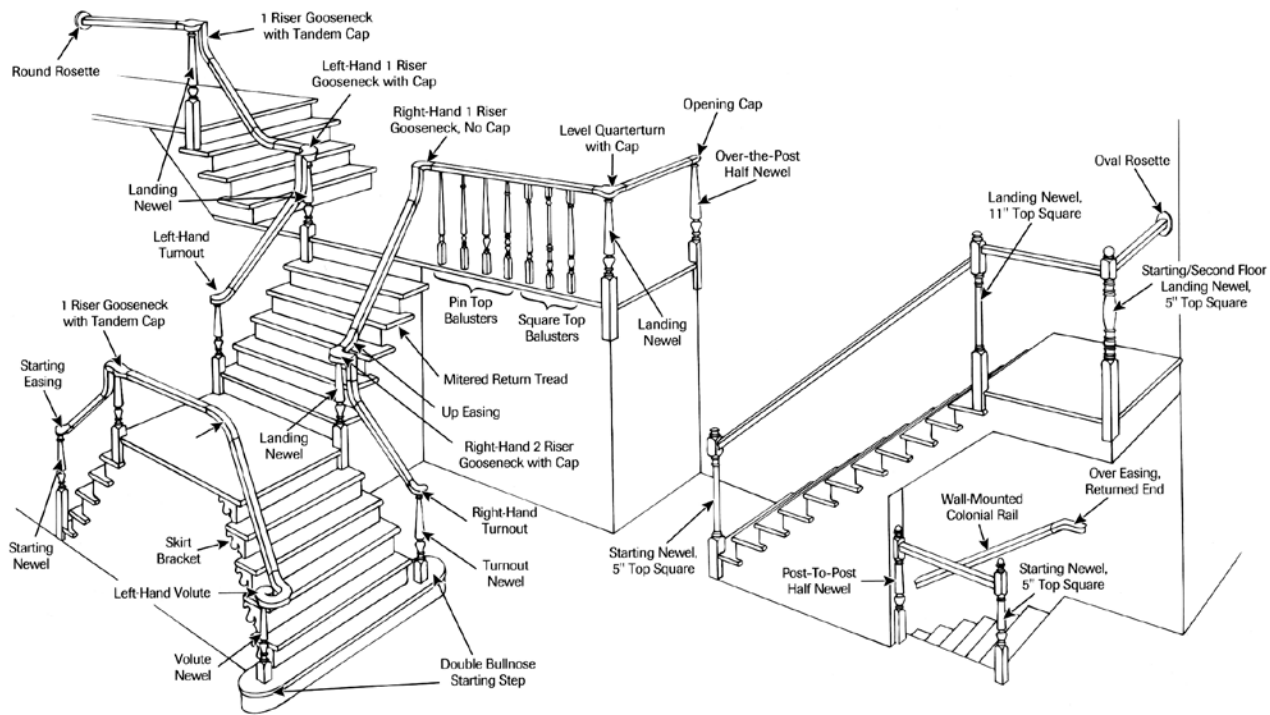

BALUSTERS

The vertical posts which support the railing of the staircase. The term "Balustrade" refers to the baluster and rail system.

COVE MOULDING

A decorative strip which, when attached to the underside of the tread nosing, covers the joint between the tread and riser.

FILLET

Strips which fill the plow between balusters on plowed handrail and shoerail.

FITTINGS

The stair parts used to form a smooth transition when the handrail changes height or direction. For example, starting a balustrade (volute, turnout, starting easing), at a landing (gooseneck) and at a balcony.

HANDRAILS

The horizontal or rake member of a balustrade system. It sits on top of the balusters and is supported by newel posts.

NEWELS

The major support posts for the balustrade system. Larger and heavier than the balusters, newels are located at the bottom and top of a staircase and at turns and critical support areas of balcony rails.

NOSING

The portion of a tread or landing tread which protrudes beyond the face of the riser.

RAKE

The slope or angle of the staircase (also referred to as rake angle).

RISERS

The vertical component of a stair which supports the treads.

SHOERAIL

A piece running along the floor which is plowed for the insertion of balusters and fillets.

STARTING STEPS

The first tread and riser at the bottom of the staircase.

TREADS

The horizontal portion of the staircase upon which you walk.

PLYWOOD

BOARD STOCK

#2 & BTR PINE BOARDS

	6' Length	8' Length	10' Length	12' Length	14' Length	16' Length
1 x 4		P2148	P21410	P21412	P21414	P21416
1 x 6		P2168	P21610	P21612	P21614	P21616
1 x 8		P2188	P21810	P21812	P21814	P21816
1 x 12		P2112	P211210	P211212	P211214	P211216

C & BTR PINE BOARDS

	6' Length	8' Length	10' Length	12' Length	14' Length	16' Length
1 x 4	PC146	PC148	PC1410	PC1412	PC1414	PC1416
1 x 6	PC166	PC168	PC1610	PC1612	PC1614	PC1616
1 x 8	PC186	PC188	PC1810	PC1812	PC1814	PC1816
1 x 12	PC1126	PC1128	PC11210	PC11212	PC11214	PC11216

	PR 16'	MDF 16'	Red Oak RL	Poplar RL	Knotty Alder RL	Maple RL
1 x 2	PR12					
1 x 4	PR14	MDF14	O1X4	POP1X4	KA1X4	M1X4
1 x 6	PR16	MDF16	O1X6	POP1X6	KA1X6	M1X6
1 x 8	PR18	MDF18	O1X8	POP1X8	KA1X8	M1X8
1 x 12	PR112	MDF112	O1X12	POP1X12	KA1X12	M1X12

PARTICLE BOARD SHELVING

	1 x 12	1 x 16	1 x 24
12'	PBS1212	PBS1612	PBS2412
8'		PBS1168	

STEPPING

	5/4 x 12
7'	PBS54127
9'	PBS54129

CAR SIDING #2 PINE

1 x 6-8	CS168
1 x 6-10	CS1610
1 x 6-12	CS1612
1 x 6-14	CS1614
1 x 6-16	CS1616

SHEET GOODS

BIRCH

	1/8"	1/4"	1/2"	3/4"
Bending	18BBP	BB14		
A2			12A2B	34A2B
A3		14A3B		
C2				B34
A1				B34A1
B2				B34A2

OAK

	1/4"	1/2"	3/4"
		O1428	O34
	O14A3		

KNOTTY ALDER

	1/4"	3/4"
	KA14	KA34

MDF SHEETS 4 x 8

1/4"	MDF1448
1/2"	MDF1248
3/4"	MDF3448
3/4"-10"	MDF3410

MISCELLANEOUS SHEETS

Bead Board 1/4" 4x8	BB14
Cedar Closet Liner 1/4" 4x8	CCL
Lauan Underlayment 1/4" 4x8	L14
Pine 4" OC Beaded High Ridge Snow Drift 1/4" 4x8	PBB14
Pine 2.0" OC Beaded Plywood Clear Face 3/8" 4x8	PBEADED
Primed Beaded Jubilee Beaded Plywood Pan 3/16" 4x8	PRBEADED



Tavaris®



Montara®



Amherst®



Arlington®



Ashfield®



Austin™



Avalon™



Stock Item
Chaisa™
Stock Item



Avalon™



Austin™



Hawthorne™



Montara™



Shelburne™



Wellington™



980



Stock Item



816 Key Control™
Deadbolt



980 Austin
Deadbolt

Designer Roses



Arched Rose
Oval Rose



Pocket Door Lock
(3.5, 10B, 26D)
(3.5, 10B, 15, 26D)



Ashfield™

Austin™



Avalon™

Brooklane®



Abbey®

Cameron®

Copa®

Circa®



Commonwealth®

Lido®



Stock Item
Stock Item

Laurel®

Phoenix®



Pembroke™

Tustin™

Pembroke

Stock Item
Stock Item

Contemporary

Halifax™



NEW

Milan™



NEW



993 RDT

993 SQ T

Tavaris™

Katara™

Vedani™



Belleview™



Belleview™



Dakota™



660



Tylo®



Cove™



Delta®



Balboa™



Cove™



Delta®



Balboa™



kēvo.



SMARTCODE 913
TOUCHPAD ELECTRONIC DEADBOLT



SMARTCODE
TOUCHPAD ELECTRONIC DEADBOLT



SMARTCODE
TOUCHPAD ELECTRONIC DEADBOLT



Powerbolt



SMARTCODE
TOUCHPAD ELECTRONIC LEVER

BALDWIN® RESERVE™

TRADITIONAL	CONTEMPORARY	RUSTIC
-------------	--------------	--------

HANDLESETS



DEADBOLTS



KNOBS/LEVERS



ROSES



FINISHES



Quick Ship ~ Custom Order



We've Got You Covered

At Hager Companies, we are focused on being the one company that can offer a full line of quality door hardware under one brand name. With 11 product lines, we provide thousands of superior products that help distributors and end users complete the hardware circle.

One Family. One Brand. One Vision.™

Call your sales representative for more information

© 2015 Hager Companies
www.hagerco.com



EXTERIOR WOOD/SC 1-3/4" HINGES:

4" Radius-Radius US2D Zinc Dichromate (Brass)	H4YZ
4" Radius-Radius US5 Antique Brass	H4AB
4" Radius-Radius US10B Oil-Rubbed Bronze	H4ORB
4" Radius-Radius US15 Satin Nickel	H4SN



EXTERIOR OUTSWING HINGES:

4" Radius Outswing US2D Zinc Dichromate (Brass)	H4YZNRP
4" Radius US15 Satin Nickel	H4SNRP
4" Radius-Radius US10R Oil-Rubbed Bronze Non-Removable Pin	H4ORBNRP

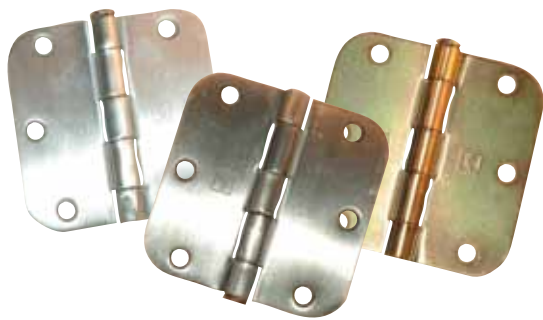

EXTERIOR SPRING HINGES:

4" Spring US2D Zinc Dichromate (Brass)	H4YZSH
4" Spring US10B Oil-Rubbed Bronze	H4ORBSh
4" US15 Satin Nickel Spring Hinge	H4SNSh



INTERIOR WOOD/SC 1-3/8" HINGES:

3-1/2" Radius US2D Zinc Dichromate (Brass)	H312YZ
3-1/2" Radius US10B Oil-Rubbed Bronze	H312ORB
3-1/2" Radius US15A Antique Nickel	H312AN
3-1/2" Radius US15 Satin Nickel	H312SN
3-1/2" Radius US1B Black	H312B
3-1/2" Radius US3 Bright Brass	H312BB



HINGE BUMPS:

Door Saver Hinge Bump US3 Brass	DSHBBB
Door Saver Hinge Bump US10B Oil-Rubbed Bronze	DSHORB
Door Saver Hinge Bump US15 Satin Nickel	DSHSN

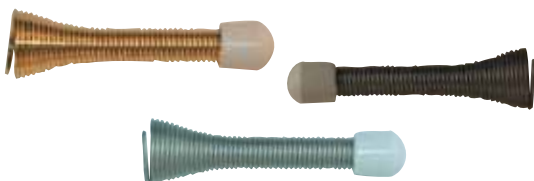

SPRING BUMPS:

Spring Door Stop Bump US3 Brass	SDSBB
Spring Door Stop Bump US10B Oil-Rubbed Bronze	SDSORB
Spring Door Stop Bump US15 Satin Nickel	SDSSN

PIANO HINGES:

4'-0" Piano Hinge US2D Zinc Dichromate (Brass)	PHBB4
6'-0" Piano Hinge US2D Zinc Dichromate (Brass)	PHBB6
4'-0" Piano Hinge Satin Nickel	PHSN4
6'-0" Piano Hinge Satin Nickel	PHSN6
6'-0" Piano Hinge ORB	PHORB6



BALL CATCHES:

Ball Catch US3 Brass	BCBB
Ball Catch US26D Stain Chrome	BCSC
Ball Catch US10B Oil-Rubbed Bronze	BCORB
Ball Catch US15A Antique Nickel	BCAN
Ball Catch US15 Satin Nickel	BCSN

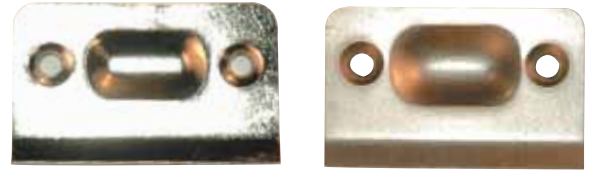

INTERIOR FLUSH BOLTS:

Round Flush Bolt 5-7/8" US3 Brass	FB5783
Round Flush Bolt 5-7/8" US10B Oil-Rubbed Bronze	FB60RB
Round Flush Bolt 5-7/8" US15 Satin Nickel	FB578SN



BI-FOLD & BI-PASS HARDWARE:

Bi-fold Knobs US3 Brass	BKBB
Bi-fold Knobs US15 Satin Nickel	BKSN
Bi-fold Knobs US10B Oil Rubbed Bronze	BKORB
Bi-fold Hardware	BH
Bi-fold Track & Hardware 4'-0"	BFTH4
Bi-fold Track & Hardware 5'-0"	BFTH5
Bi-fold Track & Hardware 6'-0"	BFTH6
Bi-pass Door Finger Pull US3 Bright Brass	FPBB (Stock)
Bi-Pass Door Finger Pull US15 Satin Nickel	FPSN (Non-stock)
Bi-Pass Door Finger Pull US10B Oil-Rubbed Bronze	FPORB (Non-stock)



Bi-pass Track & Hardware 4'-0"	BTH4
Bi-pass Track & Hardware 5'-0"	BTH5
Bi-pass Track & Hardware 6'-0"	BTH6
Bi-pass Hardware	BPH



POCKET DOOR HARDWARE:

2'-0" x 6'-8" Pocket Door Frame	PDF2068
2'-4" x 6'-8" Pocket Door Frame	PDF2468
2'-6" x 6'-8" Pocket Door Frame	PDF2668
2'-8" x 6'-8" Pocket Door Frame	PDF2868
3'-0" x 6'-8" Pocket Door Frame	PDF3068
2'-0" x 8'-0" Pocket Door Frame	PDF2080
2'-4" x 8'-0" Pocket Door Frame	PDF2480
2'-6" x 8'-0" Pocket Door Frame	PDF2680
2'-8" x 8'-0" Pocket Door Frame	PDF2880
3'-0" x 8'-0" Pocket Door Frame	PDF3080
Pocket Door Frame Connector #751	PDC
Pocket Door Frame Hardware Bag #1750	PDH

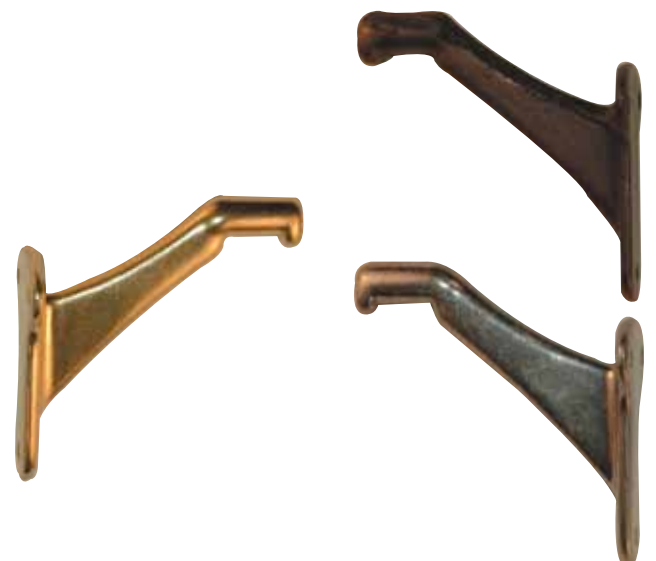

HANDRAIL BRACKETS:

Handrail Bracket US5 Antique Brass	HBAB
Handrail Bracket US10A Oil Rubbed Bronze	HBORB
Handrail Bracket US15 Satin Nickel	HBSN

HARDWARE

DOOR VIEWER:

Small Door Viewer Brass
 Small Door Viewer Satin Nickel
 Small Door Viewer Oil-Rubbed Bronze

PEEP
 PEEPSN
 PEEPORB

CLOSET HARDWARE:

Metal Closet Poles 18"-30"
 Metal Closet Poles 30"-48"
 Metal Closet Poles 48"-72"
 Metal Closet Poles 72"-120"
 Metal Closet Poles 72"-96"
 Metal Closet Poles 96"-150"
 Closet Pole Sockets Plastic
 Closet Pole Socket Oil-Rubbed Bronze
 Closet Pole Socket Brass
 Closet Pole Socket Satin Nickel
 Closet Pole Socket Wooden
 Shelf & Rod Supports
 Shelf Supports

MCP1830
 MCP3048
 MCP4872
 MCP72120
 MCP7296
 MCP96150
 CPSP
 CPSORB
 CPSBB
 CPSSN
 CPSW
 SRS
 SS

GLUE:

Titebond II Glue (1 Gallon)
 Construction Adhesive (29 Oz)
 Powered Resin Glue "DR" (5 Lb)

WG1
 82TCA
 RG5

MISCELLANEOUS:

Epoxy Gun / Iron Stair Parts
 Epoxy Black For Iron Stair Parts w/Mixing Tips
 Epoxy Clear for Iron Stair Parts w/Mixing Tips
 Newel Plate Kit - No Trim
 Shim Wedges
 Rail Bolt 5/16" x 4" W/Plugs

EPOXGUN
 EPOXBLK
 EPOXCLE (NONSTOCK)
 NP
 SW
 RB

HOUSE #s:

	Black	Solid Brass	Satin Nickel	Oil Rubbed
House # 0	HNB0	HNBB0	HNSN0	HNORB0
House # 1	HNB1	HNBB1	HNSN1	HNORB1
House # 2	HNB2	HNBB2	HNSN2	HNORB2
House # 3	HNB3	HNBB3	HNSN3	HNORB3
House # 4	HNB4	HNBB4	HNSN4	HNORB4
House # 5	HNB5	HNBB5	HNSN5	HNORB5
House # 6	HNB6	HNBB6	HNSN6	HNORB6
House # 7	HNB7	HNBB7	HNSN7	HNORB7
House # 8	HNB8	HNBB8	HNSN8	HNORB8
House # 9	HNB9	HNBB9	HNSN9	HNORB9



McCray Lumber  Millwork

Serving the Professional Builder for over 65 years!

www.mccraylumber.com

04/2015