

## **SPECIFICATIONS**

The Dibiten Specifications Manual has been prepared to serve as a guide for architects, specifiers, roofing contractors and others involved in the roof system selection and application process. This manual is intended only as a guide and the recommendations represent Dibiten's best judgement based on years of experience in the manufacture of modified bitumen roofing material. Dibiten does not claim to be expert with regard to roof system components or elements not manufactured by Dibiten.

In all roofing or waterproofing situations, local code requirements, standard good roofing practices such as those established by the National Roofing Contractors Association, and the requirements and specifications of the manufacturers of other elements of the roof system must be followed.

For information not contained in this manual, or questions regarding system selection, application, or general assistance, please call the Dibiten technical office at (800) 922-5922 (U.S. & Canada) or at [www.jm.com/roofing](http://www.jm.com/roofing).

# Specification & Application Manual

## Modified Bitumen Roofing Membranes

---

### TABLE OF CONTENTS

<b>1.1</b>	<b>GENERAL DESCRIPTION</b> Technical Assistance Suitable Applications Acceptable Decks & Surfaces	<b>3.1</b>	<b>DIBITEN SINGLE PLY (POLY/4 OR POLY/5) FLASHING DETAILS</b> 3.1a Edge Detail 3.1b Curbs and Parapet Walls 3.1c Metal Coping 3.1d Pipes and Similar Protrusions 3.1e Roof Drains 3.1f Other Terminations and Transitions
<b>1.2</b>	<b>GENERAL DECK REQUIREMENTS</b> <b>Available Decks</b> Wood Decks Plywood Decks Poured Gypsum Decks <b>Non-available Deck Types</b> Structural Concrete Decks Precast or Prestressed Slabs	<b>3.2</b>	<b>DIBITEN SMOOTH SURFACED TWO PLY SPECIFICATION</b> 3.2a Edge Detail 3.2b Curbs and Parapet Walls 3.2c Metal Coping 3.2d Pipes and Similar Protrusions 3.2e Roof Drains
<b>1.3</b>	<b>DECK PREPARATION</b> Roof Drainage Expansion Joints Vapor Retarders Cant Strips Insulation Metal Work and Flashing	<b>4.1</b>	<b>DETAIL DRAWINGS FOR DIBITEN SINGLE PLY APPLICATIONS</b> 4.1a Edge Detail 4.1aa Edge Detail (Gutters) 4.1b Parapet End Wall 4.1bb Parapet Side Wall 4.1c Parapet and Inside Corners 4.1d Curbs and Outside Corners 4.1e Pipes and Similar Protrusions 4.1f Roof Drains 4.1g Shingle Roof Transition 4.1h Expansion Joints
<b>1.4</b>	<b>MODIFICATIONS &amp; DISCLAIMERS</b> Modifications Disclaimers	<b>4.2</b>	<b>DETAIL DRAWINGS FOR DIBITEN TWO PLY APPLICATIONS</b> 4.2a Edge Detail 4.2b Parapet End Wall 4.2bb Parapet Side Wall 4.2d Parapet and Inside Corners 4.2e Curbs and Outside Corners 4.2f Pipes & Similar Protrusions 4.2g Roof Drainage 4.2h Roof Relief Vent
<b>2.1</b>	<b>APPLICATION CONSIDERATIONS</b> Weather Conditions Material Storage and Handling Job Inspection • Safety Inspection • Application Inspection	<b>5.1</b>	<b>SAFETY</b> Personnel Contractors Fire Department Regulations Equipment Do's Equipment Don'ts Building Do's Building Don'ts
<b>2.2</b>	<b>APPLICATION REQUIREMENTS</b> Recommended Equipment Methods of Application • Fully Adhered • Roof Layout Base Sheet Requirements Stress Area Treatment		
<b>2.3</b>	<b>MEMBRANE APPLICATION</b> Dibiten Smooth Surfaced Poly/4 and Poly/5 Dibiten Granular (Slate) Surfaced Ballast Coating		
<b>2.4</b>	<b>REROOFING</b> Reroofing Preparation Reroofing Terminations Reroofing Membrane Split Repairs		

## **6.1 NEW ROOFS**

### **Dibiten Poly/4, Poly/5 Specifications**

#### **Nailable Decks**

- Specification 401 (No Insulation)
- Specification 402 (Insulation)
- Specification 401-2 (Two Ply, No Insulation)
- Specification 402-2 (Two Ply, Insulation)

#### **Non-nailable Decks**

- Specification 403 (No Insulation)
- Specification 404 (Insulation)
- Specification 403-2 (Two Ply, No Insulation)
- Specification 404-2 (Two Ply, Insulation)

### **Dibiten Poly/4.5 Granular Specifications**

#### **Nailable Decks**

- Specification 451, 451-FR (No Insulation)
- Specification 452, 452-FR (Insulation)
- Specification 451-2, 451-2 FR (Two Ply, No Insulation)
- Specification 452-2, 452-2 FR (Two Ply, Insulation)

#### **Non-nailable Decks**

- Specification 453, 453 FR (No Insulation)
- Specification 454, 454 FR (Insulation)
- Specification 453-2, 453-2 FR (Two Ply, No Insulation)
- Specification 454-2, 454-2 FR (Two Ply, Insulation)

## **6.2 REROOFING**

### **Poly/4, Poly/5, Poly 4.5 Granular, Dibiten FR Reroofing Specification**

#### **Smooth Surfaced Roofs**

- Specification R405 (Dibiten Poly/4, Poly/5)
- Specification R455, R455 FR (Dibiten Poly/4.5 Granular)
- Specification R405-2 (Two Ply, Dibiten Poly/4)
- Specification R455-2 (Two Ply, Poly/4, Poly/5 Poly/4.5)

#### **Gravel Surfaced Roofs**

- Specification R406 (Dibiten Poly/4, Poly/5)
- Specification R456 (Dibiten Poly/4.5 Granular)
- Specification R406-2 (Two Ply, Dibiten Poly/4, Poly/5)
- Specification R456-2, R456-2 FR (Two Ply, Poly/4 & Poly/4.5)

## **6.3 GENERAL WATERPROOFING**

- Specification for Roof Decks
- Specification for Shower Pan & Sub-flooring
- Specification for Planter Box or Roof Garden
- Specification for Concrete or Asphalt Base Sheet
- Specification for Below-Grade Waterproofing
- Specification for Between-Slab Waterproofing

## **6.4 U.L. LISTED SPECIFICATIONS**

General U.L. Information

## **7.1 GUARANTEES**

## **8.1 TECHNICAL DATA**

## **8.2 TEST DATA**

# Specification & Application Manual

## Modified Bitumen Roofing Membranes

### 1.1 GENERAL INFORMATION

#### Technical Assistance:

We encourage the user of this manual to contact our toll free number with any questions concerning product application or specification. The toll free number is: (800) 922-5922 (U.S. and Canada). In some cases technical assistance can be offered in the field, schedules permitting. Inquire about this service through the toll free number listed above.

#### Suitable Applications:

The *Application Considerations* Section 2.1 of this manual must be referenced for information concerning application guidelines for Dibiten Poly/4, Dibiten Poly/5 and Dibiten Poly/4.5 Granular modified bitumen membrane. Particular attention must be paid to the differences in the application requirements between smooth and granulated products; particularly, the flashing detail guidelines.

In all cases, Dibiten Poly/4 smooth surfaced membrane or Dibiflash (pre-cut Dibiten Poly/4 flashing membrane) must be used for all flashing details.

For ultimate roof life and performance Dibiten recommends consideration of its two ply systems. Specifications and details for the two ply systems, which carry Dibiten's 20 year term warranty, can be found in the *Specifications* Section 6.1 of this manual.

#### Acceptable Decks & Surfaces:

Roof deck and roof system selection are the responsibility of the architect, engineer and owner. The selection of the proper specifications for a particular substrate, the need for and suitability of vapor retarders, insulations, and other aspects of the deck and roof assembly, rest with the designer.

All roof decks must be applied in accordance with the deck manufacturer's specifications.

Decks must not pond water.

All roof decks must be smooth, free of moisture, free of dirt, properly attached, properly constructed, and designed for anticipated loads with minimum deflection.

No electrical conduit, bolts, or other similar equipment shall be placed on the surface of the roof deck; such surface irregularities cannot be properly insulated and roofed.

The deck manufacturer and the applicator are responsible for determining that the deck is suitable for receiving the Dibiten roof system.

### 1.2 GENERAL DECK REQUIREMENTS

#### Nailable Decks:

Whether or not insulation is specified, a base sheet, fastened in accordance with the manufacturer, U.L. 580 and F.M. 1-90 requirements, is required over all wood decks.

■ **Wood Decks.** Wood plank decks should be a minimum of 1" in thickness and of the tongue and groove type. Decks must be designed for anticipated loads with minimum deflection. Cracks or knotholes larger than 1/2" diameter must be covered with sheet metal if they are not covered with roof insulation. All butt joints or end joints of roof boards must be made on rafters. Wood plank decks must be smooth and free of moisture before installation of the roofing system commences.

■ **Plywood Decks.** Plywood used in deck construction must meet the current requirements of the American Plywood Association. The minimum thickness must be 1/2" on rafters not exceeding 24" on center. Plywood decks, as all deck types, must be free of moisture or dirt before roof work commences. All joints should be blocked with wood framing. Ply clips are not acceptable.

■ **Poured Gypsum Decks.** Poured gypsum decks must be constructed in accordance with the deck manufacturer's specifications and in accordance with practices recommended by the Gypsum Roof Deck Association. Form boards that allow the deck to dry from below must be used. The minimum thickness must be no less than 2" and wire mesh reinforcement is required. A base ply must be secured to the deck using fasteners approved by the Gypsum Roof Deck Association.

■ **Lightweight Insulating Concrete Decks.** A lightweight deck is acceptable to receive Dibiten roofing products only under the following conditions:

Proper venting which allows the deck to dry from below must be used. Topside venting is also required at the rate of one roof relief vent per every 1000 square feet of roof area.

The minimum thickness of the deck must be no less than 2". The minimum compressive strength of the deck must be in accordance with the lightweight insulating concrete deck manufacturer's specifications.

A venting type base sheet is required as an overlay over all lightweight insulating concrete decks. It must be installed with fasteners approved for use with this deck.



The deck must be completely dry.

**NOTE: Dibiten will not be responsible for leaks resulting from splits in the roof membrane which are caused by cracking of the gypsum or light-weight insulating concrete deck, regardless of the causes of the deck cracking.**

**Non-Nailable Deck Types:**

- **Steel Decks.** Steel deck must be 22 gauge at a minimum and have a shop coat of priming paint. Galvanized steel is recommended.

Steel deck units should be welded or, preferably mechanically fastened to the structural frame with a minimum of weld holes. Side laps should be fastened with sheet metal screws on not over 3'-0" centers.

- **Structural Concrete Decks.** Concrete decks require priming with a suitable primer at the rate recommended by the manufacturer. Concrete decks must be completely dry before priming and primer must be allowed to dry thoroughly before beginning application of the Dibiten membrane.

- **Precast or Prestressed Slabs.** Precast or prestressed slabs must be smooth, firm, thoroughly dry, and free from dust or the effects of freezing. All slabs shall be anchored against uplift and lateral movement to the supporting framework. Bearing shall be even and full and units laid tight. Joints shall be grouted and struck smooth. Deformed slabs shall be metal banded and provision shall be made for nailing the roofing to treated wood nailing strips at all gables, ridges and eaves. Before receiving any Dibiten roof membrane, the deck must be primed keeping the primer back 4" from joints in the deck.

**Dibiten will not be responsible for damage to the roof membrane which occurs due to moisture retention in the deck. All roof decks must be smooth, dry, clean, and properly designed. Responsibility for roof design rests with the architect, engineer and owner. All decks must be applied in accordance with the deck manufacturer's specifications.**

**1.3 DECK PREPARATION**

**Roof Drainage:**

All decks must have positive drainage incorporating interior drains and/or gutters. The Asphalt Roofing Manufacturer's Association recommends a minimum slope of 1/4" per foot. Interior drains should be recessed below the level of the finished Dibiten roof membrane to allow positive drainage of all water. Roof drains shall be

in sufficient number and size to permit satisfactory and rapid drainage of the roof surface. Condensation of air conditioning or other process liquids should not be allowed to discharge directly onto the roof membrane.

**Expansion Joints:**

- Expansion joints should be designed into structures to prevent roofing membrane from being damaged by stress caused by expansion and contraction of structural components. The responsibility for placement of the expansion joints rests with the designer or architect. In general, expansion joints should be provided under the following conditions:

Every 200 to 300 lineal feet of roof deck.

Where steel framing, structural steel, or decking change direction.

Where separate wings of "U", "L", "T" or other configurations exist.

Where the deck type changes, such as where a steel deck and a precast concrete deck abut.

Throughout the roofing system wherever control, expansion, or contraction joints are provided in the structural steel, deck material, or deck system.

Whenever "additions" are connected to existing buildings.

At junctions of exposed canopies, overhangs or loading docks to accommodate movement caused by varying ambient temperatures.

Wherever re-entry corners occur.

To be effective, expansion joints must be continuous along the break in the structure. They must not be terminated short of the edge of the roof deck. Insulation or roofing membrane should never bridge expansion joints. Construction "ties" must be removed for expansion joints to function properly. Expansion joints should be elevated at least 4" above the roof surface and should not be located in the valleys. Area dividers or control joints should not be substituted for or considered expansion joints.

**Vapor Retarders**

The architect or engineer is responsible for determining the need for providing a vapor retarder. The decision should consider the following:

- Climactic Conditions
- Building Use
- Deck Type

**Note: Dibiten assumes no liability for the use of, or**

# Specification & Application Manual

## Modified Bitumen Roofing Membranes

---

**absence of, a vapor retarder in conjunction with its roofing systems.**

### **Cant Strips:**

Cant strips are not required in Dibiten roofing systems. However, if cant strips are specified they must be completely covered with an appropriate base sheet. (See also *Safety*, Section 5.1.)

### **Insulation:**

Generally, use of insulation is not required in Dibiten specifications. The need for, and suitability of, insulation in a Dibiten roof system, must be determined by the architect, building owner, and roofing contractor. The following guidelines should be observed:

Most rigid board or panel type insulations which provide a firm surface are acceptable. All insulations are to be fastened in accordance with manufacturer, U.L. 580, F.M. 1-90 requirements. Dibiten recommends mechanical fastening of the insulation, where possible.

A fiber glass base sheet, 25 lbs. per 100 square feet, or heavier, is required over all insulations, except JM DuraBoard. If JM DuraBoard insulation is utilized by itself or as the top layer of a multilayer insulation system, Dibiten smooth or granulated products may be heat welded directly to the DuraBoard.

Insulation may be mechanically attached to metal, gypsum, cementitious wood fiber or structural concrete decks. Insulation may be adhered with an appropriate cold adhesive to structural concrete, cementitious wood fiber and pre-cast concrete decks.

A Dibiten roof system may not be installed over polystyrene roof insulation unless it is sandwiched between two layers of minimum 1/2" thick perlite. Joint taping is required in accordance with the insulation manufacturer's instructions.

### **Metal Work and Flashing:**

The metal work incorporated in an approved Dibiten roof system, as with all components of the roof system not manufactured by Dibiten, is not covered under Dibiten guarantees. It is recommended that all metal work be installed in accordance with the practices outlined in the "*Architectural Sheet Metal Manual*" published by SMACNA, or the "*Roofing & Waterproofing Manual*" published by the National Roofing Contractors Association.

Metal base flashing shall not be used as part of the roof membrane flashing system.

All protrusions shall be at least 2' (two feet) from curbs, walls

and edges to provide adequate space for proper sealing.

All sheet metal and Dibiten flashing assemblies must be securely attached. Flashing should be adhered to walls, curbs, and nailers that are fastened to the deck or deck structural system. This minimizes shear and tensile uplift and thermal contraction forces which might rupture the roof system. Suitable wood nailers (when required) should be provided and anchored at all roof edges and openings to permit the roofing to be adhered with maximum resistance to wind uplift and thermal contraction forces.

New metal flashing such as metal edging must have the oil film removed before the application of the Dibiten membrane. Sandpaper must be used to roughen the surface of the metal and the metal can be slightly heated with the heat weld to remove oil residue. Minimum requirements: 26 gauge - 4" on roof deck. Priming with ASTM D41 asphalt primer is recommended.

Flashing and construction details are generally subjected to the worst possible conditions on the roof. Incorrect flashing and construction detail design may result in damage to the roof system and building interior and contents. Proper flashing and detail design are critical to the success of any roof system.

**NOTE: Dibiten strictly prohibits the use of any asphalt based cement products with its membrane, except JM MBR Utility Cement.**

## **1.4 MODIFICATIONS & DISCLAIMERS**

### **Modifications:**

Any changes in or variance of the roofing system specifications or application requirements as published by Dibiten must be approved in writing by Dibiten prior to application of the Dibiten products.

### **Disclaimers:**

The selection of the correct roofing system requires the evaluation of many factors: roof incline, roof deck type and condition, climactic conditions, building use and maintenance traffic are among the considerations. Before selecting a particular roofing specification, all factors should be studied.

The information and specifications contained in this manual relating to the application of Dibiten roofing systems are based on years of experience in industrial roofing and waterproofing fields. The specifications and details are designed to meet actual situations and are provided to assist architects, specification writers, engineers and owners solely for guidance purposes. These





guidelines should not be considered all-inclusive nor shall they be considered as a substitute for good roofing application practices.

Dibiten, as a manufacturer, is not involved in the design or construction of buildings or structures; therefore, technical specifications as shown within this booklet are intended to be used as general guidelines only.

The design, specifications and construction of buildings or structures are the responsibility of the owner or designer.

Dibiten does not in any way claim to be architects, engineers or designers, but only a manufacturer of roofing products. The company does not accept responsibility for the adequacy of building design on either new or existing structures, under any circumstances.

Similarly, Dibiten will not be responsible for the performance of its products when they are impaired or damaged in any way by design or construction faults, inclusions, omissions, acts of God, or any other cause not related to manufacturing defect.

Dibiten will not be responsible for damage to the roof membrane, which occurs due to moisture retention in the deck.

All roof decks must be smooth, dry, clean, and properly designed. Responsibility for roof design rests with the architect, engineer, and owner. All decks must be applied in accordance with the deck manufacturer's instructions.

## 2.1 APPLICATION CONSIDERATIONS

### Weather Conditions:

Dibiten roof systems, like all roof systems, cannot be applied successfully if moisture conditions exist. Do not attempt application if ice, snow, or moisture are present on the surface to be roofed. This will prevent the possibility of trapping moisture in the roof system.

Dibiten roof systems, like all roof systems, cannot be applied successfully if moisture conditions exist. Do not attempt application if ice, snow, or moisture are present on the surface to be roofed. This will prevent the possibility of trapping moisture in the roof system.

Where very cold weather is a consideration, Dibiten membrane can be successfully installed at temperatures of approx. 40° F and rising. In cold weather conditions, the following should be observed:

Rolls should be kept in a heated area prior to installation.

### Material Storage & Handling:

Care must be taken in the storage and handling of modified bitumen roofing membrane. Rolls must be stored upright, on pallets, and indoors above ground. Rolls must not be stored on their sides. The membrane must be pro-

tected from exposure to sunshine and moisture and, as stated above, must be stored in a heated area (above 40° F) before application in cold weather. Caution must be used in the handling and loading of the rolls to avoid damage to the membrane.

### Job Inspection:

■ **Safety Inspection.** Dibiten modified bitumen roofing membranes are intended to be installed only by licensed, thoroughly qualified roofing contractors and their trained crews. These same professionals must be completely knowledgeable not only in all aspects of roofing, but specifically in the use and operation of roofing heat welding and propane equipment. It is the roofing contractor's sole responsibility to exercise extreme caution and proper safety in the use of heat welding equipment. Dibiten assumes no liability for failure of the roofing contractor or the contractor's personnel to properly or safely install a Dibiten roof system. Reference must be made to the *Safety Guidelines*, Section 5.1 of this manual.

**Note: Along with the safe use of heat welding equipment, job inspection must be a part of the modified bitumen roof installation. In addition to the constant visual inspection during the application process, a responsible, knowledgeable crew person must be left on the job site for a minimum of one hour after cessation of heat welding (each day) to watch for smoke, flame or smoldering insulation. Safety inspection should include both the roof and attic.**

■ **Application Inspection.** Laps and flashing details are the most critical areas of the roof installation. All laps in a Dibiten roof installation can and should be checked using a heated trowel as follows:

Preheat the trowel.

Use the hot trowel to check under the laps for any unbonded areas.

Slide the preheated trowel under the unbonded lap, lift the unbonded lap and re-heat weld. If the lap cannot be lifted enough to achieve a sufficient seal, apply a strip of Dibiten (minimum six inches in width) over the lap area.

On completion of the job, always inspect the work and confirm the following:

All flashing seamed tightly.

Stacks, vents and other protrusions properly and securely flashed. (Refer to Section 3.1, *Flashing Detail Instructions*, of this manual.)

Minimum of two plies at all flashings.

# Specification & Application Manual

## Modified Bitumen Roofing Membranes

### 2.2 APPLICATION REQUIREMENTS

#### Recommended Equipment:

The following equipment is recommended for the installation of Dibiten modified bitumen:

Rounded Nose Trowel (4" wide x 6" long)  
Roofer's Hooked Blade Knife  
Gloves  
Propane (LP gas tank with regulator and gauge)  
Fire Extinguisher (minimum 20 lb. ABC type)

#### Heat Welding kit including:

Medium Length Heat Weld (9") for detail work  
Long Heat Weld (16") for field work  
Electronic Starter  
Steel Safety Stand  
33' of Rubber Hose, U.L. listed  
Regulator, U.L. listed

Follow the respective equipment manufacturer's instructions carefully regarding the proper and safe use, handling and storage of heat welding equipment.

#### Remember to:

Read the safety section of this manual. Check all fittings for leak bubbles with a liquid soap solution before each use.

Keep equipment clean.

The heat welding flame can be difficult to see in sunlight. Use extreme caution.

When heat welding, work with the heat welder a distance not less than 12" away from the middle of the Dibiten membrane. The hottest zone is normally in the center of the flame.

#### Methods of Application:

Dibiten modified bitumen membranes must be applied using the heat welding method with suitable roof heat welding equipment. **The use of hot asphalt, glues, solvents, or asphalt based cement products with Dibiten modified bitumen membranes, is strictly prohibited.**

- **Fully Adhered.** The entire underside of the membrane is fully adhered to the underlying surface using the heat welding method of application.
- **Roof Layout.** The surface that the Dibiten membrane is to be applied over must be in accordance with the manufacturer and industry standards. Any surface defect must be corrected before the membrane is installed.

The surface to be roofed must be clean, smooth, dry and completely clean of dust, debris, or foreign matter.

As in the proper installation of any built-up roofing system, application of Dibiten membrane must begin in the valleys or low point of the roof and work uphill to avoid backwater laps. On slopes at or above 2/12 pitch, material should be installed with the side laps running parallel to the direction of the roof slope to eliminate the possibility of slippage. No installation shall have laps that cause "bucking water."

On smaller roofs, end laps may be aligned or staggered. A 12" wide strip of Dibiten membrane must be applied over the end laps, if aligned. End laps must be aligned if roof dimensions exceed 100 lineal feet in any one direction.

#### Base Sheet Requirements:

A suitable base sheet, properly fastened in accordance with U.L. 580, F.M. 1-90 and manufacturer requirements is required over all combustible type decks and over all insulations or recovery boards, except JM DuraBoard. Cant strip should be installed to bridge gaps between the roof deck and parapet wall which exceed 1/4".

#### Stress Area Treatment:

Special treatment is required to assure that leaks do not occur in stress areas. A stress area is where movement may occur in the substrate. Stress areas can be found at control joints where a lower roof joins the wall of a higher building section, where additions to buildings occur, at places where the roof slope changes, or where a flat roof joins a steeper section. For example; in reroofing, the stress areas may be evident as splits, buckles, or blisters.

Stress areas need to be identified and treated prior to application of the Dibiten membrane. Once identified, treat the stress areas using a strip of Dibiten (usually 1/3 to 1/2 the width of a roll of membrane) applied over the stress area. The strip is left loose in the center, but sealed at the perimeters in a 3" to 4" width. At walls or curbs, the unheated center of the membrane strip is centered over the joint where deck and parapet meet (over the cant strip, if required) and strips of membrane no longer than 4' to 5' are used. When the main roof and parapet wall counterflashing are applied over this stress treatment, the area will be more able to withstand structural movement and still be secure.

Where the deck changes direction or where there is a change in the material used for the deck or the slope of the deck changes, a strip of Dibiten not less than 1/3 the roll width is used. Again, the edges are heat welded and sealed and the middle portion of the strip is left loose.



The main roof will be fully adhered over this but the stress strip will assist in accommodating structural movement.



**Example 1.** For roofs in excess of 100 lineal feet in any direction

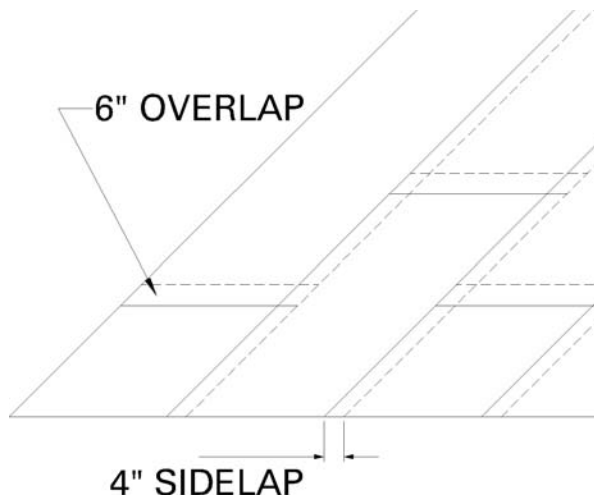

**Example 2.** Staggering is acceptable for smaller roofs, less than 100 lineal feet in any direction

## 2.3 MEMBRANE APPLICATION

### Dibiten Smooth Surfaced Poly 4 and Poly 5:

Dibiten recommends the following application procedures for its membrane:

**Note:** The application requirements are the same for both Dibiten Poly 4/ and Dibiten Poly 5/ smooth surfaced modified bitumen membrane.

1. Unroll the Dibiten membrane fully. Remove the product label tape. Note that the side covered with a very thin polyethylene film is the side of the membrane to be heat welded. The lightly talcked or sanded side faces up.
2. Position, unroll and align the roll.
3. Working from one end, reroll the roll halfway to the center.
4. Standing on the unrolled portion to prevent shifting, begin the heat welding procedure on the coiled portion of the roll.
5. Pass the heat weld flame across the roll slowly from side to side until the membrane develops an even sheen. As you heat weld, walk slowly forward, pushing the roll with your foot as you go, and adhering the heat welded portion to the underlying surface.
6. All the polyethylene must be completely burned away. Additionally, be sure to produce a 1/2" outward flow of melted bitumen at the overlapped seams. This flow, when properly troweled, is the key to a good seal and watertight integrity.
7. Having completed the installation of the first half of the roll, reroll the other half back to the center and pull back to a little beyond the point where the heat weld- procedure was begun. This will eliminate the possibility of voids. Repeat the heat welding procedure. As you install the second roll and all subsequent rolls, be sure to achieve the required 4" side laps and 6" end laps as the membrane is overlapped.
8. Once the second roll is fully installed, immediately use the heat weld flame and heated trowel to completely seal the side and end laps. To accommodate lap troweling, heat the seam area and trowel simultaneously. Use the preheated trowel to smooth the melted compound at the seam, working outward to eliminate the possibility of voids or trapped air. Use the flat part of the trowel across the full width of the lap to assure a complete seal.

Seam troweling is a requirement and will assure the longevity of the Dibiten roof installation.

# Specification & Application Manual

## Modified Bitumen Roofing Membranes

---

9. Check the length and width of all laps to verify that a complete seal has been achieved. Where there is doubt, check the seam with a warm trowel and reseal if necessary. Do not attempt to seal a loose lap by heating the top surface of the membrane only; lift the lap with the warm trowel and re-heat weld, then trowel as described above.

See Section 3.1, *Flashing Details for Dibiten Smooth Surfaced Membrane*, for more application details.

### **Dibiten Granular (Slate) Surfaced:**

The heat welding application method for Dibiten Poly/4.5 Granular membrane is essentially the same as described above for smooth surfaced membrane. However, some very significant differences exist. Of important note are the following:

1. Care must be taken not to scorch granules during application.
2. Care must also be used not to track melted bitumen. It is advisable to walk beside the granular sheet rather than standing on it as you heat weld.
3. Smooth side laps are provided on the Dibiten Poly/4.5 Granular membrane. The laps are a very critical area of the roof and since you cannot trowel the laps when using Dibiten Poly/4.5 Granular membrane, you must be 100% certain of a complete bond through the heat welding procedure. Be certain to achieve a minimum 1/4" flow of melted bitumen from the overlapped seam and allow at least 1/4" extra lap width at the side laps so that the smooth side lap provided is completely sealed and still aesthetically neat. Loose slate granules are provided to dress the bitumen at the seam area while still warm.
4. End laps, like any area where you are overlapping membrane over granulated surface, require the following preparation in order to accomplish a water-tight seal:

Use the heat weld and trowel to scorch the granules of the membrane you are overlapping onto. Bring the bitumen to the surface and smooth the area with the warm trowel. This prepares the membrane to receive the overlap.

5. Do not overlap onto granular membrane without following the above procedure.

In a Dibiten Poly/4.5 Granular roof installation, this procedure will be needed at all end laps, certain flashing details, and anywhere membrane is overlapped onto the granular surface.

Flashing details are quite different for Dibiten Poly/4.5 Granular installations. All flashing details must be accomplished using smooth surfaced Dibiten membrane (Dibiten Poly/4), and these are generally performed

before the application of the granular membrane.

See *Flashing Details* for Dibiten Poly/4.5 Granular, Section 3.1 of this manual, for more information.

### **Ballast:**

Ballast may be applied to a finished Dibiten membrane, but it is not recommended as it inhibits the normal ease with which the membrane is inspected and maintained. If ballast is used, it must be smooth, river bottom stone applied in cold, wet emulsion. Generally, a minimum of 400 lbs. of stone per 100 square feet of roof area is recommended.

### **Coating:**

Dibiten recommends coating all non-granulated finished membranes. This is a requirement if the roof membrane is to be guaranteed. Use a solvent, acrylic or latex based coating compatible with modified bitumen systems. Application rates vary by manufacturer but should never be installed less than 1 gallon per 100 square feet. Coatings will enhance the life of the roof membrane but need to be maintained. Periodic recoating may be necessary. Recoating is the responsibility of the building owner.

## Modified Bitumen Roofing Membranes

### 2.4 REROOFING

Reroofing requires special considerations, primarily involving evaluation of the condition of the existing roof(s) and preparation.

It is the sole responsibility of the building owner and contractor to determine if the existing roof, any insulation present, and the deck are sound and undamaged. If the deck is in need of repair, this repair must be completed before the new roof application is started. Often the need for reroofing is addressed only after the existing roof has failed. A complete evaluation should be made, including: examination of core samples to determine why the existing roof failed and to evaluate the suitability of reroofing over the existing roof. It must be determined that there is not trapped moisture within the system which can damage the new roof system.

If, through the core sample or a moisture device, it is determined that the existing insulation is wet or damaged. This insulation must be replaced before the new roof membrane is applied.

In reroofing, as in new construction roofing, local code requirements must be considered. Even if the existing roof, insulation, and deck are in excellent condition, many areas restrict the number of "roofs" which a building may have applied. Additionally, it is the roofing contractor's and building owner's sole responsibility to calculate the weight of the new Dibiten roof system and to determine whether or not the structure can easily accommodate the added weight.

Further, the Dibiten warranty will not cover any damage or failure of its roofing membrane to perform properly, when installed over an unsuitable existing roof or substrate. Attempts to install a new roof over a moisture soaked or otherwise unsuitable existing roof can result in damage to the new roof system and lead to the premature failure of the system.

Once the determination has been made that the existing roof is suitable to recover, the following preparation procedures must be followed prior to the application of the Dibiten membrane.

#### Reroofing Preparation

If the existing roof is covered with gravel, the gravel must be removed. Any blisters or buckles should be cut and repaired using a strip of smooth surfaced Dibiten membrane. Because a certain amount of gravel is permanently embedded and cannot be removed, a minimum 1/2" thick recover board, insulation, or plywood must be installed (fastened in accordance with the manufacturer's instructions and U.L. 580 and F.M 1-90 wind uplift requirements) over the existing roof. An appropriate base sheet is required over the existing roof or insulation, if the insulation is not JM DuraBoard. Dibiten membrane may be installed directly to JM DuraBoard.

When reroofing over "smooth surfaced" or mineral surfaced cap sheet roofs, an appropriate base sheet, mechanically fastened, is recommended to assure adhesion. The base sheet is also recommended as a divorcement layer between the existing roof and the Dibiten membrane.

Any blisters or buckles must be repaired before the new roof is applied. The blisters or buckles must be cut and nailed, and a strip of Dibiten membrane heat welded over the area.

In reroofing, expansion joints should be positioned as for new construction unless conditions of the existing roof indicate that additional expansion joints are necessary.

If a "ponding" (inadequate drainage) problem exists on the roof, it should be corrected through the installation of additional drains or tapered insulation.

#### Reroofing Terminations:

Once the preparation work is completed, application guidelines for reroofing are the same as for new roofing work. Terminations must be properly counterflashed using Dibiten smooth surfaced membrane and appropriate metal.

At the shingle roof transition, the Dibiten membrane must extend fully up under a minimum of the first three courses of shingles.

#### Roof Membrane Split Repairs:

Repairs of splits in existing roof membrane must be made before the reroofing process begins, as with blisters or buckles described in *Reroofing Preparation*. In the case of a split, a minimum 9" wide strip of Dibiten smooth surfaced membrane is loose laid over the split; over this a minimum 19 1/2" (half roll width) strip of Dibiten Poly/4 is heat welded applied, fully adhered, over the split area.

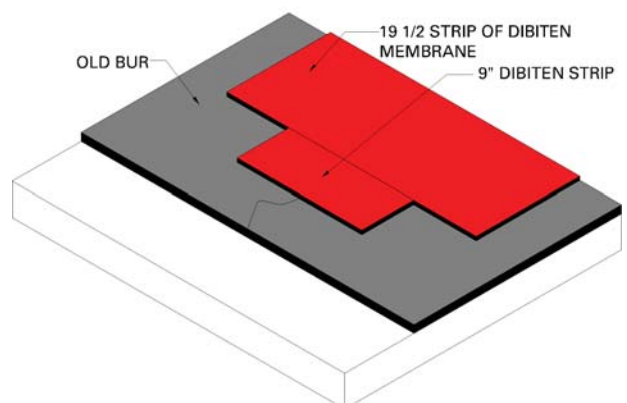

# Specification & Application Manual

## Modified Bitumen Roofing Membranes

---

### INTRODUCTION

As stated elsewhere in this manual, flashing details are considered the most critical areas of the roof and require the most attention to detail. All flashing details in Dibiten roof installations are to be accomplished using Dibiten smooth surfaced membrane.

**Note: Plastic roofing cement should never be used with Dibiten membrane.**

**Remember these general rules:**

**WHEN APPLYING MEMBRANE OVER MEMBRANE, ALWAYS HEAT BOTH SURFACES TO ASSURE A TOTAL BOND.**

**FLASHING DETAIL SIDE LAPS MUST BE STAGGERED FROM THE ROOF FIELD SIDE LAPS.**

Dibiten membrane is intended to be applied by licensed roofing contractors and their crew, thoroughly skilled in all aspects of roofing workmanship and safety, and the use and handling of propane equipment.

### 3.1 DIBITEN SINGLE PLY FLASHING DETAILS

#### 3.1a Edge Detail

Install a 9" strip of Dibiflash along the edge of the wall with at least 2" extending down the outer face of the wall. Prepare the metal edge by lightly sanding and heating the minimum 4" flange with a heat welder. The flange should then be primed. Secure the flange over the Dibiflash with appropriate nails staggered 3" o.c. Install a minimum 11" wide strip of Dibiflash over the top of the metal flange holding the strip back from the outside edge of the metal 1/4" to 1/2" to allow room for troweling. Weld and trowel this strip securely. The field membrane ply is then installed.

#### 3.1b Curbs and Parapet Walls

At the curb or parapet base, install an 8-12" strip of Dibiflash applied equally up the curb and out on the substrate. The field membrane is butted to the base of the curb. Install the counterflashing membrane up and over the top of the curb and back onto the deck at least 4". At the top and bottom of inside and outside corners, on top of the first counterflashing, install a small piece of smooth membrane to reinforce the corners. If the field membrane is granular surfaced, a 6" area around the base of the curb or parapet must be treated by "scorching" the surface to sink the granules and expose the modified bitumen so that a proper bond can be made between the counterflashing and field membrane.

#### 3.1c Metal Coping

Where a metal cap is used on parapet walls, be sure to extend the Dibiten smooth fully adhered up and over the top of the parapet wall before applying the metal coping. See Detail Drawing 4.1b.

#### 3.1d Pipes and Similar Protrusions

Install the field ply membrane and cut an X in the membrane to allow it to be installed over the pipe. Over the first field ply, install a 6" finger strip adhered at the base of the pipe. A 12" square piece of membrane is installed over the finger strip properly welded and troweled. If the field ply is granular surfaced, the area under the 12" membrane must be treated by "scorching" the surface to sink the granules and expose the modified bitumen so that a proper bond can be made between the 12" square piece of membrane and the field membrane.

#### 3.1e Roof Drains

Install a piece of smooth membrane on the substrate that extends 6" beyond the drain flange in all directions. If the field membrane is to be granular surfaced, install the drain flange and another piece of smooth membrane that extends 8" beyond the flange in all directions, on top of the flange. Install the membrane ply and trim the membrane to the outside of the drain clamping ring. In smooth surfaced membranes, install a smooth membrane on the substrate that extends 6" beyond the drain flange in all directions. Install the drain flange and the membrane so that all pieces extend fully under the drain clamping ring.

#### 3.1f Other Terminations and Transitions

When installing a Dibiten membrane adjacent to a shingle roof, remove the bottom three courses of shingles. Centered at the point of transition, install an 8-12" of smooth membrane. Install the Dibiten field membrane to the point of transition. Install another piece of membrane lapping over the field membrane 6" and up the slope of the shingle roof to the base of the remaining shingles. Replace the bottom 3 courses of shingles over the Dibiten membrane.

If metal cap of coping is not used on the top of a parapet, an appropriate metal counterflashing must protect the termination of the Dibiten membrane.

### **3.2 DIBITEN SMOOTH SURFACED TWO PLY SPECIFICATIONS**

#### **3.2a Edge Detail**

Install the first field ply membrane over the substrate and down the outside face of the building a minimum of 2". Prepare the metal edge by lightly sanding and heating the minimum 4" flange with a heat welder. The flange should then be primed. Secure the flange with appropriate nails staggered 3" o.c. Install a minimum 9" wide strip of Dibiflash over the top of the metal flange holding the strip back from the outside edge of the metal 1/4" to 1/2" to allow room for troweling. Weld and trowel this strip securely. The second field membrane ply is then installed. Refer to detail Drawing 4.2a.

#### **3.2b Curbs and Parapet Walls**

The flashing detail for curbs and parapet walls are the same. The first field membrane end laps should turn up the curb or parapet base a minimum of 4-6". Where the first field membrane runs parallel to the curb, an 8-12" strip of Dibiflash is first applied equally up the curb and out on the substrate. The first counterflashing membrane extends up and over the top of the curb and back onto the deck at least 4". At the top and bottom of inside and outside corners, on top of the first counterflashing, install a small piece of smooth membrane to reinforce the corners. The second field membrane end or side laps butt securely to the base of the curb. The second counterflashing membrane extends from up and over the top of the curb and back onto the roof deck over the second field ply a minimum of 6". If the second field membrane is granular surfaced, a 6" area around the base of the curb or parapet must be treated by "scorching" the surface to sink the granules and expose the modified bitumen so that a proper bond can be made between the counterflashing and field membrane.

#### **3.2c Metal Coping**

Metal cap goes over the two plies described above and as shown in Detail Drawings 4.2a and 4.2b.

#### **3.2d Pipes and Similar Protrusions**

Install the first field ply membrane and cut an X in the membrane to allow it to be installed over the pipe. Over the first field ply, install a 6" finger strip adhered at the base of the pipe. A 12" square piece of smooth membrane is installed over the finger strip properly welded and troweled. The second field ply is then installed. If a vent pipe collar is used, it is installed between the first field ply and the finger ply. See Detail Drawing 4.2f.

#### **3.2e Roof Drains**

Install a piece of smooth membrane on the substrate that extends 6" beyond the drain flange in all directions. If the field membrane is to be granular surfaced, install the drain flange and another piece of smooth membrane that extends 8" beyond the flange in all directions, on top of the flange. Install the membrane ply and trim the membrane to the outside of the drain clamping ring. In smooth surfaced membranes, install a smooth membrane on the substrate that extends 6" beyond the drain flange in all directions. Install the drain flange and the membrane so that all pieces extend fully under the drain clamping ring. See Detail Drawing 4.2g.



# Specification & Application Manual

## Modified Bitumen Roofing Membranes

### 4.1 DETAIL DRAWINGS SINGLE LAYER APPLICATIONS

#### Detail Drawing 4.1a

##### EDGE DETAIL

Dibiten, Single Layer Specifications

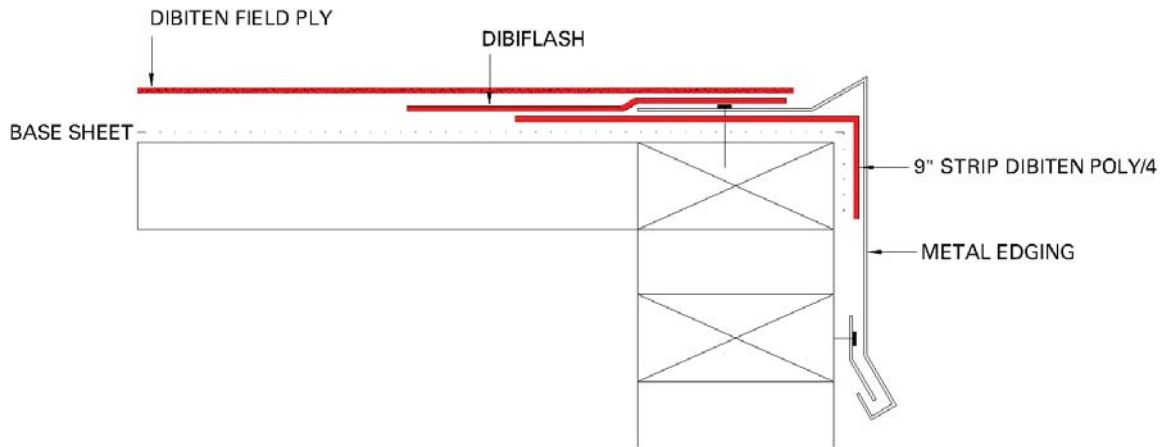

#### Detail Drawing 4.1aa

##### EDGE DETAIL, GUTTER DETAIL

Dibiten, Single Layer Specifications

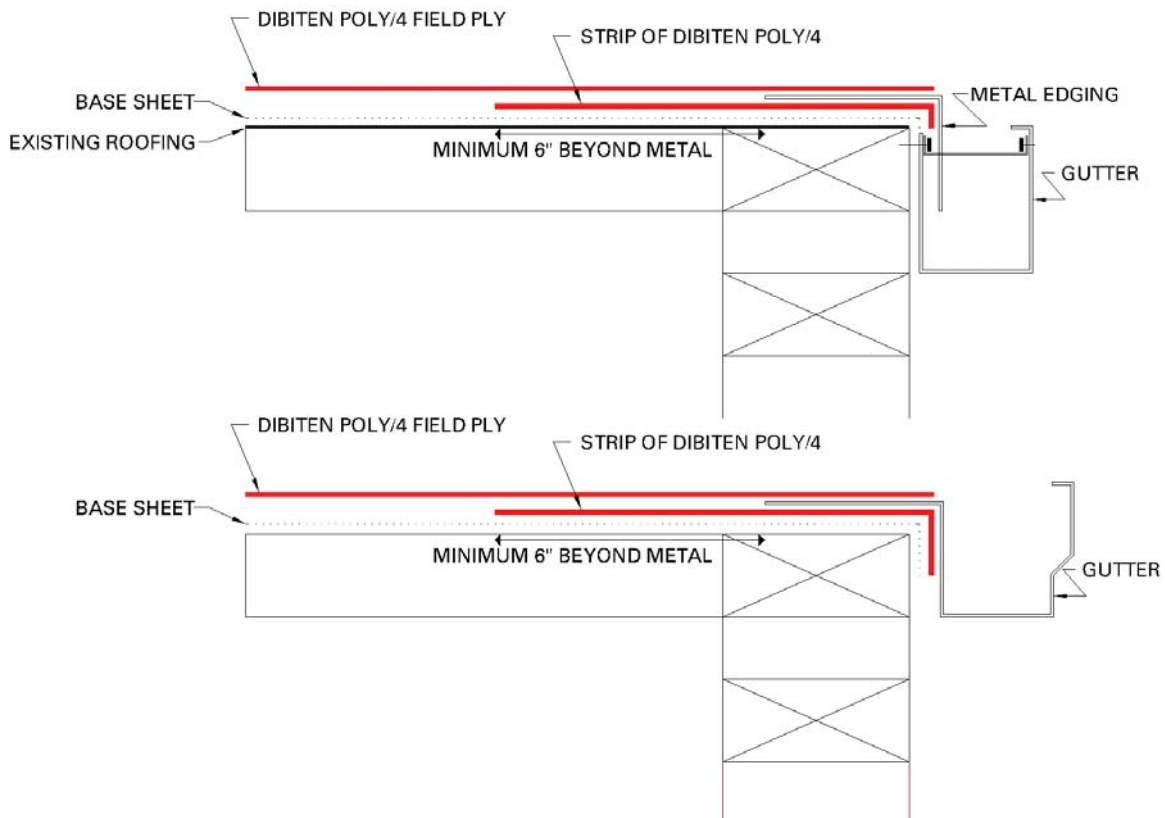

**Detail Drawing 4.1b**  
 PARAPET END WALL  
 Dibiten, Single Layer Specifications

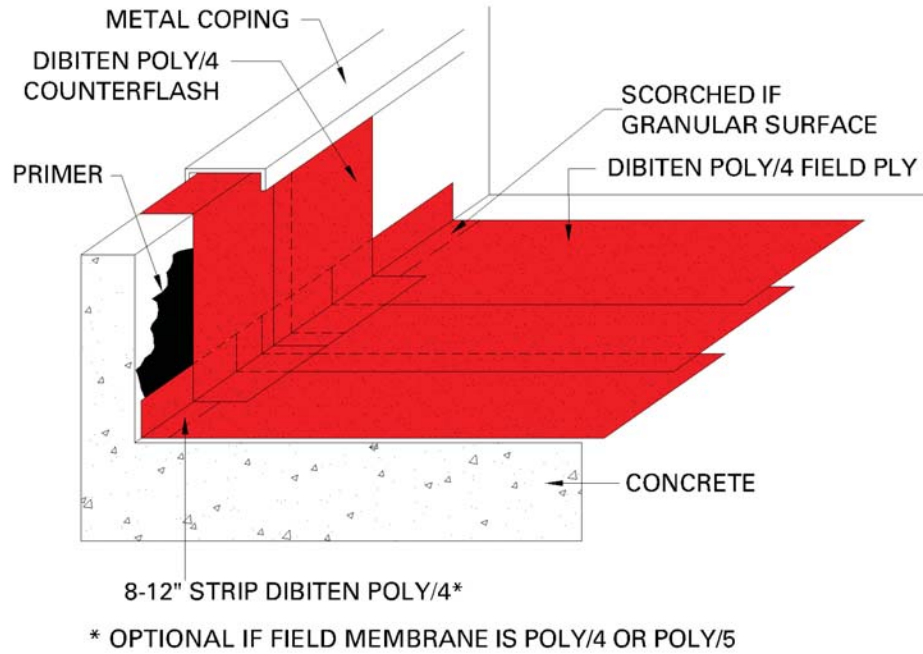

**Detail Drawing 4.1bb**  
 PARAPET SIDE WALL  
 Dibiten, Single Layer Specifications

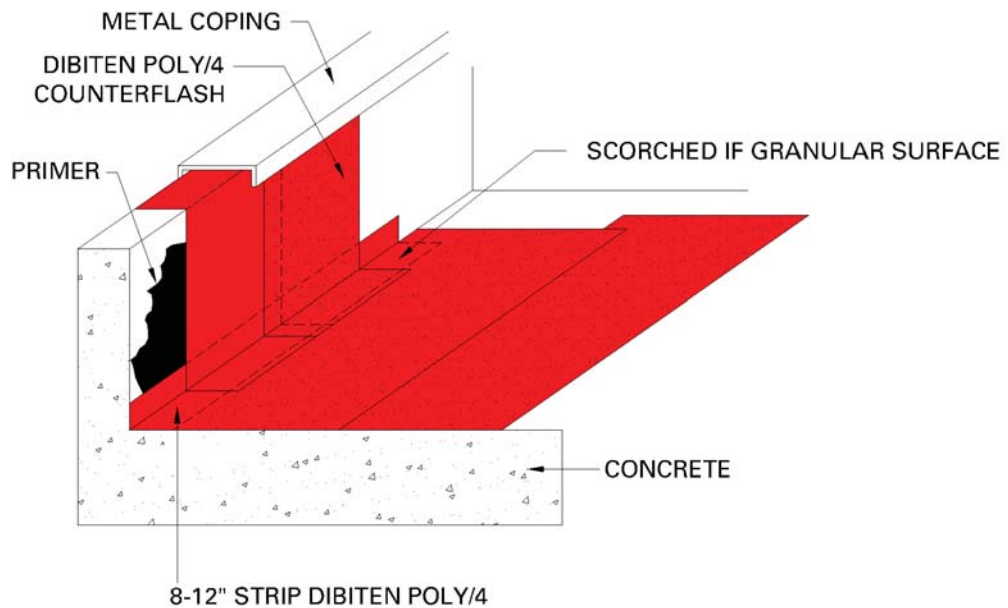

# Specification & Application Manual

## Modified Bitumen Roofing Membranes

### Detail Drawing 4.1c PARAPET and INSIDE CORNERS Dibiten, Single Layer Specifications

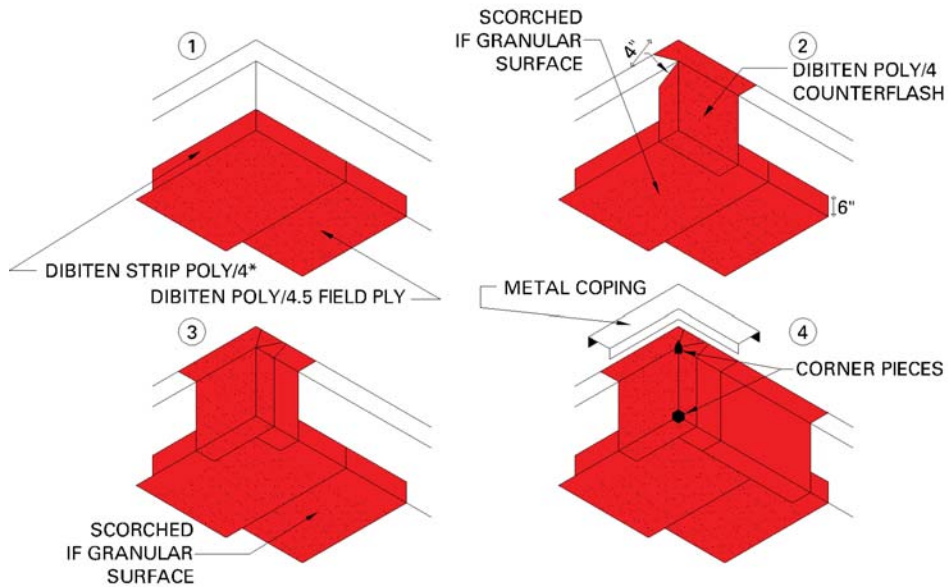

\*OPTIONAL IF FIELD MEMBRANE IS POLY/4 OR POLY/5

### Detail Drawing 4.1d CURBS and OUTSIDE CORNERS Dibiten, Single Layer Specifications

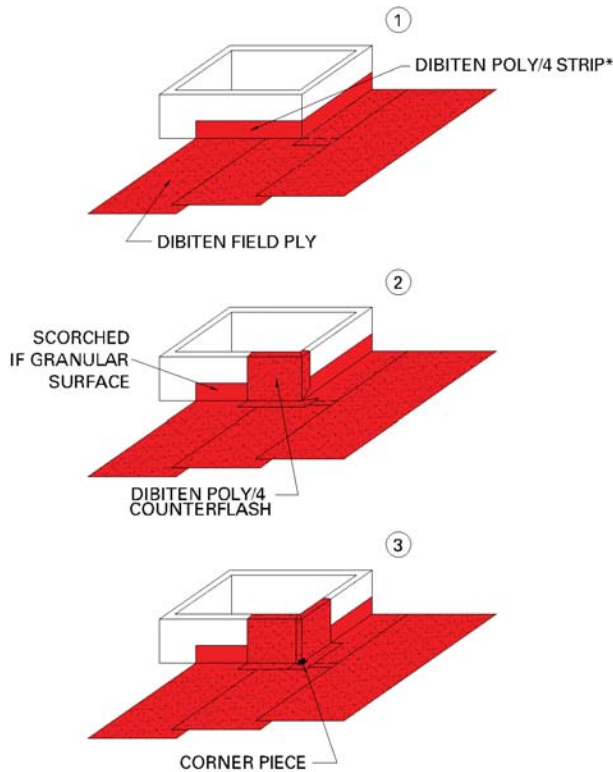

\* OPTIONAL IF FIELD MEMBRANE IS POLY/4 OR POLY/5

**Detail Drawing 4.1e**  
**PIPES and SIMILAR PROTRUSIONS**  
 Dibiten, Single Layer Specifications

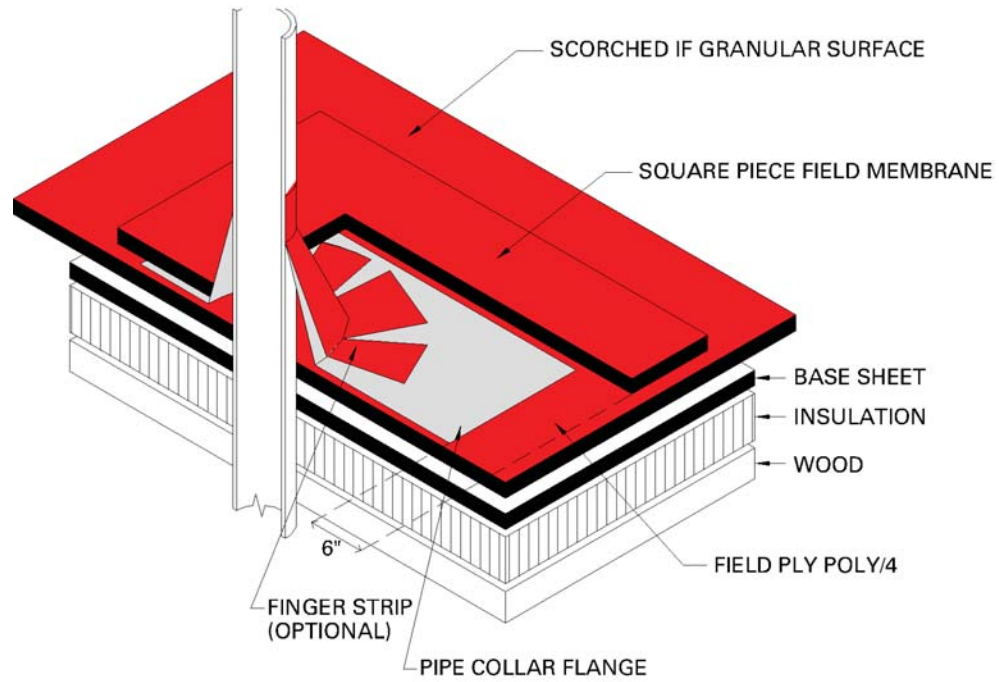

**Detail Drawing 4.1f**  
**ROOF DRAINS**  
 Dibiten, Single Layer Specifications

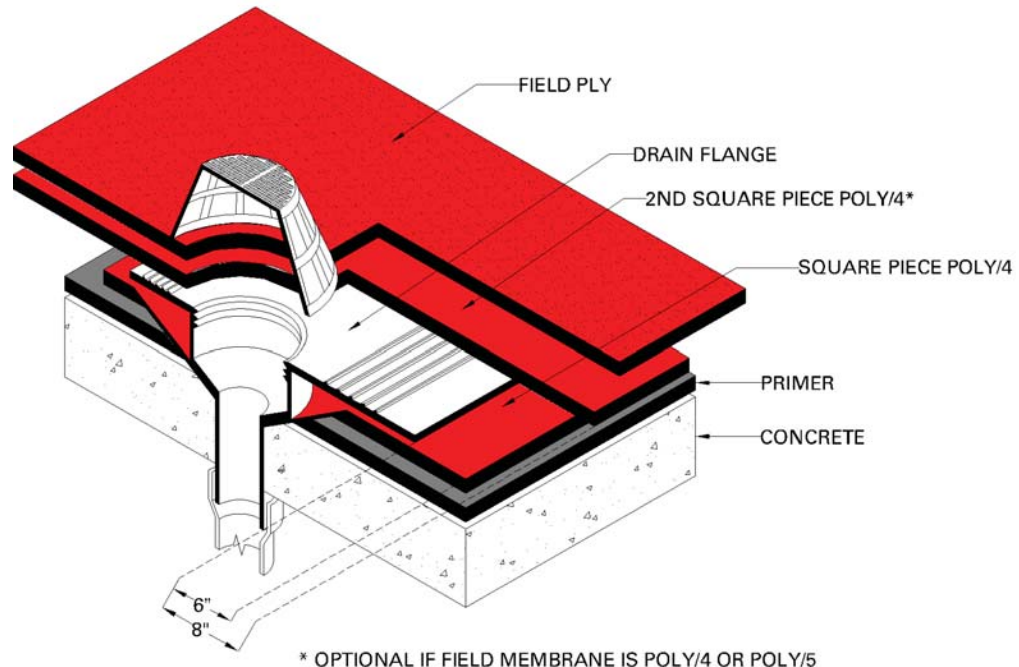

# Specification & Application Manual

## Modified Bitumen Roofing Membranes

**Detail Drawing 4.1g**  
SHINGLE ROOF TRANSITION  
Dibiten, Single Layer Specifications

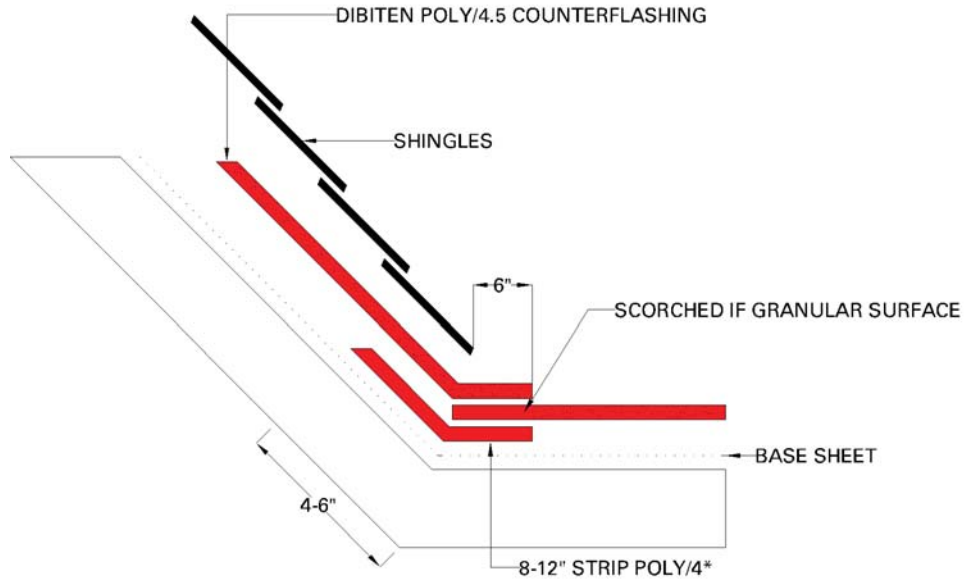

\* OPTIONAL IF FIELD MEMBRANE IS POLY/4 OR POLY/5

**Detail Drawing 4.1h**  
EXPANSION JOINT  
Dibiten, Single Layer Specifications

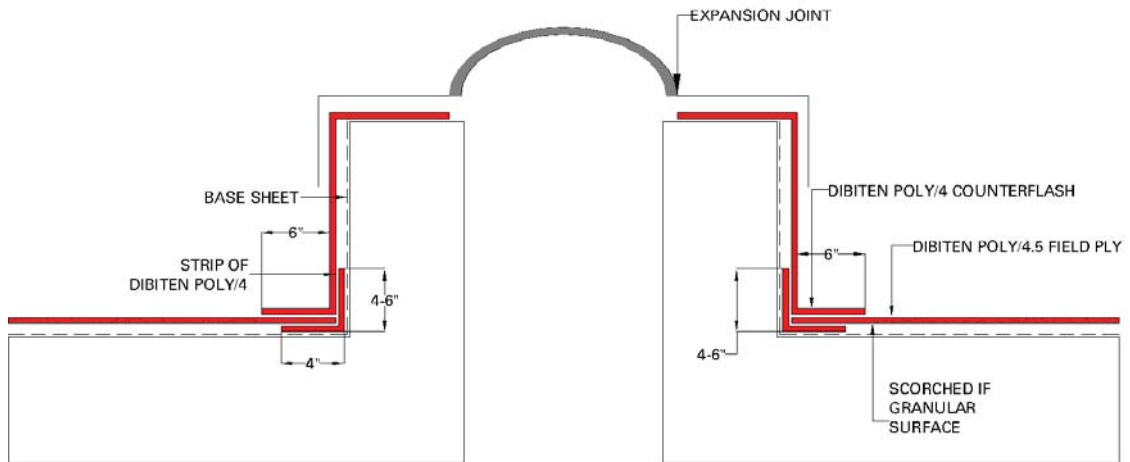



**4.2 DETAIL DRAWINGS FOR DIBITEN TWO PLY APPLICATIONS**

**Detail Drawing 4.2a**  
**EDGE DETAIL**  
 Dibiten, Two Ply Specifications

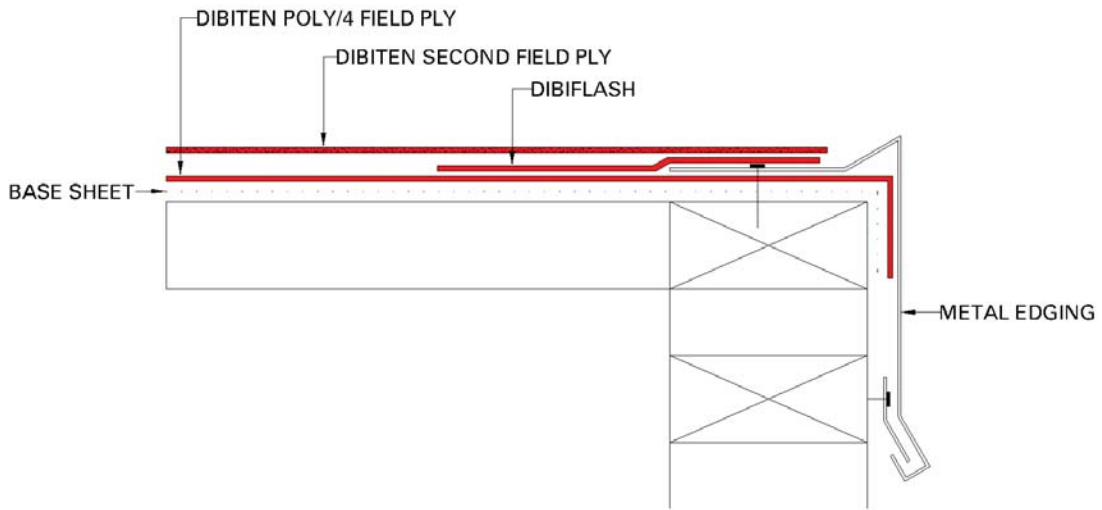

**Detail Drawing 4.2b**  
**PARAPET END WALL**  
 Dibiten, Two Ply Specifications

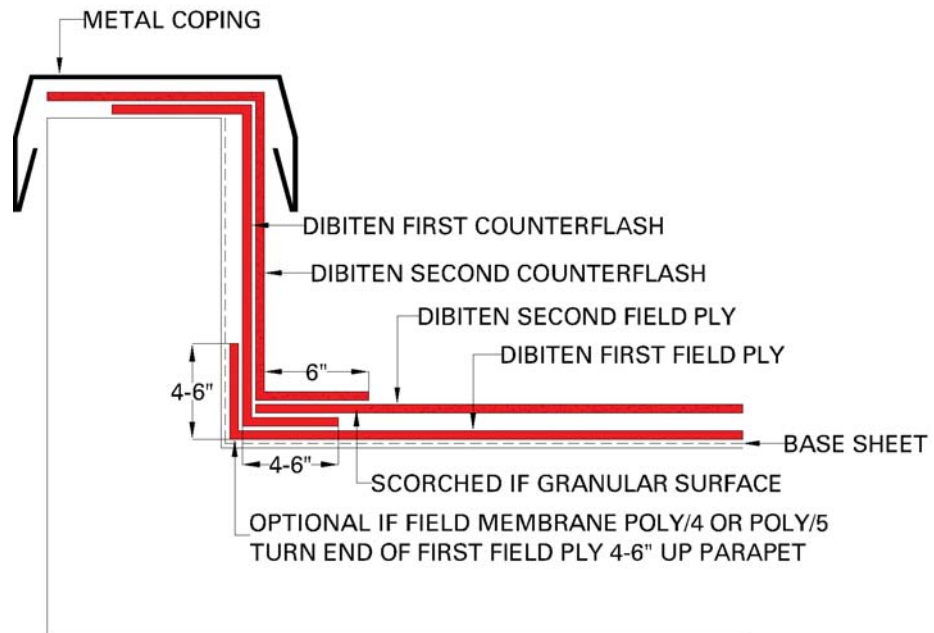

# Specification & Application Manual

## Modified Bitumen Roofing Membranes

**Detail Drawing 4.2bb**  
PARAPET SIDE WALL  
Dibiten, Two Ply Specifications

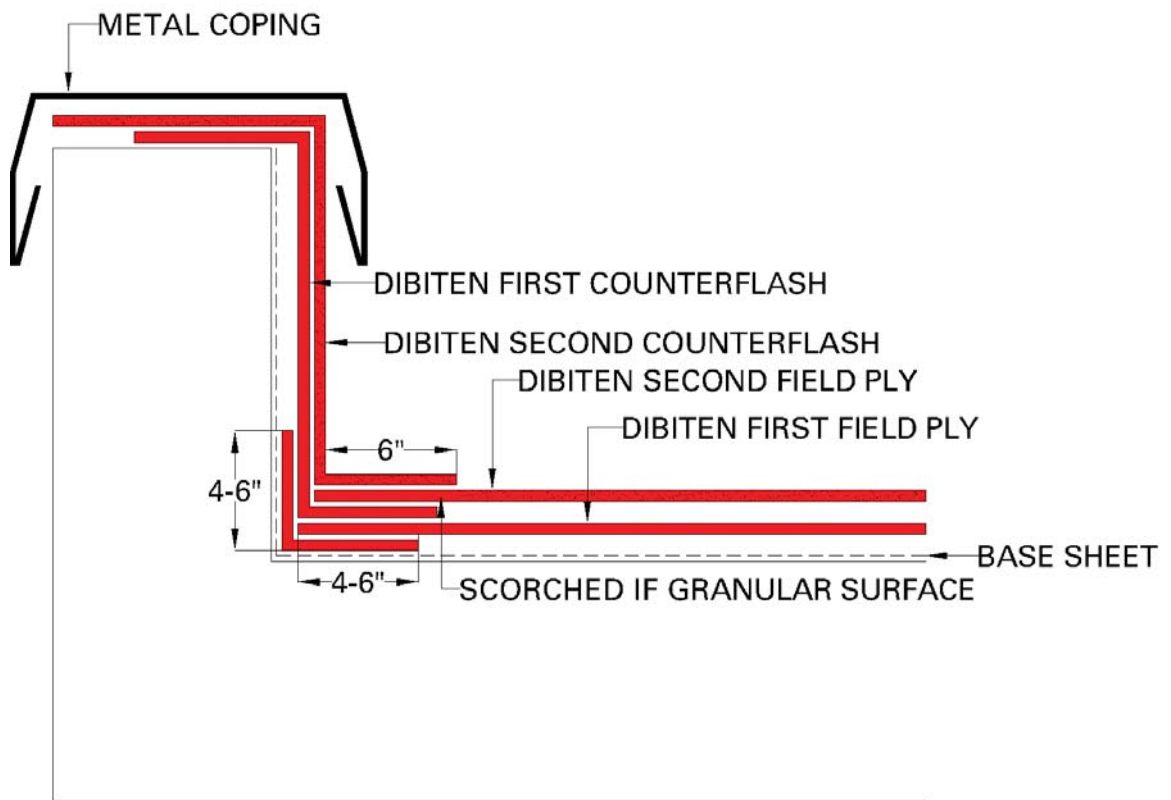

**Detail Drawing 4.2d**  
**PARAPET and INSIDE CORNERS**  
 Dibiten, Two Ply Specifications

- 1) 8-12" STRIP OF POLY/4 AT SIDEWALL
- 2) 1ST FIELD PLY (DIBITEN POLY/4)
- 3) 1ST WALL COUNTERFLASHING (DIBITEN POLY/4)
- 4) 2ND FIELD PLY
- 5) TOP AND BOTTOM CORNER PIECES
- 6) 2ND WALL COUNTERFLASHING

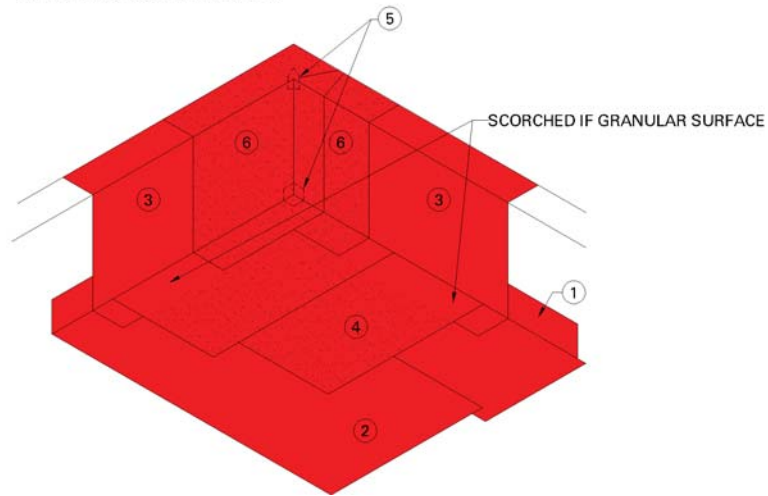

**Detail Drawing 4.2e**  
**CURBS and OUTSIDE CORNERS**  
 Dibiten, Two Ply Specifications

- 1) 8-12" STRIP POLY/4 AT SIDEWALL
- 2) 1ST FIELD PLY (DIBITEN POLY/4)
- 3) 1ST CURB COUNTERFLASHING (DIBITEN POLY/4) (EXTENDS 6" ONTO THE FIELD)
- 4) 2ND FIELD PLY
- 5) BOTTOM CORNER PIECE
- 6) 2ND CURB COUNTERFLASHING

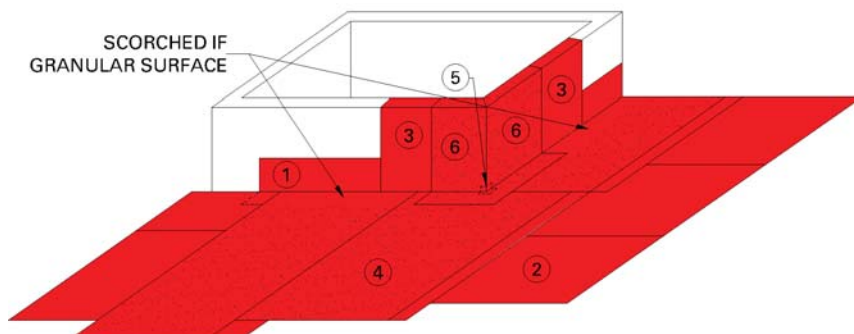

# Specification & Application Manual

## Modified Bitumen Roofing Membranes

**Detail Drawing 4.2f**  
PIPES and SIMILAR PROTRUSIONS  
Dibiten, Two Ply Specifications

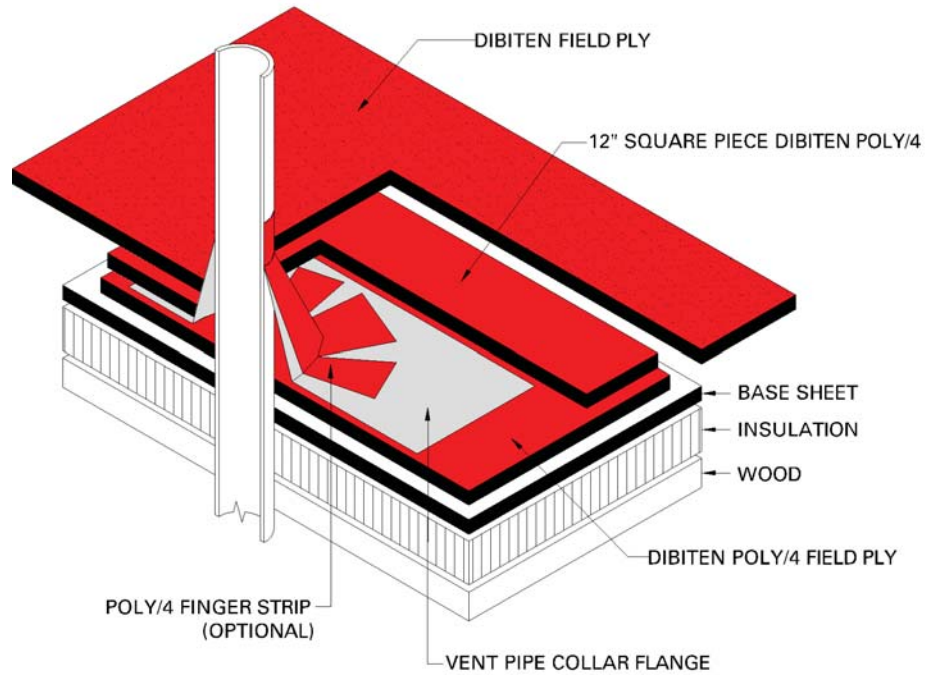

**Detail Drawing 4.2g**  
ROOF DRAINS  
Dibiten, Two Ply Specifications

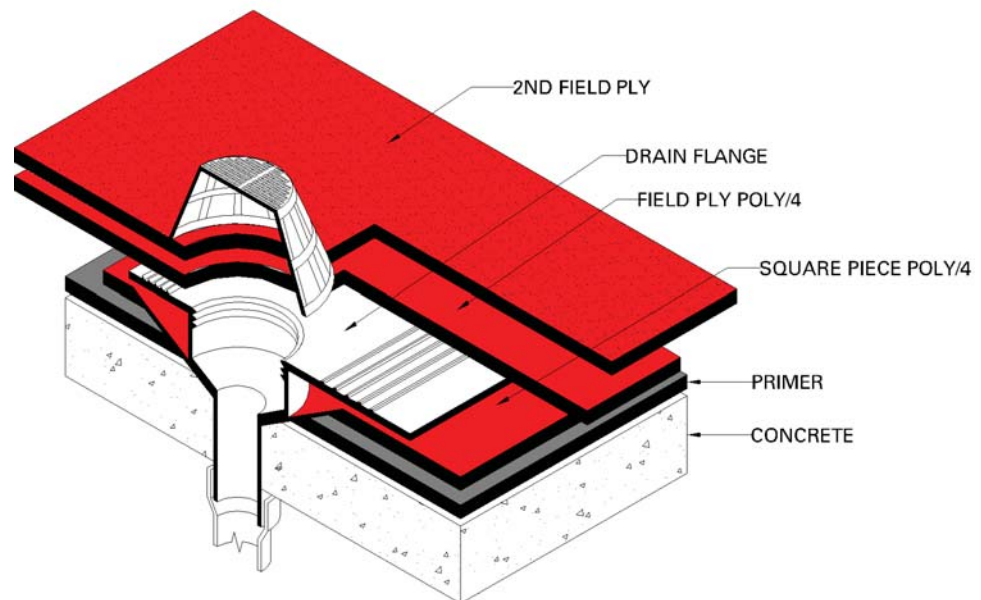

**Detail Drawing 4.2h**  
**ROOF RELIEF VENT**  
Dibiten, Two Ply Specifications

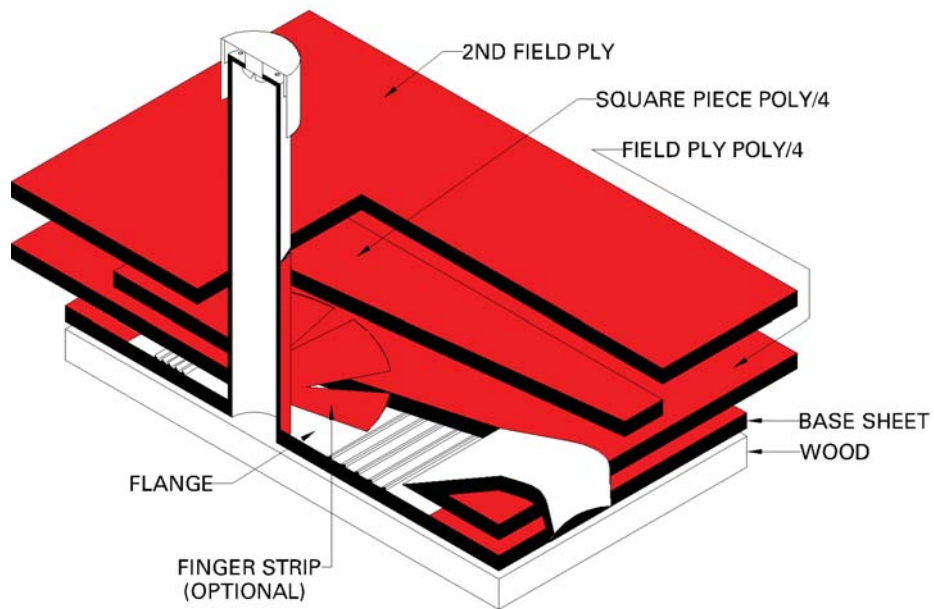



# Specification & Application Manual

## Modified Bitumen Roofing Membranes

---

### 5.1 SAFETY

#### Personnel:

Wear proper clothing (including long sleeved shirt, long pants, boots and gloves). Workmen, other than the heat weld operator, should be no closer than three feet from the open flame.

#### Contractor:

It is the contractor's responsibility to observe all fire prevention policies and practices during the installation of the roof system.

Follow NRCA and OSHA fire protection and prevention provisions; including, but not limited to those listed in OSHA 1962., 1-50., 151., 152., 153., 1191-110 as they apply to heat weld applications. Comply with all federal, state and local regulations.

It is the employer's responsibility to train, instruct, and warn employees on the use of heat welding equipment.

Workers should use extra caution around exposed edges of insulation to prevent flame from coming into contact with any flammable material. Contact for any length of time, with lead or other materials affected by heat, should be avoided.

Do not use equipment in an enclosed area.

It is the contractor's responsibility to ensure his employees wear correct clothing: no loose garments. Long sleeves, long pants, boots and gloves are recommended.

Be familiar with NFPA S8 "*Standard for the Storage & Handling of Liquefied Petroleum Gas*" and appropriate Publications of the National LP Gas Association: 1301 West 22nd Street, Oak Brook, IL 60521 and the National Fire Protection Association: Batterymarch, Quincy, MA 02269.

#### Fire Department Regulations:

Written notice should be given to the local fire department and any necessary permits should be acquired.

The required number of fire extinguishers shall be on the roof at all times.

Install portable smoke detectors in attics as required by the fire department.

Foreman on the jobsite shall have fire safety training and shall remain on the jobsite at least one hour after the application has ended for the day to check the complete roof area and attic for any signs or smoldering or fire.

No flammable liquids shall be stored or used on the roof excluding LPG in approved containers. All LPG not in use shall be stored on the ground.

#### Equipment Do's:

Do use an adjustable pilot with a complete shut-off valve.

Do use a heat weld stand to direct flame upward when not in use.

Do use only hose listed for LP gas.

Do use no more than 50 feet of hose at one time. Do use an adjustable regulator with the heat weld; it should be U.L. listed.

Do keep vent in pressure regulator unobstructed at all times.

Do make sure flow of gas through regulator is in the proper direction. Directional flow is stamped on the regulator.

Do be sure that heat welding equipment is in good working order and that the cylinder valves are clean.

Propane tanks should be secured in an upright position and placed at least 10' from the open flame.

A flint or electronic lighter should be used to ignite the burner. Matches or disposable lighters are unsafe substitutes.

Should a leak occur, stop work immediately and repair all relevant parts. Do not use heat welding equipment that is leaking gas at any fitting.

Do check hoses for wear and tear and do not allow flame to come into contact with them. Heavy equipment should not be rolled over onto the hoses. Hoses should be kept free of kinks.

Should propane odor be detected, stop the heat weld immediately.

Do you know the difference between liquid and vapor gas bottles and dispensing equipment?

Do treat the heat weld as if it is always burning. On bright days it is very hard to see the flame and when working around mechanical equipment you cannot hear the heat weld.

When using a dry chemical type fire extinguisher, direct the chemical stream at the base of the fire from a safe distance of about ten to fifteen feet. Sweep the fire away from you, starting at its nearest point and moving the chemical stream toward the furthest point.

Other than the operator, workmen should stay a minimum of three feet from the flame.

Never leave a heat weld unattended.

When shutting off the heat weld, close the propane cylinder valve first and let the remaining gas burn out of the hose before closing the heat weld valve

Do increase the size of the bottle or cylinder to keep frost from occurring.

Do secure tanks when on the roof, especially 100 lb. tanks.

Do use soap solution to test for gas leaks before lighting heat weld. Then check for proper operation of the heat weld.

Do check hoses frequently for burned or charred areas.

Do protect cylinder valves, and where possible use cylinders that have valve protection welded to the cylinder.

Do have an ABC or Halon fire extinguisher on the roof accessible to each worker using the heat weld.

Do check all equipment for wear and repair or replace as necessary.

Do be very careful when working with heat welds in areas where you cannot see. Heat the material away from the area and then apply it to the flashing.

Do protect your equipment. Store it in a toolbox.

**Equipment Don'ts:**

Do not operate any pressure gauge beyond the top of its scale, near excessive heat (above 150° F) or where there is excessive vibration.

Do not use equipment without an operating pressure gauge.

Do not turn a vapor cylinder on its side to increase pressure. Liquid could escape.

Do not heat a cylinder to increase pressure.

Do not try to put out a cylinder fire if it cannot be done without tipping the cylinder; let it burn and call the fire department.

Do not use matches or cigarette lighter to check for gas leaks.

Do not lift cylinder by the valve. Valve is made of soft brass and is easily cracked or broken.

Do not leave a lighted heat weld unattended.

Do not place fire extinguisher too close to LP gas equipment. If fire occurs, you will not have access to the extinguisher to put out the fire.

Do not fill gas cylinder or bottle in need of repair.

Do not lay an operating heat weld over the edge of a roof.

Do not use a trowel as a heat weld stand.

Do not lay an operating heat weld to rest on a gas cylinder. If there is a gas leak in the cylinder area there could be a fire.

Do not tighten the brass fittings too tightly with a wrench.

Do not use soda acid fire extinguisher - it spreads the flame.

Do not play with a heat weld. A flame can be hard to see on a bright day and can ignite skin or clothing instantly.

Do not use matches when igniting heat weld; use spark lighter or electronic start only.

**Building Do's:**

Use perlite or fiber glass cant strips if cant strips are required, and cover them with a fiber glass base sheet.

Use glass base on plywood decks, over cant strip and insulation, over any flammable surface.

Use non-combustible insulation and cover same with fiber glass base sheet.

Install metal flashings to penetrations or protect flashings with tight fitting felt collar before heat welding.

Walk the job one hour after all heat welds are out. Fires can result hours after completion of work, so the inspection time may vary depending on the size of the job and the nature of the application surface and abutments.

Make sure air conditioning units, exhaust fans, and air intake fans in the work area are shut off at the roof control.

Use a small heat weld when flashing near details.

Shield air conditioning units and other protrusions with perlite, or other similar panels, when using the heat weld around them. Heat roofing material away from air conditioning units, fans, soil pipes, and all other protrusions, and set in place while hot. Care must be taken to avoid flame being pulled into the building interior.

Feather seams around details with a hot trowel.

When heat welding at flashings, corners or voids in the roof or roof deck, never heat weld directly. Always heat weld the membrane to be applied and then adhere it to the corner or joint.

Look for any void, hole or gap and fill it with non-combustible or perlite cant strip. Cover this with fiber glass base sheet.

Use caution when heat welding near pipes in the event there is suction present. Failure to utilize the base sheet as required by the manufacturer's specifications manual is extremely hazardous as the base sheet provides a protective covering for underlying combustibles.

# Specification & Application Manual

## Modified Bitumen Roofing Membranes

---

Heat welding directly over polyurethane and polyisocyanurate roof insulations should be avoided. RIC/TIMA has recommended that an interim base ply or a layer of roof insulation, acceptable to the roof membrane manufacturer, be used to separate the foam roof insulation from the modified sheet and the heat weld.

Do install a base sheet over all flammable surfaces and rigid board insulation. Be sure base ply fits tightly around all deck openings and turns up parapet walls so the flame cannot flash down and start a fire underneath the deck.

### **Building Don'ts:**

Don't heat weld anything you cannot see; do not use the heat weld in areas like under air conditioning units or behind counterflashing.

Don't heat weld directly to wood fiber cant strips.

Don't heat weld directly to wood fiber insulation.

Don't heat weld directly to any cant strip, insulation, wood or any other flammable surface.

Don't heat weld near gas lines.

Don't heat weld near electrical wires.

Don't heat weld over flammable surfaces such as EPS insulation.

Don't heat weld around flammable vents.

Don't heat weld directly to insulation.

Don't point the heat weld under rooftop equipment.

Don't point the heat weld down open roof penetrations.

Don't point the heat weld into openings around roof penetrations.

Don't point the heat weld into corners or roof edges where dried wood or fiber (such as cant strip or wood blocking) may ignite.

Don't point the heat weld at low flashings where there is an overhang and flame could get up under the counterflashing (such as around skylights or prefabricated curbs with fiberboard side wall insulation).

Heat welding equipment is made for roofing application only and should not be used for drying out a roof or as a preheater heat weld.

Never apply modified bitumen products directly over exposed conduits or pipes laying on the roof deck.

LP gas is heavier than air. Do not work in an enclosed area where gas can accumulate.

Don't lay an operating heat weld directly onto the membrane. There is danger of fire and danger of damaging the membrane.

Don't lay an operating heat weld on an open penetration on the roof. If the penetration is part of an air intake system, the flames could be sucked into the building.

## 6.0 SPECIFICATIONS

### 6.1 NEW ROOFS

#### DIBITEN POLY/4, POLY/5 SPECIFICATIONS

**Nailable Decks, No Insulation**

#### Specification 401

##### Deck Types:

Plywood, Wood Plank, Lightweight Insulating Concrete, Poured & Precast Gypsum.

##### Base Sheet:

For plywood or wood plank decks: U.L. approved fiber glass base sheet type G-2 (25 lbs. per 100 square feet or heavier).

For lightweight insulating concrete or poured & precast gypsum decks: U.L. approved fiber glass base sheet type G-2.

##### Dibiten Poly/4, Poly/5:

Smooth surfaced modified bitumen membrane reinforced with nonwoven polyester fabric. Method of application: heat weld applied only.

##### Coating:

Dibiten recommends coating all non-granulated finished membranes. This is a requirement if the roof membrane is to be guaranteed. Use a solvent, acrylic or latex based coating compatible with modified bitumen systems. Application rates vary by manufacturer but should never be installed less than 1 gallon per 100 square feet. Coatings will enhance the life of the roof membrane but need to be maintained. Periodic recoating may be necessary. Recoating is the responsibility of the building owner.

##### Base Sheet Application:

Where required, mechanically fasten a 19 3/4" (502 mm) wide piece of base into the structural deck. The remaining base plies are to be applied full width with (76 mm) side and 4" (102 mm) end laps over the preceding sheets. Fasten the laps at 9" (229 mm) centers, and down the longitudinal center of each felt ply. Place two rows of fasteners, with the rows spaced approximately 11" (279 mm) apart, and fasteners staggered on approximately 1/8" (457 mm) centers. Use fasteners appropriate to the insulation and deck.

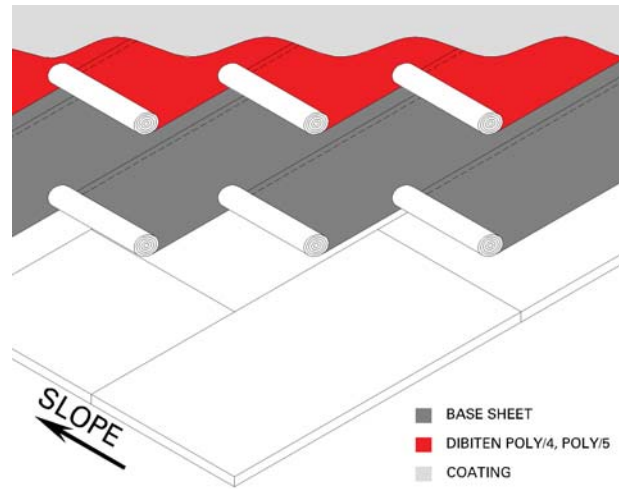

#### Roofing Application:

1. Starting at the low point of the roof, heat weld a full piece of Dibiten Poly/4 or Poly/5 so that it is firmly and uniformly set. Subsequent sheets are to be applied in the same manner, with 4" (102 mm) side and 6" (152 mm) end laps over the preceding sheets. All laps must be rolled with a 3" (76 mm) rounded edge roller. A 1/8" to 3/8" (3 mm to 10 mm) bleedout of compound shall be visible at the edge of all seams. All laps must be checked for good adhesion.
2. Apply finish coating.

#### Materials required per 100 square feet of roof area:

Base Sheet: 108 square feet

Dibiten Poly/4: Approx. 112.63 sq. ft. (Approx. 1.06 rolls)

Coating: Per Manufacturer Requirements

# Specification & Application Manual

## Modified Bitumen Roofing Membranes

### DIBITEN POLY/4, POLY/5 SPECIFICATIONS

#### Nailable Decks, Insulation

#### Specification 402

##### Deck Types:

Plywood, Wood Plank, Lightweight Insulating Concrete, Poured & Precast Gypsum.

##### Base Sheet: (Not required when using DuraBoard)

U.L. approved type G-2 fiber glass base sheet (25 lbs. per 100 square feet or heavier) is required, mechanically fastened, over all insulations.

##### Dibiten Poly/4, Poly/5:

Smooth surfaced modified bitumen membrane reinforced with nonwoven polyester fabric. Method of application: heat weld applied only.

##### Coating:

Dibiten recommends coating all non-granulated finished membranes. This is a requirement if the roof membrane is to be guaranteed. Use a solvent, acrylic or latex based coating compatible with modified bitumen systems. Application rates vary by manufacturer but should never be installed less than 1 gallon per 100 square feet. Coatings will enhance the life of the roof membrane but need to be maintained. Periodic recoating may be necessary. Recoating is the responsibility of the building owner.

##### Insulation Application:

1. Install insulation units with long joints continuous. End joints should be staggered so that they are offset at least 12" from the end joints in adjacent rows. The units of insulation should fit snugly to adjoining units.
2. If Johns Manville DuraBoard insulation is utilized by itself or as the top layer of a multilayer insulation system, Dibiten smooth or granulated products may be heat welded directly to the DuraBoard
3. Insulation may be mechanically attached to metal, gypsum, cementitious wood fiber or structural concrete decks. Insulation may be adhered with an appropriate cold adhesive to structural concrete, cementitious wood fiber and pre-cast concrete decks.
4. Other roof insulation products can be used without DuraBoard if it is possible to mechanically attach a fiber glass base sheet through the insulation into the deck (metal, structural concrete, gypsum, cementitious wood fiber).

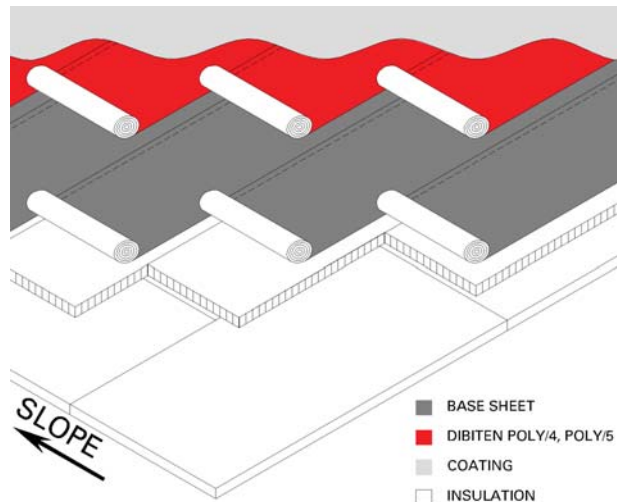

5. Where required, mechanically fasten a 19 3/4" 502 mm wide piece of base ply through the insulation. The remaining base plies are to be applied full width with 3" (76 mm) side and 4" (102 mm) end laps over the preceding sheets. Fasten the laps at 9" (229 mm) centers, and down the longitudinal center of each felt ply, place two rows of fasteners, with the rows spaced approximately 11" (279 mm) apart, and fasteners staggered on approximately 1/8" (457 mm) centers. Use fasteners appropriate to the insulation and deck.

##### Roofing Application:

1. Starting at the low point of the roof heat weld a full width piece of Dibiten Poly/4 or Poly/5 so that it is firmly and uniformly set. Subsequent sheets are to be applied in the same manner, with 4" (102 mm) side and 6" (152 mm) end laps over the preceding sheets. All laps must be rolled with a 3" (76 mm) rounded edge roller. A 1/8" to 3/8" (3 mm to 10 mm) bleedout of compound shall be visible at the edge of all seams. All laps must be checked for good adhesion.
2. Apply finish coating.

##### Materials required per 100 square feet of roof area:

Base Sheet: 108 square feet

Dibiten Poly/4: Approx. 112.63 sq. ft. (Approx. 1.06 rolls)

Coating: Per Manufacturer Requirements



**DIBITEN POLY/4, POLY/5 SPECIFICATIONS**

**Available Decks, No Insulation, Two Ply Specification**

**Specification 401-2**

**Deck Types:**

Plywood, Wood Plank, Lightweight Insulating Concrete, Poured & Precast Gypsum

**Base Sheet:**

For plywood or wood plank decks: U.L. approved fiber glass base sheet type G-2 (25 lbs. per 100 square feet or heavier).

**Dibiten Poly/4, Poly/5:**

Smooth surfaced modified bitumen membrane reinforced with nonwoven polyester fabric. Method of application: Heat weld applied only.

**Coating:**

Dibiten recommends coating all non-granulated finished membranes. This is a requirement if the roof membrane is to be guaranteed. Use a solvent, acrylic or latex based coating compatible with modified bitumen systems. Application rates vary by manufacturer but should never be installed less than 1 gallon per 100 square feet. Coatings will enhance the life of the roof membrane but need to be maintained. Periodic recoating may be necessary. Recoating is the responsibility of the building owner.

**Roofing Application:**

1. Where required, mechanically fasten a 19 3/4" (502 mm) wide piece of base into the structural deck. The remaining base plies are to be applied full width with (76 mm) side and 4" (102 mm) end laps over the preceding sheets. Fasten the laps at 9" (229 mm) centers, and down the longitudinal center of each felt ply. Place two rows of fasteners, with the rows spaced approximately 11" (279 mm) apart, and fasteners staggered on approximately 1/8" (457 mm) centers. Use fasteners appropriate to the insulation and deck.
2. Starting at the low edge of the roof, heat weld a 19 3/4" (502 mm) wide piece of Dibiten Poly/4 or Poly/5. The remaining sheets are to be applied full width, with 4" (102 mm) side and 6" (152 mm) end laps over the preceding sheets.
3. Starting at the low point of the roof heat, weld a full width piece of Poly/4 or Poly/5 so that it is firmly and uniformly set. Subsequent sheets are to be applied in the same manner, with 4" (102 mm) side and 6" (152 mm) end laps over the preceding sheets. All

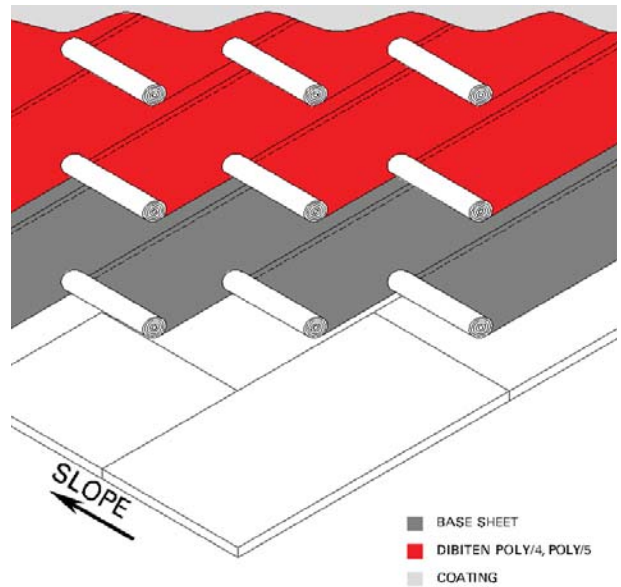

laps must be rolled with a 3" (76 mm) rounded edge roller. A 1/8" to 3/8" (3 mm to 10 mm) bleedout of compound shall be visible at the edge of all seams. All laps must be checked for good adhesions.

4. Apply finish coating.

**Materials required per 100 square feet of roof area:**

Base Sheet: 108 square feet

Dibiten Poly/4: Approx. 112.63 sq. ft. (Approx. 1.06 rolls)

Coating: Per Manufacturer Requirements



# Specification & Application Manual

## Modified Bitumen Roofing Membranes

### DIBITEN POLY/4, POLY/5 SPECIFICATIONS

#### Nailable Decks, Insulation, Two Ply Specification

#### Specification 402-2

##### Deck Types:

Plywood, Wood Plank, Lightweight Insulating Concrete, Poured & Precast Gypsum.

##### Insulation:

Only rigid roof insulation compatible with Dibiten modified bitumen membranes should be used (see requirements in Insulation Application below). Dibiten membrane products may be adhered directly to Johns Manville DuraBoard. All other insulations require a fiber glass base sheet to be installed on top of the insulation before Dibiten products are installed. Expanded polystyrene may not be used unless it is sandwiched between two layers of perlite board.

##### Base Sheet: (Except when using DuraBoard)

U.L. approved type G-2 fiber glass base sheet (25 lbs. per 100 square feet or heavier) is required, mechanically fastened, over all insulations.

##### Dibiten Poly/4, Poly/5:

Smooth surfaced modified bitumen membrane reinforced with nonwoven polyester fabric. Method of application: heat weld applied only.

##### Coating:

Dibiten recommends coating all non-granulated finished membranes. This is a requirement if the roof membrane is to be guaranteed. Use a solvent, acrylic or latex based coating compatible with modified bitumen systems. Application rates vary by manufacturer but should never be installed less than 1 gallon per 100 square feet. Coatings will enhance the life of the roof membrane but need to be maintained. Periodic recoating may be necessary. Recoating is the responsibility of the building owner.

##### Insulation Application:

1. Install insulation units with long joints continuous. End joints should be staggered so that they are offset at least 12" from the end joints in adjacent rows. The units of insulation should fit snugly to adjoining units.
2. If Johns Manville DuraBoard insulation is utilized by itself or as the top layer of a multilayer insulation system, Dibiten smooth or granulated products may be heat welded directly to the DuraBoard.
3. Insulation may be mechanically attached to metal, gypsum, cementitious wood fiber or structural concrete decks. Insulation may be adhered with an appropriate cold adhesive to structural concrete, cementitious wood fiber and pre-cast concrete decks.

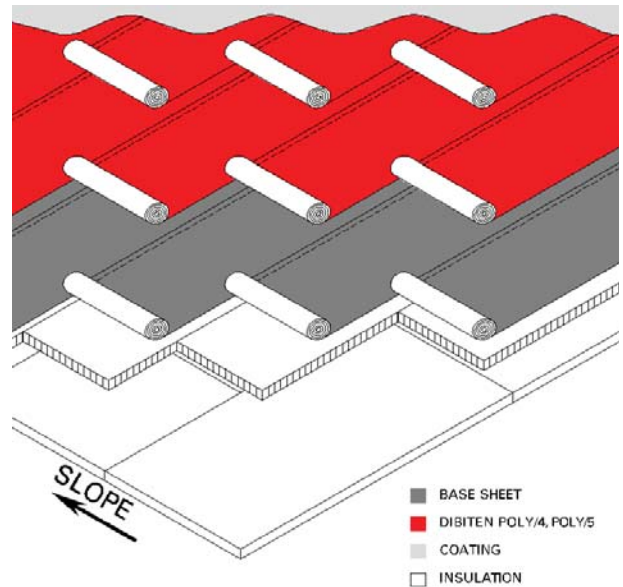

4. Other roof insulation products can be used without DuraBoard if it is possible to mechanically attach a fiber glass base sheet through the insulation into the deck (metal, structural concrete, gypsum, cementitious wood fiber).
5. Where required, mechanically fasten a 19 3/4" (502 mm) wide piece of base ply through the insulation. The remaining base plies are to be applied full width with 3" (76 mm) side and 4" (102 mm) end laps over the preceding sheets. Fasten the laps at 9" (229 mm) centers, and down the longitudinal center of each felt ply, place two rows of fasteners, with the rows spaced approximately 11" (279 mm) apart, and fasteners staggered on approximately 1/8" (457 mm) centers. Use fasteners appropriate to the insulation and deck.

##### Roofing Application:

1. Starting at the low edge of the roof, heat weld a 19 3/4" (502 mm) wide piece of Dibiten Poly/4 or Poly/5. The remaining sheets are to be applied full width, with 4" (102 mm) side and 6" (152 mm) end laps over the preceding sheets.
2. Starting at the low point of the roof heat, weld a full width piece of Poly/4 or Poly/5 so that it is firmly and uniformly set. Subsequent sheets are to be applied in the same manner, with 4" (102 mm) side and 6" (152 mm) end laps over the preceding sheets. All laps must be rolled with a 3" (76 mm) rounded edge roller. A 1/8" to 3/8" (3 mm to 10 mm) bleedout of compound shall be visible at the edge of all seams. All laps must be checked for good adhesions.
3. Apply finish coating.

## **DIBITEN POLY/4, POLY/5 SPECIFICATIONS**

**Non-nailable Decks, No Insulation**

### **Specification 403**

#### **Deck Types:**

Poured Concrete, Double T, Prestressed T, and Precast Concrete.

#### **Primer:**

Primer suitable for use over deck types listed above, applied in accordance with manufacturer instructions.

#### **Dibiten Poly/4, Poly/5:**

Smooth surfaced modified bitumen membrane reinforced with nonwoven polyester fabric. Method of application: heat weld applied only.

#### **Coating:**

Dibiten recommends coating all non-granulated finished membranes. This is a requirement if the roof membrane is to be guaranteed. Use a solvent, acrylic or latex based coating compatible with modified bitumen systems. Application rates vary by manufacturer but should never be installed less than 1 gallon per 100 square feet. Coatings will enhance the life of the roof membrane but need to be maintained. Periodic recoating may be necessary. Recoating is the responsibility of the building owner.

#### **Roofing Application:**

1. Starting at the low point of the roof, heat weld a full piece of Dibiten Poly/4 or Poly/5 so that it is firmly and uniformly set. Subsequent sheets are to be applied in the same manner, with 4" (102 mm) side and 6" (152 mm) end laps over the preceding sheets. All laps must be rolled with a 3" (76 mm) rounded edge roller. A 1/8" to 3/8" (3 mm to 10 mm) bleedout of compound shall be visible at the edge of all seams. All laps must be checked for good adhesion.
2. Apply finish coating.

#### **Materials required per 100 square feet of roof area:**

Base Sheet: 108 square feet

Dibiten Poly/4: Approx. 112.63 sq. ft. (Approx. 1.06 rolls)

Coating: Per Manufacturer Requirements

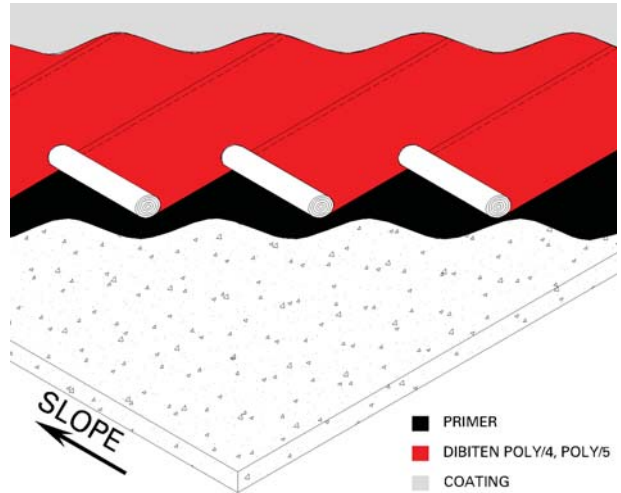

# Specification & Application Manual

## Modified Bitumen Roofing Membranes

### DIBITEN POLY/4, POLY/5 SPECIFICATIONS

#### Non-nailable Decks, Insulation

### Specification 404

#### Deck Types:

Poured Concrete, Metal, Double T, Prestressed T, and Precast Concrete.

#### Insulation:

Only rigid roof insulation compatible with Dibiten modified bitumen membranes should be used (See requirements in Insulation Application below). Dibiten membrane products may adhere directly to Johns Manville DuraBoard. All other insulations require a fiber glass base sheet to be installed on top of the insulation before Dibiten products are installed. Expanded polystyrene may not be used unless it is sandwiched between two layers of perlite board.

#### Base Sheet: (Except when using DuraBoard)

U.L. approved type G-2 fiber glass base sheet (25 lbs. per 100 square feet or heavier) is required over all insulations.

#### Dibiten Poly/4, Poly/5:

Smooth surfaced modified bitumen membrane reinforced with nonwoven polyester fabric. Method of application: heat weld applied only. Can be mopped.

#### Coating:

Dibiten recommends coating all non-granulated finished membranes. This is a requirement if the roof membrane is to be guaranteed. Use a solvent, acrylic or latex based coating compatible with modified bitumen systems. Application rates vary by manufacturer but should never be installed less than 1 gallon per 100 square feet. Coatings will enhance the life of the roof membrane but need to be maintained. Periodic recoating may be necessary. Recoating is the responsibility of the building owner.

#### Insulation/Base Sheet Application:

1. Install insulation units with long joints continuous. End joints should be staggered so that they are offset at least 12" from the end joints in adjacent rows. The units of insulation should fit snugly to adjoining units.
2. If Johns Manville DuraBoard insulation is utilized by itself or as the top layer of a multilayer insulation system, Dibiten smooth or granulated products may be heat welded directly to the DuraBoard
3. Insulation may be mechanically attached to metal, gypsum, cementitious wood fiber or structural concrete decks. Insulation may be adhered with an appropriate cold adhesive to structural concrete, cementitious wood fiber and pre-cast concrete decks.

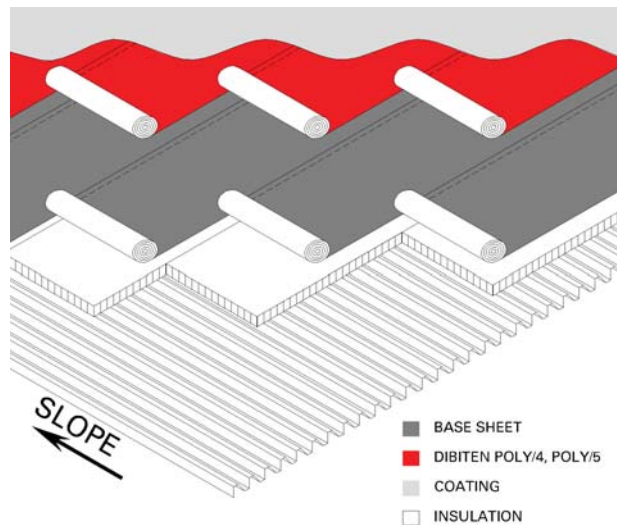

4. Other roof insulation products can be used without DuraBoard if it is possible to mechanically attach a fiber glass base sheet through the insulation into the deck (metal, structural concrete, gypsum, cementitious wood fiber).
5. Where required, mechanically fasten a 19 3/4" (502 mm) wide piece of base ply through the insulation. The remaining base plies are to be applied full width with 3" (76 mm) side and 4" (102 mm) end laps over the preceding sheets. Fasten the laps at 9" (229 mm) centers, and down the longitudinal center of each felt ply, place two rows of fasteners, with the rows spaced approximately 11" (279 mm) apart, and fasteners staggered on approximately 1/8" (457 mm) centers. Use fasteners appropriate to the insulation and deck.

#### Roofing Application:

1. Starting at the low point of the roof, heat weld a full piece of Dibiten Poly/4 or Poly/5 so that it is firmly and uniformly set. Subsequent sheets are to be applied in the same manner, with 4" (102 mm) side and 6" (152 mm) end laps over the preceding sheets. All laps must be rolled with a 3" (76 mm) rounded edge roller. A 1/8" to 3/8" (3 mm to 10 mm) bleedout of compound shall be visible at the edge of all seams. All laps must be checked for good adhesion.
2. Apply finish coating.

### DIBITEN POLY/4, POLY/5 SPECIFICATIONS

#### Non-nailable Decks, No Insulation, Two Ply Specification

#### Specification 403-2

##### Deck Types:

Poured Concrete, Double T, Prestressed T, and Precast Concrete.

##### Primer:

Primer suitable for use over deck types listed above, applied in accordance with manufacturer instructions.

##### Dibiten Poly/4, Poly/5:

Smooth surfaced modified bitumen membrane reinforced with nonwoven polyester fabric. Method of application: heat weld applied only.

##### Coating:

Dibiten recommends coating all non-granulated finished membranes. This is a requirement if the roof membrane is to be guaranteed. Use a solvent, acrylic or latex based coating compatible with modified bitumen systems. Application rates vary by manufacturer but should never be installed less than 1 gallon per 100 square feet. Coatings will enhance the life of the roof membrane but need to be maintained. Periodic recoating may be necessary. Recoating is the responsibility of the building owner.

##### Roofing Application:

1. Starting at the low edge of the roof, heat weld a 19 3/4" (502 mm) wide piece of Dibiten Poly/4 or Poly/5. The remaining sheets are to be applied full width, with 4" (102 mm) side and 6" (152 mm) end laps over the preceding sheets.
2. Starting at the low point of the roof heat, weld a full width piece of Poly/4 or Poly/5 so that it is firmly and uniformly set. Subsequent sheets are to be applied in the same manner, with 4" (102 mm) side and 6" (152 mm) end laps over the preceding sheets. All laps must be rolled with a 3" (76 mm) rounded edge roller. A 1/8" to 3/8" (3 mm to 10 mm) bleedout of compound shall be visible at the edge of all seams. All laps must be checked for good adhesion.
3. Apply finish coating.

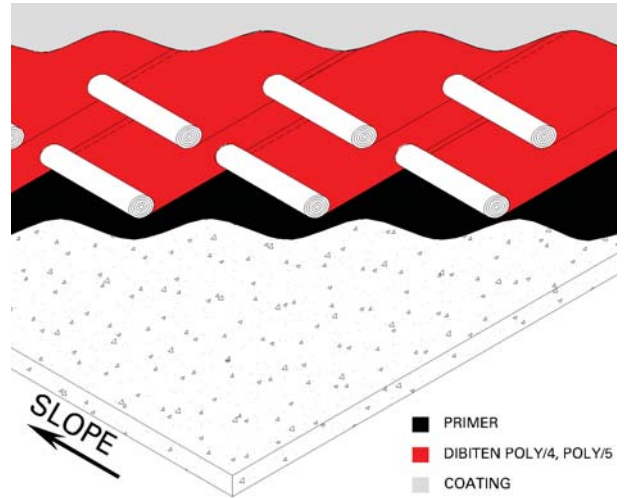



# Specification & Application Manual

## Modified Bitumen Roofing Membranes

### DIBITEN POLY/4, POLY/5 SPECIFICATIONS

#### Non-nailable Decks, Insulation, Two Ply Specification

#### Specification 404-2

##### Deck Types:

Poured Concrete, Metal, Double T, Prestressed T, and Precast Concrete.

##### Insulation:

Only rigid roof insulation compatible with Dibiten modified bitumen membranes should be used (See requirements in Insulation Application below). Dibiten membrane products may adhere directly to Johns Manville DuraBoard. All other insulations require a fiber glass base sheet to be installed on top of the insulation before Dibiten products are installed. Expanded polystyrene may not be used unless it is sandwiched between two layers of perlite board.

##### Base Sheet: (Except when using DuraBoard)

U.L. approved type G-2 fiber glass base sheet (25 lbs. per 100 square feet or heavier) is required over all insulations.

##### Dibiten Poly/4, Poly/5:

Smooth surfaced modified bitumen membrane reinforced with nonwoven polyester fabric. Method of application: heat weld applied only.

##### Coating:

Dibiten recommends coating all non-granulated finished membranes. This is a requirement if the roof membrane is to be guaranteed. Use a solvent, acrylic or latex based coating compatible with modified bitumen systems. Application rates vary by manufacturer but should never be installed less than 1 gallon per 100 square feet. Coatings will enhance the life of the roof membrane but need to be maintained. Periodic recoating may be necessary. Recoating is the responsibility of the building owner.

##### Insulation Application:

1. Install insulation units with long joints continuous. End joints should be staggered so that they are offset at least 12" from the end joints in adjacent rows. The units of insulation should fit snugly to adjoining units.
2. If Johns Manville DuraBoard insulation is utilized by itself or as the top layer of a multilayer insulation system, Dibiten smooth or granulated products may be heat welded directly to the DuraBoard
3. Insulation may be mechanically attached to metal, gypsum, cementitious wood fiber or structural concrete decks. Insulation may be adhered with an appropriate cold adhesive to structural concrete, cementitious wood fiber and pre-cast concrete decks.

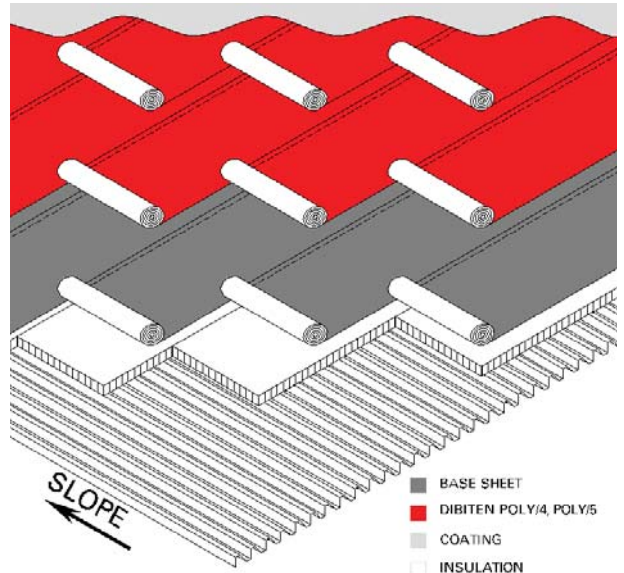

4. Other roof insulation products can be used without DuraBoard if it is possible to mechanically attach a fiber glass base sheet through the insulation into the deck (metal, structural concrete, gypsum, cementitious wood fiber).
5. Where required, mechanically fasten a 19 3/4" (502 mm) wide piece of base ply through the insulation. The remaining base plies are to be applied full width with 3" (76 mm) side and 4" (102 mm) end laps over the preceding sheets. Fasten the laps at 9" (229 mm) centers, and down the longitudinal center of each felt ply. Place two rows of fasteners, with the rows spaced approximately 11" (279 mm) apart, and fasteners staggered on approximately 1/8" (457 mm) centers. Use fasteners appropriate to the insulation and deck.

##### Roofing Application:

1. Starting at the low edge of the roof, heat weld a 19 3/4" (502 mm) wide piece of Dibiten Poly/4 or Poly/5. The remaining sheets are to be applied full width, with 4" (102 mm) side and 6" (152 mm) end laps over the preceding sheets.
2. Starting at the low point of the roof heat, weld a full width piece of Poly/4 or Poly/5 so that it is firmly and uniformly set. Subsequent sheets are to be applied in the same manner, with 4" (102 mm) side and 6" (152 mm) end laps over the preceding sheets. All laps must be rolled with a 3" (76 mm) rounded edge roller. A 1/8" to 3/8" (3 mm to 10 mm) bleedout of compound shall be visible at the edge of all seams. All laps must be checked for good adhesions.
3. Apply finish coating.

### DIBITEN POLY/4.5 GRANULAR SPECIFICATIONS

Nailable Decks, No Insulation

#### Specification 451

#### Specification 451 FR

##### Deck Types:

Plywood, Wood Plank, Lightweight Insulating Concrete, Poured & Precast Gypsum.

##### Base Sheet:

For plywood or wood plank decks: U.L. approved fiber glass base sheet type G-2 (25 lbs. per 100 square feet or heavier).

##### Dibiten Poly/4.5 Granular:

Granular (slate flake) finished modified bitumen membrane reinforced with nonwoven polyester fabric. Method of application: heat weld applied only.

##### Roofing Application:

1. Where required, mechanically fasten a 19 3/4" (502 mm) wide piece of base into the structural deck. The remaining base plies are to be applied full width with (76 mm) side and 4" (102 mm) end laps over the preceding sheets. Fasten the laps at 9" (229 mm) centers, and down the longitudinal center of each felt ply. Place two rows of fasteners, with the rows spaced approximately 11" (279 mm) apart, and fasteners staggered on approximately 1/8" (457 mm) centers. Use fasteners appropriate to the insulation and deck.
2. Starting at the low point of the roof, heat weld a full width piece of Dibiten Poly 4.5 or Poly 4.5 FR, so that it is firmly and uniformly set. Subsequent sheets are to be applied in the same manner, with 4" (102 mm) side and 6" (152 mm) end laps over the preceding sheets. All laps must be rolled with a 3" (76 mm) rounded edge roller. A 1/8" to 3/8" (3 mm to 10 mm) bleedout of compound shall be visible at the edge of all seams. All laps must be checked for good adhesion. Preparation of the 6" (152 mm) end lap requires scuffing away all loose granules. Heat and embed all remaining granules. Apply heat to the roll being seamed while making sure both have a good compound flow to adhere the two surfaces. End laps must be checked for proper adhesion.

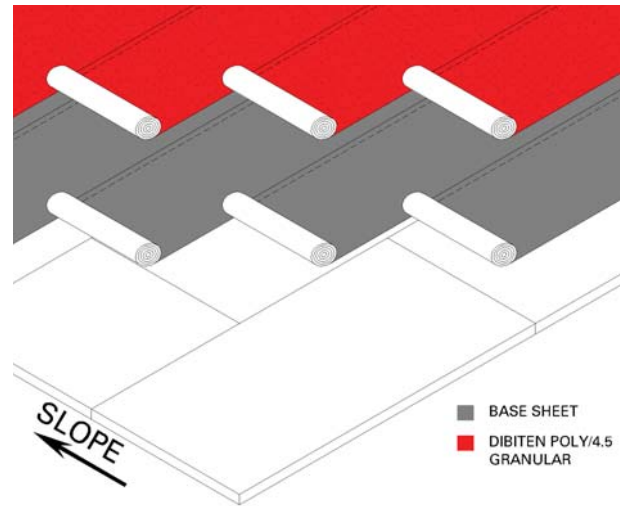



# Specification & Application Manual

## Modified Bitumen Roofing Membranes

### DIBITEN POLY/4.5 GRANULAR SPECIFICATIONS

#### Nailable Decks, Insulation

#### Specification 452 Specification 452 FR

#### Deck Types:

Plywood, Wood Plank, Lightweight Insulating Concrete, Poured & Precast Gypsum.

#### Insulation:

Only rigid roof insulation compatible with Dibiten modified bitumen membranes should be used (see requirements in Insulation Application below). Dibiten membrane products may be adhered directly to Johns Manville DuraBoard. All other insulations require a fiber glass base sheet to be installed on top of the insulation before Dibiten products are installed. Expanded polystyrene may not be used unless it is sandwiched between two layers of perlite board.

#### Base Sheet: (Except when using DuraBoard)

U.L. approved type G-2 fiber glass base sheet (25 lbs. per 100 square feet or heavier) is required, mechanically fastened, over all insulations.

#### Dibiten Poly/4.5 Granular:

Granular (slate flake) finished modified bitumen membrane reinforced with nonwoven polyester fabric. Method of application: heat weld applied only.

#### Insulation Application:

1. Install insulation units with long joints continuous. End joints should be staggered so that they are offset at least 12" from the end joints in adjacent rows. The units of insulation should fit snugly to adjoining units.
2. If Johns Manville DuraBoard insulation is utilized by itself or as the top layer of a multilayer insulation system, Dibiten smooth or granulated products may be heat welded directly to the DuraBoard
3. Insulation may be mechanically attached to metal, gypsum, cementitious wood fiber or structural concrete decks. Insulation may be adhered with an appropriate cold adhesive to structural concrete, cementitious wood fiber and pre-cast concrete decks.
4. Other roof insulation products can be used without DuraBoard if it is possible to mechanically attach a fiber glass base sheet through the insulation into the deck (metal, structural concrete, gypsum, cementitious wood fiber).

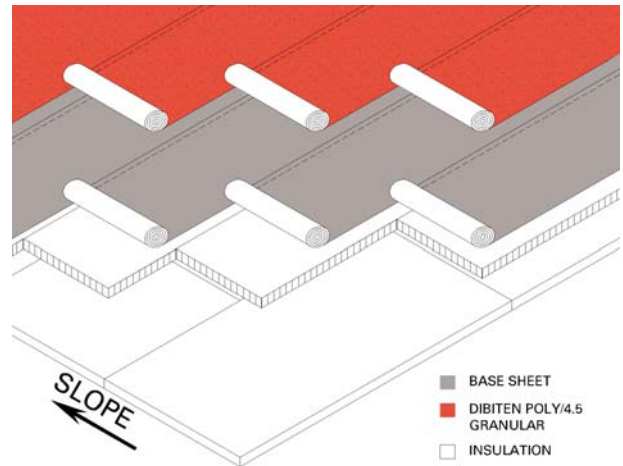

5. Where required, mechanically fasten a 19 3/4" (502 mm) wide piece of base ply through the insulation. The remaining base plies are to be applied full width with 3" (76 mm) side and 4" (102 mm) end laps over the preceding sheets. Fasten the laps at 9" (229 mm) centers, and down the longitudinal center of each felt ply, place two rows of fasteners, with the rows spaced approximately 11" (279 mm) apart, and fasteners staggered on approximately 1/8" (457 mm) centers. Use fasteners appropriate to the insulation and deck.

#### Roof Application:

1. Starting at the low point of the roof, heat weld a full width piece of Dibiten Poly 4.5 or Poly 4.5 FR, so that it is firmly and uniformly set. Subsequent sheets are to be applied in the same manner, with 4" (102 mm) side and 6" (152 mm) end laps over the preceding sheets. All laps must be rolled with a 3" (76 mm) rounded edge roller. A 1/8" to 3/8" (3 mm to 10 mm) bleedout of compound shall be visible at the edge of all seams. All laps must be checked for good adhesion. Preparation of the 6" (152 mm) end lap requires scuffing away all loose granules. Heat and embed all remaining granules. Apply heat to the roll being seamed while making sure both have a good compound flow to adhere the two surfaces. End laps must be checked for proper adhesion.

### **DIBITEN POLY/4.5 GRANULAR SPECIFICATIONS**

**Nailable Decks, No Insulation, Two Ply Specification**

**Specification 451-2**

**Specification 451-2 FR**

#### **Deck Types:**

Plywood, Wood Plank, Lightweight Insulating Concrete, Poured & Precast Gypsum.

#### **Base Sheet:**

For plywood or wood plank decks: U.L. approved fiber glass base sheet type G-2 (25 lbs. per 100 square feet or heavier).

#### **Dibiten Poly/4, Poly/5:**

Smooth surfaced modified bitumen membrane reinforced with nonwoven polyester fabric. Method of application: heat weld applied only.

#### **Dibiten Poly/4.5 Granular:**

Granular (slate flake) finished modified bitumen membrane reinforced with nonwoven polyester fabric. Method of application: heat weld applied only.

#### **Base Application:**

1. Where required mechanically fasten a 19 3/4" (502 mm) wide piece of base ply through the insulation. The remaining base plies are to be applied full width with 3" (76 mm) side and 4" (102 mm) end laps over the preceding sheets. Fasten the laps at 9" (229 mm) centers, and down the longitudinal center of each felt ply, place two rows of fasteners, with the rows spaced approximately 11" (279 mm) apart, and fasteners staggered on approximately 1/8" (457 mm) centers. Use fasteners appropriate to the insulation and deck.

#### **Roof Application:**

1. Starting at the low edge of the roof, heat weld a 19 3/4" (502 mm) wide piece of Dibiten Poly/4 or Poly/5. The remaining sheets are to be applied full width, with 4" (102 mm) side and 6" (152 mm) end laps over the preceding sheets.
2. Starting at the low point of the roof, heat weld a full width piece of Dibiten Granular or Dibiten FR so that it is firmly and uniformly set. Subsequent sheets are to be applied in the same manner, with 4" (102 mm) side and 6" (152 mm) end laps over the preceding sheets. All laps must be rolled with a 3" (76 mm) rounded edge roller. A 18" to 38" (3 mm to 10 mm)

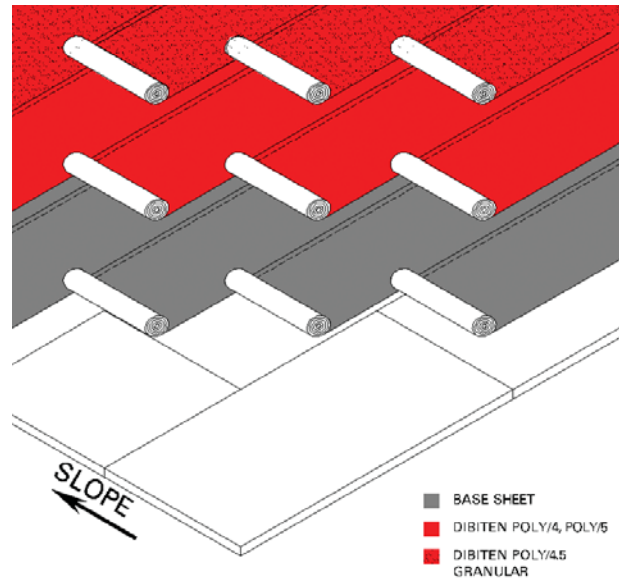

bleedout of compound shall be visible at the edge of all seams. All laps must be checked for good adhesion. Preparation of the 6" (152 mm) end lap requires scuffing away all loose granules. Heat and embed all remaining granules. Apply heat to the roll being seamed while making sure both have a good compound flow to adhere the two surfaces. End laps must be checked for proper adhesion.

# Specification & Application Manual

## Modified Bitumen Roofing Membranes

### DIBITEN POLY/4.5 GRANULAR SPECIFICATIONS

Nailable Decks, Insulation, Two Ply Specification

#### Specification 452-2

#### Specification 452-2 FR

##### Deck Types:

Plywood, Wood Plank, Lightweight Insulating Concrete, Poured & Precast Gypsum.

##### Insulation:

Only rigid roof insulation compatible with Dibiten modified bitumen membranes should be used (see requirements in Insulation Application below). Dibiten membrane products may be adhered directly to Johns Manville DuraBoard. All other insulations require a fiber glass base sheet to be installed on top of the insulation before Dibiten products are installed. Expanded polystyrene may not be used unless it is sandwiched between two layers of perlite board.

##### Base Sheet:

U.L. approved type G-2 fiber glass base sheet (25 lbs. per 100 square feet or heavier) is required, mechanically fastened, over all insulations.

##### Dibiten Poly/4, Poly/5:

Smooth surfaced modified bitumen membrane reinforced with nonwoven polyester fabric. Method of application: heat weld applied only.

##### Dibiten Poly/4.5 Granular:

Granular (slate flake) finished modified bitumen membrane reinforced with nonwoven polyester fabric. Method of application: heat weld applied only.

##### Insulation/Base Sheet Application:

1. Install insulation units with long joints continuous. End joints should be staggered so that they are offset at least 12" from the end joints in adjacent rows. The units of insulation should fit snugly to adjoining units.
2. If Johns Manville DuraBoard insulation is utilized by itself or as the top layer of a multilayer insulation system, Dibiten smooth or granulated products may be heat welded directly to the DuraBoard
3. Insulation may be mechanically attached to metal, gypsum, cementitious wood fiber or structural concrete decks. Insulation may be adhered with an appropriate cold adhesive to structural concrete, cementitious wood fiber and pre-cast concrete.
4. Other roof insulation products can be used without DuraBoard if it is possible to mechanically attach a fiber glass base sheet through the insulation into the deck (metal, structural concrete, gypsum, cementitious wood fiber).

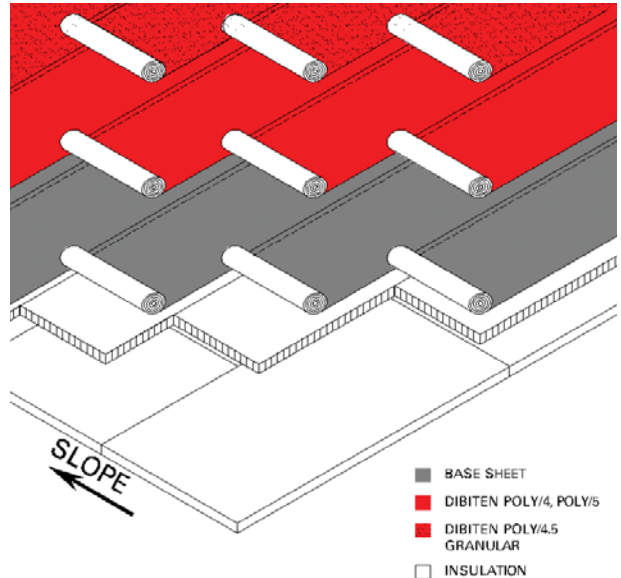

5. Where required, mechanically fasten a 19 3/4" (502 mm) wide piece of base ply through the insulation. The remaining base plies are to be applied full width with 3" (76 mm) side and 4" (102 mm) end laps over the preceding sheets. Fasten the laps at 9" (229 mm) centers, and down the longitudinal center of each felt ply. Place two rows of fasteners, with the rows spaced approximately 11" (279 mm) apart, and fasteners staggered on approximately 18" (457 mm) centers. Use fasteners appropriate to the insulation and deck.

##### Roofing Application:

1. Starting at the low edge of the roof, heat weld a 19 3/4" (502 mm) wide piece of Dibiten Poly/4 or Poly/5. The remaining sheets are to be applied full width, with 4" (102 mm) side and 6" (152 mm) end laps over the preceding sheets.
2. Starting at the low point of the roof, heat weld a full width piece of Dibiten Granular or Dibiten FR so that it is firmly and uniformly set. Subsequent sheets are to be applied in the same manner, with 4" (102 mm) side and 6" (152 mm) end laps over the preceding sheets. All laps must be rolled with a 3" (76 mm) rounded edge roller. A 18" to 38" (3 mm to 10 mm) bleedout of compound shall be visible at the edge of all seams. All laps must be checked for good adhesion. Preparation of the 6" (152 mm) end lap requires scuffing away all loose granules. heat and embed all remaining granules. Apply heat to the roll being seamed while making sure both have a good compound flow to adhere the two surfaces. End laps must be checked for proper adhesion.

### **DIBITEN POLY/4.5 SPECIFICATIONS**

**Non-nailable Decks, No Insulation**

#### **Specification 453** **Specification 453 FR**

**Deck Types:**

Poured Concrete, Double T, Prestressed T, and Precast Concrete.

**Primer:**

Primer suitable for use over deck types listed above, applied in accordance with manufacturer instructions.

**Dibiten Poly/4.5 Granular:**

Granular (slate flake) surfaced modified bitumen membrane reinforced with nonwoven polyester fabric. Method of application: heat weld applied only.

**Roofing Application:**

1. Starting at the low point of the roof, heat weld a full width piece of Dibiten Poly 4.5 or Poly 4.5 FR, so that it is firmly and uniformly set. Subsequent sheets are to be applied in the same manner, with 4" (102 mm) side and 6" (152 mm) end laps over the preceding sheets. All laps must be rolled with a 3" (76 mm) rounded edge roller. A 1/8" to 3/8" (3 mm to 10 mm) bleedout of compound shall be visible at the edge of all seams. All laps must be checked for good adhesion. Preparation of the 6" (152 mm) end lap requires scuffing away all loose granules. Heat and embed all remaining granules. Apply heat to the roll being seamed while making sure both have a good compound flow to adhere the two surfaces. End laps must be checked for proper adhesion.

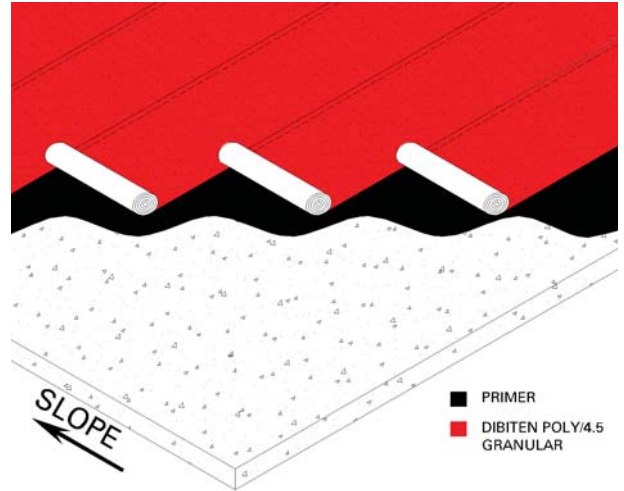

# Specification & Application Manual

## Modified Bitumen Roofing Membranes

### DIBITEN POLY/4.5 SPECIFICATIONS

#### Non-nailable Decks, Insulation

#### Specification 454 Specification 454 FR

#### Deck Types:

Poured Concrete, Metal, Double T, Prestressed T, and Precast Concrete.

#### Insulation:

Only rigid roof insulation compatible with Dibiten modified bitumen membranes should be used (see requirements in Insulation Application below). Dibiten membrane products may be adhered directly to Johns Manville DuraBoard. All other insulations require a fiber glass base sheet to be installed on top of the insulation before Dibiten products are installed. Expanded polystyrene may not be used unless it is sandwiched between two layers of perlite board.

#### Base Sheet:

U.L. approved type G-2 fiber glass base sheet (25 lbs. per 100 square feet or heavier) is required over all insulations.

#### Dibiten Poly/4.5 Granular:

Granular (slate flake) finished modified bitumen membrane reinforced with nonwoven polyester fabric. Method of application: Heat weld applied only.

#### Insulation Application:

1. Install insulation units with long joints continuous. End joints should be staggered so that they are offset at least 12" from the end joints in adjacent rows. The units of insulation should fit snugly to adjoining units.
2. If Johns Manville DuraBoard insulation is utilized by itself or as the top layer of a multilayer insulation system, Dibiten smooth or granulated products may be heat welded directly to the DuraBoard
3. Insulation may be mechanically attached to metal, gypsum, cementitious wood fiber or structural concrete decks. Insulation may be adhered with an appropriate cold adhesive to structural concrete, cementitious wood fiber and pre-cast concrete decks.
4. Other roof insulation products can be used without DuraBoard if it is possible to mechanically attach a fiber glass base sheet through the insulation into the deck (metal, structural concrete, gypsum, cementitious wood fiber).
5. Where required, mechanically fasten a 19 3/4" (502 mm) wide piece of base ply through the insulation. The remaining base plies are to be applied full width

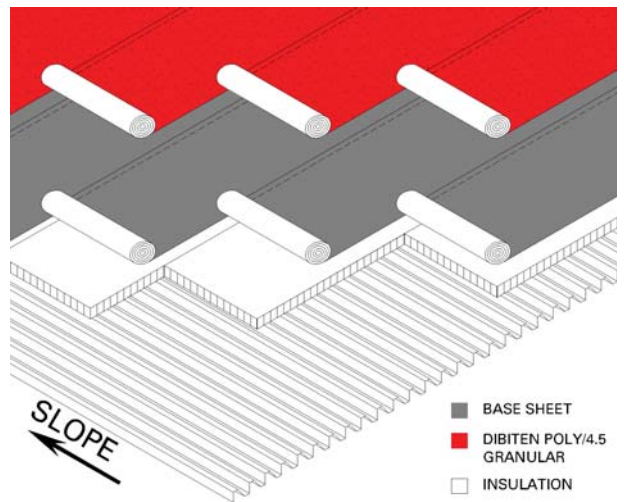

with 3" (76 mm) side and 4" (102 mm) end laps over the preceding sheets. Fasten the laps at 9" (229 mm) centers, and down the longitudinal center of each felt ply, place two rows of fasteners, with the rows spaced approximately 11" (279 mm) apart, and fasteners staggered on approximately 1/8" (457 mm) centers. Use fasteners appropriate to the insulation and deck.

#### Roofing Application:

1. Where required, mechanically fasten a 19 3/4" (502 mm) wide piece of base into the structural deck. The remaining base plies are to be applied full width at 9" (229 mm) centers, and down the longitudinal center of each felt ply. Place two rows of fasteners, with the rows spaced approximately 11" (279 mm) apart, and fasteners staggered on approximately 1/8" (457 mm) centers. Use fasteners appropriate to the insulation and deck.
2. Starting at the low point of the roof, heat weld a full width piece of Dibiten Poly 4.5 or Poly 4.5 FR, so that it is firmly and uniformly set. Subsequent sheets are to be applied in the same manner, with 4" (102 mm) side and 6" (152 mm) end laps over the preceding sheets. All laps must be rolled with a 3" (76 mm) rounded edge roller. A 1/8" to 3/8" (3 mm to 10 mm) bleedout of compound shall be visible at the edge of all seams. All laps must be checked for good adhesion. Preparation of the 6" (152 mm) end lap requires scuffing away all loose granules. Heat and embed all remaining granules. Apply heat to the roll being seamed while making sure both have a good compound flow to adhere the two surfaces. End laps must be checked for proper adhesion.



### **DIBITEN POLY/4.5 SPECIFICATIONS**

**Non-nailable Decks, No Insulation, Two Ply Specification**

**Specification 453-2**

**Specification 453-2 FR**

**Deck Types:**

Poured Concrete, Double T, Prestressed T, and Precast Concrete.

**Primer:**

Primer suitable for use over deck types listed above, applied in accordance with manufacturer instructions.

**Dibiten Poly/4, Poly/5:**

Smooth surfaced modified bitumen membrane reinforced with nonwoven polyester fabric. Method of application: heat weld applied only.

**Dibiten Poly/4.5 :**

Granular (slate flake) surfaced modified bitumen membrane reinforced with nonwoven polyester fabric. Method of application: heat weld applied only.

**Roofing Application:**

1. Apply suitable primer at the rate specified by the manufacturer and allow primer to completely dry.
2. Starting at the low edge of the roof, heat weld a 19 3/4" (502 mm) wide piece of Dibiten Poly/4 or Poly/5. The remaining sheets are to be applied full width, with 4" (102 mm) side and 6" (152 mm) end laps over the preceding sheets.
3. Starting at the low point of the roof, heat weld a full width piece of Dibiten Granular or Dibiten FR so that it is firmly and uniformly set. Subsequent sheets are to be applied in the same manner, with 4" (102 mm) side and 6" (152 mm) end laps over the preceding sheets. All laps must be rolled with a 3" (76 mm) rounded edge roller. A 1/8" to 3/8" (3 mm to 10 mm) bleedout of compound shall be visible at the edge of all seams. All laps must be checked for good adhesion. Preparation of the 6" (152 mm) end lap requires scuffing away all loose granules. Heat and embed all remaining granules. Apply heat to the roll being seamed while making sure both have a good compound flow to adhere the two surfaces. End laps must be checked for proper adhesion.

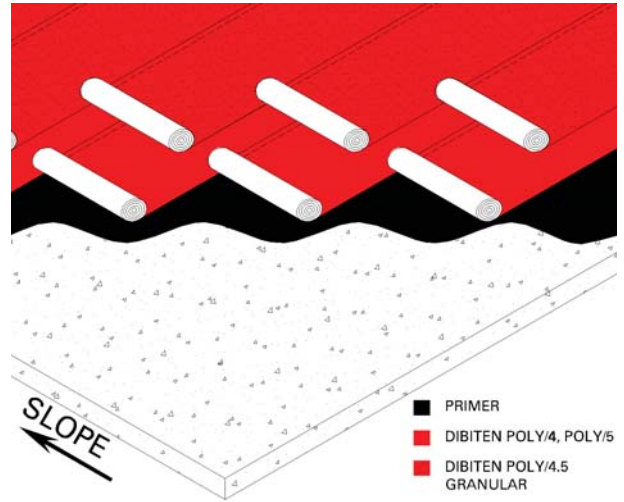



# Specification & Application Manual

## Modified Bitumen Roofing Membranes

### DIBITEN POLY/4.5 SPECIFICATIONS

Non-nailable Decks, Insulation, Two Ply Specification

#### Specification 454-2

#### Specification 454-2 FR

##### Deck Types:

Poured Concrete, Metal, Double T, Prestressed T, and Precast Concrete.

##### Insulation:

Only rigid roof insulation compatible with Dibiten modified bitumen membranes should be used (see requirements in Insulation Application below). Dibiten membrane products may be adhered directly to Johns Manville DuraBoard. All other insulations require a fiber glass base sheet to be installed on top of the insulation before Dibiten products are installed. Expanded polystyrene may not be used unless it is sandwiched between two layers of perlite board.

##### Base Sheet:

U.L. approved type G-2 fiber glass base sheet (25 lbs. per 100 square feet or heavier) is required over all insulations.

##### Dibiten Poly/4, Poly/5:

Smooth surfaced modified bitumen membrane reinforced with nonwoven polyester fabric. Method of application: Heat weld applied only.

##### Dibiten Poly/4.5 Granular:

Granular (slate flake) surfaced modified bitumen membrane reinforced with nonwoven polyester fabric. Method of application: heat weld applied only.

##### Insulation Application:

1. Install insulation units with long joints continuous. End joints should be staggered so that they are offset at least 12" from the end joints in adjacent rows. The units of insulation should fit snugly to adjoining units.
2. If Johns Manville DuraBoard insulation is utilized by itself or as the top layer of a multilayer insulation system, Dibiten smooth or granulated products may be heat welded directly to the DuraBoard
3. Insulation may be mechanically attached to metal, gypsum, cementitious wood fiber or structural concrete decks. Insulation may be adhered with an appropriate cold adhesive to structural concrete, cementitious wood fiber and pre-cast concrete decks.
4. Other roof insulation products can be used without DuraBoard if it is possible to mechanically attach a fiber glass base sheet through the insulation into the deck (metal, structural concrete, gypsum, cementitious wood fiber).

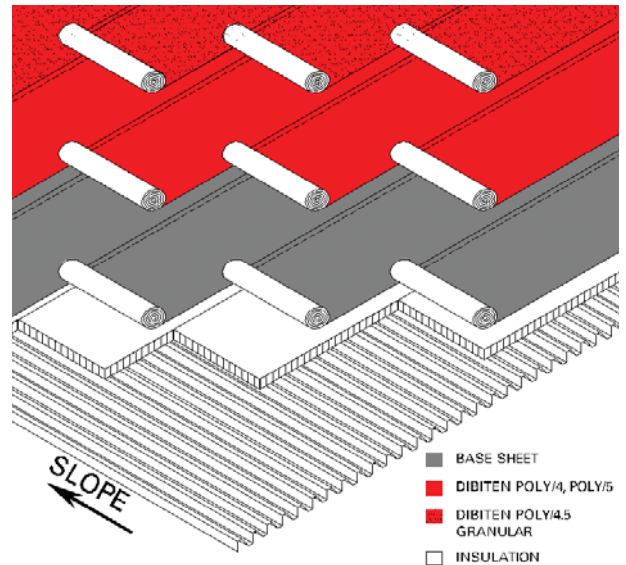

5. Where required, mechanically fasten a 19 3/4" (502 mm) wide piece of base ply through the insulation. The remaining base plies are to be applied full width with 3" (76 mm) side and 4" (102 mm) end laps over the preceding sheets. Fasten the laps at 9" (229 mm) centers, and down the longitudinal center of each felt ply, place two rows of fasteners, with the rows spaced approximately 11" (279 mm) apart, and fasteners staggered on approximately 1/8" (457 mm) centers. Use fasteners appropriate to the insulation and deck.

##### Roofing Application:

1. Starting at the low edge of the roof, heat weld a 19 3/4" (502 mm) wide piece of Dibiten Poly/4 or Poly/5. The remaining sheets are to be applied full width, with 4" (102 mm) side and 6" (152 mm) end laps over the preceding sheets.
2. Starting at the low point of the roof heat, weld a full width piece of Dibiten Granular or Dibiten FR so that it is firmly and uniformly set. Subsequent sheets are to be applied in the same manner, with 4" (102 mm) side and 6" (152 mm) end laps over the preceding sheets. All laps must be rolled with a 3" (76 mm) rounded edge roller. A 1/8" to 3/8" (3 mm to 10 mm) bleedout of compound shall be visible at the edge of all seams. All laps must be checked for good adhesion.

## 6.2 REROOFING SPECIFICATIONS

### Smooth Surfaced Roofs, Dibiten Poly/4, Poly/5

#### Specification R405

##### Surface Types:

Smooth Surfaced Existing Roofs.

##### Insulation:

Insulation used in reroofing over existing smooth surfaced roofs is an option, not a requirement. When used, only rigid roof insulation compatible with Dibiten modified bitumen membranes should be used (see requirements in Insulation Application below). Dibiten membrane products may be adhered directly to Johns Manville DuraBoard. All other insulations require a fiber glass base sheet to be installed on top of the insulation before Dibiten products are installed. Expanded polystyrene may not be used unless it is sandwiched between two layers of perlite board.

##### Base Sheet:

U.L. approved type G-2 fiber glass base sheet (25 lbs. per 100 square feet or heavier), mechanically fastened.

##### Dibiten Poly/4, Poly/5:

Smooth surfaced modified bitumen membrane reinforced with nonwoven polyester fabric: heat weld applied only.

##### Coating:

Dibiten recommends coating all non-granulated finished membranes. This is a requirement if the roof membrane is to be guaranteed. Use a solvent, acrylic or latex based coating compatible with modified bitumen systems. Application rates vary by manufacturer but should never be installed less than 1 gallon per 100 square feet. Coatings will enhance the life of the roof membrane but need to be maintained. Periodic recoating may be necessary. Recoating is the responsibility of the building owner.

##### Insulation/Base Sheet Application (Optional):

1. Install insulation units with long joints continuous. End joints should be staggered so that they are offset at least 12" from the end joints in adjacent rows. The units of insulation should fit snugly to adjoining units.
2. If Johns Manville DuraBoard Insulation is utilized by itself or as the top layer of a multilayer insulation system, Dibiten smooth or granulated products may be heat welded directly to the DuraBoard.
3. Insulation may be mechanically attached to metal, gypsum, cementitious wood fiber or structural concrete decks. Insulation may be adhered with an appropriate

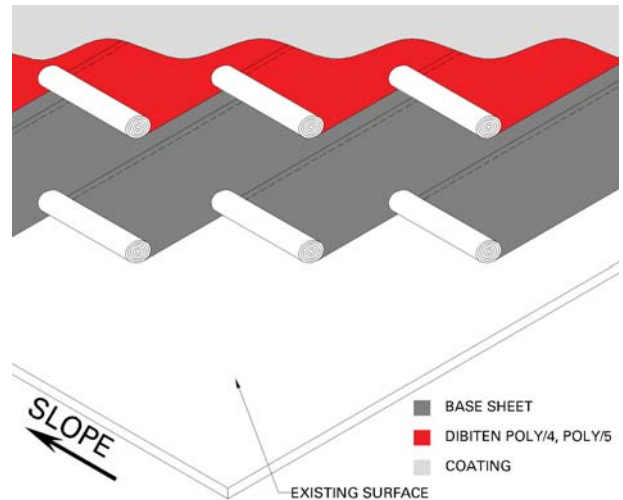

cold adhesive to structural concrete, cementitious wood fiber and pre-cast concrete decks.

4. Other roof insulation products can be used without DuraBoard if it is possible to mechanically attach a fiber glass base sheet through the insulation into the deck (metal, structural concrete, gypsum, cementitious wood fiber).
5. Where required, mechanically fasten a 19 3/4" (502 mm) wide piece of base ply through the insulation. The remaining base plies are to be applied full width with 3" (76 mm) side and 4" (102 mm) end laps over the preceding sheets. Fasten the laps at 9" (229 mm) centers, and down the longitudinal center of each felt ply. Place two rows of fasteners, with the rows spaced approximately 11" (279 mm) apart, and fasteners staggered on approximately 1/8" (457 mm) centers. Use fasteners appropriate to the insulation and deck.

##### Roofing Application:

1. Prepare surface to be roofed as described in Section 2.4, Reroofing, of this manual.
2. Starting at the low point of the roof, heat weld a full width piece of Dibiten Poly/4 or Poly/5 so that it is firmly and uniformly set. Subsequent sheets are to be applied in the same manner, with 4" (102 mm) side and 6" (152 mm) end laps over the preceding sheets. All laps must be rolled with a 3" (76 mm) rounded edge roller. A 1/8" to 3/8" (3 mm to 10 mm) bleedout of compound shall be visible at the edge of all seams. All laps must be checked for good adhesion.
3. Apply finish coating.

# Specification & Application Manual

## Modified Bitumen Roofing Membranes

### REROOFING SPECIFICATIONS

#### Smooth Surfaced Roofs, Dibiten Poly/4.5 Granular

#### Specification R455 Specification R455 FR

##### Surface Types:

Smooth Surfaced Existing Roofs.

##### Insulation:

Insulation used in reroofing over existing smooth surfaced roofs is an option, not a requirement. When used, only rigid roof insulation compatible with Dibiten modified bitumen membranes should be used (see requirements in Insulation Application below). Dibiten membrane products may be adhered directly to Johns Manville DuraBoard. All other insulations require a fiber glass base sheet to be installed on top of the insulation before Dibiten products are installed. Expanded polystyrene may not be used unless it is sandwiched between two layers of perlite board.

##### Base Sheet:

U.L. approved type G-2 fiber glass base sheet (25 lbs. per 100 square feet or heavier), mechanically fastened.

##### Dibiten Poly/4.5 Granular:

Granular (slate flake) surfaced modified bitumen membrane, heat weld applied only.

##### Insulation/Base Sheet Application (Optional):

1. Install insulation units with long joints continuous. End joints should be staggered so that they are offset at least 12" from the end joints in adjacent rows. The units of insulation should fit snugly to adjoining units.
2. If Johns Manville DuraBoard insulation is utilized by itself or as the top layer of a multilayer insulation system, Dibiten smooth or granulated products may be heat welded directly to the Duraboard.
3. Insulation may be mechanically attached to metal gypsum, cementitious wood fiber or structural concrete decks. Insulation may be adhered with an Other roof insulation products can be used without DuraBoard if it is possible to mechanically attach a fiber glass base sheet through the insulation into the deck (metal, structural concrete, gypsum, cementitious wood fiber).
4. Where required, mechanically fasten a 19 3/4" 502 mm) wide piece of base ply through the insulation. The remaining base plies are to be applied full width

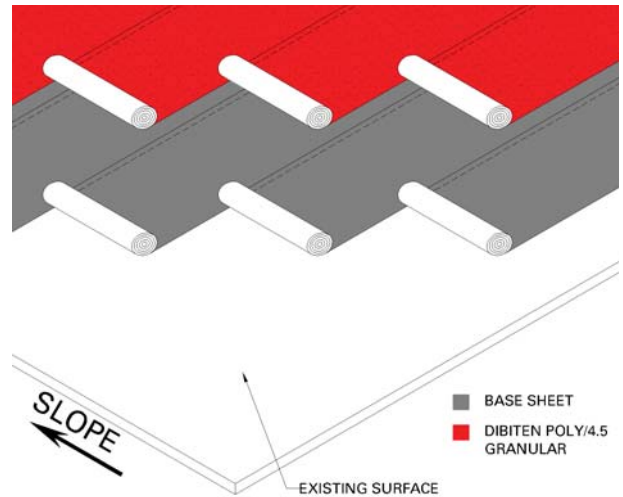

with 3" (76 mm) side and 4" (102 mm) end laps over the preceding sheets. Fasten the laps at 9" (229 mm) centers, and down the longitudinal center of each felt ply, place two rows of fasteners, with the rows spaced approximately 11" (279 mm) apart, and fasteners staggered on approximately 18" (457 mm) centers. Use fasteners appropriate to the insulation and deck.

##### Roofing Application:

1. Prepare surface to be roofed as described in Section 2.4, *Reroofing*, of this manual.
2. Starting at the low point of the roof, heat weld a full width piece of Dibiten Poly 4.5 or Poly 4.5 FR, so that it is firmly and uniformly set. Subsequent sheets are to be applied in the same manner, with 4" (102 mm) side and 6" (152 mm) end laps over the preceding sheets. All laps must be rolled with a 3" (76 mm) rounded edge roller. A 1/8" to 3/8" (3 mm to 10 mm) bleedout of compound shall be visible at the edge of all seams. All laps must be checked for good adhesion. Preparation of the 6" (152 mm) end lap requires scuffing away all loose granules. Heat and embed all remaining granules. Apply heat to the roll being seamed while making sure both have a good compound flow to adhere the two surfaces. End laps must be checked for proper adhesion.

## REROOFING SPECIFICATIONS

### Smooth Surfaced Roofs, Dibiten Poly/4, Two Ply Specification

#### Specification R405-2

##### Surface Types:

Smooth Surfaced Existing Roofs.

##### Insulation:

Insulation used in reroofing over existing smooth surfaced roofs is an option, not a requirement. Only rigid roof insulation compatible with Dibiten modified bitumen membranes should be used (see requirements in Insulation Application below). Dibiten membrane products may be adhered directly to Johns Manville DuraBoard. All other insulations require a fiber glass base sheet to be installed on top of the insulation before Dibiten products are installed. Expanded polystyrene may not be used unless it is sandwiched between two layers of perlite board.

##### Base Sheet:

U.L. approved type G-2 fiber glass base sheet (25 lbs. per 100 square feet or heavier), mechanically fastened.

##### Dibiten Poly/4, Dibiten Poly/5:

Smooth surfaced modified bitumen membrane, heat weld applied only.

##### Coating:

Dibiten recommends coating all non-granulated finished membranes. This is a requirement if the roof membrane is to be guaranteed. Use a solvent, acrylic or latex based coating compatible with modified bitumen systems. Application rates vary by manufacturer but should never be installed less than 1 gallon per 100 square feet. Coatings will enhance the life of the roof membrane but need to be maintained. Periodic recoating may be necessary. Recoating is the responsibility of the building owner.

##### Insulation/Base Sheet Application (Optional):

1. Install insulation units with long joints continuous. End joints should be staggered so that they are offset at least 12" from the end joints in adjacent rows. The units of insulation should fit snugly to adjoining units.
2. If Johns Manville DuraBoard insulation is utilized by itself or as the top layer of a multilayer insulation system, Dibiten smooth or granulated products may be heat welded directly to the Duraboard.
3. Insulation may be mechanically attached to metal gypsum, cementitious wood fiber or structural concrete decks. Insulation may be adhered with an appropriate cold adhesive to structural concrete, cementitious wood fiber and pre-cast concrete decks.

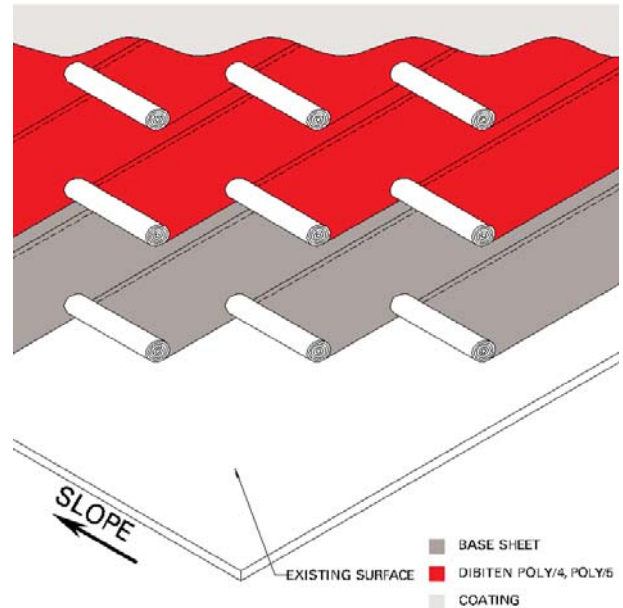

4. Other roof insulation products can be used without DuraBoard if it is possible to mechanically attach a fiber glass base sheet through the insulation into the deck (metal, structural concrete, gypsum, cementitious wood fiber).
5. Where required, mechanically fasten a 19 3/4" (502 mm) wide piece of base ply through the insulation. The remaining base plies are to be applied full width with 3" (76 mm) side and 4" (102 mm) end laps over the preceding sheets. Fasten the laps at 9" (229 mm) centers, and down the longitudinal center of each felt ply, place two rows of fasteners, with the rows spaced approximately 11" (279 mm) apart, and fasteners staggered on approximately 1/8" (457 mm) centers. Use fasteners appropriate to the insulation and deck.

##### Roofing Application:

1. Starting at the low edge of the roof, heat weld a 19 3/4" (502 mm) wide piece of Dibiten Poly/4 or Poly/5. The remaining sheets are to be applied full width, with 4" (102 mm) side and 6" (152 mm) end laps over the preceding sheets.
2. Starting at the low point of the roof, heat weld a full width piece of Poly/4 or Poly/5 so that it is firmly and uniformly set. Subsequent sheets are to be applied in the same manner, with 4" (102 mm) side and 6" (152 mm) end laps over the preceding sheets. All laps must be rolled with a 3" (76 mm) rounded edge roller. A 1/8" to 3/8" (3 mm to 10 mm) bleedout of compound shall be visible at the edge of all seams. All laps must be checked for good adhesions.
3. Apply finish coating.



# Specification & Application Manual

## Modified Bitumen Roofing Membranes

### REROOFING SPECIFICATIONS

Smooth Surfaced Roofs, Dibiten Poly/4.5,  
Two Ply Specifications

### Specification R455-2

#### Surface Types:

Smooth Surfaced Existing Roofs.

#### Insulation:

Insulation used in reroofing over existing smooth surfaced roofs is an option, not a requirement. Only rigid roof insulation compatible with Dibiten modified bitumen membranes should be used (see requirements in Insulation Application below). Dibiten membrane products may be adhered directly to Johns Manville DuraBoard. All other insulations require a fiber glass base sheet to be installed on top of the insulation before Dibiten products are installed. Expanded polystyrene may not be used unless it is sandwiched between two layers of perlite board.

#### Base Sheet:

U.L. approved type G-2 fiber glass base sheet (25 lbs. per 100 square feet or heavier), mechanically fastened.

#### Dibiten Poly/4, Poly/5:

Smooth surfaced modified bitumen membrane, heat weld applied only.

#### Dibiten Poly/4.5 Granular:

Granular (slate flake) surfaced modified bitumen membrane, heat weld applied only.

#### Roofing Application:

1. Prepare surface to be roofed as described in Section 2.4, *Reroofing*, of this manual.
2. Where required, mechanically fasten a 19 3/4" (502 mm) wide piece of base into the structural deck. The remaining base plies are to be applied full width at 9" (229 mm) centers, and down the longitudinal center of each felt ply. Place two rows of fasteners, with the rows spaced approximately 11" (279 mm) apart, and fasteners staggered on approximately 18" (457 mm) centers. Use fasteners appropriate to the insulation and deck.
3. Starting at the low edge of the roof, heat weld a 19 3/4" (502 mm) wide piece of Dibiten Poly/4 or Poly/5. The remaining sheets are to be applied full width, with 4" (102 mm) side and 6" (152 mm) end laps over the preceding sheets.

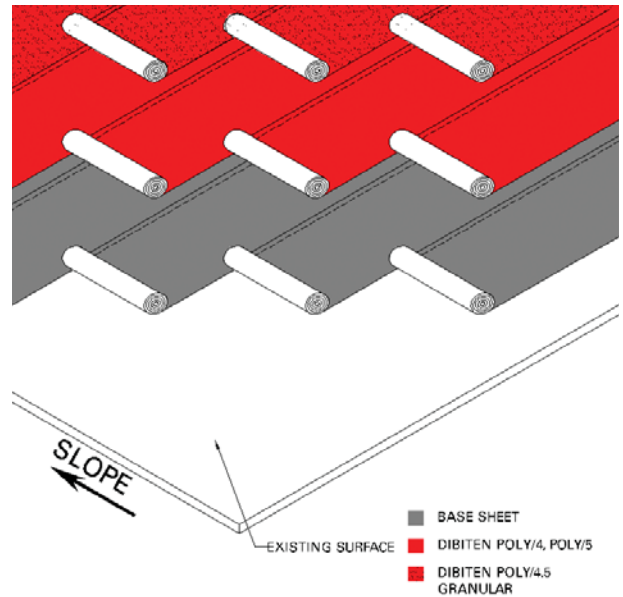

4. Starting at the low point of the roof heat, weld a full width piece of Dibiten Granular or Dibiten FR so that it is firmly and uniformly set. Subsequent sheets are to be applied in the same manner, with 4" (102 mm) side and 6" (152 mm) end laps over the preceding sheets. All laps must be rolled with a 3" (76 mm) rounded edge roller. A 1/8" to 3/8" (3 mm to 10 mm) bleedout of compound shall be visible at the edge of all seams. All laps must be checked for good adhesion.

## REROOFING SPECIFICATIONS

### Gravel Surfaced Roofs, Dibiten Poly/4, Poly/5

#### Specification R406

##### Surface Types:

Existing Gravel Roofs.

##### Insulation or Recovery Board:

Rigid roof insulation, minimum 1/2" must be installed over existing gravel surfaced roofs. If Johns Manville DuraBoard is used, the Dibiten membrane products may be adhered directly to Johns Manville DuraBoard. All other insulations require a fiber glass base sheet to be installed on top of the insulation before Dibiten products are installed. Expanded polystyrene may not be used unless it is sandwiched between two layers of perlite board.

##### Base Sheet:

U.L. approved type G-2 fiber glass base sheet (25 lbs. per 100 square feet or heavier), mechanically fastened.

##### Dibiten Poly/4, Poly/5:

Smooth surfaced modified bitumen membrane, heat weld applied only.

##### Coating:

Dibiten recommends coating all non-granulated finished membranes. This is a requirement if the roof membrane is to be guaranteed. Use a solvent, acrylic or latex based coating compatible with modified bitumen systems. Application rates vary by manufacturer but should never be installed less than 1 gallon per 100 square feet. Coatings will enhance the life of the roof membrane but need to be maintained. Periodic recoating may be necessary. Recoating is the responsibility of the building owner.

##### Insulation Application

1. Install insulation units with long joints continuous. End joints should be staggered so that they are offset at least 12" from the end joints in adjacent rows. The units of insulation should fit snugly to adjoining units.
2. If Johns Manville DuraBoard insulation is utilized by itself or as the top layer of a multilayer insulation system, Dibiten smooth or granulated products may be heat welded directly to the DuraBoard.
3. Insulation may be mechanically attached to metal, gypsum, cementitious wood fiber or structural concrete decks. Insulation may be adhered with an appropriate cold adhesive to structural concrete, cementitious wood fiber and pre-cast concrete.
4. Other roof insulation products can be used without DuraBoard if it is possible to mechanically attach a fiber glass base sheet through the insulation into the

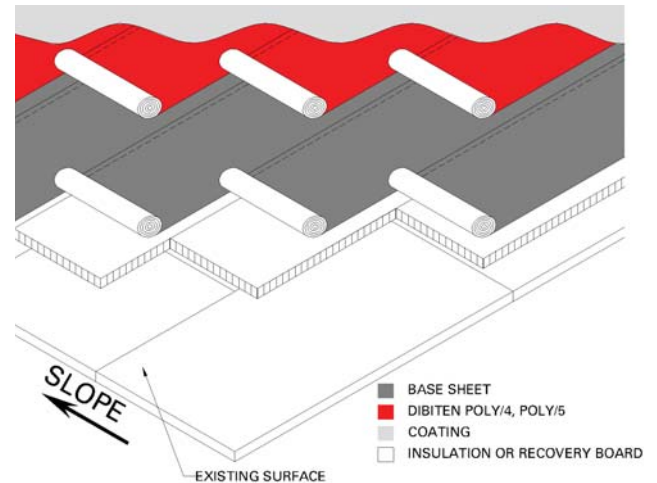

deck (metal, structural concrete, gypsum, cementitious wood fiber).

5. Where required, mechanically fasten a 19 3/4" (502 mm) wide piece of base ply through the insulation. The remaining base plies are to be applied full width with 3" (76 mm) side and 4" (102 mm) end laps over the preceding sheets. Fasten the laps at 9" (229 mm) centers, and down the longitudinal center of each felt ply. Place two rows of fasteners, with the rows spaced approximately 11" (279 mm) apart, and fasteners staggered on approximately 1/8" (457 mm) centers. Use fasteners appropriate to the insulation and deck.

##### Roofing Application

1. Prepare surface to be roofed as described in Section 2.4, *Reroofing*, of this manual. Existing gravel must be removed.
2. Starting at the low edge of the roof, heat weld a 19 3/4" (502 mm) wide piece of Dibiten Poly/4 or Poly/5. The remaining sheets are to be applied full width, with 4" (102 mm) side and 6" (152 mm) end laps over the preceding sheets.
3. Starting at the low point of the roof heat, weld a full width piece of Poly/4 or Poly/5 so that it is firmly and uniformly set. Subsequent sheets are to be applied in the same manner, with 4" (102 mm) side and 6" (152 mm) end laps over the preceding sheets. All laps must be rolled with a 3" (76 mm) rounded edge roller. A 1/8" to 3/8" (3 mm to 10 mm) bleedout of compound shall be visible at the edge of all seams. All laps must be checked for good adhesions.
4. Apply finish coating.



# Specification & Application Manual

## Modified Bitumen Roofing Membranes

### REROOFING SPECIFICATIONS

#### Gravel Surfaced Roofs, Dibiten Poly/4.5 Granular

### Specification R456

#### Surface Types:

Existing Gravel Roofs.

#### Insulation or Recovery Board:

Rigid insulation or recovery board, minimum 1/2" must be installed over existing gravel surfaced roofs. If Johns Manville DuraBoard is used, the Dibiten membrane may be installed directly to the insulation. All other insulations require a fiber glass base sheet to be installed on top of the insulation before Dibiten products are used. Expanded polystyrene may not be used unless it is sandwiched between two layers of perlite board.

#### Base Sheet:

U.L. approved type G-2 fiber glass base sheet (25 lbs. per 100 square feet or heavier), mechanically fastened.

#### Dibiten Poly/4.5 Granular:

Granular (slate flake) surfaced modified bitumen membrane, heat weld applied only.

#### Insulation Application:

1. Install insulation units with long joints continuous. End joints should be staggered so that they are offset at least 12" from the end joints in adjacent rows. The units of insulation should fit snugly to adjoining units.
2. If Johns Manville DuraBoard insulation is utilized by itself or as the top layer of a multilayer insulation system, Dibiten smooth or granulated products may be heat welded directly to the DuraBoard
3. Insulation may be mechanically attached to metal, gypsum, cementitious wood fiber or structural concrete decks. Insulation may be adhered with an appropriate cold adhesive to structural concrete, cementitious wood fiber and pre-cast concrete.
4. Other roof insulation products can be used without DuraBoard if it is possible to mechanically attach a fiber glass base sheet through the insulation into the deck (metal, structural concrete, gypsum, cementitious wood fiber).
5. Where required, mechanically fasten a 19 3/4" (502 mm) wide piece of base ply through the insulation. The remaining base plies are to be applied full width with 3" (76 mm) side and 4" (102 mm) end laps over the preceding sheets. Fasten the laps at 9" (229 mm) centers, and down the longitudinal center of each

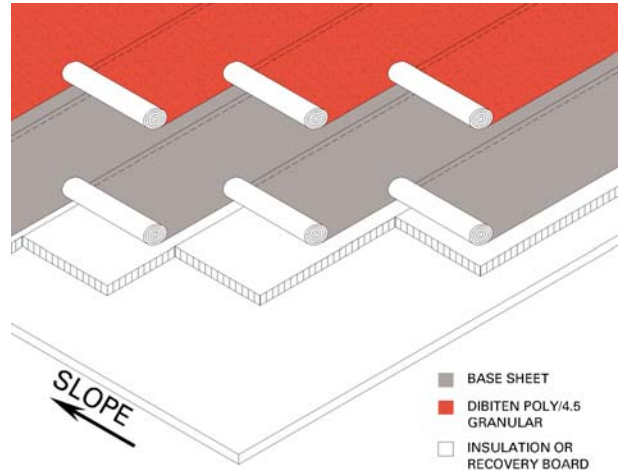

felt ply. Place two rows of fasteners, with the rows spaced approximately 11" (279 mm) apart, and fasteners staggered on approximately 1/8" (457 mm) centers. Use fasteners appropriate to the insulation and deck.

#### Roofing Application:

1. Prepare surface to be roofed as described in Section 2.4, *Reroofing*, of this manual. Existing gravel must be removed.
2. Starting at the low point of the roof, heat weld a full width piece of Dibiten Poly 4.5 or Poly 4.5 FR, so that it is firmly and uniformly set. Subsequent sheets are to be applied in the same manner, with 4" (102 mm) side and 6" (152 mm) end laps over the preceding sheets. All laps must be rolled with a 3" (76 mm) rounded edge roller. A 1/8" to 3/8" (3 mm to 10 mm) bleedout of compound shall be visible at the edge of all seams. All laps must be checked for good adhesion. Preparation of the 6" (152 mm) end lap requires scuffing away all loose granules. Heat and embed all remaining granules. Apply heat to the roll being seamed while making sure both have a good compound flow to adhere the two surfaces. End laps must be checked for proper adhesion

## REROOFING SPECIFICATIONS

### Gravel Surfaced Roofs, Dibiten Poly/4, Poly/5 Two Ply Specifications

#### Specification R406-2

##### Surface Types:

Existing Gravel Roofs.

##### Insulation or Recovery Board:

Rigid insulation or recovery board, minimum 1/2" must be installed over existing gravel surfaced roofs. If Johns Manville DuraBoard is used, the Dibiten membrane may be installed directly to the insulation. All other insulations require a fiber glass base sheet to be installed on top of the insulation before Dibiten products are used. Expanded polystyrene may not be used unless it is sandwiched between two layers of perlite board.

##### Base Sheet:

U.L. approved type G-2 fiber glass base sheet (25 lbs. per 100 square feet or heavier), mechanically fastened.

##### Dibiten Poly/4, Poly/5:

Smooth surfaced modified bitumen membrane, heat weld applied only.

##### Coating:

Dibiten recommends coating all non-granulated finished membranes. This is a requirement if the roof membrane is to be guaranteed. Use a solvent, acrylic or latex based coating compatible with modified bitumen systems. Application rates vary by manufacturer but should never be installed less than 1 gallon per 100 square feet. Coatings will enhance the life of the roof membrane but need to be maintained. Periodic recoating may be necessary. Recoating is the responsibility of the building owner.

##### Insulation Application:

1. Install insulation units with long joints continuous. End joints should be staggered so that they are offset at least 12" from the end joints in adjacent rows. The units of insulation should fit snugly to adjoining units.
2. If Johns Manville DuraBoard insulation is utilized by itself or as the top layer of a multilayer insulation system, Dibiten smooth or granulated products may be heat welded directly to the DuraBoard
3. Insulation may be mechanically attached to metal, gypsum, cementitious wood fiber or structural concrete decks. Insulation may be adhered with an appropriate cold adhesive to structural concrete, cementitious wood fiber and pre-cast concrete.
4. Other roof insulation products can be used without DuraBoard if it is possible to mechanically attach a

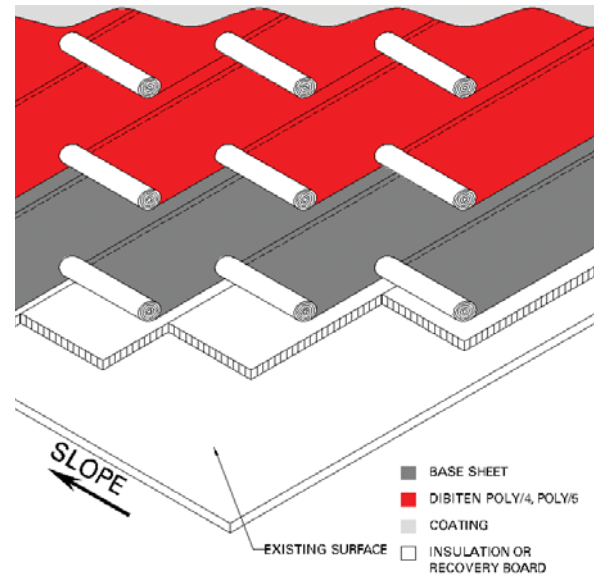

fiber glass base sheet through the insulation into the deck (metal, structural concrete, gypsum, cementitious wood fiber).

5. Where required, mechanically fasten a 19 3/4" (502 mm) wide piece of base ply through the insulation. The remaining base plies are to be applied full width with 3" (76 mm) side and 4" (102 mm) end laps over the preceding sheets. Fasten the laps at 9" (229 mm) centers, and down the longitudinal center of each felt ply. Place two rows of fasteners, with the rows spaced approximately 11" (279 mm) apart, and fasteners staggered on approximately 1/8" (457 mm) centers. Use fasteners appropriate to the insulation and deck.

#### Roofing Application

1. Prepare surface to be roofed as described in Section 2.4, *Reroofing*, of this manual. Existing gravel must be removed.
2. Starting at the low edge of the roof, heat weld a 19 3/4" (502 mm) wide piece of Dibiten Poly/4 or Poly/5. The remaining sheets are to be applied full width, with 4" (102 mm) side and 6" (152 mm) end laps over the preceding sheets.
3. Starting at the low point of the roof heat, weld a full width piece of Poly/4 or Poly/5 so that it is firmly and uniformly set. Subsequent sheets are to be applied in the same manner, with 4" (102 mm) side and 6" (152 mm) end laps over the preceding sheets. All laps must be rolled with a 3" (76 mm) rounded edge roller. A 1/8" to 3/8" (3 mm to 10 mm) bleedout of compound shall be visible at the edge of all seams. All laps must be checked for good adhesions.
4. Apply finish coating.

# Specification & Application Manual

## Modified Bitumen Roofing Membranes

### REROOFING SPECIFICATIONS

Gravel Surfaced Roofs, Dibiten Poly/4 & Poly/4.5, Two Ply Specification

#### Specification R456-2 Specification R456-2 FR

##### Surface Types:

Existing Gravel Roofs

##### Insulation or Recovery Board:

Rigid insulation or recovery board, minimum 1/2" thick, must be installed over existing gravel surfaced roofs. If Johns Manville DuraBoard is used, the Dibiten membrane may be installed directly to the insulation. All other insulations require a fiber glass base sheet to be installed on top of the insulation before Dibiten products are used. Expanded polystyrene may not be used unless it is sandwiched between two layers of perlite board.

##### Base Sheet:

U.L. approved type G-2 fiber glass base sheet (25 lbs. per 100 square feet or heavier), mechanically fastened.

##### Dibiten Poly/4, Poly/5:

Smooth surfaced modified bitumen membrane, heat weld applied only.

##### Dibiten Poly/4.5 Granular:

Granular (slate flake) surfaced modified bitumen membrane, heat weld applied only.

##### Insulation Application:

1. Install insulation units with long joints continuous. End joints should be staggered so that they are offset at least 12" from the end joints in adjacent rows. The units of insulation should fit snugly to adjoining units.
2. If Johns Manville DuraBoard insulation is utilized by itself or as the top layer of a multilayer insulation system, Dibiten smooth or granulated products may be heat welded directly to the DuraBoard
3. Insulation may be mechanically attached to metal, gypsum, cementitious wood fiber or structural concrete decks. Insulation may be adhered with an appropriate cold adhesive to structural concrete, cementitious wood fiber and pre-cast concrete.
4. Other roof insulation products can be used without DuraBoard if it is possible to mechanically attach a fiber glass base sheet through the insulation into the deck (metal, structural concrete, gypsum, cementitious wood fiber).

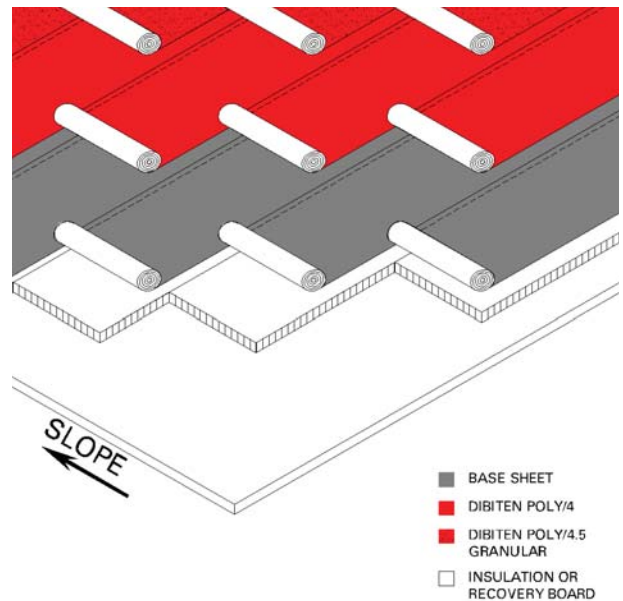

5. Where required, mechanically fasten a 19 3/4" (502 mm) wide piece of base ply through the insulation. The remaining base plies are to be applied full width with 3" (76 mm) side and 4" (102 mm) end laps over the preceding sheets. Fasten the laps at 9" (229 mm) centers, and down the longitudinal center of each felt ply. Place two rows of fasteners, with the rows spaced approximately 11" (279 mm) apart, and fasteners staggered on approximately 1/8" (457 mm) centers. Use fasteners appropriate to the insulation and deck.

##### Roofing Application:

1. Prepare surface to be roofed as described in Section 2.4, *Reroofing*, of this manual. Existing gravel must be removed.
2. Starting at the low edge of the roof, heat weld a 19 3/4" (502 mm) wide piece of Dibiten Poly/4 or Poly/5. The remaining sheets are to be applied full width, with 4" (102 mm) side and 6" (152 mm) end laps over the preceding sheets.
3. Starting at the low point of the roof heat, weld a full width piece of Dibiten Granular or Dibiten FR so that it is firmly and uniformly set. Subsequent sheets are to be applied in the same manner, with 4" (102 mm) side and 6" (152 mm) end laps over the preceding sheets. All laps must be rolled with a 3" (76 mm) rounded edge roller. A 1/8" to 3/8" (3 mm to 10 mm) bleedout of compound shall be visible at the edge of all seams. All laps must be checked for good adhesion. Preparation of the 6" (152 mm) end lap requires scuffing away all loose granules. Heat and embed all remaining granules. Apply heat to the roll being seamed while making sure both have a good compound flow to adhere the two surfaces. End laps must be checked for proper adhesion.

### 6.3 GENERAL WATERPROOFING

#### Introduction

Dibiten smooth surfaced membranes are as ideally suited for general waterproofing purposes as they are for roofing uses.

Generally, the method of application and flashing details are the same as for roofing.

The differences may lie in the requirement for a protective layer of roofing paper between the Dibiten membrane and the fill to be used, and in the possible requirement for more than one layer of Dibiten membrane.

Because the Dibiten membrane will not be accessible after installation, proper installation of the membrane is critical for long term performance.

Information regarding waterproofing specifications not listed in this manual can be obtained by contacting Dibiten technical department. The technical manager will review and assess the requirements of a particular project on an individual basis.

Listed on the following pages are some of the more common waterproofing specifications requested for Dibiten smooth surfaced membrane (Dibiten Poly/4 or Poly/5).

- General Information for Roof Decks
- Specification for Shower Pan & Sub-Flooring
- Specification for Planter Boxes & Roof Gardens
- Specification for Concrete or Asphalt Base Sheet (ex: Parking Decks, Bridges, Highways, Viaducts)
- Specification for Below-Grade Waterproofing (ex: Foundations)
- Specification for Between-Slab Waterproofing (ex: Water Reservoirs)

### GENERAL WATERPROOFING

#### Specification for Roof Decks

The following guidelines apply to any situation in which the deck is to be used as a walkway:

1. Only Dibiten Poly/4 or Dibiten Poly/5 smooth surfaced heat welded modified bitumen membranes are to be used.
2. Depending on the deck type, the membrane should be applied as in standard roofing specifications.
3. Two plies of the Dibiten membrane are recommended instead of one\*.
4. The surface of the installed Dibiten membrane must be protected. Apply a minimum 11 lb. fiber glass ply sheet, loose laid over the membrane prior to installation of non-penetrating paving tiles or similar decking. Concrete can be poured directly over the loose laid ply sheet. If indoor/outdoor carpeting is to be installed over the Dibiten membrane, the fiber glass ply sheet is not required. If a deck is to be constructed over the Dibiten membrane using wood sleepers (supports), an extra strip (min. 9" wide of Dibiten Poly/4 must be installed (heat welded) under all sleepers wherever they come into contact with the Dibiten membrane. No penetrations (punctures) to the Dibiten membrane can be made.

\*If Poly/4 is used, two plies are required. If Poly/5 is used, one ply is acceptable providing it is Poly/5 reinforced with 250 gr/sq polyester (special order required).

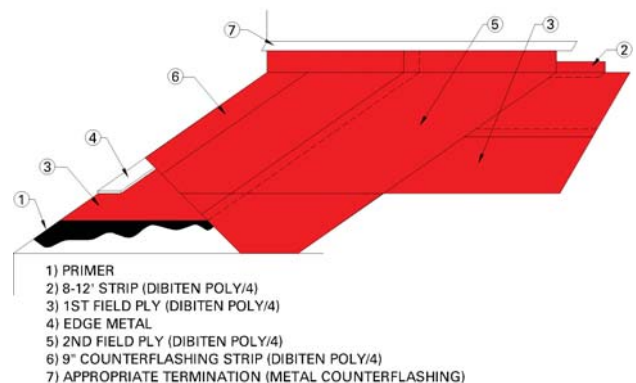

**Note: STEP 8, not shown, is the installation of walking deck surfacing such as tiles, heavy duty outdoor carpeting, or similar appropriate materials suitable for protecting the Dibiten membrane from puncture. (A loose laid ply sheet (such as 11 lb. fiber glass) is required between the 2nd layer of Poly/4 and the decking material unless outdoor carpeting is used, in which case a water-based adhesive compatible with the Dibiten membrane must be used).**



# Specification & Application Manual

## Modified Bitumen Roofing Membranes

### GENERAL WATERPROOFING

#### Specification for Shower Pan & Sub-Flooring

**Material:** Dibiten Poly/4 or Dibiten Poly/5 smooth surfaced modified bitumen membrane, heat welded.

**Deck Type:** Wood or Concrete

##### General Guidelines:

1. Concrete decks must be thoroughly cured and primed with concrete primer.
2. Wood decks require a minimum G-2 base sheet mechanically fastened to the deck prior to installation of the waterproofing.
3. Apply one layer of Dibiten Poly/4 or Dibiten Poly/5 modified bitumen membrane, fully adhered (heat welded), overlapping side laps 4" and end laps 6" as in standard roofing procedures and specifications.
4. At corners, flashing areas, and drain, apply two layers of the Dibiten membrane as illustrated in the Detail Drawings section of this manual.
5. Over the Dibiten membrane, loose lay a minimum 11 lb. fiber glass ply sheet before applying the shower pan or sub floor.

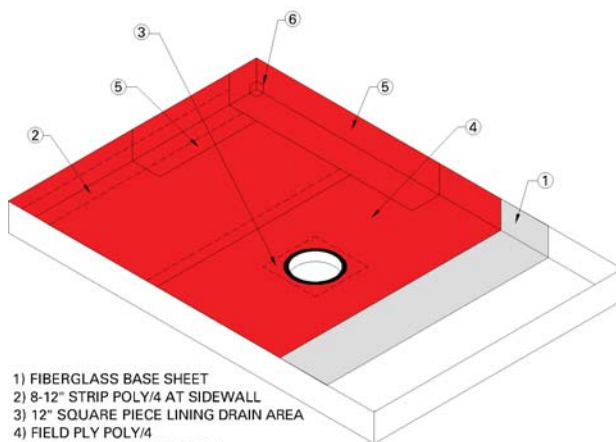

- 1) FIBERGLASS BASE SHEET
- 2) 8-12" STRIP POLY/4 AT SIDEWALL
- 3) 12" SQUARE PIECE LINING DRAIN AREA
- 4) FIELD PLY POLY/4
- 5) COUNTERFLASHING POLY/4
- 6) CORNER PIECE POLY/4

### GENERAL WATERPROOFING

#### Specification for Planter Box or Roof Garden

**Material:** Dibiten Poly/4 or Dibiten Poly/5 Smooth Surfaced Modified Bitumen Membrane, heat welded.

##### General Guidelines:

1. The Dibiten membrane should be applied fully adhered as in standard roofing and waterproofing procedure, observing all application requirements as outlined in the roofing sections of this manual. This includes flashing details such as corners, parapets, and drains, and the membrane application must observe the minimum 4" side lap and 6" end lap rule. Planter box or roof garden should allow for adequate drainage.
2. Two layers of Dibiten membrane are required instead of one. The Dibiten membrane counterflashing must extend above the level of the soil surface (min. 6") and be properly terminated with appropriate metal counterflashing, if walls are not completely covered with membrane.
3. Over the Dibiten membrane, a layer of polyester nonwoven fabric should be loose laid, including over the parapets. The outer surface of the membrane may be heat welded lightly at the parapets to adhere the polyester felt. The felt protects the membrane from the stone or aggregate and acts as a filter between the soil, stone and the Dibiten membrane.
4. Over the polyester felt, 4-6 "diameter smooth, river bottom stone or a layer of LECA (light expanded clay aggregate) should be laid into the bed of the planter. This acts as a drainage layer.
5. A second layer of the polyester felt should be applied over the loose laid stone.
6. Apply the appropriate type of soil fill according to the type of planting to be done.



**GENERAL WATERPROOFING**

**Specification for Concrete or Asphalt Base Sheet (ex: Parking Decks, Highways, Bridges, Viaducts)**

**Material:** Dibiten Poly/5\* smooth surfaced modified bitumen membrane, heat welded.

**Deck Type:** Wood or Concrete

**General Guidelines:**

1. If surface to be covered is concrete, apply an appropriate primer and allow primer to dry thoroughly.
2. If surface to be covered is wood or if insulation is to be installed, securely fasten one layer of fiber glass base sheet, type G-2 to the substrate, as in roofing procedure.
3. Apply the Dibiten membrane, fully adhered as in standard roofing specifications, overlapping side laps 4" and end laps 6" and using two plies at any flashing areas, as outlined in the *Flashing Details* section of this manual.
4. If concrete is to be the topping, apply a minimum 11 lb. fiber glass felt or a minimum 15 lb. organic felt, loose laid, over the Dibiten membrane. If paving asphalt is to be installed, an appropriate base sheet suitable for use with paving asphalt must be used.
5. Pour concrete or apply paving asphalt.

**\*Dibiten Poly/5 reinforced with 250 gr/sq polyester fabric is required for this application. Two layers of Dibiten Poly/4 may be substituted for the one layer of Dibiten Poly/5.**

- 1) PRIMER
- 2) 8-12" STRIP (DIBITEN POLY/4) AT SIDEWALLS
- 3) 1ST FIELD PLY (DIBITEN POLY/4)
- 4) 1ST COUNTERFLASH (DIBITEN POLY/4) AT WALL
- 5) 2ND FIELD PLY (DIBITEN POLY/4)
- 6) 2ND WALL COUNTERFLASHING (DIBITEN POLY/4)
- 7) METAL CAP
- 8) APPROPRIATE METAL TERMINATION (COUNTERFLASHING)
- 9) LOOSE-LAID 11 LB. OR 15 LB. OR OTHER APPROPRIATE UNDERLAYMENT
- 10) PAVING ASPHALT OR CONCRETE

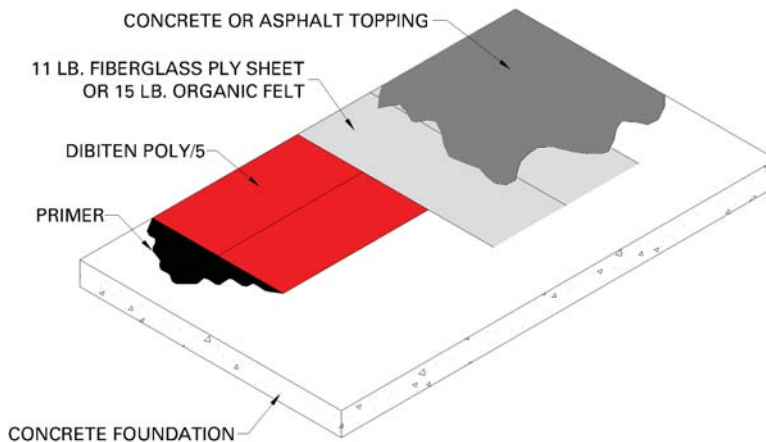
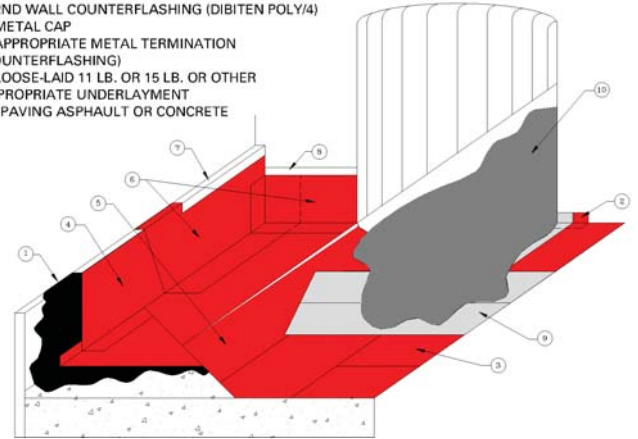

# Specification & Application Manual

## Modified Bitumen Roofing Membranes

### GENERAL WATERPROOFING

#### Specification for Below-Grade Waterproofing (ex: Foundations)

**Material:** Dibiten Poly/4 or Dibiten Poly/5 smooth surfaced modified bitumen membrane, heat weld applied only.

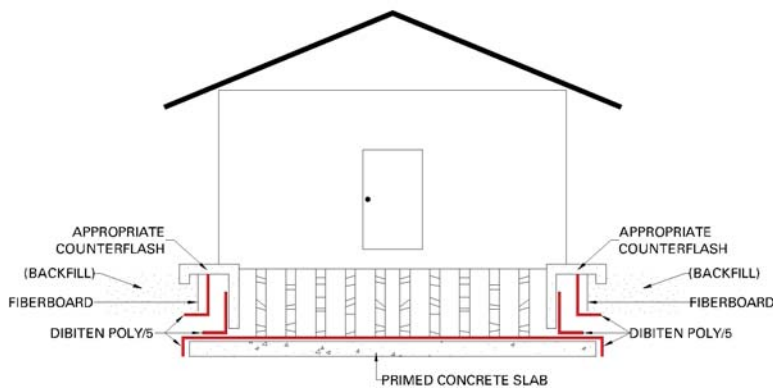

**Example Above: Below-Grade Waterproofing (ex: Foundations)**

#### Application:

1. Surface should be smooth, clean and free of any debris.
2. Prime all masonry, concrete, or metal to which the Dibiten membrane is to be applied.
3. Heat weld apply the Dibiten Poly/4 or Poly/5 into place. Fully adhere the membrane and counterflash using Dibiten membrane as in roofing procedures.
4. Maintain a minimum 1/4" outward flow of melted bitumen from the overlapped side and end laps (4" side laps and 6" end laps are required as per roofing specifications).
5. Heat weld and trowel all seams.
6. A protection course (ridge board, fiberboard, etc. is to be applied before the backfill is installed).

### GENERAL WATERPROOFING

#### Specification for Between-Slab Waterproofing (ex: Water Reservoirs)

**Dibiten Poly/4 or Dibiten Poly/5 smooth surfaced modified bitumen membrane, heat welded only.**

#### Application:

1. Concrete must be primed using suitable primer and primer must be allowed to thoroughly dry.
2. Apply the Dibiten membrane using the heat welded method of application, following the same procedures for installation, flashing details, and terminations as for roofing procedure (see Applications section of the Specifications and Applications Manual). If Dibiten Poly/4 is used, two plies are required. If Dibiten Poly/5 is used, one ply is sufficient provided it is Poly/5 reinforced with 250 gr/sq polyester.

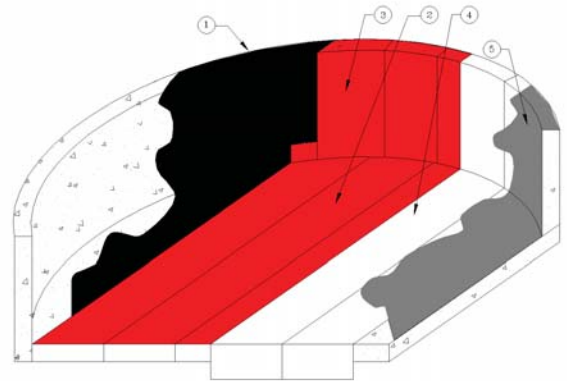

- 1) PRIMER
- 2) DIBITEN POLY/5 (250gr/sq POLYESTER REINFORCED) FIELD PLY
- 3) DIBITEN POLY/5 (250gr/sq POLYESTER REINFORCED) COUNTERFLASHING
- 4) LOOSE-LAID PLY SHEET
- 5) CONCRETE TOPPING

**Example Above: Between-Slab Waterproofing (ex: Water Reservoirs)**

3. Install a loose laid ply sheet such as 11 lb. fiber glass ply sheet. The Dibiten material may be heat welded very lightly to tack the ply sheet if necessary.
4. Install the top surfacing of concrete and any top coating required.

**Note:** Detail drawing illustrates waterproofing aspects only - does not address construction, reinforcement, or safeproofing (for drinkability) etc. The treatment of the inside of tanks and reservoirs is dependent upon the type of liquid they will contain. All applicable government health, safety and construction codes must be observed and are the responsibility of the construction contractor.



6.4 U.L. LISTED SPECIFICATIONS

Single Ply Membrane Systems

Unless otherwise specified, the insulation and base sheet are mechanically fastened to the deck. The membrane is heat fused in place.

Class A- Ballasted

- 1. **Deck:** NC **Incline:** 1/2  
**Membrane:** "Dibiten Poly 4.5" (modified bitumen)  
**Surfacing:** River bottom stone, 3/4 to 1-1/2 in., diam., 1000 lb./sq.
- 2. **Deck:** NC **Incline:** 2  
**Insulation (Optional):** Any UL Classified (except polystyrene), any thickness.  
**Base Sheet:** Type 15, G1 or G2, or vented base sheet mechanically fastened or hot mopped.  
**Membrane:** "Dibiflex S", "Dibiflex Supra S" or "Dibiflex 170", heat fused or hot mopped in place.  
**Surfacing:** Gravel, laid loosely or embedded in hot roofing asphalt or any UL Classified emulsion. Emulsion applied at 4-5- gal./sq.

Class B - Ballasted

- 1. **Deck:** NC **Incline:** 1/2  
**Membrane:** "Dibiten Poly/4.5" (modified bitumen)  
**Surfacing:** Gravel at 4000 lbs./sq., loose laid
- 2. **Deck:** C 15/32 **Incline:** 2  
**Base Sheet:** Type G2  
**Membrane:** "Dibiten Poly/4.5" or "Dibiten Poly/4" (modified bitumen.)  
**Surfacing:** River bottom stone, 1/2 to 2-1/2 in. diam., 1000 lb./sq.

Class A - Fully Adhered

- 1. **Deck:** NC **Incline:** 1/2  
**Base Sheet (Optional):** One or two plies Type G2, nailed or hot mopped  
**Membrane:** One or more plies "Dibiten Poly/4", "Dibiten Poly/4.5" or "Dibiten Poly/5" (modified bitumen), heat fused.  
**Surfacing:** Karnak "No. 97 Fibrated Aluminum Asphalt Roof Coating" at 1 gal./sq., "APOC 400" at 2 gal./sq., Monsey Products "Weather Check Aluminum Roof Coating" at 1 1/2 gal./sq. or Industrial Research Development "Rhino-Hide T-Cote A" at 2 gal./sq.
- 2. Deleted.
- 3. **Deck:** NC **Incline:** 1  
**Base Sheet:** (Optional): One or two plies Type G2, nailed or hot mopped.  
**Membrane:** One or more plies "Dibiten Poly/4", "Dibiten Poly/4.5" or "Dibiten Poly/5" (modified bitumen), heat fused.  
**Surfacing:** Kokem Products "Sungard Acrylic Latex Roof Coating", 1 gal./sq., 2 coats.
- 4. **Deck:** NC **Incline:** 1/2  
**Insulation (Optional):** Polystyrene, polyisocyanurate,

polyurethane, perlite/polyisocyanurate composite, perlite, wood fiber, glass fiber or phenolic, no max thickness.

**Base Sheet:** Type G2.

**Membrane:** One or more plies "Dibiten Poly/4", "Dibiten Poly/4.5" or "Dibiten Poly/5" (modified bitumen), heat fused.

**Surfacing:** Celotex "FR Bright and White Coating", 0.75 gal./sq., 2 coats.

- 5. **Deck:** NC **Incline:** 1/2  
**Insulation:** Insulation (Optional): Polystyrene, polyisocyanurate, polyurethane, perlite/polyisocyanurate composite, perlite, wood fiber, glass fiber or phenolic, no max thickness.

**Base Sheet:** Type G2.

**Membrane:** One or more plies "Dibiten Poly/4", "Dibiten Poly/4.5" or "Dibiten Poly/5" (modified bitumen), heat fused.

**Surfacing:** Monsey Products "Aqua-Brite Aluminum Asphalt Emulsion", 1.5 gal./sq.

- 6. **Deck:** NC **Incline:** 1/2  
**Insulation:** (Optional): Polystyrene, polyisocyanurate, polyurethane, perlite/polyisocyanurate composite, perlite, wood fiber, glass fiber or phenolic, no maximum thickness.

**Base Sheet:** Type G2.

**Membrane:** One or more plies "Dibiten Poly/4", "Dibiten Poly/4.5" or "Dibiten Poly/5" (modified bitumen), heat fused.

**Base Coat:** "Neste-Thermo 202HS", 1.5 gal./sq.

**Surfacing:** "Neste-Thermo Super Prep II", 1.5 gal./sq.

- 7. **Deck:** NC **Incline:** 1/2  
**Base Sheet:** (Optional): Type G2.  
**Membrane:** One or more plies "Dibiten Poly/4", "Dibiten Poly/4.5" or "Dibiten Poly/5" (modified bitumen), heat fused.

**Surfacing:** Celotex "FR Bright and White Coating", 0.75 gal./sq., 2 coats.

- 8. **Deck:** NC **Incline:** 1/2  
**Base Sheet:** (Optional): Type G2.  
**Membrane:** One or more plies "Dibiten Poly/4", "Dibiten Poly/4.5" or "Dibiten Poly/5" (modified bitumen), heat fused.

**Surfacing:** Monsey Products "Aqua-Brite Aluminum Asphalt Emulsion", 1.5 gal./sq.

- 9. **Deck:** NC **Incline:** 1/2  
**Base Sheet (Optional):** Type G2.  
**Membrane:** One or more plies "Dibiten Poly/4", "Dibiten Poly/4.5" or "Dibiten Poly/5" (modified bitumen), heat fused.

**Base Coat:** "Neste-Thermo 202HS", 1.5 gal./sq.

**Surfacing:** "Neste-Thermo Super Prep II", 1.5 gal./sq.

# Specification & Application Manual

## Modified Bitumen Roofing Membranes

---

- 10. Deck: C-15/32                      Incline: 1/2**  
**Base Sheet:** Two plies G2, "PP 28", "GlasBase" or "DibiGlass Base", mechanically fastened or hot mopped.  
**Membrane:** "Dibiten Poly 4.5 FR" (modified bitumen), heat welded.

### Class B - Fully Adhered

- 1. Deck: C15/32                      Incline: 1/2**  
**Base Sheet:** Two plies Type G2 (Johns Manville or Owens-Corning), nailed or hot mopped.  
**Membrane:** One or more plies "Dibiten Poly/4", "Dibiten Poly/4.5" or "Dibiten Poly/5" (modified bitumen), heat fused.  
**Surfacing:** Karnak "No. 97 Fibrated Aluminum Asphalt Roof Coating" at 1 gal./sq. "APOC 400" at 2 gal./sq., Monsey products "Weather Check Aluminum Roof Coating", at 1 1/2 gal./sq. or Industrial Research Development "rhino-Hide Ti Cote A" at 2 gal./sq.
- 2. Deck: C-15/32                      Incline: 1/2**  
**Base Sheet:** Two plies Type G2, nailed or hot mopped in place.  
**Membrane:** One or more plies "Dibiten Poly/4", "Dibiten Poly/4.5", or "Dibiten Poly/5" (modified bitumen), heat fused.  
**Surfacing:** Fields "Fields F600 FlameBloc ModFit Fibrated Aluminum Roof Coating" at 1-1/2 gal./sq.

### Class C- Fully Adhered

- 1. Deck: 15/32                      Incline: 1**  
**Base Sheet:** One ply Type G2, mechanically fastened.  
**Membrane:** One or two plies "Dibiten Poly/4", or "Dibiten Poly/4.5" (modified bitumen), heat fused.

**7.1 GUARANTEES Warranty Registration Information** (Please Print or Type)

Building Name \_\_\_\_\_

Building Address \_\_\_\_\_  
 (City) (State) (Zip)

Building Principal Use \_\_\_\_\_

Owner's Name \_\_\_\_\_ Owner's Telephone ( ) \_\_\_\_\_

Owners Address \_\_\_\_\_  
 (City) (State) (Zip)

Owners Signature \_\_\_\_\_

Contractor's Name \_\_\_\_\_ Owner's Telephone ( ) \_\_\_\_\_

Contractor's Address \_\_\_\_\_  
 (City) (State) (Zip)

Contractor's Signature \_\_\_\_\_

From whom purchased (distributor) \_\_\_\_\_

Job Completion Date \_\_\_\_/\_\_\_\_/\_\_\_\_ Number of rolls used \_\_\_\_\_

**Dibiten Membrane Applied:**

**12 Year**

- Dibiten Poly/4,  
Poly 4.5 Slate or  
Poly 4.5 FR

**15 Year**

- Dibiten Poly/5™

**20 Year (2 Ply Systems only)**

- Dibiten Base Ply  
Poly/4
- Dibiten Ply Sheet  
Poly/4, Poly/4.5 Slate  
or Poly/4.5 FR

All smooth surfaced Dibiten products must have approved coating.

To validate this warranty all information on this form must be completed and mailed within ten (10) days of job completion to:

**Dibiten Roofing Systems  
 Guarantee Services Unit  
 P.O. Box 625005  
 Littleton, CO 80162  
 (800) 922-5922**

DIBITEN, warrants to the original building owner that, subject to the conditions herein set forth, the Dibiten Modified Bitumen Membrane ("the Membrane") identified herein is free from manufacturing defects which will result in a leak and that the Membrane will not deteriorate due to weathering so that it becomes incapable of maintaining a watertight roofing system. If, in fact, manufacturing defects result in leaks, Dibiten will, during the warranty period and subject to the conditions set forth below, make repairs or cause repairs to be made to the Membrane, or will replace the same (exclusive of non-Dibiten flashing, or other materials used as a roof base over which the Membrane is applied and repairs required by defects therein) as required to prevent leaks in the roof resulting from such manufacturing defects.

**Extent of Dibiten Liability:** The maximum liability of Dibiten shall be limited to repair or replacement of that portion of the membrane containing a manufacturing defect which has resulted in leaks. Dibiten's maximum liability over the term of this warranty is \$100.00 inclusive of both labor and material for each installed roofing square (100 ft<sup>2</sup>) of Dibiten Roofing Membrane. The warranty term shall commence on the date of the completion of the application of the Membrane. Dibiten is not responsible for any cost related to the removal or replacement of any non-Dibiten products present in the roof to which the Dibiten product is applied.

Retain this limited warranty, the roofing contractors invoice and any other documents regarding your roof.



## Specification & Application Manual

### Modified Bitumen Roofing Membranes

---

#### 8.1 TECHNICAL DATA

Product	Dibiten Poly/4 Smooth	Dibiten Poly/4.5 Slate	Dibiten Poly/4.5 FR* Slate	Dibiten Poly/5 Smooth
Product Type	APP	APP	APP	APP
Application Method	Heat Weld	Heat Weld	Heat Weld	Heat Weld
Reinforcement	Polyester	Polyester	Polyester	Polyester
Roll Weight (Nominal)	88 lbs.	99 lbs.	99 lbs.	88 lbs.
Roll Length (Nominal)	10 m (approx. 33')	10 m (approx. 33')	10 m (approx. 33')	8 m (approx. 26')
Roll Width (Nominal)	1 m (approx. 39")	1 m (approx. 39")	1 m (approx. 39")	1 m (approx. 39")
Product Thickness (Nominal)	4.0 mm	4.5 mm	4.5 mm	5.0 mm
Surface Color	Black	Variety Available	White	Black
Surface Finish	Talc	Slate Flakes	Slate Flakes	Talc
Gross Area Per Roll (approx.)	107.6 sq. ft.	107.6 sq. ft.	107.6 sq. ft.	86.1 sq. ft.
Net Coverage (approx.)	95 sq. ft.	95 sq. ft.	95 sq. ft.	76 sq. ft.
Rolls Per Pallet	20	16	20	20

**\*This is a special order product. Contact your Dibiten sales representative about availability and lead time.**

**8.2 TEST DATA**

Product	Dibiten Poly/4 Smooth		Dibiten Poly/4.5 & 4.5 FR Slate		Dibiten Poly/5 Smooth	
	Load	Elong.	Load	Elong.	Load	Elong.
Thickness	4.0 mm .160"		4.5 mm .1/80"		5.0 mm .200"	
Load Strain Properties						
@ 73.4° F	MD 110 CD 75	50% 50%	MD 110 CD 75	50% 50%	MD 125 CD 85	50% 50%
@ 0° F	MD 220 CD 150	22% 25%	MD 220 CD 150	21% 24%	MD 240 CD 200	22% 25%
Tear Resistance (lbs.)	MD 105	CD 75	MD 105	CD 75	MD 11/8	CD 95
Dimensional	MD < or = .50%		MD < or = .50%		MD < or = .50%	
Stability	CD < or = .20%		CD < or = .20%		CD < or = .20%	
Low Temperature Flex	14° F		23° F		14° F	

**Dibiten APP Modified Bitumen membranes meet the criteria for ASTM 6222, Type I, Grades G (Slate Surfaced) and S (Smooth).**

**UL Class A Fire Ratings available. (See pps. 55-56 or [www.ul.com](http://www.ul.com))**

**Specification & Application Manual**  
**Modified Bitumen Roofing Membranes**

---

**For More Information or Assistance Contact:**

**dibiten™**

**(800) 922-5922 (U.S. & Canada)**

Also available to roofing contractors: VHS format video showing product application highlights and safety guidelines. Call the number above to order.