

Welcome

to Smarter ATP Hygiene Monitoring

→ Guide to your EnSURE™ Touch

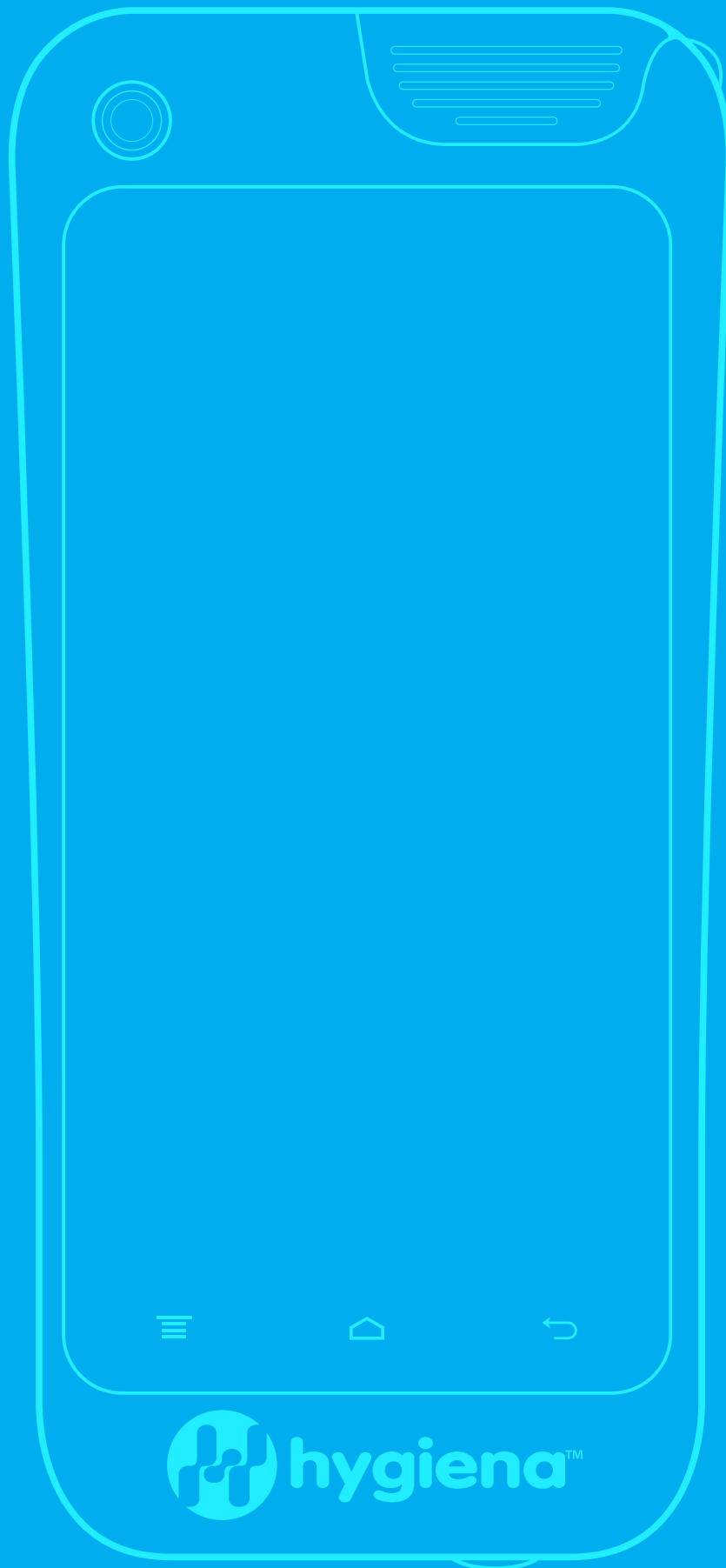

Contents

Introduction	4
Section 1: Creating a Hygiene Monitoring Program	5
1.1. What is ATP	5
1.2. Measuring ATP with Bioluminescence Technology.....	5
1.3. Other uses for ATP Monitoring Systems.....	6
1.3.1. Establishing your Facility’s Test Locations (Control Points)	7
1.3.2. Types of Contact Areas.....	8
1.3.3. Monitoring Individual Control Points	9
1.3.4. Diagram of Typical Production Floor Control Points	10
1.3.5. Interpreting Results on the Luminometer	11
1.3.6. Determining RLU Limits for your Facility.....	12
1.3.7. General Pass/Caution/Fail Limits.....	14
1.4. Testing Frequency	15
1.5. Corrective Action Procedures	16
1.6. Continuous Improvement.....	18
Section 2: Using Your EnSURE Touch ATP Monitoring System	19
2.1. Components of EnSURE™ Touch	20
2.2. System Use.....	21
2.3. Quick Start Guide	22
2.4. Locations	23
2.5. Proper Sampling Technique and Activation Procedure.....	24
2.5.1. Collecting Samples with the Testing Device	24
2.5.2. Measuring ATP with the EnSURE Touch	28
2.5.3. Calibration	29
2.5.4. Storing and Viewing RLU Limit Data.....	29
2.5.5. Plans	30
2.5.6. Users	33
2.5.7. Customizations.....	34
Section 3: Further Help	37
3.1. Glossary.....	37
3.2. Contact Hygiene.....	38

Introduction: The Best ATP Hygiene Monitoring Just Got Smarter

Now more than ever, customers and regulators demand verifiable quality control and hygiene standards. This trend is growing year after year and is most prevalent in the food manufacturing and distribution industry. Hygiena™ is the world leader in ATP hygiene monitoring with the EnSURE™ Touch luminometer, SureTrend™ Cloud Data Analysis Software and UltraSnap™ Surface ATP test device. Today, EnSURE Touch combines expertise and innovation, offering a modern solution to organizations that want the best ATP monitoring solution available.



EnSURE Touch is certified by AOAC-RI's *Performance Tested Method*™ program, demonstrating the system's sensitivity, reliability and robust operation. The certification is a modification of Hygiena's existing AOAC-RI certification of the UltraSnap test device, using the EnSURE luminometer.

This guide is in two parts. The first section is an overview of hygiene monitoring, and includes how ATP monitoring works, setting up a hygiene plan, adopting HACCP and SSOPs, and more. The second section illustrates how to use your EnSURE Touch to monitor your hygiene plan.

Recognized worldwide for accuracy and intuitiveness, EnSURE Touch is used by food and beverage processors, hospitals, pharmaceutical manufacturers, restaurants, supermarkets, janitorial/sanitation services, and anywhere cleanliness matters. It quantifies cleaning efforts in seconds, tracks those results and enables you to take immediate corrective actions where needed.

Benefits of Using EnSURE Touch for Environmental Monitoring:

- Reduces the use of conventional microbiological testing methods that are slow, labor intensive, and costly
- Verifies high-touch / high-risk areas are cleaned properly
- Improves cleaning protocol by tracking outcomes and training staff
- Verifies effective hand-washing
- Optimizes cleaning chemicals, equipment, and labor to avoid excessive waste.
- Reduces risk of pathogen development and avoid product recalls
- Shows compliance with HACCP, SSOPs, and industry regulations
- Gets 360° view of cleaning results across all your facilities in one dashboard

Section 1. Creating a Hygiene Monitoring Program

1.1. What is ATP?

ATP (Adenosine Triphosphate) is the energy-generating molecule found in all plant, animal and microbial cells, including food, bacteria, mold and yeast. All organic matter (living or once-living) contains ATP, including bodily fluids, blood and other microorganisms. It fuels metabolic processes such as cellular reproduction, muscle movement, plant photosynthesis, fungi respiration, and yeast fermentation. Detection of ATP on a surface or in water indicates the presence of biological matter that may not be visible. In industries where plant hygiene control or cleanliness is crucial, ATP testing has been adopted as a reliable tool for detecting and measuring biological matter that should not be present after cleaning.

1.2. Measuring ATP with Bioluminescence Technology

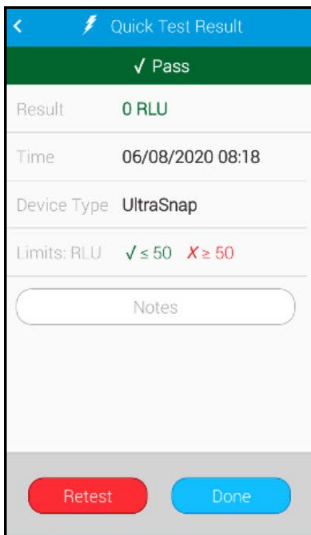

A key feature of ATP monitoring systems is the use of bioluminescence technology to measure adenosine triphosphate, commonly known as ATP.

Hygiene ATP testing devices contain a natural enzyme found in fireflies. This enzyme, called luciferase, catalyzes a simple bioluminescent (light-producing) reaction, oxidizing luciferin molecules when they come into contact with ATP.

The amount of light produced is proportional to the amount of ATP. Using bioluminescence technology, EnSURE Touch can measure extremely low levels of ATP collected with testing devices. By measuring the amount of bioluminescence from overall cleanliness, an ATP reaction provides an excellent

indication of overall cleanliness because the quantity of light generated by the reaction is directly proportional to the amount of ATP present in the sample. The bioluminescence reaction is immediate so results can be processed at the testing site in seconds. Results are expressed numerically in Relative Light Units (RLU).

1.3. Other Uses for ATP Monitoring Systems

In addition to routine hygiene monitoring, other useful applications for ATP monitoring systems include:

Troubleshooting – ATP testing provides a way to expose microbial contamination and other issues that might be causing higher than normal plate counts in environmental testing.

New Equipment Cleaning Verification – When a new piece of equipment is added, new cleaning processes are usually required. An ATP system helps determine the optimal process and chemicals.

Training – New cleaning and sanitation staff requires extensive training. Showing a trainee proper and improper processes and the effect on equipment cleanliness is invaluable.

Validation of Hand Cleanliness – ATP testing can be used to verify proper hand-washing techniques and cleanliness of employees' hands when used directly on skin. When doing this type of testing, it is important to identify appropriate pass/fail levels taking into account naturally occurring ATP levels from skin cells. To learn more about using ATP testing to verify hand cleanliness, contact a [Hygiena representative](#).

Additional Rapid Quality Tests – Hygiena's EnSURE Touch monitoring system does more than just ATP testing. With same day tests for indicator organisms, allergens, and more, EnSURE Touch can deliver a full picture of plant hygiene on one handheld system. EnSURE Touch is easy to use so it's not necessary to be a microbiologist or lab technician. Additionally, all tests measured on the EnSURE Touch monitoring system are recorded and tracked with SureTrend Cloud software.

Overall Facility Cleanliness – ATP cleaning verification products can be used to verify offices, common areas, kitchens, bathrooms, and meeting rooms have been cleaned according to standard.

1.3.1 Establishing Your Facility's Test Locations (Control Points)

Food safety programs are for the most part built on established Hazard Analysis and Critical Control Points (HACCP), which involves testing a system of Critical Control Points (CCPs) for possible hazards, including contamination. These critical control points, where a contamination hazard is more likely to occur, are monitored for cleaning efforts.

HACCP programs are themselves dependent on the successful use of other quality measures, such as Good Manufacturing Practices (GMP), and sanitation standard operating procedures (SSOPs), and even personal hygiene (such as washing hands and covering coughs and sneezes).

While none of these programs are failproof, they can help quality and safety managers identify the most likely areas that need monitoring for potential contamination. Validating and verifying sanitary efforts are key components to a successful program.

If you currently have HACCP or SSOP programs in place, you will most likely have identified your control points that are contact and non-contact surfaces. Test areas within your facility should be designated as “control points” in your hygiene monitoring plan. By monitoring these control points you will have reliable, real-time feedback on the cleanliness of a particular piece of equipment or areas being tested. It's important to routinely test all important control points. This will ensure product quality, identify issues immediately, and allow valuable trending data to be used to improve plant hygiene. Verification of cleanliness for these control points is also sometimes done visually or by environmental microbiology samples. Control points can be added or subtracted as your program develops.

If you haven't previously established control points, you need to determine areas where poor cleaning could affect your products and services. This can be done by swabbing multiple areas on equipment and production line surfaces after routine cleaning. Contamination levels will be higher in those spots that are harder to clean, spots that are missed in your current cleaning procedure, and spots that have developed biofilm. These areas should be established as control points for routine testing and monitoring.

1.3.2 Types of Contact Surfaces

Direct Contact Surfaces

Direct contact surfaces come in contact with product being processed. These are high-risk areas that should be tested frequently to verify cleanliness. They will typically have a low RLU limit.

A direct contact surface, such as a conveyor, should be tested in a few different places to verify total cleanliness. One test device could be used on multiple spots. If the test fails, then recleaning of the entire piece of equipment is required.

Indirect Contact Surfaces

Indirect contact surfaces are areas where splashed product or contaminants can be dropped, drained, or transferred onto the product. These areas are often overlooked as sources of contamination and should be routinely tested.

An indirect contact area, such as the side of a conveyor belt, should be tested in a few different spots to verify total cleanliness.

Hard-to-Clean Contact Surface

Hard-to-clean surfaces have high potential to harbor bacterial growth and should be tested regularly.

Examples: mixing blades, hoses, O-rings, nozzles, corners, grooves, cracks, joints or areas with irregularly shaped surfaces.

A hard to clean area, such as a mixing blade, should be tested in a few different places to verify total cleanliness.

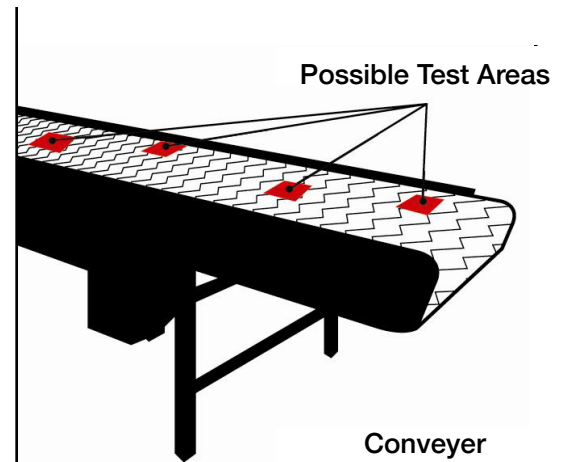

Examples: conveyor belt, cutting board, slicers, grinders, moving bins or totes, utensils, etc.

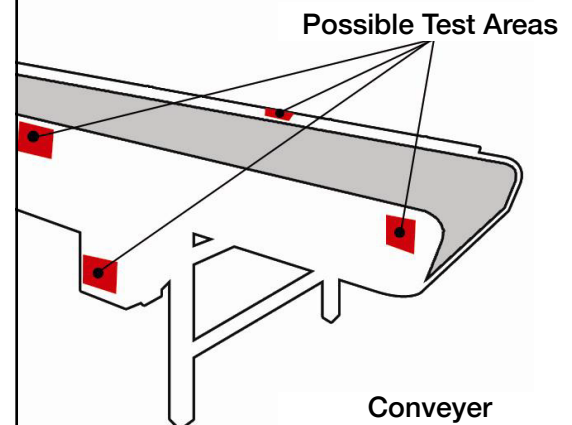

Examples: drain, side walls, machine buttons/controls, and additional machine parts that don't directly contact product but if contamination is allowed to build, could cause microbial contamination that could then spread.

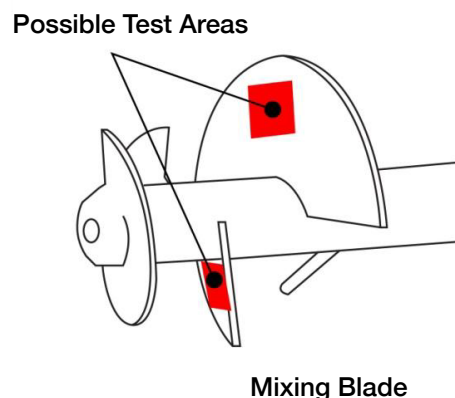

1.3.3 Monitoring Individual Control Points

Once control points have been identified, this information should be entered into SureTrend Cloud.

In SureTrend Cloud, locations may be identified by assigning an alphanumeric name, group category, surface type, and additional notes. Locations may be assigned to test plans according to when they will be tested, or which locations should be tested together.

Below is an example of a spreadsheet created with SureTrend Cloud.

Prog #	Location	Group	Surface	Lower	Upper
0	<i>Calibration Control</i>	<i>Calibration Control</i>			
1	Line A Raw Mat. Bin	Bin Carts	Plastic	20	60
2	Liquid Coating Belt	Line A	Plastic	20	60
3	Table 1	Line A	Stainless	20	60
4	Table 2	Line A	Stainless	20	60
5	Conveyer	Line A	Plastic	20	60
6	Line B Raw Mat. Bin	Bin Carts	Plastic	20	60
7	Hopper	Line B	Stainless	20	60
8	Flume	Line B	Stainless	20	60
9	Up Conveyer	Line B	Plastic	20	60
10	Table 3	Line B	Stainless	20	60
11	Table 4	Line B	Stainless	20	60
12	Conveyer	Line B	Plastic	20	60
13	Chute	Line B	Stainless	20	60
14	Slicer	Line B	Stainless	20	60
15	Down Conveyer	Line B	Plastic	20	60
16	X-Ray	Line B	Plastic	20	60
17	End Belt	Line B	Plastic	20	60
18	Line C Raw Mat. Bin	Bin Carts	Plastic	20	60
19	Hopper	Line C	Stainless	20	60
20	Shaker	Line C	Stainless	20	60
21	Flume	Line C	Stainless	20	60
22	Blades	Line C	Stainless	20	60
23	Conveyer	Line C	Plastic	20	60
24	Top Insp. Belt	Line C	Plastic	20	60
25	Bottom Insp. Belt	Line C	Plastic	20	60
26	Warm Roller	Line C	Stainless	20	60
27	Cold Roller	Line C	Stainless	20	60
28	Line A Crate	Crates	Plastic	20	60
29	Line B Crate	Crates	Plastic	20	60
30	Line C Crate	Crates	Plastic	20	60
31	Reject Bin 1	Bin Carts	Plastic	20	60
32	Reject Bin 2	Bin Carts	Plastic	20	60
33	Reject Bin 3	Bin Carts	Plastic	20	60
34	Reject Bin 4	Bin Carts	Plastic	20	60
35	On/Off Mechanism	Hand Washing	Stainless	20	60
36	Basin	Hand Washing	Stainless	20	60
37	Drain 1	Drains	Stainless	200	600
38	Drain 2	Drains	Stainless	200	600
39	Drain 3	Drains	Stainless	200	600
40	Drain 4	Drains	Stainless	200	600

1.3.4 Diagram of Typical Production Floor Control Points

Below is an example of a production floor plan. Direct contact surfaces are indicated with a red rectangle, and indirect contact areas with a blue circle.

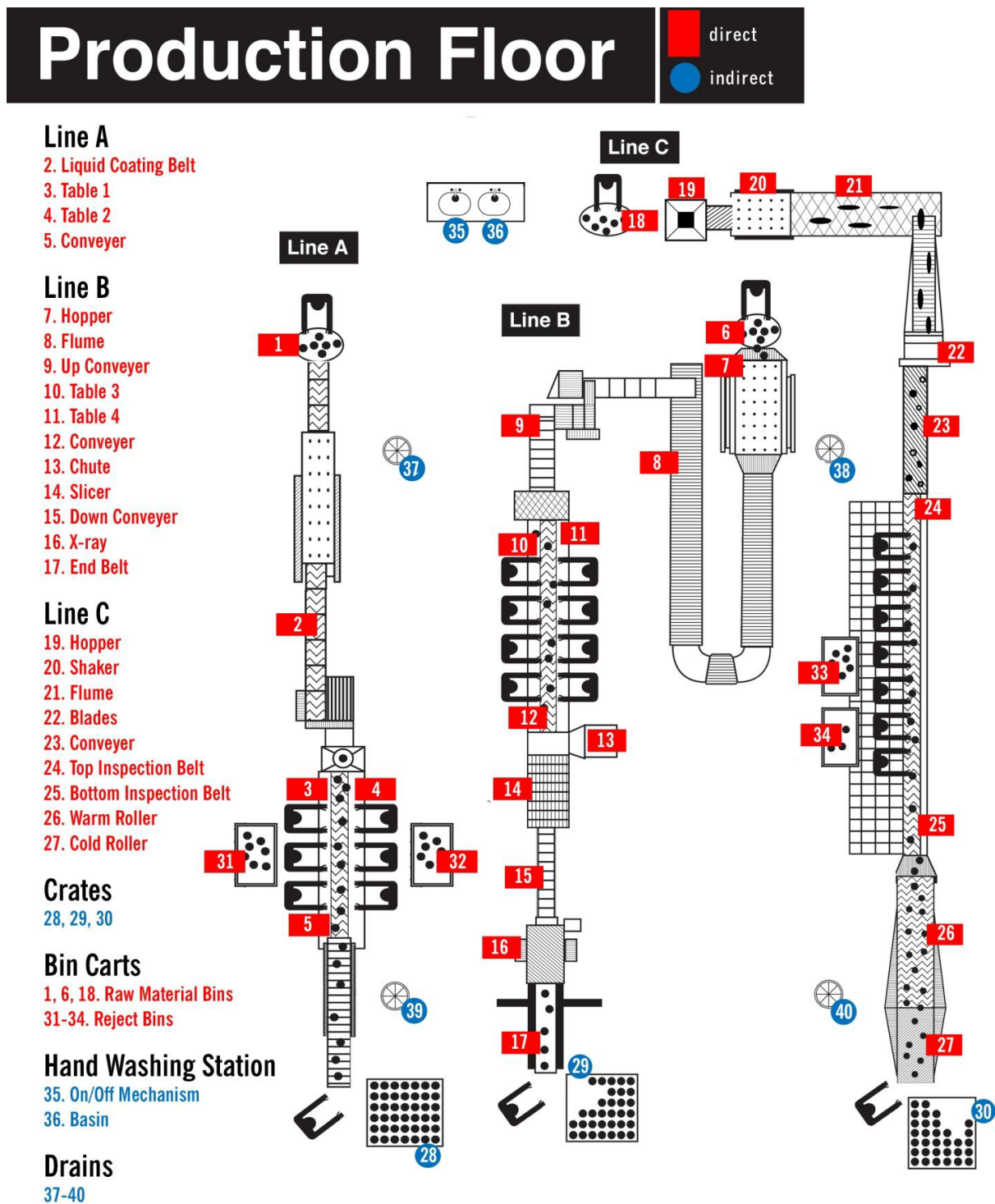

1.3.5 Interpreting Results on EnSURE Touch Luminometer

The relationship between the amount of ATP collected in a sample and the RLU result displayed on the luminometer is linear, which makes understanding the technology very easy.

The RLU reading is directly proportional to the amount of ATP collected from the sample. A high RLU reading indicates a large amount of ATP at the test location. This in turn indicates improper cleaning and the presence of potential contaminants.

Cleaning properly results in less ATP at the location. Lower ATP levels produce smaller amounts of light output during the bioluminescence reaction and consequently, a lower RLU reading.

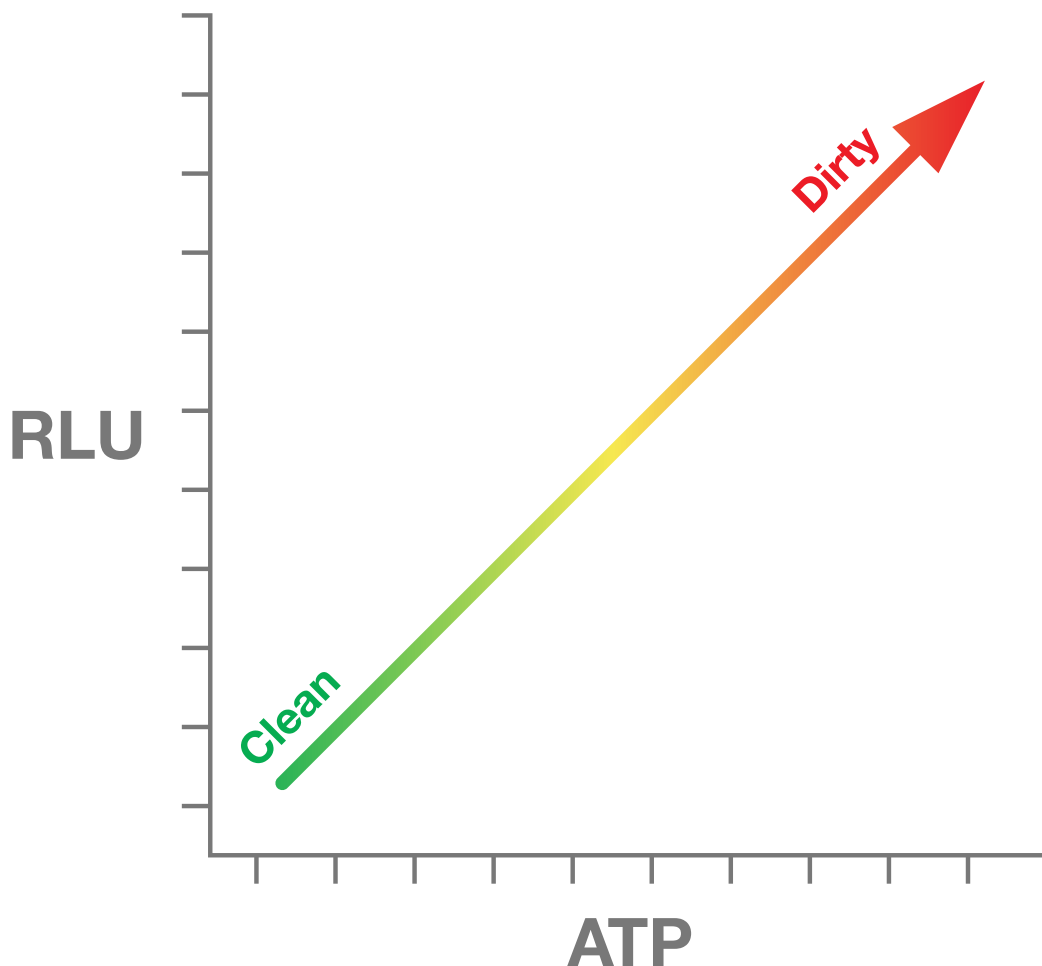

1.3.6 Determining RLU Limits for your Facility

Setting appropriate Pass, Caution and Fail levels is a fundamental part of running a successful ATP monitoring program as part of the larger HACCP process. RLU limits may vary depending on the type of product being manufactured as well as the surface being checked. However, the formulas used to determine Pass, Caution and Fail levels are always the same.

Setting Up RLU Limits

1. Clean product surfaces to the level that daily cleaning procedures should achieve.
2. Conduct an ATP test at each location. Take 5-10 replicate tests at each cleaned location, being sure not to swab the same exact surface area more than once.

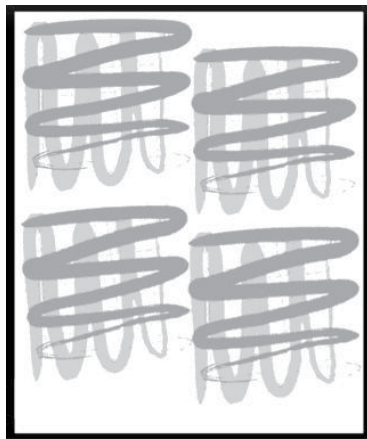

Correct

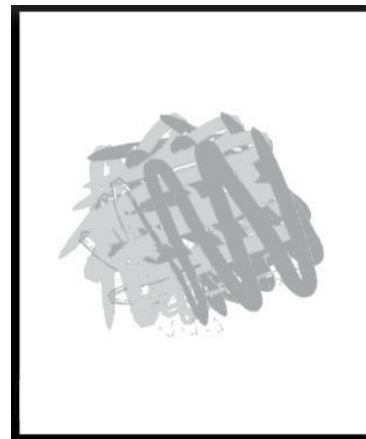

Incorrect

All replicate tests can be done on the cleaned surface or equipment after one cleaning or over the course of several days.

To Determine the Pass Limit:

Calculate the average RLU for each location based on the 5-10 test results. To do this, add all test results, and then divide the sum by the number of tests taken. The resulting number is your average RLU. This number is your Pass limit.

To Determine the Fail Limit using one of the two methods below:

1. Multiplication method: Multiply the Pass limit by 3.
2. Standard deviation method: Determine the standard deviation of the test results, then multiply the standard deviation by 3 and add this number to the Pass limit. The resulting number is your Fail limit. If the Fail limit is zero (0), it is acceptable to set the Pass limit to the system default of 10 RLU. Occasionally, blank ATP test devices may emit up to 2 RLU. For further advice contact your Hygiene Sales Manager.

To Determine the Caution* Limit:

The area between the Pass and Fail limits is the Caution range.

***Note:** The Caution range is sometimes useful for trend analysis and eliminating an excessive amount of re-cleans when an ATP program is implemented. Caution results can be viewed as a warning and more attention should be given to this location the next time cleaning is done. Often, a caution one day will be a Pass the next day. However, users may opt to forgo the Caution range and set the Fail limit to the same RLU as Pass limit. Any result over the Pass limit is then considered a Fail result.

The following table uses example data to illustrate average RLU and Pass/Caution/Fail limits using the multiplication method:

Test	1	2	3	4	5	6	7	8	9	10	Average RLU
Routine Cleansing	10	15	8	19	10	13	17	14	15	11	13.2

Pass	Caution	Fail
0-13	14-35	36+

If a user chose to eliminate the Caution zone, RLU limits for Pass and Fail would both be set to 13 to yield the following RLU limits:

Pass	Fail
0-13	14+

Note: Different surfaces have different levels of risk, and therefore may require different RLU limits. For example, porous plastic or rubber surfaces may be more difficult to clean than stainless steel surfaces, and therefore produce higher ATP test results. In this case, the user may choose to: 1) set RLU limits higher for those harder-to-clean areas; or 2) intensify cleaning to bring ATP test results on those surfaces in line with other control points.

1.3.7 General Pass/Caution/Fail Limits

For facilities that opt not to set their own RLU limits, Hygiena offers general guidelines. These are common limits used for ATP hygiene monitoring and are based on plate count and ATP correlation studies.

	Pass (RLU)	Caution (RLU)	Fail (RLU)
EnSURE Touch	<20	21-59	>60

1.4. Testing Frequency

Once control points have been established and RLU limits have been set, a sampling frequency plan should be developed. Sampling frequency should be based on the level of risk associated with the control point being tested.

Factors determining the level of risk include:

- Surface robustness and susceptibility to contamination
- How often the piece of equipment is cleaned
- Age and wear of equipment
- Degree of difficulty to clean
- Level of contact with product
- Number of types of food being processed on a machine, which increases the potential for cross-contamination and allergens.

Critical (high-risk) control points should be tested on a daily basis, after each cleaning. You may also choose to test after product line changes, after shift changes, and any time prior to start-up. Lower-risk control points may not need to be tested as frequently.

Note: ATP testing should be done prior to the application of a sanitizer, if possible.

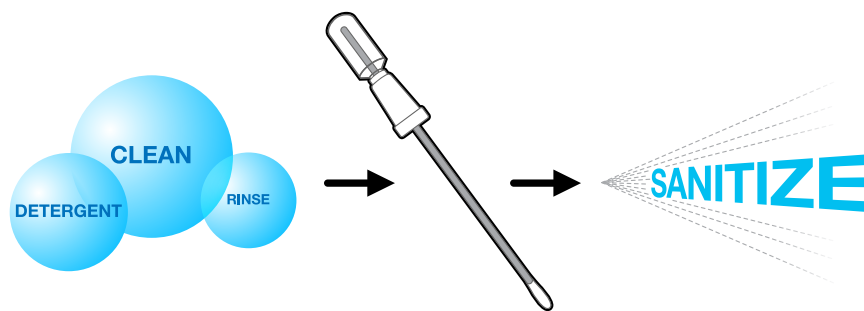

Sanitizers are more effective when surfaces are free of all residues. Following this Clean-Test-Sanitize procedure prevents wasting sanitizer and time it takes to reapply sanitizer.

Note: Some sanitation procedures may require testing to be done after sanitizing, because of equipment turnover time. In such cases, follow sanitizer's proper dwell time and concentration levels before testing. Commonly used sanitizers at working strength should not affect Hygiena's tests. Some acid-based sanitizers at high concentrations could slightly reduce output signal. For a list of sanitizers that could affect the bioluminescence reaction, contact Hygiena.

1.5. Corrective Action Procedures

Implementing a corrective action plan is an essential part of an environmental monitoring program. Corrective action procedures provide clear instructions for what steps should be taken following Pass/ Caution/Fail results.

Recommended corrective action procedures are as follows

Test Results	Corrective Action
√ (Pass)	The control point has been properly cleaned. Proceed to sanitizing.
! (Caution)	The control point may not have been adequately cleaned. You may choose to proceed to sanitizing, or reclean and retest as if the result is a Fail. A control point with a Caution reading should be monitored for future problems.
X (Fail)	The control point was not cleaned properly and must be cleaned again and retested until a Pass or Caution result is achieved. A control point with a Fail reading should be noted and monitored for future problems.

According to the needs of the facility, the user has the option of setting up a more extensive corrective action plan. For example, users may decide that control points which produce Fail results should be retested until 3 consecutive days of Pass results are achieved. If the control point does not successfully achieve 3 consecutive days of Pass results, cleaning procedures, personnel, or RLU limits should be re-evaluated.

A flow chart on the next page illustrates general recommended cleaning and corrective action procedures.

Recommended Cleaning and Corrective Action Procedures

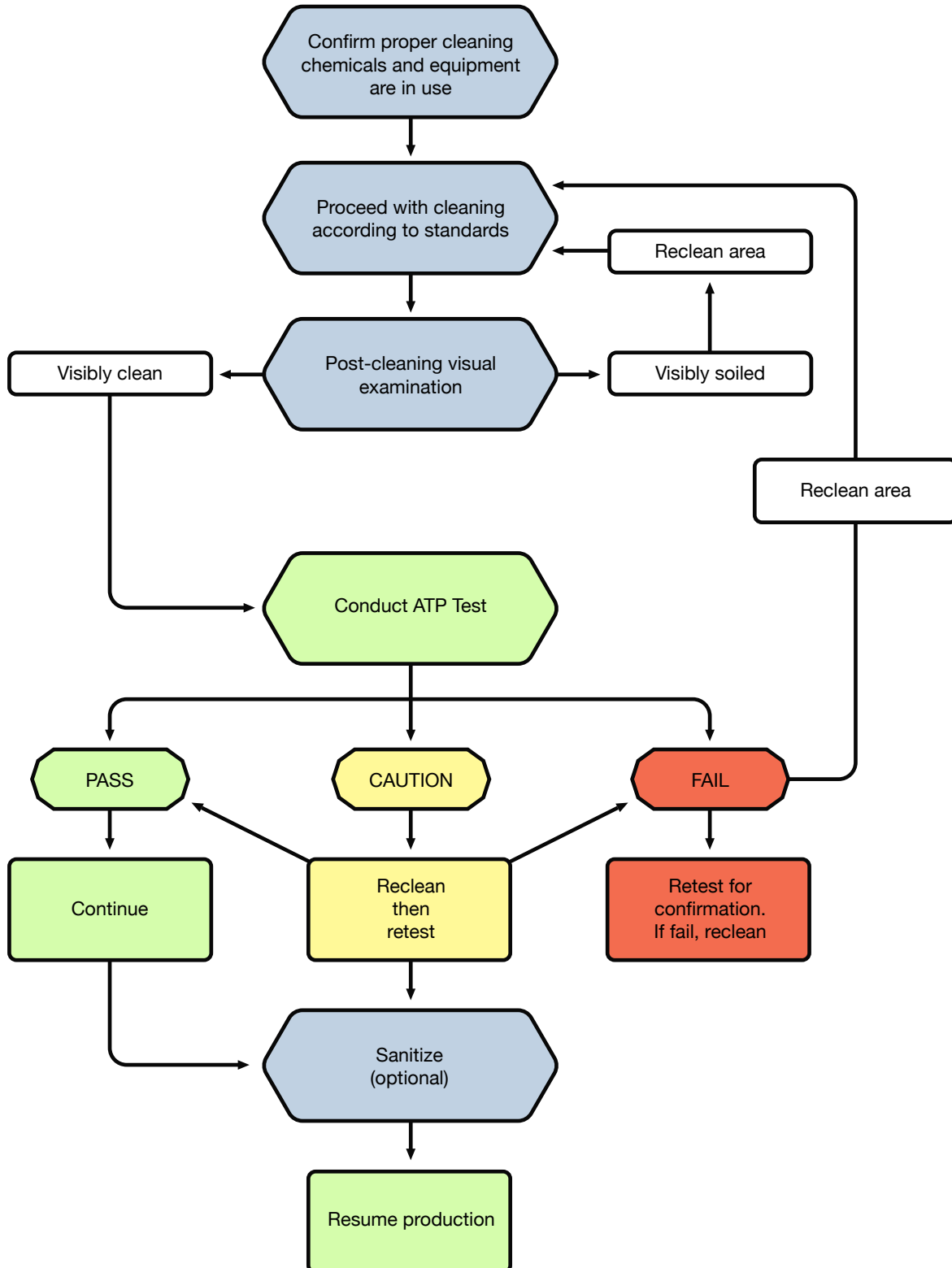

1.6. Continuous Improvement

Hygiena monitoring systems are designed to aid organizations striving for continuous improvement of standards. Continuous improvement ensures excellence in product quality, while reducing inefficiencies, avoiding recalls, and showing due diligence and compliance to auditors and customers.

Analysis of results is key to the evaluation and ongoing improvement of cleaning programs. Consistent results show there is consistency in the cleaning regime. Avoid reducing Pass and Fail levels until this has been achieved. Using SureTrend Cloud, users can monitor and assess ATP, microorganism, and enzyme test results, perform trend analysis, identify trouble zones, correct improper cleaning procedures and eliminate risk.

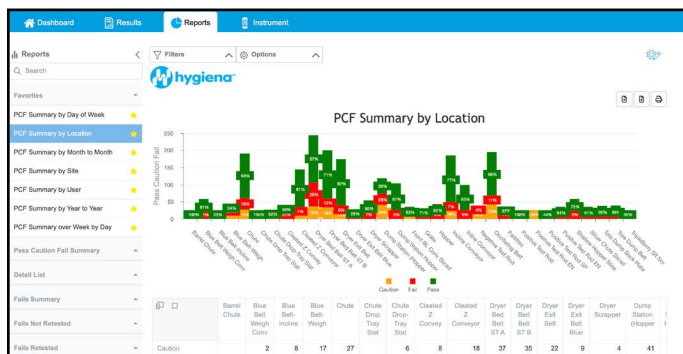
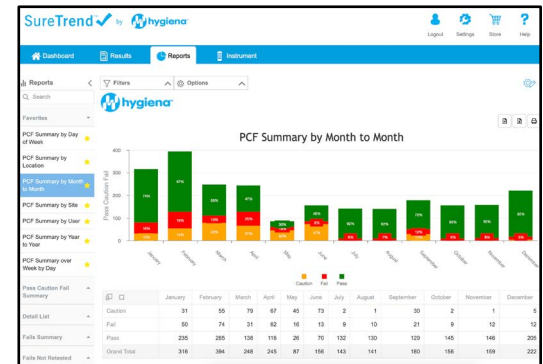

If trends show high numbers of Caution and Fail results, standard sanitation operating procedures (SSOPs) should be reviewed for ways to improve protocols. If low numbers of Caution and Fail results are obtained, Pass/Fail limits could be reviewed and potentially lowered, creating a higher cleaning standard which would create a cleaner facility.

Pass, Caution, and Fail limits should also be re-evaluated every year and whenever procedural or equipment changes are made. As cleaning procedures become more efficient and effective, limits should be adjusted to ensure your facility is operating to its maximum potential.

Section 2: Using Your EnSURE Touch ATP Monitoring System

Proper sampling, correct use of the luminometer and testing devices, and accurate data management are crucial components of a successful monitoring program.

This section will explain how to:

- Collect a sample using UltraSnap, SuperSnap, or AquaSnap tests
- Measure results using EnSURE Touch
- Review and analyze results using SureTrend Cloud Software
- Verify calibration using CalCheck
- Store data and set up plans

2.1. Components of EnSURE™ Touch

Components of the EnSURE Touch Monitoring System:

1. Instrument (also referred to as a luminometer)
2. Test devices (also referred to as swabs)
3. Software

EnSURE Touch - The Most Sensitive and Intuitive System

The EnSURE Touch features a 5-inch touch screen, wireless sync technology, cloud-based software and the ability to conduct a wide range of tests. It's the most versatile ATP system available, and can adapt to your workplace, providing everything you need to support a comprehensive risk management program.



EnSURE Touch is application driven and works just like a smartphone. In just a few touches, you can perform a test, add plans and locations, view results and reports, customize settings, and much more!

Compatible Tests:

- UltraSnap™ Surface ATP Tests
- AquaSnap™ Water ATP Tests
- SuperSnap™ High-Sensitivity ATP & Allergen Prevention Tests
- MicroSnap™ Indicator Organism Tests
- ZymoSnap ALP Pasteurization Verification Tests
- CrossCheck ACP Cooking Efficiency Tests

We designed EnSURE Touch to be an innovative system. We continue to add features and new capabilities. Software updates are released over Wi-Fi as frequently as every two weeks. To see an updated list of compatible tests, refer to our website at www.hygiena.com/ensuretouch

SureTrend™ Cloud Software

SureTrend Cloud is a powerful and private cloud-based software that wirelessly syncs testing data from one or multiple EnSURE Touch instruments. It is scalable and customizable to meet the needs of any organization. Stakeholders can view testing data across their facilities from an intuitive dashboard, allowing them to make meaningful decisions based on objective data. Hygiena's instruments, test devices, and software are designed to be easy to use, enabling both technical and non-technical staff to operate them without difficulty. Plus, select among dozens of languages based on the user's preference.



2.2. System Use

In accordance with lithium battery shipping requirements, EnSURE Touch is charged to less than 30% before shipping. Like all lithium-ion batteries, it may lose charge during shipping and storage. Therefore, we recommend immediately charging your luminometer once you receive it using the included USB-C charging cord.



Charging Port
Kick Stand

To power on the instrument, press the power button at the top left of the screen. After a few minutes of non-use, the luminometer will go into stand-by mode and appear to shut off. Stand-by or screen timeout mode helps to reduce battery use. If your luminometer appears to turn off, simply press the power button to turn on the screen. If the instrument does not power on after charging, hold the power button for 12 seconds.

To get the most out of your battery, it is recommended that you customize the battery settings.

1. Open Settings
2. Touch General
3. Touch Display & Power Off

From here you can adjust brightness, screen timeout, and automatic daily shut off.

2.3. Quick Start Guide

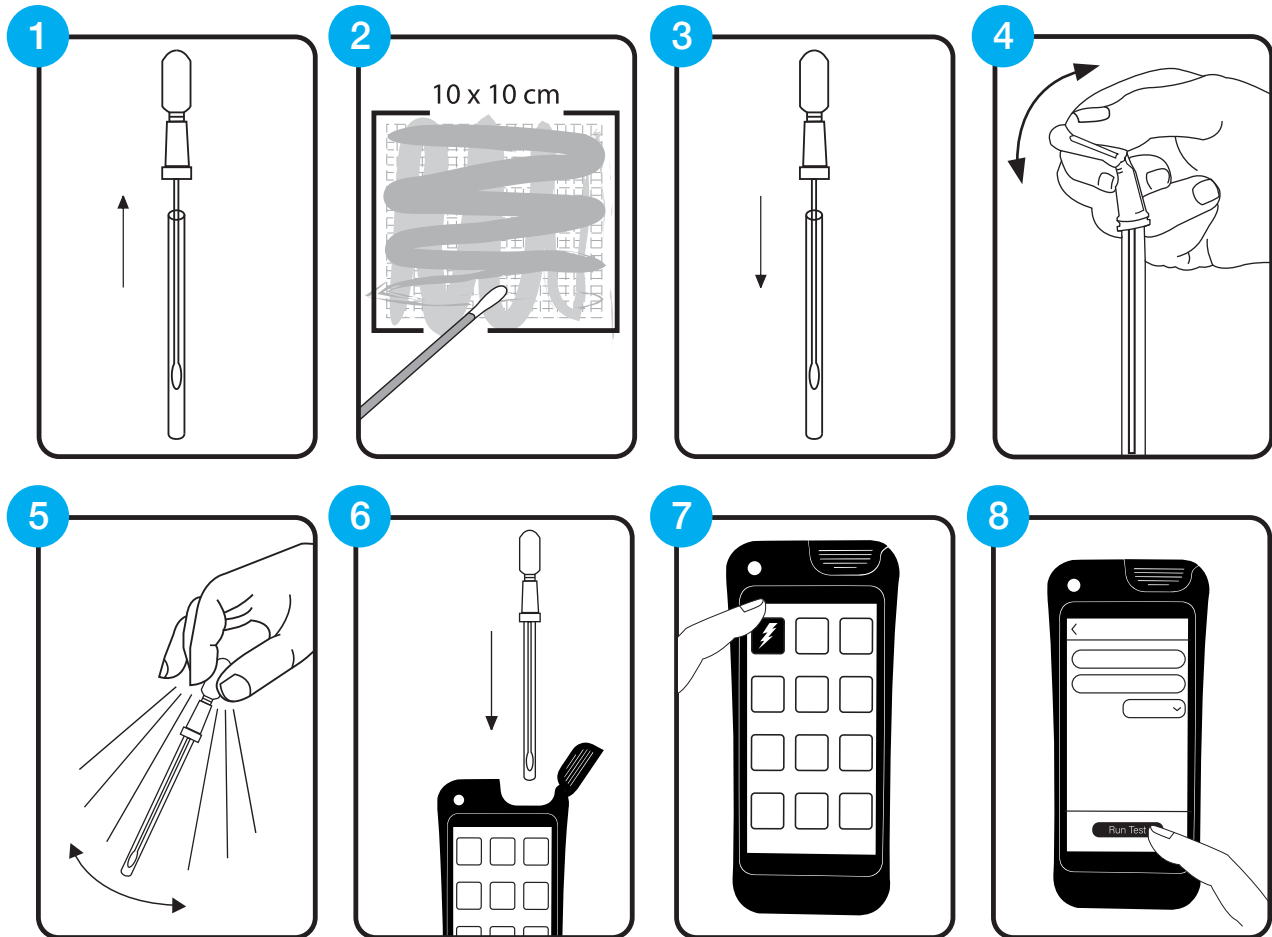

1. Identify the location to be tested and turn on the EnSURE Touch. Remove the ATP testing device from the outer tube. Press firmly down on the swab tip and collect a sample from a 10 x 10 cm (4 x 4 in) area. Use a side-to-side and up-and-down motion while rotating the swab tip.
2. Place the swab back into the swab tube. The ATP testing device is now ready to be activated or can be left inactive for up to 30 minutes. Once activated, the test must be read within 30 seconds.
3. To activate, break the plastic valve at the top of the device by bending the bulb backward and forward. Squeeze the bulb twice to expel the liquid in the bulb to the bottom of the tube.
4. Bathe the swab bud in the liquid by shaking gently in a side-to-side motion for 5-10 seconds.
5. Select the Quick Test app and place the entire test device into the luminometer and close the lid.
6. Holding in a vertical position, press Run Test to initiate reading. The test result will appear on the screen in 10 seconds.

2.4. Locations

The EnSURE Touch locations app allows you to add and manage testing locations.

To add a location, open the Locations app and press the + button. Enter the location name, select the test device that will be used on that location, and

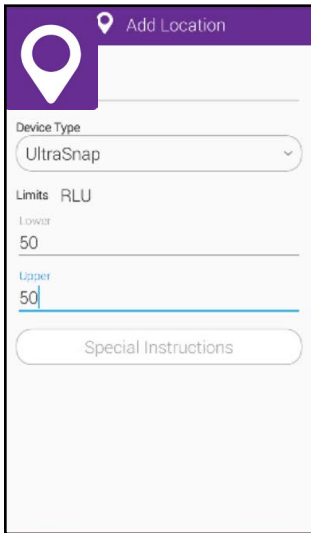

- ▶ set the RLU limits. You can also enter special instructions for the locations which will be visible when performing testing on the location. When you're done, touch the Back button. Changes are automatically saved.

To make changes to a location, touch the pencil icon. From here, you can touch the red minus icon to delete a location or touch the pencil icon next to a location to make changes to it. When you're done, touch the Back button. Changes are automatically saved.

Tests can also be initiated from the Locations app. Once the Locations app is open, select the location that will be tested, confirm the test device type that will be used, and touch Run Test to begin the test.



2.5. Proper Sampling Technique and Activation Procedure

Before collecting a sample for testing, the surface should be visibly clean. If any soiling or residue is apparent, reclean the area before testing.

If testing occurs in real-time at the sampling location, turn on EnSURE Touch and select the location to be tested. This action should be taken before activating the test.

2.5.1 Collecting Samples with the Testing Device

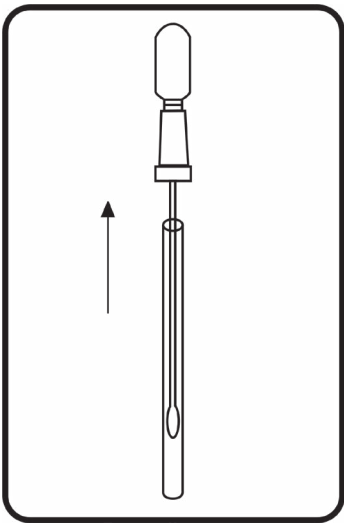

1. Remove the testing device from the pouch. Next, remove the outer tube by holding on to the double ring-base of the Snap-Valve™ while pulling down on the tube. The swab tip comes pre-moistened with an extractant that breaks through biofilm on test surfaces. Condensation may be visible on the inside of the swab tube. This is normal. Do not touch the swab tip or shaft with fingers or anything else, as this will contaminate the test. Discard any swabs that accidentally get contaminated or activated.

Note: For optimal performance, swabs that have been removed from cold storage should stand for 10 minutes at room temperature before use.

2. Collect a sample using the guidelines below. The test device is designed to detect trace amounts of contamination. Collecting a sample on a visibly dirty surface may overload the bioluminescence reaction and produce an inaccurate test result.

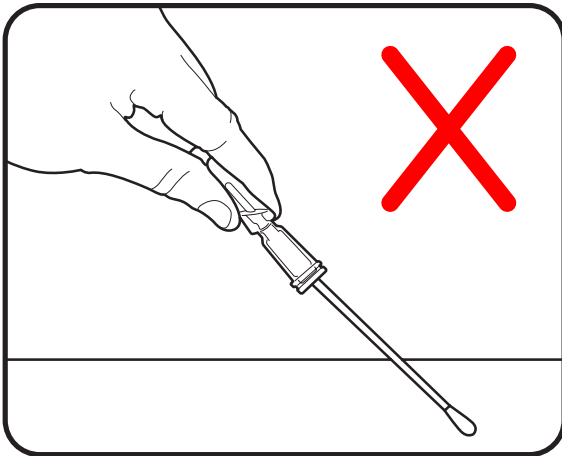

Incorrect Swabbing Technique:

Avoid touching the swab shaft with your finger. Applying light pressure or not rotating the swab while collection a sample will result in an inadequate sample collection.

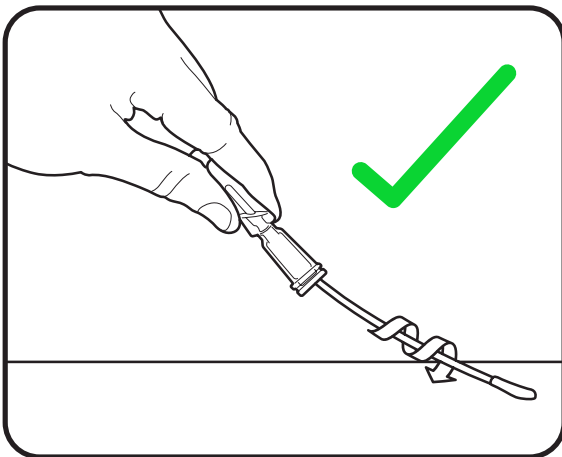

Correct Swabbing Technique:

Applying pressure while rotating the swab tip helps break through biofilm and allows for a sufficient sample to be collection. Be sure to swab 10 x 10 cm (4 in x 4 in) area where possible.

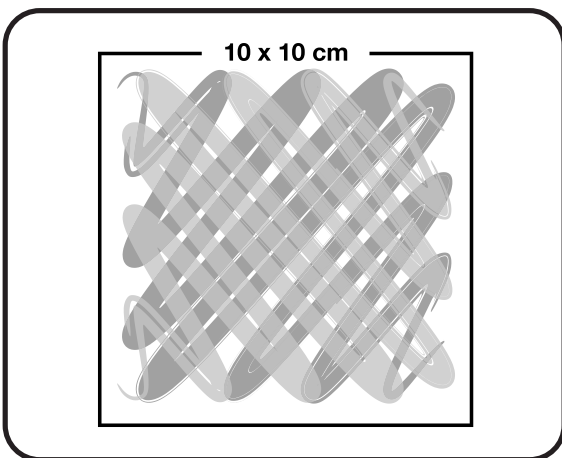

Regular Surfaces

Swab a 10 x 10 cm (4 x 4 in) square on the test surface, making a crisscross pattern as shown.

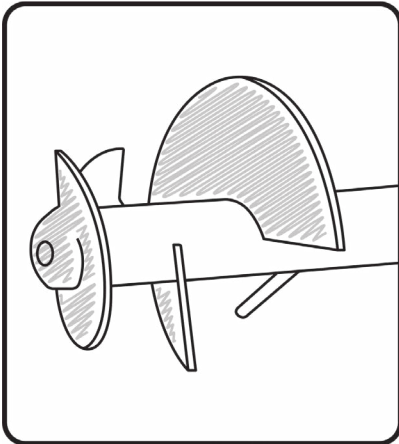

Irregular Surfaces

Where 10 x 10 cm square sampling is not feasible, swab as much of the surface as possible. Be sure that a bend in the shaft is achieved and an adequate sample is collected.

Note: Consistent swabbing pattern on irregular surfaces, such as a mixing blade, is necessary to ensure reliable and repeatable results over time. All individuals responsible for performing swab tests should be trained on correct swabbing pattern for irregular and regular surface test sites.

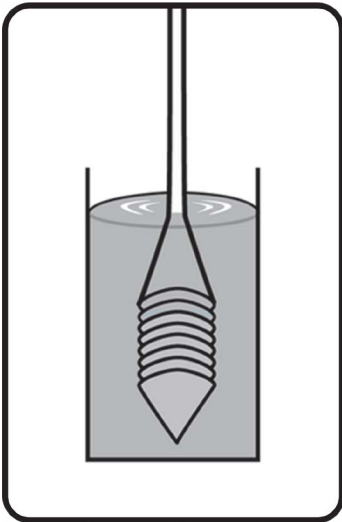

Liquid sampling – Use AquaSnap™

Dip AquaSnap honeycomb dipper into sample of water being tested. If the water is not homogenous or contains sediment, mix thoroughly before sampling.

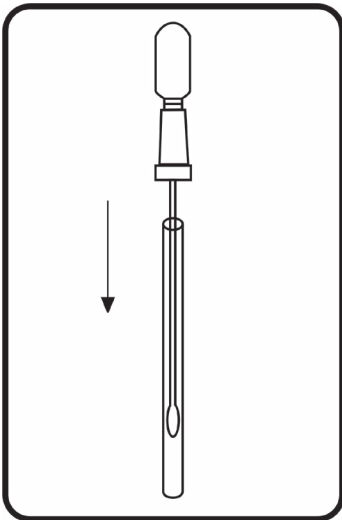

3. Re-insert the swab into the tube. The test device is now ready to be activated. A test with a collected sample on it can be left inactivated for up to 30 minutes while protected in the tube. In some facilities, users prefer to sample each location, write the sample location on the swab tube, and run all tests in a laboratory rather than at the test location. The most common process is to activate and read the test immediately after collecting the sample.

Note: It's good practice to make sure EnSURE Touch is on before activating the test. This ensures you are able to read the test within 30 seconds.

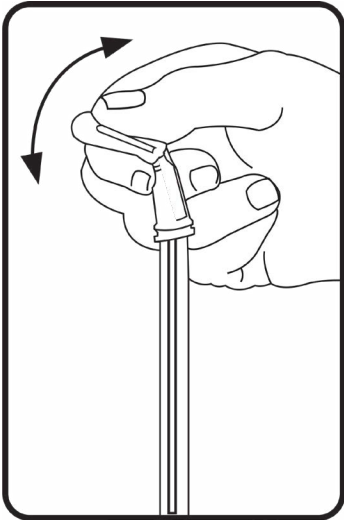

4. Holding the device upright, activate the test device by bending the bulb at the top until the Snap-Valve breaks, then bend once more in the opposite direction. Squeeze the bulb twice to expel the liquid-stable reagent contained in the bulb and allow it to flow to the bottom of the tube.

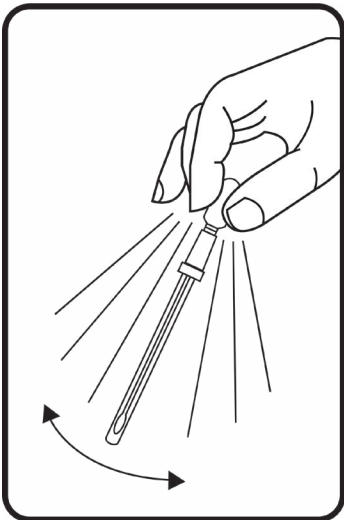

5. Gently shake the device with a side-to-side motion for 5-10 seconds, bathing the swab bud in the liquid-stable reagent. The test is now activated and the bioluminescence reaction is taking place. For optimal results, the test should be run as soon as possible, and within 30 seconds of activation.

2.5.2 Measuring ATP with EnSURE™ Touch

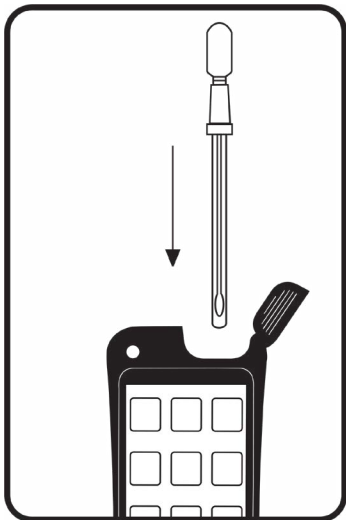

6. Select the Quick Test app or a specific Location or Plan from either respective app. Open the lid and insert the activated testing device into the reading chamber. Close the lid, making sure to keep EnSURE Touch in an upright position.

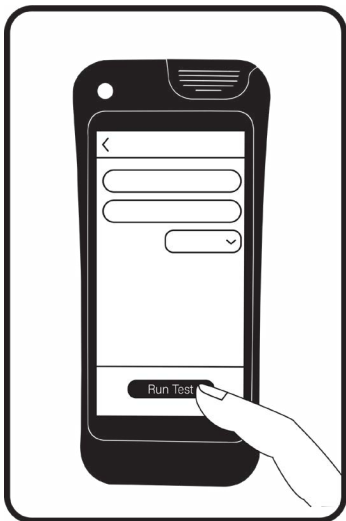

7. Press Run Test to initiate measurement. Results are displayed on the screen in 10 seconds.

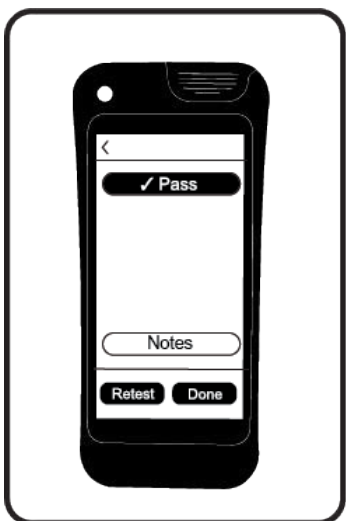

2.5.3 Calibration

Though Hygiena luminometers run a calibration self-check at start up, a robust quality control program will often require proof that your instrument is calibrated. CalCheck provides all-in-one, reusable positive and negative calibration verification, activated simply by the click of a button.

CalCheck - LED Calibration Verification



CalCheck is a reusable, convenient LED device to quickly and reliably verify the calibration on your luminometer - in less than one minute!

2.5.4 Storing and Viewing RLU Limit Data

Default RLU limits enabled in the setup screens on EnSURE Touch are based on which industry you select. You can always change this later in Settings.

Settings > Customization > Product Selections > Default Limits.

If using SureTrend Cloud to load RLU limits, the data can be imported using the Import Manager function, importing a SureTrend 4 database, or typing them in directly.

After running a test, results will display on the luminometer as follows:

√ (Pass)	For any RLU reading that is less than or equal to the Pass limit. A Pass result indicates the surface is clean.
! (Caution)	For any RLU reading that is greater than the Pass limit and less than the Fail limit. A Caution result indicates the surface may not have been adequately cleaned.
X (Fail)	For any RLU reading that is greater than the Fail limit should be recleaned.

For information on what steps should be taken after obtaining Pass, Caution, or Fail results, see Corrective action procedures in Section 1.5.

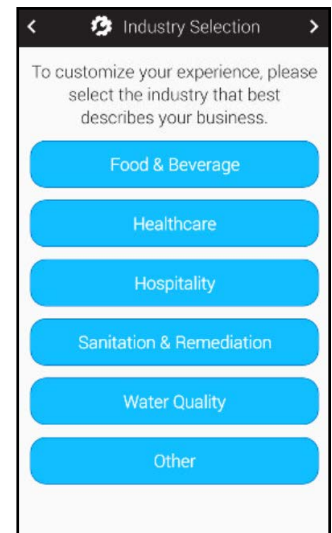

2.5.5 Plans

Once locations and limits have been entered, test plans may then be set up. Test plans are groups of locations that are tested one after each other, grouped together, or tested on a specific day. Below are some examples of test plans.



To add a plan, open the Plans icon and press the + button. Enter the plan name. Choose a plan type. There are 3 types of plans; Basic, Random, and Quota.

Plan Name
Example plan 4

Plan Type
Basic

Plan Locations

Locations in Plan

Schedule Plan

▶ **Basic plans** allows you to choose any number of locations you would like to add to the plan. The field will show you the total number of locations you have included in this plan.

Quota plans allow you to set a number of locations that must be tested before the plan is complete.

Random plans are a more specific type of quota plan and still require a quota to be set. For example, if a random plan has ten locations with a quota of five, then five locations will

randomly be selected from the ten. You also have the option to specify required locations which means that those locations get selected every time. To mark a location as required from the Plan Locations screen, touch the star icon to the right of the locations name. It will turn black when selected.

Plan Name
Random Plan

Plan Type
Random

Plan Locations

Locations in Plan

Required Locations *

Location Quota to Test
1

Do Not Repeat Locations

Schedule Plan

Scheduling Plans

Sometimes remembering to perform the right plans can be a hassle. That's why we've made it easy for you to remember with plan scheduling.

To schedule a plan, touch the Schedule Plan button. From here you can toggle plan scheduling on and off. Turn it on and then select the frequency at which you'd like to schedule the plan. Press the Back button to automatically save your changes

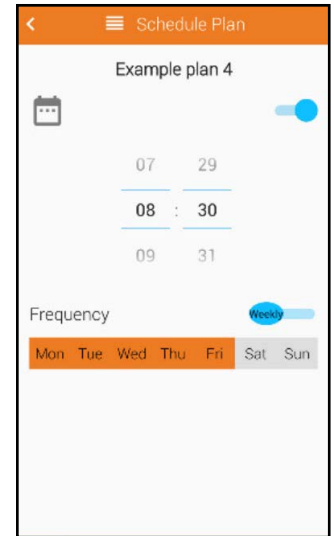

If you've scheduled a plan, when it's time to start testing, you'll see a red notification badge appear at the top right corner of the plans app.

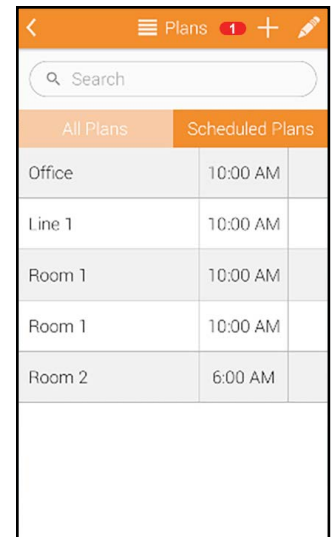

Hygiene Monitoring Guide

You will be able to choose whether a plan gets tested weekly or daily and choose the time when testing will occur. If a scheduled plan is missed this will be removed until the next occurrence.

Here are some examples of test plans:

Tables
Table 1
Table 2
Table 3
Table 4

Conveyors
Line A Conveyor
Line B Up Conveyor
Line B Down Conveyor
Line B Conveyor
Line C Conveyor
Top Inspection Belt
Lower Inspection Belt

Bins and Crates
Line A Material Bin
Line B Material Bin
Line C Material Bin
Line A Crate
Line B Crate
Line C Crate
Reject Bin 1
Reject Bin 2
Reject Bin 3
Reject Bin 4

Line A
Liquid Coating Belt
Table 1
Table 2
Conveyer

Line B
Hopper
Flume
Up Conveyer
Table 3
Table 4
Conveyer
Chute
Slicer
Down Conveyer
X-Ray
End Belt

Line C
Hopper
Shaker
Flume
Blades
Conveyer
Top Inspection Belt
Bottom Inspection Belt
Warm Roller
Cold Roller

2.5.6 Users



To add a user, open the EnSURE Touch User app and press the + button. Enter in a user name and select a role. Operators can perform tests and have limited access to instrument settings. Administrators have complete access to testing and instrument settings.

Only administrators can add or manage users on the instrument. Hygiena recommends setting up administrators before setting up operators.

Create a PIN and enter it again to confirm. When you're done, touch the Back button. Changes are automatically saved.

Results	%	Count
✓ Pass	60%	3
⚠ Caution	0%	0
✗ Fail	40%	2

▶ Enabling Security

By default, security is not enabled.

When you create an administrator with a password without having security enabled, a pop up will appear prompting you to enable it.

Touch Yes and enable security.

You can always change this in settings.

1. Open Settings
2. Touch General
3. Touch Security

Logging Out / Switching Users

When security is enabled and the screen is on, holding the power button will give you the option of logging out. You can also log out from the bottom left of the home screen by touching the username. Doing this will return you to the login screen. The username logged in at the time a test is performed will be associated with that test. When security is turned off, the instrument has no way of knowing who is using the instrument. As a result, when security is off, this instrument does not track users. When security is turned on, a user must enter their pin in order to sign in. This allows the instrument to distinguish between users and associate a user with any tests run.

Personnel are not the same as Users

Users refer to the person who is logged into EnSURE Touch and performing the testing. Users can be Operators or Administrators. Personnel refer to the person who performed the cleaning. When you have this field enabled you are able to enter the name of the person who cleaned a Location. This can be helpful for identifying training opportunities or star employees who consistently clean to standards.

Managing Users

To modify an existing user, first make sure you're logged in as an administrator.

To log in as an administrator, first log out by holding the Power button and selecting Log Out. Then log into an Administrator account.

1. Touch the user icon.
2. Touch the edit icon that looks like a pencil.
3. From here you can touch the red minus icon to delete a user or touch the pencil icon to modify.
4. Make the desired changes and touch the back button.
5. Touch check mark on right corner to save changes.

2.5.7 Customizations



EnSURE Touch is designed with you in mind, and allows you to customize it to fit your needs. To do this, open Settings and then touch Customization.

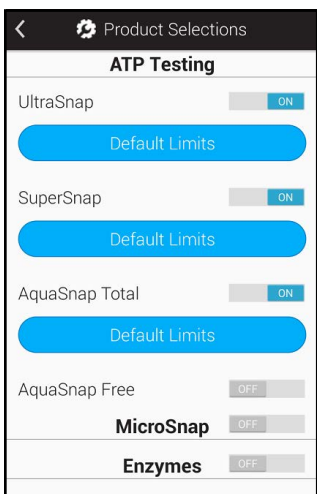

▶ Product Selections

This section will allow you to enable or disable test devices that you'll use with your instrument. For example, if your facility only uses UltraSnap you can disable the other test types. You can also modify the default limits for each test type.

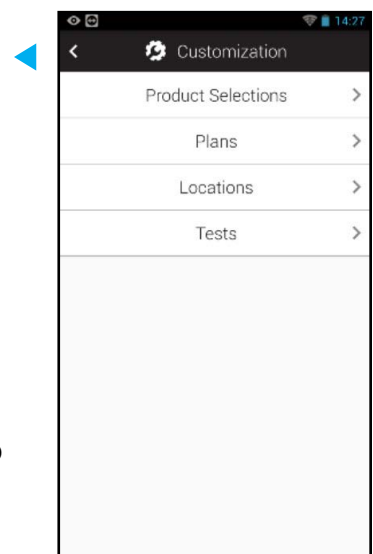

Simulation

Simulation is designed to make it easy to switch from another instrument. With simulation turned on, all test results produced using EnSURE Touch will simulate the test results that would have been received with the specified instrument. To use simulation, turn on simulation and select the instrument from which you'd like to simulate test results. Instructions for setting up simulation mode are [online](#).

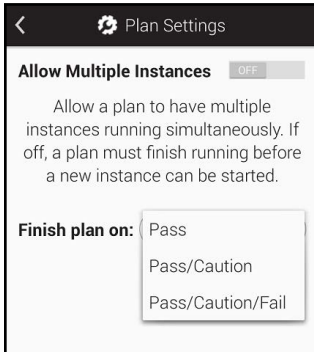

▶ Allow Multiple Instances

When turned on, you'll be able to run multiple instances of a plan simultaneously on the instrument. This is useful in some facilities such as hospitals, where it could be possible to have multiple concurrent Patient Room Plans occurring at the same time. For food and beverage plants, this is typically not used.

Finish Plan On

This allows you to specify the Pass/Caution/Fail level at which a plan will automatically finish. The default option is Pass/Caution which means that a plan will automatically finish if all the test results are pass or caution.

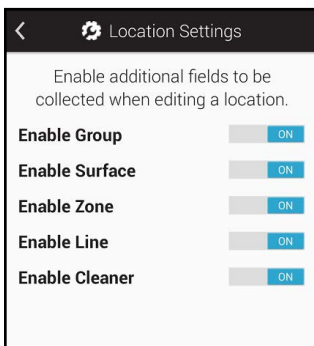

▶ Location Customizations

This screen allows you to enable or disable additional fields that can be used to provide more detail in relation to a testing location. For example, a facility may choose to enable Surface, in order to specify if a particular testing location is stainless steel or plastic.

Test Customizations

Tilt Check – a feature that verifies the instrument is held in an upright position during testing to ensure test accuracy. Although we recommend keeping this enabled, you have the option of disabling it.

Require Notes on Retest – When a retest is performed, it may be helpful to require notes be added for quality assurance and auditing purposes.

Enable Personnel – Allows the user to add which person performed the cleaning or is performing the test.

Enable Room # – Allows the user to record what room number the test was taken in. This is beneficial for healthcare facilities. It's typically not used by food and beverage plants. However, it can be used to collect additional data to help you organize your test results.

Enable Visual Inspection – Allows the user to record if visual inspection was completed prior to the test being completed.

Enable Product – Allows the user to record what product is being manufactured on that line.

Section 3: Further Help

3.1. Glossary

ATP (adenosine triphosphate)

Energy molecule found in every living or dead cell. Cells in food generally have much more ATP than bacterial cells.

Bioluminescence

Bioluminescence is a chemical reaction that produces light when ATP comes into contact with the enzyme luciferase. Hygiena's ATP testing devices use bioluminescence technology (combining ATP with luciferase) to produce a light output that can be detected and measured by the luminometer.

Biofilm

Biofilm occurs when microorganisms work together as a population and secrete a sticky polymer to form a solid matrix attached to a surface. Once a biofilm is established it is very difficult to eliminate. ATP levels will be higher in those spots that are harder to clean, spots that are missed in your current cleaning procedure, and spots that have developed biofilm. These areas should be established as control points for routine testing and monitoring.

Clean in Place (CIP)

Cleaning surfaces of processing equipment without disassembling or moving.

Clean out of Place (COP)

Moving and disassembling equipment before cleaning.

Control Points (CP)

Control points within an environmental monitoring program are direct and indirect contact areas where potential contamination hazards can be identified, controlled and monitored.

Corrective action

Action taken to remove the cause of contamination or other quality problem to prevent it from recurring.

Good Manufacturing Practices (GMP)

System in place for processing food safely under sanitary conditions. GMPs apply to staff, the physical plant, operations, sanitation methods and verification, equipment use and maintenance, and action taken to address defects and hazards.

HACCP (Hazard Analysis and Critical Control Points)

HACCP is a widely accepted systematic approach to the identification, evaluation and control of significant food safety hazards in the food manufacturing and processing industries.

RLU (Relative Light Units)

A RLU is an amount of light measured by a luminescence system. All systems measure light but how they convert light to RLUs will vary based on electronics and instrumentation. RLUs are not a standardized unit of measurement. It is a unit of measure unique to each specific ATP hygiene monitoring system and therefore scales can be different among systems.

SSOP (Sanitation Standard Operating Procedures)

Sanitation procedures in food production plants. They are considered a basic requirement in a HACCP program.

3.2. Contact Hygiena

For any questions about environmental monitoring, or more information about Hygiena products, please contact Hygiena at:

Hygiena, LLC (HQ):

941 Avenida Acaso
Camarillo, CA 93012
USA
1-805-388-8007

Hygiena Canada Ltd:

2650 Meadowvale Blvd Unit 14
Mississauga, Ontario L5N 6M5
1-833-494-4362 (Toll-free)
1-416-686-7962

Hygiena México, S.A. de C.V.:

Calle 3 Anegas 409 Bodega 5, Col. Nueva
Industrial Vallejo, Delegación Gustavo A. Madero,
C.P. 07700, CDMX, México
+52 (55) 5281-4108 y 5281-4146

Hygiena International Ltd:

8 Woodshots Meadow
Watford, Hertfordshire
WD18 8YU, UK
+44 (0) 1923-818821

Hygiena Diagnóstica España S.L.:

P.I. Paque Plata
Calle Cañada Real 31-35
41900, Camas, Sevilla, Spain
+34 954-08-1276

Hygiena (Shanghai) Trading Co. Ltd.:

Rm.7k, No. 518, Shangcheng Rd.
Pudong New District
Shanghai, China 200120
+86 21-5132-1080, +86 21-5132-1077,
+86 21-5132-1078



hygiena.com | help.hygiena.com

© 941 Avenida Acaso, Camarillo, CA 93012 | ☎ 800.863.6842 US | ☎ 302.695.5300 International

Hygiena™ and EnSURE™ are trademarks of Hygiena™ LLC.