



INSTALLATION MANUAL

ADVANTECHQUIET.COM







ATTENTION: This installation guide is intended to provide general information for the designer and end user. The following guidelines will help you safely and properly install the AdvanTech® subflooring. We urge you, and anyone installing this product, to read these guidelines to minimize any risk of safety hazards and prevent voiding any applicable warranties. This manual is a general installation guide and does not cover every installation condition. Proper installation shall be deemed to mean the most restrictive requirement specified by Huber Engineered Woods (HEW), local building code, engineer or architect of record, or other authority having jurisdiction. You are fully and solely responsible for all safety requirements and code compliance. For additional information contact Huber Engineered Woods LLC.



10925 David Taylor Drive, Suite 300
Charlotte, NC 28262
Phone: 800.933.9220 // Fax: 704.547.9228



SAFETY GUIDELINES: Follow all OSHA regulations and any other safety guidelines and safety practices during installation and construction.

-  Use approved safety belts and/or harnesses or other fall protection equipment.
-  Make sure the floor framing system is properly fastened to the supporting walls, beams, girders or other supports and is properly braced against roll over during floor panel installation. See floor joist or truss manufacture's installation instructions for additional information. Follow all OSHA regulations and any other safety guidelines and safety practices during installation and construction.
-  Wear rubber-soled or other high-traction footwear while installing AdvanTech subflooring in a roof application. Do not wear footwear with worn soles or heels.
-  Ensure the roofing surface is free from oil, chemicals, sawdust, dirt, tools, electric cords, air hoses, clothing and anything else that might create a tripping hazard.
-  Install temporary toe boards along the AdvanTech subflooring roof surface where needed.



CONTENTS

ADVANTECH® SUBFLOORING

OVERVIEW	6
NOTES & LIMITATIONS	7
STORAGE AND HANDLING	10
AVAILABLE PANEL SIZES	11
TOOLS	12
FASTENING GUIDE	12
GENERAL INFORMATION AND COMPATIBILITY	13
ADVANTECH SUBFLOOR ADHESIVE	14

ADVANTECH® SUBFLOORING - INSTALLATION

INSTALLATION STEP 1	15
INSTALLATION STEP 2	17
INSTALLATION STEP 3	19

ADVANTECH® SUBFLOORING - FLOOR COVERINGS

ALLOWABLE FLOOR COVERINGS	20
DIRECT APPLICATION	
Carpet and Pad	21
$\frac{3}{4}$ " Hardwood Flooring	22
Floating Engineered Wood/Vinyl Flooring	23
Engineered Wood Flooring	24



CONTENTS CONTINUED

SINGLE UNDERLAYMENT

Adhered Vinyl/VCP/LVP/VCT/ Commercial Carpet	25
---	----

TILE FLOOR SYSTEMS

Ceramic Tile	26
--------------	----



ADVANTECH® SUBFLOORING // OVERVIEW





Huber Engineered Woods (HEW) is committed to the responsible use of natural resources. AdvanTech® panels are produced from young, fast growing trees for less waste and faster availability. All parts of the log are used during production. Leftover chips, bark and sawdust are used as fuel to reduce energy use during manufacturing.

The International Code Council (ICC) Evaluation Service (ES) provides technical evaluations of building products for manufacturers that want to validate and qualify their products as having superior design properties. For years, HEW has maintained an ICC-ES report for its engineered wood subfloor, AdvanTech subflooring, to elevate it from other subfloors that only meet the PS-2 industry standard. The result? AdvanTech subflooring was issued the Evaluation Service Report, ESR-1785, certifying that it has endured a battery of testing protocols that measure and ensure greater and consistent levels of panel strength, stiffness and fastener holding power. For additional information, go to AdvanTechQuiet.com.

AdvanTech subflooring and sheathing panels, certified to be in conformance with requirements for U.S. Department of Housing and Urban Development (HUD-FHA) Use of Materials Bulletin #40C, bear the designation HUD-UM-40C within the stamp.



ADVANTECH® SUBFLOORING // NOTES & LIMITATIONS

-  Do not install water sealers on AdvanTech subflooring. This may void the limited lifetime warranty.
-  Do not use water-based, latex-based or hybrid adhesives with AdvanTech subflooring. A polyurethane or solvent based adhesive should be used.
-  AdvanTech subflooring is not designed for permanent exterior applications such as screened-in porches, exterior decks/porches/patios/open walkways, boats and boat docks, open bed trailers, scaffolding, exterior wood siding, furring strips, animal shelters and other permanently exposed applications. These applications would void the limited lifetime warranty.
-  AdvanTech subflooring should be dried-in under the finished roof and wall cladding assembly within 500 days of installation.
-  Avoid dropping panels on corners or edges.



ADVANTECH® SUBFLOORING // NOTES & LIMITATIONS

EXPOSURE

AdvanTech panels should not be used in applications that will expose the panels to weather permanently.

AdvanTech panels are not approved or certified for exterior exposure. Classified as Exposure 1 under PS-2, AdvanTech panels are intended to resist the effects of moisture due to construction delays or other conditions of similar severity but are not suitable for permanent exposure. Huber Engineered Woods allows AdvanTech subflooring panels to be exposed for up to 500 days.

FLAME SPREAD

AdvanTech subflooring and sheathing panels are recognized as having a Class C (III) flame spread rating without need for test or label by HUD/ FHA Manual of Acceptance Practices, Section 405-8 to the Minimum Property Standards.

FOUNDATIONS

Crawlspace foundations shall have a durable ground cover vapor barrier installed and may be vented or unvented. All foundations must be constructed in accordance with applicable code. In addition, panels should be acclimated to end use service conditions before applying necessary finished flooring.



ADVANTECH® SUBFLOORING // NOTES & LIMITATIONS

SUBFLOOR ADHESIVE

Use polyurethane or solvent-based subfloor adhesives that conform to industry standard APA AFG-01 or ASTM D 3498, and follow manufacturer's recommendations when installing AdvanTech subflooring. Recommended adhesives structurally bond the panel to the joist for a stronger, stiffer installation than panels installed with fasteners alone. Panels should span two or more floor joists with the long dimension perpendicular to the floor framing.

THINSET

When installing a thinset directly to AdvanTech subflooring use a modified thinset. Ensure the modified thinset is compatible with OSB substrates. It is not recommended to use non-modified thinset directly installed over the AdvanTech subflooring panels.

COATINGS

Oil-based paints, primers and stains can be applied to AdvanTech subflooring panels. Additional coatings that can be applied are 2-part epoxy/garage floor epoxy and bedliner coatings. DO NOT use water-based products or water sealers with AdvanTech subflooring.



ADVANTECH® SUBFLOORING // STORAGE & HANDLING

- ✔ Set panel stack on three supports (stickers) to keep off the ground.
- ✔ Outdoors, cover panels loosely with waterproof protective material.
- ✔ Anchor covers on top of the stack, but keep away from sides and bottom to assure good air circulation.
- ✔ In high moisture environments, cut banding on the panel stack to prevent edge damage.
- ✔ When using a forklift, put the stack on a pallet or supports to minimize damage from forks.





ADVANTECH® SUBFLOORING // PANEL SIZES

AdvanTech subflooring panels are available in 4' x 8' sheets with a tongue and groove* (T&G) profile. AdvanTech subflooring panels are Exposure 1 rated and are available in the following span ratings and performance categories. AdvanTech uses SFI sourced wood.

20 OC, 19/32 PERF CAT

Available lengths in 19/32" thickness:

- 4' x 8'

24 OC, Structural1, 23/32 PERF CAT

Available lengths in 23/32", Structural 1 thickness:

- 4' x 8'

32 OC, Structural1, 7/8 PERF CAT

Available lengths in 7/8" thickness:

- 4' x 8'

32 OC, Structural1, 1 PERF CAT

Available lengths in 1" thickness:

- 4' x 8'

48 OC, Structural1, 1-1/8 PERF CAT

Available lengths in 1-1/8" thickness:

- 4' x 8'

* (Actual face dimensions for tongue & groove panel are approximately 47-1/2" x 95-7/8")

ADVANTECH® SUBFLOORING // TOOLS

TOOLS

Common

- Pneumatic nail gun
- Generator
- Air compressor
- PPE

Recommended

- Collated screw gun
- Subfloor Adhesive Gun
- Framing Hammer

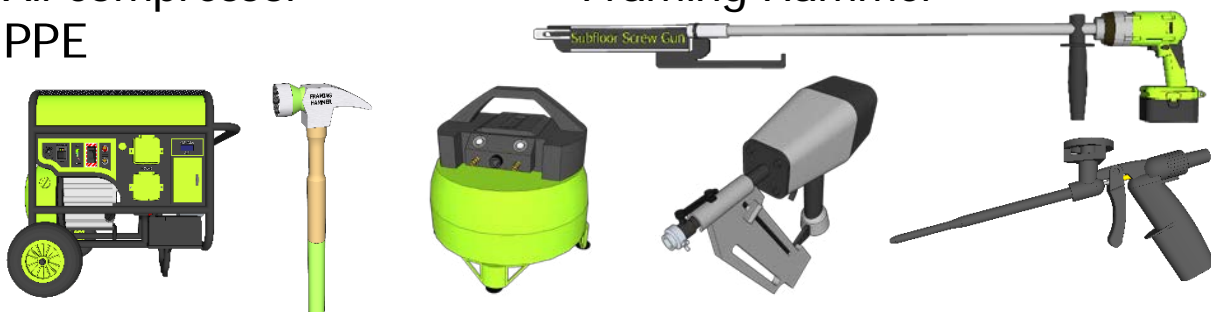

ADVANTECH® SUBFLOORING // FASTENING GUIDE

AdvanTech® subflooring panels are marked with circles denotes 16 inch o.c. framing, diamonds denotes 19.2 inch o.c. framing and squares denotes 24 inch o.c. framing.

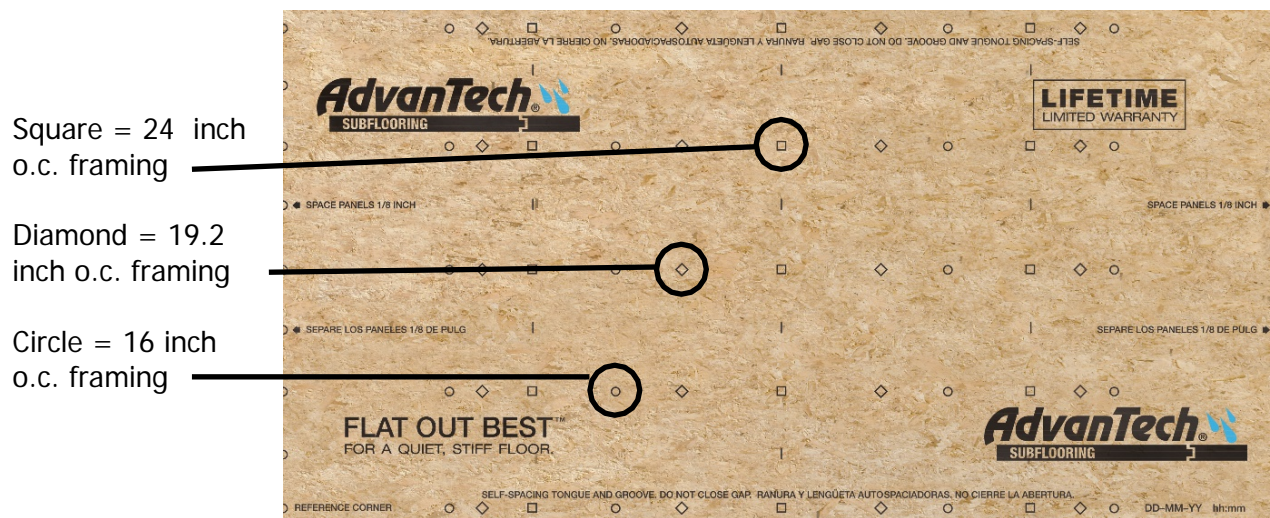



ADVANTECH® SUBFLOORING

// GENERAL INFORMATION & COMPATIBILITY

FASTENERS

Any code approved subfloor fastener can be used to attach the AdvanTech subflooring to framing. Nails, screws and hybrid fasteners can be used with AdvanTech subflooring. Hybrid fasteners do not eliminate the recommendation to use subfloor adhesive. See the table below for proper fastener selection.

Panel Thickness	≤ 23/32"	> 23/32"
Nail	8d	10d
Screw	#8	#9

The fastener must achieve at least 1-inch of penetration into the frame.

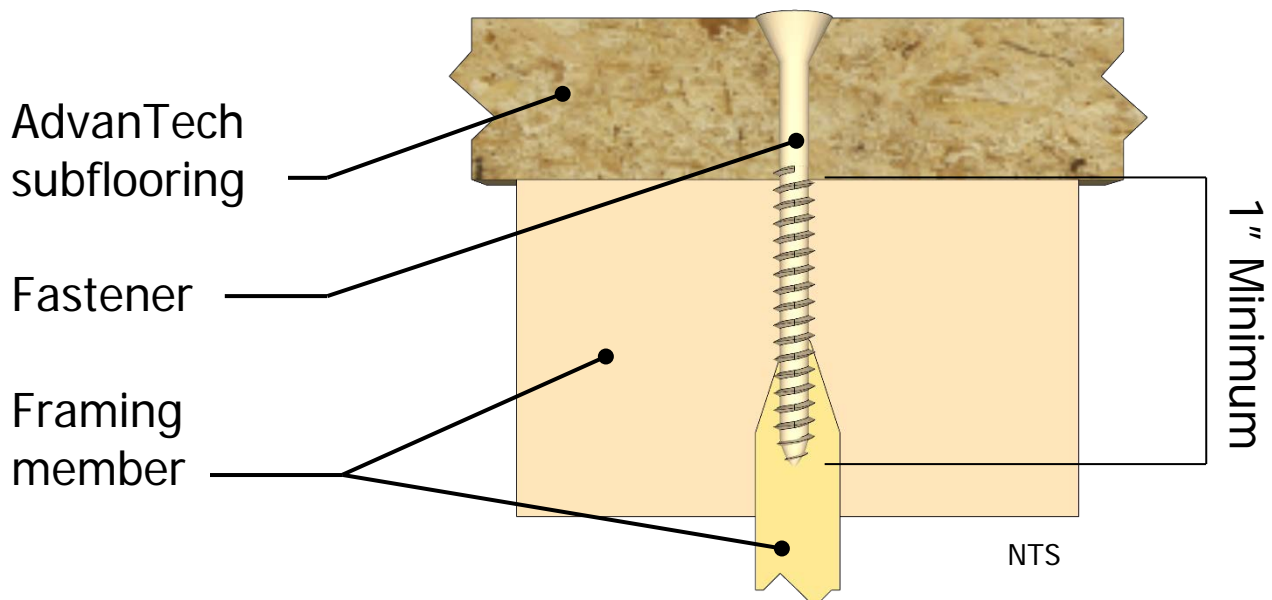

ADVANTECH® SUBFLOORING // ADVANTECH™ SUBFLOOR ADHESIVE

ADVANTECH™ SUBFLOOR ADHESIVE

AdvanTech™ subfloor adhesive is a polyurethane adhesive designed to bond subflooring panels to floor framing. The AdvanTech™ subfloor adhesive can provide a 10-year no squeak warranty wherever the subflooring panel meets framing for residential construction.

How to get the AdvanTech subflooring 10 -year no squeak warranty



Use AdvanTech subflooring panels. **1**

2 Use AdvanTech subflooring adhesive.

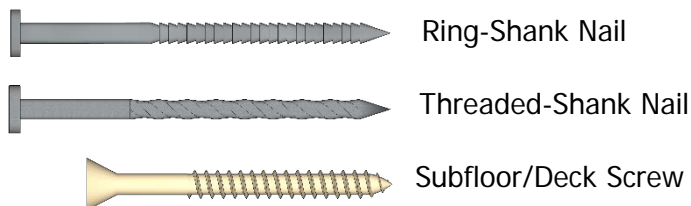

Use deformed fasteners. **3**

4 Use engineered wood-based framing (I-joist or truss)

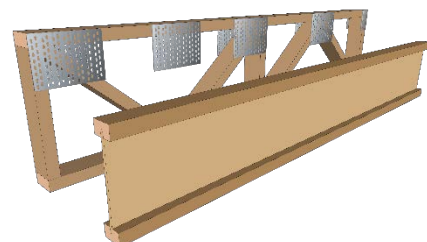

ADVANTECH® SUBFLOORING // INSTALLATION STEP 1

The following installation steps are presented as a general outline of the installation process. Apply a 3/8-inch bead of AdvanTech™ subfloor adhesive* (the adhesive should measure as 1/2-inch foam and will settle down to a 3/8-inch gel) to the top of the floor joists. The adhesive fills minor framing irregularities and provides a tight, even bond that helps prevent squeaks.



Where two subflooring panels come together on the same joist, apply two lines of adhesive to ensure both panels will have adhesive.

*Please see page 9 for compatible subflooring adhesive requirements when not using AdvanTech™ subfloor adhesive.



Apply only enough adhesive to lay one or two panels at a time to keep the adhesive from curing or skinning. Adhesive performance is affected when it begins to skin over or cure leading to squeaks or other problems. Install and store adhesives as directed by adhesive manufacturer.

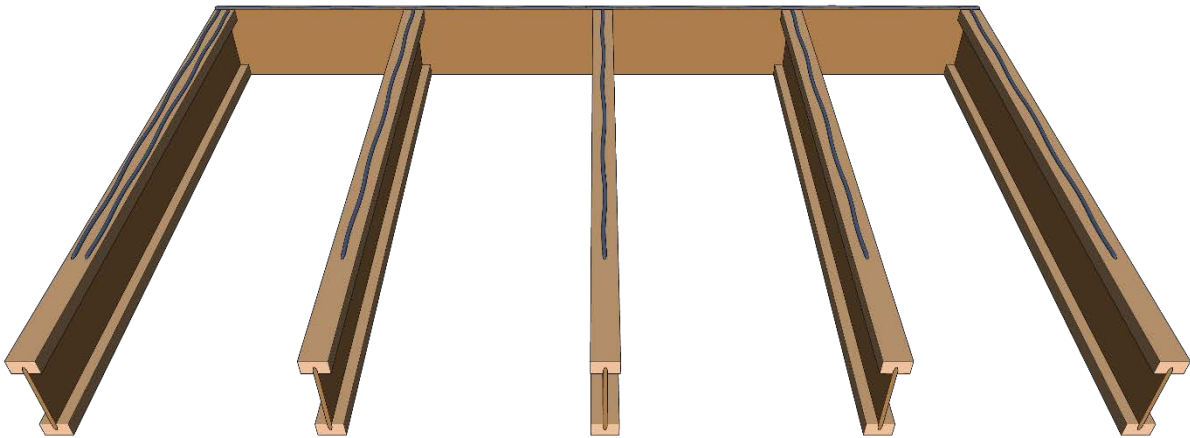

Immediately after applying the adhesive, lower the panel into place, making sure the panel is square on the joists. The top side of the panel should be facing up to allow for the certification stamp to be easily viewed from the bottom by local building officials.

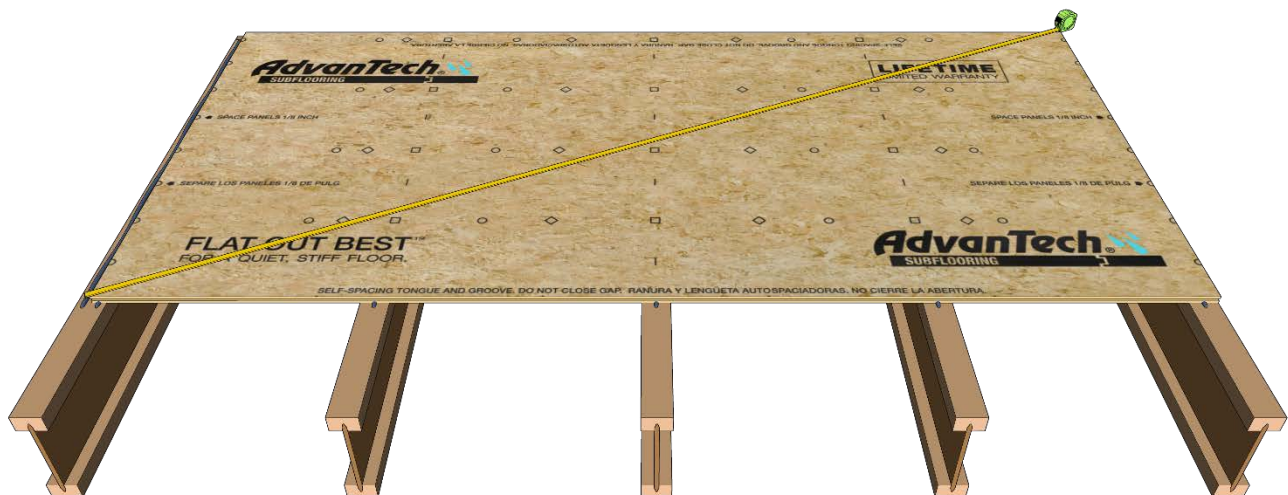

ADVANTECH® SUBFLOORING // INSTALLATION STEP 2

Snug the tongue and groove (T&G) edges together using wooden blocks and a framing hammer. Avoid excessive force that can damage the tongue or groove. Damaged tongues or grooves can give the appearance of edge swell and may require costly sanding and blocking.

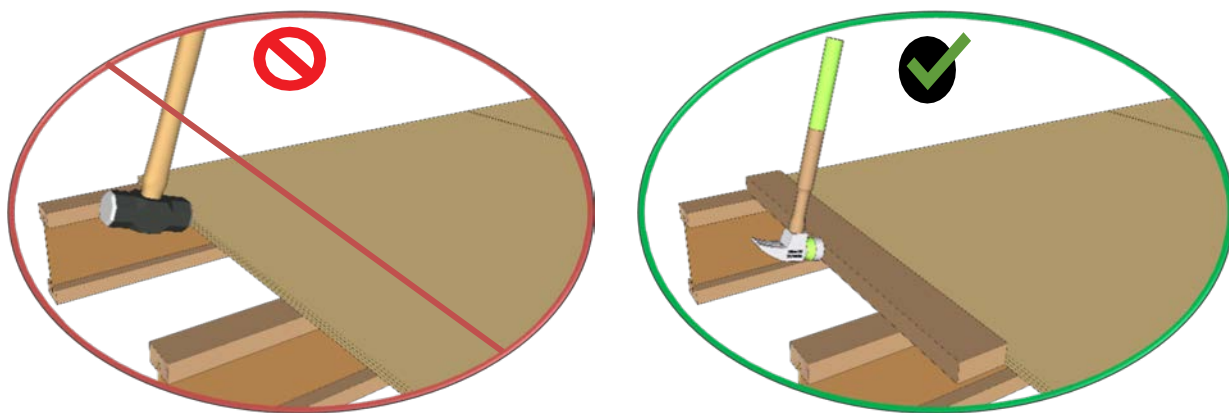

PRO TIP: Install the first row of AdvanTech subflooring panels with the tongue profile oriented towards the exterior. This allows for the wooden block to be placed on the groove when tapping the panel into place. This prevents crushing of the tongue.



The 8-foot length of the panels have a T&G profile. The T&G edges are designed to self-space the AdvanTech subflooring panels 1/8 inch.

The 4-foot lengths of the AdvanTech subflooring panels should be spaced manually 1/8 of an inch.

Stagger end joints of adjacent panel runs.

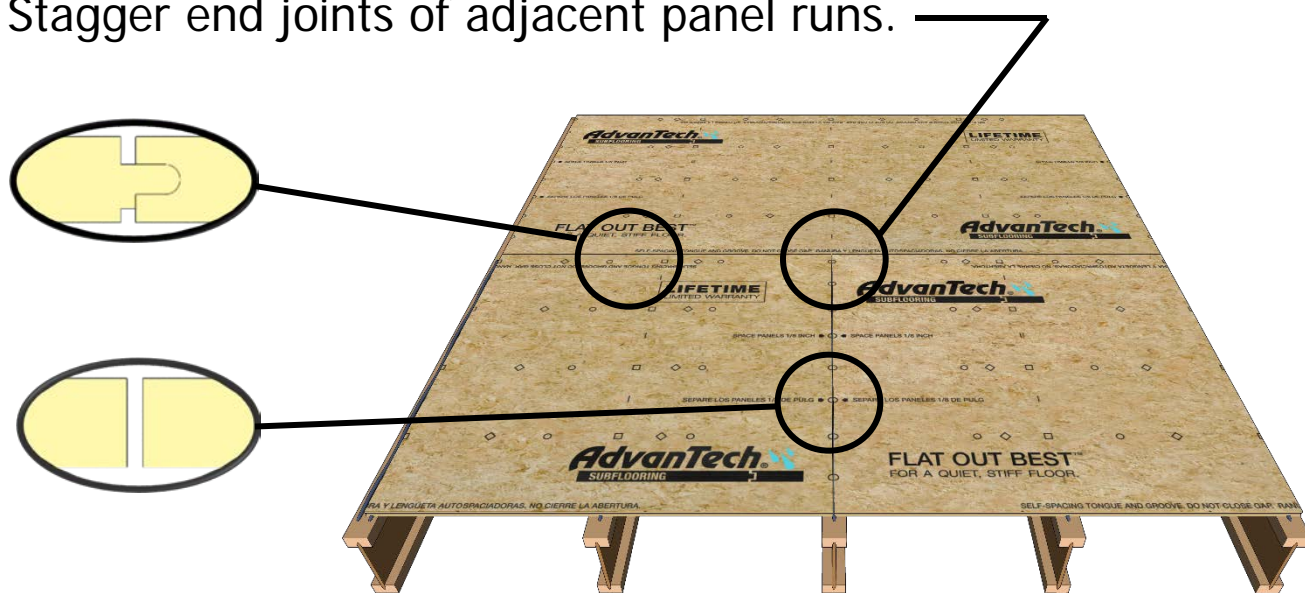

PRO TIP: use 8d nails to space the AdvanTech subflooring panels 1/8-inch.

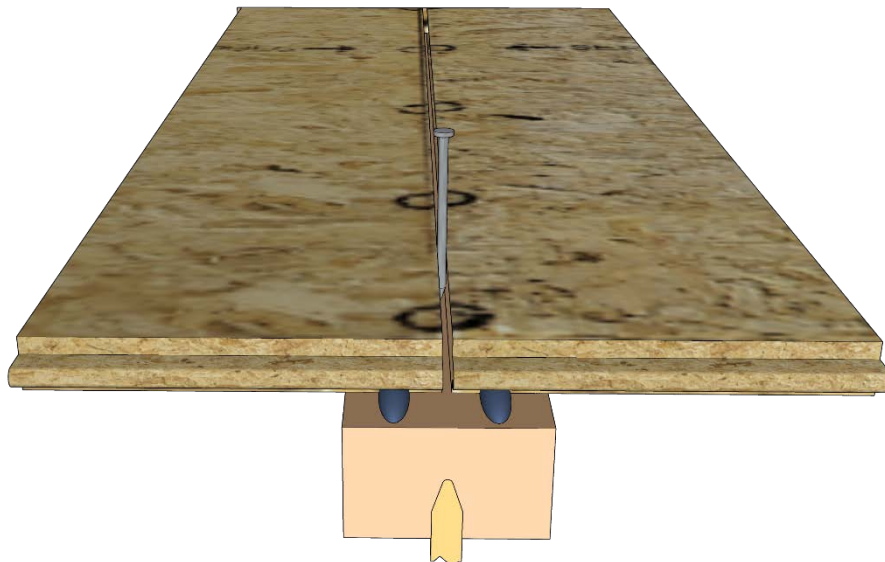

ADVANTECH® SUBFLOORING // INSTALLATION STEP 3

Install ALL required fasteners (edges and intermediate) prior to adhesive skinning or curing. DO NOT sequence fastener installations starting at corners followed by a later stage installation at edges and intermediate locations. ALL fasteners must be installed during the subfloor adhesive's stated open time.

- Start at one corner.
- Work your way to the remaining edges.
- Maintain a maximum edge distance of 3/8-inch to 1/2-inch.
- Heads should slightly penetrate the panel surface.
- Maintain a maximum spacing of 6-inch o.c. on supported edges (4-foot ends) and a maximum spacing of 12-inch o.c. at intermediate support locations.

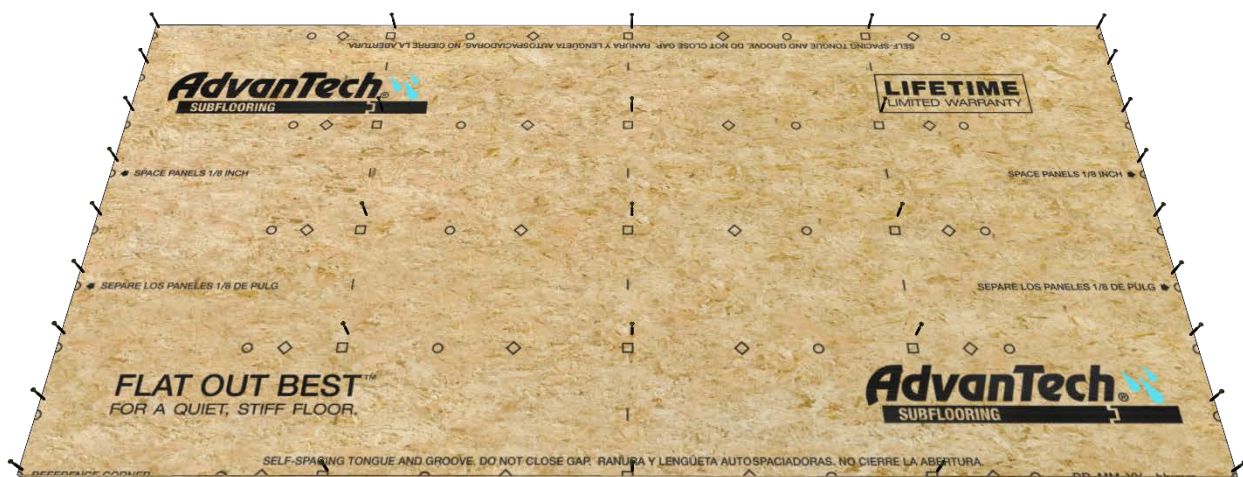

Shown for 24 o.c framing



ADVANTECH® SUBFLOORING // FLOOR COVERINGS

The following floor coverings can be installed over AdvanTech subflooring. Prior to installing the finished floor coverings over AdvanTech subflooring confirm with the finished floor manufacturer for framing and minimum subflooring thickness requirements. The following pages expand on the typical installation procedures for select flooring coverings but are not representative of all finished floor manufacturer requirements.

Direct Application

- Carpet and Pad
- ¾" Hardwood Flooring
- Floating Engineered Wood/Vinyl Flooring
- Engineered Wood Flooring

Single Underlayment

- Adhered Vinyl/Luxury Vinyl Tile (LVT)/ Vinyl Composite Tile (VCP)/Luxury Vinyl Plank (LVP)/ Vinyl Composite Tile (VCT)/ Commercial Carpet

Tile Floor Systems

- Ceramic Tile



ADVANETCH® SUBFLOORING // Direct Application

Carpet and Pad

STEP 1: Joists max spacing 24" o.c. with a 23/32" panel.

STEP 2: Follow AdvanTech subflooring installation as written in the previous sections of this installation manual.

STEP 3: Install padding and carpet per manufacturer's recommendations.

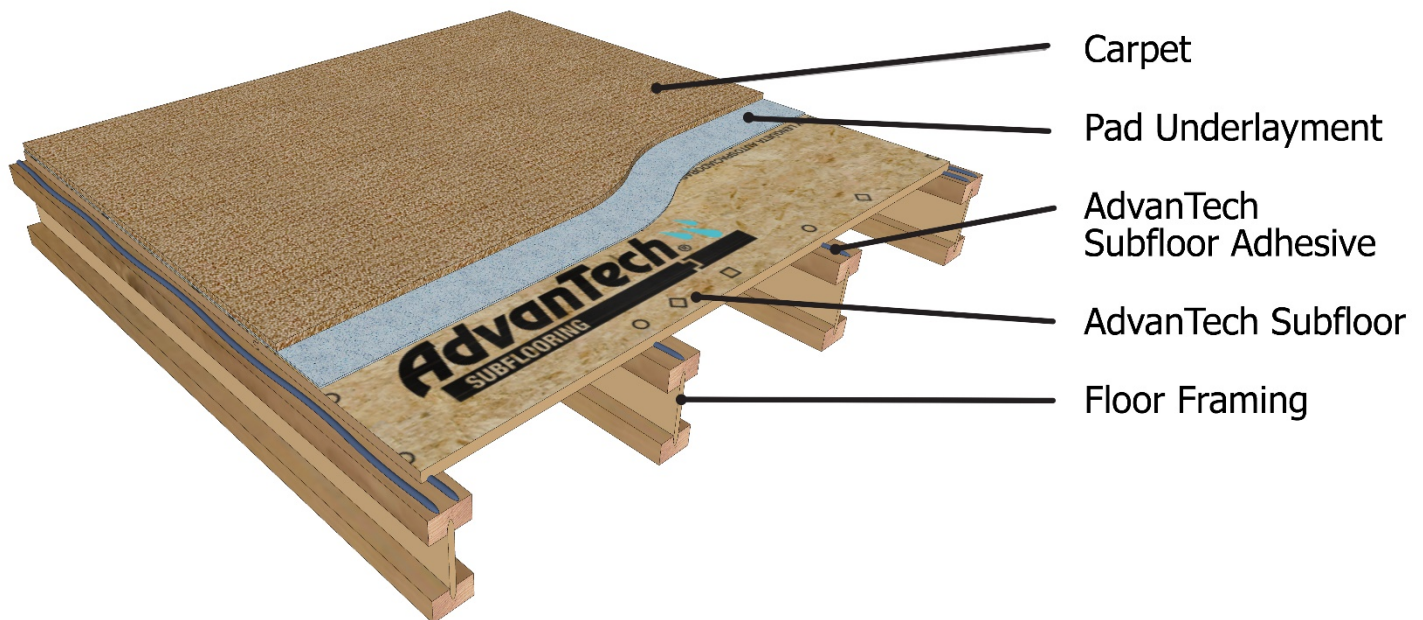

ADVANTECH® SUBFLOOR // Direct Application

Hardwood Flooring

STEP 1: Joists max spacing 19.2" o.c. with a 23/32" panel.

STEP 2: Follow AdvanTech subflooring installation as written in the previous sections of this installation manual.

STEP 3: The AdvanTech subflooring and the hardwood flooring moisture content should be $\leq 12\%$ and within 4% of each other. For wide plank flooring, please refer to flooring manufacturer's instructions as the moisture content tolerances are more stringent.

STEP 4: Use No. 15 felt or red rosin paper overlapping the edges 2-4" on top of AdvanTech subflooring.

STEP 5: Install hardwood flooring perpendicular to the joist system.

PRO TIP: Use additional 1/2" wood underlayment if installed parallel to the joist. Refer to manufacturer or NWFA for fastener and installation recommendations.

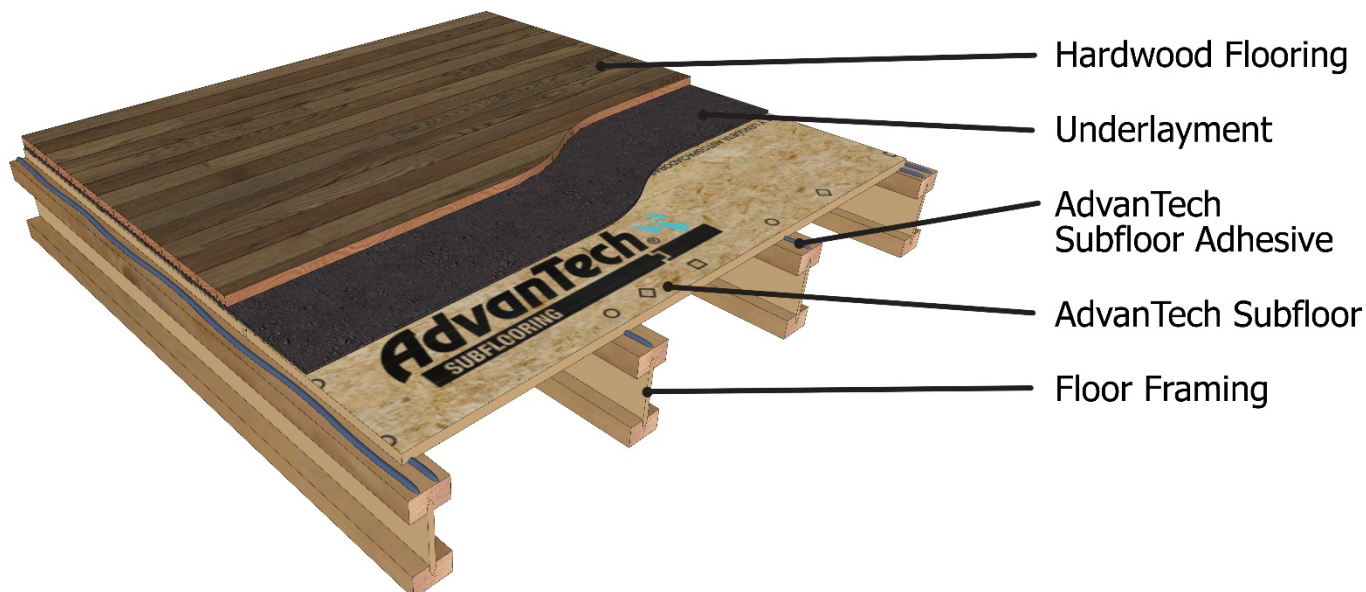



ADVANTECH® SUBFLOOR // Direct Application

Floating Engineered Wood/Vinyl Flooring

STEP 1: Joists max spacing 19.2" o.c. with a 23/32" panel.

STEP 2: Follow AdvanTech subflooring installation as written in the previous sections of this installation manual.

STEP 3: The AdvanTech subflooring and the floating hardwood flooring moisture content should be $\leq 12\%$ and within 4% of each other. For wide plank flooring, please refer to flooring manufacturer's instructions as the moisture content tolerances are more stringent.

STEP 4: Use cork or foam underlayment between AdvanTech subflooring and floating floor. Install flooring per the manufacturer's installation instructions.

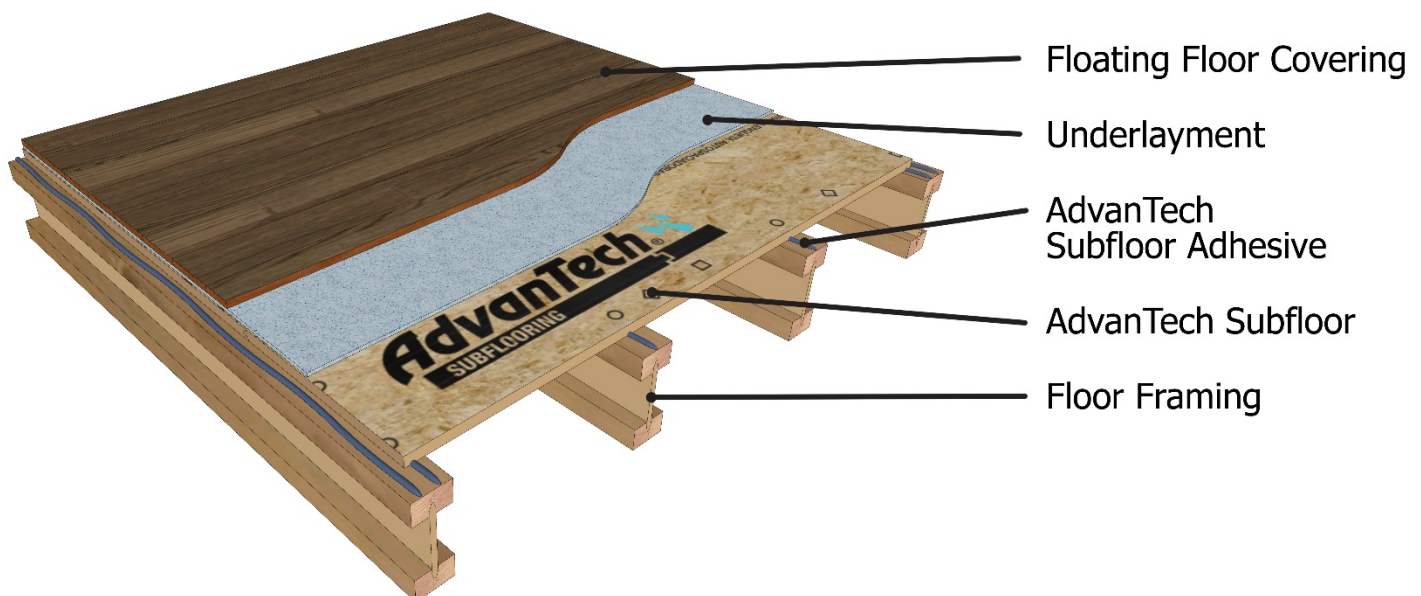



ADVANTECH® SUBFLOOR // Direct Application

Engineered Wood Flooring – Mechanically Fastened

STEP 1: Joists max spacing 19.2" o.c. with a 23/32" panel.

STEP 2: Follow AdvanTech subflooring installation as written in the previous sections of this installation manual.

STEP 3: AdvanTech subflooring and EWF moisture content should be $\leq 12\%$ and within 4% of each other. Refer to hardwood flooring manufacturer for expansion spacing and suggested fasteners.

STEP 4: Use No. 15 felt or red rosin paper overlapping the edges 2-4" on top of AdvanTech subflooring. Install EWF according to manufacturer's instructions.

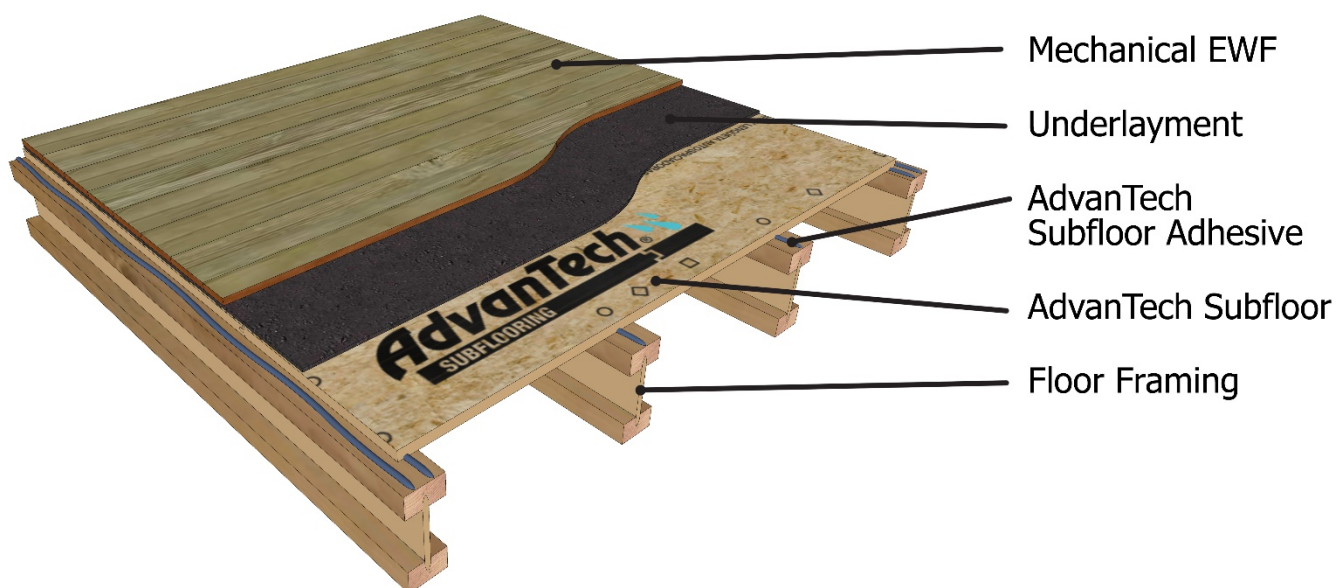



ADVANTECH® SUBFLOOR // Single Underlayment

Adhered Vinyl/VCP/LVP/LVT/VCT/Commercial Carpet

STEP 1: Joists max spacing 24" o.c. with a 23/32" panel.

STEP 2: Follow AdvanTech subflooring installation as written in the previous sections of this installation manual.

STEP 3: Install ¼" underlayment over AdvanTech subflooring. Note, fasteners of the underlayment should not extend beyond the bottom of the AdvanTech subflooring.

STEP 4: Apply adhesive with appropriate trowel size and install acclimated flooring covering material per manufacturer's instructions.

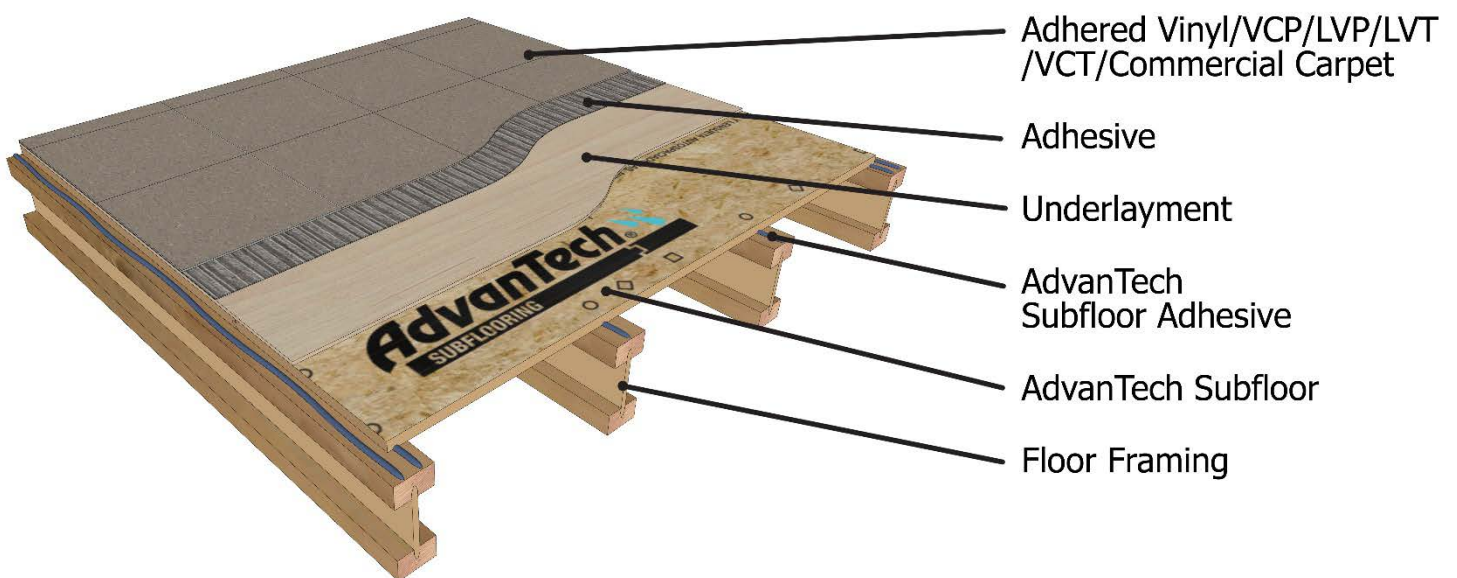

ADVANTECH® SUBFLOOR // Tile Floor Systems

Ceramic Tile

STEP 1: The max joist spacing is 16" o.c. with a 23/32" subflooring panel. For joists spaced 24" o.c. the Tile Council of North America (TCNA) states a minimum 1-1/8" subflooring panel or a two-layer subfloor should be used.

STEP 2: Follow AdvanTech subflooring installation as written in the previous sections of this installation manual.

STEP 3: Refer to TCNA to determine the appropriate backer board or uncoupling membrane and only use a modified thinset when adhering to AdvanTech subflooring.

STEP 4: Determine grade of thin-set to apply and install tile per manufacturer's recommendations.

STEP 5: Install the ceramic tile in accordance to the tile manufacturers written instructions.

