

Halloween Ball

by Color Principle

Free Project Sheet
NOT FOR RESALE



Quilt designed by Denise Russell.

Quilt 1

Quilt size: 61" x 61"

Skill Level: Advanced Beginner

 **Henry Glass & Co., Inc.**



facebook

49 West 37th Street
New York, NY 10018

Tel: 212-686-5194 - Fax: 212-532-3525

Toll Free: 800-294-9495

www.henryglassfabrics.com

Please check our website for pattern updates
before starting this project.

Halloween Ball - Fabrics in the Collection



3055P-99 Halloween Panel 24"
Black



3056P-99 Halloween Bag Panel
Orange

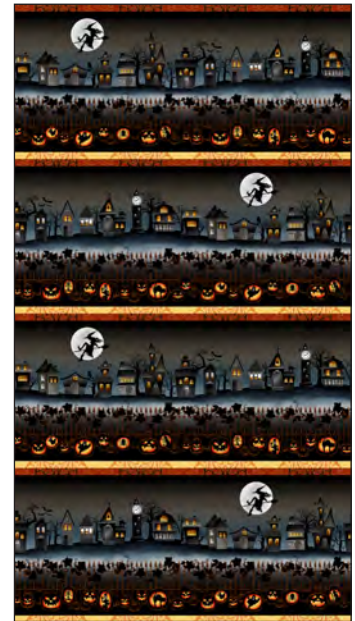

3054-99 Scary Border Stripe
Black



3053-99 Character Blocks
Black



3046-35 Jack-o'-lantern
Patch - Orange

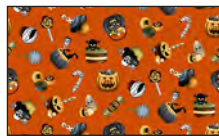

3047-35 Scary
Treats - Orange



3048-30 Witches
Brew - Lt. Orange



3049-99 Scary
Grins - Black



3050-99 Bat Wing
Damask - Black

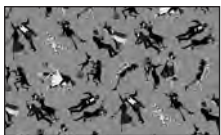

3051-95 Scary
Silhouette - Charcoal

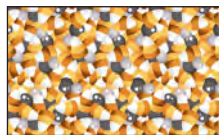

3052-35 Candy
Corn - Orange

Selected fabrics from the
Folio Basics Collection



7755-04
Off White



7755-36
Orange



7755-60
Olive



7755-65
Dk. Olive



7755-99
Black

Halloween Ball

- Quilt 1

Page 1

Materials

Yardages and cutting instructions are based on 42" of usable fabric width.

1/8 yard 7755-65 Folio - Dk. Olive
1/4 yard 3046-35 Jack-o'-lantern Patch - Orange
1/4 yard 3048-30 Witches Brew - Lt. Orange
1/4 yard 3049-99 Scary Grins - Black
1/3 yard 3052-35 Candy Corn - Orange
3/8 yard 7755-36 Folio - Orange
3/8 yard 7755-60 Folio - Olive
1/2 yard 3047-35 Scary Treats - Orange
1/2 yard 3050-99 Bat Wing Damask - Black
5/8 yard 7755-99 Folio - Black
1-1/2 yards 7755-04 Folio - Off White
2 yards 3054-99 Scary Border Stripe - Black
4 yards 3051-95 Scary Silhouette - Charcoal
for backing
Fusible web
Plastic for templates
Black thread for machine applique

Cut Fabrics

Note: All strips are cut across the width of the fabric (WOF) from selvage to selvage unless otherwise indicated.

From 7755-65 Folio - Dk. Olive, cut:

*One 2" x WOF strip. Sub-cut eight 1-1/2" x 2" strips.

From each, cut:

3046-35 Jack-o'-lantern Patch – Orange

3048-30 Witches Brew - Lt. Orange

*One 7-1/2" x WOF strip. Sub-cut four 6" x 7-1/2" rectangles.

From 3049-99 Scary Grins – Black, cut:

- Four cat heads with template A
- Two cat bodies with template B
- Two cat bodies with template B **reversed**

From 3052-35 Candy Corn – Orange, cut:

- Four each, cut with templates: triangles 1 and 1a
- Four each, cut with templates: triangles 2 and 2a
- Eight 3-1/8" x 4-1/4" rectangles

From 7755-36 Folio – Orange, cut:

*Seven 1-1/2" x WOF strips for border 5.

From 7755-60 Folio – Olive, cut:

*Eight 1-1/2" x WOF strips. Sub-cut:
- Sixteen 1-1/2" x 7-1/2" strips
- Sixteen 1-1/2" x 9-1/2" strips

From 3047-35 Scary Treats – Orange, cut:

*Five 2-1/2" x WOF strips for border 2.

From 3050-99 Bat Wing Damask – Black, cut:

*One 1-1/4" x WOF strip. Sub-cut:
- Four 1-1/4" x 2" strips (F)
- Four 1-1/8" x 2-1/4" strips (D)
- Four 1-1/8" x 6-3/8" strips (G)
*Two 5-1/2" x WOF strips. Sub-cut:
- Eight triangles, using the Hair template
- Four triangles, using the Hat template
- Four 1-1/4" x 9-1/2" strips

From 7755-99 Folio – Black, cut:

*One 1-1/2" x WOF strip. Sub-cut nine 1-1/2" squares.

*Seven 2-1/2" x WOF strips for binding.

From 7755-04 Folio - Off White, cut:

*One 1-5/8" x WOF strip. Sub-cut four 1-5/8" x 6-3/8" (H) strips.

*Two 2" x WOF strips. Sub-cut thirty-two 2" squares.

*One 3-1/8" x WOF strip. Sub-cut four 3-1/8" x 3-3/4" rectangles (C) and four 2" x 6-1/8" strips (E).

*One 3-1/2" x WOF strip. Sub-cut sixteen 2" x 3-1/2" strips.

*One 5-1/4" x WOF strip. Sub-cut four triangles 2 and four triangles 2a with templates.

*One 6-1/4" x WOF strip. Sub-cut four 6-1/4" x 9-1/2" rectangles.

*One 9-1/2" x WOF strip. Sub-cut twenty-four 1-1/2" x 9-1/2" strips.

*Ten 1-1/2" x WOF strips for borders 1 and 3.

From 3054-99 Scary Border Stripe – Black, cut:

*Four 6-1/2" x LOF strips for border 4.

Halloween Ball - Quilt 1

Assemble Blocks

Note: Measurements include 1/4" seam allowances. Sew with right sides together unless otherwise stated. If no direction is specified, press the seam toward the darker fabric.

- Trace templates A, B, 1, 1a, 2, and 2a on the plastic to make templates. Cut on the outline. Trace templates on the (wrong) side of the fabrics as listed in Table 1 below using a fabric marker or pencil. Cut on the outline using a ruler and a rotary cutter.

Template	Fabric
A – Trace four times B – Trace two times, reverse and trace two more times	3049-99 Scary Grins – Black
Hat: Trace four times Hair: Trace eight times	3050-99 Bat Wing Damask – Black
1 and 1a: Trace four times 2 and 2a: Trace four times	3052-35 Candy Corn – Orange
2 and 2a: Trace four times	7755-04 Folio - Off White

Table 1. Tracing instructions and fabric requirements.

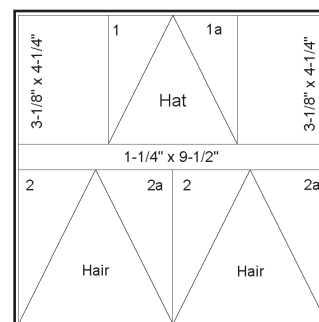

Witch Block Diagram

- With right sides together, sew a 3052-35 Candy Corn – Orange triangle 1 to a 3050-99 Bat Wing Damask – Black Hat triangle and press open. Sew an Orange triangle 1a to the other side of the Black Hat triangle and press open. Repeat to make four units. Sew a 3-1/8" x 4-1/4" 3052-35 Candy Corn – Orange rectangle to opposite sides of the hat units. Press the seams away from the center. Sew one 1-1/4" x 9-1/2" 3050-99 Bat Wing Damask – Black strip to the bottom of each unit (*figure 1*). Press the seams toward the Black strip.

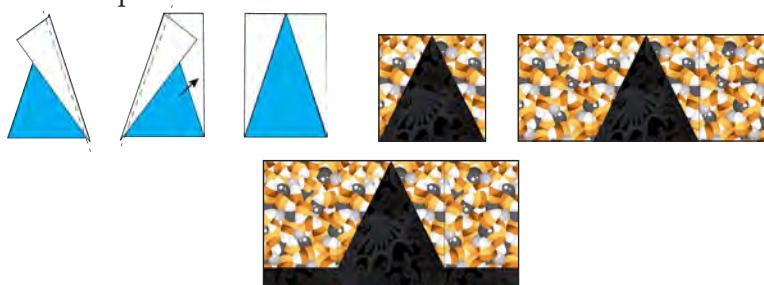

Figure 1 – Make (4) 5" x 9-1/2" rows.

- As in Step 2, sew a 3052-35 Candy Corn – Orange triangle 2 to the left side and a 7755-04 Folio - Off White triangle 2a to the right side of a 3050-99 Bat Wing Damask – Black Hair triangle and press open. Repeat to make four units.

Repeat this step with the remaining Black Hair triangles, this time sewing the Off White triangles 2 to the left and the Orange triangles 2a to the right side of the Black triangles. Sew one unit of each kind together to make four 5" x 9-1/2" bottom rows. Sew the bottom rows to the Step 2 units to complete four 9-1/2" witch blocks (*figure 2*, next page).

Halloween Ball

- Quilt 1

Page 3

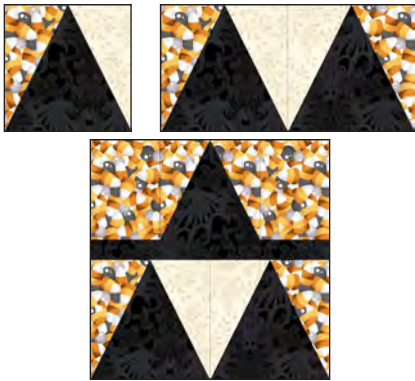

Figure 2 – Make (4) 9-1/2” blocks.

- Draw a diagonal line from corner to corner on the wrong side of the 2” 7755-04 Folio - Off White squares. With right sides together, place one marked Off-White square on a corner of one 6” x 7-1/2” 3046-35 Jack-o’-lantern Patch – Orange rectangle and stitch on the drawn line. Repeat with the other corners. Trim seam allowances to 1/4” and press open. Make four 6” x 7-1/2” units.

Repeat this step with the remaining 2” Off White squares and the four 6” x 7-1/2” 3048-30 Witches Brew - Lt. Orange rectangles (figure 3).



Figure 3 – Make (4) of each type.

- Sew a 1-1/2” x 2” 7755-65 Folio - Dk. Olive strip between two 2” x 3-1/2” 7755-04 Folio - Off White rectangles. Press the seams toward the darker fabric. Repeat to make eight strips. Sew one strip to the top of each Step 4 unit (figure 4). Press the seams in one direction.

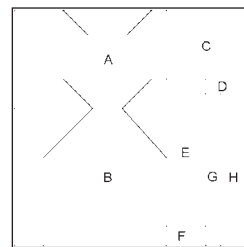

Figure 4

- Sew one 1-1/2” x 7-1/2” 7755-60 Folio – Olive strip to opposite sides of the Step 5 units. Press the seams away from the center. Sew one 1-1/2” x 9-1/2” Olive strip to the top and one to the bottom of each unit to complete the eight 9-1/2” pumpkin blocks (figure 5). Press as before.



Figure 5 – Make (8) 9-1/2” blocks.



Cat Block Diagram

- Place templates A (cat head) and B (cat body) onto the smooth side of the fusible web, trace the head four times and the body two times as is, then reverse the template and trace two more times. Cut each shape 1/8” outside the outline and fuse to the wrong side of the 3049-99 Scary Grins – Black fabric. Cut on the outline and remove the paper backing.

Position appliqué shapes on the 6-1/4” x 9-1/2” 7755-04 Folio - Off White rectangles, making sure the body is 1/4” away from the bottom and the right [for the left-facing cat] or left [for the right-facing cat] edges of the rectangle. Fuse the shapes according to the manufacturer’s instructions (figure 6, next page).

Halloween Ball

Machine appliqué using matching thread and the blanket stitch.



Fuse body 1/4" away from the edges

Figure 6 – Make 2 of each type.

- For the tails, sew a 3050-99 Bat Wing Damask – Black F strip to one short end of a 7755-04 Folio - Off White E rectangle. Press the seam toward the darker fabric [8.1 units]. Repeat to make four units. Sew a Damask – Black G strip to an Off White H strip. Press the seam as before. Repeat to make four units [8.2 units].

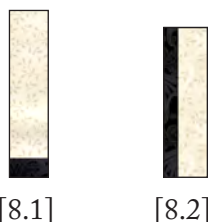

[8.1]

[8.2]

Noting fabric orientation, sew a Damask – Black D strip to the top of the [8.2] units such that the dark strip is on the left side of two units [8.3] and on the right side of the other two units [8.4]. Sew a [8.1] unit to the left of the [8.3] units, and to the right of the [8.4] units.



[8.3]

[8.4]

[8.1 + 8.3]

[8.4 + 8.1]

Sew a 7755-04 Folio - Off White C rectangle to the top of each unit (figure 7). Press the seams toward the last addition.



Figure 7 – Make 2 of each type.

- Referring to the diagram below, sew the Step 8 units to the Step 7 units to complete the four 9-1/2" cat blocks (figure 8). Press the seams open.



Figure 8 – Make (2) 9-1/2" blocks of each type.

Assemble Quilt Top

- Referring to the quilt photo for block placement and orientation, lay out four blocks and three 1-1/2" x 9-1/2" 7755-04 Folio - Off White sashing strips in four rows, and join the blocks and sashing strips together in each row. Press the seams toward the sashing.
- To make the horizontal sashing rows, sew together four Off White sashing strips and three 1-1/2" 7755-99 Folio – Black cornerstone squares. Repeat to make three sashing strips. Press the seams toward the sashing.
- Matching adjacent seams, sew block rows and horizontal sashing strips together. Press the seams in one direction.
- For border 1, sew five 1-1/2" 7755-04 Folio - Off White border strips together end to end using diagonal seams. Measure the vertical length of the quilt top through the center and cut two border strips that length. Sew one

Halloween Ball - Quilt 1

Page 5

strip to each side of the quilt top. Measure the width of the quilt top through the center. Cut two border strips that length and sew one to the top and one to the bottom. Press the seams toward the borders.

14. Repeat Step 13 with the five 2-1/2" 3047-35 Scary Treats – Orange strips to make and add border 2.
15. Repeat Step 13 with five 1-1/2" 7755-04 Folio - Off White strips to make and add border 3.
16. For border 4, mark the quilt center along the sides, top, and bottom. Mark the center of each 6-1/2" 3054-99 Scary Border Stripe – Black border strip. Matching the centers, sew each border strip in place beginning and ending exactly 1/4" from the corners. DO NOT trim the extra length.
17. To miter the borders, fold one corner of the quilt at a 45° angle so that the border strips are directly on top of one another and the seams nest together. Place your rotary ruler on the fold of the quilt so that the long edge is against the fold and the 45° line is on the side of the seam. Draw a line from the corner of the quilt top to the outside edge of the border. Pin the borders together. Position your needle on the inside corner where the border meets the quilt.

Stitch directly on the line you have drawn to the outside edge of the border. Trim the excess fabric leaving a 1/4" seam allowance. Press. Repeat the process for the remaining three corners of the quilt.

18. Repeat Step 13 with the seven 1-1/2" 7755-36 Folio – Orange strips to make and add border 5.

Finishing

19. Create a quilt sandwich with the batting between the quilt top and the backing. Pin or baste layers together, mark the quilting design, and quilt by hand or machine. When quilting is complete, remove pins or basting, and trim batting and backing even with raw edges of the quilt top.
20. Join the seven 2-1/2" 7755-99 Folio – Black binding strips together end to end using a diagonal seam to make one long strip. With wrong sides together, fold in half lengthwise and press. Sew binding to the edges of the quilt, mitering corners, and overlapping ends. Fold binding to the back of the quilt and stitch it in place by hand to finish.

©2022 Henry Glass & Co. Inc.

Every effort has been made to ensure that all projects are error free. All the information is presented in good faith; however, no warranty can be given nor results guaranteed as we have no control over the execution of instructions. Therefore, we assume no responsibility for the use of this information or damages that may occur as a result. When errors are brought to our attention, we make every effort to correct and post a revision as soon as possible. Please make sure to check www.henryglassfabrics.com for pattern updates prior to starting the project. We also recommend that you test the project prior to cutting for kits. Finally, all free projects are intended to remain free to you and are not for resale.

Halloween Ball - Quilt 1

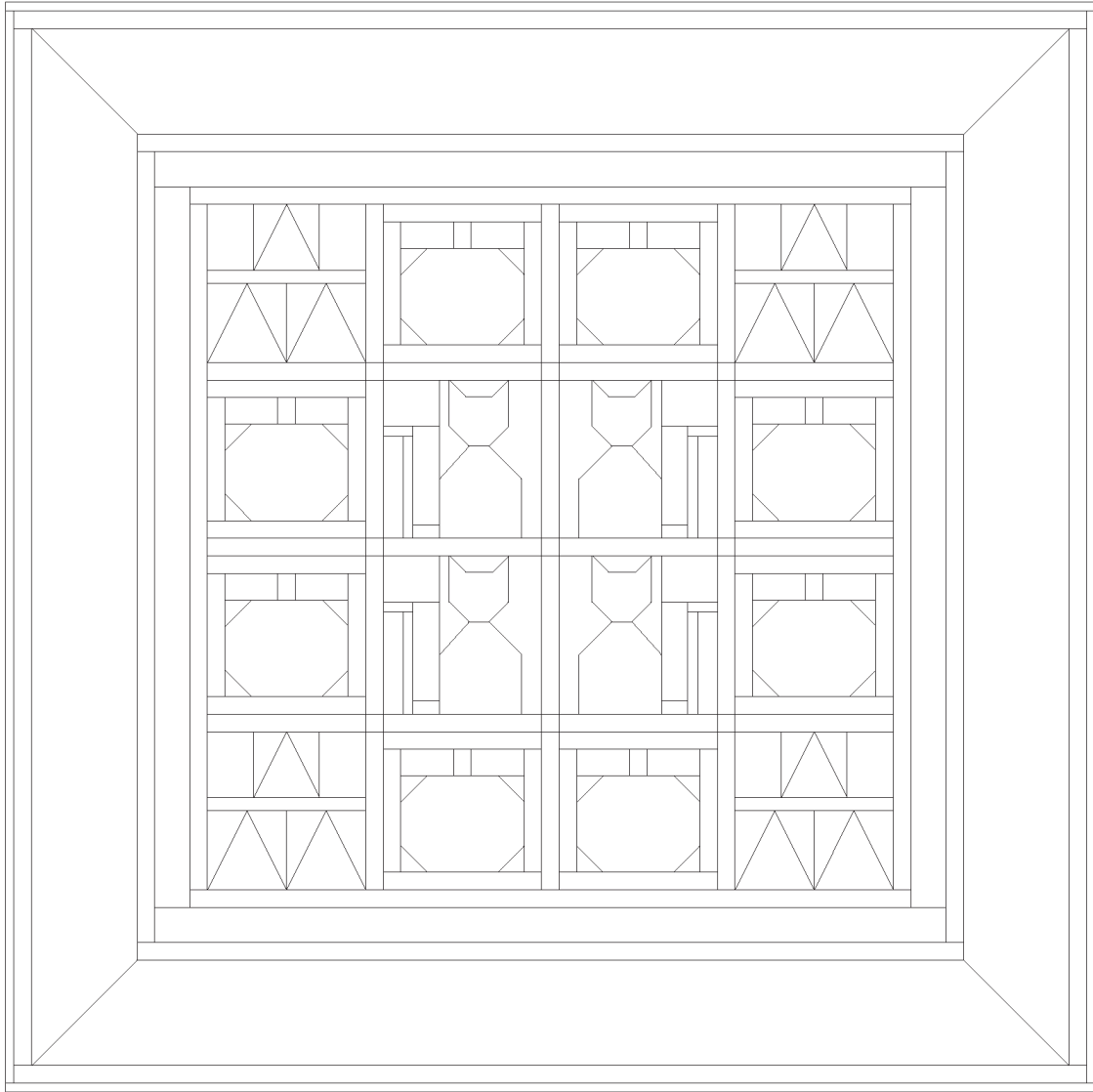

Quilt Diagram

Halloween Ball - Quilt 1

Templates

100% Scale

Already reversed (**except cat body**)

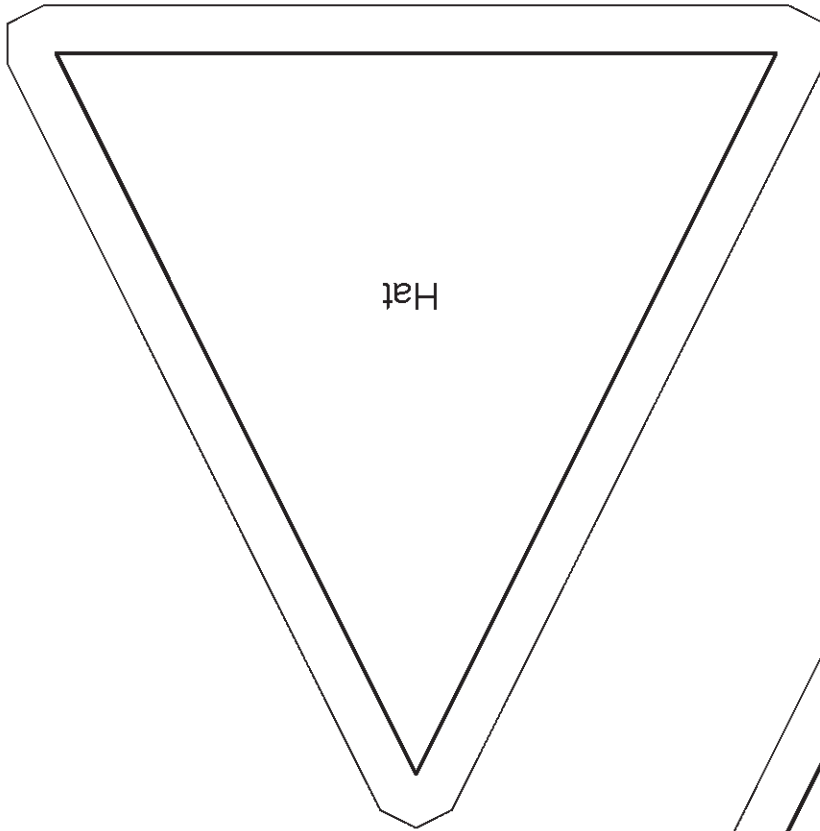

Hat

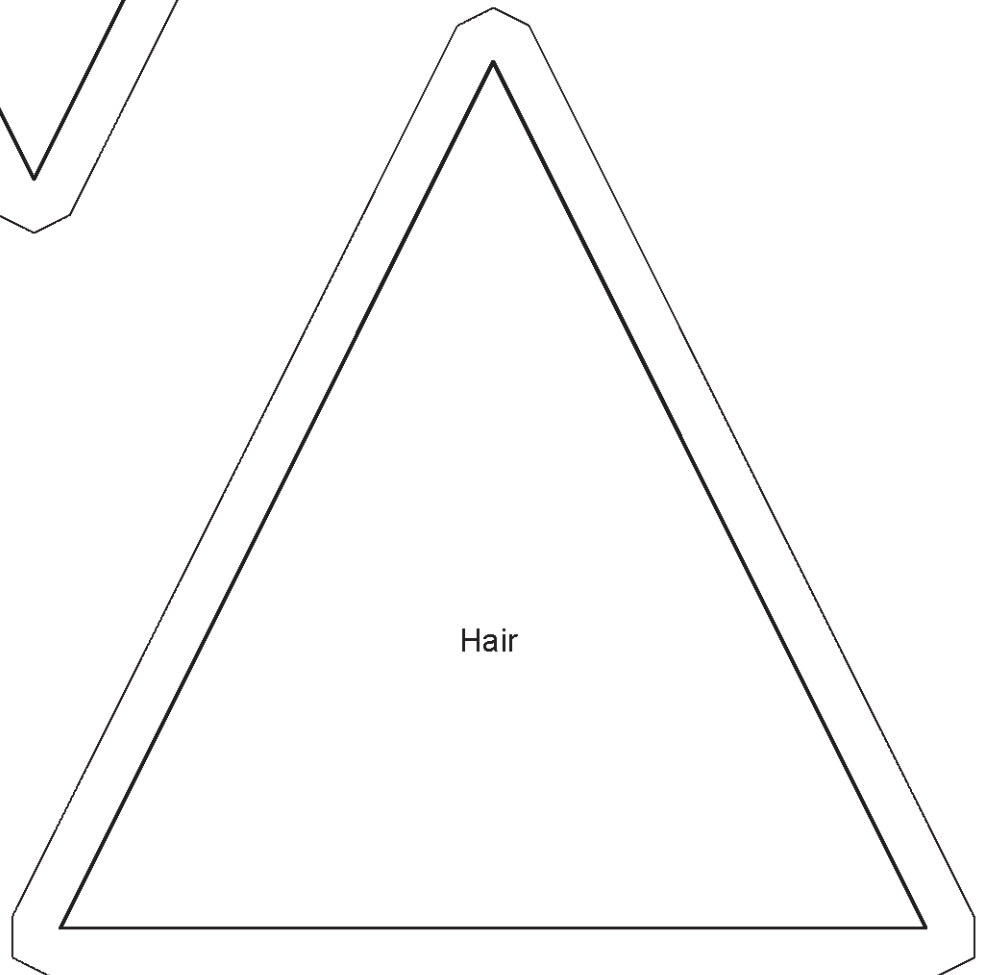

Hair

Halloween Ball - Quilt 1

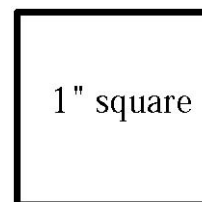
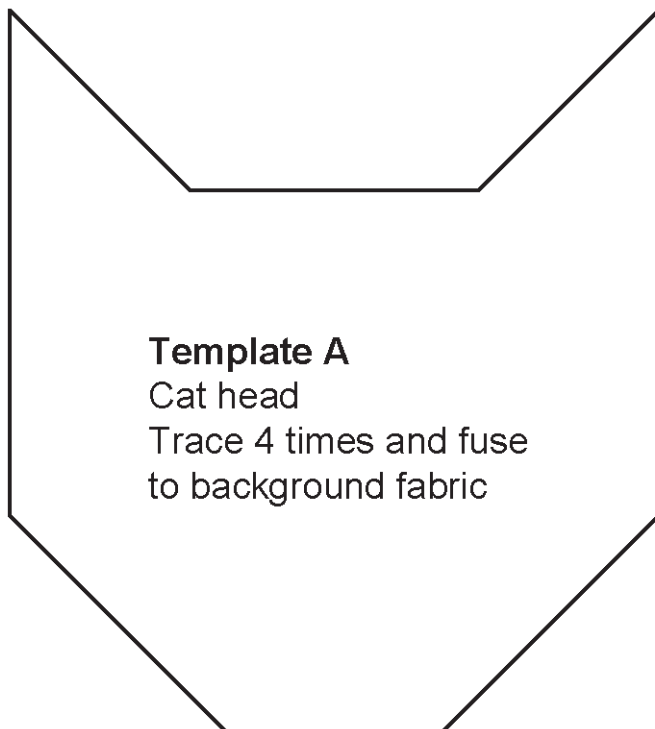
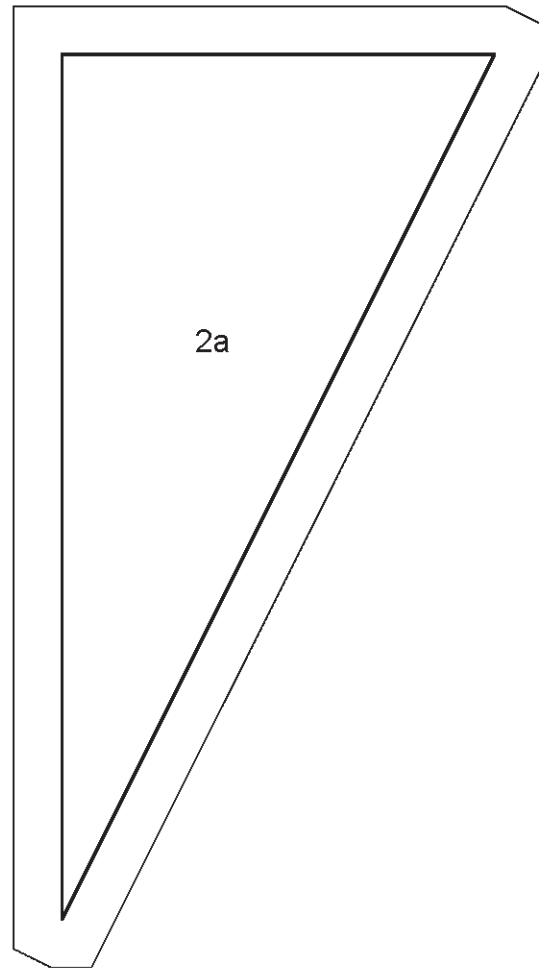
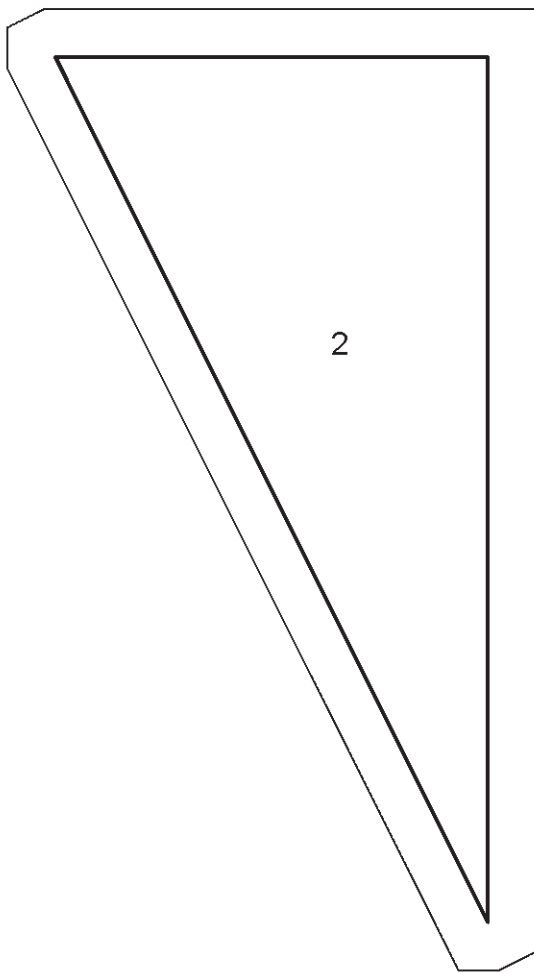

Halloween Ball - Quilt 1

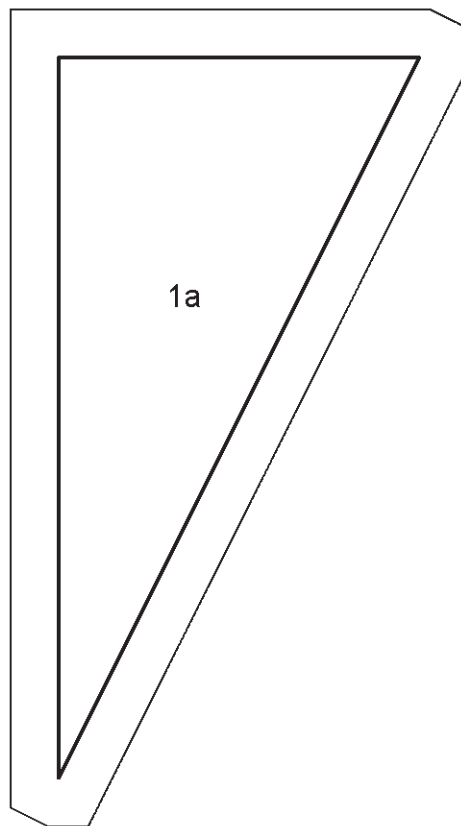
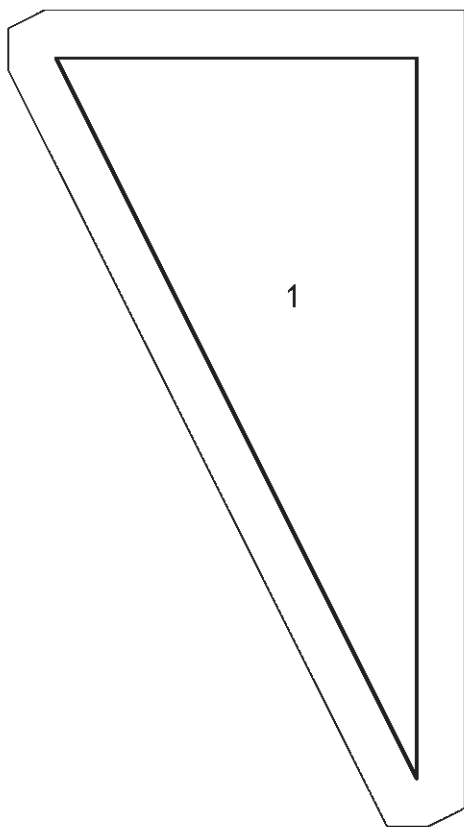

Template B
Cat body
Right facing cat: Trace onto fusible web two times as is
Left facing cat: Reverse template and trace onto fusible web two more times.