

**ANALYSIS OF DETERMINATIVE PARAMETERS
FOR MAINTAINING THE TECHNICAL AND
OPERATIONAL COMPATIBILITY OF 1520 mm and
1435 mm GAUGE RAILWAY SYSTEMS AT THE CIS-
EU BORDER**

SUBSYSTEM: POWER SUPPLY

Document produced by the ORC-ERA Contact Group

2010

REVISIONS AND AMENDMENTS

Revision and date	Sections	Note	Author
0.00/ 19/03/2009	All	Working paper, scope of application, list of parameters	FAD
0.01/ 14/05/2009	4, 5	Working paper, based on materials received to 14/05/2009.	FAD
0.02/ 20/05/2009	5	Working paper, based on meeting of 20/05/2009.	FAD VK
0.03/ 18/09/2009	4, 5	Working paper, based on material received to 18/09/2009	FAD
0.04/ 01/10/2009	5, 6	Working paper, based on meeting of 01/10/2009.	FAD VK
0.05/ 18/01/2010	2, 3, 5, 6	Draft for approval at meeting of 26-28/01/2010	FAD
1.00/ 28/01/2010	2, 3, 5	Document approved by the contact group	FAD VK

CONTENTS

1	SCOPE OF APPLICATION.	5
2	REGULATORY (BASELINE) DOCUMENTS	6
3	TERMS AND ABBREVIATIONS	11
4	LIST OF DETERMINATIVE PARAMETERS	13
5	ANALYSIS OF DETERMINATIVE PARAMETERS	15
5.1	POWER SUPPLY.....	16
5.1.1	Voltage and frequency.....	16
5.1.2	Parameters relating to supply system performance	17
5.1.3	Continuity of power supply in case of disturbances in tunnels	18
5.1.4	Current capacity, DC systems, trains at standstill.....	19
5.1.5	Regenerative braking	21
5.1.6	Electrical protection coordination arrangements.....	23
5.1.7	Harmonics and dynamic effects for AC systems	24
5.1.8	Electric consumption measuring equipment.....	25
5.2	GEOMETRY OF THE OCL AND QUALITY OF CURRENT COLLECTION	26
5.2.1	Geometry of the overhead contact line.....	26
5.2.2	Pantograph gauge	28
5.2.3	Mean contact force.....	31
5.2.4	Dynamic behaviour and quality of current collection.....	32
5.2.5	Pantograph spacing.....	36
5.2.6	Contact wire material.....	37
5.2.7	Phase separation sections.....	38
5.2.8	Sectioning of DC systems	39
5.2.9	System separation sections.....	41
5.2.10	Special requirements for trains departure points for DC systems	42

5.3	Power supply in difficult weather conditions	43
5.4	Signs and indications for train staff	45
6	COMPARISON WITH 1435 MM GAUGE SYSTEM TARGET VALUES	51
6.1	POWER SUPPLY.....	51
6.1.1	Voltage and frequency	51
6.1.2	Parameters relating to supply system performance	51
6.1.3	Continuity of power supply in case of disturbances in tunnels	51
6.1.4	Current capacity, DC systems, trains at standstill	51
6.1.5	Regenerative braking	51
6.1.6	Electrical protection coordination arrangements.....	51
6.1.7	Harmonics and dynamic effects for AC systems	51
6.1.8	Electric consumption measuring equipment	51
6.2	GEOMETRY OF THE OCL AND QUALITY OF CURRENT COLLECTION	52
6.2.1	Geometry of the overhead contact line.....	52
6.2.2	Pantograph gauge	52
6.2.3	Mean contact force.....	52
6.2.4	Dynamic behaviour and quality of current collection.....	52
6.2.5	Pantograph spacing.....	52
6.2.6	Contact wire material.....	52
6.2.7	Phase separation sections.....	52
6.2.8	Sectioning of DC systems	52
6.2.9	System separation sections.....	52
6.2.10	Special requirements for trains departure points for DC systems	52
6.3	Power supply in difficult weather conditions).....	53
6.4	Signs and indications for train staff	53
7	ANNEXES.....	54

7.1	LIST OF MEMBERS OF CONTACT GROUP	54
7.2	LIST OF ISSUES REQUIRING FURTHER STUDY	54

1 SCOPE OF APPLICATION.

This document has been prepared by the joint contact working group of experts of the Organisation for Railway Cooperation (ORC) and the European Railway Agency (ERA) ("CONTACT GROUP") as part of the cooperation of the above named organizations in the analysis of the interoperability of railway systems inside and outside the EU with a gauge of 1520 mm (1524 mm in Finland), in accordance with the Memorandum of Understanding of 2009.

ORC has carried out this work on the basis of its programme for 2009 and subsequent years.

ERA has carried out this work on the basis of Section 2.1 (TSI Revisions) of the Mandate received by the Agency to perform certain tasks in accordance with Directives 96/48/EC и 2001/16/EC.

The Contact Group has analysed the existing technical specifications of the Energy subsystem for 1520 mm gauge railway systems and established the determinative parameters for maintaining compatibility with 1520 mm gauge railway systems at the CIS-EU border. This analysis is limited to technical and operational aspects of the railway systems. This analysis does not include high-speed rail (over 200 km/h).

This document reflects the technical requirements for the above parameters, as established by regulatory acts applicable in the 1520 mm space, and compares these requirements with the target values established for the main parameters of the 1435 mm gauge railway system in the draft TSI Energy, produced in accordance with the Directive on the Interoperability of European Common Railways.

The language used in this document is intended to reflect, and as far as possible to summarize, the technical requirements applicable in various states. The language used in this document should not be treated as a regulatory citation. For the precise wording of requirements refer to the documents indicated in Section 2.

The materials (technical information) in this document may be used to reflect the main parameters of the 1520 mm gauge system in the EU TSI for the purpose of maintaining the existing technical compatibility with 1520 mm gauge systems at the CIS-EU border.

2 REGULATORY (BASELINE) DOCUMENTS

[№] Short document title	Full document title
[1.] International/intergovernmental documents	
[1.1.] GOST 13109-97	GOST 13109-97 Electricity. Compatibility of Electromagnetic Technical Devices. Electricity Quality Standards in General Power Supply Systems
[1.2.] GOST 2584-86	GOST 2584-86 Copper and Copper Alloy Cables
[1.3.] Draft Energy TSI	Draft TSI for the power supply subsystem, trans-European conventional and high-speed railways (to be published in the Official Journal of the European Union in 2010)
[1.4.] Safety in Railway Tunnels TSI	TSI on safety in railway tunnels in the transeuropean conventional and high-speed railways (adopted by Resolution of the European Commission of 20 December 2007 (2008/164/EC)) Official Journal of the European Union (L 64, 07/03/2008)
[1.5.] EN 50163:2004	EN 50163:2004 <i>Railway applications – Supply voltages of traction systems</i>
[1.6.] EN 50367:2006	EN 50367:2006 <i>Railway applications - Current collection systems - Technical criteria for the interaction between pantograph and overhead contact line (to achieve free access)</i>
[1.7.] EN50388:2005	EN50388:2005 <i>Railway applications – Power supply and rolling stock – Technical criteria for the coordination between power supply (substation) and rolling stock to achieve interoperability</i>
[2.] Republic of Belarus documents	
[2.1.] Belarusian railway TOR.	Technical Operating Rules of the Belarusian Railways (approved by order of the Head of Belarusian Railways of 04.12.2002 № 292H).
[3.] Republic of Latvia Documents	
[3.1.] Latvian railway TOR	27.04.1999. KM Technical Operating Rules, №148

[№] Short document title	Full document title
[3.2.] TE-3199 Rules on Construction and Technical Operation of Electrified Railways	Instructions TE-3199 Elektrificēto dzelzceļu kontakttīkla uzbūves un tehniskās ekspluatācijas noteikumi (Rules on Construction and Technical Operation of Electrified Railways). Approved 26 May 1999
[3.3.] Pantograph Operating Manual	Operating Manual of 10.11.2006. (Pantograph manufacturer's instructions)
[3.4.] Instructions on Inspections of Pantographs at Placing in Service	Instructions on Inspections of Pantographs at Placing in Service of 25.11.1996. (LDZ)
[3.5.] Bad Weather Conditions Action Plan	Bad Weather Conditions Action Plan of 5.10.1989 (LDZ)
[3.6.] Latvian Railways Signalling Rules	26.09.2006. CM Rules on Railway Signalling Systems, №790
[4.] Republic of Lithuania Documents	
[4.1.] Lithuanian Railways TOR	<p>Technical Operating Rules of the Lithuanian Railways ADV/001 approved by order № 297 of the Minister of Railways of the Republic of Lithuania of 20-09-1996</p> <p>Lietuvos Respublikos susisiekimo ministro 1996 m. rugsėjo 20 d. įsakymas Nr. 297 „Dėl techninio geležinkelių naudojimo nuostatų patvirtinimo“</p>
[4.2.] Rules on Construction and Technical Operation of Overhead contact lines AE/41	Rules on Construction and Technical Operation of Overhead contact lines of Electrified Railways AE/41 (LG document)
[4.3.] Lithuanian Railways Signalling Rules	Railway Signalling Rules (LG document)
[5.] Republic of Poland Documents	
[5.1.] Ministry of Transportation and the Maritime Economy Resolution of 10.09.1998	Ministry of Transportation and the Maritime Economy Resolution of 10.09.1998 (Dziennik Ustaw № 151, p. 987).
[5.2.] Instructions on Operation of Power Supply Devices at the Medyka-Mostiscas Crossing	Instructions on operation of power supply devices at the: Medyka (PKP) - Mostiscas II (UZ)
[5.3.] Ministerial Resolution on Technical Requirements for Railway Construction (DU.151)	Ministerial Resolution on the Technical Requirements for Railway Construction (DU.151)
[5.4.] Signalling Instructions - E1	Signalling Instructions - E1 (PKP PLK A.O.)

[№] Short document title	Full document title
[6.] Russian Federation Documents	
[6.1.] Russian Federation Railways TOR	Technical Operating Rules of Russian Federation Railways. Approved by the RF Railways Ministry 26.05.2000 № TsRB-756.
[6.2.] PUTEKsS TsE-868	Rules on Construction and Technical Operation of Overhead Contact Lines of Electrified Railways. Approved by the RF Railways Ministry 11.12.2001 № TsE-868
[6.3.] Construction Rules for Railway Traction Power Supply Systems TsE-462	Construction Rules for Railway Traction Power Supply Systems. Approved by MPS RF 04.06.97 № TsE-462.
[6.4.] Instructions on Technical Servicing and Operation of Structures, Systems, Rolling Stock, and the Organization of Traffic on High Speed Passenger Rail Routes TsE-393	Instructions on Technical Servicing and Operation of Structures, Systems, Rolling Stock, and the Organization of Traffic on High Speed Passenger Rail Routes. Approved by MPS RF 30.04.2003 № TsE-393.
[6.5.] Instructions on Vertical Adjustment of Overhead Contact Lines TsET-2	Instructions on Vertical Adjustment of Overhead Contact Lines TsET-2. Approved by TsE MPS CCCP 23.10.80
[6.6.] Instructions on the Procedure for Use of Pantographs TsT-TsE-844	Instructions on the Procedure for Use of Rolling Stock Pantographs in Various Weather Conditions. Approved by MPS RF 03.07.2001 TsT-TsE-844
[6.7.] Russian Federation railways Signalling Instructions-757	Russian Federation railways Signalling Instructions. Approved by MPS RF 26.05.2000 № TsRB-757
[7.] Republic of Slovakia Documents	
[7.1.] Slovakia TOR	Railways Technical Operating Rules (P1) № 26221/1976 of 01.01.1978
[7.2.] Slovakian TOR Regulations	Regulations of the Federal Ministry of Transportation on the Railways Technical Operation Rules № 25188/1976
[8.] Ukrainian Documents	
[8.1.] Ukrainian railways TOR	Technical Operating Rules of Ukrainian Railways Approved by order of the Ministry of Transport of Ukraine № 411 of 20.12.1996.

[№] Short document title	Full document title
[8.2.] Transportation structures. 1520 mm gauge railways. Design standards. DBN B.2.3-19-2008	Transportation structures. 1520 mm gauge railways. Design standards. DBN B.2.3-19-2008 (Соруди транспорту. Залізниця колії 1520 мм. Норми проектування), approved by order of the Ministry of Regional Development and Construction of Ukraine of 26.01.2008 №42.
[8.3.] Rules on Operation of Electrical Installations, PUE -2009	Rules on Operation of Electrical Installations, PUE -2009. Printed with the approval of the State Energy Supervisory Agency (Gosenergonadzor) of Ukraine. These rules are binding for all ministries and departments, regardless of ownership. New chapters are approved by order of the Ministry of Fuel and Energy of Ukraine. Chapter 3 is printed in the version of 1985, approved by the USSR Ministry of Energy and Electrification.
[8.4.] Rules on Construction of Traction Power Supply Systems on Ukrainian Railways TsE-0009	Rules on Construction of Traction Power Supply Systems on Ukrainian Railways TsE-0009, approved by order of Ukrzaliznytsa of 24.12.2004 №1010-TsZ
[8.5.] Regulatory documents on the manufacture and use of pantographs	Regulatory documents on the manufacture and use of pantographs on the electric traction stock of electrified railways (specifications and manufacturer's operating instructions, approved by developers and coordinated with Ukrzaliznytsa in accordance with the established procedure).
[8.6.] Rules on Construction and Technical Servicing of Overhead contact lines TsE-0023	Rules on construction and technical servicing of overhead contact lines of electrified railways TsE-0023, approved by order of Ukrzaliznytsa of 20.11.2007 №546-Ts
[8.7.] Temporary Instructions on the Organization of High-speed Passenger Train Traffic. Infrastructure and Rolling Stock Requirements, VND 32.1.07.000-02	Temporary Instructions on the Organization of High-speed Passenger Train Traffic. Infrastructure and Rolling Stock Requirements, VND 32.1.07.000-02
[8.8.] Instructions on Use of Electric Rolling Stock Pantographs in Various Operating Conditions	Instructions on use of electric rolling stock pantographs in various operating conditions, approved by Ukrzaliznytsa of 12.10.2007 №789/TsZ

[№] Short document title	Full document title
[8.9.] Ukrainian Railways Signalling Instructions	Ukrainian Railways Signalling Instructions (Інструкція з сигналізації на залізницях України), approved by order of the Ministry of Transportation and Communications of Ukraine of 23.06.2008 №747
[8.10.] Rules on Use of Electrical Systems	Rules on Use of Electrical Systems
[8.11.] Transportation Structures. Railway Electrification. Design Standards DBN B.2.3-2-2009	Transportation Structures. Electrification. Design Standards (Споруди транспорту. Електрифікація залізниць. Норми проектування) DBN B.2.3-2-2009. Effective from 01.01.2010.
[9.] Republic of Estonia Documents	
[9.1.] Estonian Railways TOR	Technical Operating Rules of Estonian Railways, approved by Resolution of the Minister of Transportation and Communications №39 of 09.07.1999
[9.2.] Estonian Railways Signalling Instructions	Signalling Instructions (annex 1 to Estonian railways TOR)
[9.3.] Rules on Technical Operation and Construction of Overhead contact lines	Rules on technical operation and construction of overhead contact lines of electrified railways. Annex to the Rules on Entrepreneurial Activities in the Railways Sector (drafted by the Infrastructure Manager and approved by the Republic of Estonia Technical Supervisory Department).

3 TERMS AND ABBREVIATIONS

Abbreviation	Definition
AR	Automatic reclosing
GOST	Interstate standard
DSTU	State Standardization System of Ukraine
r.d.	Railway [not used in English]
r/w	Railways [not used in English]
CM	Cabinet of Ministers
LDZ	Latvian Railways
LG	Lithuanian Railways
MTU	Motor Train Units
MPS	Railways Ministry
RS	Rolling stock
TOR	Technical Operating Rules
CCS	Control, Command and Signalling
TU	Traction units
TSI	Technical Specifications for Interoperability
TO	Technical operation
CSRI	Central Scientific Research Institute
TsRB	Traffic Safety Department (RF), Main Department of Traffic Safety and the Environment (Ukraine)
ERS	Electric Rolling Stock
AC	Alternating current
ADV	Rail traffic rules
DC	Direct current
EN	European Norm
LHS	OOO Large-gauge Metallurgical Railway Lines
LVS	Latvian State Standard
OCL	Overhead contact line
PN	Polish standard

Term	Definition
Overhead contact line	System of suspended cables on isolating supports that ensure the contact wire is in the required position and transferring electrical current to the rolling stock.
Quality of current collection	Parameter for determining whether it is possible to transfer current between overhead contact line and pantograph for an extended period.
Section	Section of railway line between neighbouring stations, sidings, marshalling yards, or signalling posts.
Mainline	Sections or station lines that run on directly from adjoining sections and, as a rule, do not diverge at switches
Station	A point on the line capable of accepting, dispatching, combining, and shunting trains, servicing passengers, and where track facilities allow, marshalling to break up and form trains and perform technical operations with trains.
General line	A railway line equally accessible for freight and passenger trains, or for supporting other technological processes
Siding line Industrial siding line	A line intended to serve individual enterprises, organizations, institutions (factories, plants, mines, forestry works, power stations, traction substations, etc.), connected to the general rail network by an uninterrupted line and owned by the railway, enterprise, organization, or institution.

4 LIST OF DETERMINATIVE PARAMETERS

This list sets forth the determinative parameters for maintaining technical and operational compatibility of the Energy subsystem for 1520 mm gauge railways at the CIS-EU border. This list is produced on the basis of the Energy TSI, currently under development, and has been supplemented and adjusted subject to the specific requirements of 1520 mm gauge systems¹.

	Russian term	English term (according to draft Energy TSI)
1.	Электрические характеристики	<i>Power supply</i>
1.1.	Напряжение и частота	<i>Voltage and frequency (4.2.3)</i>
1.2.	Параметры производительности системы (пропускная способность системы)	<i>Parameters relating to supply system performance (4.2.4)</i>
1.3.	Непрерывность электроснабжения в случае сбоев в тоннелях	<i>Continuity of power supply in case of disturbances in tunnels (4.2.5)</i>
1.4.	Максимальная сила тока на остановках для систем электроснабжения постоянного тока	<i>Current capacity, DC systems, trains at standstill (4.2.6)</i>
1.5.	Рекуперативное торможение	<i>Regenerative braking (4.2.7)</i>
1.6.	Порядок координации электрической защиты	<i>Electrical protection coordination arrangements (4.2.8)</i>
1.7.	Гармоники и динамические эффекты в системах переменного тока (взаимное влияние подвижного состава и системы энергоснабжения)	<i>Harmonics and dynamic effects for AC systems (4.2.9)</i>
1.8.	Оборудования для измерения энергопотребления	<i>Electric energy consumption measuring equipment (4.2.21)</i>
2.	Геометрия контактной подвески и качество токосъёма	<i>Geometry of the OCL and quality of current collection</i>
2.1.	Геометрия контактной подвески	<i>Geometry of the overhead contact line (4.2.13)</i>
2.2.	Габарит токоприемника (рабочая зона токоприемника)	<i>Pantograph gauge (4.2.14)</i>
2.3.	Среднее нажатие токоприемника во время движения	<i>Mean contact force (4.2.15)</i>

¹ This list is based on the draft TSI, the list of parameters and their names in the final version of the TSI may differ from those in this document. Parameters 2.8, 2.10, 3 and 4 have been proposed by contact group members for additional consideration.

	Russian term	English term (according to draft Energy TSI)
2.4.	Динамические характеристики и качество токосъема	<i>Dynamic behaviour and quality of current collection (4.2.16)</i>
2.5.	Расстояние между токоприемниками	<i>Pantograph spacing (4.2.17)</i>
2.6.	Материал контактного провода	<i>Contact wire material (4.2.18)</i>
2.7.	Нейтральные вставки для разделения фаз	<i>Phase separation sections (4.2.19)</i>
2.8.	Воздушные промежутки линий постоянного тока	<i>Sectioning of DC systems</i>
2.9.	Нейтральные вставки между разными системами электрификации	<i>System separation sections (4.2.20)</i>
2.10.	Особые требования к пунктам отправления поездов для систем постоянного тока	<i>Special requirements for trains departure points for DC systems</i>
3.	Климатические условия и обеспечение токосъема в тяжелых погодных условиях	<i>Power supply in difficult weather conditions</i>
4.	Предписывающие знаки и обозначения для персонала поезда	<i>Signs and indications for train staff</i>

5 ANALYSIS OF DETERMINATIVE PARAMETERS

The railways of the 1520 mm space use the following power supply systems:

- 3.0 kV DC
- 25 kV 50 Hz single-phase AC

In particular, in each of these countries the following systems are used:

Belarus ²	25 kV 50 Hz single-phase alternating current In Belarus-Poland border areas (1435 mm gauge) 3.0 kV direct current is used
Latvia	3.0 kV direct current (suburban trains only) Routes on the CIS-EU border are not electrified.
Lithuania	25 kV 50 Hz single-phase alternating current (suburban trains only) Routes on the CIS-EU border are not electrified.
Poland	3.0 kV direct current, including 1520 mm gauge border sections
Russia	3.0 kV direct current and 25 kV 50 Hz single-phase alternating current 3.0 kV electrification is used on the section adjoining the CIS-EU border (Finland) (with a neutral spacer at the border) Alternating current is preferred for new electrification.
Slovakia	1520 mm lines: 3.0 kV direct current and 1435 mm lines: 25 kV 50 Hz single-phase alternating current and 3.0 kV direct current
Ukraine	3.0 kV direct current (51.3% electrification) and 25 kV 50 Hz single-phase alternating current (48.7% electrification) Alternating current is preferred for new electrification. Ukraine will retain the current system of electrification with further development of the 25 kV 50 Hz base. Sections at the CIS-EU border use 3.0 kV direct current electrification
Estonia	3.0 kV direct current (suburban trains only) Routes on the CIS-EU border are not electrified.

²Belarus was not represented in the contact group at the time this document was produced. The data given for Belarus in this document is based on information provided by participants from other countries.

5.1 POWER SUPPLY

5.1.1 Voltage and frequency

Belarus, Latvia, Lithuania, Russia. Ukraine, Estonia:

Required voltage at the ERS pantograph (rated value):

System	Minimum permitted value		Maximum permitted value
	Sections with train speeds to 160 km/h inclusive	Sections with train speeds of over 160 km/h**	
3.0 kV direct current	2.7 kV Some sections up to 2.4 kV*	2.9 kV	4 kV
25 kV 50 Hz single-phase alternating current	21 kV Some sections up to 19 kV*	24 kV	29 kV

* Russia: low-traffic lines (no more than 8 pairs of trains per day). Ukraine: certain sections, with Ukrzaliznytsa permission.

** Latvia, Lithuania and Estonia: no sections with speeds over 160 km/h.

In single-phase alternating current systems the frequency must be: 50 ± 0.4 Hz.

Poland

3 kV direct current, min 2.0 max 3.6 kV

Slovakia

3 kV direct current on 1520 mm lines.

Conformity assessment method: calculation

These requirements are established by the following documents:

Belarus	No information available
Latvia	[3.1.] Latvian railway TOR, s. 178-179
Lithuania	Rules on construction and technical operation of overhead contact lines of electrified railways AE/41 and TOR
Poland	[1.3.] Draft Energy TSIs. 4.2.3 EN 50163

Russia	[6.1.] Russian Federation Railways TORs. 7.2. [6.4.] Instructions on Technical Servicing and Operation of Structures, Systems, Rolling Stock, and the Organization of Traffic on High Speed Passenger Rail Routes TsE-393 s. 5.5.3. [1.1.] GOST 13109-97, subsection 5.6.
Slovakia	No information available
Ukraine	[8.2.] Transportation structures. 1520 mm gauge railways. Design standards. DBN B.2.3-19-2008 (s. 21.1) [8.1.] Ukrainian railways TOR(part 7, s. 7.2)
Estonia	[9.1.] Estonian Railways TOR, s. 111

Conclusion: Besides the existence of two power supply systems, the requirements for this parameter are identical in all states, except Poland and maybe Slovakia. These requirements and documents may be used as the basis for drafting uniform specifications for 1520 mm gauge systems (subject to the differences in Poland and Slovakia).

5.1.2 *Parameters relating to supply system performance*

Latvia, Lithuania, Russia, Ukraine, Estonia

Determined individually for each section, depending on distance between neighbouring traction substations, track profile, traffic levels, train mass and speed, subject to the maximum permitted overhead contact line voltage and compliance with the values indicated in Section 5.1.1.

For direct current, the maximum permitted overhead contact line current, depending on line type and cross-section is 3460 A, for alternating current it is 1450 A (Russia and Ukraine only).

Poland

Requirements match the Energy TSI

Maximum permitted current consumed by train: 2500 A (EN50388:2005)

Minimum average overhead contact line voltage: 2700 V (EN50163)

Conformity assessment method: calculation

These requirements are established by the following documents:

Belarus	No information available
---------	--------------------------

Latvia	[3.1.] Latvian railway TOR, s. 175.1
Lithuania	[4.1.] Lithuanian Railways TOR
Poland	[1.3.] Draft Energy TSIs. 4.2.4
Russia	[6.2.] PUTEKsS TsE-868, table 2.5. [6.3.] Construction Rules for Railway Traction Power Supply Systems TsE-462. Part 2.
Slovakia	No information available
Ukraine	[8.4.] Rules on Construction of Traction Power Supply Systems on Ukrainian Railways TsE-0009
Estonia	[9.1.] Estonian Railways TOR, s. 110, 118

Conclusion: Besides the existence of two power supply systems, the requirements for this parameter are identical in all states, except Poland. These requirements and documents may be used as the basis for drafting uniform specifications for 1520 mm gauge systems (allowing for the differences in Poland).

5.1.3 *Continuity of power supply in case of disturbances in tunnels*

Belarus, Latvia, Poland (1520 mm gauge lines), Slovakia (1520 mm gauge lines), Estonia:

No tunnels.

If new tunnels are built, Latvia, Poland, Slovakia and Estonia will use the TSI on Safety in Railway Tunnels.

Lithuania:

No specific tunnel requirements.

If new tunnels are built the TSI on Safety in Railway Tunnels will be used.

Russia

General (not only tunnels) power continuity requirements: Interruption permitted during AR (automatic reclosing), determined by the requirements for ensuring selective protection at substations (sectioning point) with regard to protection of electric rolling stock. For direct current – not more than 7.0 s, for alternating current – not more than 1.0 s.

Locomotive power supply – continuous in both directions, with contacts throughout the length of tunnels.

Ukraine:

Locomotive power supply – continuous in both directions, with overhead contact line throughout tunnel. Power supply for lighting from two independent sources, emergency lighting also provided.

No modern railway tunnels in Ukraine.

Ukrzalinytsa will build new tunnels in accordance with European rules.

Conformity assessment method: calculation, project assessment, compliance assessment.

These requirements are established by the following documents:

Belarus	No information available
Latvia	Not standardized. No tunnels. For new tunnel construction:[1.4.] Safety in Railway Tunnels TSI.
Lithuania	For new tunnel construction: [1.4.] Safety in Railway Tunnels TSI.
Poland	Not standardized. No tunnels on 1520 mm gauge lines. For new tunnel construction: [1.4.] Safety in Railway Tunnels TSI.
Russia	[6.3.] Construction Rules for Railway Traction Power Supply Systems TsE-462
Slovakia	Not standardized. No tunnels on 1520 mm gauge lines. For new tunnel construction: [1.4.] Safety in Railway Tunnels TSI.
Ukraine	[8.2.] Transportation structures. 1520 mm gauge railways. Design standards. DBN B.2.3-19-2008 (s. 10.7)
Estonia	Not standardized. No tunnels. For new tunnel construction: [1.4.] Safety in Railway Tunnels TSI.

Conclusion: These requirements and documents may be used as the basis for drafting uniform specifications for 1520 mm gauge systems.

5.1.4 Current capacity, DC systems, trains at standstill

This parameter refers to the maximum current for direct current power systems when trains are at standstill, which is limited by the maximum temperature value of contacts (strips) and the overhead contact line at the point of contact. The activity of auxiliary equipment and the existence of centralized power supplies for passenger cars at standstill should also be taken into account for this parameter.

Belarus, Lithuania

No direct current systems.

Latvia, Russia, Ukraine, Estonia

Passenger cars do not have power supplied from the engine at standstill. In the case of motorised rolling stock, power is supplied from several pantographs. Therefore, no problems arise with heating of the contact line in these cases and this parameter is not standardized.

Poland

Requirements comply with the draft Energy TSI.

200A for each pantograph in a 3 kV system.

Ukraine:

Maximum current for direct current power systems at standstill is limited by the maximum temperature value of contacts (strips) and the overhead contact line at the point of contact.

When selecting the number and type of operating pantographs for electric rolling stock, the capacity of the pantograph heads is primary.

For pantographs fitted with three rows of carbon insets at standstill:

Type A: single strip pantograph head (winter/summer) – 80/50 A; dual strip pantograph head – 130/80 A

Type B: single strip pantograph head (winter/summer) – 100/65 A; dual strip pantograph head – 170/110 A

Type C: single strip pantograph head (winter/summer) – 160/100 A; dual strip pantograph head – 260/170 A

For pantographs with three rows of sinter strips in collector heads:

Dual strip pantograph head (winter/summer) – 500/330 A

For pantographs with four rows of sinter strips in collector heads:

Single strip pantograph head (winter/summer) – 300/200 A

When selecting the structure and number of working pantographs, the number of collector heads and type of contact material, the ancillary equipment and centralized power

supply to passenger cars in motion and at standstill must be taken into consideration along with the nominal current to the ERS.

Conformity assessment method: testing

These requirements are established by the following documents:

Belarus	No information available
Latvia	Not standardized
Lithuania	Not applicable. No direct current systems.
Poland	[1.6.] EN 50367:2006 [1.3.] Draft Energy TSIs. 4.2.6
Russia	Not standardized
Slovakia	No information available
Ukraine	[8.5.] Regulatory documents on the manufacture and use of pantographs
Estonia	Not standardized

Conclusion: This parameter is not standardized (except in Poland) because power is not supplied from the locomotive to passenger cars at standstill.

5.1.5 *Regenerative braking*

Latvia, Lithuania, Estonia

Not applicable

Russia

Permitted provided voltage in the traction system does not exceed the values stated in Section 5.1.1. This energy is consumed by another TU on the same section.

Poland

Permitted for use of the energy by other trains, subject to compliance with EN50388:2005 s. 12.

Ukraine:

Regenerative braking is used on Ukrainian railways for both direct and alternating current systems.

Use is permitted on direct current systems provided one of three conditions is met:

- a) ERS in traction mode are in the feeder zone and able to take the regenerated energy;
- b) substations are fitted with inverters to feed the regenerated energy into the power system;
- c) substations are fitted with devices (rheostats) to absorb regenerated energy.

Voltage in 3 kV direct current traction substation buses should be maintained at 3.3-3.5 kV in regeneration zones, provided this does not affect movement of trains in traction mode.

Conformity assessment method: calculation, project assessment, project conformity assessment.

These requirements are established by the following documents:

Belarus	No information available
Latvia	Not standardized. Not applicable
Lithuania	Not standardized. Not applicable
Poland	[1.7.] EN50388:2005 s. 12 [1.3.] Draft Energy TSIs. 4.2.7
Russia	[6.3.] Construction Rules for Railway Traction Power Supply Systems TsE-462 (s. 10.12) [6.4.] Instructions on Technical Servicing and Operation of Structures, Systems, Rolling Stock, and the Organization of Traffic on High Speed Passenger Rail Routes TsE-393 (s. 5.5.3)
Slovakia	No information available
Ukraine	[8.4.] Rules on Construction of Traction Power Supply Systems on Ukrainian Railways TsE-0009 (s. 8.3.9 para. 4) [8.11.] Transportation Structures. Railway Electrification. Design Standards DBN B.2.3-2-2009 (s. 5.19 para. 5 and s. 7.1.23 para. 4).
Estonia	Not standardized. Not applicable

Conclusion: The requirements for this parameter are different in different states and are not standardized in all states. This parameter will require additional study when producing the uniform specifications for 1520 mm gauge systems.

5.1.6 *Electrical protection coordination arrangements*

Latvia, Lithuania, Russia, Ukraine, Estonia:

Electrical protection is based on ensuring the limitation of any disruptions (like overvoltages, short circuits) from normal supply conditions. The main principle of coordination is selectivity:

- a) when triggered, starting from the minimum, at the point of damage, and increasing the response time with each step towards the power source;
- b) by current (for current), resistance (for remote), discrimination (for other protection).

Current and the protection response time on electric rolling stock must be at least one time selectivity interval from current and response time on traction substations.

Protection devices should be designed and built in accordance with the standards of the country of use, but these devices must distinguish the ERS load from abnormal modes, should not allow false actuations, but should reliably switch off damaged sections.

An interruption is permitted during AR (automatic reclosing), determined by the need to ensure selectivity of substation (sectioning posts) protection compared to electric rolling stock protection. For direct current – not more than 7.0 s, for alternating current – not more than 1.0 s (6 s in Lithuania).

Poland

The procedure for coordinating electrical protection of rolling stock and traction substations is in accordance with the draft Energy TSI.

Conformity assessment method: taken into consideration during design, testing.

These requirements are established by the following documents:

Belarus	No information available
Latvia	Not standardized. In practice, as stated above
Lithuania	[4.2.] Rules on Construction and Technical Operation of Overhead contact lines AE/41
Poland	[1.3.] Draft Energy TSIs. 4.2.8
Russia	[6.3.] Construction Rules for Railway Traction Power Supply Systems TsE-462 (part 7)
Slovakia	No information available

Ukraine	[8.3.] Rules on Operation of Electrical Installations, PUE -2009 (part 3, Protection and Automation). [8.4.] Rules on Construction of Traction Power Supply Systems on Ukrainian Railways TsE-0009 (part 11, Protection against Short Circuits and Overvoltage)
Estonia	[9.1.] Estonian Railways TOR, s. 112, 116, 117

Conclusion: The approach to this parameter is the same in principle in all states. This parameter will require additional study when producing the uniform specifications for 1520 mm gauge systems with regard to the specific values for current, voltage and time.

5.1.7 *Harmonics and dynamic effects for AC systems*

Electromagnetic compatibility with CCS, radio communications systems and third parties is not considered in this section.

Latvia, Poland, Slovakia (no 1520 mm gauge lines with alternating current) and Estonia

No alternating current systems.

Lithuania

Not regulated

Russia, Ukraine

The harmonics and dynamic effects of rolling stock and power supply systems are at the research stage due to the short time in use of locomotives fitted with traction semiconductor transformers.

Conformity assessment method: measurement.

These requirements are established by the following documents:

Belarus	No information available
Latvia	Not standardized. No alternating current systems.
Lithuania	Not standardized.
Poland	Not standardized. No alternating current systems.
Russia	Not standardized. At the research stage
Slovakia	Not standardized. No alternating current systems on 1520 mm gauge lines.

Ukraine	Not standardized. At the research stage
Estonia	Not standardized. No alternating systems.

Conclusion: The issue of the interaction of rolling stock and power supply systems is in the research stage due to the short period in which locomotives fitted with traction semi-conductor transformers have been in operation. This parameter will require additional study when producing the uniform specifications for 1520 mm gauge systems.

5.1.8 *Electric energy consumption measuring equipment*

This section considers the requirements for electric energy consumption measurement equipment (meters) for commercial records installed on board ERS.

Latvia, Lithuania, Russia, Ukraine, Estonia

Meters installed on ERS are used for technical metering, commercial metering is performed using meters installed on substations and other balance-sheet division points of the electrical system.

Meters for commercial records are not installed on ERS.

Poland

Complies with the draft Energy TSI and the requirements of PKP Energetyka A.O.

Conformity assessment method: meters are checked according to the schedule established by the manufacturer or Gosstandart

These requirements are established by the following documents:

Belarus	No information available
Latvia	Not standardized. Meters for commercial records are not installed on ERS.
Lithuania	Not standardized. Meters for commercial records are not installed on ERS.
Poland	[1.3.] Draft Energy TSIs. 4.2.21
Russia	Not standardized. Meters for commercial records are not installed on ERS.
Slovakia	No information available
Ukraine	Not standardized. Meters for commercial records are not installed on ERS.

Estonia	Not standardized. Meters for commercial records are not installed on ERS.
---------	---------------------------------------------------------------------------

Conclusion: Other than Poland, where the TSI requirements apply, this parameter is not standardized because meters for commercial records are not installed on ERS. This parameter will require additional study when producing the uniform specifications for 1520 mm gauge systems.

5.2 GEOMETRY OF THE OCL AND QUALITY OF CURRENT COLLECTION

5.2.1 Geometry of the overhead contact line

Latvia, Lithuania, Russia, Ukraine, Estonia:

The height of the contact line in sections and stations must be:

Height of contact line support	3 kV DC.	25 kV 50 Hz
Nominal	6250 mm (6000 mm in Russia)	6250 mm (6000 mm in Russia)
Minimum <ul style="list-style-type: none"> • Sections and stations • Crossings • Exceptional cases with special permission 	5750 mm 6000 mm 5550 mm	5750 mm 6000 mm 5675 mm
Maximum	6800 mm	6800 mm

At electrification (new construction, reconstruction or refurbishment) for the purposes of raising, the line suspension in unhung position should allow for:

- Latvia, Lithuania, Ukraine and Estonia: 6500 mm for sections and 6600 mm for stations.
- Russia: 6500 mm for sections and stations.

Horizontal deviation of the contact wire from the axis of the overhead contact line for pantograph heads with a 1270 mm contact surface, allowing for support flexing and wind effects, shall be no more than: for straight sections – 500 mm, for curves – 450 mm.

Russia (additional):

Geometric parameters for overhead contact lines used on direct and alternating current lines are provided in the table below:

№	Overhead contact line parameter	Up to 160 km/h		Up to 200 km/h	
		DC	AC	DC	AC
1	Nominal height of overhead contact line suspension (mm).	6000	6000	6000	6000
2	Greatest difference in height of contact line on a section between neighbouring supports (mm).	30	30	20	20
3	Maximum height of overhead contact line for rated speed, including uplift (mm).	6500	6500	6250	6500
4	Maximum height of overhead contact line for restricted speed traffic (mm)	6900	6900	6900	6900
5	Maximum length of span of suspension (m).	65	70	65	65
6	Maximum difference in length between two consecutive anchor sections (%)	<15	<15	<15	<15
7	Height of suspension structure, not more than (m).	1.80	1.80	1.80	1.80
8	Distance between two consecutive wires (m).	10	10	10	9
9	Contact wire sag (mm)	$f=L_{np}/1000$		$f=0,5L_{np}/1000$	
10	Overhead contact line stagger from pantograph axis at base (mm).	+300	+300	+300	+300
11	Permitted deviation from established value of overhead contact line value (mm).	+20	+20	+20	+20
12	Permitted lateral deviation of overhead contact line in a span at maximum side wind value, m.	<0.5	<0.5	<0.4	<0.4
16	Permitted gradient of contact wire (‰).	3	3	1	1

The structure of the pantograph arm must be calculated to allow for twice the maximum displacement of the overhead contact line at the point the pantograph passes the support.

Poland

Height of overhead wire 5750 – 6200 mm

Overhead contact line stagger ± 300 mm

Overhead contact line clearance 500 mm

Conformity assessment method: measurement.

These requirements are established by the following documents:

Belarus	No information available
---------	--------------------------

Latvia	[3.1.] Latvian railway TOR s. 184 [3.2.] TE-3199 s. 2.2.1.
Lithuania	[4.2.] Rules on Construction and Technical Operation of Overhead contact lines AE/41
Poland	[5.2.] Instructions on Operation of Power Supply Devices at the Medyka-Mostiscas Crossing
Russia	[6.2.] PUTEKsS TsE-868
Slovakia	No information available
Ukraine	[8.1.] Ukrainian railways TOR(part 7, s. 7.4) [8.2.] Transportation structures. 1520 mm gauge railways. Design standards. DBN B.2.3-19-2008 (s. 21,26. 21.28)
Estonia	Rules are established by undertakings in accordance with [9.1.] Estonian Railways TOR

Conclusion: The requirements for this parameter have only small differences in different states. These requirements and documents may be used as the basis for drafting uniform specifications for 1520 mm gauge systems, including items 17, 18, 19, in the table for Russia.

5.2.2 *Pantograph gauge*

Latvia, Lithuania, Russia, Ukraine, Estonia

The placement height, geometrical dimensions and range of motion in operation of the pantograph must ensure normal conditions of current collection and remain within a space separate from the rolling stock gauge and earthed parts of the permitted sectioning.

The pantograph position (pantograph gauge) when raised during motion or at standstill is governed by the permitted spacing between electrified parts of the pantograph, the rolling stock gauge, and earthed parts of the structure.

The pantograph gauge must conform to Figure 1.



Рис. 1. Расстояние между сооружениями, устройствами контактной сети, токоприемниками и подвижным составом:
 1 — габарит подвижного состава; 2 — габарит искусственных сооружений; 3 — положение токоприемника с учетом его смещения

Figure 1

[Left side: (in sections) (in stations) middle: (for freight 4450) right: (in sections) (in stations) Below: Fig. 1 Structures gauge, overhead contact line structure, pantographs and rolling stock: 1 – rolling stock gauge; 2 – gauge of man-made structures; 3 – pantograph position taking into account its displacement]

where:

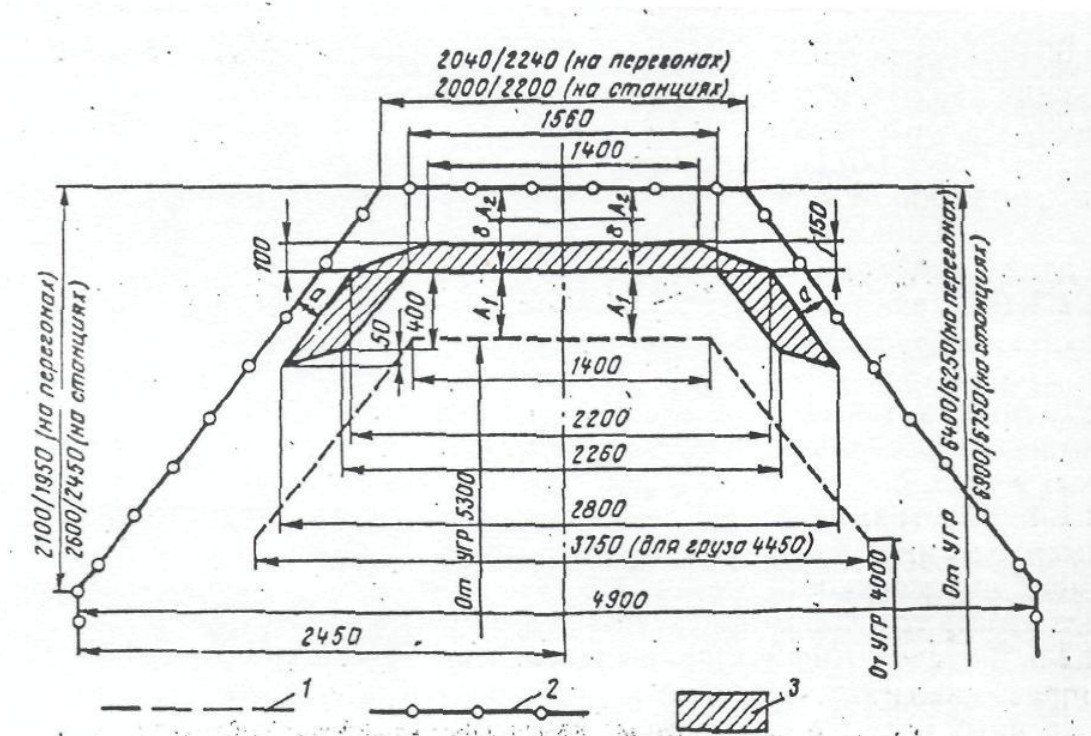
numerator – with suspension line

denominator – without suspension line

A_1 – 450 mm on sections and station main lines, 950 mm on other station lines, 375 mm minimum permitted interval in sections and station lines;

A_2 – 350 mm standard, 300 mm minimum permitted;

α - 250 mm standard, 200 mm minimum permitted.

Poland

1950 mm

B8 or B3 profile according to EN50367:2006

Rolling stock with pantographs conforming to Belarusian and Ukrainian requirements is permitted.

Russia (additional)

Pantograph head profile

Figure 2 shows the profile of the pantograph head the overhead contact line geometry is calculated to match. These parameters are for speeds over 160 km/h.

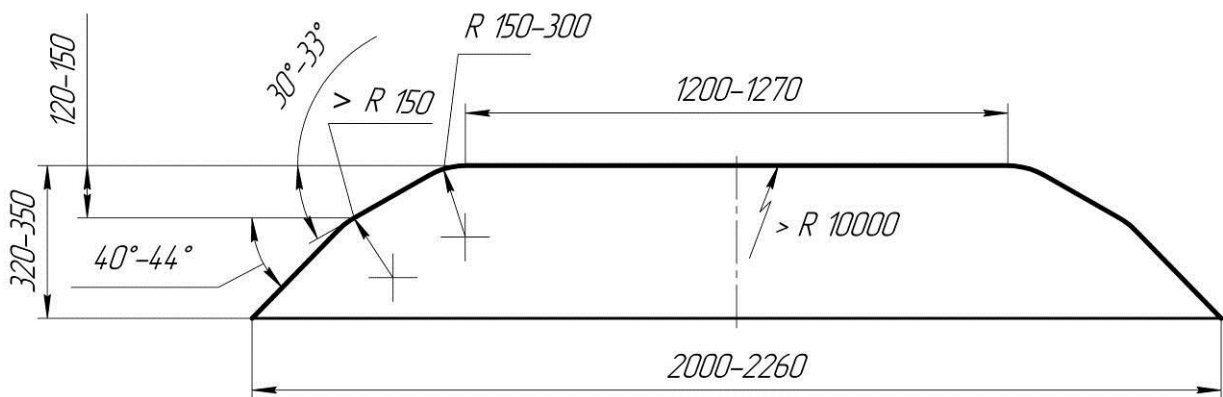

Figure 2 Pantograph head configuration and size

Conformity assessment method: measurement of the maximum operating positions of the ERS pantograph.

These requirements are established by the following documents:

Belarus	No information available
Latvia	[3.2.] TE-3199 . s. 2.2.5. for direct current
Lithuania	[4.2.] Rules on Construction and Technical Operation of Overhead contact lines AE/41
Poland	[1.3.] Draft Energy TSI s. 4.2.14 [1.6.] EN 50367:2006
Russia	[6.2.] PUTEKsS TsE-868
Slovakia	No information available
Ukraine	[8.6.] Rules on Construction and Technical Servicing of Overhead contact lines TsE-0023 (fig. 2.2.1 and table 2.2.3)
Estonia	Rules are established by undertakings in accordance with [9.1.] Estonian Railways TOR

Conclusion: the requirements for this parameter are on the whole identical in all countries. The above documents may be used as a basis in developing uniform specifications for 1520 mm gauge systems.

5.2.3 *Mean contact force*

Latvia, Ukraine, Estonia:

The pantograph should ensure a static contact force throughout the operating range:

- For heavy pantographs: active (raising) 90-100 H, passive (lowering) 100-130 H, average – 95-115 N;
- For lightweight pantographs: active (raising) 60-70 H, passive (lowering) 80-90 H, medium – 75-80 N;

Lithuania

The pantograph contact force shall not lift the overhead wire more than 250 mm at the support.

Poland

According to draft Energy TSI

Average contact force $90 \text{ N} < F_m < 0,00097 \cdot v^2 + 110$

Russia

The pantograph should ensure static contact force throughout the operating range:

- For heavy pantographs: active (raising) 90-100 N, passive (lowering) 100-130 H, average – 95-115 N;
- For lightweight pantographs: active (raising) 70 N, passive (lowering) 90 N, average – 80 N;

Dynamic pantograph contact force is stated allowing for the specific aerodynamic behaviour in which the quasi-static contact force rises with increasing speed.

№	Parameter, notes	Value		
		Up to 160 km/h	Up to 200 km/h	Up to 250 km/h

		DC	AC	DC	AC	DC	AC
1.	Maximum permitted dynamic pantograph contact force on overhead wire $F_{\max} = F_m + 3\sigma$ (N) F_m – mean static contact force	250	250	350	250	450	250
2.	Minimum permitted dynamic pantograph contact force on overhead wire $F_{\min} = F_m - 3\sigma$ (N)	40	40	40	40	40	40

Conformity assessment method: measurement

These requirements are established by the following documents:

Belarus	No information available
Latvia	[3.3.] Pantograph Operating Manual [3.4.] Instructions on Inspections of Pantographs at Placing in Service
Lithuania	[4.2.] Rules on Construction and Technical Operation of Overhead contact lines AE/41
Poland	[1.3.] Draft Energy TSI s. 4.2.15
Russia	[6.2.] PUTEKsS TsE-868
Slovakia	No information available
Ukraine	[8.7.] Temporary Instructions on the Organization of High-speed Passenger Train Traffic. Infrastructure and Rolling Stock Requirements, VND 32.1.07.000-02 (s. 7.1.9)
Estonia	Rules are established by undertakings in accordance with [9.1.] Estonian Railways TOR

Conclusion: Only static contact force is standardized (with minor differences), dynamic contact force is not standardized for speeds up to 160 km/h. This parameter will require additional study when producing the uniform specifications for 1520 mm gauge systems.

5.2.4 *Dynamic behaviour and quality of current collection*

Latvia, Estonia

The structural height of the suspension links at the suspension support points shall be 1.8 m, permitted deviation – 0.3 m and + 0.5 m.

The overhead contact line support should not allow pantographs to lift the overhead contact line more than 250 mm at the support at the maximum calculated wind, temperature and total rolling stock pantograph pressure values.

Contact wire tension K at compensators, depending on local wear S_{max} at anchor points, must comply with the values in Figure 3 for copper and low-alloy cable, and figure 2 for bronze (tension on 1 mm for copper and low-alloy cable of 100 N (10 kg/s) and for bronze of — 120 N (12 kg/s)).

Tension in dual contact wire lines shall be double the tension relating to maximum spot wear on either of the two wires. The actual tension of the overhead contact line at any anchor point shall not deviate from the nominal by more than 15%.

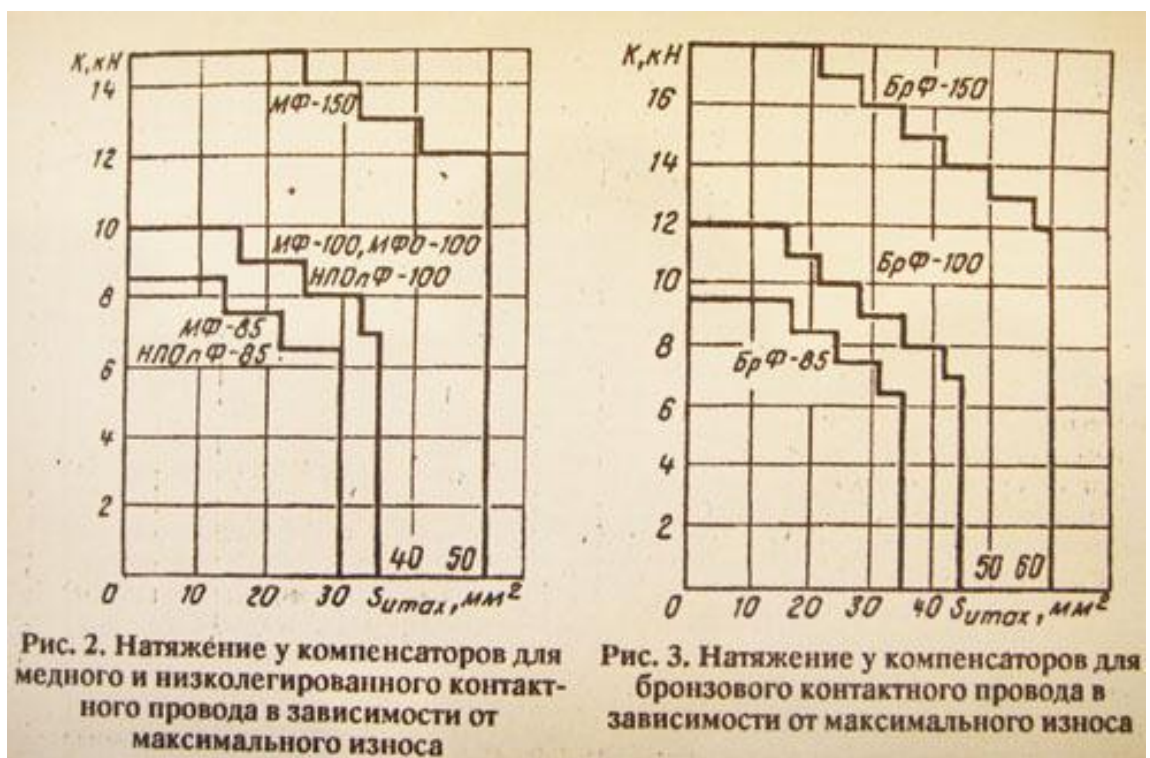

Figure 3

[Fig. 2. Tension in compensators for copper and low-alloy contact wire depending on maximum wear.

Fig. 3. Tension in compensators for bronze contact wire depending on maximum wear.]

Lithuania

Not regulated

Poland

1. $F_{min} = F_m - 3 \sigma_{max} \geq 40 \text{ N}$
2. Overhead contact line lift 100 mm

In accordance with EN50367:2006, annex B, table B6

Russia

The parameters of the overhead contact line supports that are determinative for quality of current collection and their values are provided in the following table.

The table provides formulas for calculating the dynamic parameters of the overhead contact line supporting suspension affecting the current collection quality. Pantograph contact force is stated allowing for the specific aerodynamic behaviour in which the quasi-static force rises with increases in speed.

№	Parameters, notes	Value					
		Up to 160 km/h		Up to 200 km/h		Up to 250 km/h	
		DC	AC	DC	AC	DC	AC
1.	Permitted uplift (mm).	200	250	200	250	250	300
2.	Maximum permitted dynamic pantograph contact force at overhead contact line $F_{max} = F_m + 3\sigma$ (N) F_m – mean static contact force	250	250	350	250	450	250
3.	Minimum permitted dynamic pantograph contact force at overhead wire $F_{min} = F_m - 3\sigma$ (N)	40	40	40	40	40	40
4.	Coefficient of variation of elasticity $U = \frac{e_{max} - e_{min}}{e_{max} + e_{min}} \times 100\%$ - with stitch wire: - without stitch wire:	≤ 35 ≤ 40	≤ 35 ≤ 40	≤ 35 ≤ 40	≤ 35 ≤ 40	≤ 35 ≤ 40	≤ 35 ≤ 40
5.	Wave propagation velocity, not less than km/h	200	200	280	280	350	350

№	Parameters, notes	Value					
		Up to 160 km/h		Up to 200 km/h		Up to 250 km/h	
		DC	AC	DC	AC	DC	AC
6.	Doppler coefficient (ratio of speed of wave advance to train speed) $\alpha = \frac{V_c - V_b}{V_c + V_b} :$ - with stitch wire: - without stitch wire:	≥ 0.12	≥ 0.12	≥ 0.16	≥ 0.16	≥ 0.25	≥ 0.25
		≥ 0.10	≥ 0.10	≥ 0.14	≥ 0.14	≥ 0.2	≥ 0.2
7.	Reflection coefficient $r = \frac{1}{\left(1 + \sqrt{\frac{H_F \times m_F}{H_T \times m_T}}\right)} :$ - [Translator's Note: I think the H in this equation should be N for Newtons. I could not change the image to reflect this.] with stitch wire: - without stitch wire:	$r \leq 0.5$	$r \leq 0.5$	$r \leq 0.5$	$r \leq 0.5$	$r \leq 0.5$	$r \leq 0.5$
		$r \leq 0.5$	$r \leq 0.5$	$r \leq 0.5$	$r \leq 0.5$	$r \leq 0.5$	$r \leq 0.5$
8.	Gain $\gamma = r/\alpha :$ - with stitch wire: - without stitch wire:	$\gamma \leq 4$	$\gamma \leq 4$	$\gamma \leq 3$	$\gamma \leq 3$	$\gamma \leq 2.0$	$\gamma \leq 2.0$
		$\gamma \leq 5$	$\gamma \leq 5$	$\gamma \leq 3.6$	$\gamma \leq 3.6$	$\gamma \leq 2.5$	$\gamma \leq 2.5$

Ukraine:

Contact line tension (MF-100) – 1050N, suspension line tension (BBSM-95, M-95) – 1425 N, height of suspension structure 1.8 m, maximum permitted line displacement at support – 250 mm, coefficient of elasticity variation in span 1.408.

Conformity assessment method: measurement

These requirements are established by the following documents:

Belarus	No information available
Latvia	[3.2.] TE-3199 . pp. 2.1.3, 2.1.4, 2.5.5
Lithuania	Not standardized.
Poland	[1.3.] Draft Energy TSI s. 4.2.16

Russia	[6.2.] PUTEKsS TsE-868 [6.5.] Instructions on Vertical Adjustment of Overhead Contact Lines TsET-2
Slovakia	No information available
Ukraine	[8.6.] Rules on Construction and Technical Servicing of Overhead contact lines TsE-0023 (part 2.5)
Estonia	Rules established by undertakings in accordance with [9.1.] Estonian Railways TOR

Conclusion: The requirements for this parameter are not expressly standardized and are derived from requirements for the overhead contact line. This parameter will require additional study when producing the uniform specifications for 1520 mm gauge systems.

5.2.5 *Pantograph spacing*

Latvia, Estonia

Practical, not less than 25 m, not regulated.

Lithuania

Not regulated

Poland

In accordance with the draft Energy TSI. The overhead contact line must allow trains with at least two pantographs to pass. Minimum spacing between pantographs:

- 20 m at speeds up to 160 km/h
- 200 m at speeds up to 160 km/h

Russia, Ukraine

Distance between pantographs of not less than 18 m in accordance with locomotive construction requirements. For motorized rolling stock the distance between pantographs (in practice at least 40 m) does not represent a problem at speeds up to 160 km/h. For dual traction, it is not permitted to raise the pantographs on adjoining RS units.

For the purpose of reducing wear on the overhead wire, one of the pantographs (usually the first according to the direction of the locomotive) must be lowered:

- Russia: when starting from standstill on direct current from achieving 10-15 km/h (see s. 3 Collected Technical Instructions 1985, p. 68) and until the first overhead junction crossing.
- Ukraine: Upon reaching 25 km/h.

Conformity assessment method: no assessment of overhead contact line conducted for this parameter.

These requirements are established by the following documents:

Belarus	No information available
Latvia	Not standardized.
Lithuania	Not standardized.
Poland	[1.3.] Draft Energy TSIs. 4.2.17
Russia	[6.2.] PUTEKsS TsE-868 [6.6.] Instructions on the Procedure for Use of Pantographs TsT-TsE-844
Slovakia	No information available
Ukraine	[8.8.] Instructions on Use of Electric Rolling Stock Pantographs in Various Operating Conditions
Estonia	Not standardized.

Conclusion: The requirements for this parameter are not expressly standardized (except in Poland), but are derived from requirements for RS and additional instructions. This parameter will require additional study when producing the uniform specifications for 1520 mm gauge systems.

5.2.6 *Contact wire material*

Latvia, Lithuania, Ukraine, Estonia:

Copper or low-alloy copper with a cross-section of 100 mm² on main lines, 85 mm² on secondary lines (GOST 2584-86).

Poland

Cu-ETP or CuAg0.1

Russia

Copper or low-alloy copper with tin content 0.04%, bronze with tin content 0.15% and cross-sections of 85, 100, 120, 150 mm² (according to new GOST in development).

Conformity assessment method: material certificate of conformity.

These requirements are established by the following documents:

Belarus	No information available
Latvia	[3.2.] TE-3199 .
Lithuania	Not standardized.
Poland	Railway Infrastructure Manager Requirements PKP PLK A.O. [1.3.] Draft Energy TSI s. 4.2.18
Russia	[6.2.] PUTEKsS TsE-868 (s. 2.1.6) [1.2.] GOST 2584-86 (new GOST in development)
Slovakia	No information available
Ukraine	[8.6.] Rules on Construction and Technical Servicing of Overhead contact lines TsE-0023 (s. 2.1.6) [8.4.] Rules on Construction of Traction Power Supply Systems on Ukrainian Railways TsE-0009
Estonia	Rules established by undertakings in accordance with [9.1.] Estonian Railways TOR

Conclusion: the requirements for this parameter have slight differences in different states. These requirements and documents may be used as the basis for drafting uniform specifications for 1520 mm gauge systems.

5.2.7 *Phase separation sections*

Latvia, Poland, Slovakia (1520 mm gauge systems), Estonia

No alternating current systems.

Lithuania, Russia, Ukraine:

On sections with alternating current, sections of overhead contact line with different phases are separated by two section insulators with neutral separation section between them, preventing the pantograph heads contacting both phases simultaneously. The length of the separation section is selected based on the type of traction unit and train, minimum 200 m.

Phase separation sections are also used in places where the overhead contact line current may cross between power systems.

Conformity assessment method:

These requirements are established by the following documents:

Belarus	No information available
Latvia	Not standardized. No alternating power systems used.
Lithuania	[4.2.] Rules on Construction and Technical Operation of Overhead contact lines AE/41
Poland	Not standardized. No alternating power systems used.
Russia	[6.5.] Instructions on Vertical Adjustment of Overhead Contact Lines TsET-2 (s. 2.18.10)
Slovakia	Not standardized. Alternating current not used on 1520 mm gauge systems.
Ukraine	[8.5.] Regulatory documents on the manufacture and use of pantographs (s. 21.37) [8.6.] Rules on Construction and Technical Servicing of Overhead contact lines TsE-0023 (s. 2.18.10)
Estonia	Not standardized. Alternating systems not used

Conclusion: this parameter is only regulated in Russia and Ukraine. These requirements and documents may be used as the basis for drafting uniform specifications for 1520 mm gauge systems.

5.2.8 Sectioning of DC systems

Latvia, Estonia

The distance between the inner sides of operating overhead wires at the insulated section (insulator) must be 550 mm. If wind displacement of lines on operating sections means that this distance cannot be used, it may be 400 mm for direct current lines and 500 mm for alternating current. The permitted deviation from these values is +/- 50 mm.

The vertical distance from axle of the inset insulator at the support crossing to the contact wire shall be no less than 500 mm for a single wire and 400 mm for dual wire.

Brackets, wires and electrical couplings should be placed so as to ensure constant tension sections are insulated regardless of any possible temperature change.

Lithuania

Direct current systems are not used.

Poland

Insulation distance must be not less than 200 mm.

Russia

The distance between overhead wires at insulated sections (insulators) must comply with the values in the table below.

Simultaneous contacts between the pantograph head and the overhead wire of two branches of a three-wire coupling must have an insulated section (insulator) of 6 - 12 m in the middle.

The brackets of constant tension overhead wires, braces, wires and electrical couplings on insulating couplings must be placed so as to ensure the insulation of constant tension sections during temperature changes.

Type and place of spacing	Spacing at coupling (mm)
Horizontal between inner sides of contact wire in a span, km/h:	
• Up to 160	550*±50
• 161 to 200	550±40
Vertical from contact wire	
• to lower surface of inset ceramic insulator	
○ dual overhead contact lines	250+20
○ single overhead contact line	300+20
• to lower surface of polymer insulator	300+20
• to lower surface of insulating element allowing contact with pantograph	200+20

Note.* For wind effects on operating sections, and also standard closed insulation couplings, 400 mm is permitted for direct current and 500 mm for alternating.

Ukraine.

The overhead contact line is divided into separate sections using insulated sections (insulators) (sectioning). The spacing from overhead contact lines in various sections is: horizontal – 550 mm, vertical – 250 for dual lines, 300 for single.

Conformity assessment method: measurement.

These requirements are established by the following documents:

Belarus	No information available
Latvia	[3.2.] TE-3199 . s. 2.7.6.
Lithuania	Not standardized. No direct current lines
Poland	[5.3.] Ministerial Resolution on Technical Requirements for Railway Construction (DU.151)
Russia	[6.2.] PUTEKsS TsE-868 (s. 2.7.5-2.7.7)
Slovakia	No information available
Ukraine	[8.2.] Transportation structures. 1520 mm gauge railways. Design standards. DBN B.2.3-19-2008 (s. 21.36) [8.6.] Rules on Construction and Technical Servicing of Overhead contact lines TsE-0023 (part 2.7)
Estonia	Rules established by undertakings in accordance with [9.1.] Estonian Railways TOR

Comment: this parameter is not described in the TSI and is included for reference purposes.

5.2.9 *System separation sections*

Latvia, Lithuania, Poland, Slovakia, Estonia

Only one current system is used, no system separation sections, parameter not standardized.

Russia, Ukraine:

Differing electrification systems are separated at connecting stations. In this case between the direct current 3 kV system and the 25 kV 50 Hz alternating current there should also be a non-switching section between the insulated section (insulator) separating the section and the switching insulated section (insulator). The section must be of a sufficient length to prevent the pantographs headsimultaneously contacting insulated sections (insulators).

Ukraine: between different electrification systems only system separation sections are required for dual system ERS (3 kV and 25 kV). System separation sections at phase separators for direct current and alternating current electrical traction are fitted with devices to enable automatic switching of the traction current on the ERS.

If non-dual system trains are used, this function is performed by connection stations.

Conformity assessment method: design assessment and conformity.

These requirements are established by the following documents:

Belarus	No information available
Latvia	Not standardized. Applies to direct current only.
Lithuania	Not standardized. Applies to alternating current only.
Poland	Not standardized. Applies to direct current only.
Russia	[6.2.] PUTEKsS TsE-868
Slovakia	Not standardized. Applies to direct current only for 1520 mm systems.
Ukraine	[8.6.] Rules on Construction and Technical Servicing of Overhead contact lines TsE-0023 (s. 2.18.10, 2.18.11, 2.18.12)
Estonia	Not standardized. Applies to direct current systems only.

Conclusion: this parameter is only regulated in Russia and Ukraine. These requirements and documents may be used as the basis for drafting uniform specifications for 1520 mm gauge systems.

5.2.10 *Special requirements for trains departure points for DC systems*

Latvia, Lithuania, Poland, Estonia

Not standardized

Russia

A second line is run alongside at the departure and acceleration sections of stations.

Ukraine

On sections and stations where more than 1000 A is collected, the overhead contact line has two wires, in stations at departure and acceleration trains use a bypass wire above the contact wire.

Conformity assessment method: design assessment and conformity.

These requirements are established by the following documents:

Belarus	No information available
Latvia	Not standardized

Lithuania	Not standardized
Poland	Not standardized
Russia	[6.2.] PUTEKsS TsE-868
Slovakia	No information available
Ukraine	[8.2.] Transportation structures. 1520 mm gauge railways. Design standards. DBN B.2.3-19-2008 (s. 21.24, 21.27) [8.6.] Rules on Construction and Technical Servicing of Overhead contact lines TsE-0023 (s. 2.24.3.)
Estonia	Not standardized

Comment: this parameter is not described in the TSI and is included as reference information.

5.3 Power supply in difficult weather conditions

Poland:

Not standardized

Latvia:

Electrical heating of overhead contact line used.

Lithuania, Russia

Three methods are used to protect against the affects of ice build-up on current collection

- Mechanical removal involves the removal of ice using special devices to ensure contact between the overhead contact line and the pantograph.
- Electrical heating involves using electrical current in the conducting elements to raise their temperature, which can either prevent ice build up or remove any build up that has occurred.
- Chemical protection enables the prevention of ice formation or reduces ice adhesion to current collection devices, facilitating subsequent mechanical removal.

Prophylactic heating is used for protection against ice on the overhead contact line.

Due to difficulties with prophylactic heating, station lines may use special additional transformers to heat sections of the overhead contact line at sections where trains arrive and depart.

Ice melting schemes are used to remove ice build-up.

Mechanical removal of ice from overhead contact lines uses special ice clearers installed on the railcars. Use of vibrating pantographs on trains is effective at temperatures not below -4°C.

For prophylactic purposes, places where locomotives arrive and depart are treated with CSRI-KZ de-icer before the start of the ice season.

The pantograph should be painted with special paint providing low adhesion for ice in order to prevent ice build up.

Before the ice season, the pantograph must be treated with CSRI-KZ de-icer.

Ukraine:

The type of overhead contact line support and wire type are selected on the basis of rated speed, total cross-section of the overhead contact line, climatic and other local conditions. In areas with high winds wind stability treatments are used. In icy areas prophylactic heating, electric ice melting, special pantograph lubricants and special mechanical devices are used.

Estonia:

Range of measures including:

- Mechanical ice removal
- Electrical heating of conducting elements
- Chemical protection

Conformity assessment method:

These requirements are established by the following documents:

Belarus	No information available
Latvia	[3.5.] Bad Weather Conditions Action Plan
Lithuania	Not standardized
Poland	Not standardized
Russia	[6.6.] Instructions on the Procedure for Use of Pantographs TsT-TsE-844 (s. 13.3, parts 21, 22)
Slovakia	No information available

Ukraine	<p>[8.2.] Transportation structures. 1520 mm gauge railways. Design standards. DBN B.2.3-19-2008 (s. 21.24, 21.27, 21.39)</p> <p>[8.6.] Rules on Construction and Technical Servicing of Overhead contact lines TsE-0023 (s. 2.18.5)</p> <p>[8.4.] Rules on Construction of Traction Power Supply Systems on Ukrainian Railways TsE-0009</p>
Estonia	<p>[9.3.] Rules on Technical Operation and Construction of Overhead contact lines</p>

Comments:

- Certain details on prevention of ice build-up are provided in ORC R 610 -3;
- This parameter is not described in the TSI and is included for reference purposes.

5.4 Signs and indications for train staff

Latvia, Lithuania, Russia, Ukraine, Estonia

"Lower Pantograph": On electrified sections before air spaces, where in the event of a sudden removal of power in one section of the overhead contact line the train is not able to move with raised pantographs, the "Lower Pantograph" signal is placed on supports or on a separate pole (Figure 4).



Figure 4

When the signal shows flashing white stripes, the driver must immediately act to pass the air space section with lowered pantographs.

The signal is not normally lit and in this case does not indicate anything.

Continuous signals

If "Lower Pantograph" signals are used, "Attention! Current Separation!" signs shall be placed in front of them" (Figure 5, a).

A permanent "Raise Pantograph" signal with reflectors shall be installed at intervals in the direction of traffic (Figure 5, b).

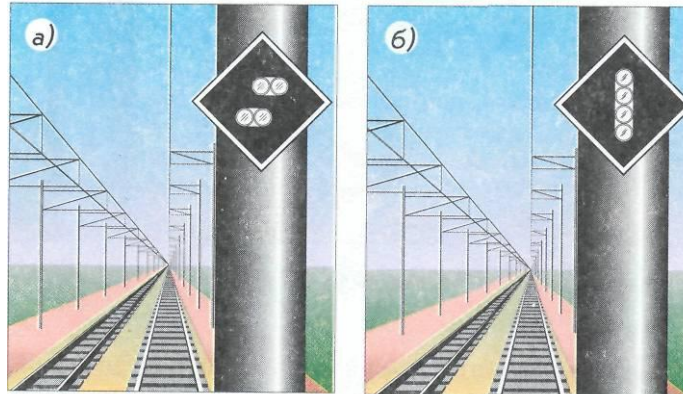

Figure 5

The placement of "Lower Pantograph" signal and permanent "Raise Pantograph" and "Attention! Current Separation!" signs is given in Figure 6. They shall be placed so as not to obstruct vision or the visibility of signals.



Figure 6

[L-R: not less than 300 m; not more than one span; sectioning; not less than 50 m; not less than 200 m]

For 12-carriage electric trains, the distance from the sectioning to the permanent "Raise Pantograph" sign shall be no less than 250 m.

The overhead contact line supports at the boundaries of the air space shall have distinguishing markings: four black and three white alternating horizontal stripes. The first support in the direction of travel shall also be marked with a vertical black stripe (Figure 7, a).

These signs may be placed directly on the support post, or on signboards attached to the posts (Figure 7, b). On multitrack sections signs may be placed on the overhead contact line above the axis of the tracks.

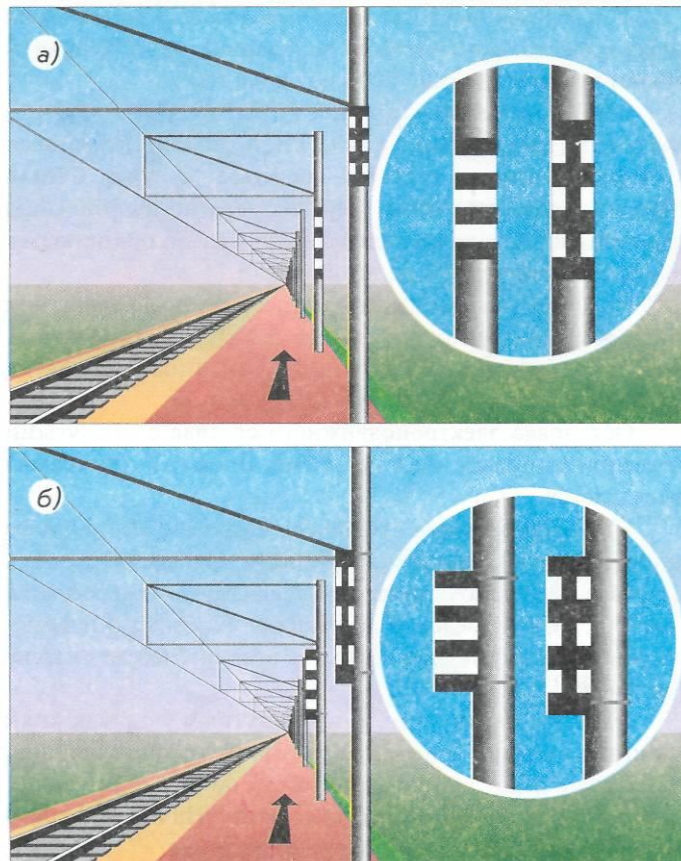

Figure 7

Electric rolling stock is prohibited to stop between these supports (signs) with raised pantographs.

"Switch Off Current" (Figure 8, a) – before the system separation section;

"Switch On Train Current" (Figure 8, b);

"Switch On Train Current" (Figure 8, c) – beyond the system separation section.

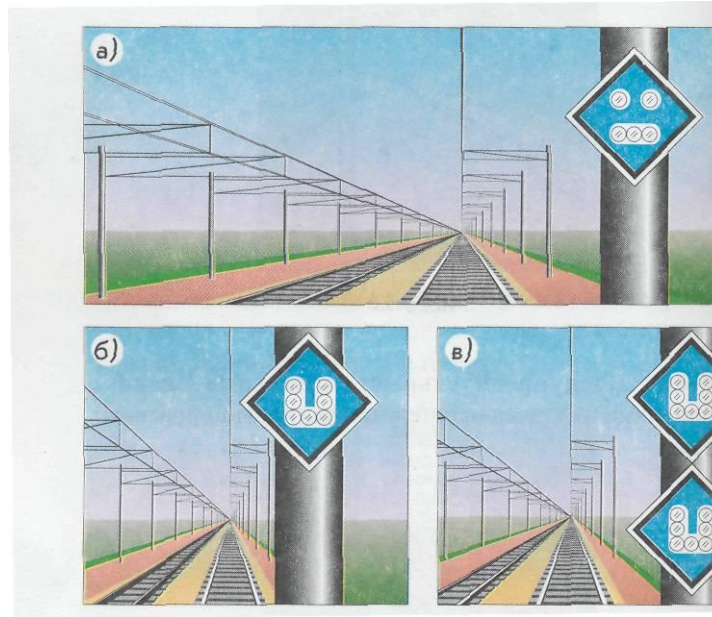

Figure 8

The placement scheme for these signs is given in Figure 9

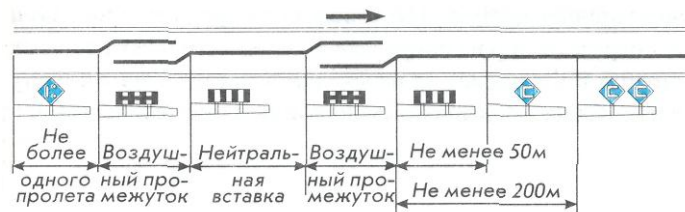

Figure 9

[L-R: not more than one span; sectioning; phase separation section; sectioning; not less than 50 m; not less than 200 m]

Lithuania uses, and Latvia and Estonia plan to introduce, an "End of Overhead Contact Line" sign (Figure 10), which is installed on the overhead contact line at the point where the contact line ends. Russia and Ukraine (and Latvia and Estonia before the change in rules) use a sign with the text "End of Overhead Contact Line".

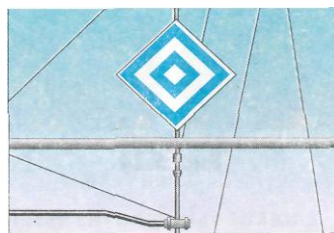

Figure 10

"Prepare to Lower Pantograph" (Figure 11, a);

"Lower Pantograph" (Figure 11, b);

"Raise Pantograph" (Figure 11, c).

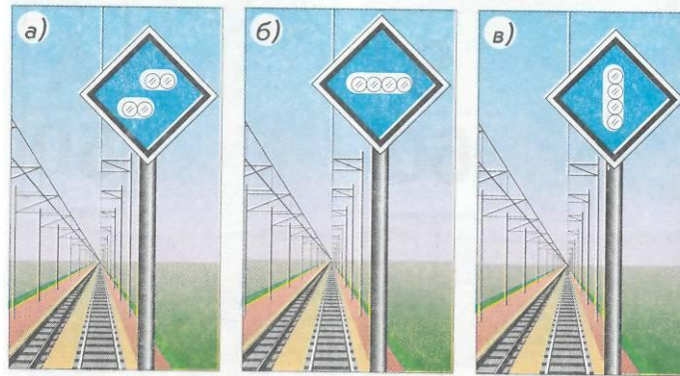

Figure 11

The installation scheme for these signs is in Figure 12.

If track maintenance and construction work is being performed on a dual track line, with trains passing on one track and the laying of temporary crossing tracks not fitted with an overhead contact line, a "Lower Pantograph" signal shall be installed at least 100 m before the protected section. The other signals shall be installed in accordance with Figure 12.

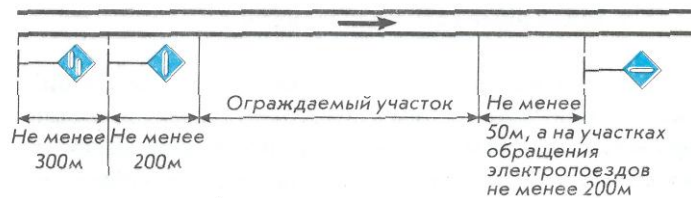

Figure 12

[L-R: not less than 300 m; not less than 200 m; protected section; not less than 50 m, for sections with electric train traffic not less than 200 m]

In the event of a sudden discovery of damage to the overhead contact line that prevents electric rolling stock passing with raised pantographs, the power supply worker that discovered the problem shall stand 500 m towards the expected oncoming train and give the driving a "Lower Pantograph" hand signal (Figure 13):

- By day – repeatedly move the right hand across the chest on a horizontal line while holding the left hand vertical;
- By night – repeated vertical and horizontal movements with a white light.

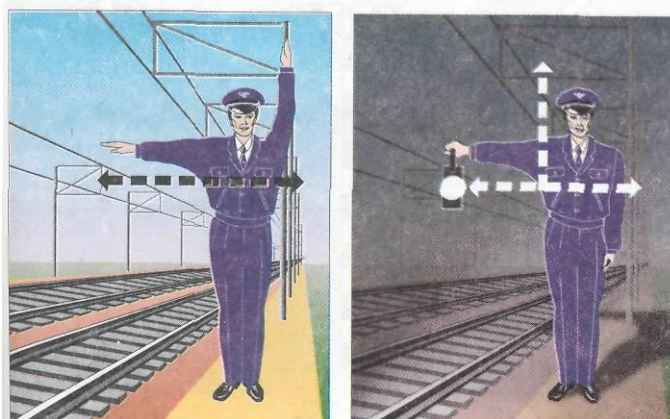

Figure 13

The driver shall: give a warning signal, cut electrical power and lower the pantograph, and proceed with special care through the damaged section, once the driver is sure he is in a properly operating section of the overhead contact line, the pantograph may be raised and the train may continue onwards.

Poland

Signs according to signalling instructions - E1 (PKP PLK A.O.)

Conformity assessment method: visual.

These requirements are established by the following documents:

Belarus	No information available
Latvia	[3.6.] Latvian Railways Signalling Rules
Lithuania	[4.3.] Lithuanian Railways Signalling Rules
Poland	[5.4.] Signalling Instructions - E1
Russia	[6.7.] Russian Federation railways Signalling Instructions-757
Slovakia	No information available
Ukraine	[8.9.] Ukrainian Railways Signalling Instructions
Estonia	[9.2.] Estonian Railways Signalling Instructions

Comments: this parameter is not described in the TSI and is included as reference material.

Conclusion: signs and indications for train staff are the same in all countries except Poland and Slovakia. These requirements and documents may be used as the basis for drafting uniform specifications for 1520 mm gauge systems.

6 COMPARISON WITH 1435 MM GAUGE SYSTEM TARGET VALUES

6.1 POWER SUPPLY

6.1.1 *Voltage and frequency*

The nominal values in the TSI are applicable for 1520 mm systems except 15 kV and 1.5 kV. Minimum and maximum rated values should be in accordance with those stated in section 5.1. The TSI standardises absolute minimum and maximum values permitted in operation.

6.1.2 *Parameters relating to supply system performance*

The approach used for supply system performance in the 1520 mm gauge system differs from the TSI approach.

6.1.3 *Continuity of power supply in case of disturbances in tunnels*

The TSI requirements are applicable in the 1520 mm gauge system.

6.1.4 *Current capacity, DC systems, trains at standstill*

The applicability of the TSI to 1520 mm gauge systems requires further study.

6.1.5 *Regenerative braking*

TSI requirements are applicable to 1520 mm gauge systems provided it is possible to transmit regenerated energy to other trains.

6.1.6 *Electrical protection coordination arrangements*

The principle of selectivity of electrical protection is used in 1520 mm gauge systems. The applicability of specific values of EN50388:2005 requires further examination.

6.1.7 *Harmonics and dynamic effects for AC systems*

Harmonics and dynamic effects are still at the stage of scientific research due to the short time trains fitted with semiconductor traction transformers have been in operation. The applicability of specific values of EN50388:2005 requires further examination.

6.1.8 *Electric consumption measuring equipment*

Not standardized in 1520 mm gauge systems, no comparison possible.

6.2 *GEOMETRY OF THE OCL AND QUALITY OF CURRENT COLLECTION*

6.2.1 *Geometry of the overhead contact line*

TSI values are not applicable in 1520 mm systems.

6.2.2 *Pantograph gauge*

TSI values are not applicable in 1520 mm systems.

6.2.3 *Mean contact force*

TSI values are not applicable in 1520 mm systems.

6.2.4 *Dynamic behaviour and quality of current collection*

The values in the TSI require further study with regard to applicability in the 1520 mm gauge systems.

6.2.5 *Pantograph spacing*

The values in the TSI require further study with regard to applicability in the 1520 mm gauge systems. Today the minimum pantograph spacing in practice is 18 m.

6.2.6 *Contact wire material*

The values in EN50149:2001 require further study with regard to applicability in 1520 mm gauge systems.

6.2.7 *Phase separation sections*

The applicability of EN50367:2006 requires further study.

6.2.8 *Sectioning of DC systems*

Not standardized in TSI, comparison not possible.

6.2.9 *System separation sections*

The TSI requirements are generally applicable to 1520 mm gauge systems, the values in EN50122-2 and EN50119 should be checked.

6.2.10 *Special requirements for trains departure points for DC systems*

Not standardised in TSI, comparison not possible.

6.3 Power supply in difficult weather conditions)

Not standardised in TSI, comparison not possible.

6.4 Signs and indications for train staff

Not standardised in TSI, comparison not possible.

7 ANNEXES

7.1 LIST OF MEMBERS OF CONTACT GROUP

7.2 LIST OF ISSUES REQUIRING FURTHER STUDY

**ANALYSIS OF THE DETERMINATIVE
PARAMETERS FOR MAINTAINING TECHNICAL
AND OPERATIONAL COMPATIBILITY OF 1520 mm
and 1435 mm GAUGE RAILWAYS AT THE EU-CIS
BORDER**

SUBSYSTEM: POWER SUPPLY

**ANNEX 2
MATTERS FOR ADDITIONAL STUDY**

Document produced by the ORC-ERA Contact Group

REVISIONS AND AMENDMENTS

Revision and date	Section	Note	Author
0.00/ 18/01/2010	All	Draft for approval in session 26-28/01/2010	FAD
1.00/ 28/01/2010	None	Document approved by contact group	FAD VK

CONTENTS

1	SCOPE OF APPLICATION OF DOCUMENT.....	3
2	MATTERS FOR ADDITIONAL STUDY.....	4
2.1	Power supply	4
2.2	Geometry of the OCL and quality of current collection	4

1 SCOPE OF APPLICATION OF DOCUMENT.

The ERA/ORC contact group has prepared this Analysis of the Determinative Parameters for Maintaining Technical and Operational Compatibility of 1520 mm and 1435 mm Gauge Railway Systems at the CIS-EU Border. Subsystem: Power Supply, on the basis of materials provided by the member countries of the ORC represented in the contact group. This material has been summarised where possible.

The regulatory documents of various countries are identical or have only minor differences with regard to many parameters. In these cases, the working group producing the uniform specifications for 1520 mm gauge systems can resolve these minor differences.

However, the requirements for a number of parameters have significant differences between countries, and a number of parameters are not regulated either in individual countries or in the 1520 mm gauge system as a whole. More detailed study of these parameters will be required when drafting the uniform specifications for 1520 mm gauge systems.

This annex lists the parameters requiring further in-depth study.

2 MATTERS FOR ADDITIONAL STUDY.

For each group of parameters the matters requiring additional study have been stated below.

2.1 Power supply

- Voltage and frequency: 1520 mm systems regulate the minimum and maximum baseline indicators, while the TSI stipulates absolute minimum and maximum permitted in-use values.
- Parameters relating to supply system performance: the 1520 mm gauge system takes a different approach to power supply requirements from the TSI approach.
- Current capacity, DC systems, trains at standstill: the issue of power supply for passenger carriages at standstill requires further study.
- Electrical protection coordination arrangements: The applicability of specific values in the EN50388:2005 standard requires further analysis.
- Harmonics and dynamic effects for AC systems: The issue of the mutual effects of the rolling stock and power supply system is in the realm of scientific studies due to the short period that semi-conductor based engines have been in service. The applicability of individual values of the EN50388:2005 standard requires further study.
- Electric consumption measuring equipment: not standardised in the 1520 mm system.

2.2 Geometry of the OCL and quality of current collection

- Mean contact force: at present the 1520 mm gauge system only standardizes static force, dynamic force is not standardised at speeds up to 160 km/h.
- Dynamic behaviour and quality of current collection: the TSI values require additional testing for applicability in the 1520 mm gauge system.
- Pantograph spacing: the TSI values require additional testing for applicability in the 1520 mm gauge system.
- Contact wire material: the values in the EN50149:2001 standard require additional testing for applicability in the 1520 mm gauge system.
- Phase separation sections: the applicability of the EN50367:2006 standard requires additional testing.

- System separation sections: The TSI requirements as a whole are applicable for the 1520 mm gauge system, the values in the EN50122-2:1998 and EN50119:2009 standards must be retested. The applicability of 'short' separators requires additional testing.