

*AMSAT builds and operates satellites and related resources for the purpose of educating youth and adults in how to use this technology in the public interest.*

# ***This is AMSAT***

**The Radio Amateur Satellite Corporation**



Radio Amateur Satellite Corporation (AMSAT)  
712 H Street NE, Ste 1653  
Washington DC 20002  
info@amsat.org

AMSAT is a registered trademark of the Radio Amateur Satellite Corporation.  
Copyright 2022, Radio Amateur Satellite Corporation.  
This is AMSAT V.1.1 December 31, 2022.

# Table of Contents

President’s Letter .....	4
AMSAT Leadership .....	6
Strategic Plan 2021-2035 .....	7
Educational Relations.....	8
University Partnerships.....	8
Classroom Simulators.....	9
High Altitude Balloons.....	9
Youth Initiative .....	10
Online Lessons and Experiments .....	10
Earth Science CubeSat Simulators .....	11
Online Satellite Ground Stations.....	11
Satellites for Youth Interaction.....	11
Engineering .....	12
ASCENT.....	12
FOX-PLUS.....	13
GOLF.....	13
Member Services .....	14
Membership Portal .....	14
AMSAT.org Website .....	14
AMSAT News Service.....	14
AMSAT Bulletin Board .....	15
AMSAT Symposium .....	15
The AMSAT Journal .....	15
Publications.....	16
Satellite Tracking Software.....	16
Telemetry Collection Software.....	17
Training and Education.....	15
Operational Aids and Plans.....	17
AMSAT Ambassadors .....	17
International Space Station.....	17

## President's Letter

*"We have a strong fiscal foundation, an excellent governance and management team, generous volunteers who freely donate their time and expertise, and a diverse membership base who truly care about keeping Amateur Radio in space."*



Greetings to our members and stakeholders. The year 2021 has been a remarkable year, one of transitions and accomplishments, one that positions AMSAT for a year of growth and accomplishments in 2022.

The AMSAT Engineering team has been making significant progress on our highly elliptical orbit program GOLF (Greater Orbit, Larger Footprint). Under the leadership of our VP, Engineering, Jerry Buxton, NOJY, our volunteer engineers have worked tirelessly to develop its test bed satellite GOLF-TEE (Test Engineering Environment) for launch.

At the December 7, 2021, Board of Directors meeting, Jonathan Brandenburg, KF5IDY, presented a plan for a sustained presence of "easy sats" in low Earth orbit. "Easy sats" are low Earth orbit satellites with single channel FM repeaters that play a critical role in introducing new comers to Amateur Radio in space. So, I was both excited and impressed with Jonathan's proposal. Fox-Plus, as the new program will be called, is based on the original Fox bus design but will develop a new transceiver and power system in an open-hardware and open-source environment. In addition, Fox-Plus CubeSats will host student science, technology, engineering, and mathematics (STEM) experiments and AMSAT radio experiments.

Not to be outdone, our Educational Relations team completed its beta testing on the CubeSat Simulator, a plug-and-play device for students to study and analyze simulated CubeSat telemetry. Dr. Alan Johnston, KU2Y, and his team have done a phenomenal job. In addition, they have not only developed and released the new CubeSatSim Lite version, but Dr. Johnston and his team have begun to experiment with high altitude balloon launches to take the CubeSatSim concept to the next level of educational initiatives. I am also excited that we are ready to launch the AMSAT Youth Initiative, a wide ranging program to encourage youth to explore satellite and communications technologies in their application to study and manage the breadth of issues of life on earth such as climate change, pollution control, meteorology, natural resources preservation as well as others. This program is designed to bring the seemingly remote and far-out world of aerospace technologies into the real world of meaningful daily issues.

Behind the scenes, we have been busy modernizing back-office tasks, finding ways to more efficiently do business, and ensuring the AMSAT machine runs smoothly. Our modernization efforts, which really began with the May 2020 launch of our online member management system, have been the key to our overall success this year. Transforming a 52 year-old organization from brick and mortar to virtual was no easy task and not without a few hiccups along the way, but we are better positioned moving forward. It was a sad day packing up the AMSAT office in Kensington, Maryland, in May and putting everything in storage. To touch all that history reaffirmed why we do what we do.

Financially, AMSAT is on a solid footing, with over \$950,000 in cash and liquid investments. Our revenues are down from last year, as is the rest of the U.S. economy; however, we are on track to exceed our profitability margin over last year because of the cost-cutting measure we implemented. In 2020, \$0.82 of every dollar went to pay overhead. In 2021, that amount was reduced to \$0.56 for every dollar we brought in – a 31% reduction. This means much more of membership dues and revenues are going towards building satellites and expanding our educational efforts. With the increasing cost of flying satellites, it is obvious that revenue sources outside of the traditional Amateur Radio community are necessary. It is the responsibility of Frank Karnauskas, our VP, Development to communicate our educational and engineering goals to external corporate and philanthropic organizations to identify and secure the funds needed to accomplish our goals. This is not an easy task and will require the support of all AMSAT areas to ensure our success.

AMSAT membership has consistently been over 4,000 the past year, with 4,045 current members as of this writing. AMSAT's membership is diverse, representing 76 countries. While each comes for varied reasons (builders and operators, scientists and educators, HEO and LEO), we all come together for a single purpose: to keep amateur radio in space. So, what's next? With over 52 years of success, what are we going to do now?

We have an ambitious, forward-thinking plan that's ready to be put into action. We will focus our efforts on new communication systems that more efficiently allow us to communicate in space and spacecraft which will take us towards and beyond the next space horizon. At the same time, we will establish and maintain a path of sustainability that not only introduces space communications using Amateur Radio to the public but also nurtures them to be the next generation of satellite builders and operators.

I look forward to both the challenges and opportunities that lie ahead. AMSAT is in a very solid position from both a financial and a membership perspective. We have a strong fiscal foundation, an excellent governance and management team, generous volunteers who freely donate their time and expertise, and a diverse membership base who truly care about keeping Amateur Radio in space.

Sincerely,

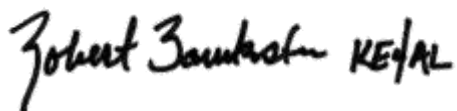
A handwritten signature in black ink that reads "Robert Bankston KE4AL". The signature is written in a cursive, slightly slanted style.

Robert Bankston, KE4AL  
President

# AMSAT Leadership, 2021-2022

## Board of Directors

**Joseph Armbruster, KJ4JIO**

President, OLat, Inc.  
Orlando, FL

**Robert Bankston, KE4AL**

Principal, C.P.A., Bevis, Eberhart,  
Browning, Walker & Stewart, P.C.  
Dothan, AL

**Gerald W. Buxton III, N0JY**

Senior Manager  
BNSF Railway (retired)  
Granbury, TX

**Mark Hammond, N8MH**

VP, Academic Affairs and Provost  
Campbell University  
Coats, NC

**Zach Metzinger, N0ZGO**

Principal Software Engineer  
METECS  
Southlake, TX

**Paul Stoetzer, N8HM**

Communications Specialist  
Federal Election Commission  
Washington, DC

**Bruce Paige, KK5DO**

Deputy  
Harris County Sheriff's Office (Retired)  
Roman Forest, TX

Board members are elected annually for a two-year term by AMSAT membership.

## Senior Officers

**Robert Bankston, KE4AL**

**President**  
Dothan, AL

**Paul Stoetzer, N8HM**

**Executive VP and Secretary**  
Washington, D.C.

**Jeff Davis, KE9V**

**Secretary**  
Yorktown, IN

**Steve Belter, N9IP**

**Treasurer**  
West Lafayette, IN

**Gerald W. Buxton III, N0JY,**

**VP, Engineering**  
Granbury, TX

**Drew Glasbrenner, KO4MA**

**VP, Operations**  
Brooksville, FL

**Alan Johnston, KU2Y**

**VP, Educational Relations**  
Philadelphia, PA

**Frank Karnauskas, N1UW**

**VP, Development**  
Tucson, AZ

Senior Officers are elected for one-year terms at the AMSAT Annual Meeting. The AMSAT Annual Meeting and Symposium is held in the month of October in various cities around the United States

(The phrase after each person's name is their Federal Communications Commission issued Amateur Radio callsign.)

# Strategic Plan 2021-2035

## Organization

### Our Vision

- To deploy satellite systems with the goal of providing wide-area and continuous coverage communications.
- To continue active participation in human space missions, and
- To support a stream of LEO satellites developed in cooperation with the educational community and other Amateur Radio satellite groups.

### Our Mission

- AMSAT is a non-profit volunteer organization which designs, builds, and operates experimental satellites and promotes space education.
- We work in partnership with government, industry, educational institutions, and fellow Amateur Radio societies.
- We encourage technical and scientific innovation and promote the training and development of skilled satellite and ground system designers and operators.

### Our Core Values

- We lead by example.
- We respect the individual.
- We work collaboratively towards a common purpose and shared goals.
- We embrace change and innovation to help our members, our partners, and ourselves.
- We are committed to the Amateur Radio satellite community.
- We are open and honest in our communication. Above all, we act with integrity.

## Strategic Satellite Objectives and Organization Goals

### Highly Elliptical Orbits

**Upward to HEO.** Develop and deploy a series of spacecraft capable of providing wide-area and continuous coverage from high-Earth and geostationary transfer orbits.

### Greater Orbit, Larger Footprint

**GOLF.** Develop and deploy a series of increasingly capable spacecraft through a program to learn skills and systems for which we do not yet have the necessary low-risk experience, including active attitude control, deployable/steerable solar panels, radiation tolerance for commercial off the shelf (COTS) components in higher orbits, and propulsion.

### Amateur Radio on the International Space Station

**AREx-A.** Partner with ARISS and ARISS-USA to advance Amateur Radio's presence aboard NASA's International Space Stations, Deep Space Gateway and Artemis missions and provide opportunities to engage with astronauts in lunar and deep space operations.

### Low Earth Orbit

**LEO.** Support a stream of LEO satellites developed in cooperation with the educational community and other Amateur Radio satellite groups.

**FM Operations.** Develop, deploy, and support a series of 1U spacecraft to support continued FM amateur satellite operations in low Earth orbit.

**Partnerships.** Develop a plug-and-play communications solution for educational and other Amateur Radio CubeSat programs, providing a VHF/UHF telemetry beacon, command receiver, and linear transponder or FM repeater communications module.

### AMSAT STEM Initiatives

**AMSAT Education.** Support science, technology, engineering, and mathematics (STEM) initiatives and training programs for satellite and ground system designers and operators.

**CubeSat Simulator.** Continue development of AMSAT's CubeSat Simulator Program.

**High Altitude Ballooning.** Develop program to support and sponsor the use of amateur radio in high-altitude balloon (HAB) launches.

**Youth Initiative.** Develop an educational outreach program that encourages youth to pursue STEM interests in space science and communication technology.

# Educational Relations

## University Partnerships

AMSAT partners with major research universities and colleges to fly experiments in space such as those with Virginia Tech, Vanderbilt University, Penn State University and the University of Washington. AMSAT partners with these research universities who provide the experiments while AMSAT provides the basic spacecraft, control and communications. At the end of the primary mission the university turns the satellite over to AMSAT for communication purposes.

**AMSAT's AO-92** has a Virginia Tech camera experiment and the University of Iowa's High Energy CubeSat Radiation Instrument (HERCI) experiment that is intended to provide a mapping of radiation in a low earth orbit. The instrument consists of a digital processing unit derived from processors currently in orbit around Saturn on Cassini and on the way to Jupiter on the Juno spacecraft.

**AMSAT's AO-95** flew a Vanderbilt University Low Energy Proton (LEP) radiation experiment and a Penn State University–Erie gyroscope experiment. In addition, Virginia Tech provided a VGA resolution camera experiment for pictures of the earth.

The University of Washington's **HuskySat-1** embodies aspects of future spacecraft design and how AMSAT collaborates with educational institutions. The spacecraft and experiments were designed and built by the University of Washington Husky Satellite Lab while primary communications and control hardware were provided by AMSAT.

Besides AMSAT's ability to help universities gain access to space, AMSAT's worldwide network of ground stations provides the ability to capture data that is downloaded while its satellites orbit the earth day and night.

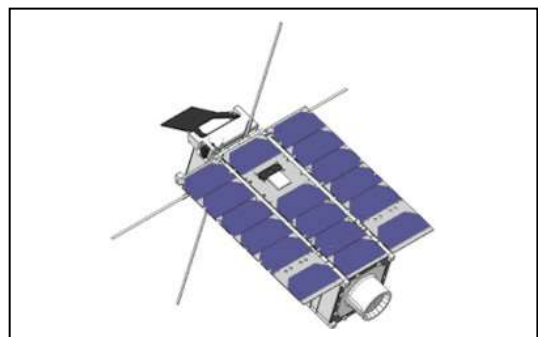



## Educational Relations...continued

Besides working at the university level, AMSAT is wholly engaged in working with teachers in Science, Technology, Engineering and Mathematics (STEM) education.

### Classroom Satellite Simulators

The AMSAT Educational Relations team designs and builds simulators to demonstrate certain functions and environmental effects of satellites in space. CubeSat Simulators are low-cost satellite emulators that run on solar panels and batteries, transmit radio telemetry and can be extended by additional sensors and modules. They can be used in a variety of classroom settings including grades 6-12 STEM and undergraduate engineering and science classes. The AMSAT CubeSat Simulator helps bridge the gap between High Altitude Balloons (HAB's) and actual orbiting CubeSats. The CubeSat Simulator is a low-cost, functional educational model of a CubeSat that can be built with a few hundred dollars in a few weeks. Students can learn soldering, 3D printing, Raspberry Pi computing and testing skills. In addition, receiving and decoding telemetry in the classroom can be useful training for either a HAB or CubeSat mission.



### High Altitude Balloons

The AMSAT Educational Relations team is actively developing teaching programs for the design and development of High Altitude Balloons for educational use. STEM payloads range from simple to very complex. An example of a simple payload may be just a location tracker so that students can observe the balloon's altitude and flight path in real-time. Very complex payloads carry an array of science experiments using multiple sensors or sensor packages coupled with radio transmitters to return the data in real-time via custom-built ground station receivers. In addition, most payloads record data from the sensors on board to be retrieved and analyzed after the flight and when ground chase teams recover the payload.



# Youth Initiative

The AMSAT Youth Initiative is designed to put learning resources for space-bound education directly in the hands of youth, their parents and youth group leaders. It is unique because its approach to youth is to put the sometimes-forbidding sounding topic of aerospace or astronautics into the perspective of our everyday lives – how we study climate change, protect natural resources, listen to music and navigate our way around city streets as well as other things we take for granted.

Two trademarked brand names focus on two age groups – KidzSat for grades 5-7 and BuzzSat for grades 8-12.

Also unique in this program is its partnership with local media outlets. Participating local television stations in up to 210 major markets provide the Youth Initiative with an invaluable local presence through promotion and local technical support. Television stations in return are provided with a unique way for their on-the-air personalities to further engage with their audiences and boost viewership.

The Youth Initiative provides four primary opportunities in which youth can participate.

## Online Lessons and Experiments

Presented through the websites KidzSat.com for grades 5-7 and BuzzSat.com for grades 8-12, youth have direct access to a wealth of resources, lessons and experiments. The content is designed for self-directed learning, preferably with the guidance and encouragement of a parent, teacher or youth group leader. The content approaches youth's interest in earth sciences, careers and other paths by showing how satellites in space can help us improve our lives here on earth. By completing self-directed lessons and performing experiments students can earn certificates of completion.

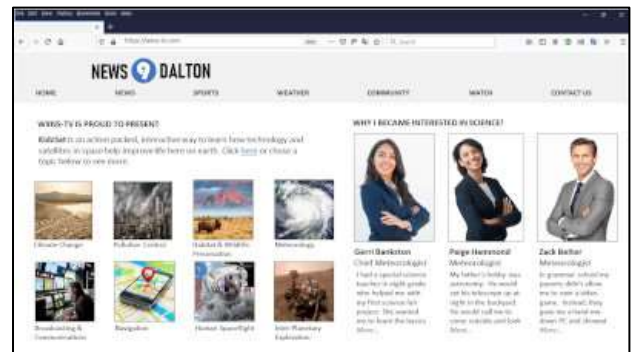

## Youth Initiative...continued

### Earth Science CubeSat Simulators

Referred to as our Non-Orbiting Earth Science Experiments (NOESE), these self-contained, solar powered satellite simulators are to be hosted at participating local television stations. NOESE devices collect climate change data such as particulate matter, carbon dioxide, methane, nitrogen and sulfur oxides, ozone and ultra-violet radiation (UV). Using online simulated ground stations, youth can download the telemetry and convert it into usable data for study. The NOESE “satellites” provide youth with a realistic experience that closely resembles the process that scientists follow when tracking and collecting telemetry from live satellites.

### Online Satellite Ground Stations

Youth participants can experience the thrill of satellite communication through the KidzSat network of satellite ground stations accessible with their tablet or laptop. The platform anticipates a ground station in each of the 210 television marketplaces. This means virtually every young person in the U.S. has the ability to interact with satellites as they pass overhead in their own hometown. With these live stations, youth can download and analyze NOAA weather pictures, a variety of satellite telemetry and educationally oriented experiments from live satellites. This experience will encourage students to take the next step and set up their own ground stations with readily accessible, low-cost radios that connect to their tablet or laptop.

### Easily Accessible Satellites for Youth Interaction

AMSAT has 50+ years of experience designing, building and operating amateur satellites carrying educational, scientific and communications payloads. AMSAT is currently designing and building a new generation of low earth orbiting satellites (FOX-PLUS) that will provide more easily received signals and advanced educational and experimental payloads.

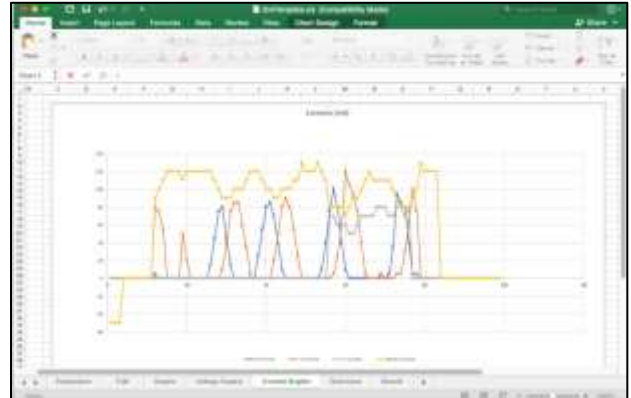



# Engineering

While all senior officers and members of the Board of Directors contribute to the educational and scientific definition and conceptual designs of AMSAT satellites, the Engineering team is responsible for the hardware and software design of its satellites, their construction, testing and launch.

The Engineering team is composed entirely of unpaid volunteers, most of whom are electronic engineers or software programmers with extensive experience in the aerospace industry. At any given time, approximately 60 or more professionals are donating their time, energy and expertise to bring AMSAT satellites from the drawing board to reality.

In keeping with AMSAT's strategic plan, the Engineering team is responsible for continuing to provide a series of low earth orbit (LEO), easily accessible satellites to support its educational purposes. It must also press ahead to design, build and launch satellites in highly elliptical orbits to support the research needs of advanced users to further the cutting edge of satellite communications technologies.

## ASCENT

The **A**dvanced **S**atellite **C**ommunications and **E**xploration of **N**ew **T**echnology program lies at the core of AMSAT's engineering efforts. It is from within the ASCENT team that cutting edge communications technologies are explored and strategic decisions are made to guide the overall direction of AMSAT's satellite design and engineering efforts.

Central to ASCENT's interests is the rapidly evolving technology for software defined radios, or SDR's. This new frontier of radio technology offers unprecedented flexibility in the bands in which radios can operate, the modes of operation that can be utilized and the almost unlimited range of educational experiences and scientific experiments that can be supported.

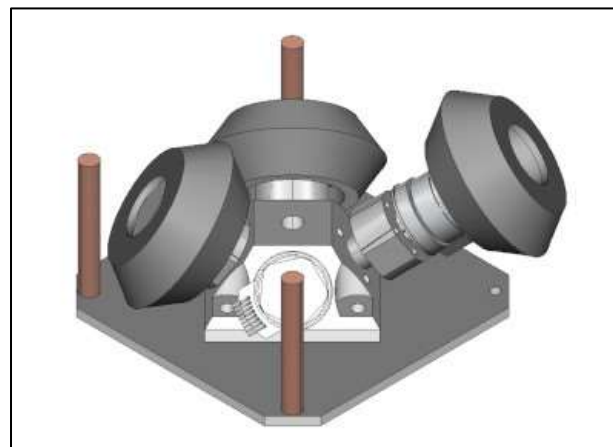
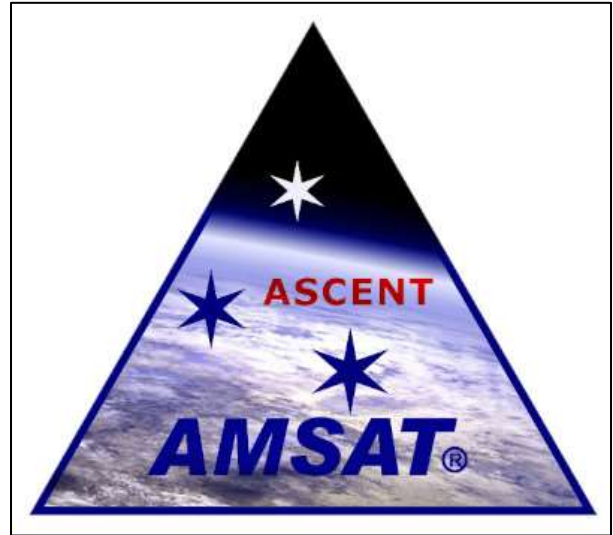

# Engineering...continued

## FOX-PLUS

AMSAT's FOX-1 series of low earth orbit satellites beginning in 2015 became an immediate hit by providing easy access to space communications via Amateur Radio. This breakthrough design gave countless students and adult experimenters their first taste of communications via satellite. With the FOX-1 satellites reaching the end of their life expectancy, AMSAT begins the development of the FOX-Plus satellites.

The FOX-Plus satellites will continue the tradition of providing easy access to two-way communications for experimenters with inexpensive radios and simple antennas. These satellites are designed with advanced software defined radios that will provide high flexibility to support advanced educational and scientific experiments. Improved computing power will offer the possibility of more interactive, multimedia experiences.

## GOLF

The **G**reater **O**rbit for **L**arger **F**ootprint program means flying satellites in extended orbits in order to provide wider geographical coverage for users on earth. Besides the usual challenges of designing radios to operate over longer distances, building satellites for these far-out orbits means constructing them to survive the increased rigors of outer space. The GOLF series of satellites are the ultimate test for AMSAT's engineering efforts for operating software defined radios across microwave frequencies, solar power generation and battery management, attitude detection and control for antenna steering, and systems hardening to increase survivability in space's harshest environment.

All AMSAT engineering designs are published as openly available documents to be shared among all interested in amateur satellite operation.

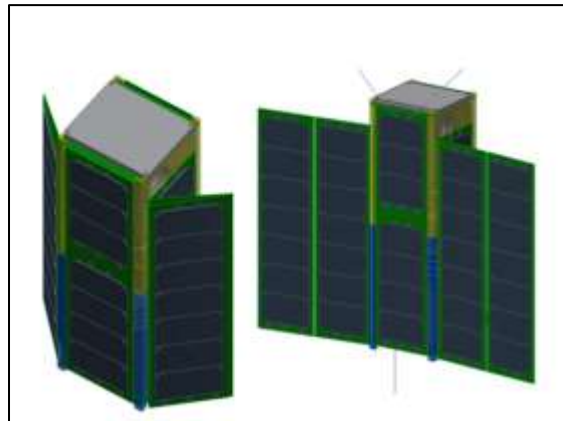
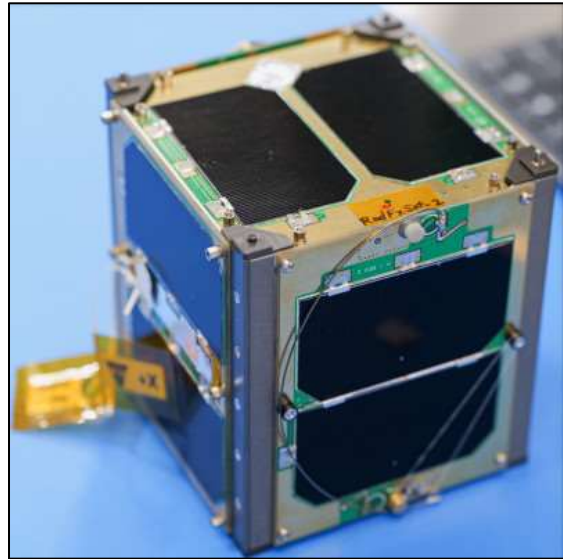

# Member Services

## Membership Portal

The Membership Portal is the gateway to AMSAT member features and benefits. Here, members can renew their membership, update their contact information, make additional donations and register for events.

The portal also provides members with exclusive access to the archives of the *AMSAT Journal* and Symposium Proceedings as well as other member benefits.

## AMSAT.org Website

AMSAT maintains a comprehensive website with pages of information about the organization itself, educational offerings, beginner tutorials, satellite information, projects, events, and member services. The website has links to pages that answer almost any question concerning amateur satellite operation.

## AMSAT News Service

The AMSAT News Service (ANS) bulletins are a free, weekly news and information service of AMSAT. The ANS bulletin publishes a variety of news related to Amateur Radio in space, including reports on the activities of Amateur Radio operators worldwide who share an active interest in designing, building, launching and communicating through analog and digital Amateur Radio satellites.

ANS bulletins are distributed via email to a list of more than two thousand subscribers worldwide. While most subscribers are radio amateurs, the subscription list also includes academic researchers, journalists, and scientific organizations who desire a regular capsule summary of Amateur Radio satellite activities.

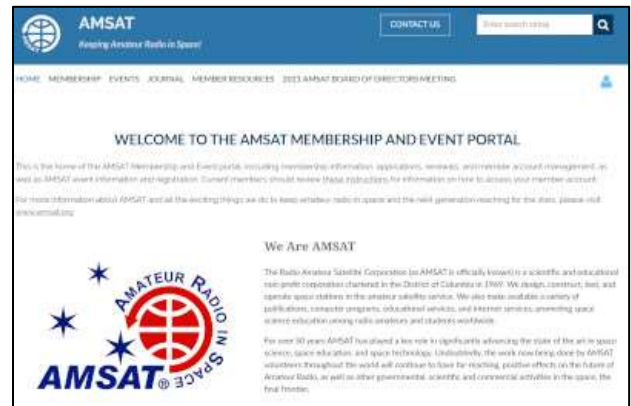



## Member Services...continued

### AMSAT Bulletin Board

The Bulletin Board is an email mailing list available free to any who subscribe. The Bulletin Board offers users the opportunity to post questions, share observations, and exchange technical aid or opinions about satellite radio operating procedures. With approximately 3,000 subscribers at present, the Bulletin Board is a lively forum for discussion about satellite technology and operation with participants from around the world.

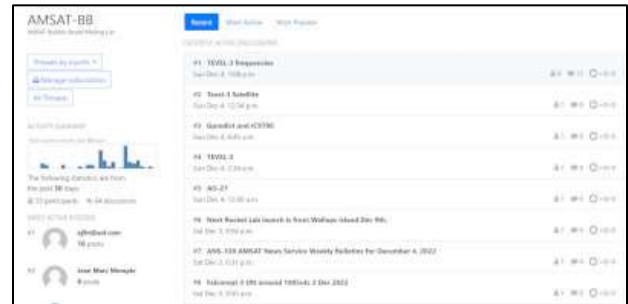

### AMSAT Symposium

Since the early 1990s, AMSAT has held an annual gathering at various locations around North America. Modeled upon an academic conference, the Symposium features presentations on technical projects, software, and future satellite plans. Also included are also presentations of interest to beginners, and a good measure of informal chat between sessions and at the closing banquet.



Written versions of the Symposium presentations are collected in an edited volume of *Proceedings* that are published electronically for distribution at no charge to AMSAT members and registered Symposium attendees, and sold at modest cost to those requesting them.

### The AMSAT Journal

*The AMSAT Journal* is a bi-monthly digital magazine for Amateur Radio-in-space enthusiasts. It is available to members, along with archived issues, on the membership portal of the AMSAT website. Each issue is a source for hardware and software projects, technical tips, STEM initiatives, operational activities, and news from around the world. *The AMSAT Journal* is professionally edited with assistance from a team of volunteers with expertise in publishing and technical writing. Articles range from introductory projects for beginners to advanced scientific research reports.

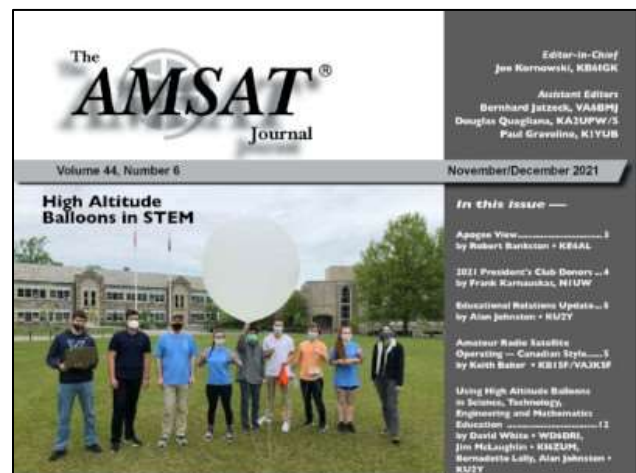

## Member Services...continued

### Publications

AMSAT supports all interested parties with publications ranging from a beginner's guidebook to collections of advanced technical articles.

*Getting Started with Amateur Satellites* is the definitive reference written for the new satellite operator and includes discussions for the experienced operator.

In it, the new operator is introduced to the basic concepts and terminology unique to this mode of communications. Also included is information on satellites that are expected to be launched in the coming years.

### Satellite Tracking Software

AMSAT offers for sale tracking software for both Windows and Apple platforms. With these sophisticated apps, enthusiasts can plan their communications with dozens of available amateur satellites from anywhere on the globe.

In addition to the software-based applications, anyone can use the online satellite prediction tool on the AMSAT.org website to predict the orbit of any working amateur satellite.

### Telemetry Collection Software

Downloading and capturing telemetry from satellites is a critical function performed by amateur satellite enthusiasts around the world. Telemetry is essential for control operators to maintain the health of satellites and is the conduit for capturing the results of the scientific payloads that many AMSAT satellites support. AMSAT published FOX-TELEM software to capture this telemetry and forward it to a data warehouse where control operators and experiment principals can access this essential information.

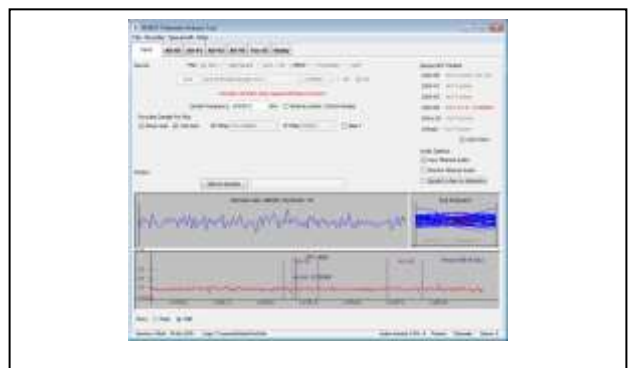
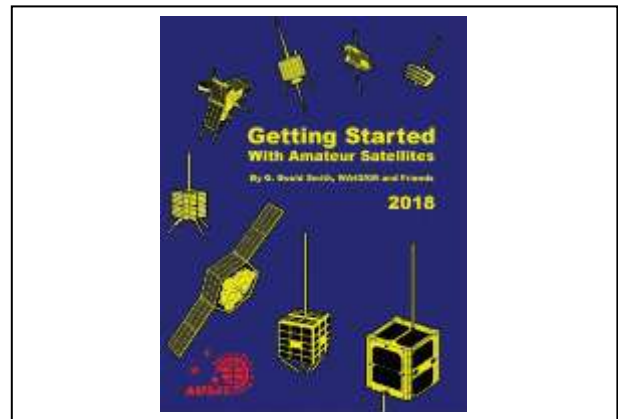



# Member Services...continued

## Training and Education

Education has always been part of AMSAT's mission. Sharing our passion for Amateur Radio and space is an excellent way to advance educational outreach for STEM (Science Technology Engineering and Math) education. AMSAT educational outreach takes many different forms including:

- **Operational Aids and Plans**  
AMSAT provides beginning satellite communicators with a wide assortment of articles and brochures detailing how to assemble their first station and how to make their first satellite contact.
- **AMSAT Ambassadors**  
Outreach within the educational, experimental and public communities and the public is provided by AMSAT Ambassadors. These volunteers provide instructive presentations on space communications, stage live demonstrations of satellite communications and host displays at various events and conferences.
- **International Space Station**  
AMSAT volunteers provides technical and operational support for radio contacts between school students and astronauts onboard the International Space Station organized by ARISS (Amateur Radio on the International Space Station).

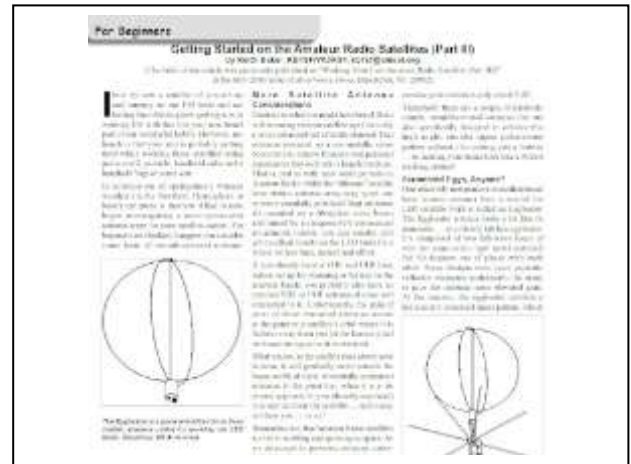

**Radio Amateur Satellite Corporation (AMSAT)**  
712 H Street NE, Ste 1653  
Washington DC 20002  
[info@amsat.org](mailto:info@amsat.org)

