

Whale Sighting

Designed by Natalie Crabtree
Featuring *Whale Tales* by Katherine Quinn

SIZE: 63" x 77"

FREE
PROJECT



THIS IS A DIGITAL REPRESENTATION OF THE QUILT TOP, FABRIC MAY VARY.





PLEASE NOTE: BEFORE MAKING YOUR PROJECT, CHECK FOR ANY PATTERN UPDATES AT WINDHAMFABRICS.COM'S FREE PROJECTS SECTION.

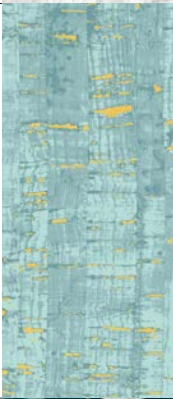

Whale Sighting

Cutting Notes: Mark and store your cutting pieces, as this will make matching fabrics easier when piecing begins. Be sure to read the entire pattern before you begin.





Designer Notes: Before cutting Templates B-E, unfold the WOF strip so that only (1) cut is being made at a time. This is to avoid mirror image cutting and other cutting errors.

KEY	FABRIC	SKU	YD	CUTTING INSTRUCTIONS
A		50107M-4 Birch UNCORKED	2	(1) 63½" x WOF strip, so that the Fabric A area being cut measures approximately 63½" x 44" before trimming selvages. Trim the strip to measure 63 ½" x 35 ½". Set aside. From the remaining yardage cut (4) Template B and (4) Template C.
B		50107M-16 Acid Wash UNCORKED; INCLUDES BINDING	1¾	(1) 7½" x WOF strip. Subcut (5) Template A. (2) 4" x WOF strips. Subcut (8) Template B and (8) Template C. Turn the templates 180° after each cut to best utilize fabric. (2) 4" WOF strips. Subcut (16) Template D. (8) 2¼" x WOF strips for binding. Use the remaining yardage to fuse Water Drops A-D onto the wrong side of fabric. Use scissors to cut out each template on the traced line and set aside. Leave the paper on the glue side of the fusible web at this time.
C		52099-1 Ocean	½	(1) 7½" x WOF strip. Subcut (3) Template A. (1) 4" x WOF strip. Subcut (2) Template B and (2) Template C. Turn the templates 180° after each cut to best utilize fabric. (1) 4" WOF strip. Subcut (6) Template D.
D		52099-2 Surf	5/8	(1) 7½" x WOF strip. Subcut (3) Template A. (1) 4" x WOF strip. Subcut (5) Template B and (5) Template C. Turn the templates 180° after each cut to best utilize fabric. (2) 4" WOF strips. Subcut (12) Template D.
E		52100-1 Ocean	½	(1) 7½" x WOF strip. Subcut (3) Template A. (1) 4" x WOF strip. Subcut (4) Template B and (4) Template C. Turn the templates 180° after each cut to best utilize fabric. (1) 4" WOF strip. Subcut (10) Template D.

PROJECT DISCLAIMER: Every effort has been made to ensure that all projects are error free. All the information is presented in good faith, however, no warranty can be given nor results guaranteed. Therefore, we assume no responsibility nor damages that may occur when referring to this pattern. When errors are brought to our attention, we make every effort to correct and post a revision as soon as possible. We suggest you check windhamfabrics.com for pattern updates and to test the pattern prior to making the project. Test templates first, before cutting all the pieces. Free projects are not for resale.



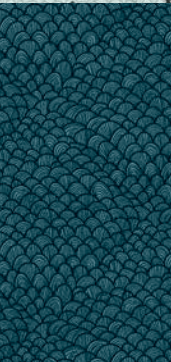

Whale Sighting

KEY	FABRIC	SKU	YD	CUTTING INSTRUCTIONS
F		52100-3 Sea Green	1/2	(1) 7 1/2" x WOF strip. Subcut (5) Template A. (1) 4" x WOF strip. Subcut (3) Template B and (3) Template C. Turn the templates 180° after each cut to best utilize fabric. (1) 4" WOF strip. Subcut (6) Template D.
G		52101-1 Ocean	1/2	(1) 7 1/2" x WOF strip. Subcut (4) Template A. (1) 4" x WOF strip. Subcut (4) Template B and (3) Template C. Turn the templates 180° after each cut to best utilize fabric. (1) 4" WOF strip. Subcut (7) Template D.
H		52101-2 Surf	5/8	(2) 7 1/2" x WOF strips. Subcut (7) Template A, (3) Template B, and (4) Template C. Turn the templates 180° after each cut to best utilize fabric. (1) 4" WOF strip. Subcut (7) Template D.
I		52102-5 Sun Bleached	5/8	(1) 7 1/2" x WOF strip. Subcut (5) Template A. (3) 4" x WOF strips. Subcut (5) Template B, (6) Template C and (11) Template D. Turn the templates 180° after each cut to best utilize fabric.
J		52103-6 Seafoam	1/2	(1) 7 1/2" x WOF strip. Subcut (4) Template A. (1) 4" x WOF strip. Subcut (4) Template B, and (3) Template C. Turn the templates 180° after each cut to best utilize fabric. (1) 4" WOF strip. Subcut (10) Template D.
K		52104-1 Ocean	1	(1) 7 1/2" x WOF strip. Subcut (4) Template A. (2) 4" x WOF strips. Subcut (8) Template B, (6) Template C, and (1) Template D. Turn the templates 180° after each cut to best utilize fabric. (1) 4" WOF strip. Subcut (10) Template D. Use remaining yardage to fuse the Whale Body and Whale Tail onto the wrong side of fabric. Use scissors to cut out each template on the traced line and set aside. Leave the paper on the glue side of the fusible web at this time.



Whale Sighting

KEY	FABRIC	SKU	YD	CUTTING INSTRUCTIONS
L		52104-8 Aqua	7/8	(2) 7½" x WOF strips. Subcut (10) Template A. (1) 8" x WOF strip. Subcut (1) Template A. Trim the remainder of the strip into (2) 4" x WOF strips measuring approximately 4" x 34½". Subcut (12) Template D. (1) 4" x WOF strip. Subcut (3) Template B and (4) Template C. Turn the templates 180° after each cut to best utilize fabric.
		Backing	4	
				71" x 85" piece of batting.

Fusible Web

(Instructions included in this pattern are for raw edge appliqué. The printed size of the templates are the finished size of the appliqué.)

- Cut out templates from all template pages along the black printed line. Tape templates together by aligning the black lines for a seamless transition between template pieces.
- Place the Whale Body, Whale Tail, and Water Drops A-D wrong side up and printed side down onto the smooth side of fusible web. **Templates are not reversed therefore placing wrong side up will ensure templates are oriented correctly when appliquéd.**
- Trace (1) of each template onto the smooth side of fusible web.
- Roughly cut out each fusible web template just outside of the traced line. Set aside for further instruction.

Piecing Instructions

(Designer Note: The Ocean Waves are assembled in (6) rows. Rows 1-6 use a combination of **Fabrics B-L** and Templates A-E. Templates B-E are always located on the same side of Template A. See diagram below. Curved piecing is used to sew Templates B-E onto the curved sides of Template A as shown. Fabric placement within each row is crucial for quilt assembly. Follow diagrams closely for accurate fabric placement. Fabrics are labeled for each row's assembly diagram. Fabrics should transition between rows to create clam shells.)



Whale Sighting

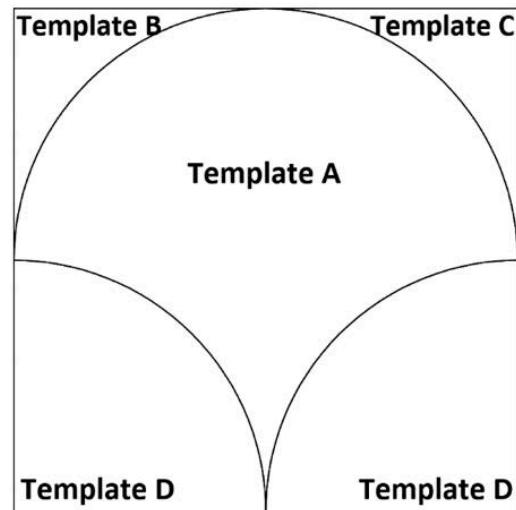

1. Use the following instructions to complete Wave Blocks for Rows 1-6. Place Templates B and C on either side of Template A. Align the bottom edges of the templates and pin in place thoroughly. Begin sewing Templates B and C onto Template A one at a time, starting with the bottom edge and working your way towards the top rounded edge of the template. Sew slowly through the curved seam, using your fingers to smooth the edges and keep fabrics aligned as you go.
2. Seams connecting Template A to Template B and Template A to Template C should overlap by approximately $\frac{1}{4}$ " at the top center. Once complete, press outward toward Templates B and C.
3. Place (1) Template D from (2) prints on either side of Template A. Align both ends of the templates and pin in place thoroughly. Begin sewing both Template D onto Template A one at a time. Sew slowly through the curved team, using your fingers to smooth the edges and keep fabrics aligned as you go.
4. Once complete, press outward toward Template D.
5. Completed Wave Block should measure $7\frac{1}{2}$ " x $7\frac{1}{2}$ " unfinished. (Piecing Diagrams show seams and fabric overlap.)

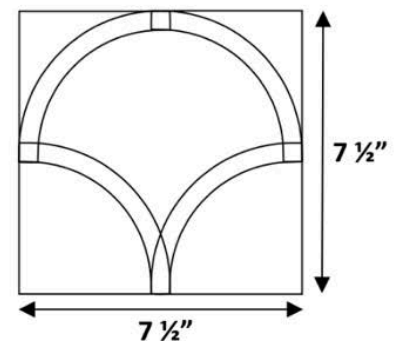
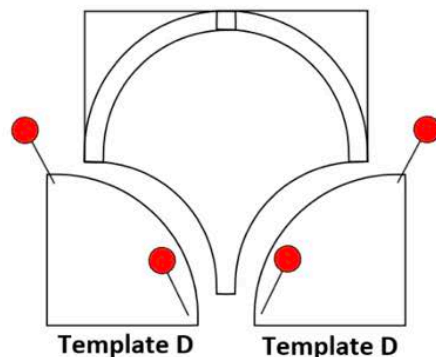
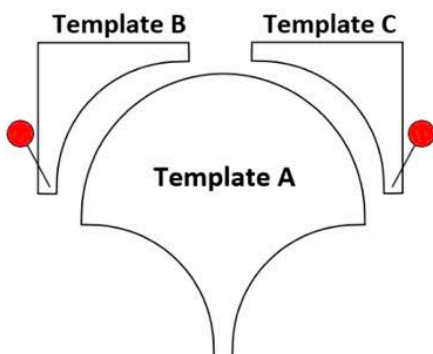



Whale Sighting

6. Begin assembly for Rows 1-6 using the instructions above. Each Wave Block is labeled according to what fabric is used for Template A, Template B, Template C, Template D L (Left) and Template D R (Right). Fabric labels are abbreviated to save space. Example: **Fabric A** is "A". Diagrams show the rows separated by Wave Block and completed. Arrows used in the row completion diagram indicate pressing instruction for seams connecting each Wave Block. Ensure fabric placement before proceeding. All rows will measure 7½" x 63½" upon completion.

ROW 1:

Temp A: K	Temp A: E	Temp A: H	Temp A: L	Temp A: F	Temp A: C	Temp A: L	Temp A: I	Temp A: F
Temp B: A	Temp B: A	Temp B: K	Temp B: A	Temp B: A	Temp B: K	Temp B: K	Temp B: K	Temp B: K
Temp C: A	Temp C: K	Temp C: A	Temp C: A	Temp C: K	Temp C: K	Temp C: K	Temp C: K	Temp C: A
Temp D L: C	Temp D L: B	Temp D L: D	Temp D L: I	Temp D L: K	Temp D L: L	Temp D L: H	Temp D L: G	Temp D L: E
Temp D R: B	Temp D R: D	Temp D R: I	Temp D R: K	Temp D R: L	Temp D R: H	Temp D R: G	Temp D R: E	Temp D R: I

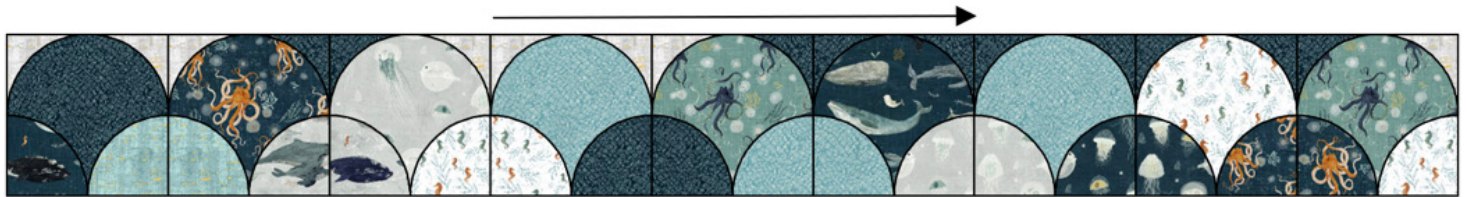

Row 1 Complete

ROW 2:

Temp A: L	Temp A: F	Temp A: G	Temp A: J	Temp A: G	Temp A: B	Temp A: J	Temp A: L	Temp A: K
Temp B: C	Temp B: B	Temp B: D	Temp B: I	Temp B: K	Temp B: L	Temp B: H	Temp B: G	Temp B: E
Temp C: B	Temp C: D	Temp C: I	Temp C: K	Temp C: L	Temp C: H	Temp C: G	Temp C: E	Temp C: I
Temp D L: G	Temp D L: I	Temp D L: B	Temp D L: I	Temp D L: B	Temp D L: L	Temp D L: K	Temp D L: B	Temp D L: D
Temp D R: I	Temp D R: B	Temp D R: I	Temp D R: B	Temp D R: L	Temp D R: K	Temp D R: B	Temp D R: D	Temp D R: F

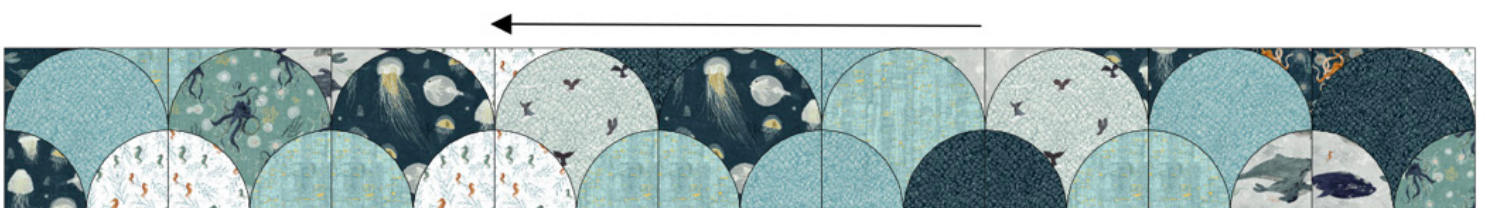

Row 2 Complete



Whale Sighting

ROW 3:

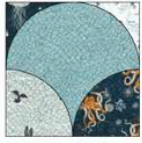

Temp A: L
 Temp B: G
 Temp C: I
 Temp D L: J
 Temp D R: E

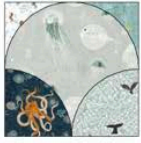

Temp A: H
 Temp B: I
 Temp C: B
 Temp D L: E
 Temp D R: J

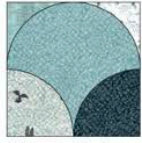

Temp A: L
 Temp B: B
 Temp C: I
 Temp D L: J
 Temp D R: K

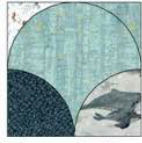

Temp A: B
 Temp B: I
 Temp C: B
 Temp D L: K
 Temp D R: D



Temp A: E
 Temp B: B
 Temp C: L
 Temp D L: D
 Temp D R: F



Temp A: B
 Temp B: L
 Temp C: K
 Temp D L: F
 Temp D R: L



Temp A: I
 Temp B: K
 Temp C: B
 Temp D L: L
 Temp D R: E

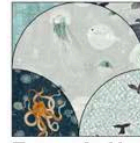

Temp A: H
 Temp B: B
 Temp C: D
 Temp D L: E
 Temp D R: J

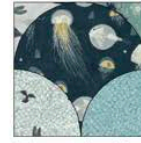

Temp A: G
 Temp B: D
 Temp C: F
 Temp D L: J
 Temp D R: L



Row 3 Complete

ROW 4:



Temp A: H
 Temp B: J
 Temp C: E
 Temp D L: F
 Temp D R: C



Temp A: D
 Temp B: E
 Temp C: J
 Temp D L: C
 Temp D R: G

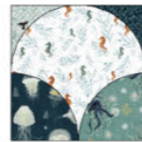

Temp A: I
 Temp B: J
 Temp C: K
 Temp D L: G
 Temp D R: F



Temp A: B
 Temp B: K
 Temp C: D
 Temp D L: F
 Temp D R: H



Temp A: C
 Temp B: D
 Temp C: F
 Temp D L: H
 Temp D R: B



Temp A: J
 Temp B: F
 Temp C: L
 Temp D L: B
 Temp D R: B



Temp A: D
 Temp B: L
 Temp C: E
 Temp D L: B
 Temp D R: B

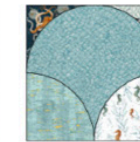

Temp A: L
 Temp B: E
 Temp C: J
 Temp D L: B
 Temp D R: I



Temp A: C
 Temp B: J
 Temp C: L
 Temp D L: I
 Temp D R: H

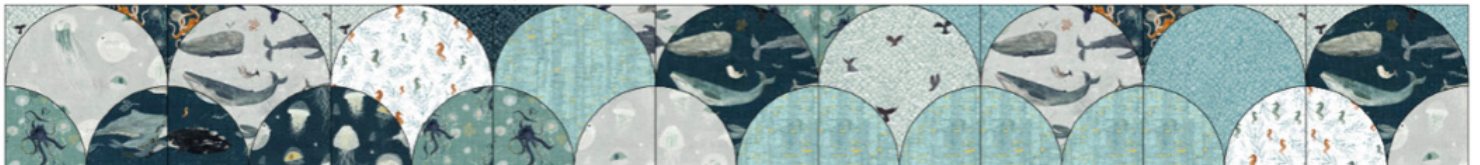

Row 4 Complete



Whale Sighting

ROW 5:



Temp A: B
Temp B: F
Temp C: C
Temp D L: K
Temp D R: D

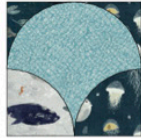

Temp A: L
Temp B: C
Temp C: G
Temp D L: D
Temp D R: G



Temp A: J
Temp B: G
Temp C: F
Temp D L: G
Temp D R: H



Temp A: I
Temp B: F
Temp C: H
Temp D L: H
Temp D R: D

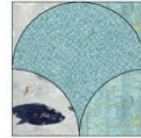

Temp A: L
Temp B: H
Temp C: B
Temp D L: D
Temp D R: B



Temp A: K
Temp B: B
Temp C: B
Temp D L: B
Temp D R: I

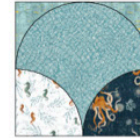

Temp A: L
Temp B: B
Temp C: B
Temp D L: I
Temp D R: E



Temp A: D
Temp B: B
Temp C: I
Temp D L: E
Temp D R: J

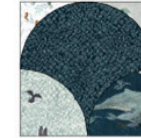

Temp A: K
Temp B: I
Temp C: H
Temp D L: J
Temp D R: C

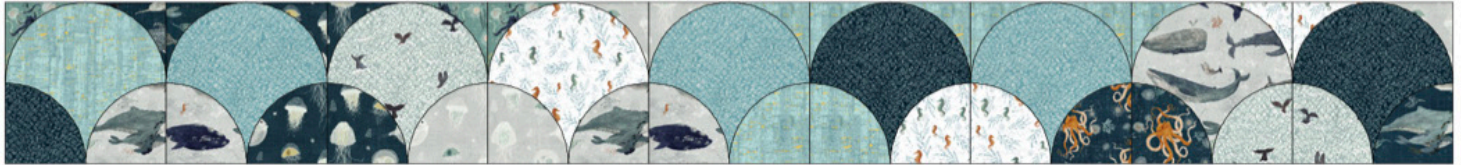

Row 5 Complete

ROW 6:



Temp A: I
Temp B: K
Temp C: D
Temp D L: J
Temp D R: L



Temp A: H
Temp B: D
Temp C: G
Temp D L: L
Temp D R: E

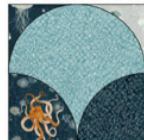

Temp A: L
Temp B: G
Temp C: H
Temp D L: E
Temp D R: K



Temp A: F
Temp B: H
Temp C: D
Temp D L: K
Temp D R: L

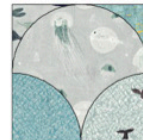

Temp A: H
Temp B: D
Temp C: B
Temp D L: L
Temp D R: J



Temp A: G
Temp B: B
Temp C: I
Temp D L: J
Temp D R: C



Temp A: F
Temp B: I
Temp C: E
Temp D L: C
Temp D R: K



Temp A: H
Temp B: E
Temp C: J
Temp D L: K
Temp D R: D



Temp A: E
Temp B: J
Temp C: C
Temp D L: D
Temp D R: L

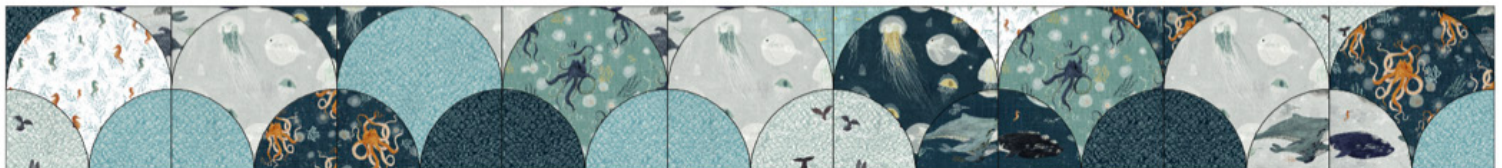

Row 6 Complete



Whale Sighting

Quilt Assembly

7. Lay out Rows 1-6 in numerical order as shown. **Fabrics B-L** should create continuous clam shell patterns when rows are placed together. Sew together using a $\frac{1}{4}$ " seam, using pins to help nestle seams.

8. When complete, the bottom of the quilt should measure $63\frac{1}{2}$ " x $42\frac{1}{2}$ " unfinished.

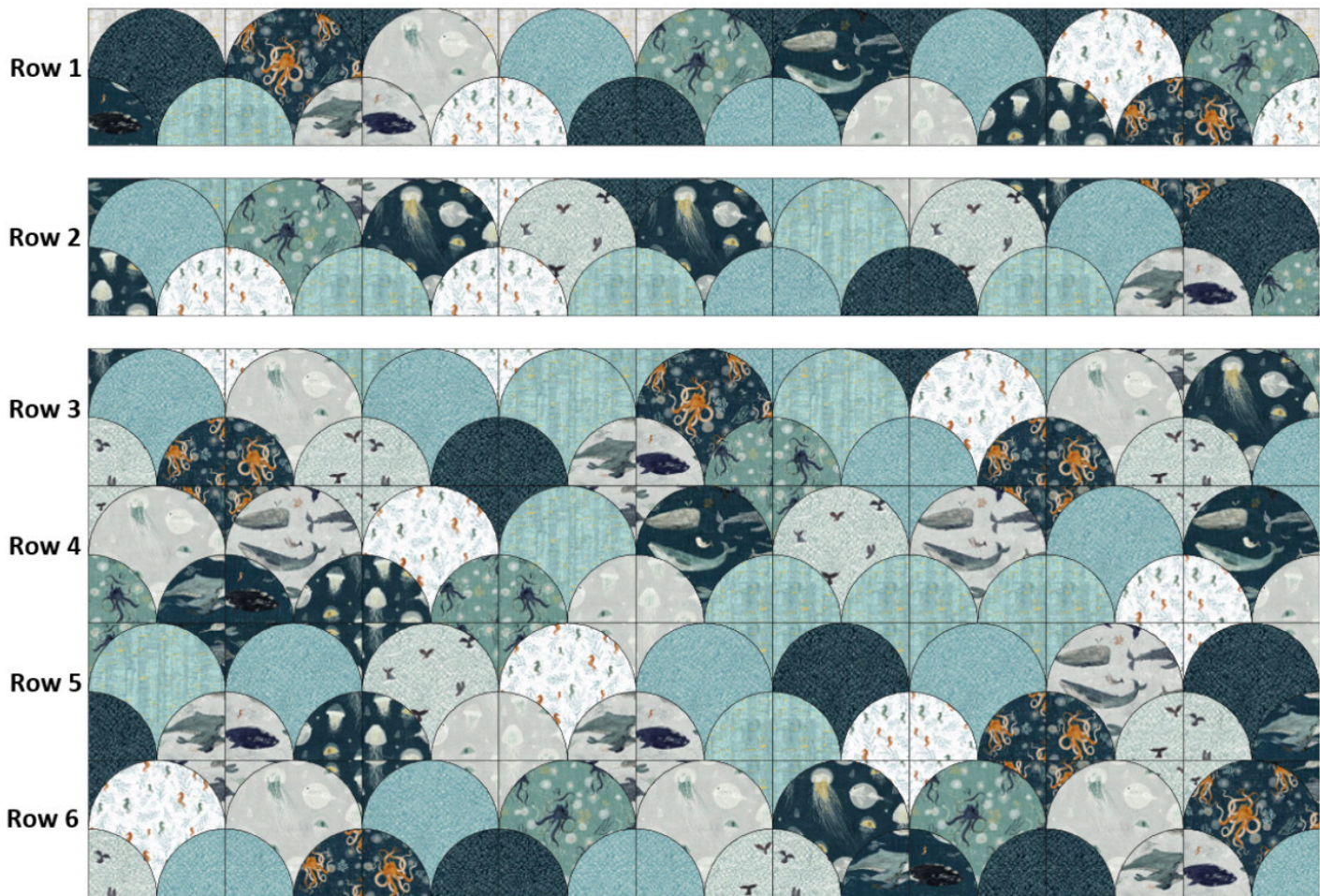

9. Lay out the **Fabric A** $63\frac{1}{2}$ " x $35\frac{1}{2}$ " fabric piece and the bottom of the quilt as shown. Remove the paper from the glue side of each fusible web template to begin appliqué placement. Do not iron at this time. Place the Whale Body and Whale Tail, aligning the appliqué templates with the **Fabric K** Template B and C pieces so that it appears that the whale is rising above the waves. Align the Whale Body and Whale Tail with the edge of the **Fabric A** piece. Please note that a $\frac{1}{4}$ " of the Whale Body and Whale Tail will be sewn into the seam allowance when placing the appliqué.



Whale Sighting

10. Place Water Drops A-E as shown in the Quilt Assembly Diagram on Page 10.
11. Once you are happy with appliqué placement, thoroughly pin in place before moving the **Fabric A** piece.
12. Move the **Fabric A** piece with appliqués pinned to the ironing board, thoroughly fuse in place using manufacturer's instructions.
13. Stitch around each individual appliqué using a thread color and decorative stitch of your choice.
14. Sew the completed top half of the quilt to the completed bottom half of the quilt, using pins to help align the Whale Tail and Body with the **Fabric K** Template B and C pieces. Press toward the top half of the quilt to complete. Quilt top should measure 63½" x 77½" unfinished.

Finishing

15. With the backing fabric laying taut, place batting and then quilt top to form quilt sandwich.
16. Baste sandwich. Quilt as desired.
17. Bind with **Fabric B** to finish quilt.



Whale Sighting

QUILT ASSEMBLY DIAGRAM



PLEASE PRINT TEMPLATES
AT 100% SCALE.

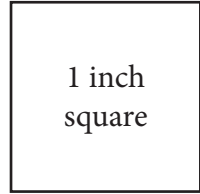

Whale Tail Template Part 1 of 3



Whale Sighting Templates by Natalie Crabtree

Template Page 2/12

PLEASE PRINT TEMPLATES
AT 100% SCALE.

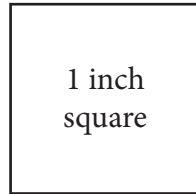

Whale Tail Template Part 2 of 3



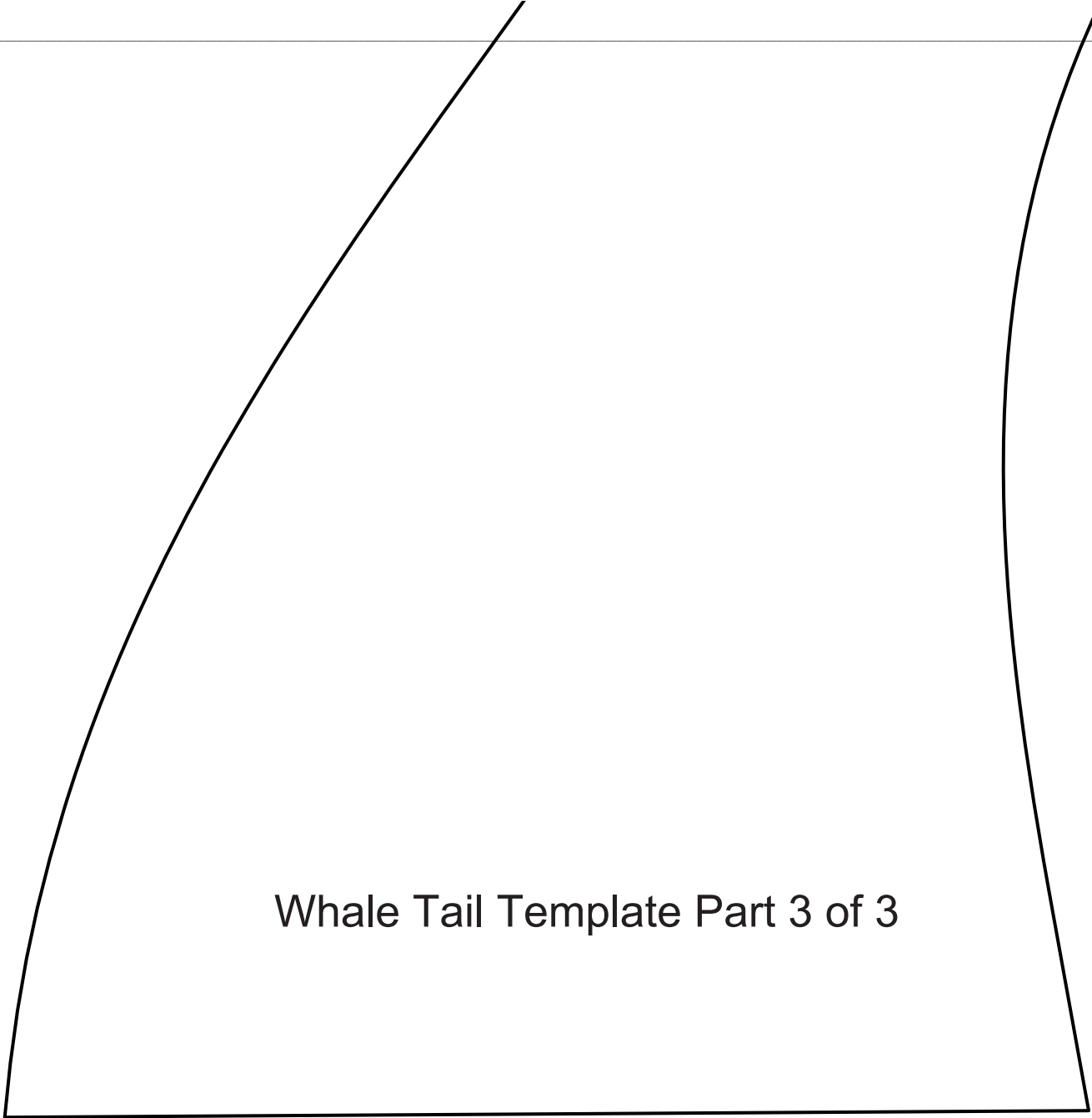

Whale Tail Template Part 3 of 3

Whale Sighting Templates by Natalie Crabtree Template Page 3/12

PLEASE PRINT TEMPLATES
AT 100% SCALE.

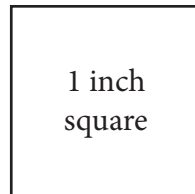



Water Drop
C

Whale Sighting Templates by Natalie Crabtree
Template Page 4/12

PLEASE PRINT TEMPLATES
AT 100% SCALE.

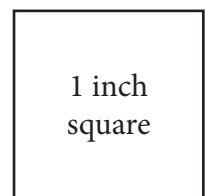

PLEASE PRINT TEMPLATES
AT 100% SCALE.

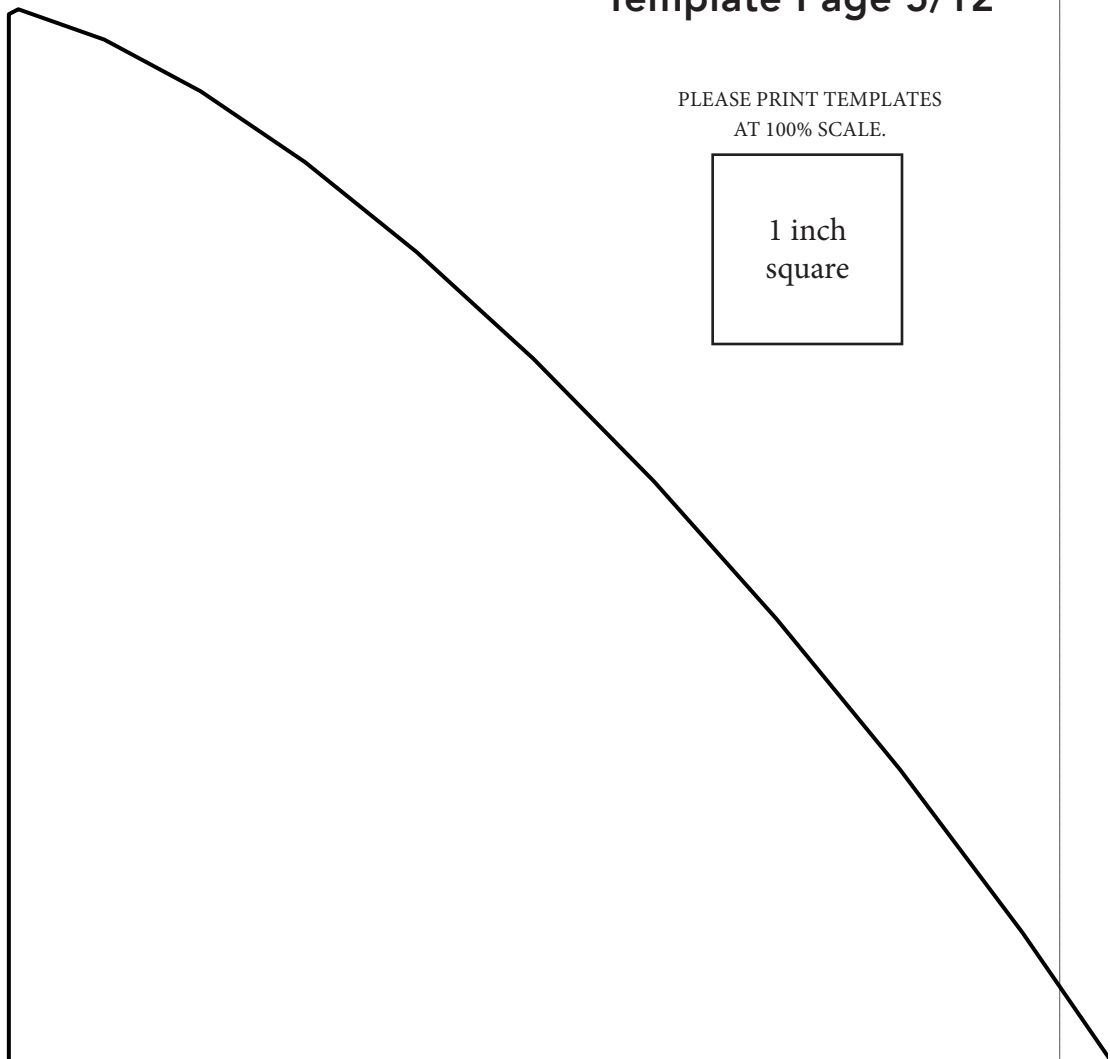
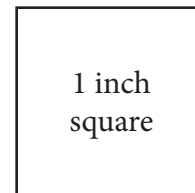

Whale Body Template Part 1 of 6



**Whale Sighting Templates
by Natalie Crabtree**

Template Page 6/12

PLEASE PRINT TEMPLATES
AT 100% SCALE.

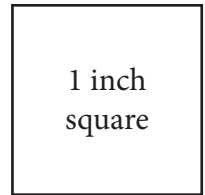

Water Drop
B

Whale Body
Template Part
2 of 6



Whale Sighting Templates by Natalie Crabtree

Template Page 7/12

PLEASE PRINT TEMPLATES
AT 100% SCALE.

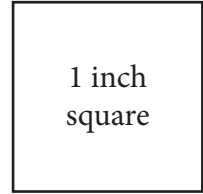

Whale Body Template Part 3 of 6



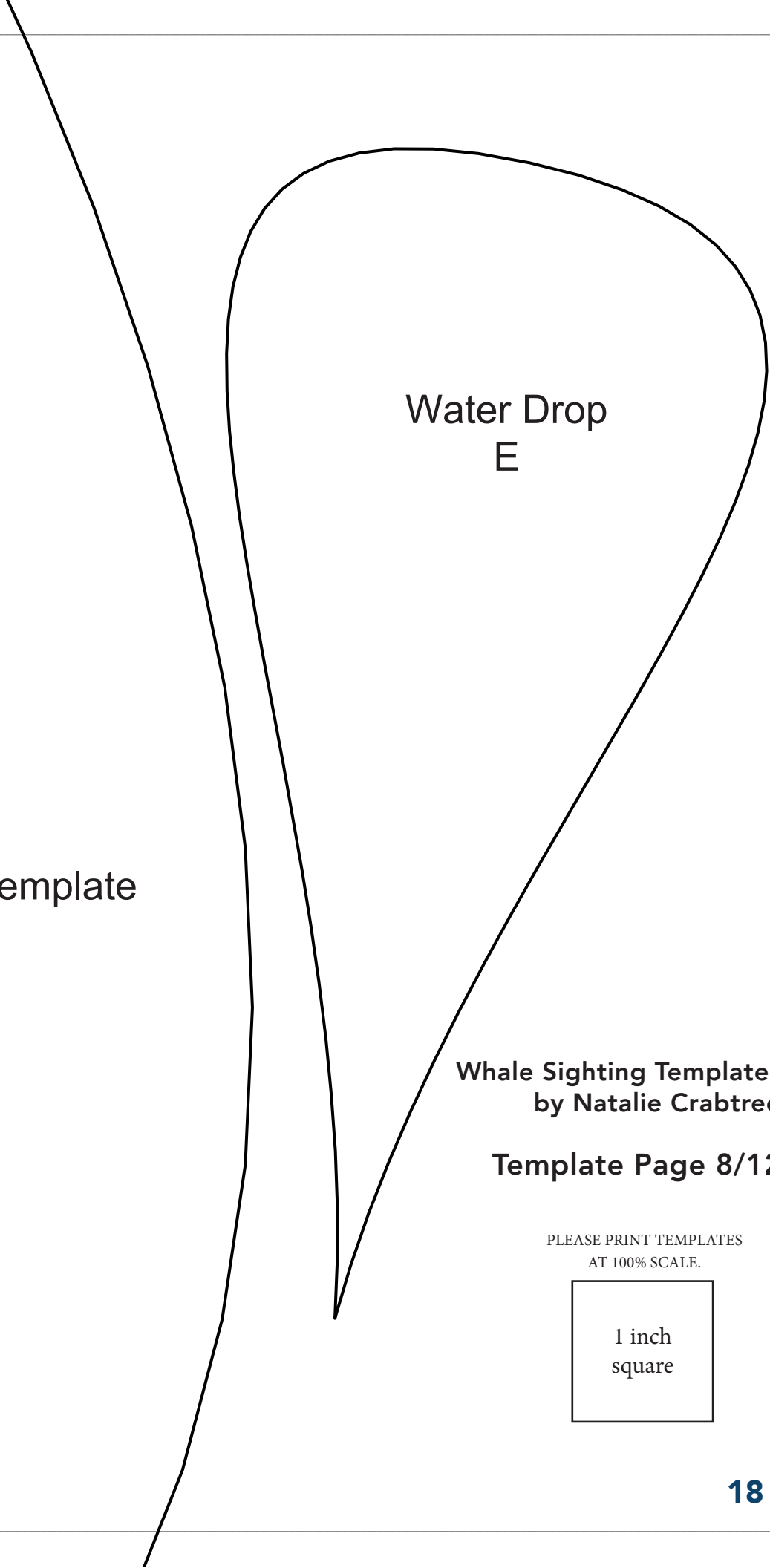

Water Drop
E

Whale Body Template
Part 4 of 6

Whale Sighting Templates
by Natalie Crabtree

Template Page 8/12

PLEASE PRINT TEMPLATES
AT 100% SCALE.

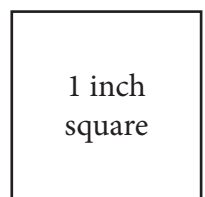

1 inch
square



Whale Body Template Part 5 of 6

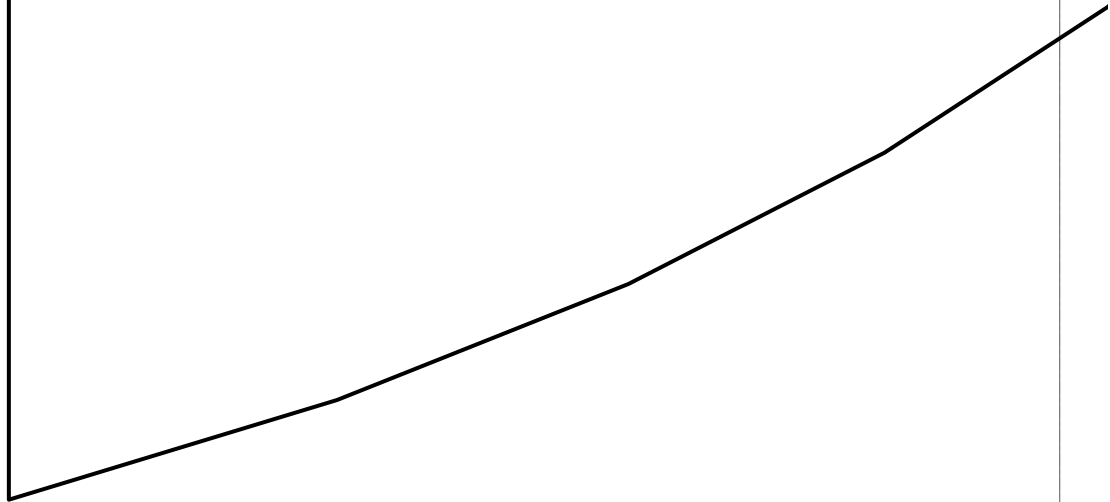

Whale Sighting Templates by Natalie Crabtree
Template Page 9/12

PLEASE PRINT TEMPLATES
AT 100% SCALE.

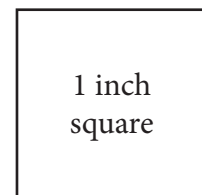

Whale Body
Template Part
6 of 6

Water Drop
A

Whale Sighting Templates
by Natalie Crabtree
Template Page 10/12

PLEASE PRINT TEMPLATES
AT 100% SCALE.

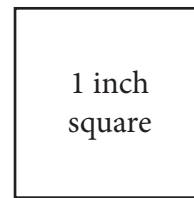

Water Drop
D



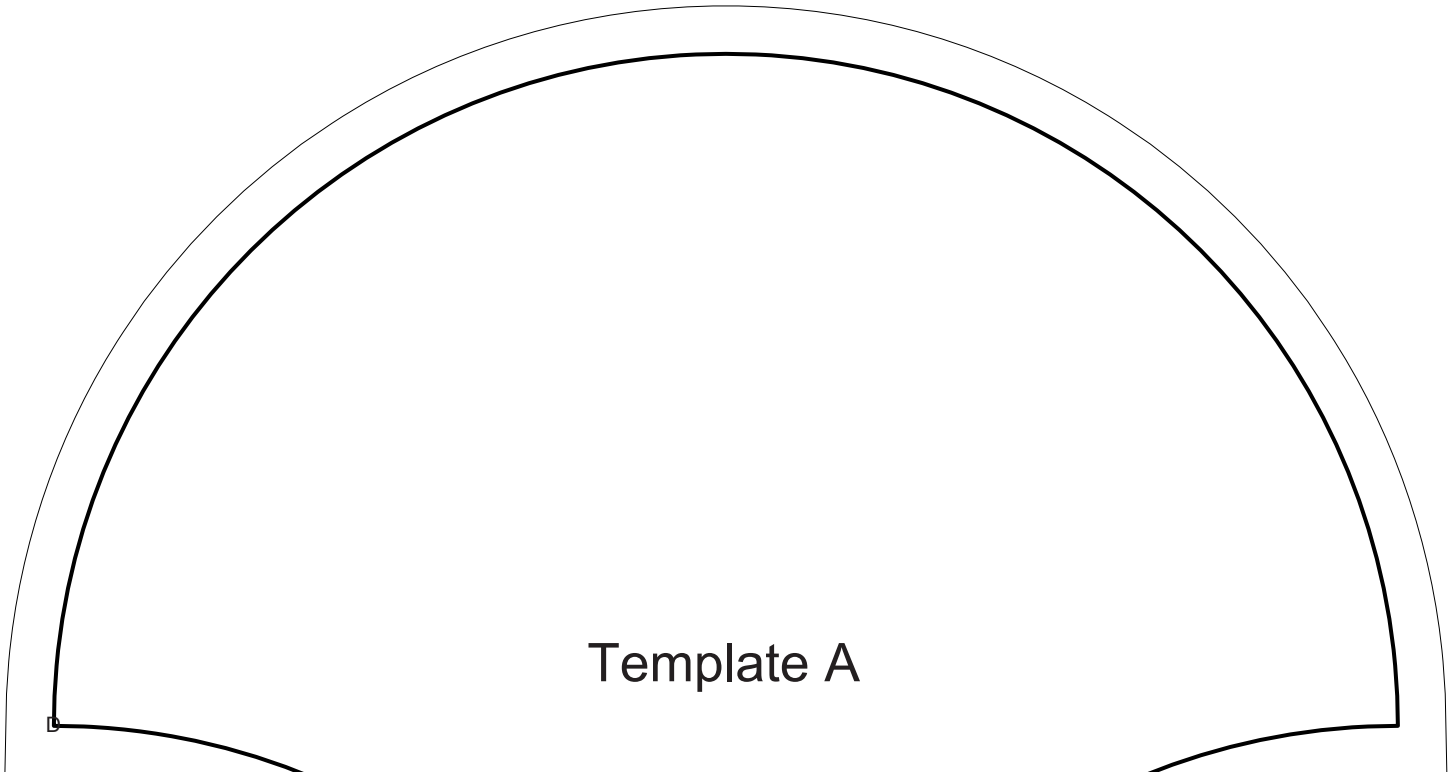

Template A

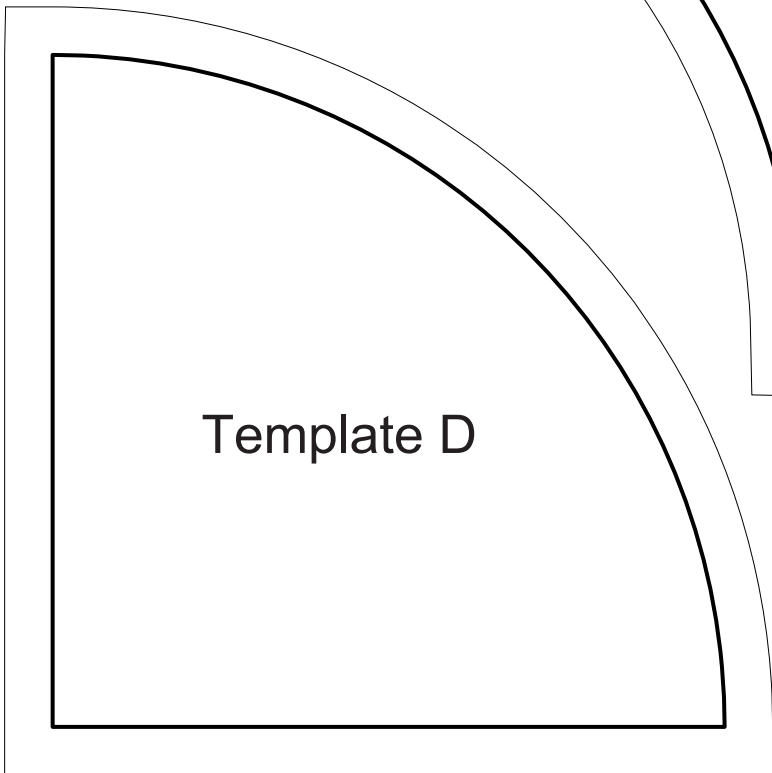

Template D

**Whale Sighting Templates
by Natalie Crabtree
Template Page 11/12**

PLEASE PRINT TEMPLATES
AT 100% SCALE.

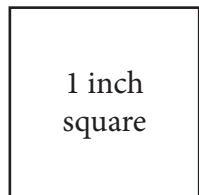

1 inch
square



Whale Sighting Templates by Natalie Crabtree

Template Page 12/12

PLEASE PRINT TEMPLATES
AT 100% SCALE.

