

Stormy Seas

designed by Natalie Crabtree

featuring the Whale Tales fabric collection by Katherine Quinn

SIZE: 65" x 69"

FREE
PROJECT









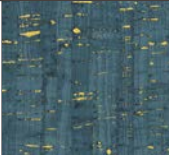
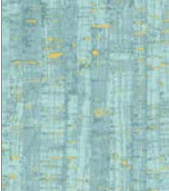

THIS IS A DIGITAL REPRESENTATION OF THE QUILT TOP, FABRIC MAY VARY.

PLEASE NOTE: BEFORE MAKING YOUR PROJECT, CHECK FOR ANY PATTERN UPDATES AT WINDHAMFABRICS.COM'S FREE PROJECTS SECTION.



Stormy Seas



Cutting Notes: Mark and store your pieces according to the sections they have been assigned to, as this will make it much easier when you start piecing. Be sure to read the entire pattern before you begin.

KEY	FABRIC	SKU	YD	CUTTING INSTRUCTIONS
A		50107M-15 Teal UNCORKED	1/2	(1) 12½" x WOF strip. Subcut: (4) Template #1. (4) Template #3.
B		50107M-16 Acid Wash UNCORKED	1¼	(8) 2¼" x WOF strips for binding. (2) 12½" x WOF strips. Subcut: (11) Template #1. (11) Template #3.
C		52099D-1 Ocean	½	(2) 8" x WOF strips. Subcut (5) Template #2.
D		52099D-2 Surf	½	(2) 8" x WOF strips. Subcut (4) Template #2.
E		52100D-3 Sea Green	½	(2) 8" x WOF strips. Subcut (4) Template #2.
F		52100D-4 Shell	½	(2) 8" x WOF strips. Subcut (4) Template #2.
G		52101D-2 Surf	½	(2) 8" x WOF strips. Subcut (6) Template #2.
H		52103D-4 Shell	7/8	(2) 12½" x WOF strips. Subcut: From first strip cut (4) Template #2 and (3) Template #3. From second strip cut (8) Template #1 and (3) Template #3. (1) 3" x WOF strip. Subcut (2) Template #3.
I		52103D-6 Seafoam	¾	(1) 8" x WOF strip. Subcut (2) Template #2.

Project Disclaimer: Every effort has been made to ensure that all projects are error free. All the information is presented in good faith, however, no warranty can be given nor results guaranteed. Therefore, we assume no responsibility nor damages that may occur when referring to this pattern. When errors are brought to our attention, we make every effort to correct and post a revision as soon as possible. We suggest you check windhamfabrics.com for pattern updates and to test the pattern prior to making the project. Test templates first, before cutting all the pieces. Free projects are not for resale.

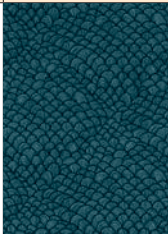
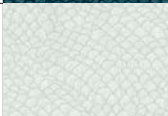

Stormy Seas

KEY	FABRIC	SKU	YD	CUTTING INSTRUCTIONS
J		52104D-1 Ocean	1 $\frac{5}{8}$	(2) 12 $\frac{1}{2}$ " x WOF strips. Subcut: (5) Template #2. (8) Template #1. (8) 3" x WOF strips for borders. (2) 3" x WOF strips. Subcut (8) Template #3.
K		52104D-2 Surf	$\frac{5}{8}$	(3) 3 $\frac{1}{2}$ " x WOF strips. Subcut (9) Template #1. (3) 3" x WOF strips. Subcut (9) Template #3.
L		52104D-8 Aqua	$\frac{1}{2}$	(2) 8" x WOF strips. Subcut (6) Template #2.
		Backing fabric	4	73" x 77" piece of batting

Additional Supplies: Plastic template

MAKING THE BLOCKS

Note: This block is shown in (9) colorways. Piecing instructions and diagrams are given for one block colorway. Repeat piecing instructions to create all block colorways.

1. Begin preparing for block assembly by folding all Template 1, 2 and 3 pieces in half as shown. Iron the fold to make a crease in the fabric, marking the exact centers of each template.

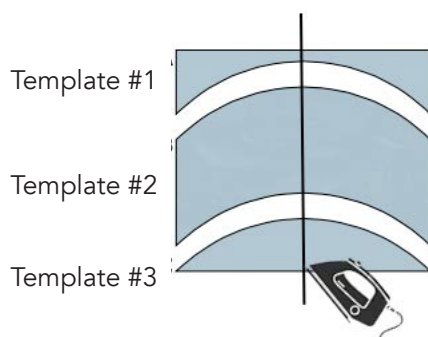

2. Gather (1) Template #1 and #3 cut from **Fabric K** and (1) Template #2 cut from **Fabric C**. Place templates in numerical order as shown, moving from top to bottom.

3. Place Template #1 right sides together with Template #2. Pin templates together at the creased center of the templates, and at the beginning and the ends of the templates. Align the beginning and ends of the templates perfectly when pinning. Template #1 will appear bunched up before sewing, but will become smooth once sewing begins.

4. Begin sewing templates together slowly using a $\frac{1}{4}$ " curved seam and a slightly smaller stitch length. Use your fingers to keep templates aligned and smooth the edges as you sew.



Stormy Seas

- 5. Once Templates #1 and #2 are sewn together, press outward toward Template #1.
- 6. Repeat pinning and sewing techniques described in steps 2-5 to attach Template #3 to the bottom of Template #2. Once complete, press seams outward toward Template #3.

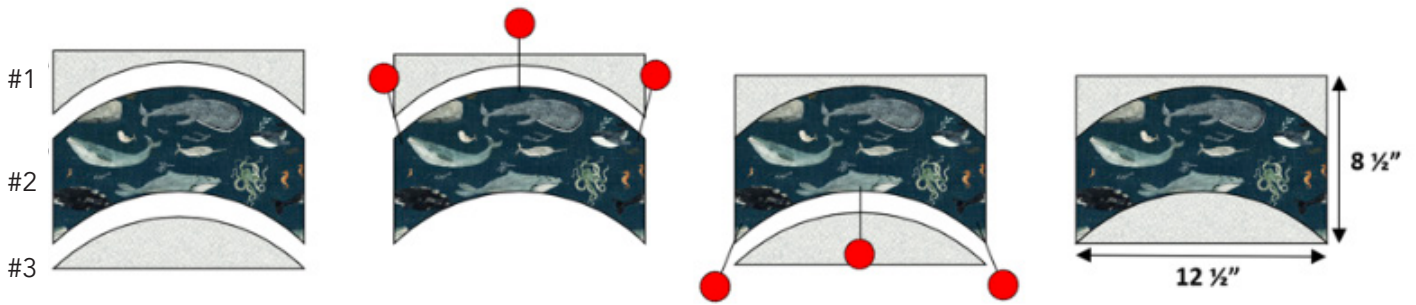

- 7. Completed block should measure 12½" x 8½" unfinished. Follow the color guide below and shown in the diagrams to create (40) blocks in (9) colorways.

Create (5) – Fabrics C and K



Create (4) – Fabrics A and E



Create (6) – Fabrics B and G

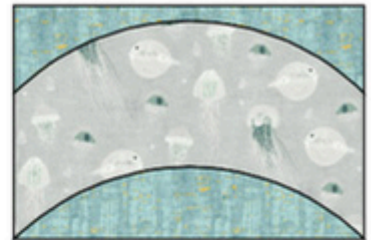

Create (5) – Fabrics B and J

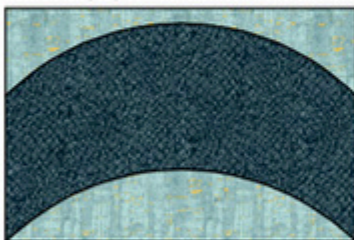

Create (4) – Fabrics H and J

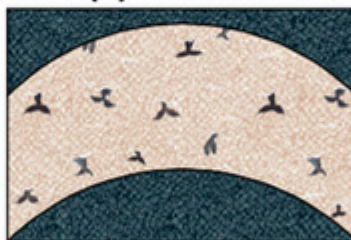

Create (6) – Fabrics H and L

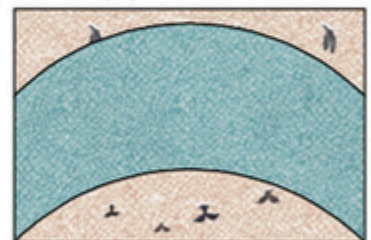

Create (2) – Fabrics H and I

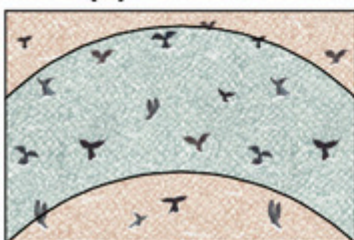

Create (4) – Fabrics F and J

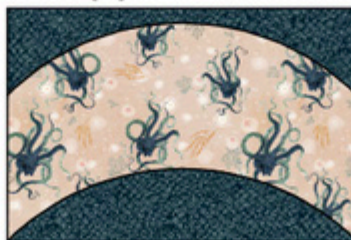

Create (4) – Fabrics D and K





Stormy Seas

QUILT ASSEMBLY

1. Lay out the blocks in a 5 x 8 grid as shown. Please note that blocks in the odd numbered rows are oriented differently than blocks in the even numbered rows. Sew together in horizontal rows first, alternating the direction in which you press the seams in each row.
2. Sew horizontal rows together to complete the quilt top center. Quilt top center should measure 60½" x 64½" unfinished.





Stormy Seas

3. Create borders for the quilt by sewing (2) **Fabric J** 3" x WOF strips together end to end using a diagonal seam. Trim seams to ¼" and press to one side. Repeat to create (4) long **Fabric J** strips.

4. Trim (2) **Fabric J** strips to measure 3" x 64½" for the side borders.

5. Trim (2) **Fabric J** strips to measure 3" x 65½" for the top/bottom borders.

6. Attach borders to the quilt top center, sewing the side borders on first, followed by the top/bottom borders. Press seams outward toward the borders to complete the quilt top.

FINISHING THE QUILT

7. Sandwich quilt with batting and backing. Baste layers together using your preferred method.

8. Quilt as desired.

9. Create binding using (8) **Fabric B** 2¼" x WOF strips. Sew strips end to end using a diagonal seam. Trim seams to ¼" and press open to reduce bulk.

10. Use an iron to press the long **Fabric B** strip in half widthwise, with wrong sides together, to create a long, thin strip.

11. Attach binding using your preferred method to complete the quilt.



Stormy Seas

Quilt Assembly Diagram





Stormy Seas

Template #2 part a

Templates are shown at 100%.
Print out and join a and b pieces on dotted lines for each template shape.





Stormy Seas

Template #1 part a

Template #3 part a

1 inch



Stormy Seas

