

MODIS Vegetation Index User's Guide (MOD13 Series)

Version 2.00, May 2010 (Collection 5)

Ramon Solano, Kamel Didan*, Andree Jacobson
and Alfredo Huete
(*didan@email.arizona.edu)

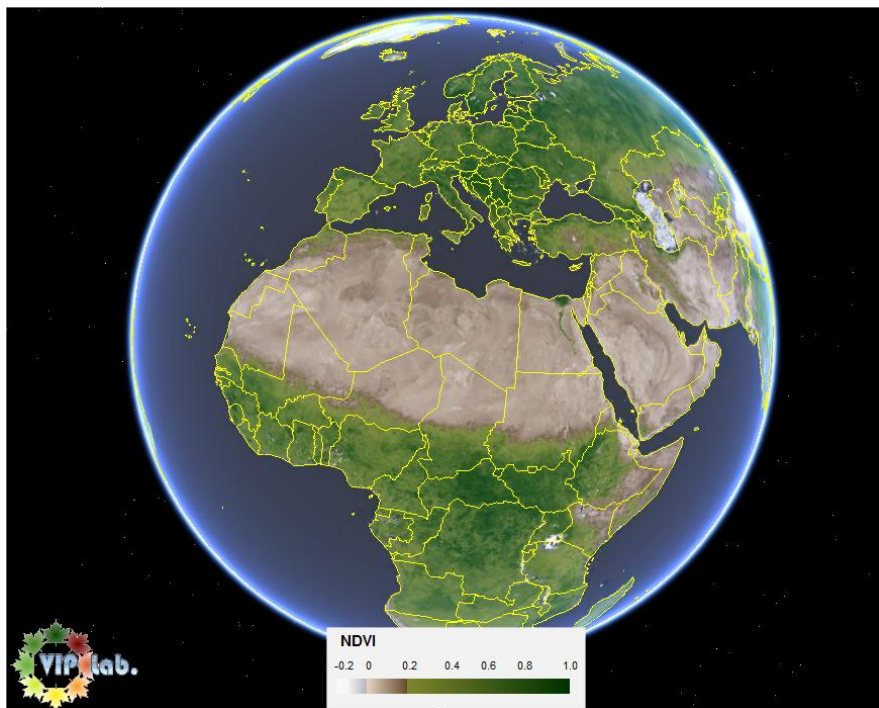

Vegetation Index and Phenology Lab

<http://vip.arizona.edu>

The University of Arizona

Contents

1	Introduction	1
1.1	The MODIS vegetation index (VI) products	1
1.2	Theoretical Description of Vegetation Indices	2
1.2.1	Theoretical basis of the NDVI	2
1.2.2	Theoretical basis of the EVI	3
1.2.3	EVI backup algorithm	3
2	What is new in Collection 5	4
3	File Format of the MODIS VI Products	5
4	MODIS VI Product Sequence	6
5	MOD13Q1/MOD13A1 (16-day 250/500-m) VI	6
5.1	Algorithm Description	7
5.2	Scientific Data Sets	9
5.3	Product Specific Metadata	10
5.4	Global and Local Metadata Attributes	10
5.5	Quality Assurance	10
5.5.1	QA Metadata	11
5.5.2	QA Science Data Sets	15
6	MOD13A2 (16-day 1-km) VI	18
6.1	Algorithm Description	18
6.2	Scientific Data Sets	19
6.3	Product Specific Metadata	19
6.4	Global and Local Metadata Attributes	19
6.5	Quality Assurance	20
6.5.1	QA Metadata	20
6.5.2	QA Science Data Sets	21
7	MOD13A3 (monthly 1-km) VI	21
7.1	Algorithm Description	21
7.2	Scientific Data Sets	22
7.3	Product Specific Metadata	23
7.4	Global and Local Metadata Attributes	23
7.5	Quality Assurance	23
7.5.1	QA Metadata	24
7.5.2	QA Science Data Sets	24
8	MOD13C1 CMG (16-day 0.05-deg) VI	24
8.1	Algorithm Description	24

8.2	Scientific Data Sets	25
8.3	Quality Assurance	26
8.3.1	QA Metadata	27
8.3.2	QA Science Data Sets	27
9	MOD13C2 CMG (monthly 0.05-deg) VI	28
9.1	Algorithm Description	28
9.2	Scientific Data Sets	29
9.3	Quality Assurance	29
9.3.1	QA Metadata	29
9.3.2	QA Science Data Sets	30
10	Related Web Sites	30
11	FAQ	31
12	Sample images	32

List of Figures

1	Overview of MODIS VI product series.	7
2	250/500-m MODIS VI production flow diagram.	8
3	MODIS VI Compositing algorithm data flow.	9
4	Monthly MODIS VI flow diagram.	22
5	MOD13 CMG Processing flow.	25
6	MOD13C product series filling strategy.	26
7	MODIS VI Color Palettes	32
8	MOD13Q1 NDVI and EVI sample images	33
9	MOD13A1 NDVI and EVI sample images	33
10	MOD13A2 NDVI and EVI sample images	34
11	MOD13A3 NDVI and EVI sample images	34
12	MOD13C1 NDVI and EVI sample images	35
13	MOD13C2 NDVI and EVI sample images	36
14	Comparative of MOD13Q1 and MOD13A1 spatial resolution	37
15	Comparative of MOD13A2 and MOD13C1 spatial resolution	38

List of Tables

1	Product MOD13A1: 16-day 250/500-m VI.	10
2	Metadata fields for QA evaluation of MOD13 Q1/A1.	11
3	List of the QA Metadata Objects for the MOD13 Q1/A1 products	13
4	MOD13Q1/A1 Pixel Reliability.	15
5	Descriptions of the VI Quality Assessment Science Data Sets (QA SDS)	16

6	Relationship between the MODLAND QA Bits and QA Metadata Objects . . .	17
7	VI Usefulness Index Scaling Method for the MOD13 Q1/A1 products. . . .	18
8	Product MOD13A2: 16-day 1-km VI.	19
9	Metadata fields for QA evaluation of MOD13A2.	20
10	Correspondence between MOD13A2 and MOD13A1 PSA QA Metadata . . .	20
11	VI Usefulness Index Scaling Method for the MOD13A2 Product.	21
12	Product MOD13A3: monthly 1-km VI.	22
13	Metadata fields for QA evaluation of MOD13A3.	23
14	Correspondence between MOD13A3 and MOD13A1 PSA QA Metadata . . .	24
15	List of SDS's from 16-day 0.05-deg MOD13C1 VI.	26
16	Metadata fields for QA evaluation of MOD13C1 and MOD13C2 products. . .	27
17	Bits 14-15 of the MOD13C1 VI Quality Assessment SDS.	28
18	MOD13C1 Pixel Reliability.	28
19	List of SDS's from monthly 0.05-deg MOD13C2 VI.	29

1 Introduction

One of the primary interests of the Earth Observing System (EOS) program is to study the role of terrestrial vegetation in large-scale global processes with the goal of understanding how the Earth functions as a system. This requires an understanding of the global distribution of vegetation types as well as their biophysical and structural properties and spatial/temporal variations. Vegetation Indices (VI) are robust, empirical measures of vegetation activity at the land surface. They are designed to enhance the vegetation reflected signal from measured spectral responses by combining two (or more) wavebands, often in the red (0.6 - 0.7 μm) and NIR wavelengths (0.7-1.1 μm) regions.

1.1 The MODIS vegetation index (VI) products

The MODIS VI products (MOD13) provide consistent, spatial and temporal comparisons of global vegetation conditions which can be used to monitor the Earth's terrestrial photosynthetic vegetation activity in support of phenologic, change detection, and biophysical interpretations. Gridded vegetation index maps depicting spatial and temporal variations in vegetation activity are derived at 16-day and monthly intervals for precise seasonal and inter-annual monitoring of the Earth's terrestrial vegetation.

Two VI products are made globally for land regions. The first product is the standard Normalized Difference Vegetation Index (NDVI), which is referred to as the *continuity index* to the existing NOAA-AVHRR derived NDVI. There is a +27-year NDVI global data set (1981 - 2009) from the NOAA-AVHRR series, which could be extended by MODIS data to provide a long term data record for use in operational monitoring studies. The second VI product is the Enhanced Vegetation Index (EVI), with improved sensitivity over high biomass regions and improved vegetation monitoring capability through a de-coupling of the canopy background signal and a reduction in atmosphere influences. The two VIs complement each other in global vegetation studies and improve upon the extraction of canopy biophysical parameters. A new compositing scheme that reduces angular, sun-target-sensor variations is also utilized. The gridded VI maps use MODIS surface reflectances corrected for molecular scattering, ozone absorption, and aerosols, as input to the VI equations. The gridded vegetation indices include quality assurance (QA) flags with statistical data that indicate the quality of the VI product and input data.

The MODIS VI products are currently produced at 250 m, 500 m, 1 km and 0.05 deg spatial resolutions. For production purposes, MODIS VIs are produced in *tile* units that are approximately 1200-by-1200 km, and mapped in the Sinusoidal (SIN) grid projection. Only tiles containing land features are processed, with the aim to reduce processing and disk space requirements. When mosaicked, all tiles cover the terrestrial Earth and the global MODIS-VI can thus be generated each 16 days and each calendar month.

1.2 Theoretical Description of Vegetation Indices

The theoretical basis for empirical-based vegetation indices is derived from examination of typical spectral reflectance signatures of leaves. The reflected energy in the visible is very low as a result of high absorption by photosynthetically active pigments, with maximum absorption values in the blue (470 nm) and red (670 nm) wavelengths. Nearly all of the near-infrared radiation (NIR) is scattered (reflected and transmitted) with very little absorption, in a manner dependent upon the structural properties of a canopy (LAI, leaf angle distribution, leaf morphology). As a result, the contrast between red and near-infrared responses is a sensitive measure of vegetation amount, with maximum red–NIR differences occurring over a full canopy and minimal contrast over targets with little or no vegetation. For low and medium amounts of vegetation, the contrast is a result of both red and NIR changes, while at higher amounts of vegetation, only the NIR contributes to increasing contrasts as the red band becomes saturated due to chlorophyll absorption.

The red-NIR contrast can be quantified through the use of ratios (NIR/red), differences (NIR–red), weighted differences (NIR– k ·red), linear band combinations (x_1 ·red+ x_2 ·NIR), or hybrid approaches of the above. Vegetation indexes are measures of this contrast and thus are integrative functions of canopy structural (%cover, LAI, LAD) and physiological (pigments, photosynthesis) parameters.

1.2.1 Theoretical basis of the NDVI

The NDVI is a *normalized* transform of the NIR to red reflectance ratio, $\rho_{\text{NIR}}/\rho_{\text{red}}$, designed to standardize VI values to between -1 and $+1$. It is commonly expressed as:

$$\text{NDVI} = \frac{\rho_{\text{NIR}} - \rho_{\text{red}}}{\rho_{\text{NIR}} + \rho_{\text{red}}} \quad (1)$$

As a ratio, the NDVI has the advantage of minimizing certain types of band-correlated noise (positively-correlated) and influences attributed to variations in direct/diffuse irradiance, clouds and cloud shadows, sun and view angles, topography, and atmospheric attenuation. Ratioing can also reduce, to a certain extent, calibration and instrument-related errors. The extent to which ratioing can reduce noise is dependent upon the correlation of noise between red and NIR responses and the degree to which the surface exhibits Lambertian behavior.

The main disadvantage of ratio-based indices tend to be their non-linearities exhibiting asymptotic behaviors, which lead to insensitivities to vegetation variations over certain land cover conditions. Ratios also fail to account for the spectral dependencies of additive atmospheric (path radiance) effects, canopy-background interactions, and canopy bidirectional reflectance anisotropies, particularly those associated with canopy shadowing.

1.2.2 Theoretical basis of the EVI

A major finding on atmospheric effect minimization is the use of the difference in blue and red reflectances as an estimator of the atmosphere influence level. This concept is based on the wavelength dependency of aerosol scattering cross sections. In general the scattering cross section in the blue band is larger than that in the red band. When the aerosol concentration is higher, the difference in the two bands becomes larger. This information is used to stabilize the index value against variations in aerosol concentration levels.

The EVI incorporates this atmospheric resistance concept as in the Atmospheric Resistant Index (ARVI), along with the removal of soil-brightness induced variations in VI as in the Soil Adjusted Vegetation Index (SAVI). The EVI additionally decouples the soil and atmospheric influences from the vegetation signal by including a feedback term for simultaneous correction. The EVI formula is written as:

$$\text{EVI} = G \cdot \frac{\rho_{\text{NIR}} - \rho_{\text{red}}}{\rho_{\text{NIR}} + C_1 \cdot \rho_{\text{red}} - C_2 \cdot \rho_{\text{blue}} + L} \quad (2)$$

where ρ_x are the full or partially atmospheric-corrected (for Rayleigh scattering and ozone absorption) surface reflectances; L is the canopy background adjustment for correcting nonlinear, differential NIR and red radiant transfer through a canopy; C_1 and C_2 are the coefficients of the aerosol resistance term (which uses the blue band to correct for aerosol influences in the red band); and G is a gain or scaling factor. The coefficients adopted in the EVI algorithm are, $L=1$, $C_1=6$, $C_2=7.5$, and $G=2.5$.

1.2.3 EVI backup algorithm

The EVI is replaced by a modified 2-band EVI (which does not use the blue band) over high-reflectance surfaces such as clouds and snow/ice. This backup method is used to avoid an atmospheric over-correction condition by EVI, caused by a high blue band reflectance over those surfaces. This situation may be exacerbated by an imperfect atmospheric correction procedure, which would promote further anomalous EVI values. Because the 2-band EVI lacks the blue band, it becomes insensitive to these effects, while maintaining the other advantages of the EVI.

The 2-band EVI equation used for the MODIS VI products is:

$$\text{2-band EVI} = 2.5 \cdot \frac{\rho_{\text{NIR}} - \rho_{\text{red}}}{\rho_{\text{NIR}} + \rho_{\text{red}} + 1} \quad (3)$$

Prior to Collection 5, the SAVI algorithm was used as the EVI backup algorithm for the MODIS VI Products.

Please refer to the “MODIS Vegetation Index (MOD 13) Algorithm Theoretical Basis” document (http://modis.gsfc.nasa.gov/data/atbd/atbd_mod13.pdf) for an in-depth review of the MODIS VI scientific basis.

2 What is new in Collection 5

A number of improvements have been applied to the previous Collection 4 (C4) MODIS VI products. Updates are listed under the following main categories:

1. Science changes
2. Structural changes
3. Processing rules
4. Metadata changes
5. New VI products

The most important improvements to the VI products are the new quality-based filtering scheme and a modified compositing method to deal with residual and mislabeled clouds. These changes have positively impacted all the VI products, with improved identification of the least cloudy observation from the daily inputs.

In order to benefit from the presence of two identical data streams (Terra and Aqua) we modified certain production rules. Terra and Aqua data streams are processed 8 days out of phase to provide a quasi-8-day temporal frequency, thus improving the change detection capabilities of the products.

Two new output parameters were also added to the MODIS VI products, the `Composite day of the year` and `Pixel reliability`.

Additionally, two new VI products were introduced as the VI Climate Modeling Grid (CMG) series: MOD13C1 and MOD13C2. These are generated at 0.05deg spatial resolution, aggregated as 16-day and monthly composites, respectively. The VI CMG series is a seamless global 3600x7200 pixel data product.

Major changes are outlined as follows:

- Improved processing of aerosol- and cloud-contaminated pixels.
- Implemented internal data-compression to reduce file size.
- Fusion and restructuring of NDVI QA and EVI QA into a single VI QA layer.
- Added `Composite day of the year` and `Pixel reliability` output parameters.

- Improvement of the Constrained View angle - Maximum Value Composite (CV-MVC) compositing method.
 - The Maximum Value Composite (MVC) is used when all input days are cloudy.
 - The CV-MVC approach was modified to favor smaller composite view angles.
- Update of the EVI backup algorithm from SAVI to a 2-band EVI.
- Adopted a threshold technique to identify anomalous surface reflectances. over inland water bodies in order to suspend the VI computation. *This technique was later dropped from the algorithm. The information is left in this document to alert the user community of this special issue.*
- Adopted an out-of-phase production approach for Terra and Aqua data streams: both products are kept as two independent 16-day composites, with starting dates separated by 8 day. This scheme increases the temporal frequency of the overall Terra-Aqua VI product.

Full details of introduced changes are described in the document “MOD13 VI C5 Changes Document” (http://landweb.nascom.nasa.gov/QA_WWW/forPage/MOD13_VI_C5_Changes_Document_06_28_06.pdf)

3 File Format of the MODIS VI Products

The MODIS production and science team chose the Hierarchical Data Format-Earth Observing System (HDF-EOS) format, which is the standard archive format for EOS Data Information System (EOSDIS) products. Each MODIS-VI file contains two separate structures:

1. Scientific data sets (SDS) which are the actual data stored in array format (2-D, 3-D and even 4-D).
2. Three sets of metadata:
 - structural metadata that describes the actual content of the file,
 - core metadata that describes the projection and grid name,
 - archive metadata that describes various aspects of the file in terms of dates, times, statistics about quality, useful to archive and search the product.

All MODIS VI products are in a grid structure, which are defined as projected, fixed-area size files. This was done for geolocation purposes and to facilitate the correlation between the data and its actual location on Earth. Other formats used to store MODIS data are the point structure and the swath structure. The use of metadata is meant to enhance the self-describing characteristics of HDF files and is useful to the end user, facilitating the

archiving and searching of files. Parameter Value Language (PVL) is used to write the various metadata to the product file as:

```
PARAMETER = VALUE
```

There are two types of metadata attributes: 1) global attributes which are general to all MODIS products and 2) product specific attributes (PSA). From a practical perspective, metadata will provide the user with general information about the file contents, its characteristics and quality (through the QA PSA), which is used to decide if the file is useful. The scientific data sets (SDS) could then be used for further analyses and use of the product.

4 MODIS VI Product Sequence

There are 6 products in the MODIS VI sequence¹:

1. MOD13Q1: 16-day 250-m VI
2. MOD13A1: 16-day 500-m VI
3. MOD13A2: 16-day 1-km VI
4. MOD13A3: monthly 1-km VI
5. MOD13C1: 16-day 0.05-deg VI
6. MOD13C2: monthly 0.05-deg VI

All MODIS VI products rely on the upstream surface reflectance (MOD09 series) product, which is a daily level (L2) product. The VI algorithms ingest the level 2G surface reflectances and temporally composite these to generate the VI products. The 1-km VI product (MOD13A2), however, must first aggregate 250- and 500-m MODIS pixel sizes to 1 km by way of the MODAGG algorithm. The CMG products, MOD13C1 and MOD13C2, are generated through spatial averaging of the 1-km versions, MOD13A2 and MOD13A3. Both monthly products, MOD13A3 and MOD13C2, are temporal averages of their 16-day versions (Fig. 1).

5 MOD13Q1/MOD13A1 (16-day 250/500-m) VI

This product is generated using the daily MODIS Level-2G (L2G) surface reflectance, pointer file, geo-angle file and 1-km state file (Fig. 2). Examples of the MOD13Q1 MODIS

¹ Even though we make reference in this document to MODIS VI product as “MOD13” for simplicity, it is implicit that we mean the full MODIS VI product series from both MODIS sensors onboard Terra and Aqua platforms (i.e. MOD13 and MYD13 respectively)

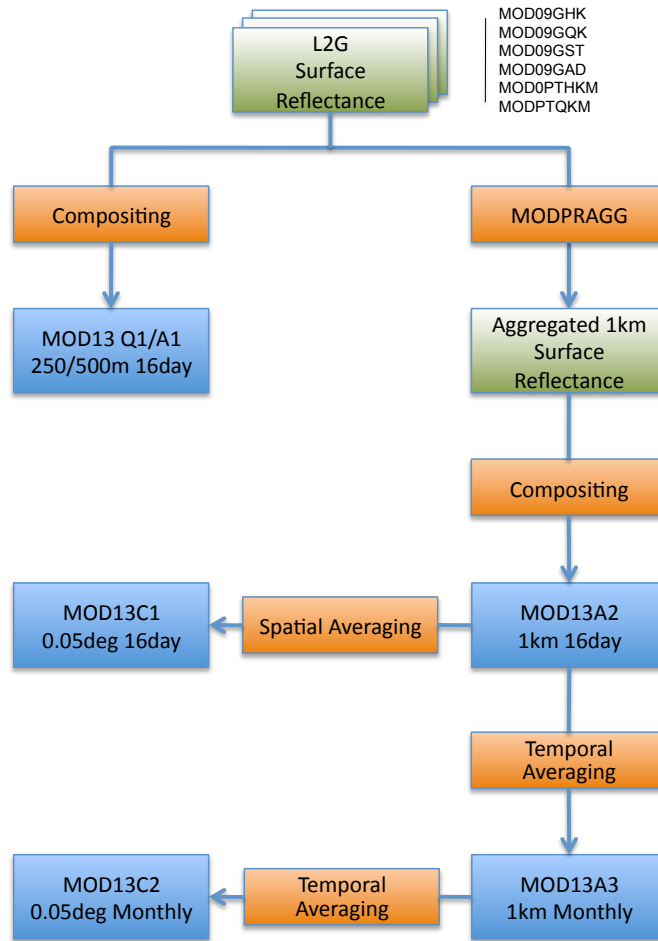

Figure 1: Overview of MODIS VI product series.

products for the Southwest USA are included at the end of this document (Fig. 8).

5.1 Algorithm Description

The VI algorithm operates on a per-pixel basis and requires multiple observations (days) to generate a composited VI. Due to orbit overlap, multiple observations may exist for one day and a maximum of four observations may be collected. In theory, this can result in a maximum of 64 observations over a 16-day cycle, however, due to the presence of clouds and the actual sensor spatial coverage, this number will range between 64 and 0 with decreasing observations from polar to equatorial latitudes. The MOD13A1 algorithm separates all observations by their orbits providing a means to further filter the input data.

Once all 16 days are collected, the MODIS VI algorithm applies a filter to the data based on quality, cloud, and viewing geometry (Fig. 3). Cloud-contaminated pixels and extreme off-nadir sensor views are considered lower quality. A cloud-free, nadir view pixel with no residual atmospheric contamination represents the best quality pixel. Only the higher qual-

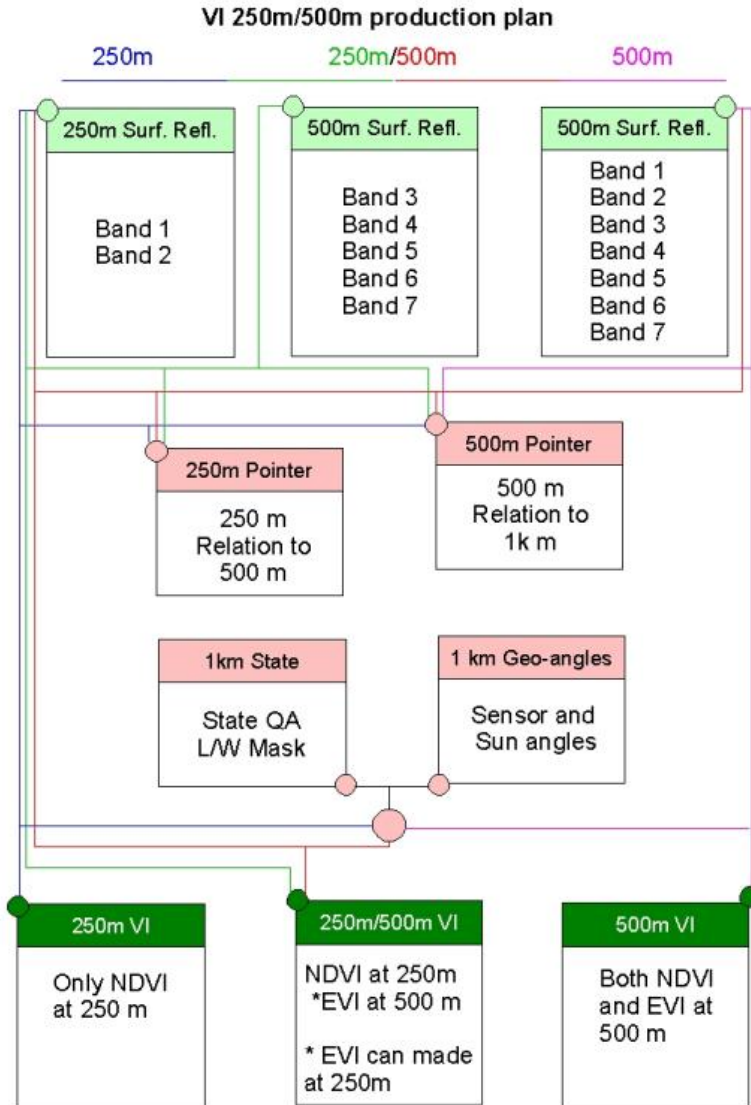

Figure 2: 250/500-m MODIS VI production flow diagram.

ity, cloud-free, filtered data are retained for compositing. Thus, the number of acceptable pixels over a 16-day compositing period is typically less than 10 and often varies between 1 and 5, especially when one considers a mean global cloud cover of 50-60%. The goal of the compositing methodology is to extract a single value per pixel from all the retained filtered data, which is representative of each pixel over the particular 16-day period. The VI compositing technique uses an enhanced criteria for normal-to-ideal observations, but switches to an optional backup method when conditions are less than ideal. These techniques are:

1. Main: Constrained View angle - Maximum Value Composite (CV-MVC)
2. Backup: Maximum Value Composite (MVC)

The technique employed depends on the number and quality of observations. The MVC

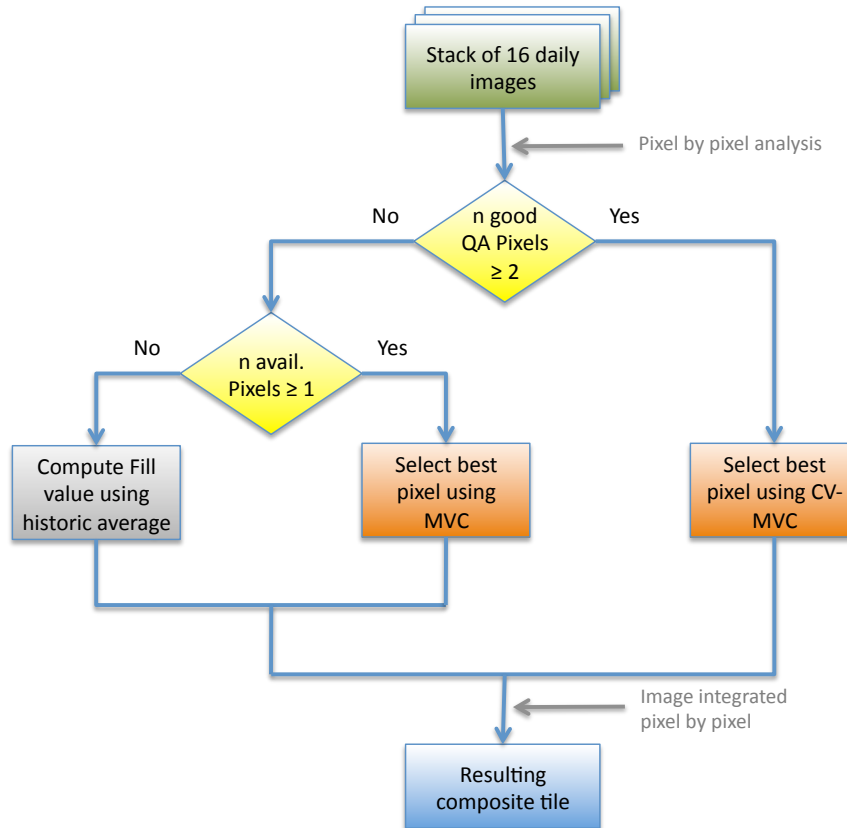

Figure 3: MODIS VI Compositing algorithm data flow.

is similar to that used in the AVHRR-NDVI product, in which the pixel observation with the highest NDVI value is selected to represent the entire period (16 days). Furthermore, the algorithm will choose the orbit observation with the highest NDVI if presented with multiple observations for the same day (multiple orbits).

The CV-MVC is an enhanced MVC technique, in which the number of observations n (n being set to 2 at the moment) with the highest NDVI are compared and the observation with the smallest view angle, i.e. closest to nadir view, is chosen to represent the 16-day composite cycle.

All compositing methodologies result in spatial discontinuities, which are inevitable and result from the fact that disparate days can always be chosen for adjacent pixels over the 16-day period. Thus, adjacent *selected* pixels may originate from different days, with different sun-pixel-sensor viewing geometries and different atmospheric and residual cloud/smoke contamination.

5.2 Scientific Data Sets

The 250m/500-m VI product has the following characteristics (Table 1).

Table 1: Product MOD13A1: 16-day 250/500-m VI.

Science Data Set	Units	Data type	Valid Range	Scale factor
XYZm 16 days NDVI	NDVI	int16	-2000, 10000	0.0001
XYZm 16 days EVI	EVI	int16	-2000, 10000	0.0001
XYZm 16 days VI Quality detailed QA	Bits	uint16	0, 65534	NA
XYZm 16 days red reflectance (Band 1)	Reflectance	int16	0, 10000	0.0001
XYZm 16 days NIR reflectance (Band 2)	Reflectance	int16	0, 10000	0.0001
XYZm 16 days blue reflectance (Band 3)	Reflectance	int16	0, 10000	0.0001
XYZm 16 days MIR reflectance (Band 7)	Reflectance	int16	0, 10000	0.0001
XYZm 16 days view zenith angle	Degree	int16	-9000, 9000	0.01
XYZm 16 days sun zenith angle	Degree	int16	-9000, 9000	0.01
XYZm 16 days relative azimuth angle	Degree	int16	-3600, 3600	0.1
XYZm 16 days composite day of the year	Day of year	int16	1, 366	NA
XYZm 16 days pixel reliability summary QA	Rank	int8	0, 3	NA

XYZ means either 250 or 500 for MOD13Q1 and MOD13A1 products respectively.

5.3 Product Specific Metadata

A listing of the metadata fields used for QA evaluations of the MOD13 Q1/A1 VI product is included in Table 2.

5.4 Global and Local Metadata Attributes

As in all MODIS products, the global metadata is written to the output file during the generation process and could be used for searching the archive about the product.

5.5 Quality Assurance

The quality of the MOD13A1 product is indicated and assessed through the quality assessment (QA) metadata objects and QA science data sets (SDS's). The QA metadata objects summarize tile-level (granule) quality with several single words and numeric numbers, and thus are useful for data ordering and screening processes. The QA SDS's, on the other hand, document product quality on a pixel-by-pixel basis and thus are useful for data analyses and application uses of the data.

Table 2: Metadata fields for QA evaluation of MOD13 Q1/A1.

I. Inventory Metadata fields for all VI products (searchable)	
	QAPERCENTINTERPOLATEDDATA
	QAPERCENTMISSINGDATA
	QAPERCENTOUTOFBOUNDSDATA
	QAPERCENTCLOUDCOVER
	QAPERCENTGOODQUALITY
	QAPERCENTOTHERQUALITY
	QAPERCENTNOTPRODUCEDCLOUD
	QAPERCENTNOTPRODUCEDOTHER
II. Product specific metadata (searchable)	
Product	Specific Metadata variable name (Best Quality)
MOD13Q1	NDVI250M16DAYQCLASSPERCENTAGE
MOD13Q1	EVI250M16DAYQCLASSPERCENTAGE
MOD13A1	NDVI500M16DAYQCLASSPERCENTAGE
MOD13A1	EVI500M16DAYQCLASSPERCENTAGE
III. Archived Metadata (not searchable)	
Product	Metadata variable name (Array of QA usefulness histogram)
MOD13Q1	QAPERCENTPOORQ250M16DAYNDVI
MOD13Q1	QAPERCENTPOORQ250M16DAYEVI
MOD13A1	QAPERCENTPOORQ500M16DAYNDVI
MOD13A1	QAPERCENTPOORQ500M16DAYEVI

5.5.1 QA Metadata

There are 18 QA metadata objects in the MOD13 Q1/A1 product. These objects (Table 3) are characterized by the following five attributes:

1. *Object name*: Uniquely identifies and describes the content of each object.
2. *Object type*: Describes the object as either an ECS mandatory, MODLAND mandatory, or VI product specific metadata object, and also as either text or numeric.
3. *Description*: Briefly describes the object, its valid value or format, and its sample value(s).
4. *Level*: Describes whether the object value is given for each SDS or not.

The ECS QA metadata are mandatory to all of the EOS products (the first 10 objects in Table 3), all of which are given for each SDS of the MOD13 Q1/A1 product. The first 6 objects are called QAFlags, including AutomaticQualityFlag, OperationalQualityFlag, ScienceQualityFlag, and their explanations. The AutomaticQualityFlag object indicates a result of an automatic QA performed during product generation and the following criteria

are used to set its value:

1. Set to 'Passed' if $QAPercentMissingData \leq 5\%$
2. Set to 'Suspect' if $QAPercentMissingData > 5\%$ or $< 50\%$
3. Set to 'Failed' if $QAPercentMissingData > 50\%$

where the 'QAPercentMissingData' is also an ECS QA metadata object and is described below. Explanation of the result of the AutomaticQualityFlag is given in the AutomaticQualityFlagExplanation metadata object.

The OperationalQualityFlag indicates the results of manual, non-science QA performed by processing facility personnel (DAAC or PI), i.e., if data are not corrupted in the transfer, archival, and retrieval processes. The flag has the value of 'Not Being Investigated' if no non-science QA is performed. If the flag has the value other than 'Passed' or 'Not Being Investigated', explanation is given in the OperationalQualityFlagExplanation object.

The ScienceQualityFlag indicates the results of manual, science-QA performed by personnel at the VI Science Computing Facility (SCF). As for the OperationalQualityFlag, the flag has the value of 'Not Being Investigated' if science QA is not performed. Explanation is given in the ScienceQualityFlagExplanation object if the flag has the value other than 'Passed' or 'Not Being Investigated'.

The last 4 ECS QA metadata objects are called 'QAStats'. The QAStats indicate the percentages of pixels in the tile of which values are either interpolated (QAPercentInterpolatedData), missing (QAPercentMissingData), out of a valid range (QAPercentOutOfBoundData), or contaminated by cloud cover (QAPercentCloudCover).

There are 4 MODLAND mandatory QA metadata objects, all of which are designed to complement the ECS QA metadata objects. These indicate the percentages of pixels in the tile that are either good quality (QAPercentGoodQuality), unreliable quality (QAPercentOtherQuality), covered by cloud (QAPercentNotProducedCloud), or not produced due to bad quality other than cloud cover (QAPercentNotProducedOther). Different from the ECS QA metadata, only one set of values are given per tile.

The last 4 QA metadata objects in Table 3 are designed specifically for the MODIS VI product(s) (Product Specific Attributes, PSAs). Both NDVI500M16DAYQCLASSPERCENTAGE and EVI500M16DAYQCLASSPERCENTAGE objects indicate the percentages of pixels with good quality in the tile and, thus, should be equal to the QAPercentGoodQuality value unless there is a significant difference between the NDVI and EVI performance for the same tile.

The QAPERCENTPOORQ500M16DAYNDVI and QAPERCENTPOORQ500M16DAY-NDVI indicate, respectively, the percent frequency distributions of the NDVI and EVI quality. Their values are computed as sums of the NDVI and EVI usefulness indices (described in the QA Science Data Set section) and, thus, include 16 integer numbers. The 16 num-

bers are ordered in the descending qualities from left to right and a sum of 16 numbers is always equal to 100. The first numbers in the QAPERCENTPOORQ500M16DAYNDVI and QAPERCENTPOORQ500M16DAYNDVI objects are equal to the values given in the NDVI500M16DAYQCLASSPERCENTAGE and EVI500M16DAYQCLASSPERCENTAGE objects, respectively.

Table 3: List of the QA Metadata Objects for the MOD13 Q1/A1 products (XYZ refers to either 250 or 500 m).

Object Name	Object Type	Description	Level
AutomaticQuality Flag	ECS Mandatory QAFlags, Text	Result of an automatic quality assessment performed during product generation. Valid value: 'Passed', 'Suspect', or 'Failed'	Per-SDS, Per-Tile
AutomaticQuality FlagExplanation	ECS Mandatory QAFlags, Text	Explanation of the result of the automatic quality assessment. Valid value: Up to 255 characters. Sample value: 'Run was successful But no land data found/processed'	Per-SDS, Per-Tile
OperationalQuality Flag	ECS Mandatory QAFlags, Text	Result of an manual, non-science quality assessment performed by production facility personnel after production. Valid value: 'Passed', 'Suspect', 'Failed', 'Inferred Passed', 'Inferred Failed', 'Being Investigated', or 'Not Being Investigated'	Per-SDS, Per-Tile
OperationalQuality FlagExplanation	ECS Mandatory QAFlags, Text	Explanation of the result of the manual, non-science quality assessment. Valid value: Up to 255 characters	Per-SDS, Per-Tile
ScienceQuality Flag	ECS Mandatory QAFlags, Text	Result of an manual, science quality assessment performed by production facility personnel after production. Valid value: 'Passed', 'Suspect', 'Failed', 'Inferred Passed', 'Inferred Failed', 'Being Investigated', or 'Not Being Investigated'	Per-SDS, Per-Tile

(cont.)

Table 3: (cont.)

Object Name	Object Type	Description	Level
ScienceQuality FlagExplanation	ECS Mandatory QAFlags, Text	Explanation of the result of the manual, science quality assessment. Valid value: Up to 255 characters	Per-SDS, Per-Tile
QAPercent Inter- polatedData	ECS Manda- tory QAStats, Numeric	Percentage of interpolated data in the tile. Valid value: 0 100. Sample value: 12	Per-SDS, Per-Tile
QAPercent Miss- ingData	ECS Manda- tory QAStats, Numeric	Percentage of missing data in the tile. Valid value: 0 100. Sample value: 8	Per-SDS, Per-Tile
QAPercent Out- OfBoundData	ECS Manda- tory QAStats, Numeric	Percentage of data in the tile of which values are out of a valid range. Valid value: 0 100. Sample value: 2	Per-SDS, Per-Tile
QAPercent CloudCover	ECS Manda- tory QAStats, Numeric	Percentage of cloud covered data in the tile. Valid value: 0 100. Sample value: 15	Per-SDS, Per-Tile
QAPercent GoodQuality	MODLAND Mandatory, Numeric	Percentage of data produced with good quality in the tile. Valid value: 0 100. Sample value: 4	Per-Tile
QAPercent Oth- erQuality	MODLAND Mandatory, Numeric	Percentage of data produced with unreliable quality in the tile. Valid value: 0 100. Sample value: 56	Per-Tile
QAPercent Not- ProducedCloud	MODLAND Mandatory, Numeric	Percentage of data produced but contaminated with clouds in the tile. Valid value: 0 100. Sample value: 32	Per-Tile
QAPercent Not- ProducedOther	MODLAND Mandatory, Numeric	Percentage of data not produced due to bad quality in the tile. Valid value: 0 100. Sample value: 8	Per-Tile
NDVIXYZM16DAYVI Product Spe- QCLASS PER- CENTAGE	cific, Numeric	Percentage of NDVI data produced with good quality in the tile. Valid value: 0 100. Sample value: 4	Per-Tile

(cont.)

Table 3: (cont.)

Object Name	Object Type	Description	Level
EVIXYZM16DAY QCLASS PER- CENTAGE	VI Product Spe- cific, Numeric	Percentage of EVI data produced with good quality in the tile. Valid value: 0 100. Sample value: 4	Per-Tile
QAPERCENT POORQ XYZM16DAYNDVI	VI Product Spe- cific, Numeric	Summary statistics (percent frequency distribution) of the NDVI useful- ness index over the tile. Valid format: (N, N, N, N, N, N, N, N, N, N, N, N, N, N, N, N), where N = 0 100. Sample value: (4,0,0,0,44,6,18,15,5,0,0,0,0,0,8)	Per-Tile
QAPERCENT POORQ XYZM16DAYEVI	VI Product Spe- cific, Numeric	Summary statistics (percent frequency distribution) of the NDVI useful- ness index over the tile. Valid format: (N, N, N, N, N, N, N, N, N, N, N, N, N, N, N, N), where N = 0-100. Sample value: (4,0,0,0,44,6,18,15,5,0,0,0,0,0,8)	Per-Tile

5.5.2 QA Science Data Sets

A summary Quality layer has been included in the MOD13Q1: pixel reliability. This layer contains ranked values describing overall pixel quality (Table 4).

Table 4: MOD13Q1/A1 Pixel Reliability.

Rank Key	Summary QA	Description
-1	Fill/No Data	Not Processed
0	Good Data	Use with confidence
1	Marginal data	Useful, but look at other QA information
2	Snow/Ice	Target covered with snow/ice
3	Cloudy	Target not visible, covered with cloud

Because evaluation of the past 6 years of MODIS C3 and C4 data collections revealed insignificant differences between the Quality assignments for NDVI versus EVI, C5 MOD13 products include a single Quality layer pertinent to both indices, rather than one layer for each (Table 5). This reduces data volume as well as user confusion with multiple Quality layers.

QA bits are designed to document conditions under which each pixel was acquired and processed.

Table 5: Descriptions of the VI Quality Assessment Science Data Sets (QA SDS).

Bits	Parameter Name	Value	Description
0-1	VI Quality (MODLAND QA Bits)	00	VI produced with good quality
		01	VI produced, but check other QA
		10	Pixel produced, but most probably cloudy
		11	Pixel not produced due to other reasons than clouds
2-5	VI Usefulness	0000	Highest quality
		0001	Lower quality
		0010	Decreasing quality
		0100	Decreasing quality
		1000	Decreasing quality
		1001	Decreasing quality
		1010	Decreasing quality
		1100	Lowest quality
		1101	Quality so low that it is not useful
		1110	L1B data faulty
1111	Not useful for any other reason/not processed		
6-7	Aerosol Quantity	00	Climatology
		01	Low
		10	Intermediate
		11	High
8	Adjacent cloud detected	0	No
		1	Yes
9	Atmosphere BRDF Correction	0	No
		1	Yes
10	Mixed Clouds	0	No
		1	Yes
11-13	Land/Water Mask	000	Shallow ocean
		001	Land (Nothing else but land)
		010	Ocean coastlines and lake shorelines
		011	Shallow inland water
		100	Ephemeral water
		101	Deep inland water
		110	Moderate or continental ocean
111	Deep ocean		
14	Possible snow/ice	0	No

(cont.)

Table 5: (cont.)

Bits	Parameter Name	Value		Description
		1	Yes	
15	Possible shadow	0	No	
		1	Yes	

The first two bits are used for the MODLAND mandatory per-pixel QA bits that summarize the VI quality of the corresponding pixel locations. Percentages of sums of its four possible values (bit combinations) over a tile will give the MODLAND mandatory QA metadata object values (Table 6).

Table 6: Relationship between the MODLAND Mandatory per-pixel QA Bits and QA Metadata Objects.

VI Quality Bit Combination	Corresponding QA Metadata Object
00: VI produced, good quality	QAPercentGoodQuality
01: VI produced, but check other QA	QAPercentOtherQuality
10: Pixel produced, but most probably cloudy	QAPercentNotProducedCloud
11: Pixel not produced due to other reasons than clouds	QAPercentNotProducedOther

The 2nd QA bit-field is called the VI usefulness index. The usefulness index is a higher resolution quality indicator than the MODLAND mandatory QA bits (16 levels) and its value for a pixel is determined from several conditions, including 1) aerosol quantity, 2) atmospheric correction conditions, 3) cloud cover, 4) shadow, and 5) sun-target-viewing geometry (Table 7). As shown, there is a specific score that is assigned to each condition and a sum of all the scores gives a usefulness index value for the pixel. An index value of 0000 is corresponding to the highest quality, while the lowest quality is equal to a value of 1100 (i.e., 13 levels). The three largest values are reserved for three specific conditions which are shown in Table 5. There are relationships between the VI usefulness index and the MODLAND mandatory QA bits. Pixels with the index value of 0000 and 1111 always have the MODLAND QA bit values of 00 and 11, respectively.

The next three QA bit-fields document atmospheric correction scenarios of each pixel. The bits 6-7 are used to indicate aerosol quantity, and the bits 8 and 9 indicate whether an adjacency correction and atmosphere-surface BRDF coupled correction, respectively, are applied or not.

Bit 10 indicates a possible existence of mixed clouds. As the original spatial resolutions of the red and NIR bands are 250 m, these two bands were spatially aggregated to a 500 m resolution before the computations of VIs. The mixed cloud QA bit is flagged if any of the 250 m resolution pixels that were used for the aggregations were contaminated with cloud.

Table 7: VI Usefulness Index Scaling Method for the MOD13 Q1/A1 products.

Parameter Name	Condition	Score
Aerosol Quantity	If aerosol climatology was used for atmospheric correction (00) If aerosol quantity was high (11) 3	2
Atmosphere Adjacency Correction	If no adjacency correction was performed (0)	1
Atmosphere BRDF Correction	If no atmosphere-surface BRDF coupled correction was performed (0)	2
Mixed Clouds	If there possibly existed mixed clouds (1)	3
Shadow	If there possibly existed shadow (1)	2
View zenith angle (q_v)	If $q_v > 40^\circ$	1
Sun zenith angle (q_s)	If $q_s > 60^\circ$	1

Bits 11-13 are used for the land/water mask. The input land/water mask to the MOD13 Q1/A1 VI product has 7 land/water classes. The VIs are not computed for pixels over the ocean/inland water class.

Bits 14 and 15 indicate possible existences of snow/ice and shadow, respectively.

6 MOD13A2 (16-day 1-km) VI

This product is generated using the output of the daily, MODIS surface reflectance aggregation algorithm (MODAGG). The output file contains 12 SDS (Table 8).

Examples of the MOD13A2 MODIS products for the Southwest USA are included at the end of this document (Fig. 10).

6.1 Algorithm Description

The MOD13A2 VI algorithm, as in MOD13A1, operates on a per-pixel basis and requires multiple observations (days) to generate a composited VI. Due to sensor orbit overlap, multiple observations may exist for one day, hence the aggregation algorithm (MODAGG) precedes the VI algorithm. MODAGG will ingest all the daily projected (tile) surface reflectance data and generate a maximum of four observations based on quality, cloud

cover, and viewing geometry. In theory, this can result in a maximum of 64 observations over a 16-day cycle, however, due to the presence of clouds and the actual sensor spatial coverage, this number will range between 64 and 0 with decreasing observations from higher to equatorial latitudes.

Please see Subsection 5.1 “MOD13Q1/A1 Algorithm Description” for full details of the MODIS VI compositing method followed also for the MOD13A2 product.

6.2 Scientific Data Sets

The 1-km VI product has the following 12 Science Data Sets (Table 8):

Table 8: Product MOD13A2: 16-day 1-km VI.

Science Data Set	Units	Data type	Valid Range	Scale factor
1km 16 days NDVI	NDVI	int16	-2000, 10000	0.0001
1km 16 days EVI	EVI	int16	-2000, 10000	0.0001
1km 16 days VI Quality detailed QA	Bits	uint16	0, 65534	NA
1km 16 days red reflectance (Band 1)	Reflectance	int16	0, 10000	0.0001
1km 16 days NIR reflectance (Band 2)	Reflectance	int16	0, 10000	0.0001
1km 16 days blue reflectance (Band 3)	Reflectance	int16	0, 10000	0.0001
1km 16 days MIR reflectance (Band 7)	Reflectance	int16	0, 10000	0.0001
1km 16 days view zenith angle	Degree	int16	-9000, 9000	0.01
1km 16 days sun zenith angle	Degree	int16	-9000, 9000	0.01
1km 16 days relative azimuth angle	Degree	int16	-3600, 3600	0.1
1km 16 days composite day of the year	Day of year	int16	1, 366	NA
1km 16 days pixel reliability	Rank	int8	0, 4	NA

6.3 Product Specific Metadata

A listing of the metadata fields used for QA evaluations of the MOD13A2 VI product is included in Table 9.

6.4 Global and Local Metadata Attributes

As in all MODIS products, the global metadata is written to the output file during the generation process and could be used for searching the archive about the product. A listing of relevant metadata is provided.

Table 9: Metadata fields for QA evaluation of MOD13A2.

I. Inventory Metadata fields for all VI products (searchable)
 QAPERCENTINTERPOLATEDDATA
 QAPERCENTMISSINGDATA
 QAPERCENTOUTOFBOUNDSDATA
 QAPERCENTCLOUDCOVER
 QAPERCENTGOODQUALITY
 QAPERCENTOTHERQUALITY
 QAPERCENTNOTPRODUCEDCLOUD
 QAPERCENTNOTPRODUCEDOTHER

II. Product specific metadata (searchable)

Product	Specific Metadata variable name (Best Quality)
MOD13A2	NDVI1KM16DAYQCLASSPERCENTAGE
MOD13A2	EVI1KM16DAYQCLASSPERCENTAGE

III. Archived Metadata (not searchable)

Product	Metadata variable name (Array of QA usefulness histogram)
MOD13A2	QAPERCENTPOORQ1KM16DAYNDVI
MOD13A2	QAPERCENTPOORQ1KM16DAYEVI

6.5 Quality Assurance

In principal, the QA metadata objects and QA SDS's of the MOD13A2 product are the same as those of the MOD13A1 product. In this section, we only describe the differences of the MOD13A2 product QA from the MOD13A1 product QA.

6.5.1 QA Metadata

As the spatial resolution of the MOD13A2 product differs from that of the MOD13A1 product, the 4 VI PSA object names differ correspondingly. Table 10 lists the correspondences between these object names.

Table 10: Correspondence of the VI PSA QA Metadata Object Names between MOD13A2 and MOD13A1 products.

Object Name in the MOD13A2	Object Name in the MOD13A1
NDVI1KM16DAYQCLASSPERCENTAGE	NDVI500M16DAYQCLASSPERCENTAGE
EVI1KM16DAYQCLASSPERCENTAGE	EVI500M16DAYQCLASSPERCENTAGE
QAPERCENTPOORQ1KM16DAYNDVI	QAPERCENTPOORQ500M16DAYNDVI
QAPERCENTPOORQ1KM16DAYEVI	QAPERCENTPOORQ500M16DAYEVI

6.5.2 QA Science Data Sets

VI usefulness index computation is performed according the criteria showed in Table 11.

VI Pixel reliability is described in 'Pixel reliability summary QA' SDS (Table 4), and detailed QA bit fields are described in 'VI Quality detailed QA' SDS (Table 5).

Table 11: VI Usefulness Index Scaling Method for the MOD13A2 Product.

Parameter Name	Condition	Score
Aerosol Quantity (bits 6-7)	Low or average aerosols	0
	Climatology aerosols	2
	High aerosols	3
Atmosphere BRDF Correction (bit 9)	Performed	0
	Not performed	2
Mixed Clouds (bit 10)	No mixed clouds	0
	Possible mixed clouds	3
Shadows (bit 15)	No shadows	0
	Possible shadows	2
View zenith angle (q_v)	If $q_v > 40^\circ$	1
Sun zenith angle (q_s)	If $q_s > 60^\circ$	1

7 MOD13A3 (monthly 1-km) VI

This product is generated using the 16-day 1-km MODIS VI output, temporally aggregated using a wighted average to create a calendar-month composite. The output file contains 11 SDS's (Table 12)

7.1 Algorithm Description

This algorithm operates (Fig. 4) on a per-pixel basis and requires all 16-day VI products which overlap within a calendar month. Once all 16-day composites are collected, a weighing factor based on the degree of temporal overlap is applied to each input. In assigning the pixel QA, a worst case scenario is used, whereby the pixel with the lowest quality determines the final pixel QA.

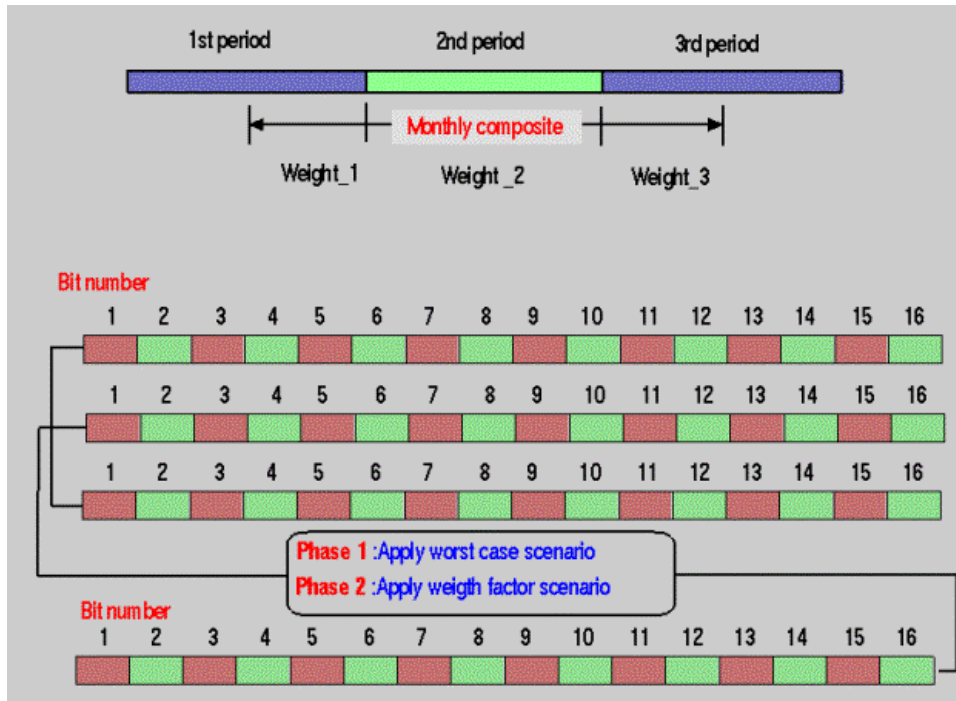

Figure 4: Monthly MODIS VI flow diagram.

7.2 Scientific Data Sets

The monthly 1-km MOD13A3 VI product has 11 SDS's, as listed in Table 12. Compared with MOD13A2, the only difference (besides the temporal aggregation) is the lack of the composite day of the year SDS.

Table 12: Product MOD13A3: monthly 1-km VI.

Science Data Set	Units	Data type	Valid Range	Scale factor
1km monthly NDVI	NDVI	int16	-2000, 10000	0.0001
1km monthly EVI	EVI	int16	-2000, 10000	0.0001
1km monthly VI Quality	Bits	uint16	0, 65534	NA
1km monthly red reflectance (Band 1)	Reflectance	int16	0, 10000	0.0001
1km monthly NIR reflectance (Band 2)	Reflectance	int16	0, 10000	0.0001
1km monthly blue reflectance (Band 3)	Reflectance	int16	0, 10000	0.0001
1km monthly MIR reflectance (Band 7)	Reflectance	int16	0, 10000	0.0001
1km monthly view zenith angle	Degree	int16	-9000, 9000	0.01
1km monthly sun zenith angle	Degree	int16	-9000, 9000	0.01
1km monthly relative azimuth angle	Degree	int16	-3600, 3600	0.1
1km monthly pixel reliability	Rank	int8	0, 3	NA

7.3 Product Specific Metadata

A listing of the metadata fields used for QA evaluations of the MOD13A3 VI product is included in Table 13.

Table 13: Metadata fields for QA evaluation of MOD13A3.

I. Inventory Metadata fields for all VI products (searchable)	
	QAPERCENTINTERPOLATEDDATA
	QAPERCENTMISSINGDATA
	QAPERCENTOUTOFBOUNDSDATA
	QAPERCENTCLOUDCOVER
	QAPERCENTGOODQUALITY
	QAPERCENTOTHERQUALITY
	QAPERCENTNOTPRODUCEDCLOUD
	QAPERCENTNOTPRODUCEDOTHER
II. Product specific metadata (searchable)	
Product	Specific Metadata variable name (Best Quality)
MOD13A3	NDVI1KMMONTHQCLASSPERCENTAGE
MOD13A3	EVI1KMMONTHQCLASSPERCENTAGE
III. Archived Metadata (not searchable)	
Product	Metadata variable name (Array of QA usefulness histogram)
MOD13A3	QAPERCENTPOORQ1KMMONTHNDVI
MOD13A3	QAPERCENTPOORQ1KMMONTHEVI

7.4 Global and Local Metadata Attributes

MOD13A3 Metadata attributes are almost the same as in MOD13A2 (16-day 1-km VI); please refer to the corresponding MOD13A2 description.

7.5 Quality Assurance

As in MOD13A1 and MOD13A2 products, each MOD13A3 output pixel has a ranked summary quality SDS (Table 4), and a single QA SDS for both NDVI and EVI quality assurance (Table 5).

7.5.1 QA Metadata

As both the spatial and temporal resolutions of the MOD13A3 product differ from those of the MOD13A1 product, the 4 VI PSA object names differ correspondingly. Table 14 lists the correspondences between these object names.

Table 14: Correspondence of the VI PSA QA Metadata Object Names between the MOD13A3 and MOD13A1 Products.

Object Name in the MOD13A2	Object Name in the MOD13A1
NDVI1KMMONTHQCLASSPERCENTAGE	NDVI500M16DAYQCLASSPERCENTAGE
EVI1KMMONTHQCLASSPERCENTAGE	EVI500M16DAYQCLASSPERCENTAGE
QAPERCENTPOORQ1KMMONTHNDVI	QAPERCENTPOORQ500M16DAYNDVI
QAPERCENTPOORQ1KMMONTHEVI	QAPERCENTPOORQ500M16DAYEVI

7.5.2 QA Science Data Sets

MOD13A3 QA SDS are kept the same as described MOD13 products (Table 5)

8 MOD13C1 CMG (16-day 0.05-deg) VI

The VI CMG series is a seamless global 3600x7200 pixel data product with 13 SDS's, at approximately 100 MB per composite period (using internal compression). This is a higher quality climate product useful in time series analyses of earth surface processes. It incorporates a QA filter scheme that removes lower quality and cloud-contaminated pixels in aggregating the 1-km pixels into the 0.05-deg geographic (lat/lon) CMG product (See Fig. 13 for a sample image). It also incorporates a data fill strategy, based on historic data records, to produce a continuous and reliable product for ready entry into biogeochemical, carbon, and growth models. With its very manageable size, the VI CMG can be used for many purposes.

Cloud-free global coverage is achieved by replacing clouds with the historical MODIS time series climatology record (Fig. 5).

8.1 Algorithm Description

Global MOD13C1 data are cloud-free spatial composites of the gridded 16-day 1-kilometer MOD13A2, and are provided as a level-3 product projected on a 0.05 degree (5600-meter) geographic Climate Modeling Grid (CMG).

Processing Flow

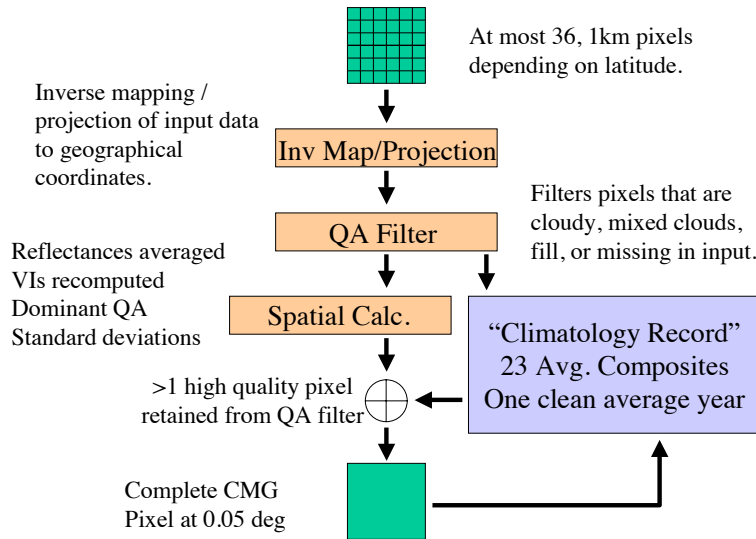

Figure 5: MOD13 CMG Processing flow.

The algorithm attempts to minimize clouds in the output product. To do so, it employs three different averaging schemes. All input 1-km pixels (nominally 6x6) will either be all clear, all cloudy, or mixed. These averaging schemes work as follows: If all input pixels are clear, they will be all averaged to produce one output value; If all input pixels are cloudy, the pixel will be computed from the historical database; and, If the input pixels are mixed, only the clear pixels are averaged to produce one output value

The MOD13C1 uses the entire MODIS data record to calculate a reliable VI fill value in case input data is missing or deemed cloudy. The fill value is calculated from the average of good data from all previous years CMGs of that composite period. It is mainly used for replacing completely cloudy data, but is powerful enough to reliably fill in whole missing tiles (Fig. 6).

All fill strategies have their fallacies and pitfalls. In the Climatology Fill case, certain highly dynamic regions may show discrepancies where fill values were used. This is most obvious when missing input tiles are replaced, where edges may be visible. For pixels filled due to high cloud contamination, this fill strategy will perform well.

The fill completes the two VI layers with data. Other layers will contain their respective fill values, except data layer 11 (#1km pix used), which is set to 0, i.e., no good input data.

8.2 Scientific Data Sets

The 16-day 0.05-deg MOD13C1 VI product has 13 SDSs, as listed in Table 15.

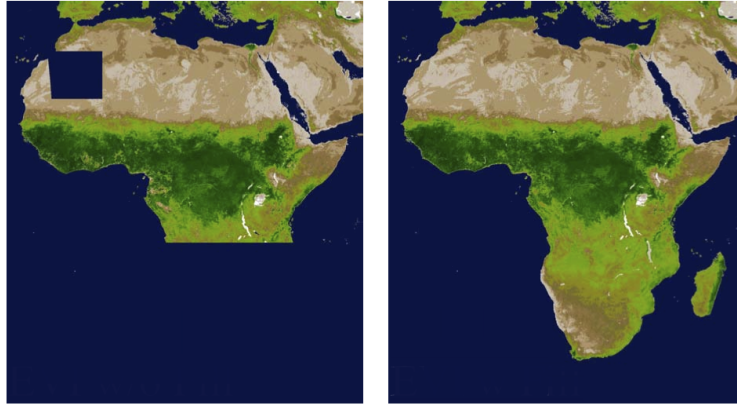

Figure 6: MOD13C product series filling strategy. Historical (“climatological”) data is used to replace missing pixels (even entire tiles as in this case).

Table 15: List of SDS’s from 16-day 0.05-deg MOD13C1 VI.

Science Data Set	Units	Data type	Valid Range	Scale factor
CMG 0.05 Deg 16 days NDVI	NDVI	int16	-2000, 10000	0.0001
CMG 0.05 Deg 16 days EVI	EVI	int16	-2000, 10000	0.0001
CMG 0.05 Deg 16 days VI Quality	Bits	uint16	0, 65534	NA
CMG 0.05 Deg 16 days red reflectance (Band 1)	Reflectance	int16	0, 10000	0.0001
CMG 0.05 Deg 16 days NIR reflectance (Band 2)	Reflectance	int16	0, 10000	0.0001
CMG 0.05 Deg 16 days blue reflectance (Band 3)	Reflectance	int16	0, 10000	0.0001
CMG 0.05 Deg 16 days MIR reflectance (Band 7)	Reflectance	int16	0, 10000	0.0001
CMG 0.05 Deg 16 days Avg sun zenith angle	Degree	int16	-9000, 9000	0.01
CMG 0.05 Deg 16 days NDVI std dev	NDVI	int16	-2000, 10000	0.0001
CMG 0.05 Deg 16 days EVI std dev	EVI	int16	-2000, 10000	0.0001
CMG 0.05 Deg 16 days #1km pix used	Pixels	uint8	0, 36	1
CMG 0.05 Deg 16 days #1km pix +-30deg VZ	Pixels	uint8	0, 36	1
CMG 0.05 Deg 16 days pixel reliability	Rank	int8	0, 4	1

8.3 Quality Assurance

As in previous MODIS VI products, the QA metadata objects summarize tile-level quality with several single words and numeric numbers, and thus are useful for data ordering and screening processes.

The QA SDSs, on the other hand, document product quality on a pixel-by-pixel basis and thus are useful for data analyses and application uses of the data. Each MOD13C1 output pixel has a ranked summary quality SDS (Table 4), and a single QA SDS for both NDVI and EVI quality assurance (Table 5).

8.3.1 QA Metadata

A listing of the metadata fields used for QA evaluations of the MOD13C1 and MOD13C2 VI product is included in Table 16.

Table 16: Metadata fields for QA evaluation of MOD13C1 and MOD13C2 products.

I. Inventory Metadata fields for all VI products (searchable)	
	QAPERCENTINTERPOLATEDDATA
	QAPERCENTMISSINGDATA
	QAPERCENTOUTOFBOUNSDATA
	QAPERCENTCLOUDCOVER
	QAPERCENTGOODQUALITY
	QAPERCENTOTHERQUALITY
	QAPERCENTNOTPRODUCEDCLOUD
	QAPERCENTNOTPRODUCEDOTHER
II. Product specific metadata (searchable)	
Product	Specific Metadata variable name (Best Quality)
MOD13C1	EVICMG16DAYQCLASSPERCENTAGE
MOD13C1	NDVICMG16DAYQCLASSPERCENTAGE
MOD13C2	EVICMGMONTHQCLASSPERCENTAGE
MOD13C2	NDVICMGMONTHQCLASSPERCENTAGE
III. Archived Metadata (not searchable)	
Product	Metadata variable name (Array of QA usefulness histogram)
MOD13C1	QAPERCENTPOORQCMG16DAYEVI
MOD13C1	QAPERCENTPOORQCMG16DAYNDVI
MOD13C2	QAPERCENTPOORQCMGMONTHEVI
MOD13C2	QAPERCENTPOORQCMGMONTHNDVI

8.3.2 QA Science Data Sets

As with previous VI products, the VI Usefulness rank (bits 2-5 in the QA SDS) computation is performed for MOD13C1 according the criteria showed in Table 11. Detailed QA bit 0-13 are kept the same as for MOD13A2 (Table 5); bits 14-15 are replaced as stated in Table 17.

Table 17: Bits 14-15 of the MOD13C1 VI Quality Assessment SDS.

Bits	Parameter Name	Value	Description
14-15	Geospatial quality	00	$\leq 25\%$ of the finer 1-km resolution contributed to this CMG pixel
		01	$> 25\%$ and $\leq 50\%$ of the finer 1-km resolution contributed to this CMG pixel
		10	$> 50\%$ and $\leq 75\%$ of the finer 1-km resolution contributed to this CMG pixel
		11	$> 75\%$ of the finer 1-km resolution contributed to this CMG pixel

VI Pixel reliability has an additional rank compared with other VI product, which is used to describe if pixels were generated using the historical filling criteria (Table 18).

Table 18: MOD13C1 Pixel Reliability.

Rank Key	Summary QA	Description
-1	Fill/No Data	Not Processed
0	Good Data	Use with confidence
1	Marginal data	Useful, but look at other QA information
2	Snow/Ice	Target covered with snow/ice
3	Cloudy	Target not visible, covered with cloud
4	Estimated	From MODIS historic time series

9 MOD13C2 CMG (monthly 0.05-deg) VI

Global MOD13C2 data are cloud-free spatial composites of the gridded monthly 1-km MOD13A3 product. MOD13C3 is provided as a level-3 product projected on a 0.05 degree (5600-meter) geographic (lat/lon) Climate Modeling Grid (CMG). Cloud-free global coverage is achieved by replacing clouds with the historical MODIS time series climatology record.

MOD13C2 product is analogous to MOD13C1 but based on MOD13A3 for a monthly temporal resolution; all other specs are kept the same, and production features retained. See Section 8 for more details.

9.1 Algorithm Description

Algorithm is as for MOD13C1, but using monthly MOD13A3 as input.

9.2 Scientific Data Sets

MOD13C2 VI product has 13 SDSs, as listed in Table 19.

Table 19: List of SDS's from monthly 0.05-deg MOD13C2 VI.

Science Data Set	Units	Data type	Valid Range	Scale factor
CMG 0.05 Deg Monthly NDVI	NDVI	int16	-2000, 10000	0.0001
CMG 0.05 Deg Monthly EVI	EVI	int16	-2000, 10000	0.0001
CMG 0.05 Deg Monthly VI Quality	Bits	uint16	0, 65534	NA
CMG 0.05 Deg Monthly red reflectance (Band 1)	Reflectance	int16	0, 10000	0.0001
CMG 0.05 Deg Monthly NIR reflectance (Band 2)	Reflectance	int16	0, 10000	0.0001
CMG 0.05 Deg Monthly blue reflectance (Band 3)	Reflectance	int16	0, 10000	0.0001
CMG 0.05 Deg Monthly MIR reflectance (Band 7)	Reflectance	int16	0, 10000	0.0001
CMG 0.05 Deg Monthly Avg sun zenith angle	Degree	int16	-9000, 9000	0.01
CMG 0.05 Deg Monthly NDVI std dev	NDVI	int16	-2000, 10000	0.0001
CMG 0.05 Deg Monthly EVI std dev	EVI	int16	-2000, 10000	0.0001
CMG 0.05 Deg Monthly #1km pix used	Pixels	uint8	0, 36	1
CMG 0.05 Deg Monthly #1km pix +- 30deg VZ	Pixels	uint8	0, 36	1
CMG 0.05 Deg Monthly pixel reliability	Rank	int8	0, 4	1

9.3 Quality Assurance

As in MOD13C1, QA metadata objects summarize tile-level quality with several single words and numeric numbers, and thus are useful for data ordering and screening processes.

QA SDSs document product quality on a pixel-by-pixel basis and thus are useful for data analyses and application uses of the data. Each MOD13C3 output pixel has a ranked summary quality SDS (Table 4), and a single QA SDS for both NDVI and EVI quality assurance (Table 5).

9.3.1 QA Metadata

A listing of the metadata fields used for QA evaluations of the MOD13C2 VI product is included in Table 16.

9.3.2 QA Science Data Sets

QA SDS for MOD13C3 are the same as for MOD13C1 (See Section 8.3.2 for details).

10 Related Web Sites

- MODIS VI Theoretical Basis document: http://modis.gsfc.nasa.gov/data/atbd/atbd_mod13.pdf
- MODIS VI User's Guide: <http://tbrs.arizona.edu/project/MODIS/UserGuideC5/index.html>
- MOD13 VI C5 Changes Document: http://landweb.nascom.nasa.gov/QA_WWW/forPage/MOD13_VI_C5_Changes_Document_06_28_06.pdf
- Data Access Tools
 - Data Pool: The Data Pool (On-line Archive): https://lpdaac.usgs.gov/lpdaac/get_data/data_pool
 - WIST: The Warehouse Inventory Search Tool: <https://wist.echo.nasa.gov/~wist/api/imswelcome>
 - GloVis: The Global Visualization interface provides access to tiled MODIS products that have an associated browse image: <http://glovis.usgs.gov/>
 - MRTWeb: The MODIS Reprojection Tool Web interface provides access to all MRT services offered by the stand-alone MRT utility: <http://mrtweb.cr.usgs.gov/>
- MODIS Reprojection Tool: Utilities to convert from Sinusoidal projection, sub-setting, band extracting and format change from HDF-EOS (and more): https://lpdaac.usgs.gov/lpdaac/tools/modis_reprojection_tool
- MODIS Project: <http://modis.gsfc.nasa.gov/>
- MODIS Products: https://lpdaac.usgs.gov/lpdaac/products/modis_products_table
- MODIS Land Discipline: <http://modis-land.gsfc.nasa.gov>
- MODIS Land Data Discipline Team: <http://landweb.nascom.nasa.gov/>
- HDF: <http://www.hdfgroup.org/>
- HDF-EOS: <http://www.hdfgroup.org/hdfeos.html>

11 FAQ

Frequently Asked Questions about MODIS VI Products

Q. *What is the difference between NDVI and EVI?*

A. The Enhanced Vegetation Index differs from NDVI by attempting to correct for atmospheric and background effects. EVI appears to be superior in discriminating subtle differences in areas of high vegetation density, situations in which NDVI tends to saturate. NDVI has been used for several decades, which is advantageous for studying historical changes. Please refer to our page on vegetation indices for more information.

Q. *What spatial resolutions are available?*

A. 250 m (MOD13Q1), 500 m (MOD13A1), 1 km (MOD13A2), and 0.05 deg (MOD13C1 and MOD13C2).

Q. *What temporal resolutions are available?*

A. Base products are 16-day (MOD13Q1, MOD13A1, MOD13A2 and MOD13C1). Monthly products (MOD13A3 and MOD13C2) are generated from their 16-day counterparts.

Q. *How often are images acquired?*

A. MODIS images are collected daily, however the vegetation products are composites of the best pixels from 16 consecutive days. These composites are produced on 16-day cycles. Monthly products are generated by using a weighted-average scheme on corresponding 16-day products.

Q. *Where can I order the data from?*

A. There are several sources of data, each providing different ways to access the data pool. Please see section “Related Web Sites” (Sec. 10), bullet “Data Access Tools” for detailed information.

Q. *How can I order MODIS data from TBRS?*

A. The TBRS lab does not keep complete archives of MODIS data due to space limitations. MODIS data may be ordered through the sites listed before.

Q. *How much does MODIS data cost?*

A. MODIS data are free.

Q. *What is a “tile”?*

A. Global data from MODIS are organized as units that are 10deg by 10deg at the Equator, but vary according to the latitude. These units are called tiles. The tile coordinate system starts at (0,0) in the UL corner and proceeds right (horizontal) and downward (vertical). The tile in the bottom right corner is (35,17). See http://modis-land.gsfc.nasa.gov/MODLAND_grid.htm for more information.

Q. *How can I determine the tile and pixel coordinates for a specific site with known geographic coordinates?*

A. You can use the MODIS Tile Calculator (<http://landweb.nascom.nasa.gov/cgi-bin/developer/tilemap.cgi>).

Q. *What is the file format of MODIS data?*

A. HDF-EOS. Please see Section “Related Web Sites” for links to further details.

Q. *How can I read HDF/HDF-EOS data?*

A. Some image processing programs, such as ENVI and PCI Geomatics, can read the format directly. If needed, free MODIS tools for converting the data format are available at https://lpdaac.usgs.gov/lpdaac/tools/modis_reprojection_tool.

Q. *My software does not recognize the MODIS map projection. What is the projection and how can I change it?*

A. The projection is called Sinusoidal (SIN). Use the MODIS Tools, available at https://lpdaac.usgs.gov/lpdaac/tools/modis_reprojection_tool to reproject your data to a more common projection.

12 Sample images

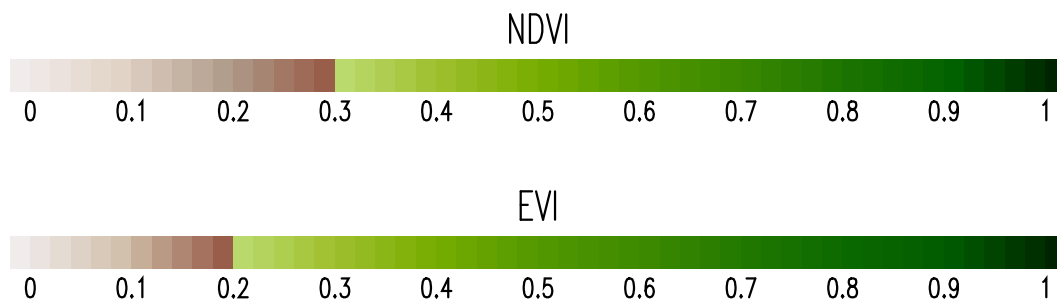

Figure 7: MODIS VI Color Palettes for NDVI (upper) and EVI (lower) products as used in this document.

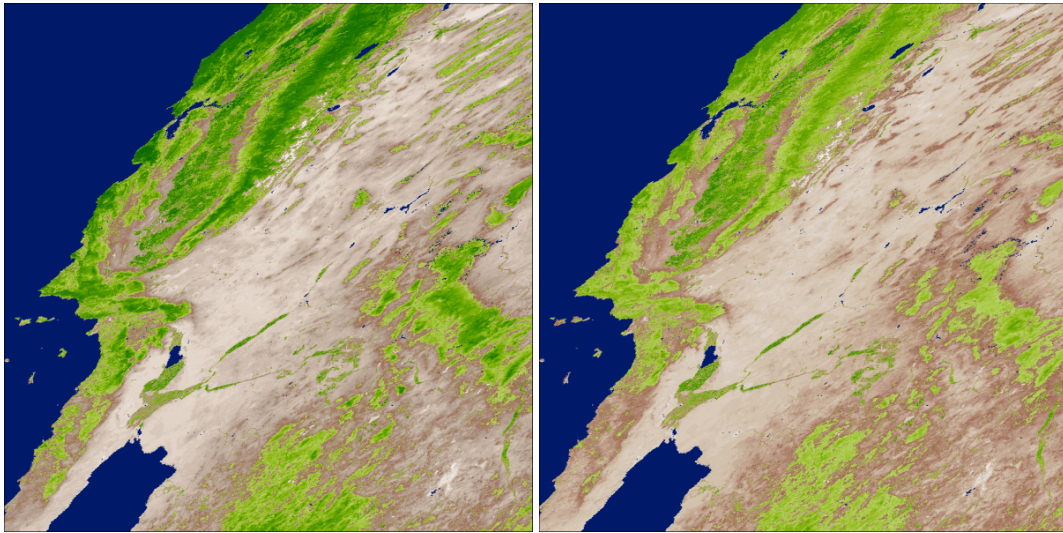

Figure 8: Colored 16-day 250-m MOD13Q1 NDVI and EVI images (left and right respectively). Data from the western United States (tile h08v05), corresponding to the period from June 25 to July 10, 2000.

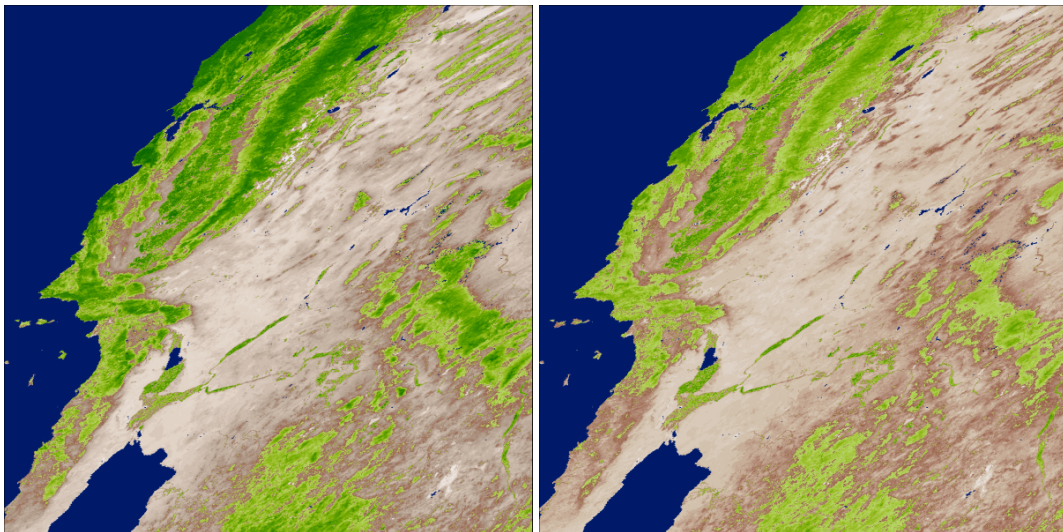

Figure 9: Colored 16-day 500-m MOD13A1 NDVI and EVI images (left and right respectively). Data from the western United States (tile h08v05), corresponding to the period from June 25 to July 10, 2000.

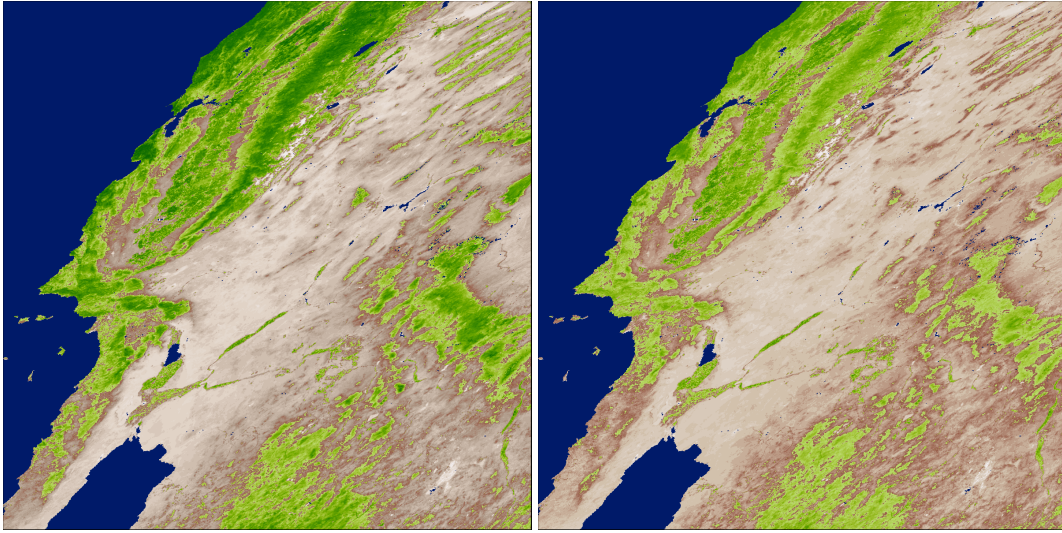

Figure 10: Colored 16-day 1-km MOD13A2 NDVI and EVI images (left and right respectively). Data from the western United States (tile h08v05), corresponding to the period from June 25 to July 10, 2000.

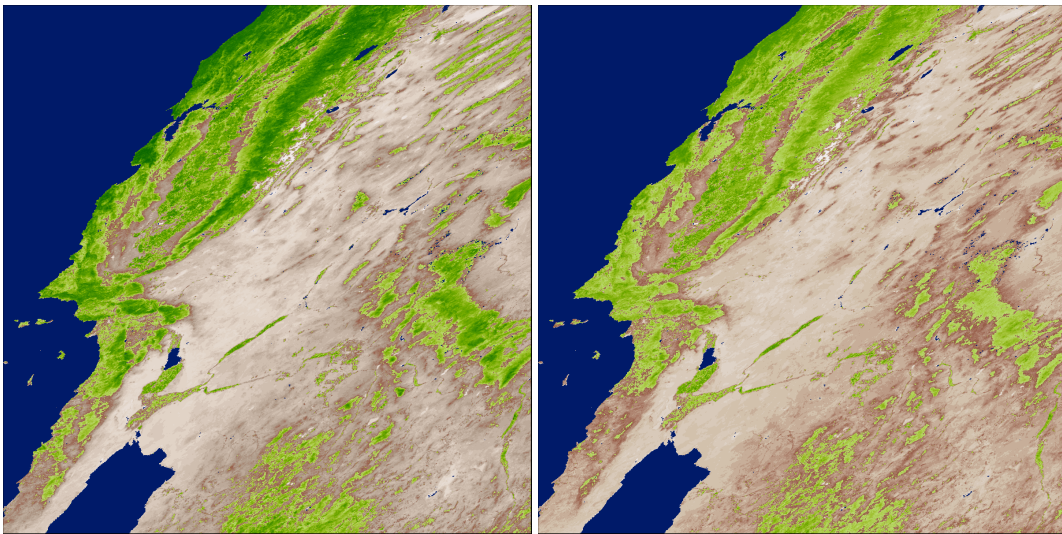

Figure 11: Colored monthly 1-km MOD13A3 NDVI and EVI images (left and right respectively). Data from the western United States (tile h08v05), corresponding to June, 2000.



Figure 12: 0.05-deg 16-day MOD13C1 NDVI (upper) and EVI (lower) sample images. The VI values have been pseudo-colored to represent biomass health across the globe using data acquired during April 6-22, 2000.

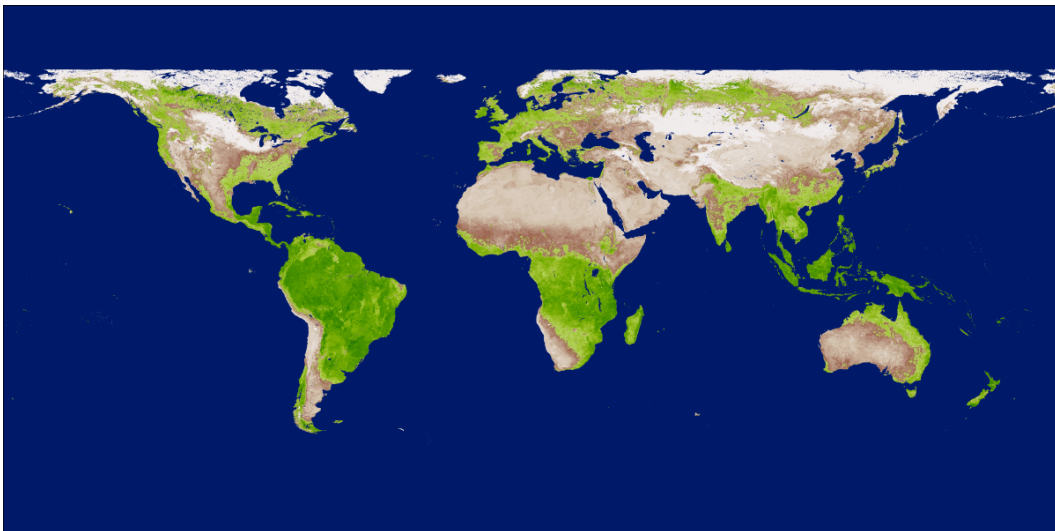

Figure 13: monthly 0.05-deg MOD13C2 NDVI (upper) and EVI (lower) sample images. The VI values have been pseudo-colored to represent biomass health across the globe using data acquired in January 2001.

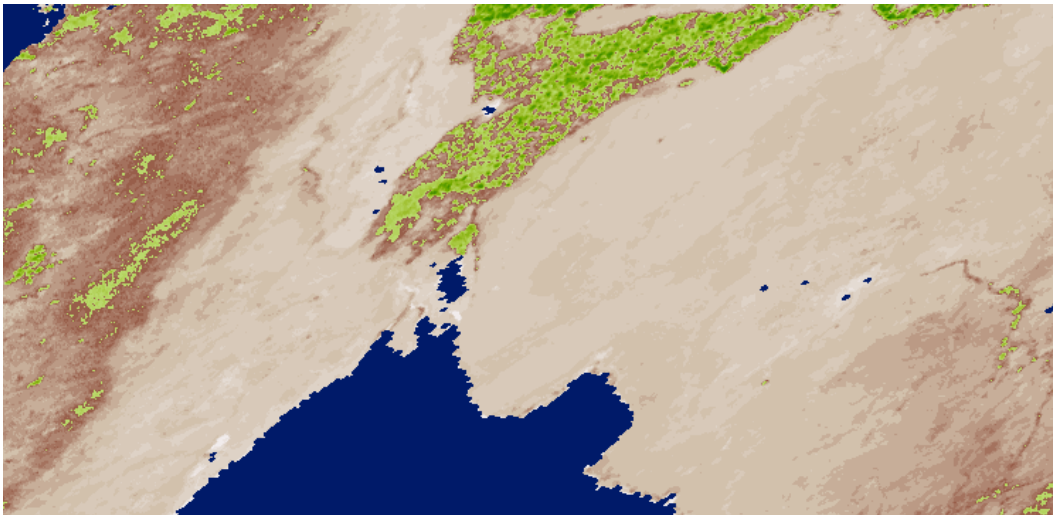
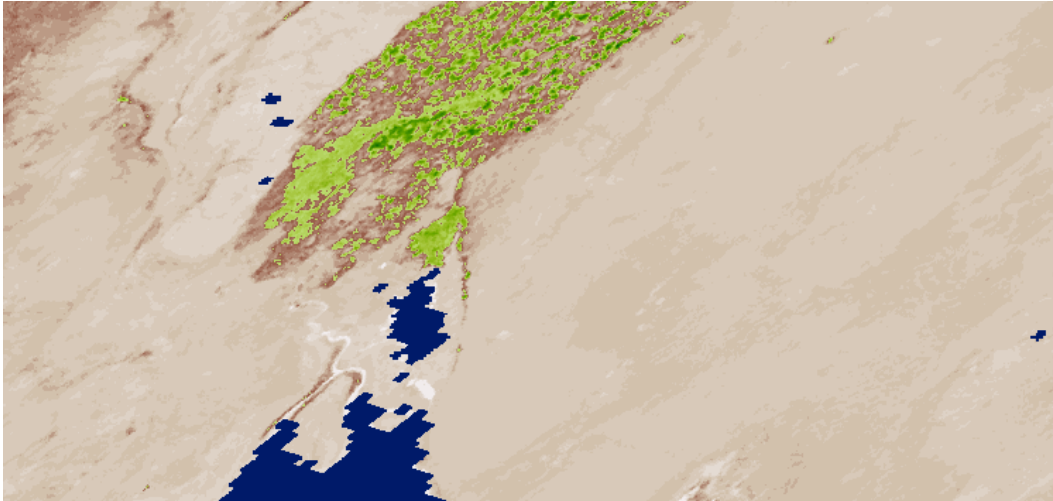

Figure 14: Comparative of MOD13Q1 and MOD13A1 spatial resolution: *Upper image:* 250-m MOD13Q1; *Lower image:* 500-m MOD13A1. Images are subsets from corresponding full tiles shown before, but shown here at natural spatial resolution (each image pixel corresponds to 1 native MODIS data pixel). Location shows agricultural, riparian and wetland areas along the lower Colorado River and U.S.-Mexico Border.

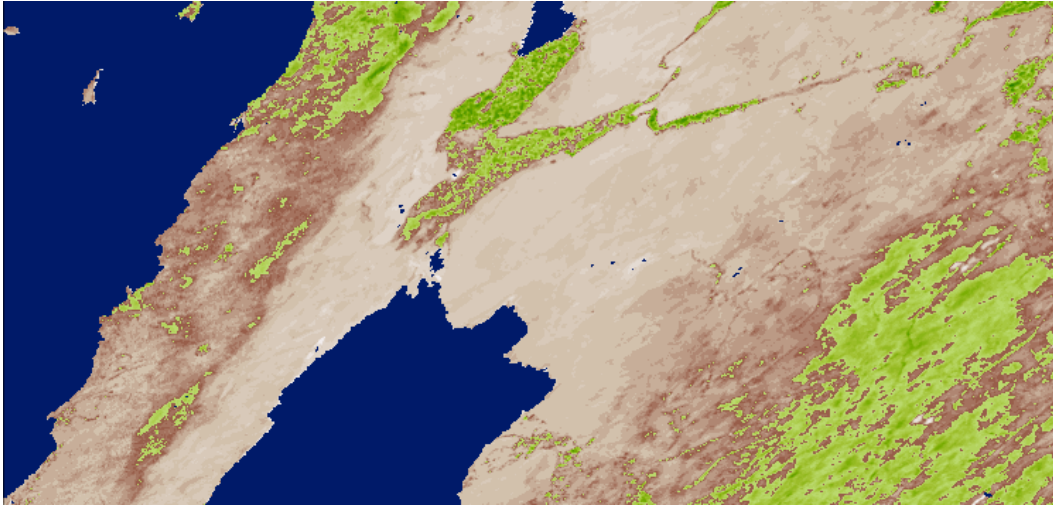

Figure 15: Comparative of MOD13A2 and MOD13C1 spatial resolution: *Upper image:* 1-km MOD13A2; *Lower image:* 0.05-deg MOD13C1. MOD13A2 is projected in Sinusoidal (SIN) projection, while MOD13C is in Geographic coordinates. Images are subsets from corresponding full tiles or images shown before, but shown here at natural spatial resolution (each image pixel corresponds to 1 native MODIS data pixel).