

A FRAMEWORK FOR AN INTERACTIVE,
COMPUTER-SUPPORTED, BATTALION-LEVEL
WAR GAME

Dominic Nicolosi

WILEY JOHN LIBRARY
LINAL POSTGRADUATE SCHOOL
MONTESEY, CA 93940

1974

140

NAVAL POSTGRADUATE SCHOOL
Monterey, California



THESIS

A FRAMEWORK FOR AN INTERACTIVE,
COMPUTER-SUPPORTED, BATTALION-LEVEL
WAR GAME

by

Dominic Nicolosi, Jr.

June 1979

Thesis Advisor:

J. M. Wozencraft

Approved for public release; distribution unlimited

T196266

REPORT DOCUMENTATION PAGE

READ INSTRUCTIONS
BEFORE COMPLETING FORM

1. REPORT NUMBER		2. GOVT ACCESSION NO.	3. RECIPIENT'S CATALOG NUMBER
4. TITLE (and Subtitle) A Framework for an Interactive, Computer-Supported, Battalion-Level War Game		5. TYPE OF REPORT & PERIOD COVERED Master's Thesis June 1979	
7. AUTHOR(s) Dominic Nicolosi, Jr.		6. PERFORMING ORG. REPORT NUMBER	
9. PERFORMING ORGANIZATION NAME AND ADDRESS Naval Postgraduate School Monterey, California 93940		8. CONTRACT OR GRANT NUMBER(s)	
11. CONTROLLING OFFICE NAME AND ADDRESS Naval Postgraduate School Monterey, California 93940		10. PROGRAM ELEMENT, PROJECT, TASK AREA & WORK UNIT NUMBERS	
14. MONITORING AGENCY NAME & ADDRESS (if different from Controlling Office) Naval Postgraduate School Monterey, California 93940		12. REPORT DATE June 1979	
		13. NUMBER OF PAGES 136	
		15. SECURITY CLASS. (of this report) Unclassified	
		15a. DECLASSIFICATION/DOWNGRADING SCHEDULE	

16. DISTRIBUTION STATEMENT (of this Report)

Approved for public release; distribution unlimited

17. DISTRIBUTION STATEMENT (of the abstract entered in Block 20, if different from Report)

18. SUPPLEMENTARY NOTES

19. KEY WORDS (Continue on reverse side if necessary and identify by block number)

20. ABSTRACT (Continue on reverse side if necessary and identify by block number)

This thesis analyzes in depth the Army's PEGASUS free-play, manual wargame and developes in detail the event-sequenced logic which comprises the battle simulation. The resulting logic has been structured to serve as a framework for the programming of an interactive, computer-supported, battalion-level wargame. The game is designed for 2 players, rather than the 35-40 required in the PEGASUS manual mode, with the players role-playing the



adversary force commanders. Battle results are determined stochastically, and relevant battle information is filtered and displayed to the players to enhance their tactical decision-making.

The framework is sufficiently flexible so that future weapon systems and sophisticated sensors can be incorporated into the game. Exercising this potential in future studies may provide unique insights into the processing of information and decision-making on the modern, automated battlefield.



Approved for Public Release; Distribution Unlimited

A Framework for an Interactive, Computer-Supported,
Battalion-Level War Game

by

Dominic Nicolosi, Jr.
Major, United States Marine Corps
B.S., University of Texas, 1968

Submitted in partial fulfillment of the
requirements for the degree of

MASTER OF SCIENCE IN OPERATIONAL DECISION SYSTEMS

from the

NAVAL POSTGRADUATE SCHOOL
June, 1979



ABSTRACT

This thesis analyzes in depth the Army's PEGASUS free-play, manual war game, and develops in detail the event-sequenced logic which comprises the battle simulation. The resulting logic has been structured to serve as a framework for the programming of an interactive, computer-supported, battalion-level war game. The game is designed for 2 players, rather than the 35-40 required in the PEGASUS manual mode, with the players role-playing the adversary force commanders. Battle results are determined stochastically, and relevant battle information is filtered and displayed to the players to enhance their tactical decision-making.

The framework is sufficiently flexible so that future weapon systems and sophisticated sensors can be incorporated into the game. Exercising this potential in future studies may provide unique insights into the processing of information and decision-making on the modern, automated battlefield.

TABLE OF CONTENTS

I.	INTRODUCTION-----	13
II.	THE PEGASUS MANUAL WAR GAME-----	16
	A. GENERAL-----	16
	B. PEGASUS CONCEPT AND ORGANIZATION-----	16
	1. Players-----	17
	2. Control Group-----	17
	a. Controllers-----	17
	b. Functional Controllers-----	18
	c. Player-Controllers-----	18
	C. THE PEGASUS EXERCISE-----	19
	D. CONTROL BOARD-----	20
	E. GENERAL SEQUENCE OF PLAY-----	21
	1. Indirect Fire Phase-----	22
	2. Direct Fire Phase-----	22
	3. Movement Phase-----	22
	F. CONFLICT RESOLUTION - THE COMBAT RESULTS TABLES-----	23
	G. APPLICABILITY OF PEGASUS TO COMPUTER SIMULATION-----	24
III.	SIMULATION DESCRIPTION-----	26
	A. GENERAL-----	26
	B. BATTALION-LEVEL PLAY-----	27
	C. ROLE OF THE PLAYER-----	29
	D. THE GAME ENVIRONMENT-----	30

E.	THE GAME FLOW-----	31
	1. Indirect Fire Results Subroutine-----	32
	2. Direct Fire Results Subroutine-----	34
	3. Movement Phase Subroutines-----	34
	a. Movement Execution-----	34
	b. Target Detection-----	35
	c. Immediate Fire-----	35
	d. Close Assaults-----	36
	e. Planning Phase-----	36
F.	SUBROUTINE DESIGN-----	36
G.	DATA BASE INPUT-----	37
H.	DATA BASE ORGANIZATION-----	38
I.	CHANGE-OF-STATE PROCEDURES-----	39
IV.	INDIRECT FIRE ENGAGEMENTS-----	40
	A. GENERAL-----	40
	B. EMPLOYMENT OF INDIRECT FIRES-----	40
	C. PLAYER INPUT REQUIREMENTS-----	43
	D. ASSESSMENT OF INDIRECT FIRE RESULTS-----	43
	1. Reduction of Target Categories-----	46
	2. Consolidation of Tables-----	46
	3. Casualty Considerations-----	47
	E. CASUALTY TABLE RELATIONSHIPS-----	48
	F. CASUALTY ALGORITHM-----	50
	G. SUPPRESSION EFFECTS-----	57
V.	TARGET ACQUISITION-----	60
	A. GENERAL-----	60
	B. TARGET ACQUISITION-----	60



C.	LINE-OF-SIGHT PROBLEM FORMULATION-----	61
D.	MODEL IMPLICATIONS-----	62
	1. Uniformity of Elevation in Hex-----	62
	2. Uniformity of Terrain Features-----	62
	3. The Irregular Hexagon-----	63
E.	LINE-OF-SIGHT DETERMINATION-----	64
F.	DETERMINATION IF HEX IS OBSCURING HEX-----	71
G.	DETERMINATION OF OBSCURING ELEVATION OF HEX-----	73
H.	DETERMINATION OF OBSCURATION-----	74
I.	DETECTION-GENERAL-----	74
J.	DETECTION DETERMINATION-----	81
K.	POTENTIAL ENHANCEMENTS-----	82
VI.	DIRECT FIRE ENGAGEMENTS-----	87
	A. GENERAL-----	87
	B. DIRECT FIRE ENGAGEMENT RULES-----	87
	1. Mission Costs-----	88
	2. Deliberate and Return Fire-----	88
	3. Restrictions on Number of Missions-----	89
	4. Observation-----	89
	C. PLAYER REQUESTS FOR DIRECT FIRE MISSIONS-----	90
	D. ASSESSMENT OF DIRECT FIRE RESULTS-----	92
	E. DETERMINATION OF CASUALTIES-----	95
	F. CALCULATION OF ARMORED CASUALTIES-----	95
	G. CALCULATION OF PERSONNEL CASUALTIES-----	103
VII.	MOVEMENT PHASE-----	108
	A. GENERAL-----	108
	B. OVERVIEW OF THE MOVEMENT PHASE-----	109



C.	TIME-SEQUENCING OF MOVEMENTS-----	111
D.	MOVEMENT EXECUTION-----	114
E.	DETECTION-----	114
F.	IMMEDIATE FIRE MISSIONS-----	118
G.	CLOSE ASSAULTS-----	119
H.	PLANNING PHASE SUBROUTINES-----	119
VIII.	CONCLUSIONS AND RECOMMENDATIONS-----	126
A.	SUMMARY-----	126
B.	CONCLUSIONS AND RECOMMENDATIONS-----	126
APPENDIX A	- GLOSSARY OF SYMBOLS-----	128
APPENDIX B	- DATA BASE ORGANIZATION-----	129
LIST OF REFERENCES	-----	134
INITIAL DISTRIBUTION LIST	-----	136



LIST OF TABLES

Table No.

IV.1	ARTILLERY RESPONSE CAPABILITY CONTRIBUTION-----	41
IV.2	MISSION RESPONSE FACTORS FOR INDIRECT FIRES-----	42
IV.3	INTENSITY OF FIRE INDEX VALUES, I-----	51
IV.4	TARGET SIZE INDEX VALUES, T-----	51
IV.5	DESCRIPTIONS OF EFFECTS INDEXES-----	57
V.1	PEGASUS MAXIMUM OBSERVATION DISTANCES-----	61
VI.1	WEAPON SYSTEM INTENSITY FACTORS FOR DIRECT FIRE ENGAGEMENTS-----	104



LIST OF FIGURES

Figure No.

III.1	RELATIONSHIP OF GAME TURN SUBROUTINES-----	33
IV.1	FLOWCHART FOR ARTILLERY FIRE SUPPORT REQUESTS SUBROUTINE-----	44
IV.2	EXAMPLE OF PEGASUS INDIRECT FIRE COMBAT RESULTS TABLE-----	49
IV.3	EXAMPLE OF CONSOLIDATED KIA COMBAT RESULTS TABLE-----	49
IV.4	EXAMPLE OF FORMULA DERIVED KIA COMBAT RESULTS-----	49
IV.5	FLOWCHART OF INDIRECT FIRE RESULTS SUBROUTINE-----	53
IV.6	FLOWCHART OF INDIRECT FIRE RESULTS (ARMORED TARGETS) SUBROUTINE-----	54
IV.7	FLOWCHART OF INDIRECT FIRE RESULTS (TROOPS IN DEFENSE) SUBROUTINE-----	55
IV.8	FLOWCHART OF INDIRECT FIRE RESULTS (TROOPS IN OFFENSE) SUBROUTINE-----	56
IV.9	FLOWCHART OF PROCEDURES TO REFLECT SUPPRESSIVE EFFECTS-----	59
V.1	GEOMETRIC PROPERTIES OF THE PEGASUS HEXAGON-----	65
V.2	QUADRANT PATTERN OF ADJACENT HEXES-----	68
V.3	LOCUS OF LINES OF SLOPE $\leq .5$ EXITING HEXAGON-----	68
V.4	LOCUS OF LINES OF SLOPE $> .5$ EXITING HEXAGON-----	68
V.5	FLOWCHART FOR DETERMINING LINE PATH THROUGH ADJACENT HEXES-----	70
V.6	PROJECTION OF LINE-OF-SIGHT ONTO Z-PLANE----	72



V.7	Z-PLANE LINE-OF-SIGHT VS. OBSCURING ELEVATION PROJECTIONS-----	75
V.8	LINE-OF-SIGHT HEX CHECKING PROCEDURE-----	76
V.9	FLOWCHART OF LINE-OF-SIGHT DETERMINATION SUBROUTINE-----	78
V.10	FLOWCHART OF DETECTION SUBROUTINE-----	83
VI.1	FLOWCHART OF IMMEDIATE DIRECT FIRE REQUEST SUBROUTINE-----	91
VI.2	FLOWCHART OF PLANNED DIRECT FIRE REQUEST SUBROUTINE-----	93
VI.3	FLOWCHART OF DIRECT FIRE RESULTS SUB- ROUTINE-----	98
VI.4	CUMMULATIVE PROBABILITY DISTRIBUTION FUNCTION-----	99
VI.5	FLOWCHART OF DIRECT FIRE RESULTS (ARMORED TARGETS) SUBROUTINE-----	100
VI.6	FLOWCHART OF ARMORED CASUALTIES CALCULATION SUBROUTINE-----	102
VI.7	FLOWCHART OF DIRECT FIRE RESULTS (TROOP TARGETS) SUBROUTINE-----	105
VI.8	EXAMPLE OF DIRECT FIRE COMBAT RESULTS TABLE-----	107
VI.9	EXAMPLE OF CONSOLIDATED KIA COMBAT RESULTS TABLE-----	107
VI.10	EXAMPLE OF FORMULA DERIVED KIA COMBAT RESULTS TABLE-----	107
VII.1	FLOWCHART OF MOVEMENT PHASE SUBROUTINE-----	110
VII.2	FLOWCHART OF MOVE SEQUENCING SUBROUTINE-----	112
VII.3	FLOWCHART OF MOVEMENT EXECUTION SUB- ROUTINE-----	115
VII.4	FLOWCHART OF MOVEMENT COSTS SUBROUTINE-----	117
VII.5	FLOWCHART OF IMMEDIATE INDIRECT FIRE MISSION SUBROUTINE-----	120
VII.6	FLOWCHART OF CLOSE ASSAULT SUBROUTINE-----	121



VII.7 FLOWCHART OF PLANNING PHASE SUBROUTINE----- 124



I. INTRODUCTION

Few of mankind's undertakings compare with war for its complexity, intensity, or total commitment of men and material. Nothing has stimulated more effort, thought, ingenuity, and resourcefulness than such ventures. The dedication of this effort has created the uniquely diverse and technically sophisticated fighting systems that now comprise modern conventional forces. These technology-based developments are dramatically changing the nature of the battlefield. Heretofore our ground combat operations have been characterized by massive amounts of firepower in search of targets. "Reconnaissance by fire" and artillery "harassment and interdiction" have become standard U.S. tactics. But now the modern battlefield promises to be alive with targets. Sophisticated, specialized radars, laser sights, electro-optical seekers, aerial reconnaissance drones and other recent developments have conspired to reverse the traditional tactical problem; rather than too few targets, there may now be too many - too many, at least, to be easily processed by existing battlefield decision-making.

The requirements for a command-control-information system to support and effect the management of the modern, automated battlefield will be significantly different from solutions that have been successful in the past. Clearly,



the commanders perception of the battlefield will be uniquely different. Within the context of command and control, the commander must be supported by a battlefield information system which will provide him with competent key information in a responsive time frame. The concern then becomes: what is the key information? What is that information which when appropriately digested and synthesized, correctly contributes to the commanders perception of the battlefield and enhances his decision-making capabilities?

Any viable discussion of key information required in combat must have its genesis in an even more basic question: what are the key decision-making processes required to conduct and sustain combat operations? Amid the turmoil and chaos that characterizes the battlefield there must exist a structure of information transactions to support these decision-making processes. If the collective structure can be ascertained and understood, the value and character of decision-supporting information, of key-information, can be more clearly defined.

It is the premise of this thesis that an understanding of the collective structure of combat decision-making processes may be achieved by study of existing manual war games. Accordingly, this thesis analyzes in depth the Army's PEGASUS war game, a manual, free-play, battle simulation which productively exercises brigade and battalion commanders and their staffs in the command and control of combined arms operations. The analysis develops in detail the event

sequenced logic which comprises the battle simulation, and structures it to serve as the framework for the programming of an interactive, computer-supported, battalion level war game. The war game is designed for 2 opposing players, rather than the 35-40 players required in the PEGASUS manual mode, and accordingly significant filtering of information is required in order not to overwhelm the decision-maker.

This report begins with a chapter providing a general description of the objectives and procedures of the manual PEGASUS war game. An overview of the analysis effort is then presented, discussing those parameters and procedures germane to an understanding of the computer-supported war game, and providing the context within which the detailed discussions which follow relate. PEGASUS is an intricately structured war game, dependent upon the application of specific game rules and controller interactions to generate the battle simulation. It is precisely this structure which makes the game adaptable to the objectives of this thesis effort. The reduction of this structure to computer programming logic is presented in detailed discussions of indirect fire, target acquisition, direct fire and movement simulations. The relevance of the developed framework to future study efforts is examined, and appropriate recommendations are offered in the concluding chapter.

II. THE PEGASUS MANUAL WAR GAME

A. GENERAL

The PEGASUS battle simulation is a free-play, manual war game which exercises brigade and/or battalion commanders and their staffs in the command and control of combined arms operations. By simulating real-time events, PEGASUS serves as a unique training vehicle and tactical laboratory; it provides commanders and their staffs an opportunity to work together under the time constraints and stresses of real life battle situations, against a thinking and competent adversary. Accordingly it is utilized to support the Army Training and Evaluation Program (ARTEP) at the Battalion and Brigade levels, in order to evaluate the strengths and weaknesses of a unit's procedures and training.

B. PEGASUS CONCEPT AND ORGANIZATION

Real time multi-echelon operations are an important feature of the PEGASUS war game. The rules and sequence of play are designed to conform to time/distance factors assumed for the modern battlefield. Therefore the command groups are required to act and react with real-time decisions and orders, and accordingly, a realistic stress environment is created.



There are two groups of participants required to conduct PEGASUS: a player group and a control group.

1. Players

The players plan and execute the exercise. As the command group they set up a command and control system, plan the tactical mission, prepare maps, orders, and overlays, and issue orders. They interact with one another, and fight the battle. There is no prescribed organization for the player group; it consists of those individuals normally constituting the command group of the tactical operations center of the brigade and/or battalions during combat operations. Their roles are played as they would be in any real situation; they need not be familiar with the simulation procedures.

2. Control Group

The control group prepares and controls the exercise. There are three categories of control personnel:

a. Controllers

Controllers have overall supervisory responsibilities for the conduct and evaluation of the exercise. They represent the higher and adjacent units with which the players may communicate during the exercise, providing reports, requirements and information representative of that generated in a combat environment. These individuals are

neutral and have the primary responsibility for maintaining the pace and efficient flow of the exercise.

b. Functional Controllers

Functional controllers support areas of special or amplified play. There are required functional controllers dedicated to areas such as indirect fire support and intelligence, and optional controllers in areas such as administration/logistics, engineering, or chemical/nuclear warfare. The optional controllers are not required unless their functional area is included in the scope of the exercise.

c. Player-Controllers

These are the individuals who provide the interface or link between the simulation and the players. They are "players" in the sense that they are part of either the friendly or opposing side, and must exercise tactical judgement and respond to tactical decisions that support their side. They are "controllers" in that they must translate tactical decisions into simulation procedures governed by the rules of play for movement and the rules for the conduct of appropriate engagements. Player-controllers perform duties essentially paralleling unit assignments, such as unit controllers (company commanders) and forward observers.

The total number of controllers required depends on the scenario and the scope of the exercise. A battalion level war game requires approximately 20 controllers, while a brigade exercise may require more than 65 controllers.

C. THE PEGASUS EXERCISE

The exercise is initiated when the players (command groups) are briefed on a particular scenerio by the controllers, given an appropriate mission, and are required to plan the execution of the mission. During the exercise the players operate from a tactical operations center (generally in the field), and the controllers work in facilities near, but not co-located with, the player group. Organic tactical communications equipments are used to facilitate communications between the players and the controllers, and are employed to realistically represent those equipments and communication networks that would be used in combat. Utilizing this communications capability, the players communicate freely with the controllers during the game play. Decisions are made and directives and orders are issued by the players. The controllers then simulate the operation in real-time on a specially designed control board in accordance with a set of rules for fire and maneuver, and assess the results of each conflict phase. Information and data from each resulting interaction, as appropriate, are then fed back to the players as the battle unfolds. Using this updated status information, the players interactively modify their orders and dynamically direct the battle, and the controllers appropriately execute the operations and report the outcomes. Since the rules and sequence of play are designed to conform to time and distance factors, the players are forced to react in real-time, thereby creating a decision-stress

environment similar to that of actual battle. Since the PEGASUS war game is a free-play exercise, it realistically portrays the uncertainty of battle. The relative success of the opposing forces, therefore, will depend principally on the actions of the respective players; the command groups will influence the outcome of the battle in direct accordance with their ability to make responsive and tactically sound decisions.

The PEGASUS battle simulation can support a command post exercise of approximately eight hours in length. Longer exercises are possible, but would require additional controllers for relief. The system can be tailored to amplify play in several functional areas, such as air defense, electronic warfare, and engineer operations, and can be adapted to any terrain for which 1:12,500 scale maps can be fabricated.

D. CONTROL BOARD

The PEGASUS control board is the playing surface on which the simulation is conducted. It is composed of 12 sections (each 2 feet by 3 feet) which, together, form a control board measuring 6 feet by 12 feet. The control board is actually a reproduction of a standard 1:50,000 topographic map enlarged to a scale of 1:12,500 and printed on sheets of polyester. Its most unique feature is a hexagonal grid, superimposed on and corresponding to the Military Grid Reference System of the map. Hexes are used

in lieu of squares because it permits more realistic movement of units - six directions rather than four - which results in a more accurate time-distance portrayal of movement. Movement is regulated by terrain effects, and the movement costs associated with each hex depends on the predominant terrain feature within the hex. Unit "playing pieces" or "counters," with the standard military symbol of the unit to help identify it, are used to represent each unit on the control board. It should be emphasized that the players do not have access to the control board, and in fact develop their plans and operations using standard 1:50,000 topographic maps. The control board is used exclusively by the controllers to systematically effect the movement of units and to assist in the resolution of conflicts.

E. GENERAL SEQUENCE OF PLAY

Play of the war game is divided into 12 minute turns during which the controllers and players of each side move and fight their units. Since each game turn represents a 12 minute "slice" of the battle, allocation of indirect fire, conduct of direct fire, and movement are all designed to be representative of the pace of combat expected on the battlefield. Resolution of these various aspects of combat is simplified by executing each game turn in a specified and

orderly sequence. Each game turn is divided into the following phases and each phase is normally resolved in the following order:

1. Indirect Fire Phase

Requests for indirect fire can be initiated anytime during a game turn; however, to provide for the realistic time lag that normally occurs between the request and the receipt of fire, the results are resolved only during the indirect fire phase of the next game turn. Indirect fire support includes not only artillery support, but also close air support and attack helicopter missions.

2. Direct Fire Phase

Requests for direct fire are planned at the end of each game turn to be executed and the results resolved during this phase. Execution of direct fire missions are conditioned upon the target unit being within range of the firing unit, as well as being in line-of-sight of the firing unit.

3. Movement Phase

Movement is a complex and important aspect of the simulation. Each unit begins each turn of game play with an allowance of 12 movement minutes, which can be expended in several ways (including movement and direct fire). Terrain characteristics dictate those corresponding costs associated

with actual movement. However, movement can also reveal units and trigger direct fire. Effects of direct fire in this phase are assessed immediately, and requests for return fire missions can be made and again are immediately executed and resolved (assuming the firing unit has sufficient movement minutes available to absorb the cost of the mission). This is the dynamic and interactive phase of the simulation for the controllers. When the desired objectives are reached, or a unit has exhausted its movement allowance, or movement is interrupted by opposing forces actions, the movement phase is completed.

There are a series of basic rules for PEGASUS which are used to simulate the basic fire and maneuver functions of the tactical units within each of these phases. They specify the effects of terrain, the rules for observation and movement, the employment of direct and indirect fire, and the conduct of close assaults. The rules are extensive, and have applicability to the potential activities of all type maneuver units in the U.S. Army organization, contributing to a potentially comprehensive and realistic battle simulation.

F. CONFLICT RESOLUTION - THE COMBAT RESULTS TABLES

Conflict resolution is probabilistically determined by use of a series of PEGASUS Combat Results Tables. The tables have been developed for the full range of combat weapon systems and generalized target categories. They are structured to provide the losses resulting from specific

weapon system/target engagements, while appropriately considering the modifying effects of range, target disposition, target size, etc. Figure IV.2 reproduces the indirect fire combat results tables for the U.S. vs. dismounted troops in the offense. Casualties are determined by first searching the table for the appropriate firing mission criteria (artillery round caliber and intensity of fire), and finding the intersection of that row with the target (squad, platoon, company) column. A die roll is used to select which of the corresponding 6 possible outcomes will apply for the engagement. There are 60 such tables for resolving just the artillery indirect fire support and direct fire missions, and accordingly the majority of the controller's time is spent rolling a die and looking up tables for resolution of each engagement!

G. APPLICABILITY OF PEGASUS TO COMPUTER SIMULATION

The description provided of the PEGASUS battle simulation in the previous pages is too general in its overview to give a full appreciation for the comprehensive and flexibility of its structure. The war game productively exercises full battalion and brigade level staffs in their attempt to plan and conduct operations against a thinking and purposeful opponent; and its free play nature realistically portrays the uncertainty, and hence the frustration, of battle.



PEGASUS at first appears to be a complex exercise. It is an intricately structured war game, dependent upon the application of specific game rules and controller interactions to generate the battle simulation. But it is precisely this structure which makes this game adaptable to the objectives of this thesis effort. The reduction of any game to computer assisted play requires that events be logically sequenced and time-stepped. Accordingly, the structure of the PEGASUS game is uniquely compatible with this programming requirement. Further, even in the manual mode, the game provides operationally significant detail within acceptable user turn-around times; accordingly the reducing of the controller conflict resolution responsibilities to computer calculations offers the potential for increased responsiveness.

Most importantly, the PEGASUS war game provides meaningful representations of the battlefield situation, interactions, and events. Accordingly, if the game can be successfully reduced to computer-assisted play, it offers the potential to assist players in gaining valid, non-trivial insights into the complex operational problems that comprise the battlefield. Further, the structure of the manual war game is such that it is capable of being tailored to incorporate new weapon systems and new sensors into the game. This flexibility and growth potential is a particularly interesting aspect of the game.



III. SIMULATION DESCRIPTION

A. GENERAL

Models tend to be as simple and concise as our knowledge of the activity warrants. The Army has used 'models' of military operations, specifically manual war games and field exercises, for many years; their purposes have been to enhance training, test plans, and achieve insight into the complexities of battle. With the development of high-speed computers came the ability to play war games more rapidly and to include much more detail. At the same time (and no doubt in part due to this improved capability), there was an increased awareness of the need to examine new weapons in a "combined arms" context, in a complete battle environment rather than in isolation. The purpose of gaming and simulation therefore tended to broaden from training objectives to comparison of alternative forces and major weapon systems. More significantly, it changed from a relatively simple and "visible" aid to judgement, to an esoteric, complicated, and transparent producer of battle outcomes, rigidly constrained by automated procedures.

The manual PEGASUS game represents the Army's commitment to reverse this trend, to maintain a capability to play free war games in which imaginative military players can gain insight by 'experiencing' land warfare and exercising the

tactical employment of forces. The significance of the game, for academic purposes, is that it creates a neutral "playing field" upon which the battle simulation takes place. This feature must be emphasized; just as a chess-board can accommodate a wide range of player skills (from novice to master), so can the manual PEGASUS war game accommodate varying levels of sophistication and complexity, and hence player skills. The purpose of this chapter is to discuss the level of sophistication contemplated for this neutral, computer-assisted simulation, and to provide an overview of the game procedures that effect it.

B. BATTALION-LEVEL PLAY

The reduction of a manual war game which productively exercises full brigade and battalion staffs down to a computer-assisted game involving two players is a nontrivial task. The multi-echelon decision-making requirements in a brigade scenario does not lend itself to simple reduction to one player decisions. At the battalion level, however, the situation is perceptively different. The scope of command for a battalion commander extends down to the platoon as the basic maneuver unit, and it is at the platoon level that the majority of the PEGASUS simulation is exercised. Further, assuming that a player would exercise tactical prudence by maintaining a significant reserve capability (both at the battalion and company level), the number of forward line maneuver units appears to be within a players



intellectual ability to control. Play at the battalion level also requires a significantly smaller maneuver or playing area, a realistic consideration that influences the amount of effort involved in establishing a computer terrain characterization of the battle area.

Even at the battalion level there exists multi-echelon and multi-dimensional decision-making that contributes to the effectiveness of a maneuver unit in combat, and it is unrealistic to consider that all this decision-making expertise would be resident in one player (that of the battalion commander). Accordingly, there has been a conscious effort to make as much of the detail of the PEGASUS war game transparent to the player as possible, allowing him to concentrate his intellectual skills in massing his firepower and maneuver elements, vice being distracted by some of the more mundane (though important) considerations of combat (i.e., ammunition constraints, artillery weapons selection, etc.). The constraints on the commanders resources and capabilities represent important tactical considerations, and therefore extensively exist within the transparent structure of the simulation; they do not, however, represent considerations that must be constantly placed before the battalion commander to allow him to effectively exercise command.

The PEGASUS war game owes its complexity in part to its flexible design, which allows for almost all combat functions to be simulated. Minefields, chemical/nuclear warfare,

engineer operations, air defense, and other "functional" capabilities can be exercised in the manual game. Incorporation of procedures to exercise these functional areas has not been attempted in the computer-assisted simulation, as they introduce a level of management complexity inconsistent with the overall objectives of the simulation. Similarly, considerations such as night operations, use of smoke, and air and helicopter support, all of which would increase the realism associated with game play, have not been incorporated into the simulation procedures because of the complex rules associated with their play.

C. ROLE OF THE PLAYER

It is not the intent of this effort to get intensely involved in the substantive issues of modeling and simulation techniques. Nor is there an explicit desire to make the simulation a forum for improving the tactical sophistication of the players. The objective is to involve the players, as adversary commanders, in a conflict on a neutral and realistically representative battlefield. The players, irrespective of their skill levels, must maneuver their forces to complete their scenerio-defined mission. Their skill at interpreting the battlefield information available to them should enhance their game play. The level of battlefield information available to the players will be essentially consistent with the information sensors played.

As enhancements are overlaid the basic procedures, the information available to the players can be modified to reflect increased sensors, and corresponding subjective judgements can be made regarding the utility of this information in the decision-making considerations of the players.

D. THE GAME ENVIRONMENT

The envisioned, fully-developed simulation contemplates the extensive use of graphical computer support. The opportunity to display battlefield information graphically represents a significant command and control enhancement. Players could visually observe the dynamics of the battlefield, and could achieve an increased perception of the conflict development. Within this environment, the variety and detail of battlefield information can be uniquely presented and its value subjectively determined. The development of a fully-integrated, graphically-supported computer war game, however, is an ambitious undertaking beyond the scope of this work. Accordingly the current effort must first emphasize creation of a structurally sound simulation framework.

The logic development of the simulation presented in this paper is designed to support a war game involving two players, each positioned with a computer console and a 1:12,500 scale military topographic map of the battlefield (superimposed with a hexagonal grid). The players must



manually transfer the information received from the computer to their maps, and then transmit their tactical orders to the computer through the console (prompting is provided to direct the necessary input requirements). The computer will only provide a narrowly determined and standardized battlefield status report; this report provides sufficient information with which to intelligently continue the battle while maintaining a tempo-of-operations consistent with a time-stressed environment. Reports of visual contacts of enemy units will reach the players, and they will have to decide, based on their assessment of the situation, whether or not to engage these targets of opportunity. The players will have complete freedom to maneuver their units and employ their combat power at their discretion, consistent with realistic terrain and weapon system limitations. Each player is engaged against a thinking, mission-oriented, and combat-capable adversary, and the element of risk is pervasively maintained throughout the game. Enhancements to the game play will concentrate on providing that battlefield information the players believe will minimize their risk level.

E. THE GAME FLOW

The game flow utilizes the concept of the 12-minute game turn of the manual PEGASUS simulation. Each game turn consists of an indirect fire phase, direct fire phase and movement phase. The character of this structure, however,



is significantly different from the manual PEGASUS game in the respect that the two fire phases are completely executed and resolved by the computer, rather than by a large number of controllers. Embedded in the movement phase are the intricate and dynamic interactions of target acquisition and immediate engagement, as well as the "planning" phase for indirect fire support and continuation of direct fires for the next game turn.

Figure III.1 provides a schematic of the relationship of the logic routines developed to support this game flow. Since each game turn represents a 12-minute portion of the battle, the allocation of indirect fires, conduct of direct fires and movement are all designed to be representative of the pace of combat expected on the battlefield. Resolution of these various aspects of combat is simplified by executing each game turn in the specified and orderly sequence of subroutines as shown; an overview of each of the subroutines follows:

1. Indirect Fire Results Subroutine

This subroutine assesses the casualty and suppressive effects of each executed artillery support fire mission on the targeted unit. The effects of artillery fire are a function not only of the intensity of fire brought to bear on a target, but on the disposition and type of target. Accordingly, embedded in this routine are subroutines devoted



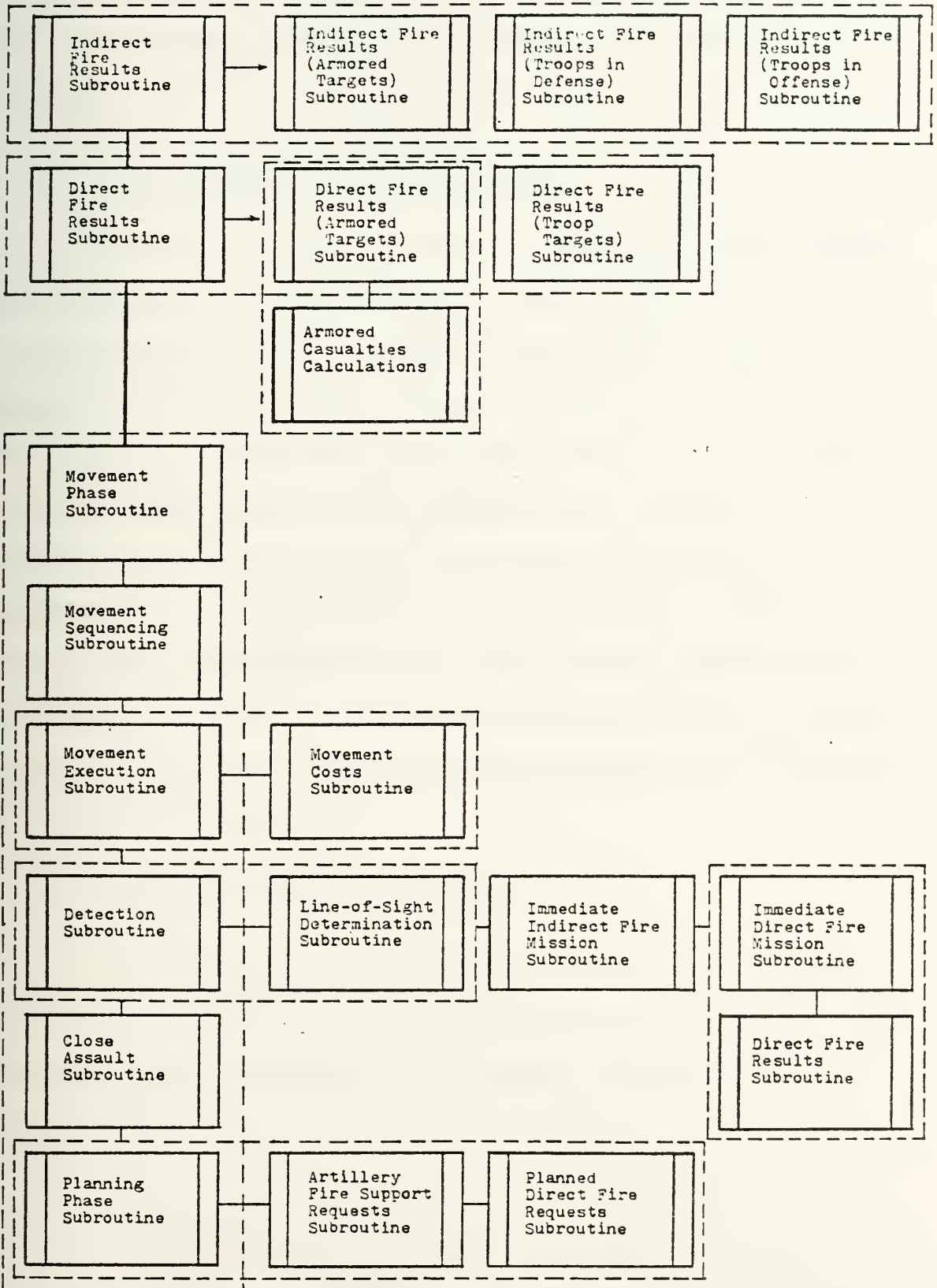

FIGURE III.1 RELATIONSHIP OF GAME TURN SUBROUTINES

to assessing conflict results on the target categories of armored vehicles, troops in the offense, and troops in the defense.

2. Direct Fire Results Subroutine

Implicit in the execution of the direct fire engagement procedures is the assumption that a unit will attack a target with its most appropriate and potent weapon. For example, an infantry unit equipped with an antitank missile will use the missile when attacking a tank, but will use its antipersonnel weapons when engaging troop targets. In this regard embedded subroutines have been developed for casualty assessments of two general target categories: armored targets and dismounted troops. The casualty assessments of armored targets utilizes cumulative probability distributions, based on uncoordinated attack assumptions, developed in a special subroutine.

3. Movement Phase Subroutine

It is within the movement phase that the players dynamically interact with the computer and each other. The movement phase processes the following categories of subroutines:

a. Movement Execution Subroutines

Subroutines have been developed to prioritize the sequential movement of units (an effort to approximate the simultaneous nature of events on the battlefield), as

well as to execute planned movements consistent with the mobility constraints imposed by terrain characteristics on maneuver units. In this regard, each unit begins each turn with an allowance of 12 movement minutes; these movement minutes can be expended in several ways, principally in movement, but also in direct fire operations. The cost in movement minutes to move into an adjacent hex is a function of the type of unit and the principal terrain characteristic of that hex.

b. Target Detection Subroutines

Movement of any unit in the combat simulation changes its detection probabilities relative to opposing force units. The objective of this subroutine is twofold; to determine if the moving unit has detected opposing forces, and to determine if the moving unit has been detected by opposing forces. Key to these objectives is the determination of line-of-sight between the units.

c. Immediate Fire Subroutines

Immediate exploitation of targets of opportunity detected in the movement phase can be accomplished by the organic direct fire assets of the observing unit, or by the company's 81mm mortar platoon. Accordingly, subroutines have been developed to provide for this capability. For purposes of the simulation there are two types of direct fire: deliberate fire and return fire. Direct fire missions increase the probability of the firing unit being detected, and generate the dynamic and interactive engagements of this phase.

d. Close Assault Subroutine

Whereas direct fires are conducted at range, close assaults are representative of close combat engagements. Significant casualties result from these intense engagements, and the attrition proportions are a probabilistic function of the fire power ratios associated with the corresponding attacker/defender. The close assault subroutine shows that a probabilistic advantage accrues to the attacker, on the average, when the attacker-to-defender fire power ratios exceed 2:1.

e. Planning Phase Subroutines

When all movements are exhausted and close assaults resolved, the players then program their indirect fires utilizing the artillery capabilities supporting the battalion. If enemy forces are still observable, planned deliberate direct fire missions can be scheduled. Most importantly, the movements for each maneuver unit are programmed at this time, for execution during the next game turn. This is the most time-consuming portion of the simulation; however extensive computer prompting with time-clock constraints on providing input will cause each player to consider and execute his options in realistic time-frames.

F. SUBROUTINE DESIGN

The subroutines are designed to facilitate programming efforts by follow-on studies, and major considerations have been made and algorithms developed to simplify potential

programming efforts. Particular emphasis has been placed on developing the detailed logic for line-of-sight determinations and for generating results of conflict engagements. The levels of sophistication in these solutions are relatively primitive, however they adequately satisfy the objectives of the simulation.

Appendix A provides a glossary of the flowcharting symbols used in the logic diagrams of each subroutine.

G. DATA BASE INPUT

Appendix B defines all the variables identified by the subroutines presented in the following chapters. Of significant concern is the development and input of representative terrain information, to include the average elevation of principal terrain characteristic of each hexagon. A battalion level scenerio involving armored forces can be exercised in a corridor 8 km's wide and 30 km's long. However, this involves inputting elevation and terrain information for 6000 hexes, an effort that is not particularly motivating. Accordingly, it will be desirable for the terrain over which iterations of the war game is played to be a separate, standardized input. Characteristics of the adversary forces, including unit types, weapon mixes, and unit strengths, may be easily adjusted for each game play.

H. DATA BASE ORGANIZATION

In order to fully understand the logic presented in the subroutine flowcharts to be presented, it is necessary that the author's view of the data base organization be understood. The actual organization to be utilized if the program were to be executed would be dependent not only on the computer hardware and software systems available, but also on the judgement of the actual programmer.

The data used in the subroutines essentially fit into three categories; unit-related, hex-related, and program-related. The program-related variables involve look-up tables, switches and counting mechanisms that are procedural in nature and contribute to the programming effort. Hex-related data refers primarily to the large table that characterizes the terrain of the battlefield. The only entrance to this table is the coordinates of each hex. Accordingly, if it were desired to determine which hexes were wooded, it would be necessary to test each hex in the data base. It is important to understand that the location of units, that is, a test of the occupancy of each hex, cannot be accomplished utilizing this hex-related table. The location of units, as well as all capability, disposition, and vulnerability data, are accessible through tables organized with the unit code as the primary link. Accordingly, when the logic of a routine requires that a specific hex be tested for occupancy, the appropriate unit-location table

is sequentially searched, with only the unit positions in the table compared to the hex-coordinates in question. If the specific unit is known, its location (and all other unit-related data) can be directly accessed in the data base via the unit code link.

I. CHANGE-OF-STATE PROCEDURES

The data base of the war game is predictably dynamic. The movement of units and the resolution of conflict engagements require many bookkeeping considerations in order to correctly characterize the state of the battle.

The principal mechanism for introducing constraints on units is through the time relationship of the game turn. Since each game turn represents a "time-slice" of the battle, the allocation of indirect fires, direct fires and control of movement are all designed to be limited by game turn allowances. Accordingly, the changes in the state of variables associated with unit capabilities fall into 2 categories: those associated with the game turn (such as movement minutes, effects index, and artillery response capability), which return to an initial value at the beginning of each game turn; and those associated with the overall game play (such as unit strength and location) which are dynamically modified during the game turn, but are directly carried to each succeeding game turn. Similarly, data items associated with pending fire missions are directly transferred in the data base to the next game turn.

IV. INDIRECT FIRE ENGAGEMENTS

A. GENERAL

The processes involved for conduct of successful artillery support of combat operations are multi-dimensional and complex; however, the effective utilization of this dimension of combat power will greatly influence the outcome of any engagement. Accordingly it is necessary that the indirect fire support processes incorporated in the model be representative of existing military capabilities and constraints, and that the war game players have sufficient information and latitude to exercise this capability to enhance their combat effectiveness. This objective is clearly constrained by the parallel objective to make as much of the combat process as transparent to the player as possible, while still maintaining a time-constraining stress environment.

B. EMPLOYMENT OF INDIRECT FIRES

Prior to commencement of game play, it is necessary to input into the data base an artillery "response capability" for both adversaries participating in the exercise. This response capability is a numerical value which represents the maximum capability for artillery fires to support each side each game turn. The maximum sustained-rate-of-fire of each artillery weapon has served as the basis for determining

this response capability, and accordingly it is reflective of both the 12 minute per turn time-constraint and the real-world employment constraint.

The total response capability available to each side is based on the artillery organization for combat generated in the supporting game scenerio. Field artillery is organized for combat by the assignment of one of the four standard tactical missions (direct support, reinforcing, general support-reinforcing, general support) to each artillery battalion. The support relationship represented by these mission assignments is from artillery battalion to combat brigade (or regimental) units. Accordingly each maneuver battalion within a brigade will normally have available to it only a portion of the fire power of the supporting artillery unit, as noted in Table IV.1.

TABLE IV.1

ARTILLERY RESPONSE CAPABILITY CONTRIBUTIONS

<u>Artillery Mission</u>	<u>Response Capability Contribution</u>	
	<u>PEGASUS</u>	<u>Simulation</u>
Direct Support	12	2
*Direct Support, Priority of Fires	30	5
Reinforcing	12	2
General Support - Reinforcing	9	1.5
General Support	9	1.5
4.2 inch Mortars	8	1.5

* If the maneuver battalion has priority of fire, the direct support artillery battalion contributes larger value (30 vice 12, or 5 vice 2) to the response capability.



Table IV.1 also includes a contribution in response capability by the maneuver battalions' 4.2 inch mortar platoon. Accordingly a maneuver battalion in a Brigade sized unit supported by one direct support artillery battalion, one reinforcing artillery battalion, and two battalions in general support, would have a response capability of 7 contributed by these units (2 + 2 + 1.5 + 1.5). By adding the maneuver battalions' 4.2" mortar capability, its total response capability becomes 8.5.

The number of fire missions available to a player during each game turn therefore is constrained by the organization for combat of the artillery, and will vary based on the number of volleys, or intensity, associated with each fire mission he requests. The "cost" of each mission is shown in Table IV.2. The "cost" of each mission fired is subtracted from the artillery response capability until the response capability has been expended or until all requests for fire have been satisfied. It is noted that unexpended portions of this response capability cannot be carried over to subsequent turns.

TABLE IV.2

MISSION RESPONSE FACTORS FOR INDIRECT FIRES

<u>Intensity of Fire</u>	<u>Mission "Cost"</u>
Light	1
Moderate	2
Heavy	3
Intense	4



C. PLAYER INPUT REQUIREMENTS

As outlined above, the indirect artillery support available to each player has been generalized to simplify its use while still providing the "commander" control over these assets. No fire support mission will be fired unless it is initiated by the players. The players input their indirect fire support requests at the end of each game turn in accordance with the prompting directions provided by the computer terminal. The player is asked if he requires any indirect fire support; a positive answer then generates computer queries requesting the target hex coordinates and the intensity of fire power desired to be brought to bear at the target location. Figure IV.1 charts the interactive nature of the indirect fire support input. Note that the requests made in this subroutine will be executed at the beginning of the subsequent game turn, and that the results of these fires can modify the planned movement and direct fire capabilities of the opposing player, as well as cause casualties.

D. ASSESSMENT OF INDIRECT FIRE RESULTS

The procedures for assessing indirect fire results are based on simplifying assumptions relative to the combat results tables of the PEGASUS manual game. There are separate indirect fire combat results tables for U.S. and opposing forces, and the tables are further identified by



Artillery
Fire Support
Requests
Subroutine

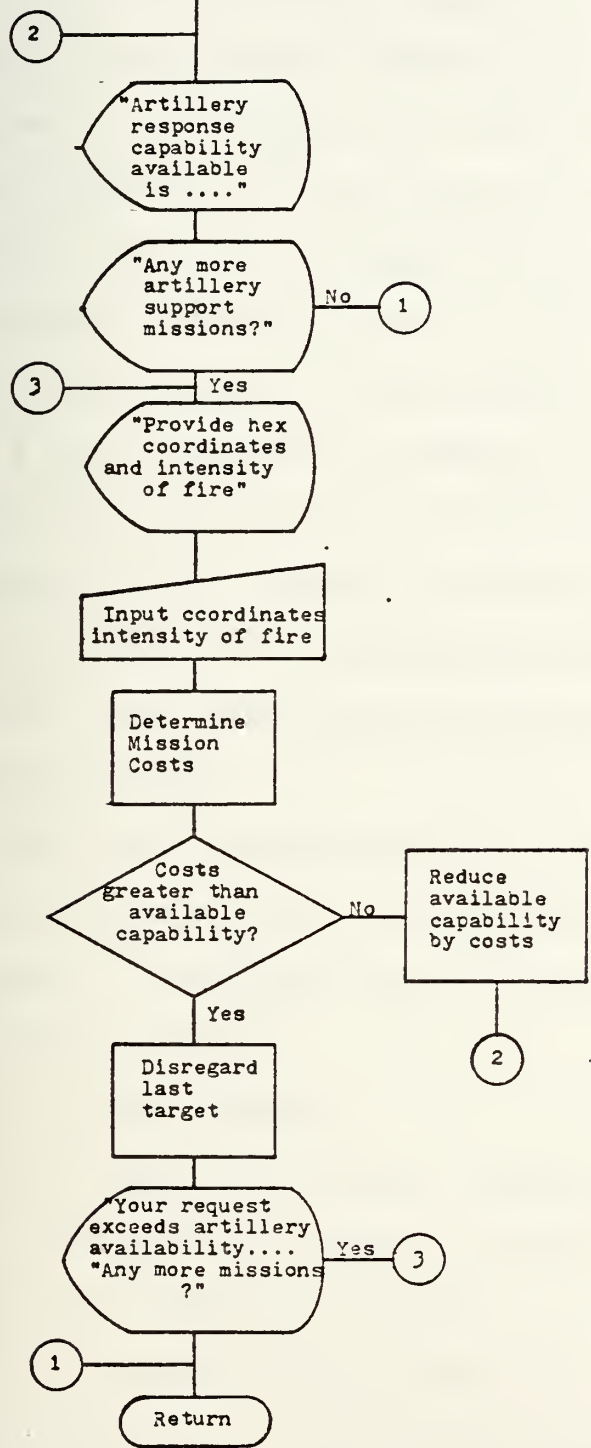

This subroutine details the procedures for requesting indirect artillery fire support missions.

The artillery response capability available prior to assigning another fire mission is reported. Initially this value will represent the total response capability, as defined by the supporting artillery battalion missions. As fire requests are generated, the response capability will be appropriately reduced.

Intensity of fire input:
 1 = Light
 2 = Moderate
 3 = Heavy
 4 = Intense

Mission costs are a function of the intensity of fire of the mission. Costs associated with each intensity are found in Table IV.2.

If costs exceed the available response capability, the mission request cannot be executed during the next game turn.

Artillery availability, although exceeded in this request, might still be sufficient to support a lower "cost" (intensity of fire) mission.

FIGURE IV.1 FLOWCHART FOR ARTILLERY FIRE SUPPORT REQUESTS SUBROUTINE

target category. Figure IV.2 reproduces the results table for the U.S. vs. dismounted troops in the offense. Casualties are determined by first searching for the table with the appropriate artillery round caliber (i.e., 155 mm, 175 mm, 105 mm); once finding the correct table, the intensity of fire requested for the mission and the size of the target (squad, platoon, or company) will determine which box within the matrix applies. There are six digits in each block, each corresponding to the results of a die roll. Accordingly, for a 155 mm mission of moderate intensity against a platoon sized unit, a die roll of 5 would determine results of 1 killed-in-action (KIA), 5 wounded-in-action (WIA), and an effects index of 3 (the effects indexes will be described shortly; they range from no effect (1), to complete disruption (4)).

There are separate tables for the U.S. and opposing forces, and the tables are further identified by target category. The PEGASUS game utilizes five target categories for indirect fires:

1. Armor targets
2. Dismounted troops - defense
3. Dismounted troops - offense
4. Fire Support Systems
5. Troops in Rear Areas

Superimposed upon these target categories are separate results tables based on groupings of artillery calibers - an average of 3 tables per target category, and a resulting

total of approximately 30 different tables to search for combat results. The intricacies involved in attempting to develop algorithms to duplicate just one of these tables is sufficiently frustrating to encourage the search for simplifying assumptions. The following assumptions have been made:

1. Reduction of Target Categories

The scope of the interactive war game is essentially limited to maneuver elements of the combat forces. In order to minimize the decision processes the player must concentrate on to fight the battle, the movement of fire support systems has been made transparent (assumed to be doctrinally consistent with the movement of maneuver elements). Considerations relating to troops in rear areas have been assumed to be a concern of the Brigade echelons of command, and accordingly are not played at the Battalion level to which this simulation is addressed. In view of these considerations it is consistent to exclude "fire support systems" and "troops in rear areas" from the list of target categories.

2. Consolidation of Tables

A review of Figure IV.2 provides a number of insights that can be generalized for all of the indirect fire combat results tables. First, it is noted that the effects index is not a function of caliber, but rather of intensity of fire. Clearly this is consistent with the

realities of combat; an infantryman is not concerned with the caliber of an incoming round - he will seek cover and protection directly in accordance with the intensity of fire, the number of rounds per minute, that land in his vicinity, and his movement and firepower will be proportionately suppressed. Second, when corresponding row/column blocks are compared between the two tables, it is noted that the range of casualties are essentially equivalent, and that only the probability distribution of casualties appears to be influenced by the increase in caliber. Accordingly, with both casualties and effects more heavily influenced by intensity of fire rather than by caliber of rounds utilized, the consolidation of these tables appears prudent and reasonable, as little loss in generality occurs.

3. Casualty Considerations

Since the war game as currently envisioned does not play evacuation processes for WIA's, nor does it play the administration/logistics considerations of personnel and equipment replacements, there is no utility for keeping bookkeeping notes on WIA's. Clearly, however, there is an inverse relationship between the number of men wounded in a unit and the unit's combat power. Since loss of manpower (KIA's) also reduces combat power, the conversion of WIA's was converted to equivalent KIA's on a 2 for 1 basis. The resulting equivalent KIA's were added to the actual KIA



totals, and casualty tables now expressed in only KIA totals were developed. Figure IV.3 was developed using this approach on the 155 mm results table depicted in figure IV.2. These resulting tables then served as the basis for regression analysis efforts to generate algorithms for determining personnel casualties.

E. CASUALTY TABLE RELATIONSHIPS

An analysis of the PEGASUS personnel casualty tables provides useful observations. As would reasonably be expected given a specific level of intensity of fire, casualties increased as the size of the target increased (from squad to platoon to company sized targets). However, this increase was not proportional to the actual increase in size of the target. Whereas the proportional size of a squad:platoon:company is 1:3:9, the proportional casualty increases are approximately 1:2:4 (as found in the PEGASUS tables). This apparent inconsistency is easily explained: as the size of the unit increases, the area within which it is dispersed increases; accordingly, if the same number of rounds are used in a mission against these targets, its area of coverage must either be increased (resulting in a lower intensity of fire per unit area, and hence lower probability of kill); or if its area of coverage is not increased, a proportion of the larger target is not threatened, resulting in proportionately fewer kills. Within this context, the 1:2:4 relationship is understandable and of utility.



US vs DISMOUNTED TROOPS IN OFFENSE

SHELL	CALIBER	INTENSITY OF FIRE		SQD	PLT	CO	EFFECTS INDEX		
H E	81MM 4.2 IN 105MM	LIGHT	KIA	000 000	000 011	001 111	111 112		
			WIA	000 111	011 112	111 234			
		MODERATE	KIA	000 001	000 111	011 112	112 334		
			WIA	001 121	111 134	123 457			
		HEAVY	KIA	000 111	011 112	111 123	223 344		
			WIA	111 122	234 568	355 6 8 12			
		INTENSE	KIA	000 112	111 122	112 233	333 444		
			WIA	111 223	345 679	667 8 10 11			
		H E	155 175 8 IN	LIGHT	KIA	000 001	000 011	001 111	111 112
					WIA	000 111	111 112	123 345	
				MODERATE	KIA	000 001	001 111	111 122	112 334
					WIA	011 122	112 455	345 678	
HEAVY	KIA			000 011	011 112	112 222	223 344		
	WIA			111 123	123 467	346 789			
INTENSE	KIA			000 112	111 222	122 233	333 444		
	WIA			112 234	245 789	567 9 11 13			

FIGURE IV.2

SHELL	CALIBER	INTENSITY OF FIRES		SQD	PLT	CO
H E	155MM 175MM 8 IN	LIGHT		000011	001122	012334
		MODERATE		000112	012334	233456
		HEAVY		001122	122345	235567
		INTENSE		011223	234566	356789

FIGURE IV.3

SHELL	CALIBER	INTENSITY OF FIRES		SQD	PLT	CO
H E	155MM 175MM 8 IN	LIGHT		000000	000111	011223
		MODERATE		001111	111222	233445
		HEAVY		011122	122334	455667
		INTENSE		011223	233445	677899

FIGURE IV.4



Similarly, as the intensity of fire on equal sized targets increases, casualties are expected to increase. This is in fact observed in the PEGASUS results tables. As the level of intensity of fire is increased from light to medium to heavy to intense, casualties proportionally increase approximately in the ratio 1:2:3:4, respectively, (Referring back to Table IV.2., the mission costs for increasing levels of intensity also increased in the same 1:2:3:4 ration. This similarity in ratios is a useful property which can be exploited when developing computer coding).

F. CASUALTY ALGORITHM

The logic governing how casualties will increase as the intensity of fire increases and as the number of personnel in the target area increases has been quantified in the previous discussion. These relationships were exploited in the development of a generalized personnel casualty algorithm.

The tables constructed based on the procedures in paragraph IV.D.3 were analyzed, and it was noted that the mean KIA value in any casualty distribution grouping (associated with the outcome of a possible die roll could be approximated by the product of the intensity of fire and the size of the target. Using an index for intensity of fire of 1:2:3:4 to describe the relationship between light:moderate:heavy:intense, and an index for target unit size of 1:2:3 for the

squad:platoon:company relationship, the mean KIA value against dismounted troops in the offense is approximated by:

$$\overline{\text{KIA}}(I,T) = 0.5 \times I \times T \quad (\text{IV-1})$$

where

I = intensity of fire index

T = target size index

The associated index values are found in Tables IV.3 and IV.4.

TABLE IV.3 INTENSITY OF FIRE INDEX VALUES, I

<u>Intensity of Fire</u>	<u>Index Values</u>
Light	1
Moderate	2
Heavy	3
Intense	4

TABLE IV.4 TARGET SIZE INDEX VALUES, T

<u>Target Size</u>	<u>Index Values</u>
Squad	1
Platoon	2
Company	3

Extending this relationship to other weapon systems and to other target dispositions (troops in defense) requires a modifier to each of these indexes; the relationship then becomes:

$$\overline{\text{KIA}}(I,T) = 0.5 \times k_I \times I \times k_T \times T \quad (\text{IV-2})$$

where

k_I = weapons system intensity factor

k_T = target disposition factor

For purposes of this discussion, $k_I = 1.0$ for artillery fires, and k_T takes the value of 1.0 for troops in the offense, or 0.5 for troops in the defense. Further development of these factors is found in paragraph VI.4, where they are applied to generalize direct fire casualty results.

Equation IV-2 only describes the average number of KIA's expected for each weapon-target pairing. In order to provide for an appropriate range of stochastic outcomes, a uniform distribution was assumed, and the following relationships were determined:

$$X = 0.5(k_I I + k_T T)(R - .5) + \overline{KIA}(I, T) \quad (IV-3)$$

where

$$R = \text{uniformly distributed random number } (0 < R \leq 1)$$

and

$$\overline{KIA}(I, T, R) = \begin{cases} X & \text{when } X > 0 \\ 0 & \text{when } X \leq 0 \end{cases} \quad (IV-4)$$

In equation IV-3, the $(k_I I + k_T T)/2$ term represents the relative range of values that X can assume around the mean value \overline{KIA} . Equations IV-3 and IV-4, used in conjunction with integer rounding properties available in computer calculations, provides for casualty distributions that adequately attrited infantry forces within the context of the envisioned interactive war game. Figure IV-4 is an example of the results obtained using the algorithm. The relationships are clearly approximate, and although useful in their presented form, can easily be further refined if desired. The overall procedure utilized for determining indirect fire casualties is flowcharted in Figures IV.5 - IV.8.

Indirect Fire Results Subroutine

This subroutine assesses the casualty and suppressive effects of each executed indirect artillery support fire mission.

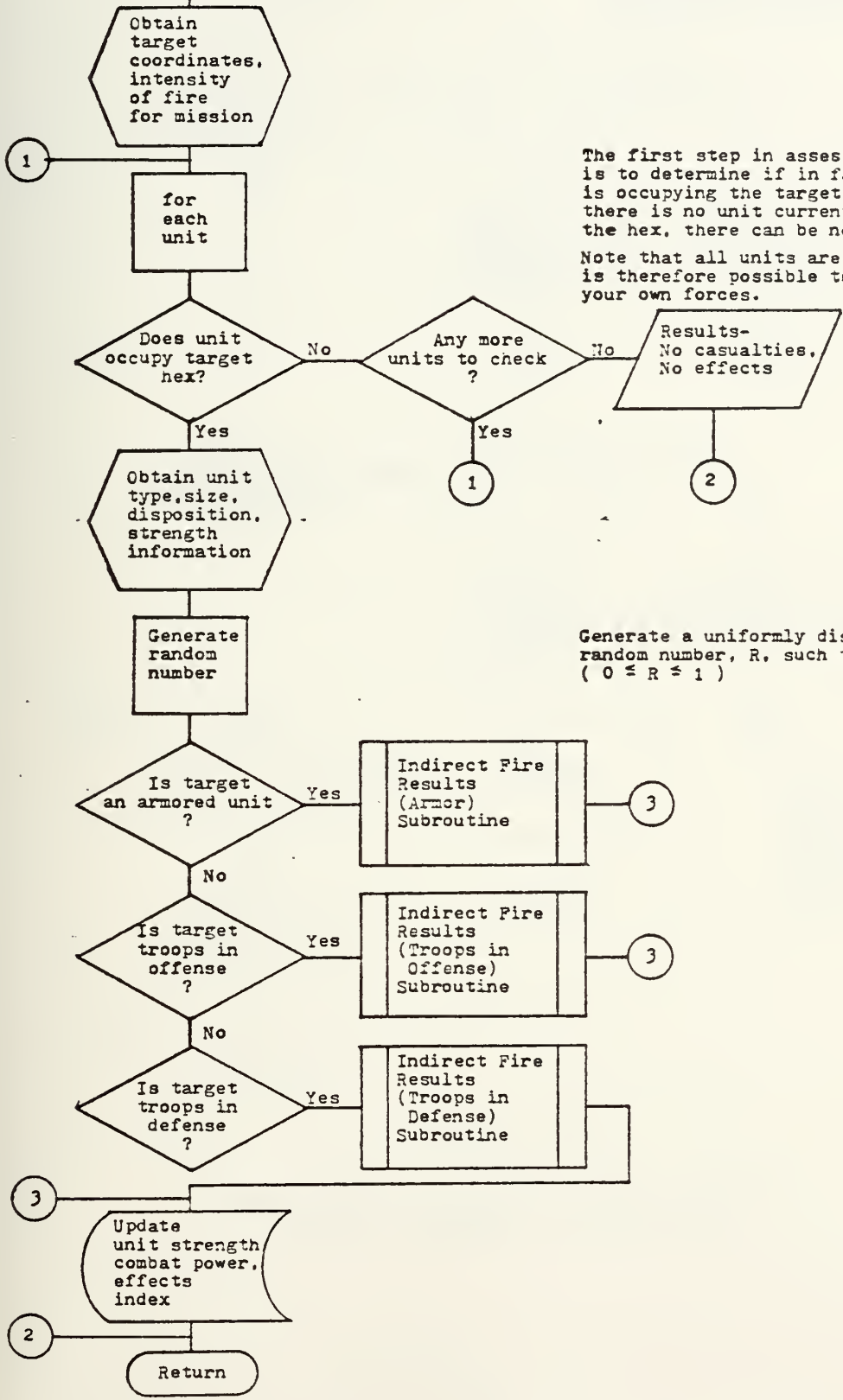

The first step in assessing results is to determine if in fact a unit is occupying the target hex; if there is no unit currently occupying the hex, there can be no casualties. Note that all units are checked. It is therefore possible to fire on your own forces.

Generate a uniformly distributed random number, R, such that $(0 \leq R \leq 1)$

FIGURE IV.5 FLOWCHART OF INDIRECT FIRE RESULTS SUBROUTINE

Indirect Fire Results (Armor) Subroutine

This subroutine assesses the effects of indirect artillery fire upon armored targets.

The category "armored" includes tanks and armored personnel carriers.

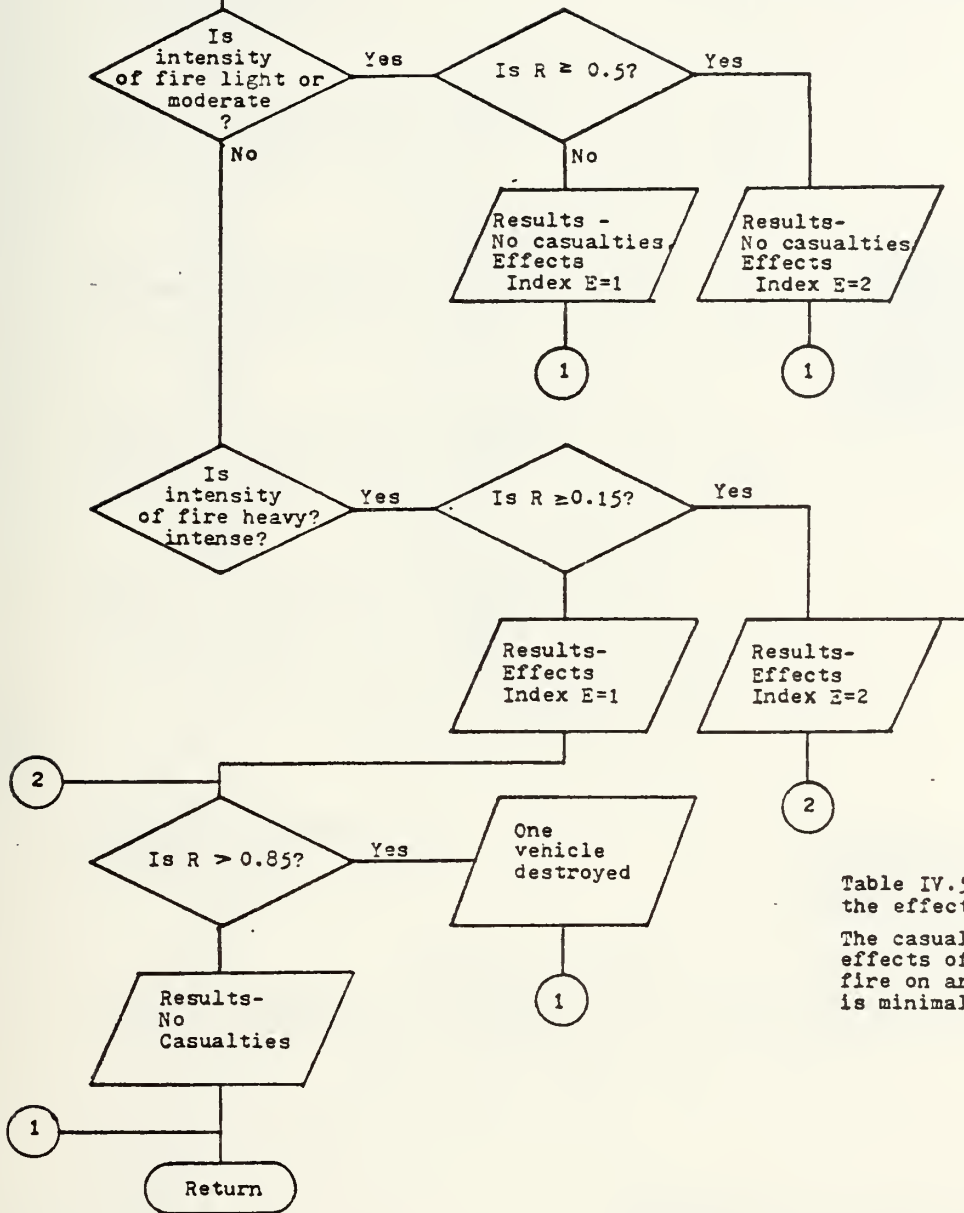

Table IV.5 describes the effects indexes. The casualty producing effects of indirect fire on armored targets is minimal.

FIGURE IV.6

FLOWCHART OF INDIRECT FIRE RESULTS (ARMOR TARGETS) SUBROUTINE

Indirect Fire Results
(Troops in Defense)
Subroutine

This subroutine assesses the casualty and suppressive effects of indirect artillery fire upon troops in the defense.

A unit is considered in a defensive posture if it did not move in the previous game turn.

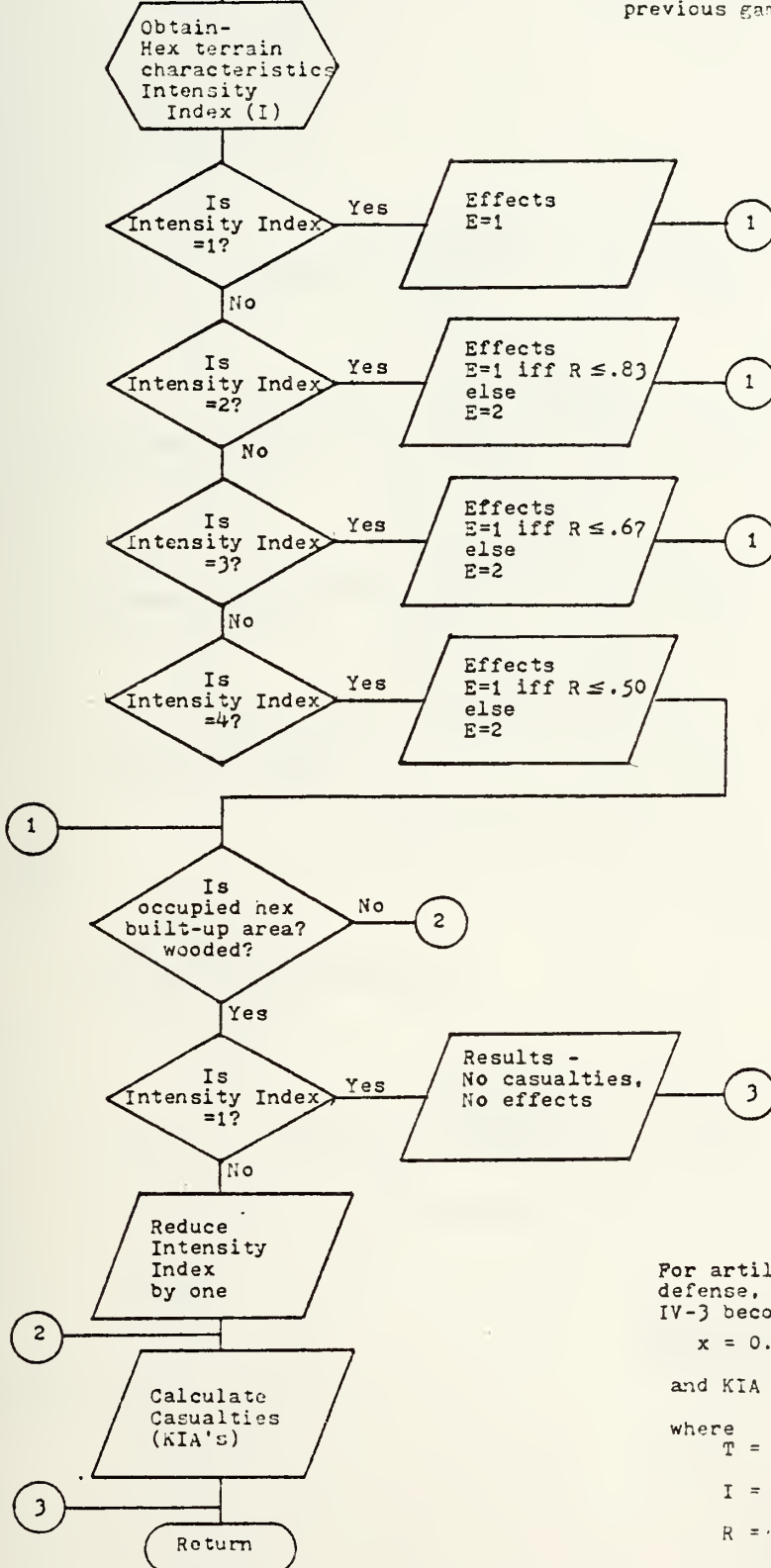

E is defined as the Effects Index; see Table IV.5 for descriptions.
R is defined as a uniformly distributed random number, such that
($0 \leq R \leq 1$)

A position in a "covering" hex reduces the casualty effects of an artillery mission (but not the suppression effects).

For a mission of light intensity into a covered hex there will be no effects.

For artillery fire against troops in defense, $k_d=1.0$, $k_T=0.5$, and equation IV-3 becomes:

$$x = 0.5(I+.5T)(R-.5) + 0.25IT$$

$$\text{and KIA} = \begin{cases} x & \text{when } x > 0 \\ 0 & \text{when } x \leq 0 \end{cases}$$

where

T = Target Size Index of unit; see Table IV.4.

I = Intensity Index of fire mission; see Table IV.3.

R = Random number ($0 \leq R \leq 1$)

FIGURE IV.7

FLOWCHART OF INDIRECT FIRE RESULTS (TROOPS IN DEFENSE) SUBROUTINE

Indirect Fire Results
(Troops in
Offense)
Subroutine

This subroutine assesses the casualty and suppressive effects of indirect artillery fire upon troops in the offense.

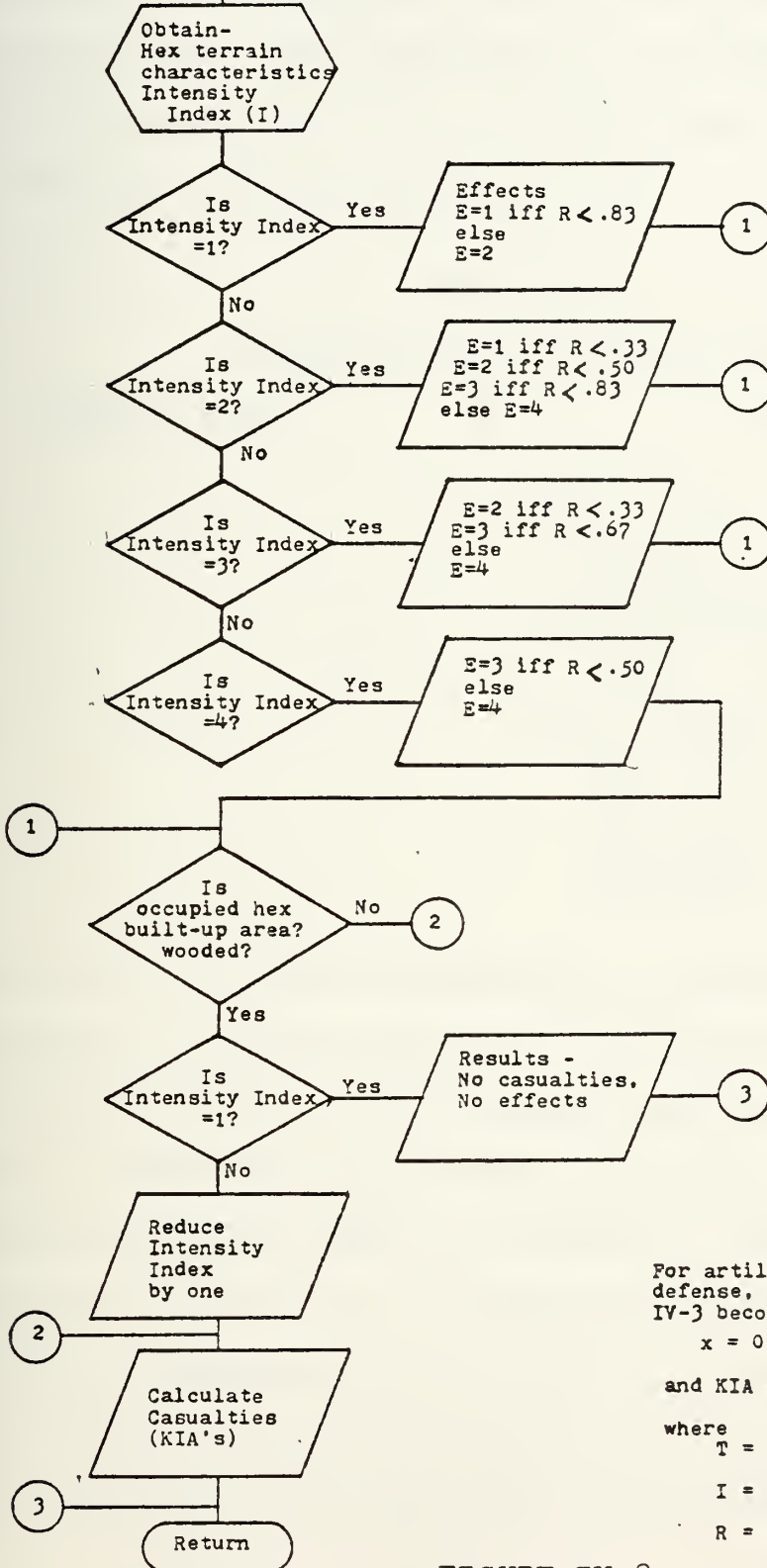

E is defined as the Effects Index; see Table IV.5 for descriptions.
R is defined as a uniformly distributed random number, such that
(0 ≤ R ≤ 1)

A position in a "covering" hex reduces the casualty effects of an artillery mission (but not the suppression effects).

For a mission of light intensity into a covered hex there will be no effects.

For artillery fire against troops in defense, $k_d=1.0$, $k_T=1.0$, and equation IV-3 becomes:

$$x = 0.5(I+T)(R-0.5) + 0.5 IT$$

$$\text{and KIA} = \begin{cases} x & \text{when } x > 0 \\ 0 & \text{when } x \leq 0 \end{cases}$$

where

T = Target Size Index of unit; see Table IV.4.

I = Intensity Index of fire mission; see Table IV.3.

R = Random number (0 ≤ R ≤ 1)

FIGURE IV.8

FLOWCHART FOR INDIRECT FIRE RESULTS (TROOPS IN OFFENSE) SUBROUTINE

G. SUPPRESSION EFFECTS

In addition to creating casualties, indirect artillery fires will also degrade a units combat power and movement capabilities. This degradation is accounted for in the PEGASUS game by use of an "effects index." The effects indexes are defined in Table IV.5.

TABLE IV.5

DESCRIPTIONS OF EFFECTS INDEXES

<u>Effects Index</u>	<u>Description</u>
1	No Effect
2	Combat power degraded 50% for balance of turn
3	Combat power and movement degraded 50% for balance of turn
4	Unit is disrupted; it may not move nor conduct direct fire for the balance of turn; its close assault factor is decreased by 75% for the remainder of turn.

The extent of a units suppression is directly related to the intensity of fire of the artillery mission. The more intense the fire mission, the more severe the probability of suppression. Similarly, a unit which has established a defensive posture would not suffer the degree of suppressive effects accorded to a unit in an offensive posture. These considerations are appropriately accounted for in the determination of effects as depicted in Figures IV.5 - IV-8. It is noted that the threshold values used in determining applicable

effects indexes are those utilized in the related PEGASUS combat results tables.

The results of the effects on the targeted unit is best explained by an example. An effects index of three, as described in Table IV-5, specifies that the targeted unit's combat power and movement are reduced by 50% for the balance of the turn. Accordingly, the results of any of the targeted units direct fires are reduced by one-half, the units close assault factor is reduced by one-half, and only six movement minutes are available to the unit for that turn.

Figure IV.9 provides a flowchart of the procedures utilized to change a unit's capabilities when it has been suppressed by fire during a game turn. These procedures are followed in each instance when the subroutines indicate that the "effects index" is to be updated.

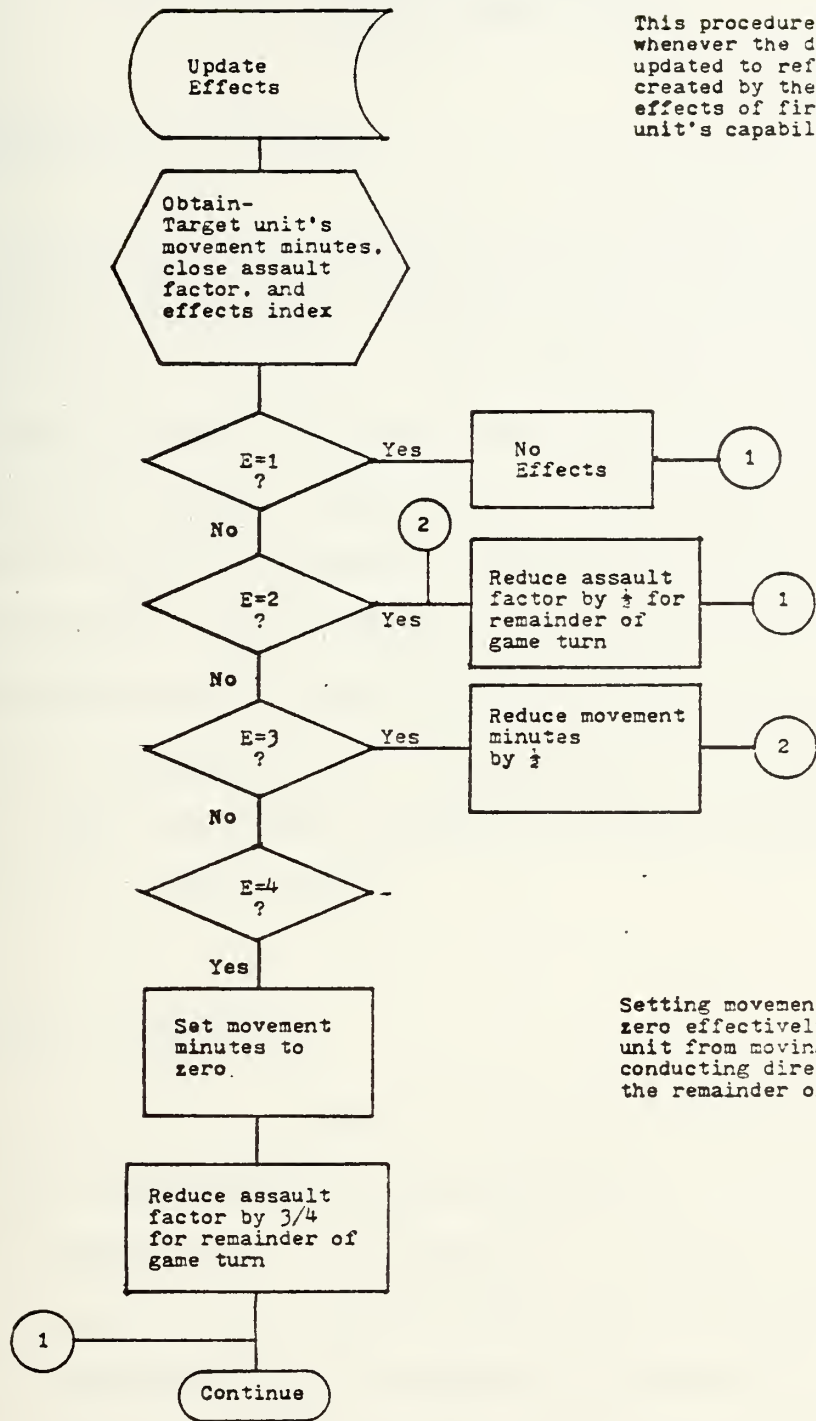

This procedure is followed whenever the data base is updated to reflect changes created by the suppressive effects of fire upon a unit's capabilities.

Setting movement minutes to zero effectively restricts the unit from moving and from conducting direct fires for the remainder of the game turn.

FIGURE IV.9

FLOWCHART OF PROCEDURES TO REFLECT SUPPRESSIVE EFFECTS

V. TARGET ACQUISITION

A. GENERAL

It is through the simulation of time and space that the interaction of opposing forces and their environment can be accounted for. Germane to this interaction is the ability for opposing forces to detect each other, to execute surveillance and target acquisition. Surveillance and target acquisition have a pervasive influence on other aspects of combat models: they provide the basis upon which commanders make decisions about allocation of forces, about movement, and about firepower itself. Therefore, it is extremely important that observation probabilities be adequately represented in any combat model.

B. TARGET ACQUISITION

As previously discussed, the direct fire phase is dependent upon observation being established by the firing unit of the targeted unit. This ability to observe occurs only when a line-of-sight exists between the two units, and is further dependent upon the distance between the two units, the disposition of the opposing unit (i.e., moving, stationary), as well as appropriate terrain factors. The opportunity for visual contact is enhanced when the opposing unit is firing at you.

The PEGASUS game established maximum distances to which observation may exist, as shown in Table V.1:

TABLE V.1

PEGASUS MAXIMUM OBSERVATION DISTANCES

<u>Status of Observing Unit</u>	<u>Disposition of Observed Unit</u>	
	<u>Stationary</u>	<u>Moving</u>
Dismounted	1000 m	2000 m
Mounted	2000 m	4000 m

These distances then represent the limiting conditions within which observation can occur. It must be emphasized at this point that these constraints are unique to the PEGASUS game, and that the maximum observation distances used in wargaming simulations is uniquely inconsistent in the literature. Irrespective of the lack of precision of the maximum distances of Table V.1, they adequately serve to establish an influence within the game play between the dynamics of the tactical situation (fire and maneuver) and the ability of a unit to obtain information (target acquisition).

C. LINE-OF-SIGHT PROBLEM FORMULATION

The ability to observe another unit visually only occurs when an uninterrupted line-of-sight exists between the two units. The problem can be easily defined: knowing the three dimensional location in space of each unit, project a line between the two points and test if any obscuring

elements in three dimensional space intercept the line. If there are no obscuring elements on the path, line-of-sight exists.

D. MODEL IMPLICATIONS

The ability to execute this test within the model assumptions and constraints is disarmingly nontrivial. Accordingly, a review of some of these restrictions and their implications is in order prior to a discussion of the line-of-sight algorithms.

1. Uniformity of Elevation in Hex

The input of the elevation of each hex in the data base is determined by averaging the actual elevations on the topographic map from within the particular hex. For example, the terrain on the side of uniformly sloping hill may vary in elevation within a hex from 200 meters at its highest point to 180 meters at its lowest. The average value of 190 meters would be input to represent the uniform elevation of the hex in the data base. Each hexagon would be defined with a single and uniform elevation.

2. Uniformity of Terrain Features

Those terrain features that dominate the terrain within a hexagon are assumed to characterize all of the hexagon. Each hex is characterized by only one terrain feature (cleared, wooded, built-up area, etc.) which is

appropriately input into the data base. This terrain characteristic is assumed, then, to exist uniformly throughout the hex. As an example, the topographic features of a standard hex may be partially wooded (25%), but the dominate feature is that of cleared terrain. The computer model will treat the hexagon as uniformly clear for all visibility and movement calculations.

3. The Irregular Hexagon

The PEGASUS control board superimposes a hexagon grid pattern over a standard military topographic map, and utilizes the hexes as the basic position identifying elements. It would be desirable, from a mathematical and analytic standpoint, that this be a regular hexagon grid system. However, this feature cannot be accomodated because of the requirement to conform to the existing military map grid-square geometry. To simplify location reporting, it is desirable that the center of each of the 25 hexes in a grid square be represented within the grid square by a pair of single digit numbers coinciding with their actual map coordinates. This cannot be achieved with a regular hexagon system; if the vertical distance between the centers of two regular hexagons is fixed at 200 meters, the horizontal balance between the centers of regular hexagons becomes $200\cos 30^\circ$ meters, vice 200 meters, and is clearly not compatible with a simple location reporting system.

Figure V.1 summarizes the properties of the PEGASUS hexagon utilized as the basic element in the computer simulation. It is noted in figure V.1 that the distance between the diagonal faces of the hexagon and its center is 110.94 meters, vice the 100 meters between the horizontal faces and the center. This information becomes useful in the line-of-sight determination, as will be explained further in the chapter. Figure V.1 provides information uniquely relevant to the development of line-of-sight algorithms. Attention is drawn to the fact that the slope of the line SY connecting the centers of 2 diagonally adjacent hexagons is defined by:

$$\tan = \frac{100}{200} = .500$$

The geometry of the hexagon then also dictates that the lines ABC and DEF also have this same slope. The importance of these factors will be developed shortly.

E. LINE-OF-SIGHT DETERMINATION

Since all units are assumed to be "concentrated" at the center of each hexagon, determination of line-of-sight between these units logically dictates that a straight line be drawn between the centers of those hexes representing their positions. All hexes in between these two points into which the projected line crosses must therefore be checked for obscuring properties. If no hexes are found to obscure this projected line, then line-of-sight exists;

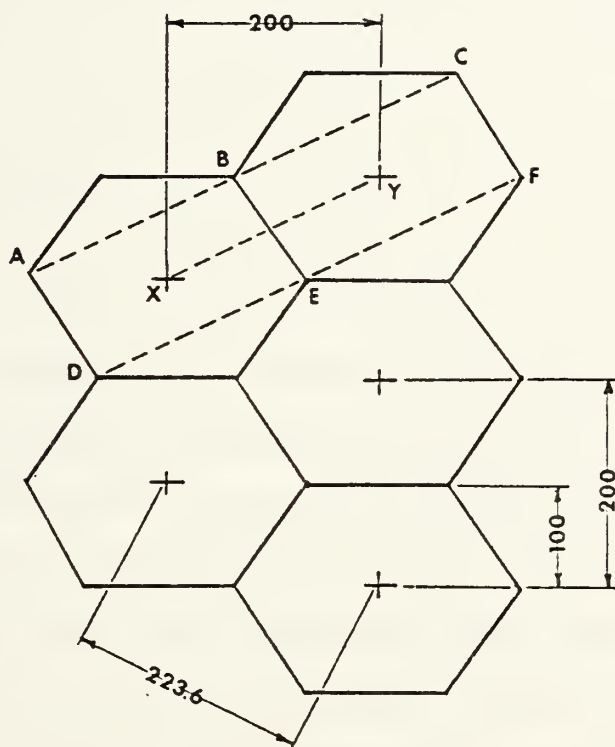
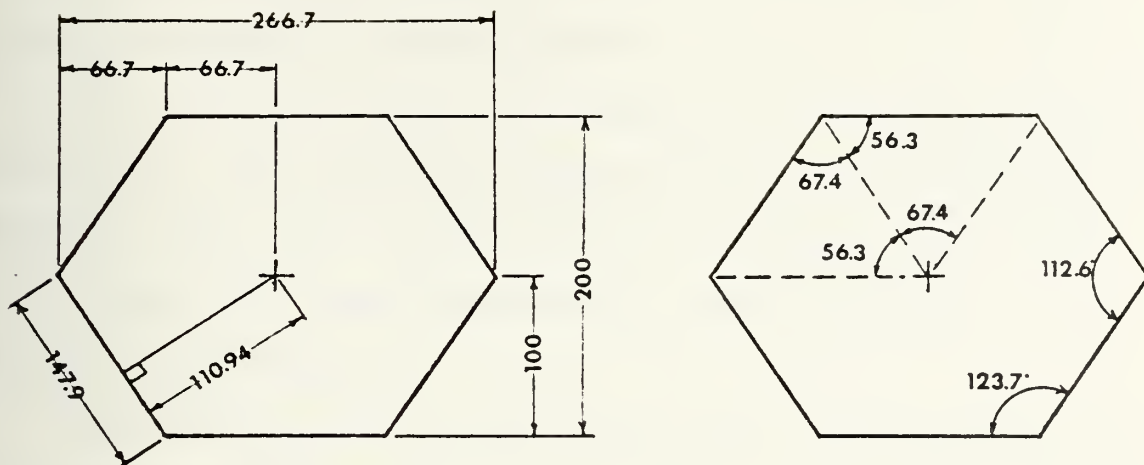

FIGURE V.1

GEOMETRIC PROPERTIES OF THE PEGASUS HEXAGON

conversely, if obscuration is found, line-of-sight, and hence observation, does not exist.

In a continuum where every point is represented in the data base, this checking procedure would be straightforward. However, with only one data point to represent the terrain for every 40,000 square meters (the area of a hex) the procedure is less direct.

The determination of which hexes are intercepted by the projected line between units is complicated by the irregularity of the hexagon element. The projected line can be easily defined by the equation of a straight line of the form:

$$y = mx + b \quad (V-1)$$

where

$$m = \frac{y_2 - y_1}{x_2 - x_1}$$

$$b = y_2 - mx_2$$

when (x_1, y_1) represent the hex grid coordinates of unit 1, and (x_2, y_2) represents the position of unit 2. Graphically, knowing the coordinates of position 1 and 2, it is a simple matter to connect the points with a line, to visually determine which hexes have been intercepted, and then to test these hexes for obscuring properties. From an analytical viewpoint the problem is more pronounced. When a line with a known slope = m passes through the center of a hex, it is a straightforward matter to determine the side, and hence the adjacent hex, which the line will intercept. However, if all that is known is the slope of the line, the problem

of determining where the line will exit, and hence which adjacent hex it will next intercept, confronts us. Whereas there are a variety of ways to approach this problem analytically, the procedure developed below has the advantages of being straightforward and mathematically uncomplicated.

It is first noted that the slope of a line and its directional properties (positive x-y, positive x-negative y, etc.) determines the quadrant pattern of adjacent hexes which must be checked along the path of the line. For example, a positive slope in the positive x-y direction dictates the set of the vertically and diagonally adjacent hexes that must always be checked, as shown in figure V.2.

Figures V.3 and V.4 display that quadrant pattern of adjacent hexes associated with a line with a positive slope in the positive X-Y direction. Hexes 1,2, and 3 are the only hexes into which a line so defined can enter upon leaving hex A. The shaded area of figure V.3 represents the loci of all possible lines of slope less than or equal to 0.5 which exit from hex A. The significant factor to observe is that all lines ($m \leq 0.5$) which enter hex 1 first must still intercept hex 2; further, there also exists a family of lines which enter hex 3 but do not intersect hex 2. Accordingly, it can be concluded that any line of slope ≤ 0.5 which did not enter hex 2 must always have entered hex 3.



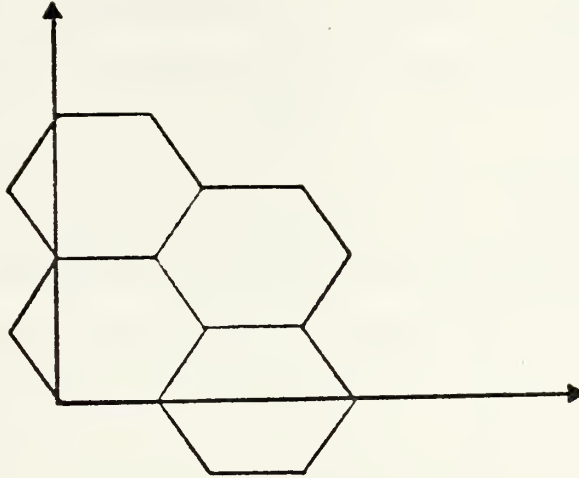

FIGURE V.2 QUADRANT PATTERN OF ADJACENT HEXES

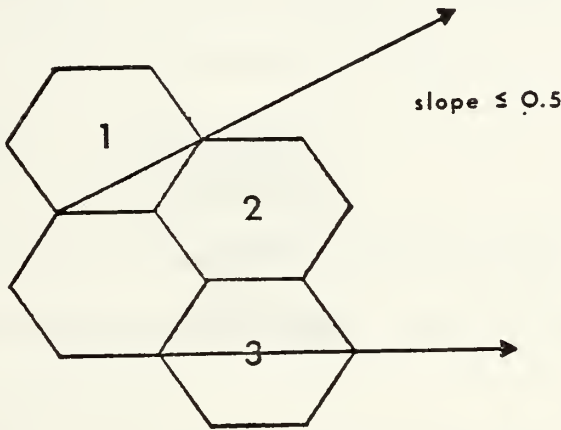

FIGURE V.3

LOCUS OF LINES OF SLOPE LESS THAN 0.5 EXITING HEXAGON

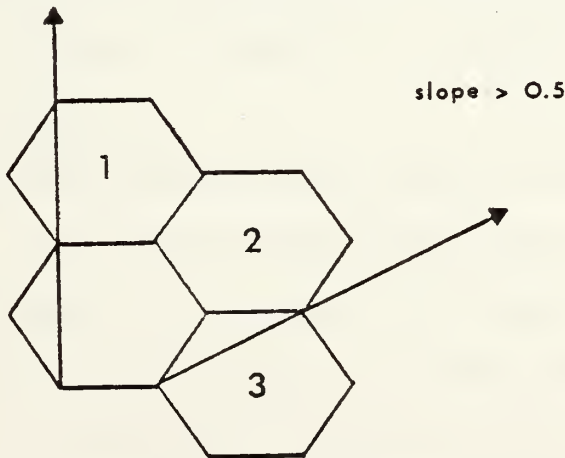

FIGURE V.4

LOCUS OF LINES OF SLOPE GREATER THAN 0.5 EXITING HEXAGON



Similarly, observation of figure V.4 shows that any line of slope >0.5 which did not enter hex 2 must have always entered hex 1.

A method to test whether or not a line has intercepted a hex is by the calculation of the perpendicular distance between the line and center of the hex. If it is within predetermined threshold values (dictated by the geometry of the hexagon) it can be concluded that the line has intercepted the hex.

The calculation of the distance between a point (x_1, y_1) and a line $y = mx + b$ is defined by the formula:

$$\text{distance} = \frac{mx_1 - y_1 + b}{m^2 + 1} \quad (\text{V-2})$$

Referring back to figure V.1, the threshold values to test against are determined to be 100 meters when $m \leq 0.5$, and 111 meters when $m > 0.5$.

Accordingly, the logic for determining which of the adjacent hexes a line exiting a hex will enter has evolved. The decision process is depicted in figure V.5, and is explained as follows:

1. Knowing the directional slope of the line determines the quadrant set of hexes which must always be checked.

2. The diagonally oriented hex (hex-2 in the example) is first checked to determine if it has been intercepted. If it was not intercepted, a test of the slope of the line dictates which adjacent hex was intercepted.



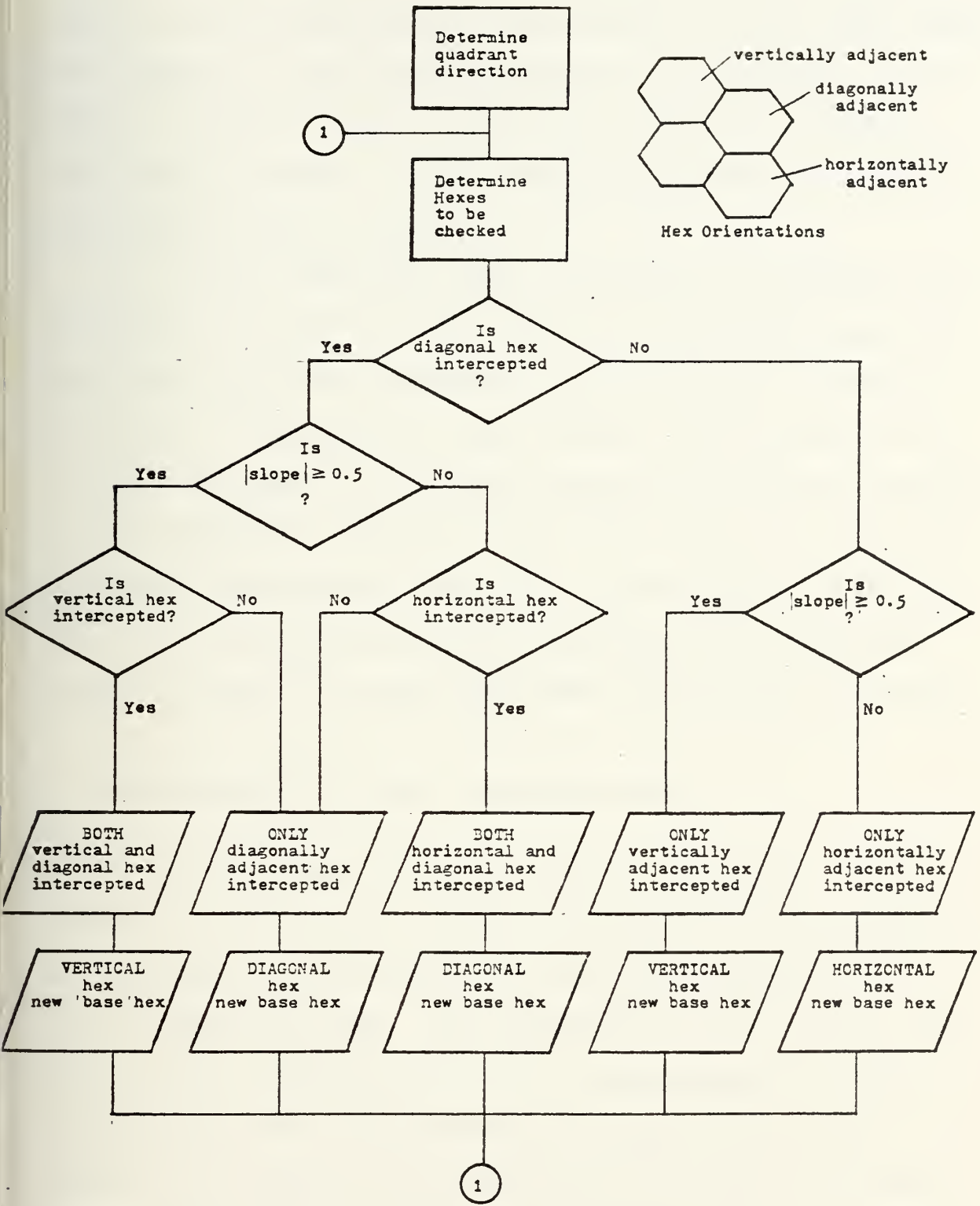

FIGURE V.5

FLOWCHART FOR DETERMINING LINE PATH THROUGH ADJACENT HEXES

3. The fact that the diagonally oriented hex was intercepted does not preclude its intercepting another hex. Again, the geometry of the situation governs the procedure: if the slope is greater than 0.5, only the vertically oriented hex need be checked; if less than 0.5 only the horizontally oriented hex must be checked.

4. If two hexes have been intercepted, it remains to be determined which of the pair the line exited from last (for that hex will be the reference hex for the next iteration of checks). The geometry again governs the decision: for a slope less than 0.5 the line intercepting both the horizontal and diagonally adjacent hexes will always exit from the diagonally adjacent hex last; for a slope greater than 0.5, the line intercepting both the diagonally and vertically adjacent hexes will always exit from the vertical hex last.

F. DETERMINATION IF HEX IS OBSCURING HEX

Upon determining that a hex is on the map path of the projected line-of-sight between two units, it is necessary to determine if the elevation of the hex intercepts the three-dimensional path. The mathematics of this effort is significantly simplified when the three-dimensional path is projected onto a two-dimensional plane, as shown in figure V.6. Based on the map direction of the line (slope greater than 0.5) it may be more convenient to work in the YZ plane vice the XZ plane, and accordingly after this

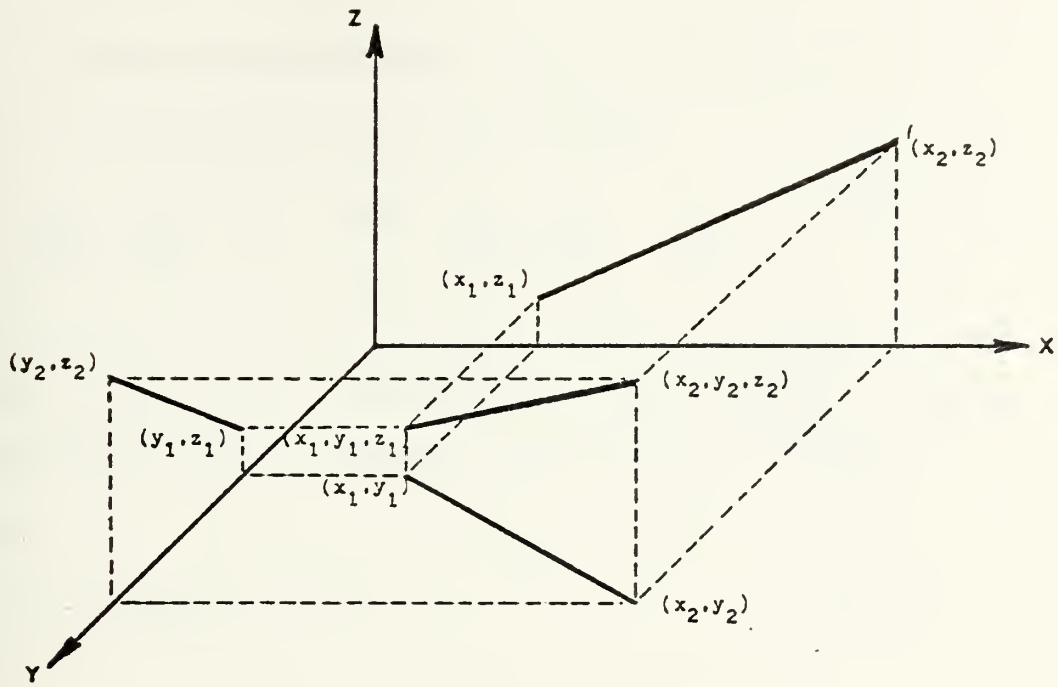

FIGURE V.6

PROJECTION OF LINE-OF-SIGHT ONTO Z-PLANE

decision is made the appropriate slope (for the XZ or YZ plane) is calculated in the subroutine:

$$m_{YZ} = \frac{Z_2 - Z_1}{Y_2 - Y_1} \quad ; \quad m_{XZ} = \frac{Z_2 - Z_1}{X_2 - X_1} \quad (V-3)$$

Knowing the elevation Z_1 , and adding to it the height of an erect man in meters, the determination of the line-of-sight elevation at any point along the path becomes a simple operation;

$$Z_3 = Z_1 + M_{XZ} (X_3 - X_1) \quad (V-4)$$

or

$$Z_3 = X_1 + M_{YZ} (Y_3 - Y_1)$$

G. DETERMINATION OF OBSCURING ELEVATION OF HEX

The elevation and the terrain characteristics of any hex on the map path must be extracted from the data base in order to determine the obscuring elevation of the hex. The only terrain features that represent obscuring properties in the model are wooded areas and built-up areas. Accordingly, once the identity of a map path hex is known, that hex is tested for the presence of obscuring properties (which have been assumed uniform throughout all of the hex). A positive test indicates that the elevation of the hex must be appropriately increased (the model uses a height of 8 meters for wooded areas and 12 meters for built up areas). It should be noted this calculated obscuring elevation is that of the center-of-mass of the hex; this

height, using the center of the hex as the reference, is then projected upon the XZ or YZ plane (as appropriate) for testing for obscuration. This approach has the advantage of partially smoothing out the "stepped" terrain of the computer model (see figure V.7).

H. DETERMINATION OF OBSCURATION

The test for obscuration therefore becomes simple. A comparison of the elevation of the projected line of sight is made against the obscuring elevation of the hex. If obscuration exist, line-of-sight between the two units does not exist. If the hex is not an obscuring hex, the logic developed in this chapter is repeated, i.e., determining the next set of hexes on the map path, and checking them for obscuration. This procedure is graphically summarized in figure V.8. The model logic is summarized in figure V.9.

I. DETECTION: GENERAL

Line-of-sight determination, however, is embedded within the larger question of whether or not detection in fact occurs. The theory of detection indicates that the contrast of the target, the atmospheric attenuation, the angular motion, the experience of the observer, fatigue, camouflage of the target, and a host of other factors are important in detection phenomenon. The level of detail required to generate a realistic model of detection theory is inconsistent



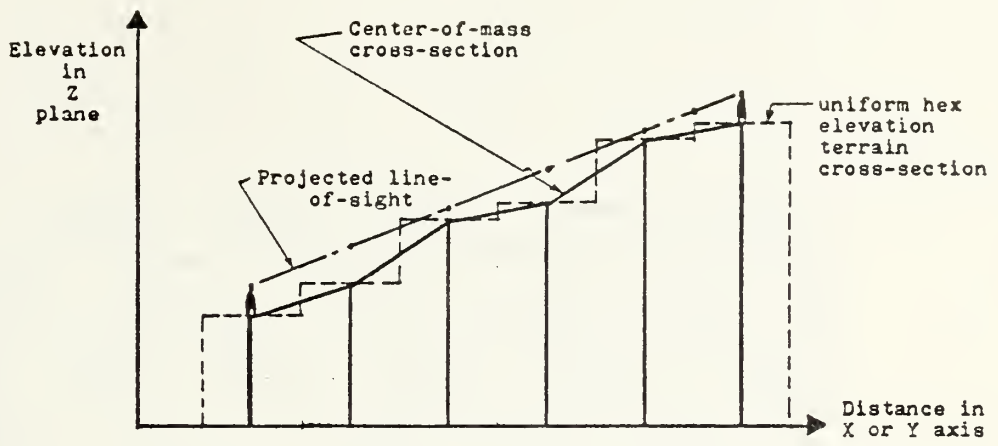

FIGURE V.7

Z-PLANE LINE-OF-SIGHT VS. OBSCURING ELEVATION PROJECTIONS

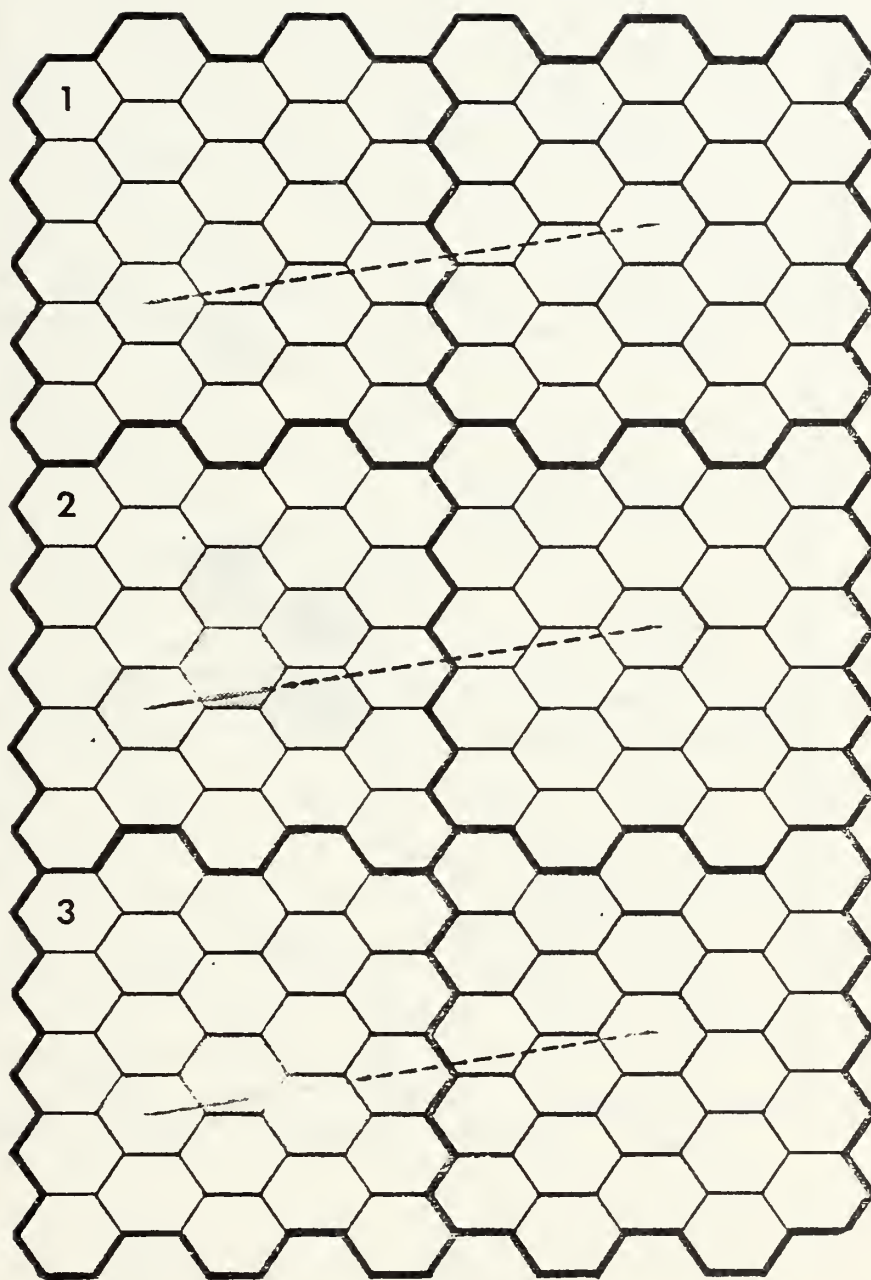

FIGURE V.8

LINE-OF-SIGHT DETERMINATION SUBROUTINE

THE
MUSEUM
OF
THE
CITY OF
NEW YORK
AND
THE
HUNTERIAN SOCIETY

1855

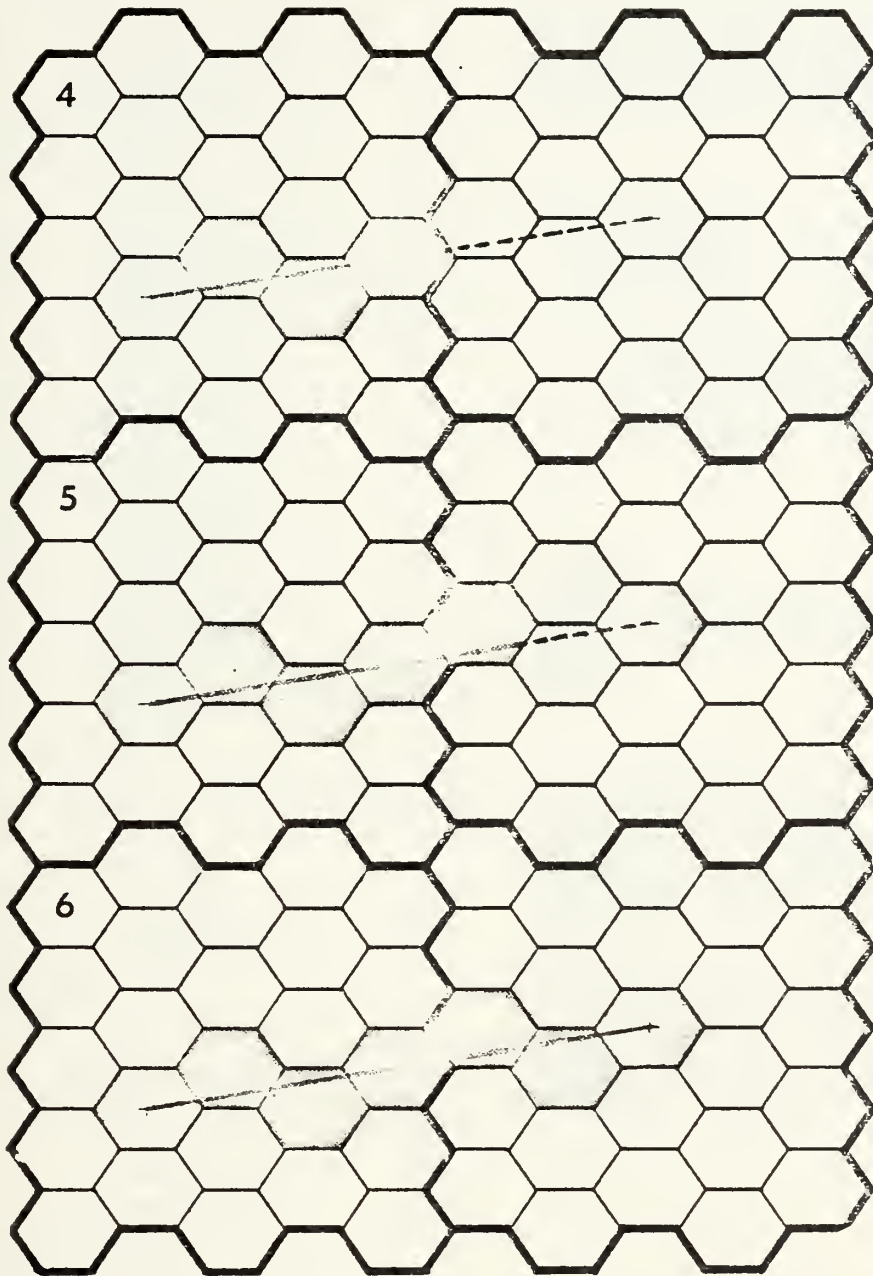
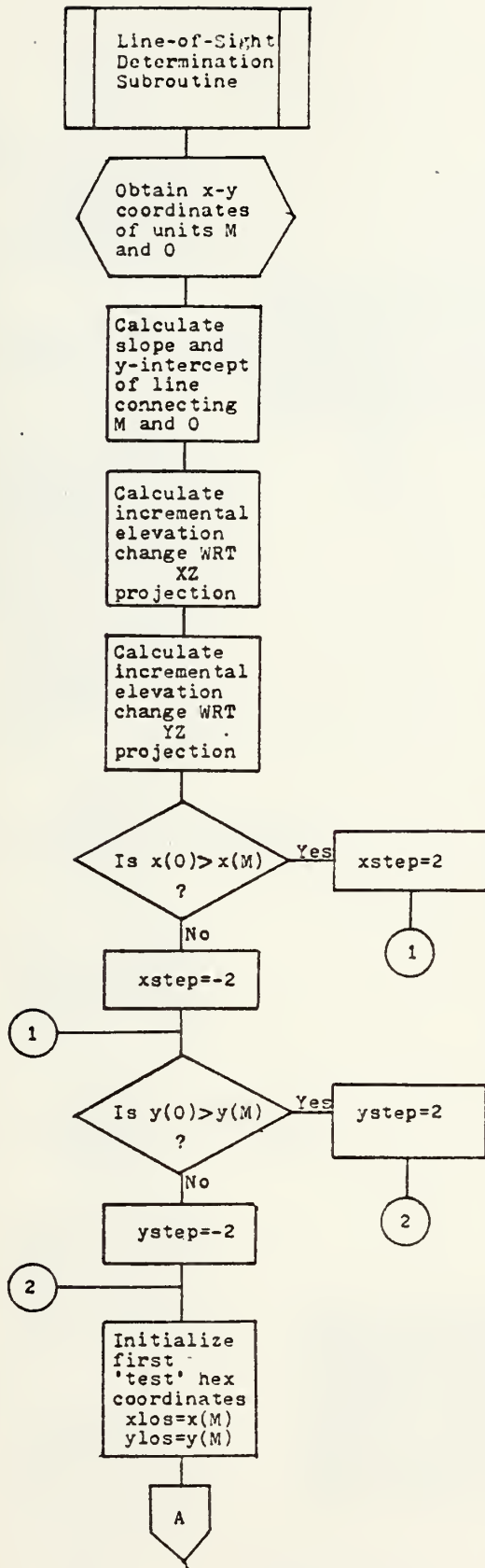

FIGURE V.8 (CONTINUE)





This subroutine determines whether or not an unobstructed line-of-sight exists between two units.

Within this procedure, the moving unit is again referred to as unit M, and the opposing unit is referred to as O. The specific O unit against which this subroutine checks has been selected by the Detection Subroutine.

Using $y = mx + b$

$$m = \frac{y(O) - y(M)}{x(O) - x(M)}$$

$$b = y(O) - x(O) \cdot m$$

Δelev is defined as the incremental elevation change with respect to the XZ or YZ plane

$$\Delta\text{elev}(XZ) = \frac{\text{elev}(O) - \text{elev}(M)}{|y(O) - y(M)|}$$

$$\Delta\text{elev}(YZ) = \frac{\text{elev}(O) - \text{elev}(M)}{|y(O) - y(M)|}$$

This procedure tests the directional properties of the line under consideration. As discussed in paragraph V. E, the directional properties of the line will dictate the adjacent quadrant set of hexes which must be tested for interception.

Accordingly, a test is made for positive x-direction and positive y direction, with the results of the test establishing values of constants that will be utilized to calculate the coordinates of adjacent hexes to be checked (relative to the "base" hex).

The moved unit's new location represents the base for line-of-sight calculations.

FIGURE V.9
FLOWCHART OF LINE-OF-SIGHT DETERMINATION SUBROUTINE



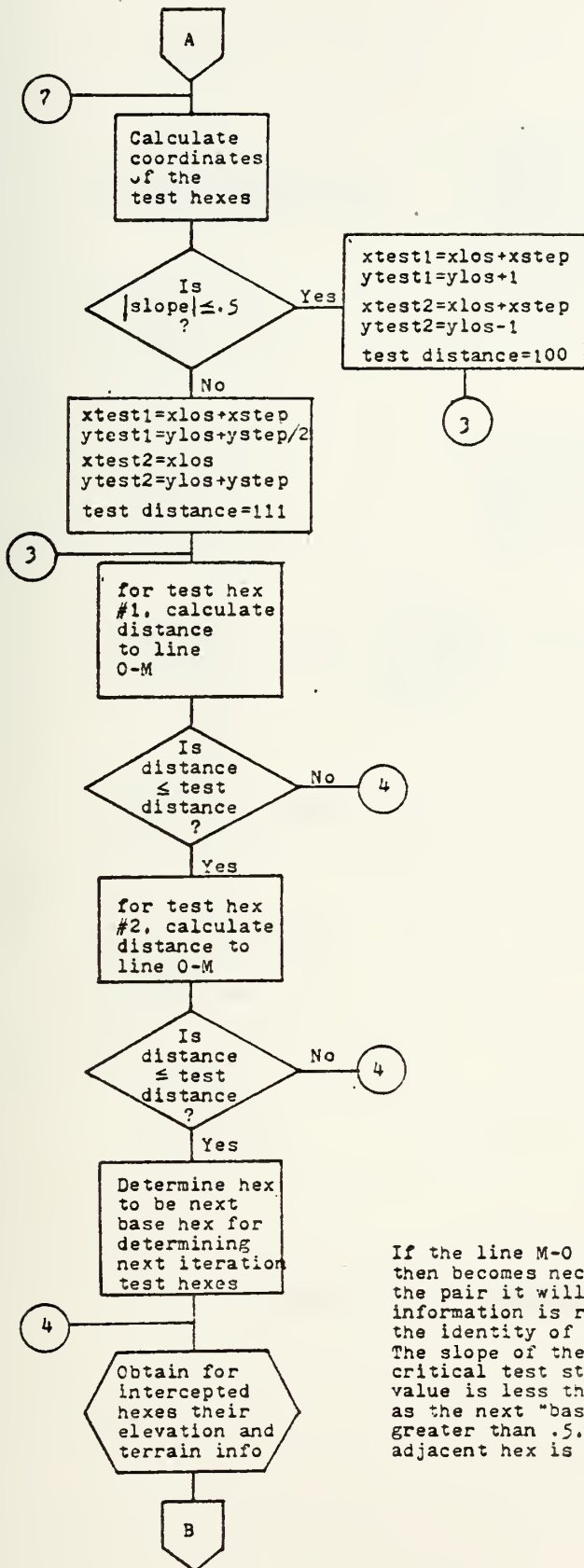

Knowing the slope of the line and its direction, we can then calculate the coordinates of the adjacent hexes which need to be tested to determine if they are intercepted by the line.

Note that the first hex to be tested will always be the diagonally adjacent hex (as defined within the appropriate quadrant set of hexes).

In order to test whether or not the line has intercepted a hex, the perpendicular distance between the point and the line is calculated. If the distance is within threshold values, the line is contained in the hex.

The distance between a line $y=mx+b$ and a point (x_1, y_1) is defined by the formula:

$$\text{distance} = \frac{|mx_1 - y_1 + b|}{\sqrt{m^2 + 1}}$$

Note that the order for checking the hexes is important; the diagonally adjacent hex is always checked first; if the line is not contained in the diagonal hex, it is always contained in the 2d test hex.

If the line M-O passes through both hexes, it then becomes necessary to determine which of the pair it will finally exit from. This information is required in order to determine the identity of the next set of "test hexes". The slope of the line O-M represents the critical test statistic; for cases when the value is less than .5, the diagonal hex serves as the next "base" hex; for cases when it is greater than .5, the vertically oriented adjacent hex is chosen.

FIGURE V.9 (CONTINUE)



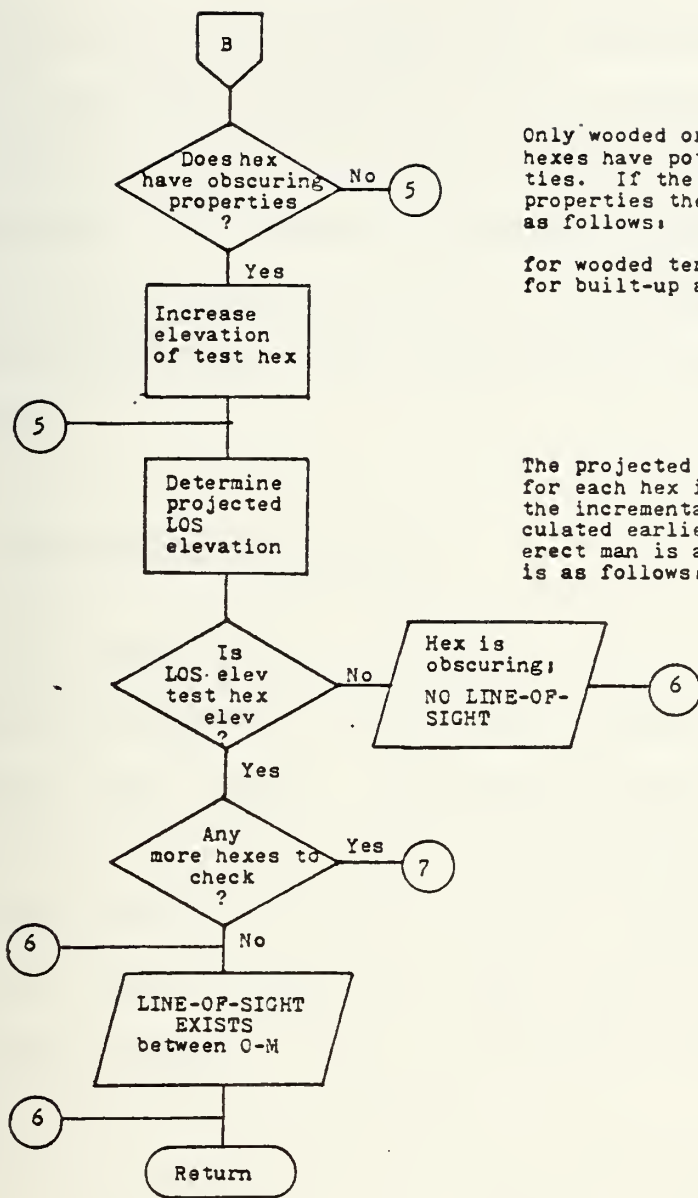

Only wooded or built-up area terrain hexes have potential obscuring properties. If the test hexes have obscuring properties their elevations are increased as follows:

for wooded terrain hex=elevation +8 (meters)
 for built-up area hexes=elevation +12 (meters)

The projected line-of-sight elevation for each hex is determined by utilizing the incremental elevation changes calculated earlier. The height of an erect man is also included. The algorithm is as follows:

$$LOS_{elev} = elev(M) + \Delta_{elev} + 2$$

where
 elev(M) is the elevation of the hex of the moving unit, and
 Δ_{elev} represents the product of the incremental change and the associated x or y axis distance that the test hex is from the moving unit.

FIGURE V.9 (CONTINUE)



with the level of detail at which our model is being pursued. The framework for the detection simulation includes line-of-sight existence, whether or not the target or the observer is moving, the characteristics of the target unit (size, equipment), all bounded by maximum observable distances. These factors all contribute to a probability of detection that therefore must take into account all of the non-explicit factors.

J. DETECTION DETERMINATION

Any change in the location of any unit in the combat simulation changes its detection probabilities relative to opposing force units. Accordingly keying of a detection subroutine is required after every movement of any unit from its hex location in the data base to another adjacent hex. The moved unit becomes the focal point for the calculation of ranges between it and all opposing units. The objective of the subroutine is twofold:

1. To determine if the moving unit has changed its status of observation of opposing units.

2. To determine if the moving unit has changed its status of observation by opposing units.

Key to these objectives is the determination of line-of-sight, or intervisibility. Intervisibility and detection are assumed, without calculation, between observers and targets in adjacent hexagons. Observation and detection cannot occur, in accordance with the game thresholds, when the distance between

the units becomes excessive. For those situations of interest between these two extremes, the logic of figure V.10 determines whether or not detection occurs. If line-of-sight exists between two units, the probability of detection is calculated as a decreasing function of the distance between the units. It must be noted that two different detection determinations are being made within the logic diagram: detection of the moved unit by opposing forces (detection of moving units involves longer detection threshold distances), and detection by the moved unit of opposing stationary forces (at shorter threshold distances). The probability of detection is considerably enhanced for either unit in the algorithm if line-of-sight had existed between the units prior to the event under consideration. Clearly, the longer a unit is within line-of-sight, the higher the probability it will be detected. Although the algorithm reflecting this logic is subjectively developed, it provides useful information. Similarly, if observation of a unit had previously existed, that observation is determined to be continued if line-of-sight continues to exist.

K. POTENTIAL ENHANCEMENTS

The procedures presented represent target acquisition processes for essentially a one-sensor system, that of visual contact. Most direct fire weapons have low trajectories closely approximating projected line-of-sights, and accordingly reliance on visual target acquisition will continue to

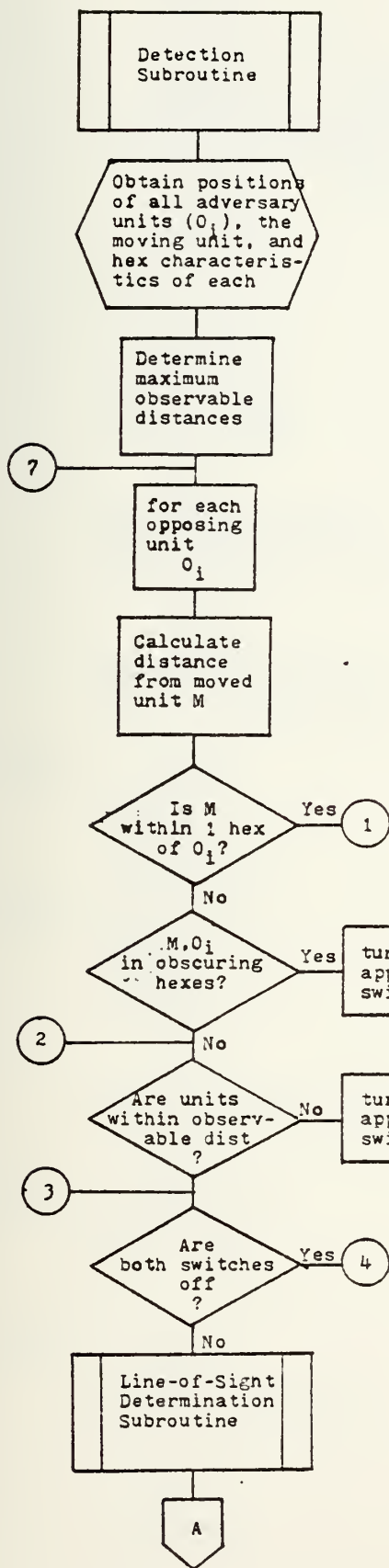

The Detection Subroutine is called after every movement of a unit. The subroutine determines whether the moving unit has observed any adversary forces, and whether the moving unit has been detected by any adversary forces.

For notational simplicity, the moving unit is referred to as M, and the opposing unit as O_i .

Maximum observable distances are found in Table V.1.

If a unit moves into a hex adjacent to an opposing unit, intervisibility automatically occurs irrespective of the obscuring properties of the hexes.

Notational note:

$O_i \rightarrow M$ defined as opposing unit observation of moving unit
 $M \rightarrow O_i$ defined as moving unit observation of opposing unit

Switches using the above notation are designed to help avoid the hex checking procedure if constraints preclude line-of-sight from existing.

If both units are within obscuring hexes, or outside of observable range, no visual contact will result and the subroutine need not continue further.

FIGURE V.10 FLOWCHART OF DETECTION SUBROUTINE

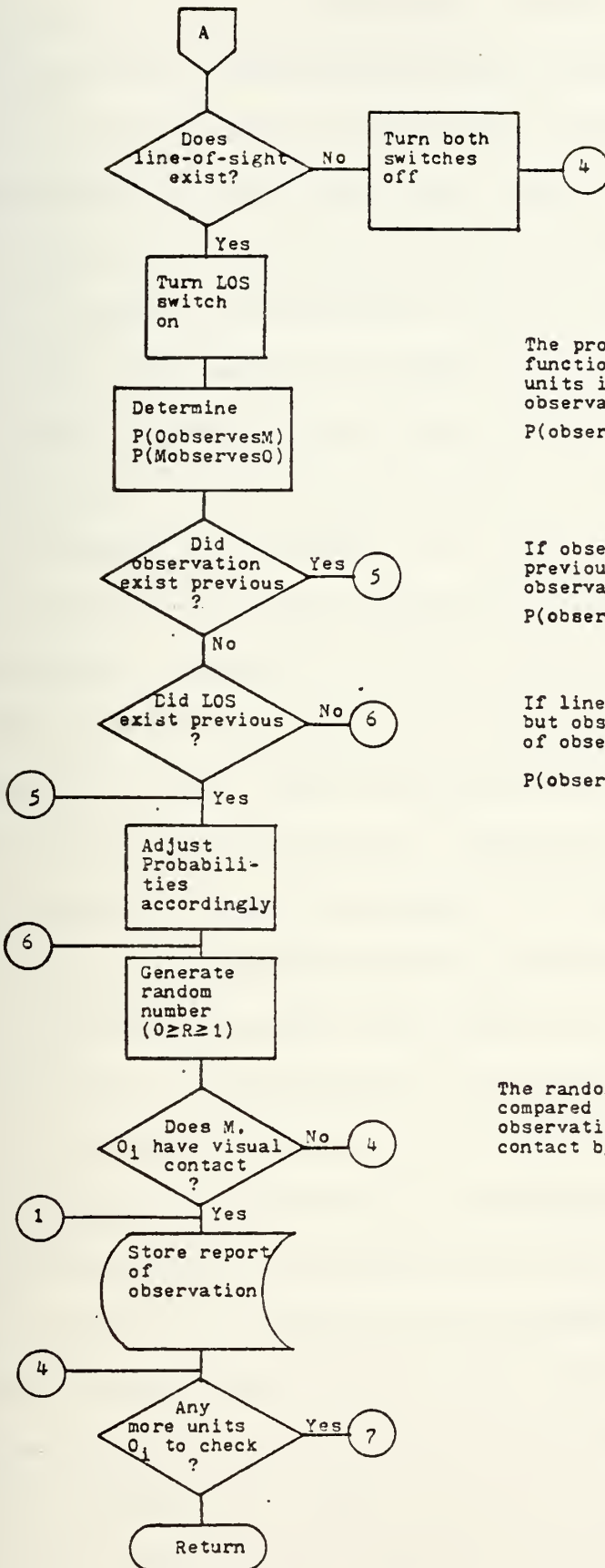

The probability of observation is a function of the distance between the units in relation to their maximum observation distances:

$$P(\text{observation}) = 1 - \left[\frac{\text{distance betw units}}{\text{max observable dist}} \right]$$

If observation between units existed previous to the current movement, then observation continues to exist.

$$P(\text{observation} | \text{observation existed}) = 1$$

If line-of-sight existed previously, but observation didn't, the probability of observation is still enhanced.

$$P(\text{observ} | \text{LOS existed}) = 1 - \frac{1 - P(\text{observ})}{4}$$

The random number between 0 and 1 is compared to the probability of observation to determine if visual contact by either unit is achieved.

FIGURE V.10 (CONTINUE)

be relevant in the foreseeable future. Clearly, however, sophisticated, specialized radars, electro-optical seekers, aerial reconnaissance drones and electronic intelligence capabilities, offer exotic new target acquisition opportunities. The operational characteristics of these new sensor systems can be readily incorporated into the simulation structure, and their influences evaluated subjectively.

Most interactive war games, and PEGASUS is no exception, provide perfect information about an adversary unit once it is detected. Location, unit size, and unit capabilities, are all known once the threshold of detection is overcome. This rarely occurs in battle. The stress and urgency of combat pervasively causes uncertainty; misperceptions and miscalculations - and this proverbial "fog of war" clouds all operational decisions. Accordingly, as development of envisioned war game progresses, the opportunity to study the effects of misinformation presents itself. This factor of misinformation will not lose its influence in an automated battlefield. The quality or accuracy of all sensor information is highly variable, and is a function of the source and inherent environmental considerations. However, these variables become transparent as data undergoes transformation into aggregated computerized information. All traces of their questionable ancestry are forgotten, and an aura of respectability (and accuracy) is generated. The concern that surfaces is at what level of misinformation will the decision-maker cease to have confidence in these transparent sensor systems.

The influence of the "fog of war," of misinformation, can be incorporated into the simulation. Once detection has been ascertained, the accuracy of the reported location and size of the observed unit can become subject to stochastic processes. As the distance between the observed and detected unit increases, the accuracy of the reported location may become less accurate; similarly, the accuracy of the estimate of the unit size should decrease. The accuracy of an observation report from a unit that is being suppressed by fire would suffer in accuracy. Accuracy degradation would take the form of changing a units reported location between 1 to 5 hexes along the axis of the line-of-sight between the 2 units.

The use of smoke as an obscuring capability under the control of the players is another potential enhancement which would improve the realism of the game. Use of smoke missions would expend artillery capability, and last only during one game turn. However, the targeted hex would become an obscuring hex during line-of-sight determinations, hence protecting against detection. This capability was not developed in order to simplify the role of the player as much as possible in the game; however, once the game is established, the use of smoke could be incorporated.

VI. DIRECT FIRE ENGAGEMENTS

A. GENERAL

Once target acquisition has been accomplished, the direct interaction of the forces can be initiated and accounted for. Of course, target acquisition does not require target engagement; clearly, the role of the successful commander includes a selective decision process relative to when, where, or whether to engage a target. His decision will be based, in part, on his mission objectives, his environment, his fire power capabilities, as well as his perception of his adversaries objectives and capabilities. Once he has made the decision to engage a target, time and distance factors will influence the probability of his success. The purpose of this section will be to describe the considerations and interactions that occur once the decision to engage a target has occurred.

B. DIRECT FIRE ENGAGEMENT RULES

Actual combat activities occur simultaneously and continuously on a real battlefield. The dynamics of battle are exceedingly intricate and interactive, and accordingly in attempting to present direct fire engagements in real time within the context of the war game, it is not possible to account for all possible variables and outcomes of an



engagement. Consequently, the PEGASUS war game includes a number of rules and restrictions which are designed to keep direct fire solutions fairly simple and straight-forward, and these rules and restrictions are incorporated into the proposed simulation.

1. Mission Costs

Perhaps the most important of the restrictions is the trade-off between a unit's ability to move and a unit's capability to execute direct fire during the same game turn. For each direct fire mission, the firing unit forfeits a portion of its movement allowance, thereby degrading its ability to move. Conversely, a unit which moves may degrade its ability to conduct direct fire during the movement phase. Each direct fire mission costs the firing unit three movement minutes. Because a direct fire mission can be executed during either the direct fire phase or the movement phase of a game turn, there is a requirement to assure that sufficient unexpended movement minutes are available to a unit prior to execution of the mission.

2. Deliberate and Return Fire

For purposes of the simulation there are two types of direct fire: deliberate fire and return fire. Deliberate fire is that direct fire which a unit plans and executes as the initiating fire in an engagement. Return fire is direct fire that a unit delivers on an opposing unit in response



to fire received from that unit. Return fire is reactive in nature and generally less effective than deliberate fire, and accordingly the distinction between the two types of fire must be accounted for prior to assessing the results of a direct fire mission. In this regard, when direct fires are planned by opposing units against each other for execution during the direct fire phase, both fires are considered "deliberate" and are assumed to occur simultaneously.

3. Restrictions on Number of Missions

Although there a 12 movement minutes available, a unit is restricted to executing a maximum of three direct fire missions during a game turn. Further, no unit may fire more than one direct fire mission at the same target during the same phase (direct fire phase or movement phase) of a game turn.

4. Observation

As clearly emphasized in previous sections, a unit must have line-of-sight to a target before it can engage that target by direct fire. During the direct fire phase, a unit may fire at any target it can observe, or any target that becomes observable during that phase. When a unit executes a direct fire mission from within an obscuring hex, it reduces the obscuring protection the terrain affords, and increases the probability of its observation and detection.

If a firing unit becomes "observable" to the targeted unit, the targeted unit may execute a "return" fire mission in response.

C. PLAYER REQUESTS FOR DIRECT FIRE MISSIONS

Consistent with the interactive and dynamic nature of combat, exploitable targets may be opportunistically acquired. The exploitation can be achieved only if a timely response is available. Accordingly, the computer will advise the players each time the algorithms of the target acquisition subroutine indicate an opposing unit is observed by the maneuver unit. It must be emphasized at this point that although the player is aware of the location of the opposing unit, the only friendly units that can engage the target are those which the computer has determined have observation of the target.

During the direct fire or movement phase of the game turn, the player is required to immediately indicate his desire to engage a target with direct fire once advised that the target has been acquired. Available information to assist him in making this determination is provided, such as target location, type, size, and range from the maneuver unit. A decision by the player to engage the target will cause the computer to immediately execute the direct fire mission (assuming there are no game restriction that preclude the mission from being accomplished). Figure VI.1 charts the interactions involved in requesting immediate direct fire missions.



"Target acquired; do you desire to engage?"

Requests for decisions relative to immediate direct fire missions are provided during the movement or the direct fire phases.

This subroutine processes immediate requests for direct fire missions, and if the requests are valid, immediately executes the mission.

Prior to executing the direct fire mission, the request is screened for conformance with simulation rules and restrictions.

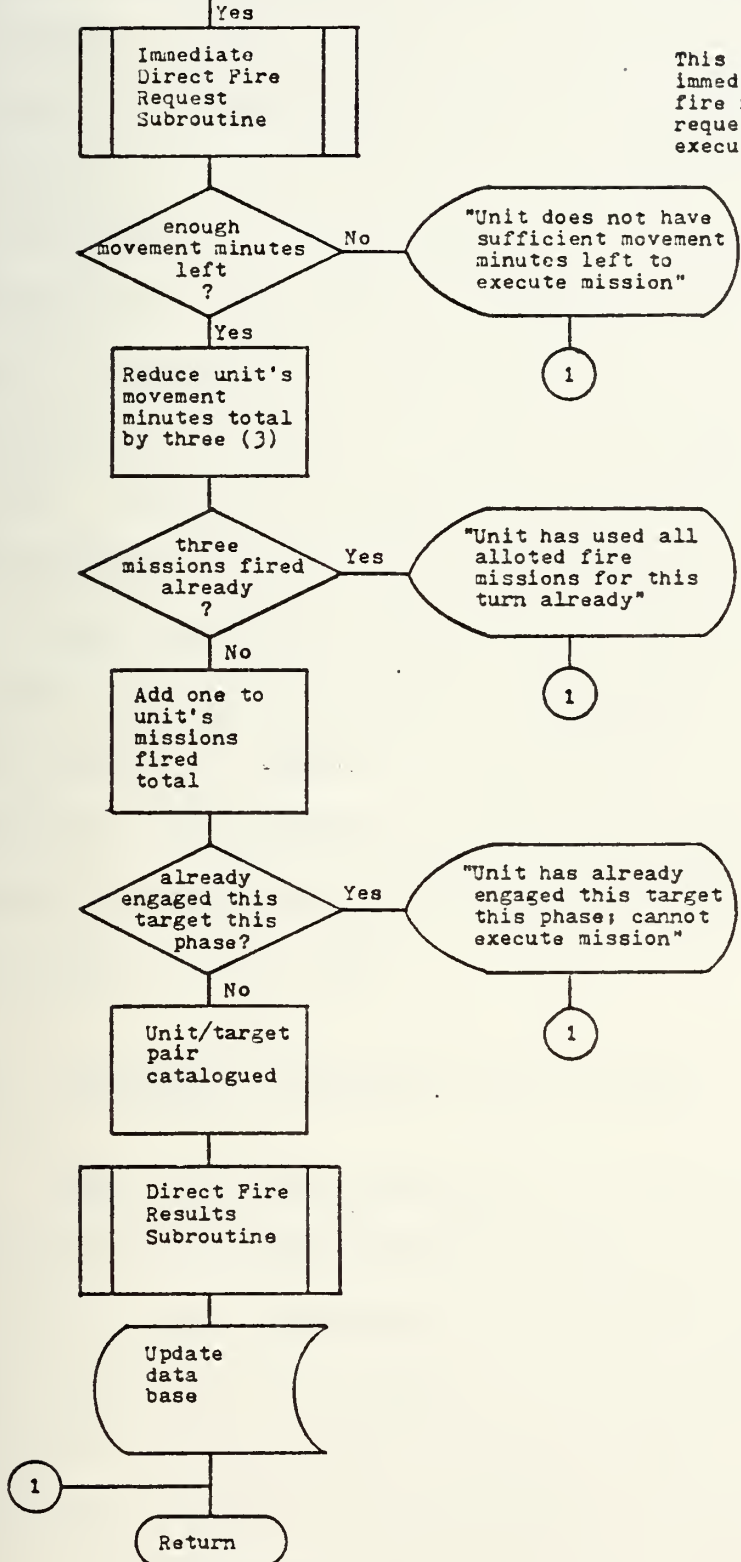

FIGURE VI.1 FLOWCHART OF IMMEDIATE DIRECT FIRE REQUEST SUBROUTINE



At the end of each game turn, each player is advised of those opposing units observed by each of his maneuver elements. Again he has the opportunity to direct the execution of a direct fire mission upon the potential targets, however the mission will not be executed until the direct fire phase of the next game turn. Therefore, the player assumes the risk that the effects of the direct fire mission may be preemptively reduced if his unit is targeted by the opposition during the indirect fire phase of the next game turn. Figure VI.2 charts the interactions involved in requesting planned direct fire missions.

The procedures developed in figures VI.1 and VI.2 concentrate on detailed computer prompting of the players, intended to reduce the player contribution to a yes/no answer. This approach significantly reduces the time it takes for a player to respond, and hence contributes to accelerating the tempo of the game.

D. ASSESSMENT OF DIRECT FIRE RESULTS

Implicit in the execution of the direct fire engagement procedures is the assumption that a unit will attack a target with its most appropriate and potent weapon. For example, an infantry unit equipped with an anti-tank missile will use the missile when attacking a tank, but will use its anti-personnel weapons when engaging another infantry unit.

In this regard there are only three categories of targets considered in the assessment procedures:

"Do you plan any direct fire missions for your units?"

Planned Direct Fire Requests Subroutine

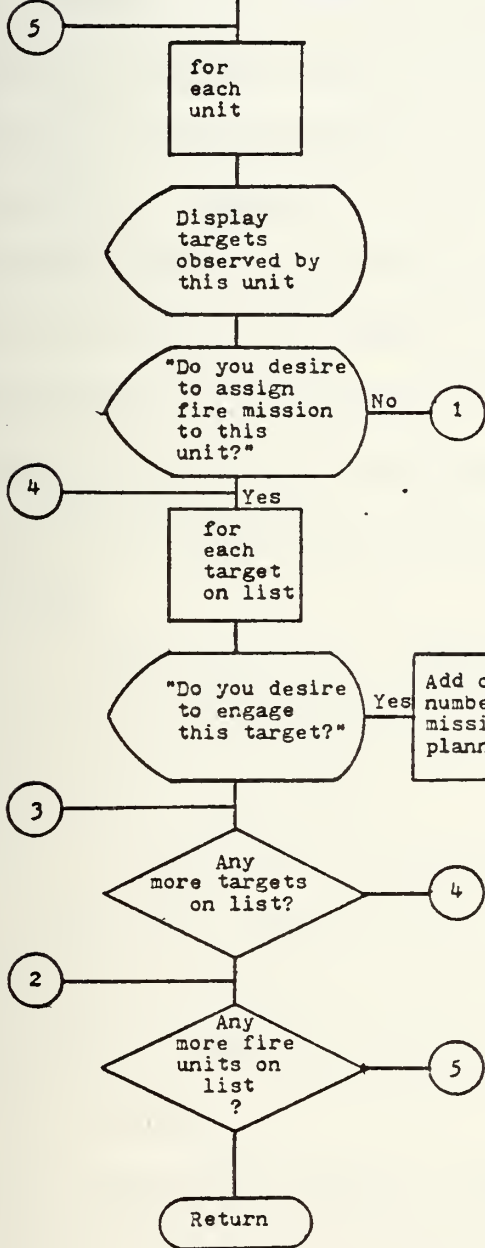

Only adversary units that are observable by a unit are listed at the end of each game turn. If the player desires to engage one of these units in direct fire, this subroutine is called.

The planned direct fire requests subroutine helps the player to generate a target list to be executed in the next turn by the appropriate firing unit.

The request procedure goes through the potential targets list, requiring only YES or NO answers from the player in response to the formatted queries.

Appropriate mission information is catalogued and saved to be used in execution of the mission in the direct fire phase of the next game turn.

FIGURE VI.2

FLOWCHART OF PLANNED DIRECT FIRE REQUEST SUBROUTINE



1. Armored targets, which includes tanks and armored personnel carriers (mounted troops);
2. Dismounted troops in the offense;
3. Dismounted troops in the defense.

Therefore an accounting procedure is required to assure during the game play that the appropriate target classification is always assigned to each unit. When a direct fire mission is ordered, it will be necessary to determine the current target classification assigned the targeted unit. Upon obtaining the target classification, the next procedural step will be to determine which (if any) of the firing unit's weapon systems can best defeat the target. The weapon systems played that can defeat armored targets are aggregated as follows:

1. Tank main gun (M60A1, M60A2, T62)
2. Anti-Tank Missiles (TOW, Sagger)
3. Anti-Tank Guns
4. Troop Anti-Tank Weapons (Dragon, RPG-7)

The weapon systems that can defeat personnel targets (dismounted troops in the offense or in the defense) are grouped into more general characterizations as follows:

1. Tanks
2. Mounted Infantry (Squad, Platoon, Company)
3. Dismounted Infantry (Squad, Platoon, Company)

Accordingly, the initial effort in the direct fire results algorithm is to determine the specific weapon system/target combination that is applicable to the situation. The



weapon systems associated with each maneuver unit are identified and quantified in the units standard Table of Equipment. A maneuver elements Table of Equipment may be augmented, reinforced, or otherwise modified (within the constraints of overall unit equipment totals) by the commander as he task-organizes his fighting elements. Note that if the firing unit does not have an organic weapon system capable of defeating the target, there will be no casualties resulting from the ensuing fire fight.

E. DETERMINATION OF CASUALTIES

Once the specific weapon system/target pairing has been identified, the casualty calculation routines can be entered. There are a variety of constraints and parameters that are unique to each weapon system/target pairing, and these unique parameters are provided for in the logic diagrams of figures VI.3, VI.5 and VI.7. This section will discuss those considerations more general in application, and more germane.

F. CALCULATION OF ARMORED CASUALTIES

The firing of one anti-armor weapon against one armored target can be reduced down to two simple, but complementary outcomes: success, that the target will be neutralized (destroyed or rendered ineffective), or failure, that it would not be neutralized. Assigning probability of kill factors to the weapon system adequately defines the

probabilistic outcome of this independent conflict. However, when a group of firing units confronts a group of targets, (the resulting engagement pairings) the expected number of successes are no longer independent of each other—unless perfect coordination between firing units is assumed. The method used to calculate armored casualties in this subroutine assumes a lack of coordination between firing units, that each firing unit picks a specific target from a group of targets at random, and fires at it independent of the behavior of the other firing units. Obviously the lack of coordination or information transfer among firing units creates inefficiency: some targets will be fired on by more than one unit, while some will not be fired upon at all.

The problem, simply stated, is to determine stochastically the number of kills (successes) resulting from an engagement of f firing units (with a probability of kill $P_k=p$) against t targets. Assume:

$X(n)$ = number of targets killed just after the n^{th} firing unit fires.

$U_j(n) = P [X(n) = j]$ = probability that j targets have been killed after the n^{th} firing unit fires.

$p = P_k$ = probability of kill of the weapon system against a target in an independent engagement.

$q = (1 - P_k)$ = probability of a miss

t = number of targets

f = number of firing units

n = number of firing units that have fired



The probability that there will be j kills after n units have fired against t targets is then defined by the following:

$$U_j(n) = U_j(n-1) \left[\frac{j}{t} P + q \right] + U_{j-1}(n-1) \left[\left(\frac{t-j+1}{t} \right) P \right] \quad (\text{IV-1})$$

where

$$U_j(n) = 0 \text{ if } j > n \\ \text{or } j < 0$$

The equation states that the probability of j kills after n firings is dependent upon the probabilities associated with how many kills there were after $n-1$ firings. There could be j kills after n firings only if: (1) there were j kills after $n-1$ firings, and the n^{th} shot was a miss (or a hit on a previously killed target); or (2) there were $j-1$ kills after $n-1$ firings, and the n^{th} shot was a kill (of a previously unkilld target).

By iteratively determining the probabilities associated with each possible number of kills after each firing unit has fired, a set of probabilities for j kills ($0 \leq j \leq t$) resulting from f units firing on t targets result. To determine the number of kills for a specific engagement, it is convenient to utilize the cumulative probability distribution function resulting from this information. An example of the resulting curve when $P_k = .60$, $f = 3$, and $t = 3$ is shown in figure VI.3. The utility of this curve is that it establishes thresholds for each possible outcome. Accordingly, once having established the threshold values for all possible outcomes for a unique P_k , f and t combination, selection of a uniformly distributed random number R between 0 and 1 then



Direct Fire Results Subroutine

This subroutine resolves direct fire engagements, either preplanned or immediate.

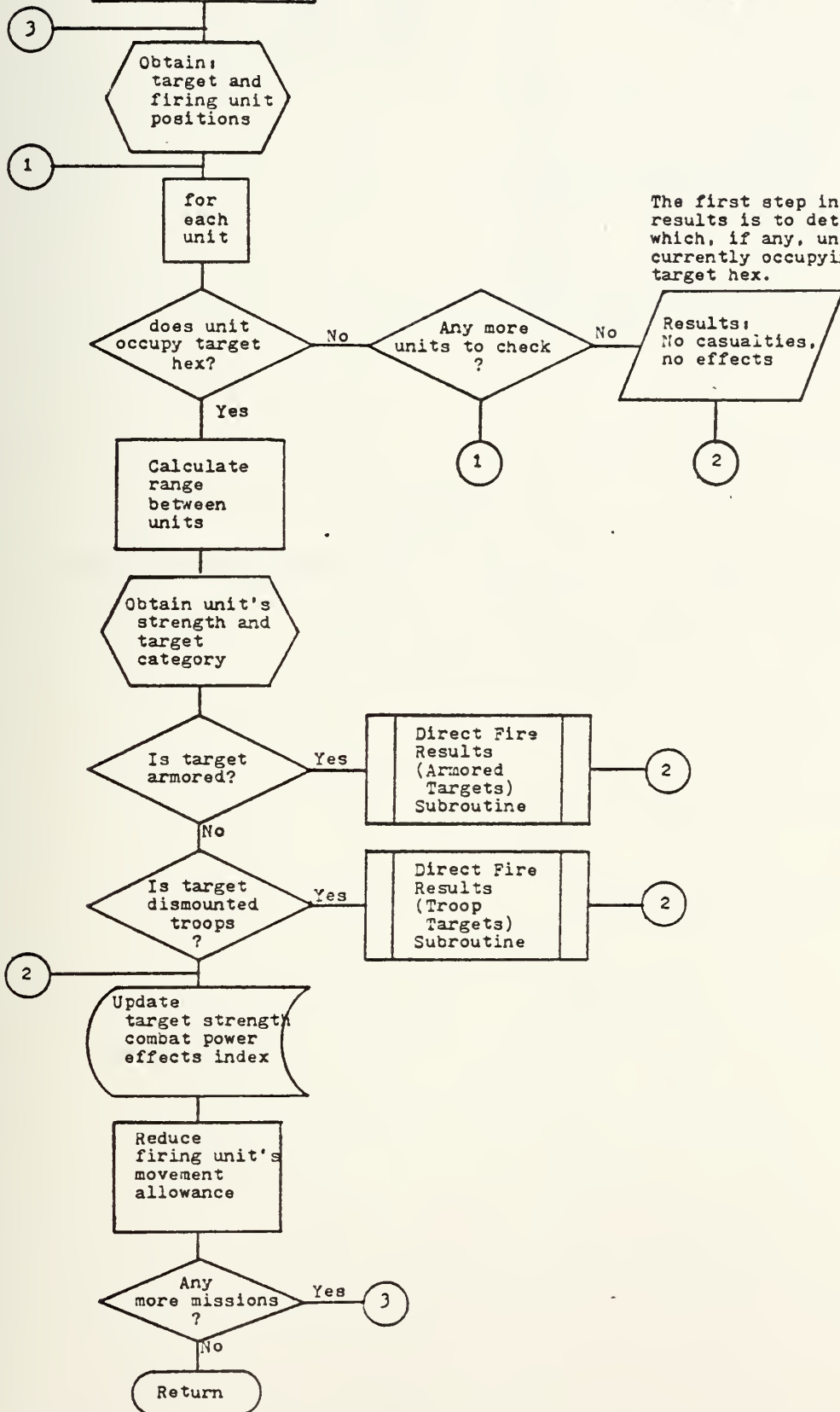

FIGURE VI.3 FLOWCHART OF DIRECT FIRE RESULTS SUBROUTINE

j	$P[J=j]$	$P[J \leq j]$
0	.064	.064
1	.456	.520
2	.432	.952
3	.048	1.000

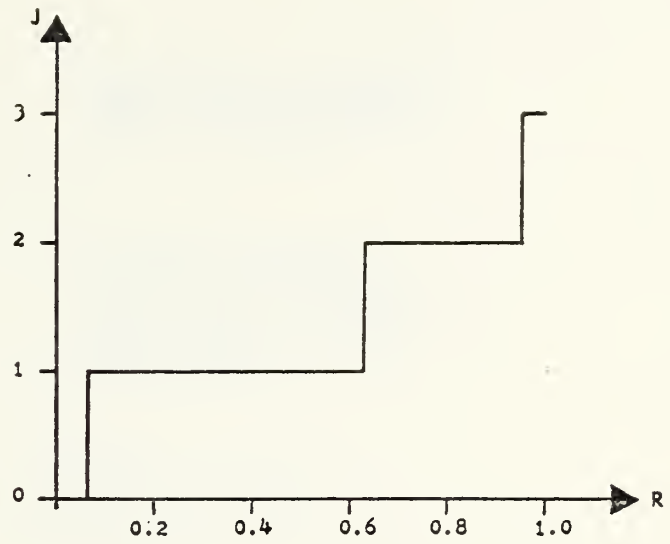

FIGURE VI.4

CUMULATIVE PROBABILITY DISTRIBUTION FUNCTION

Direct Fire Results (Armored Targets) Subroutine

This subroutine assesses the losses accruing an armored unit due to an adversary's direct fire mission.

Obtain target range, strength, and disposition; firing unit type, and strength; and hex terrain characteristic

A target is considered protected if it is in a covering hex. A covering hex has a predominant terrain characteristic of 'wooded' or 'built-up area'

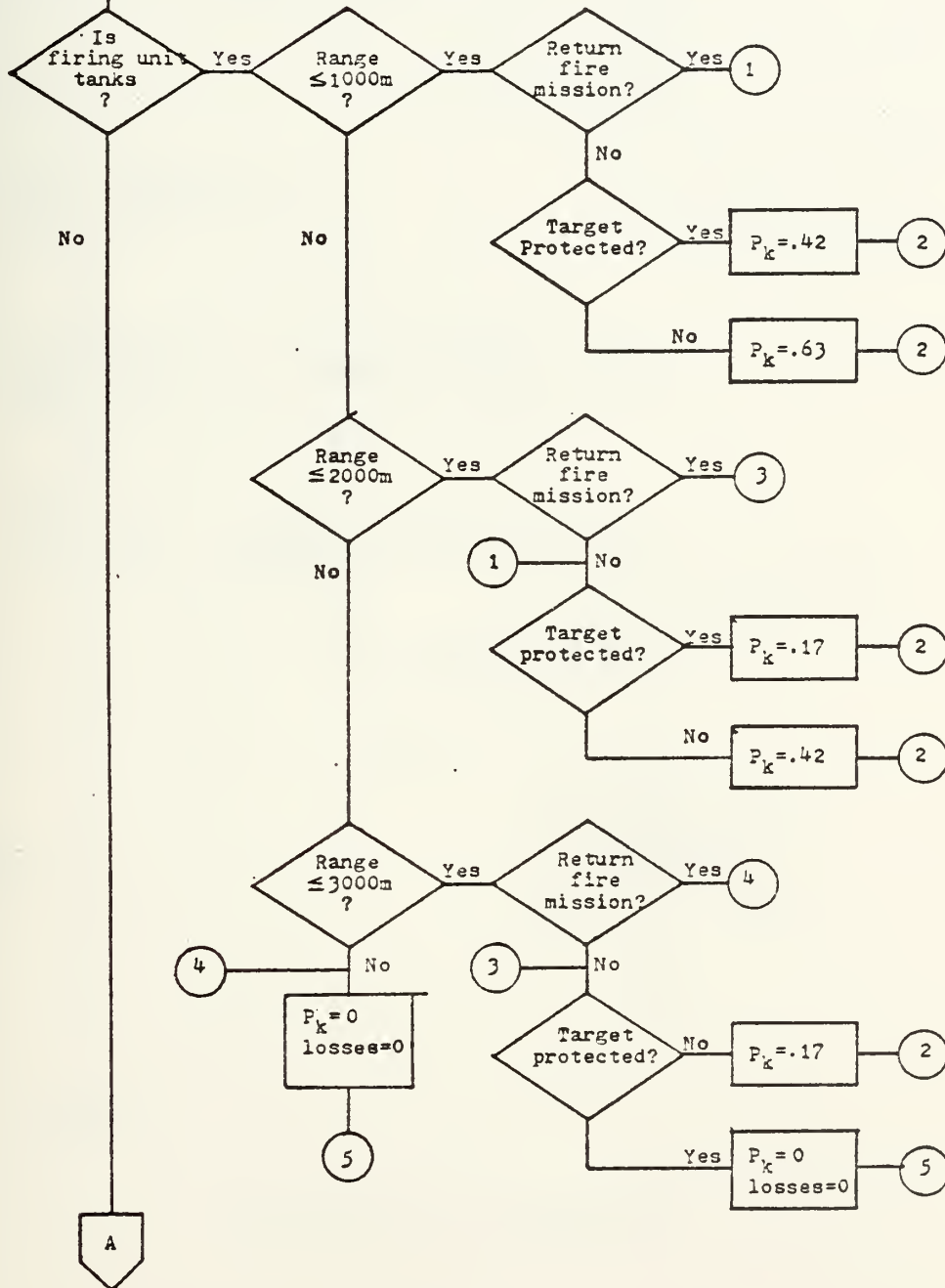

FIGURE VI.5
FLOWCHART OF DIRECT FIRE RESULTS
(ARMORED TARGETS) SUBROUTINE



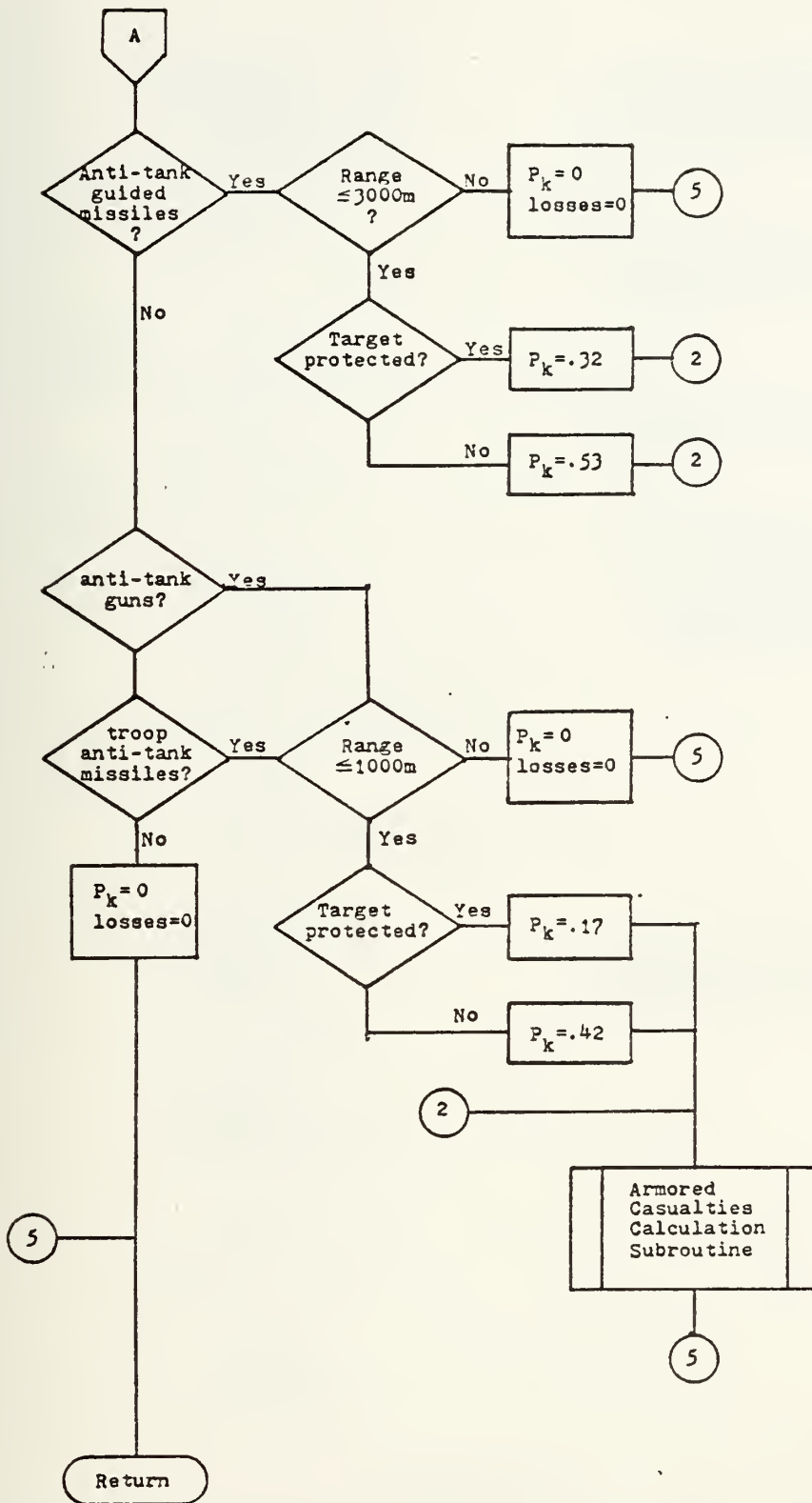
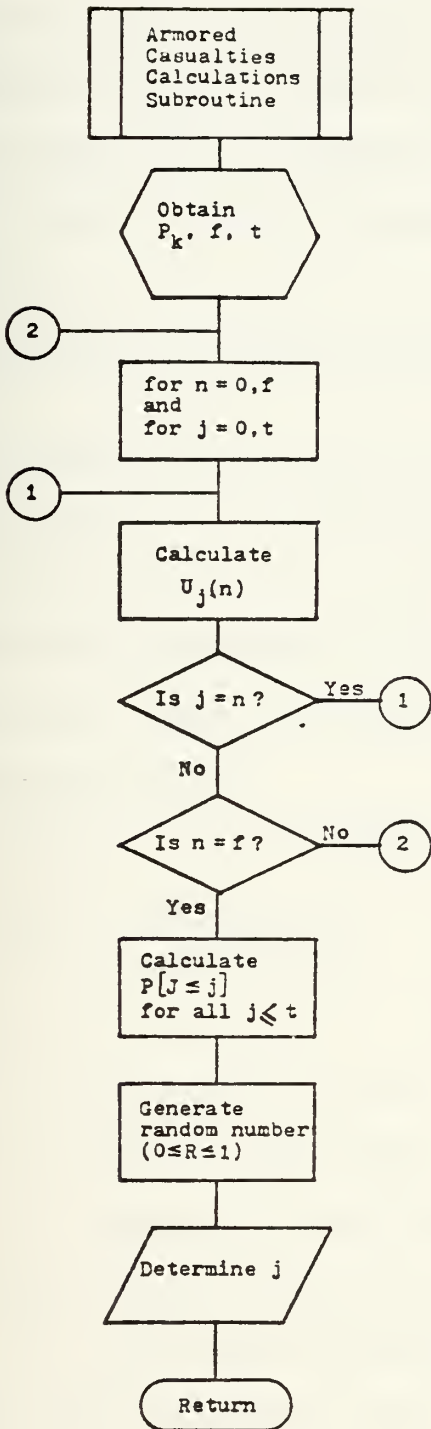

FIGURE VI.5 (CONTINUE)



This subroutine calculates the specific number of losses of armored vehicles resulting from a direct fire mission.

P_k is the probability of kill
 f = number of firing units
 t = number of targets

j = number of kills
 n = number of units which have fired

$U_j(n)$ is defined as the probability of there being exactly j kills after n units have fired in an uncoordinated mode against t targets. Equation VI-1 defines the relationship.

This procedure constructs the thresholds associated with the cumulative probability distribution function.

FIGURE VI.6

FLOWCHART OF ARMORED CASUALTIES CALCULATION SUBROUTINE



determines the number of kills associated with the conflict. It is precisely this procedure that is utilized to determine the number of kills in each anti-armor weapon versus armored vehicle direct fire engagement. This procedure is incorporated into the logic diagram presented in figure VI.6.

G. CALCULATION OF PERSONNEL CASUALTIES

The assumptions and procedures utilized to determine personnel casualties resulting from indirect fire engagements were developed with full consideration of their applicability to direct fire engagements (see section IV.D - IV.F). The probabilistic range of casualty outcomes was defined by the following equations:

$$X = 0.5 (k_i I + k_t T)(R - 0.5) + 0.5 k_i k_t IT \quad (IV-3)$$

$$KIA = X \text{ when } X > 0 \\ 0 \text{ when } X \leq 0$$

where

$$I = \text{Intensity of Fire Index} \quad (IV-4)$$

$$T = \text{Target Size Index (see Table IV.4)}$$

$$k_I = \text{Weapons System Intensity Factor}$$

$$k_T = \text{Target Disposition Factor}$$

$$R = \text{Uniformly distributed random number between 0 and 1.}$$

The equations reflect the logic governing how casualties will increase as the intensity of fire (I) brought to bear on the target increases, and as the number of personnel in the target area (represented by T) increases. The stochastic range of casualty outcomes determined by the above equations,



in conjunction with the integer rounding properties available in computer operations, adequately serve to attrit infantry forces when appropriate values are assigned to k_I , the weapons system intensity factor, and the intensity of fire factor I. Table VI.1 lists those values determined by analysis to provide casualty distributions closely approximating those found in the direct fire combat results tables of the PEGASUS manual game. Figures VI.8, VI.9, and VI.10 provide an example of the comparative results obtained from using this approach.

TABLE VI.1

WEAPON SYSTEM INTENSITY FACTORS
FOR DIRECT FIRE ENGAGEMENTS

<u>Weapon System</u>	<u>Weapon System Intensity Factor, k_I</u>	<u>Intensity Descriptor, I</u>
Tanks	0.4	Number of tanks
Mounted Infantry	0.5	Size of unit
Dismounted Infantry	1.0	Squad = 1 Platoon = 2 Company = 4

Direct Fire Results (Troop Targets) Subroutine

This subroutine assesses casualties and effects resulting from direct fire missions on troop targets.

T=1 for squad-size target
 T=2 for platoon-size target
 T=4 for company-size target

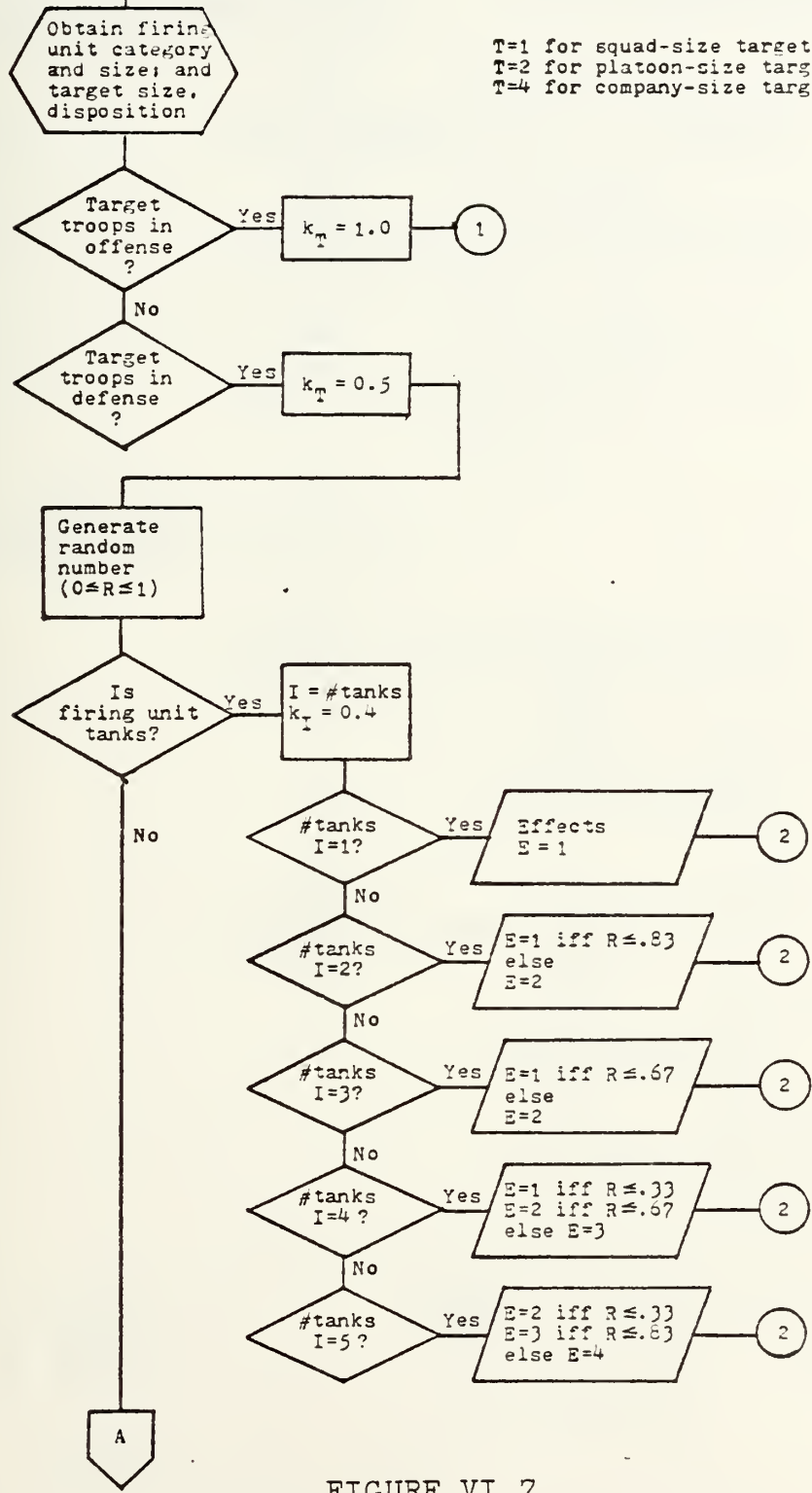

FIGURE VI.7

FLOWCHART OF DIRECT FIRE RESULTS (TROOP TARGETS) SUBROUTINE



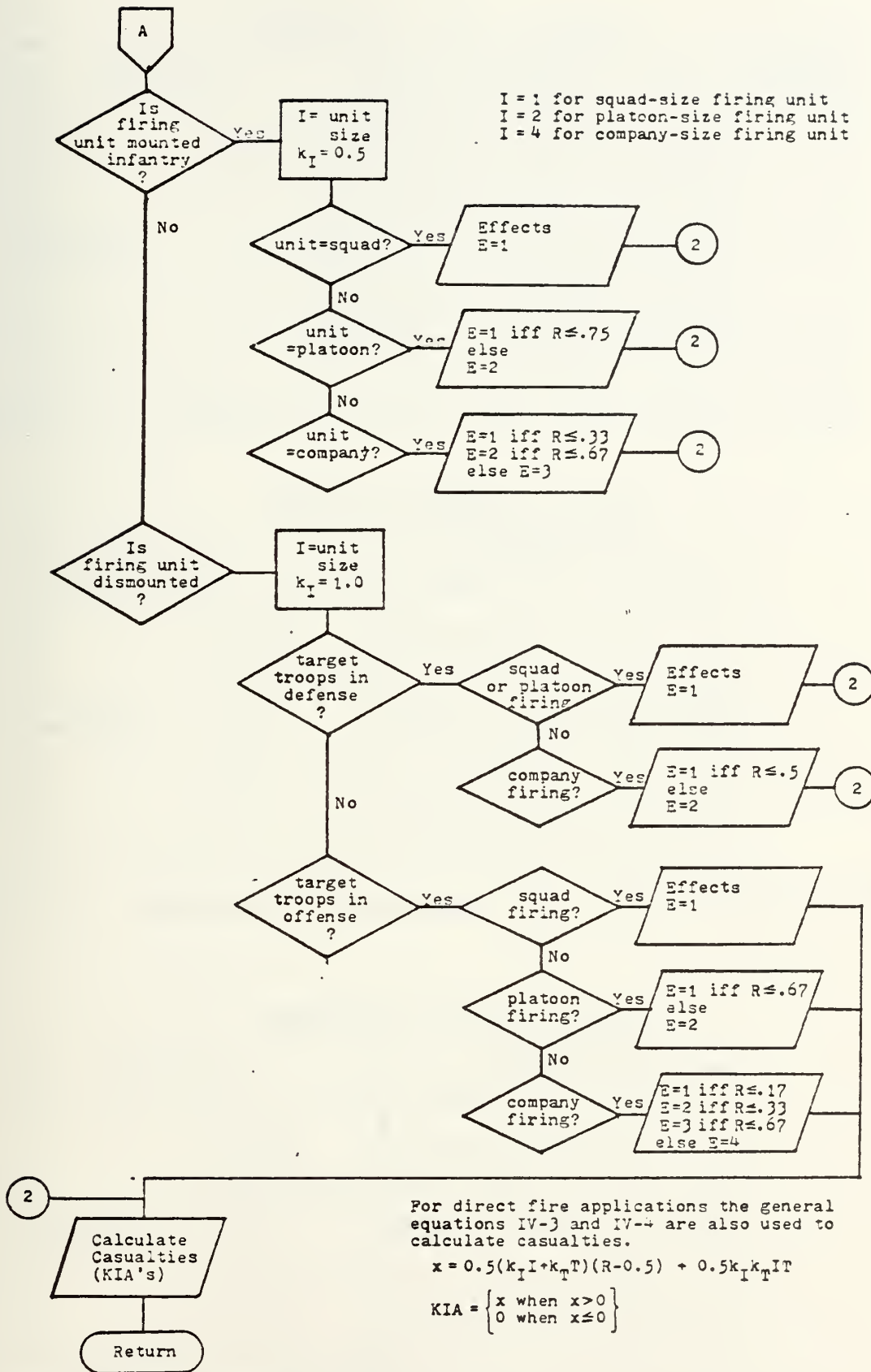

FIGURE VI.7 (CONTINUE)



DISMOUNTED TROOPS - OFFENSE

FIRING UNIT			TARGET UNIT			EFFECTS INDEX
			SQD	PLT	CO	
MOUNTED	SQD	KIA	000 000	000 000	000 000	111 111
		WIA	000 001	000 011	001 111	
	PLT	KIA	000 000	000 001	000 111	111 112
		WIA	001 111	011 112	112 234	
	CO	KIA	000 011	001 111	111 223	122 233
		WIA	011 111	112 234	567 8 9 10	

FIGURE VI.8 EXAMPLE OF DIRECT FIRE COMBAT RESULTS TABLE

DISMOUNTED TROOPS - OFFENSE

FIRING UNIT			TARGET UNIT		
			SQD	PLT	CO
MOUNTED	SQD		000000	000001	000011
	PLT		000011	000112	011223
	CO		000112	012223	344668

FIGURE VI.9 EXAMPLE OF CONSOLIDATED KIA COMBAT RESULTS TABLE

DISMOUNTED TROOPS - OFFENSE

FIRING UNIT			TARGET UNIT		
			SQD	PLT	CO
MOUNTED	SQD		000000	000000	000111
	PLT		000001	000111	111222
	CO		000111	011223	233445

FIGURE VI.10
EXAMPLE OF FORMULA DERIVED KIA COMBAT RESULTS TABLE



VII. THE MOVEMENT PHASE

A. GENERAL

It is through the simulation of movement, within realistic time and space factors, that the interaction of the forces and their environment can be accounted for. Actual combat activities occur simultaneously over several areas of the battlefield, and the activities of units in actual combat are continuous. However, the simulation by the computer of combat requires the sequential handling of events and the discrete representation of units and terrain. Accordingly, the success of a simulation is highly dependent upon its ability to create, within the constraints of event-sequencing, a reasonable representation of the continuum of the battlefield. The manual PEGASUS war game, by virtue of its dependence on numerous controllers, creates an atmosphere of simultaneous and continuous operations for the players, even though the battle simulation itself is conducted in a structured, event-oriented mode. Accordingly, while developing the logic structure of the movement phase of the proposed computer-assisted war game, an attempt has been made to similarly create an atmosphere of interactive, continuous operations.



B. OVERVIEW OF THE MOVEMENT PHASE

It is within the movement phase that the players are required to exercise their tactical decision-making abilities in a time-constrained, stressed situation similar to actual combat. However, the simulation, by virtue of its design for just one player on each side, cannot hope to capture the full impact of the multi-echelon, multi-dimensional flow of information and decision-making typical of combat at the battalion level.

Figure VII.1 structures the logic of the movement phase, and it can be readily observed that all of the conflict engagement types and considerations discussed previously come into play. Movement is a complex and important part of a simulation, since movement can reveal units and hence initiate engagements. The acquisition of targets generates attendant decision-making pressure upon the players. Since acquisition of targets in this simulation is limited to the visual sensor mode, observation of an adversary unit implies the possibility that intervisibility exists, that the observing unit has also been detected. The player's decision to engage the target just acquired is nontrivial, as it may not be to his advantage to do so. The availability of immediate indirect fire support (from the company's 81 mm Mortar section) as well as the immediate direct fire capability organic to the unit, allows each side sufficient firepower and flexibility to cause significant attrition of its adversary. Accordingly, each must assure that conflict



This subroutine executes the planned movements of each adversary, and interacts with the players to generate dynamic battle simulation.

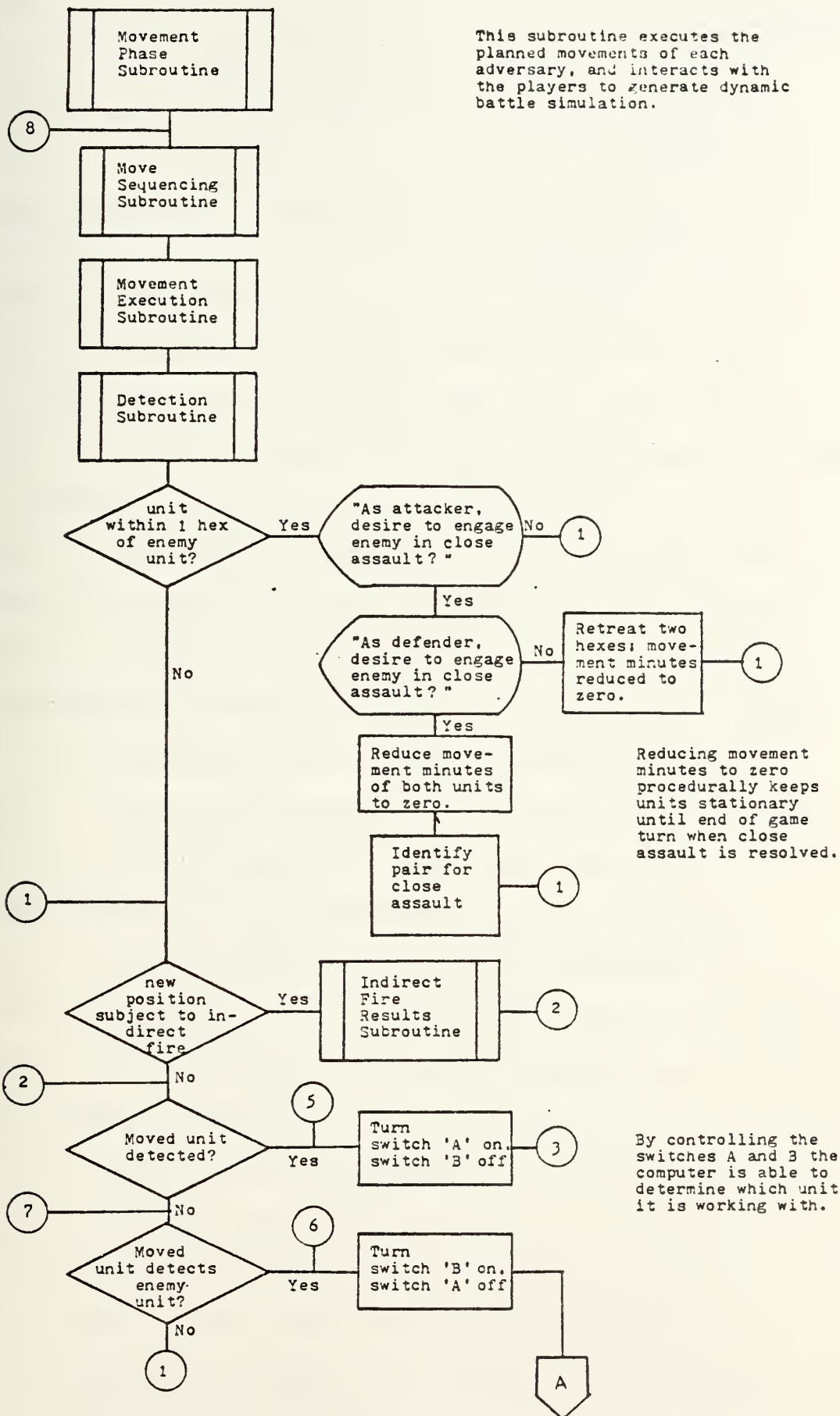

Reducing movement minutes to zero procedurally keeps units stationary until end of game turn when close assault is resolved.

By controlling the switches A and B the computer is able to determine which unit it is working with.

FIGURE VII.1 FLOWCHART OF MOVEMENT PHASE SUBROUTINE



engagements are initiated when it is tactically advantageous to do so, because the penalties for tactical mistakes or blunder are absolute, as they are in combat.

C. TIME-SEQUENCING OF MOVEMENTS

The time-sequencing of the movement of units must be placed in the context of the previously discussed "game-turn." Each maneuver unit begins each game turn with an allowance of twelve movement minutes. This allowance of time can be expended in several ways, principally in movement, but also in direct fire operations. Therefore, the movement minute becomes more than a time-measure of movement; it is also a measure governing a units combat capability. The suppressive effects of indirect and direct fire engagements, which degrade a units combat capability, may be expected to result in reductions to a units movement minute allowance for the balance of a game turn (see table IV.5 for descriptions of the suppressive effects of indirect and direct fires). The importance of this discussion is that some, or many, of the maneuver units may have already expended a portion of their movement allowance prior to the movement phase of the game turn. Since maneuver units would enter this phase with varying amounts of minutes remaining, priority of movement execution, as shown in figure VII.2, is given to those units with the most movement minutes remaining. Searches are iteratively conducted after each movement (and all activities and operations generated by



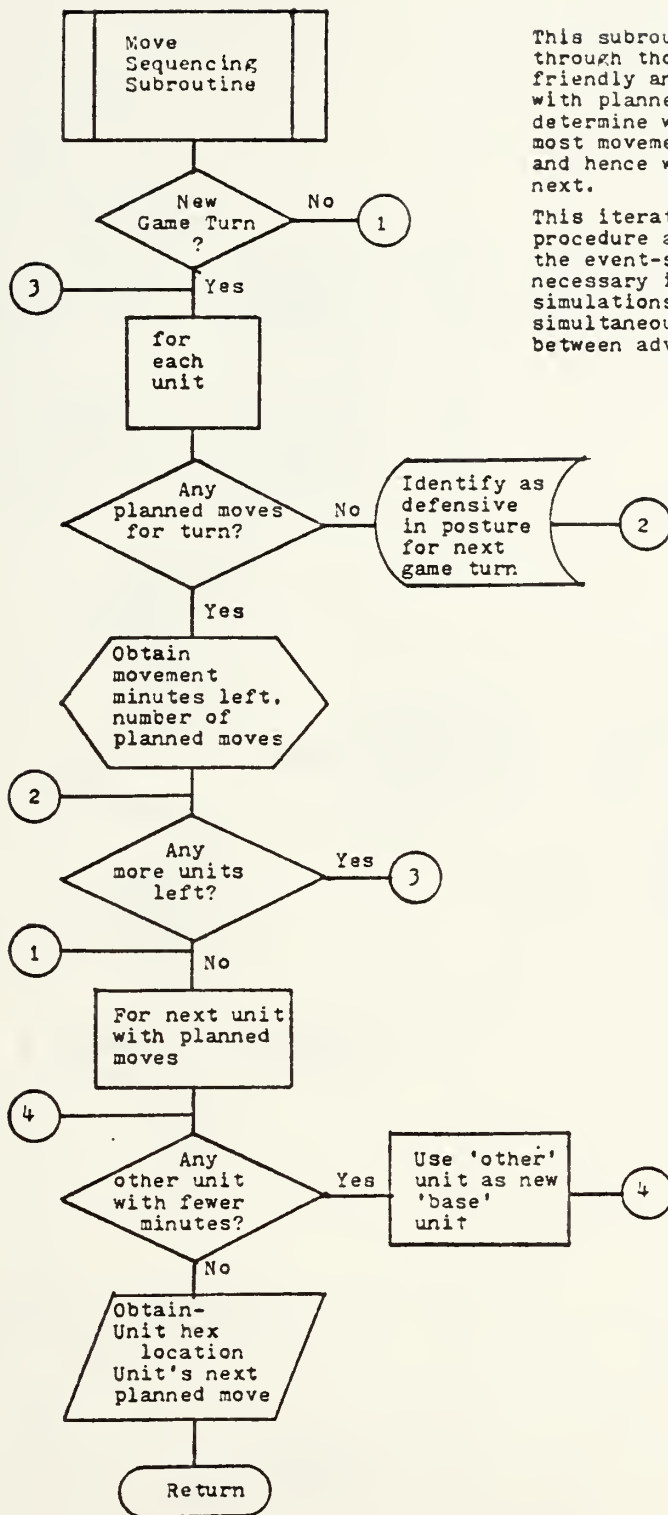

This subroutine searches through those units (both friendly and adversary) with planned moves left to determine which has the most movement minutes left, and hence which will move next.

This iterative search procedure attempts, within the event-sequencing structure necessary in computer simulations, to achieve simultaneous operations between adversaries.

FIGURE VII.2 FLOWCHART OF MOVE SEQUENCING SUBROUTINE



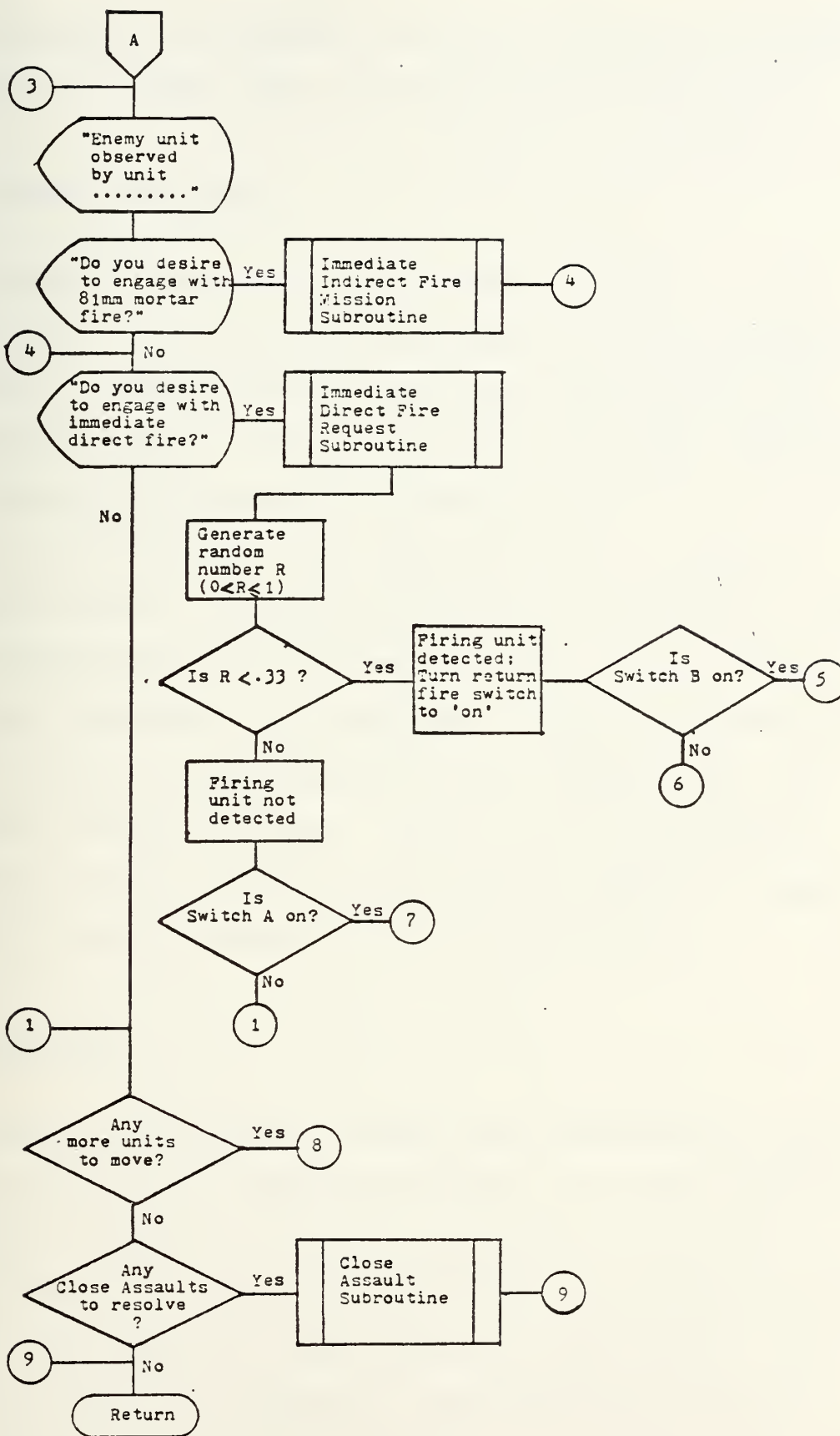

FIGURE VII.2 (CONTINUE)



that movement) is completed, creating a semblance of event-ordering consistent with simultaneous operations.

D. MOVEMENT EXECUTION.

Movement of units is accomplished one hex at a time, and as indicated previously, a movement cost (in movement minutes) is associated with each hex, depending upon the predominant terrain characteristics of that hex. Although the character of the game is uniquely dependent upon the simulation of movement, the execution of the movement is straightforward. As shown in figures VII.3 and VII.4, the hex coordinates associated with execution of the planned move are calculated, the predominant terrain characteristic of the new hex is determined, and the movement cost (in movement minutes) is found. If the unit has sufficient movement minutes available, the planned movement is executed; otherwise the unit remains in its old position.

E. DETECTION

Chapter V discussed in detail the considerations relating to surveillance and target acquisition. The logic supporting these procedures is found in figures V.9 and V.10. Surveillance and target acquisition have a pervasive influence on all other aspects of the simulation; they provide the basis upon which the battalion commanders will allocate and mass their forces and firepower.



Movement Execution Subroutine

This subroutine executes the planned movement for the designated unit, providing the 'new' hex coordinates resulting from the planned move. The move is then verified by determining if sufficient movement minutes are available to the unit to execute the move.

Obtain unit type, planned move, moves left, movement minutes left, hex location

Is planned move overwatch (OV)?

Yes: Reduce moves and movement minutes left by one (1)

An 'overwatch movement' is generated when a player wants one of his units to 'watch' as another unit moves, ostensibly to be in position to provide covering fire, if necessary.

Is movement dismount or mount?

Yes: Reduce movement minutes left by 3

No

Minutes left ≥ 0 ?

No: Reduce moves left to 0 (1)

Yes

Is movement to mount?

Yes: Change unit type to "Mounted Troops" (2)

No

Is movement to dismount?

Yes: Change unit type to "Dismounted Troops" (2)

Is movement NN?

Yes: $x(\text{new}) = x(\text{old})$
 $y(\text{new}) = y(\text{old}) + 2$ (3)

No

Is movement NE?

Yes: $x(\text{new}) = x(\text{old}) + 2$
 $y(\text{new}) = y(\text{old}) + 1$ (3)

No

Is movement NW?

Yes: $x(\text{new}) = x(\text{old}) - 2$
 $y(\text{new}) = y(\text{old}) + 1$ (3)

No

A

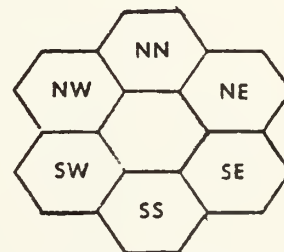

Computer reads planned moves and calculates new x-y coordinates

FIGURE VII.3 FLOWCHART OF MOVEMENT EXECUTION SUBROUTINE



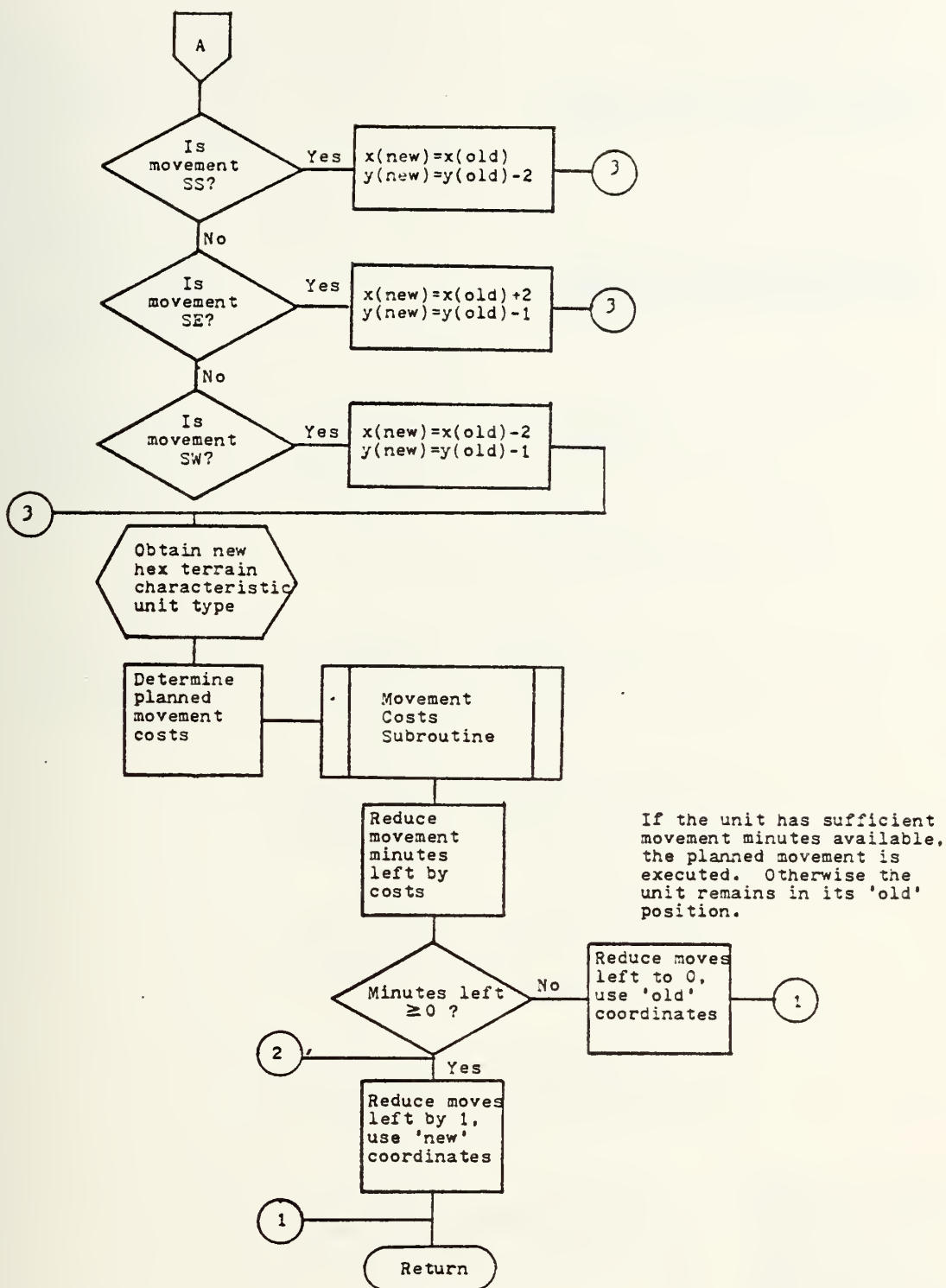

FIGURE VII.3 (CONTINUE)



Movement Costs Subroutine

This subroutine calculates the movement costs associated with each planned move.

Obtain New hex coordinates
terrain characteristics
Unit type

Movement costs are associated with terrain characteristics as well as the mobility characteristics of the type unit.

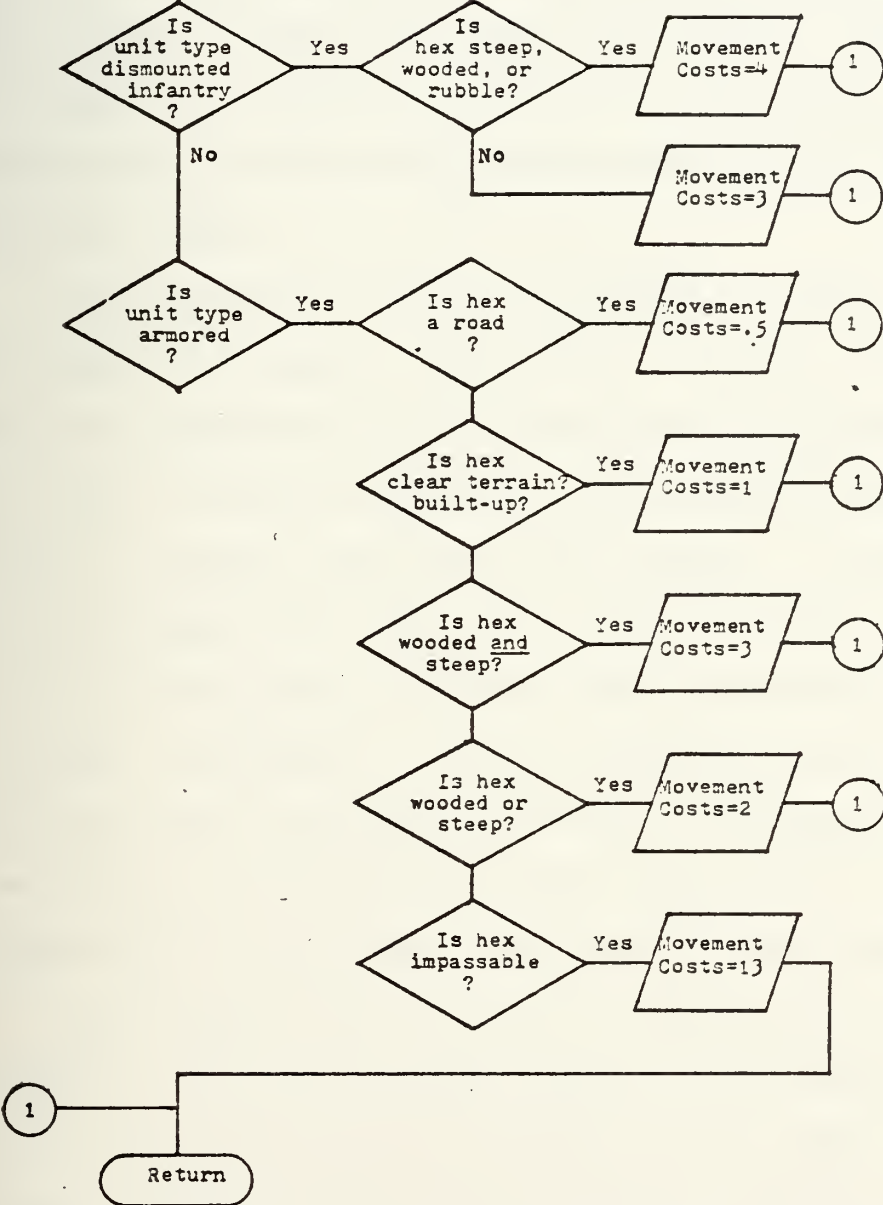

Making the movement costs associated with impassable terrain greater than 12 movement minutes insures the move is not executed.

FIGURE VII.4 FLOWCHART OF MOVEMENT COSTS SUBROUTINE



F. IMMEDIATE FIRE MISSIONS

The dynamic nature of combat is characterized by the surveillance of a target, and the initialization of engagement at the time and place most advantageous to the friendly forces. Targets of opportunity often present themselves, and if it is consistent with the unit's mission to engage that target, battle advantages may accrue. Likewise advantages can accrue by avoiding the enemy (to avoid unacceptable attrition from an engagement with a larger adversary unit).

Once detection occurs, the player is given the opportunity to engage the target. His option to engage the adversary unit with immediate direct fire remains available as long as the unit is within observation and enough movement minutes exist to support the direct fire mission. However, once having engaged the enemy with direct fire the probability of the firing unit's position being detected by the enemy is again calculated. If the determination procedure results in intervisibility being achieved, the targeted force may now execute a return fire mission (at a lower effectiveness rate because of the reactive nature of the engagement).

The targeted unit can also be immediately engaged by the organic 81 mm mortar assets held at the company level. Only 2 of these missions can be executed in a game turn, and the weapon intensity factor (K_I) used for casualty calculations resulting from 81 mm mortar attacks is equal to 0.8.



The programming logic associated with immediate direct fire missions has been previously presented in figure VI.1. Figure VII.5 schematically presents the procedural considerations for executing immediate 81 mm mortar support.

G. CLOSE ASSAULTS

Whereas direct fires are conducted at range, close assaults are representative of close combat engagements. They are initiated when units close to within adjacent hexes, and each announces its desire to pursue this intense close-range combat. Significant casualties result from these intense engagements, and the resulting attrition rates are a probabilistic function of the fire power ratio associated with the attacker vs. defender capabilities. The logic of figure VII.6 essentially duplicates the combat results table for close assault conflicts used in the manual PEGASUS game. It is noted that a probabilistic advantage accrues to the attacker, on the average, when the attacker-to-defender fire power ratios exceed 2:1.

H. PLANNING PHASE SUBROUTINES

When all movements are exhausted and close assaults resolved, the players then have the opportunity to program indirect fire support utilizing the artillery capability assigned by higher authority to support their units. This procedure has been previously discussed and is flowcharted



Immediate Indirect Fire Mission Subroutine

This subroutine assesses the casualty and suppressive effects of immediate indirect fire support missions. These missions are accomplished by organic 81mm mortar assets.

Obtain target size(T), type, disposition, and hex coordinates; and hex terrain characteristic

Add one to number of missions this game turn

missions this turn > 2?

Yes: "81mm mortar assets are committed for this game turn" (1)

A maximum of two immediate indirect fire missions can be executed in a game turn.

No: Generate random number R (0 ≤ R ≤ 1)

Is target Armored?

Yes: No casualties; Effects- E=1 iff R ≤ .83 else E=2 (2)

'Covering hex' implies that the predominant terrain characteristic is that of a wooded or built-up area.

Is target troops in offense?

Yes: E=1 iff R ≤ .33 else E=2 iff R ≤ .50 else E=3

Is occupied hex "covering hex"? Yes: I=1.0, k_I=0.8, k_T=1.0 (3); I=2.0, k_I=1.0, k_T=1.0 (3)

Is target troops in defense?

E=1 iff R ≤ .83 else E=2

Is occupied hex "covering hex"? Yes: I=1.0, k_I=0.8, k_T=0.5 (3); I=2.0, k_I=0.8, k_T=0.5 (3)

(3) Calculate personnel casualties

Update target unit effects, strength, combat power

Return

Personnel casualties are calculated using equations IV-3 and IV-4, as follows:

$$x = .5(k_I I + k_T T)(R - .5) + .5k_I k_T I T$$

$$KIA = \begin{cases} x & \text{when } x > 0 \\ 0 & \text{when } x \leq 0 \end{cases}$$

where

- I = Intensity of fire index value
- T = Target size index value
- k_I = Weapon system intensity factor
- k_T = target disposition factor

FIGURE VII.5

FLOWCHART OF IMMEDIATE INDIRECT FIRE MISSION SUBROUTINE



Close Assault Subroutine

This subroutine resolves close assault conflicts by calculating losses and determining associated retreat movements.

Algorithms were developed to mirror the Close Assault Table found in the PEGASUS Combat Results Tables booklet.

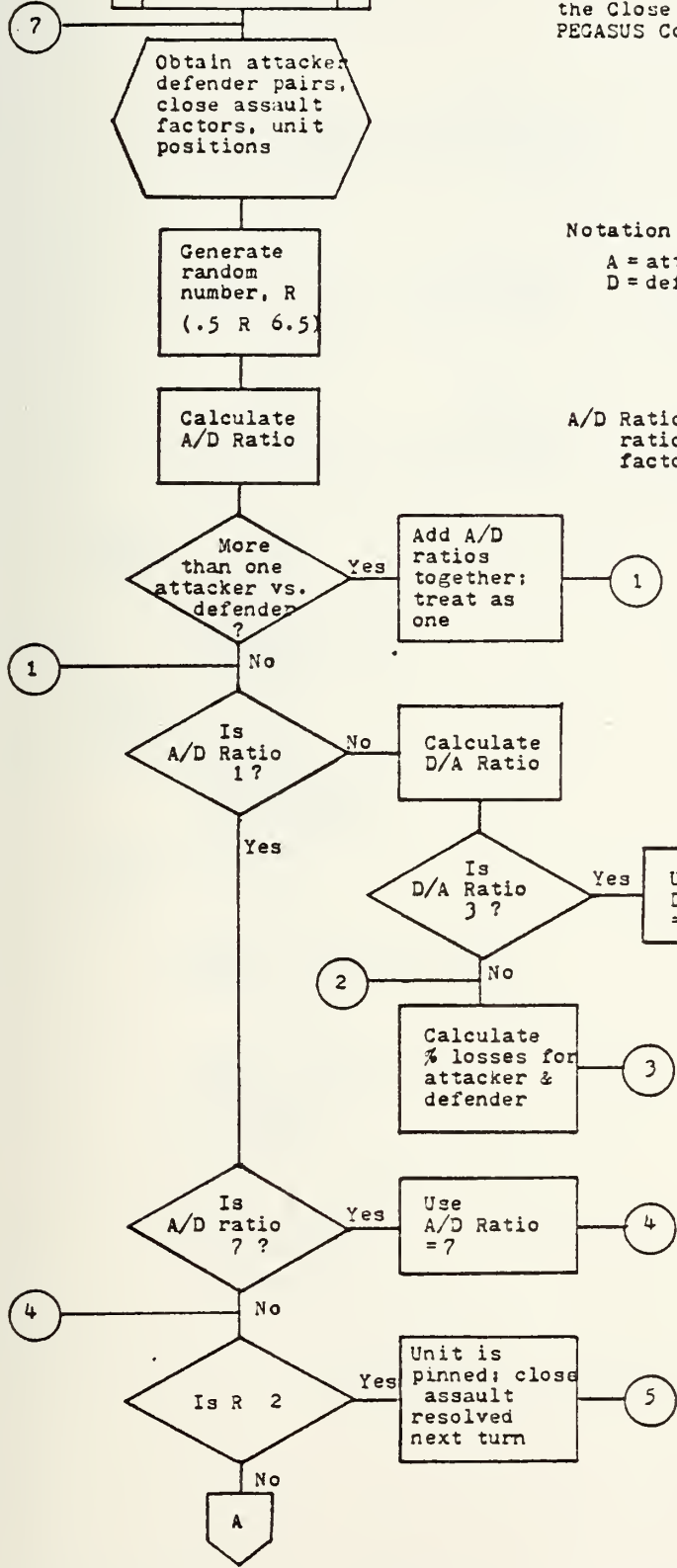

Notation

A = attacker
D = defender

A/D Ratio is the attacker to defender ratio of close assault power factors

For attacker
 $\% \text{loss} = .40 + .05(D/A \text{ Ratio} - R)$
 For defender
 $\% \text{loss} = .10 + .05(R - D/A \text{ Ratio})$

Neither unit can move until close assault phase next turn; pinning action creates varying time element in regard to close assault combat.

FIGURE VII.6 FLOWCHART OF CLOSE ASSAULT SUBROUTINE



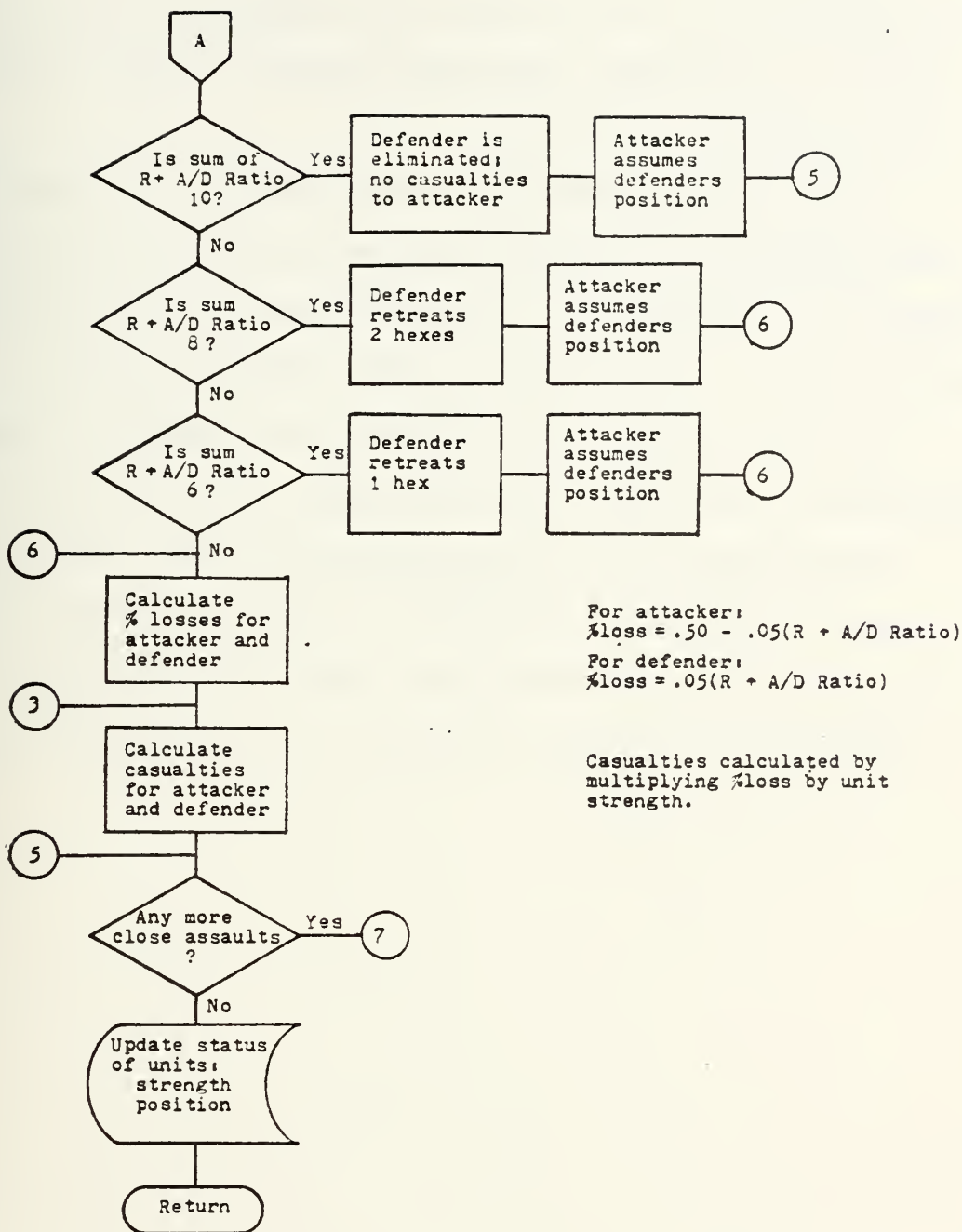

FIGURE VII.6 (CONTINUED)



in figure IV.1. If enemy forces are still observable, planned deliberate direct fire missions can be scheduled in accordance with the routine previously presented in figure VI.2.

Of particular significance, the movements for each maneuver unit are now planned and input to the computer for execution during the next game turn. As indicated in figure VII.7, an effort has been made to simplify the input procedures in order to minimize the probability of player error, as well as accelerate the input process. This can be anticipated to be the most time consuming portion of the simulation; however, extensive computer prompting with time-clock default constraints will assist and encourage each player to consider and execute his options in realistic time-frames.



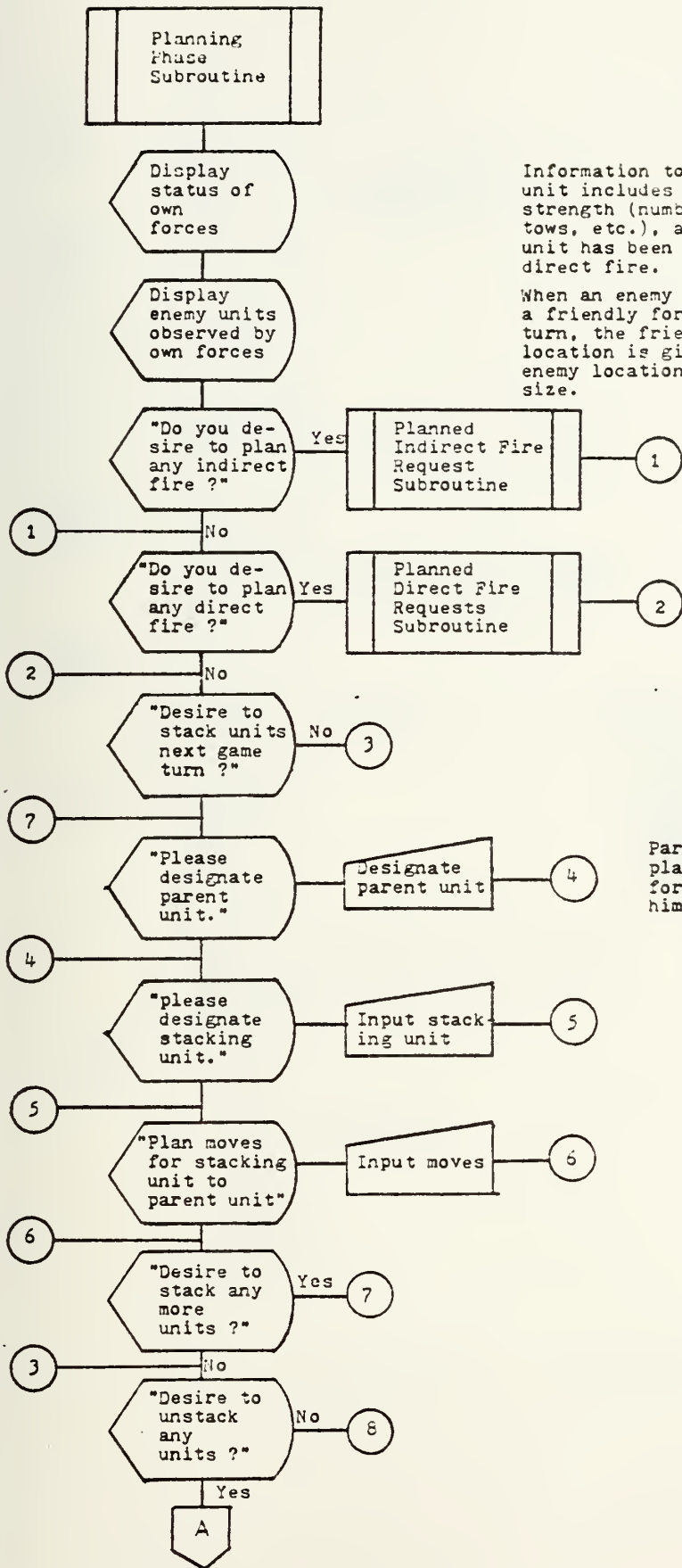

Information to be included for each unit includes unit identity, position, strength (number of personnel, tanks, tows, etc.), and notification the unit has been subject to indirect or direct fire.

When an enemy unit is 'observed' by a friendly force at the end of a game turn, the friendly unit identity and location is given, as well as the enemy location, unit type, and unit size.

Parent unit must remain in place during next game turn for 'stacking' unit to join him.

FIGURE VII.7 FLOWCHART OF PLANNING PHASE SUBROUTINE



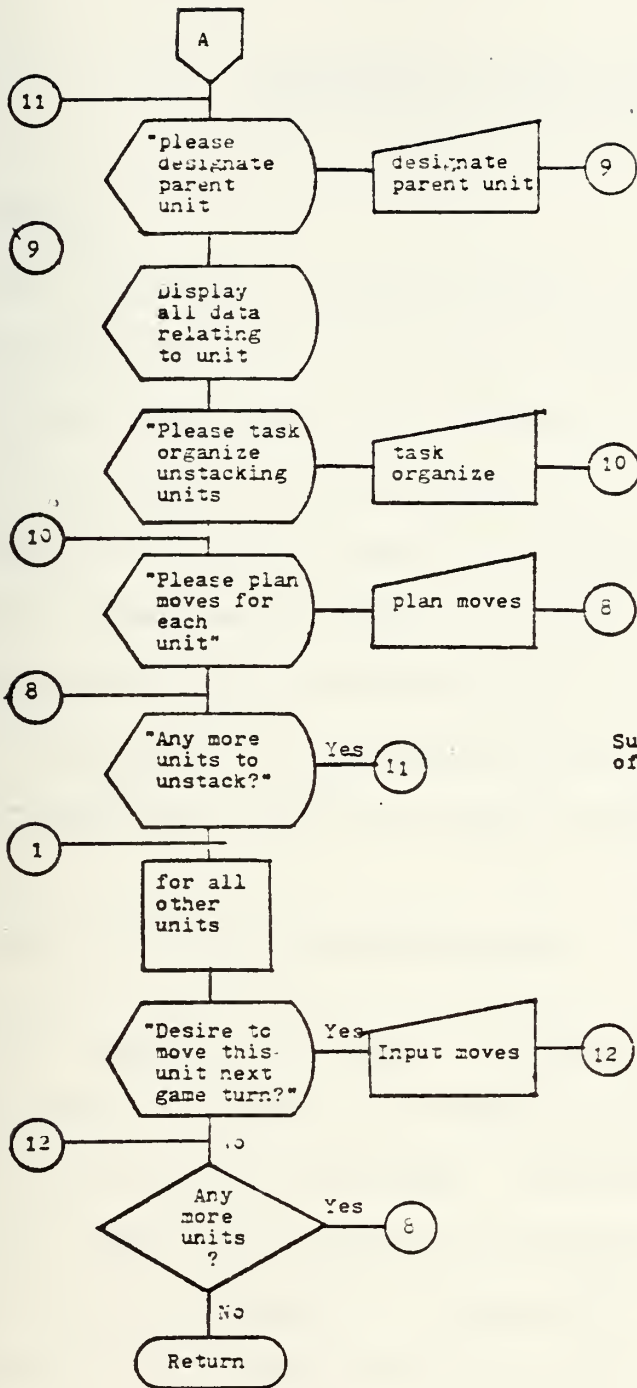

Parent unit must be platoon or company sized; smallest playing unit is a squad.

Suggested formatting for input of moves:

- OW Overwatch mission
- DM Dismount troops from vehicles
- RM Troops mount vehicles
- NN Move north
- NE Move northeast
- NW Move northwest
- SS Move south
- SE Move southeast
- SW Move southwest

Directional moves may be followed by a number indicating number of similar moves to make; i.e., NN4 would indicate to move 4 hexes in north direction.

FIGURE VII.7 (CONTINUE)



VIII. CONCLUSIONS AND RECOMMENDATIONS

A. SUMMARY

This study was initiated under the premise that an understanding of the collective structure of combat decision-making processes might be achieved by the study of existing manual war games. As an initial effort in this direction, the Army's PEGASUS war game was analyzed in depth. The analysis developed in detail the event-sequenced logic which comprises the battle simulation and structured it to serve as the framework for the programming of an interactive, computer-supported, battalion-level war game.

B. CONCLUSIONS AND RECOMMENDATIONS

The framework developed is sufficiently flexible that future weapons systems and sophisticated sensors can potentially be incorporated into the game. Accordingly, it is recommended that the framework be further developed in follow-on work in order to adapt the game to interactive-computer play. The exercising of this game with potential enhancements may provide unique insights into the processing of information and decision-making on the modern, automated battlefield.

The process of analyzing and structuring the logic of a manual war game is a unique endeavor which in itself provides some understanding of the processes of command and control



and of the information flow requirements among and within different echelons in the command hierarchy. Accordingly, it is recommended that other manual games, in particular the Army's FIRST BATTLE division level simulation, be similarly studied and structured.



GLOSSARY OF SYMBOLS

Flowchart Symbol

Interpretation



Preparation. Used to signify those items resident in the data base required to accomplish the processes that follow; an initialization symbol



Process. Used to signify calculations, operations and processes



Output. Used to signify those results calculated/generated in a processing operation

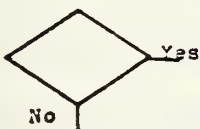

Decision. Used to indicate decision options, determining which of a number of alternative paths are followed



Display. Used exclusively to signify those computer generated displays of relevance to the players. Generally limited to paraphrasing of queries, prompting, or results



Auxiliary Operation. Used to represent minor processing actions, labeling, miscellaneous information, comments, annotations

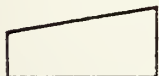

Manual Input. Used for those situations when the player must make a direct input into the computer via the console



Data-Base Storage. Used to represent those operations which essentially update the data base, and are held in storage until needed; ie., number of movement minutes left, unit strength, etc. Data base storage information is accessible to multiple subroutines

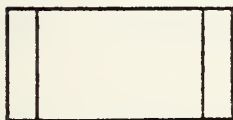

Subroutine. Symbol indicates transfer to a subroutine to execute labeled processes



Connector. On page, or within subroutine, connector



Offpage Connector.

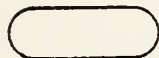

Terminal Interrupt. Used principally to indicate end of subroutines, and return to calling routine

APPENDIX A



Appendix B

DATA BASE ORGANIZATION

A. GENERAL

The following represents the author's conception of the data base upon which the logic of the presented subroutines was developed. The actual organization utilized if the program were to be implemented would be dependent not only on the computer hardware and software available, but also on the judgement of the actual programmer.

The data used in the subroutines essentially fit into three categories: hex-related, unit-related, and program-related.

B. HEX-RELATED DATA

Hex-related data refers primarily to the large table that characterizes the terrain of the battlefield. The data items included are:

1. Hex Location

The location of a hex is identified by a six-digit number consistent with military grid coordinates. The first three digits are referred to in the program as the x-coordinates; the second three digits are referred to as the y-coordinates. The hex location is the primary link to all other hex-related data items.



2. Terrain Characteristics

Associated with each hex is a dominant terrain characteristic. An appropriate code would identify the following possible characteristics:

- a. Clear terrain
- b. Roads
- c. Built-up areas
- d. Wooded terrain
- e. Steep and clear terrain
- f. Steep and wooded terrain
- g. Impassable terrain

3. Hex Elevation

The average elevation of the hex is maintained for line-of-sight calculations.

C. UNIT-RELATED DATA

Unit-related data refers to those data items that refer to the capability, disposition and vulnerability of each unit in the game play. The data items included are:

1. Unit Code

The unit code would identify each specific unit being played, and would be the primary link for all other unit-related data items. Incorporated into the unit code would be a system that identifies:



- a. Whether the unit is a U.S. or opposing force unit.
- b. The size of the unit (squad, platoon, company).
- c. The type of unit (tanks, dismounted troops, or mounted troops).

2. Combat Capability

Associated with each unit is its combat capability.

This is represented by the following data items:

- a. Close Assault Factor

A factor unique to PEGASUS game which generalizes the relative combat powers of different unit types and sizes.

- b. Movement Minutes Available.

- c. Unit Strength

Unit strength is characterized by the number of personnel in the unit, if it is a troop unit, and by the number of tanks or armored vehicles if it is an armored unit. Attrition of these strengths is the principal objective of the indirect and direct fire casualty algorithms.

- d. Weapon Systems

Direct fire subroutines require identification of which type (and quantity) of anti-armor weapon systems are held by each unit. Accordingly, the number of anti-tank guided missiles, guns, and troop anti-armor missiles held by each unit must be identified.



e. Type of Fire

Direct fire is broken down to include deliberate and return fire. This data item dynamically changes during a game turn.

f. Effectiveness

The effectiveness of a unit's direct fire is modified by the suppressive effects of fire engagements. An Effects Index has been created to accomodate this aspect of combat.

3. Unit Location

The six-digit coordinate associated with each unit's location. Tests for occupancy of a hex are accomplished by searching through these data items, rather than through the hex-related data base.

4. Vulnerability

Vulnerability in the unit data base is a function of the unit disposition. Disposition refers to the combat orientation of the unit (troops in the offense, troops in the defense), as well as whether or not the unit is in terrain that protects him.

D. PROGRAM-RELATED DATA

Numerous tables and switches have been incorporated to provide for procedural control of the program. Significant among these data items are:



1. Observation and Line-of-Sight Pairings

Indication that line-of-sight or visual contact exists.

2. Effects Index

This index indicates the degree to which the effects of a fire mission suppress the fire and maneuver capability of a unit.



REFERENCES

1. Command and Control Technical Center Computer System Manual CSM UM-244-78, Vector-2 System for Simulation of Theater-Level Combat - Users Manual, 15 February 1978.
2. Department of the Army, Review of Selected Army Models, by J. Honig, and others, May 1971.
3. General Research Corporation OAD-CR-73 Vol. I, Carmonette, Volume I, General Description, by G.S. Colonna and R.G. Williams, p. , November 1974.
4. General Research Corporation OAD-CR-73 Vol. II, Carmonette, Volume II, Data Preparation and Output Guide, by G.S. Colonna and R.G. Williams, p. , November 1974.
5. Hausrath, A.H., Venture Simulation in War, Business, and Politics, McGraw-Hill Book Company, 1971.
6. Huber, R.K., Jones, L.F., and Reine, E., Military Strategy and Tactics-Computer Modeling of Land War Problems, Plenum Press, 1974.
7. Rand Report R-1526-PR, Models, Data, and War: A Critique of the Study of Conventional Forces, by J.A. Stockfish, March 1975.
8. U.S. Army Combined Arms Training Developments Activity, Battle Simulations and the ARTEP, Fort Leavenworth, KS, November 1977.
9. U.S. Army Combined Arms Training Developments Activity GTA 71-2-1, PEGASUS Rules, Fort Leavenworth, KS, 1978.
10. U.S. Army Combined Arms Training Developments Activity GTA 71-2-1 (14), PEGASUS Organizer's Guide, Fort Leavenworth, KS, 1978.
11. U.S. Army Combined Arms Training Developments Activity GTA 71-2-1 (15), PEGASUS Control Group Instructions, Fort Leavenworth, KS, 1978.
12. U.S. Army Combined Arms Training Developments Activity GTA 71-2-1 (16), PEGASUS Evaluation Guide, Fort Leavenworth, KS, 1978.



13. U.S. Army Combined Arms Training Developments Activity
GTA 71-2-1 (17), PEGASUS Combat Results Tables, Fort
Leavenworth, KS, 1978.
14. U.S. Army Combined Arms Training Developments Activity
GTA 71-2-1 (18), PEGASUS Opfor Tactics, Fort Leaven-
worth, KS, 1978.
15. U.S. Army Combined Arms Training Developments Activity
GTA 71-2-1 (19), PEGASUS Admin/Log Reference Data,
Fort Leavenworth, KS, 1978.
16. U.S. Army Combined Arms Training Developments Activity
GTA 71-2-1 (32), PEGASUS Electronic Warfare Effects
Folder, Fort Leavenworth, KS, 1978.
17. U.S. Army Combined Arms Training Developments Activity
GTA 71-2-3 (8), FIRST BATTLE Basic Rules, Fort Leaven-
worth, KS, 1978.



INITIAL DISTRIBUTION LIST

	No. Copies
1. Library, Code 0142 Naval Postgraduate School Monterey, California 93940	2
2. Curriculum Advisor, Code 039 Joint Command, Control and Communications Curriculum Naval Postgraduate School Monterey, California 93940	3
3. Professor J. Wozencraft, Code 74 Department of Electrical Engineering Naval Postgraduate School Monterey, California 93940	3
4. Professor George A. Rahe, Code 52 Ra Computer Science Department Naval Postgraduate School Monterey, California 93940	1
5. Professor Paul Moose, Code 61 Me Physics and Chemistry Department Naval Postgraduate School Monterey, California 93940	1
6. Major Dominic Nicolosi, Jr. 1083 Spruance Road Monterey, California 93940	5
7. Defense Documentation Center Cameron Station Alexandria, VA 22314	1



Thesis
N5755
c.1

Nicolosi

187375

A framework for an
interactive, computer-
supported, battalion-
level war game.

30 OCT 86

16 AUG 89

16 AUG 89

33364
80063
80063

Thesis
N5755
c.1

Nicolosi

187375

A framework for an
interactive, computer-
supported, battalion-
level war game.

thesN5755

A framework for an interactive, computer



3 2768 001 94671 8

DUDLEY KNOX LIBRARY