

(43) Date of A Publication 23.08.2000

(21) Application No 9907693.7  
(22) Date of Filing 01.04.1999  
(30) Priority Data  
(31) 09251591 (32) 17.02.1999 (33) US

(71) Applicant(s)  
3Com Corporation  
(Incorporated in USA - Delaware)  
5400 Bayfront Plaza, P O Box 58145, Santa Clara,  
California 95052-8145, United States of America

(72) Inventor(s)  
Jon Jameson Burgess  
Thomas C Hogan

(74) Agent and/or Address for Service  
Bowles Horton  
Felden House, Dower Mews, High Street,  
BERKHAMSTED, Herts, HP4 2BL, United Kingdom

(51) INT CL<sup>7</sup>  
H04L 12/44 , H04H 1/02

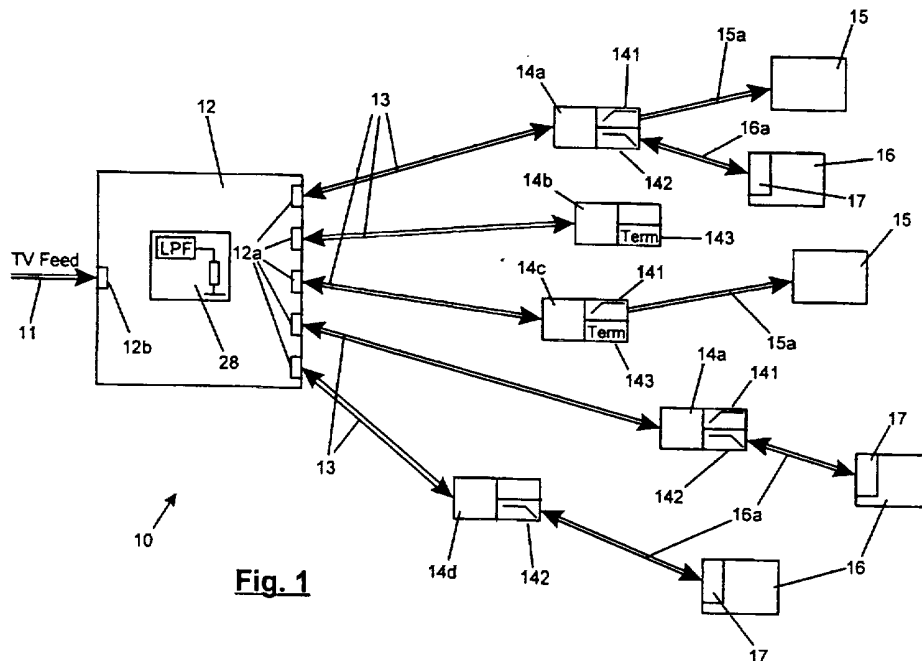
(52) UK CL (Edition R )  
H4P PPBC PPNE  
U1S S2123 S2202 S2206

(56) Documents Cited  
EP 0412220 A1 EP 0292072 A1

(58) Field of Search  
UK CL (Edition Q ) H4P PPBB PPBC PPC PPNE  
INT CL<sup>6</sup> H03H , H04H , H04L  
Online: WPI, JAPIO, EPODOC

(54) Abstract Title  
**Network connections**

(57) A network includes one or more passive communications hub 12 having a number of ports 12a, with the network being made up of connections to, and optionally interconnections between, the ports. The network is arranged to carry electrical signals of different frequencies and characteristics. In particular the network distributes DC signals substantially without attenuation, and oscillation signals substantially without reflection. In the preferred implementation, the network carries both TV signals and computer network signals, such as ethernet signals. In this context the carrying of DC signals substantially without attenuation, by way of a controlled DC resistance in the network, enables the proper functioning of ethernet collision detection.



**Fig. 1**

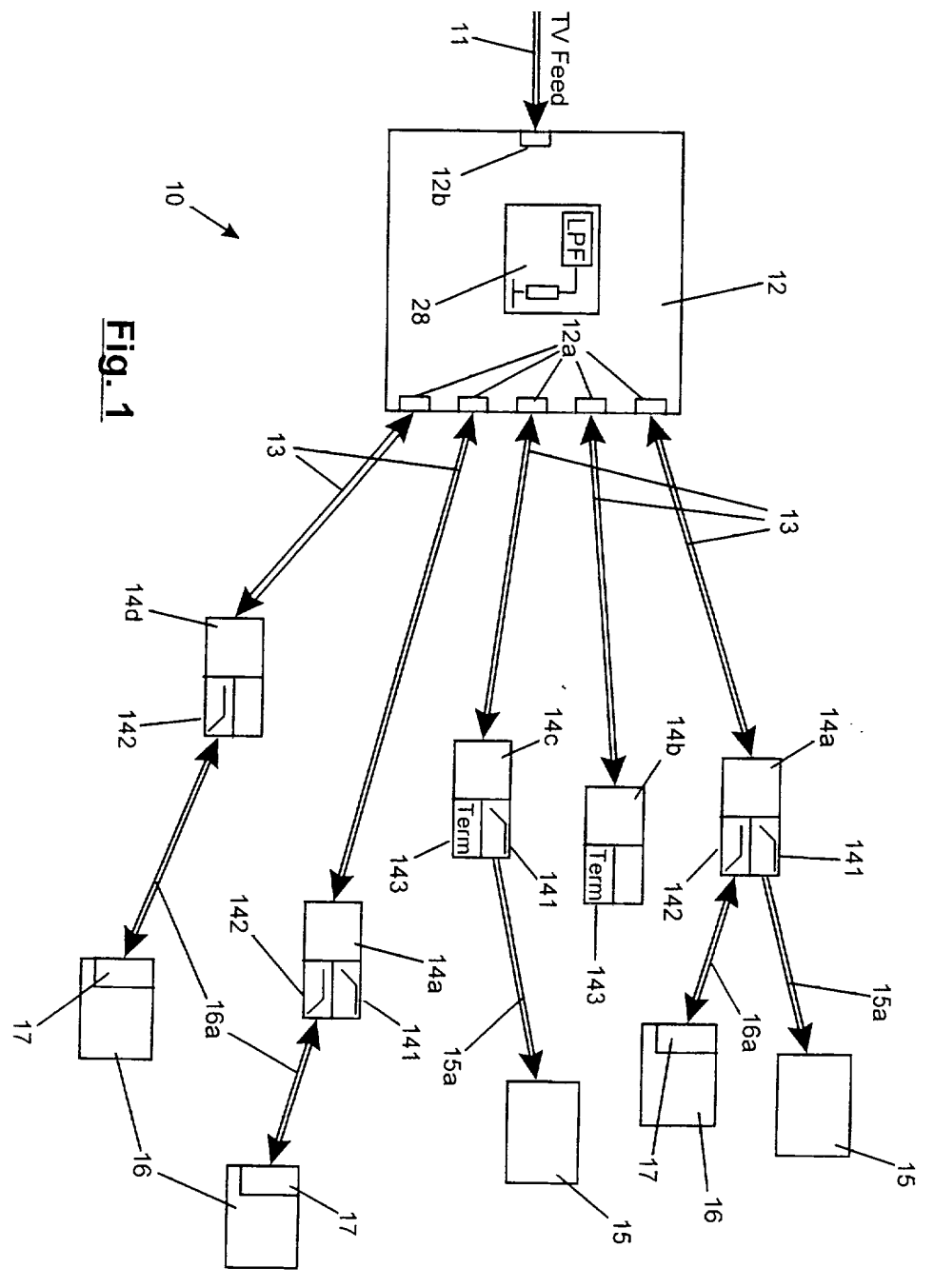
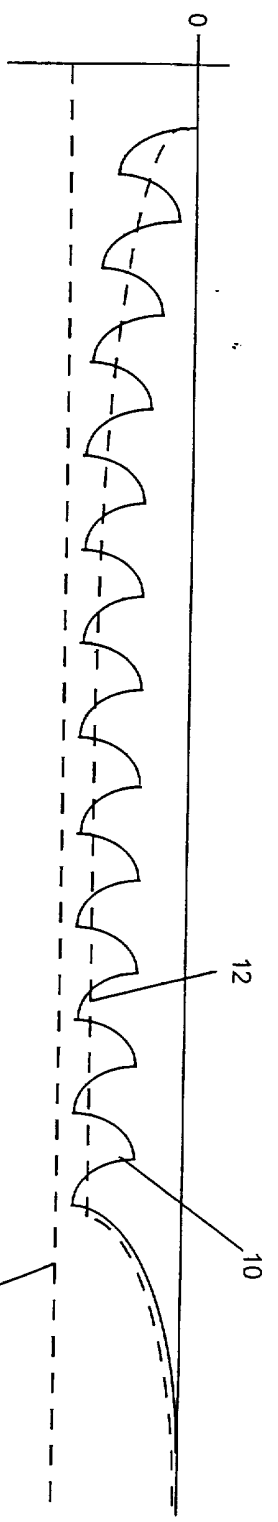
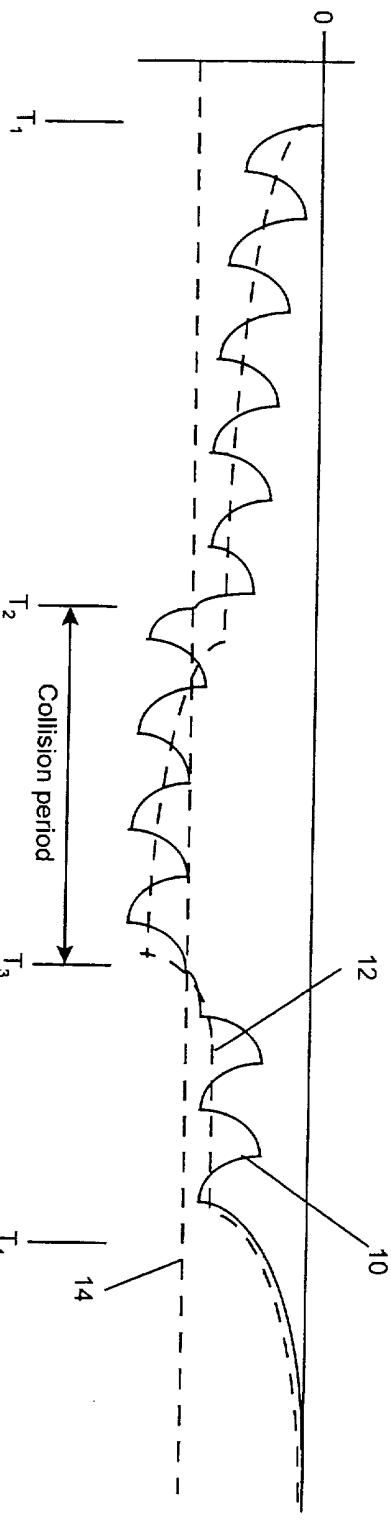


Fig. 1

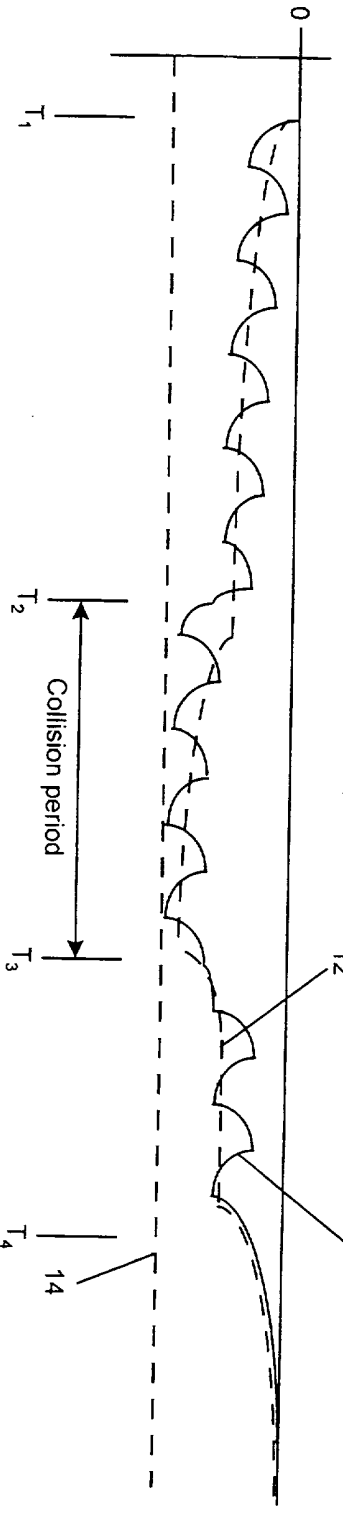
**Fig. 2a**

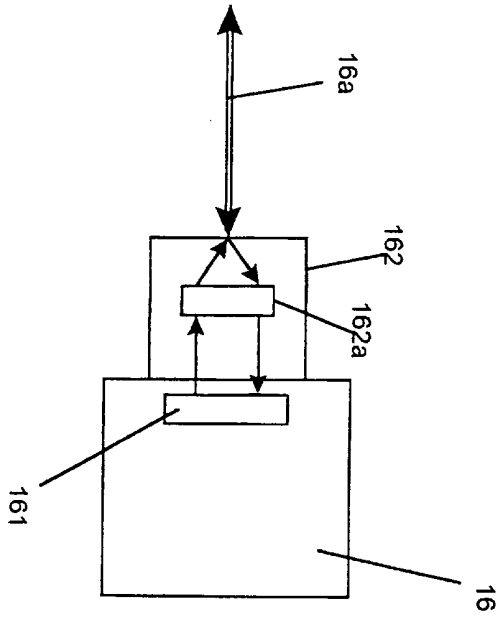


**Fig. 2b**

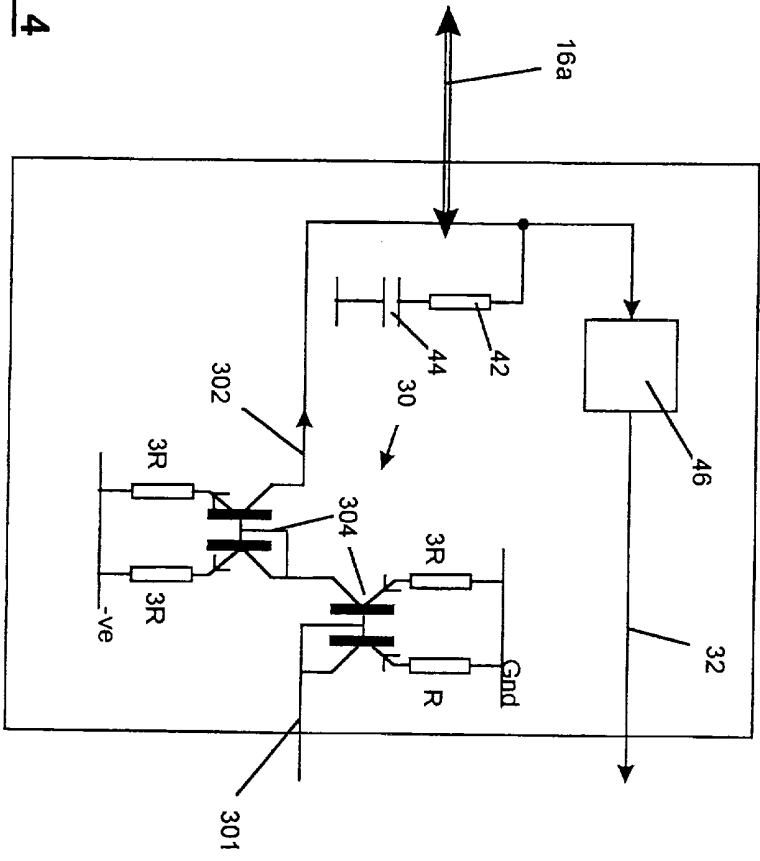


**Fig. 2c**





**Fig. 3**



**Fig. 4**

COMPUTER/TELEVISION NETWORKBACKGROUND OF THE INVENTIONField of the Invention

5           The present invention relates to the provision of a network of cabling and other elements which is suited to the distribution of electrical signals of different frequencies, including DC signals. One type of such network carries television signals and also communications in a computer network, for instance operating according to the Ethernet protocol.

10       The Prior Art

          In domestic situations it is well known to distribute television signals to different rooms in a house. In particular this may be implemented by taking an input feed from a receiving aerial, satellite antenna, cable TV supply or other signal source and pass it through a signal splitting device from where the  
15       signal can be carried via coaxial cables, to other desired locations. One or more such splitting devices may be used to construct what is essentially a tree or star arrangement of cable segments to provide convenient distribution of the TV signal to the desired locations in the home. Such arrangements are not limited to domestic use and may be implemented in any relatively small scale environment  
20       where the cable runs are not so long that active amplification and/or reconstitution of the distributed signal is necessary.

          In a domestic or other small scale arrangement as outlined above, the splitting devices are designed so as distribute TV signals which are typically in the frequency range 45 - 900 MHz.

25       It is also well known to provide computer networks comprising cabling arranged to interconnect computers and other network devices in order to enable the devices to communicate with each other for instance to facilitate the sharing of resources and data and to enable users of the network equipment to

communicate with each other. A number of different network topologies and associated communication protocols have been proposed to enable communication between computing devices in this fashion, and some of these are outlined in the following.

5           In one system, an essentially passive transmission line arrangement is provided to carry communications between devices attached to the network. In essence, this is one length of transmission line, having appropriate terminations at each end to which all of the network devices are connected and to which all of the network devices apply communications to be sent to other devices. Such an arrangement is typically implemented using co-axial cable looped from one network device to the next and having a terminator device at each end. Each network device therefore effectively looks both ways along the transmission line and the same impedance is presented to each network device.

15           One communications protocol which is well known to be used on networks connected in this fashion is 10Base-2 Ethernet which is a collision sense protocol in which any network device which requires to send a communications packet attempts to apply the packet to the transmission line. In the event that no other device is attempting to communicate at the same time, the transmitted communications packet travels to all of the other devices connected to the network and can therefore be identified and received by the intended recipient. If however it is detected that two or more devices have attempted to put a communication on transmission line at the same time this is sensed by the devices attempting to send communications and these devices assume that the transmitted communication has not been properly received and, after an appropriate time, transmission is reattempted.

25           In a protocol such as 10Base-2 Ethernet the transmission protocol is arranged such that during the transmission of a data packet a constant DC voltage level different from zero is created on the transmission line and this is

used in the collision detection mechanism. In particular, if two packets are being transmitted onto the communication line simultaneously, the overall DC level will be twice the value as that which would be the case if only one communication were being attempted. The network devices have threshold detectors which detect such an increase in the DC level and which therefore detect the occurrence of collisions. This system, broadly outlined above, functions satisfactorily on a single transmission line arrangement as mentioned above and is a well used protocol.

Other, later, Ethernet standards are fundamentally different from the 10Base-2 arrangement outlined above in that they are not passive transmission arrangements but include active components. In particular, networks operating according to, for instance, the 10Base-T protocol, are connected in a star or tree formation in which there are provided communication hubs having a plurality of ports to each of which a network device or another hub may be connected. The communications hubs function according to various well known principles to retransmit communications received on their ports to the others of the ports thereby enabling the communication sent out by the network devices to reach the other network devices in the network. The connections between the network devices and the communications hub in this arrangement are typically made by twisted pair data cable and the active communications hubs ensure proper retransmission of the data throughout the network thereby enabling, among other things, proper collision detection to be conducted.

There have also been proposals to integrate Ethernet with TV distribution. One such arrangement proposes remodulating the Ethernet communication signals to fall within the typical frequency band of the TV signals such that they are properly distributed by TV distribution equipment. This arrangement however requires complex further re-modulation equipment which would be dynamic or active equipment requiring a power supply.

The parallel distribution of TV and Local Area Network (LAN) signals is also considered in other areas, for instance in a video conferencing network in US Patent 5,374,952. In such an arrangement however separate cables are provided to carry the TV and the computer network signals.

5 SUMMARY OF THE INVENTION

The present invention has been made against the above background and aims to implement a star or tree connected computer network, preferably in the context of a TV distribution system, which operates as a passive network in which data is distributed and proper collision detection takes place. Such a  
10 network has particular advantages where it is desired to provide a relatively low cost network, in which case it is useful to have a passive network, but where the devices to be connected in the network are relatively widely spaced, where it would be inconvenient to provide a looped transmission line from one network device to the next.

15 The invention as mentioned also aims to combine the distribution of TV signals with the interconnection of network devices to form a network, taking advantage of the fact that both TV distribution systems and 10Base-2 networks utilise coaxial cable to carry the signals. Such an arrangement would be particularly useful for instance in the circumstance where it is desired to  
20 implement a computer network in a home or other environment where a TV distribution system as outlined above is already in place. This would have clear advantages in terms of not requiring the installation of further cabling as the TV distribution system already provides cable to a number of locations.

25 Potential difficulties with such an implementation include the different topographies of the two systems. That is, as outlined above, a typical TV distribution system is generally a star or tree configuration while a known 10Base-2 type network is essentially a single transmission line arrangement. Also, communication signals in a computer network such as Ethernet 10Base-2 are



typically in the frequency range 5 - 20 MHz and therefore would not be carried properly by standard TV distribution devices as discussed above. A further difficulty is the fact that TV signals are typically distributed using 75Ω steel cored coaxial cable while the coaxial cable used to form the transmission lines for a typical Ethernet 10Base-2 network is 50Ω cable.

Also, as will be explained in more detail later, it is important when dealing with Ethernet type signals, to ensure that low frequency and DC signals are carried properly around the network in order to ensure proper operation of collision detection mechanisms in the network devices.

Broadly speaking the invention provides a network which handles signals in three different frequency ranges differently. Firstly, high frequency TV signals typically having a frequency higher than approximately 50 MHz are carried around a star or tree type network in a manner similar to known TV signal distribution arrangements. Secondly, Ethernet data signal, typically in the frequency range 5-17 MHz are carried around the network without reflection such that they reach all of the users attached to the network. Thirdly, effectively DC signals, say having a frequency less than 2 MHz, are carried around the network without substantial attenuation to facilitate proper operation of collision detection mechanisms.

The present invention provides a network arranged to distribute TV signals and to carry data communications between computing devices attached to the network, the network comprising a passive communications hub having a plurality of ports, a plurality of cable segments suitable for the transmission of TV signals and a plurality of termination devices, the cable segments each being arranged to connect a termination device to a port on the communications hub, the communications hub being arranged to distribute TV signals therethrough and also comprising means arranged to receive data communications at any port without reflection and to provide the received data communications as outputs at

others of said plurality of ports, each said termination device comprising termination means arranged such that data communications are not reflected at such termination means, at least one of said termination devices being arranged to present said TV signals as an output from the network and at least one of said termination means being arranged to present data communications received via a respective cable segment as an output from the network.

In such an arrangement the cable segments already in place in a domestic installation for carrying TV signals between the splitting devices and locations in the home are utilised also to carry Ethernet or other network signals. As compared to the standard TV distribution arrangement, the signal splitters are replaced by passive communication hubs which are designed to handle signals in the frequency range of data communications in a computer network in addition to the TV signal frequency range. The termination devices are arranged to terminate the cable segments properly from the point of view of the computer network communications. They may also provide one or other of the TV signals and the computer network communications as outputs enabling a network device or a TV station or both to be connected at each of the locations served by the network. A preferred arrangement for this is to provide appropriate filters for the two types of signal, typically a high pass filter for the video signal and a low pass filter for the baseband data signal. If only the video output is required, a correct impedance load for the unused data signal is provided.

The arrangement according to the present invention is advantageous as compared to the prior art as it does not require any additional wiring extra to that provided in a normal TV distribution arrangement also to carry communications in a computer network. Also, the distribution device is merely a passive device which retains the simplicity inherent in a normal TV distribution arrangement.

In another aspect of this invention there is provided a network

interface connector for a network device to be attached to a computer network, the device comprising means to convert standard computer network signals suitable for distribution via a network presenting a first characteristic impedance to signals suitable for distribution via a network presenting a second characteristic impedance. For instance, the interface may be arranged to convert signals suitable for transmission via a standard 10Base-2 arrangement to signals suitable for transmission via the TV cabling discussed above.

In particular, it will be appreciated from the above discussion that the characteristic impedance presented to a standard Ethernet network transceiver differs from that presented by cable typically used to distribute TV signals. The cable generally used in Ethernet networks has a characteristic impedance of  $50\Omega$  while TV coaxial cable is typically of  $75\Omega$  characteristic impedance. In this aspect of the invention therefore currents are applied to the cabling of a suitable magnitude such that the expected voltage levels are detected for proper operation of the collision detection mechanism.

In the preferred embodiment of a network according to the present invention it may be the case that one of the communication hubs is designated a master device. This device would receive the TV signal to be distributed and may also include means to prevent the transmission of the network communications along the cabling carrying the incoming TV signal, as such transmission may affect the proper functioning of the overall TV network.

Alternatively it may be that a cable TV company may designedly provide for instance Internet access via the same cable as it provides TV feed signals. In this case the master device would be arranged also to receive and distribute the received Internet signals in an appropriate fashion.

In another aspect the present invention provides a computer network for the interconnection of a plurality of network devices to enable data communications to be sent therebetween comprising a passive communications

hub having a plurality of ports, and a plurality of cable segments each arranged to connect a network device to a port on the communications hub, the communications hub comprising means arranged to receive data communications at any port without reflection and to provide the received data communications as outputs at the others of said plurality of ports, and means defining a low DC resistance between the ports, the network further comprising means defining an effectively infinite DC resistance at the ends of said cable segments distant from said communications hub, except that there is further provided within the network means defining a predetermined DC resistance effective throughout the network.

10 It is envisaged that such a network would be implemented using coaxial cable to connect from the passive hubs to the network devices and the network devices would put their communications onto the cables in the normal way. In such a network clearly the cable is selected and the passive hubs designed so as to provide correctly matched impedance at the data transmission frequencies such that the data is correctly carried around the network. Also, at each network device there will be provided an interface having the correct termination impedance at the data frequency.

This aspect of the invention is preferably implemented together with the combined TV/Ethernet arrangement outlined above. In this case the network transceivers must either be especially designed or provided with interface means such that appropriate signal levels are generated in the TV cabling which is of a different characteristic impedance.

The network may alternatively be designed such that unaltered 10Base-2 network transceivers may be used at the network devices. This could be achieved by the use of 50 $\Omega$  co-axial cable and the passive hubs would have appropriately matched impedances at the ports.

In these arrangements however the signals are liable to be attenuated as they pass through the hub and around the network. For the transmission and

reception of the data communications this does not present a significant problem as the dynamic range of the transceivers is able to cope with some attenuation.

However, as discussed above, the detection of collision in, for example, a 10Base-2 network relies on the proper detection of DC voltage levels, and therefore any significant attenuation of the DC signal will cause the collision detection to fail and the network to function incorrectly.

In the present invention therefore the above defined measures mean that DC signals are carried around the network without substantial attenuation occurring, permitting the collision detection to function in the normal way.

#### 10 BRIEF DESCRIPTION OF THE DRAWINGS

This invention will be better understood from the following description of preferred embodiments given by way of example and with reference to the accompanying drawings, in which:

Figure 1 is a schematic illustration of a network according to a preferred embodiment of this invention;

Figure 2 is a diagram useful to assist understanding of the collision detection mechanism; and

Figures 3 and 4 illustrate one embodiment for connection of a network device to the network of Figure 1.

#### 20 DETAILED DESCRIPTION OF THE DRAWINGS

In general terms in the described arrangement a network includes one or more passive communications hub having a number of ports, with the network being made up of connections to, and optionally interconnections between, the ports. The network is arranged to carry electrical signals of different frequencies and characteristics. In particular the network distributes DC signals substantially without attenuation, and oscillation signals substantially without reflection. In the preferred implementation, the network carries both TV signals and computer network signals, such as ethernet signals. In this context the

carrying of DC signals substantially without attenuation, by way of a controlled DC resistance in the network, enables the proper functioning of ethernet oscillation detection.

5 Fig. 1 is a schematic illustration showing a first example network 10 which distributes TV signals to TV devices 15 and provides a local area network enabling data communications to pass between computer network devices 16. The TV signals and data communications are both carried via the coaxial cable segments 13.

10 It is envisaged that the cable segments 13 are those previously present, for instance, in a home for the purpose of distributing TV signals from a single feed point to various rooms in the home. Alternatively it may be that cable segments 13 are specifically installed for implementing a network according to this invention, but in any event, and advantageously from the wiring point of view, the same cable is used to carry the TV and data communication signals.

15 At the heart of network 10 is hub 12 which has a plurality of ports 12a. It also has a port 12b via which a TV signal feed is received. The TV signal feed may be derived from an appropriate source, eg. TV aerial, satellite dish, cable TV supplier, VCR or a combination of these. Hub 12 handles the received TV feed signal in a similar fashion to known TV signal distributors, that is it presents  
20 the TV signal as an output at each of ports 12a such that it is carried via cable segments 13.

Typically, the TV signals will be in the frequency range 45-900 MHz. As will be described in detail below, the cable segments 13 also carry data communications passing between network devices 16, and these are typically in  
25 the frequency range 5 to 20 MHz.

As can be seen in Fig. 1, each cable segment 13 which is connected to a port 12a of hub 12 is also connected at its other end, to a termination device 14. Although in a simple TV signal distribution system, cable segments not

attached to a TV device can be simply left unconnected to anything, in this network it is important, for reasons explained below, that each cable segment 13 is connected to a termination device 14, of which there may be present a number of different types, designated 14a, 14b, 14c, 14d.

5           In termination devices 14a, 14c, to which a TV device 15 may be connected there is provided a TV signal output means 141. This is essentially a high pass filter means arranged to output, via a further cable segment 15a, the TV signal only, for reception by TV device 15. As mentioned above, there are no problems caused by leaving a TV signal output not connected or electrically  
10   “hanging” and therefore it may well be that all the termination devices 14 in a network would be provided with TV signal output means 141, even where no TV device 15 was currently present. However it is possible to provide some termination devices 14b, 14d without TV signal output means 141, for instance for use where it is known that no TV device 15 will be used or where it is desired to  
15   prevent access to the TV signal.

The TV feed signal is thus distributed by being received at port 12b of hub 12, transmitted to cable segments 13 via ports 12a, passing through termination devices 14 via TV signal output means 141 where present and passing via cable segments 15a to TV devices 15.

20           The termination devices 14 also are arranged to handle the data communications which pass via cable segments 13 between the network devices 16 connected to the network. As will be described in more detail in the following, each termination device 14 is provided either with data communication output means 142 when it is desired to connect a network device 16 to the particular  
25   termination device 14 or with a termination means 143 where no network device is connected. Although each termination device 14 in Figure 1 is illustrated as having one or other of these items it would equally be possible and convenient to have both provided within each termination device, the necessary one being

switched into operation according to whether a network device is connected.

As illustrated in Figure 1 termination devices 14a, 14d are provided with data communication output means 142. Essentially this is a low pass filter means arranged to output, via a further cable segment 16a, the data communication signals only for reception by network devices 16. In the simplest arrangement the data communication output means 142 may simply provide a straight through path between cable segment 13 and cable segment 16a for the lower frequency signals forming the data communications such that they reach network devices 16. As will be described in more detail below, network devices 16 are provided with transceiver means 17 which, amongst other functions, properly terminate cable segments 16a at the data communication frequencies such that no reflections are generated as is well known to be important in data communication arrangements.

In termination devices 14 to which no network device 16 is connected, there is no such termination provided by a transceiver 17. It is therefore necessary to provide termination means 143 in termination devices 14b, 14c to which no computing device 16 is attached. Termination means 143 simply provide the necessary data frequency impedance at the end of the cable segments 13 such that no reflection of the data communications is generated which would otherwise interfere with the proper operation of the data communication side of the overall network.

It will be appreciated that data communication output means 142 is in fact a two-way communication device allowing data communications received from a connected cable segment 16a to be passed to the corresponding cable segment 13 and thereby to hub 12. Hub 12 is provided with means to ensure that all communications received at any one of ports 12a that the data communication frequency is provided as an output at the others of ports 12a such that data communications transmitted by any one of computing devices 16 reach the others of computing devices 16 to enable the computer network to function.



Hub 12 also implements measures to ensure that the collision detection mechanisms in network devices 16 function correctly. In order to assist a full understanding of this aspect of the present invention, an outline of the operation of a collision detection system in accordance with the 10Base-2 Ethernet protocol will be given in conjunction with the diagrams in Figure 2.

In the 10Base-2 protocol the data is transmitted in accordance with a system which ensures that, whenever data is being transmitted, a particular DC voltage level appears on the communications medium. This is achieved, in this protocol, by ensuring that, whatever the sequence of data bits which is being transmitted, the applied current is on for half the time and off for half the time. In particular, timeslots are defined for the transmission of the data bits and the value of the data bit which is being transmitted in any timeslot is not represented by an absolute current level but rather by the direction of a current transition in the centre of the timeslot. Thus, for instance, if it is desired to transmit a zero bit, the corresponding transition may be negative going, while if it is desired to transmit a one bit the corresponding transition is positive going. It will be appreciated then that whatever value of bit is being transmitted, the current applied during the corresponding timeslot is on for half the time and off for half the time ensuring that a constant average or DC level is created during the transmission of a sequence of bits.

Figure 2a illustrates in schematic form the voltage which appears on the communications medium when a data packet in the 10Base-2 protocol is applied to the medium. In this protocol it is in fact the case that the voltages which appear are negative as compared to the quiescent state of the transmission medium, but it will be understood that all of the following description is equally appropriate to a system in which positive currents and voltages are used. Also, it should be noted that the diagrams in Figure 2 merely illustrate oscillating waveforms representative of the transmission onto the transmission medium. In

practice, the oscillation would not be regular as it represents a sequence of bits of different values, and would also have many more transitions than illustrated in the transmission of a data packet.

5 In Figure 2a the oscillating voltage level on the transmission medium generated by the application of the desired bit sequence is illustratively represented by the solid line 10 and it will be understood that this creates a short term average or DC level on a communications medium as represented by the dashed line 12.

10 In order to perform collision detection, each network device connected to such a network compares the present DC voltage level with a threshold level, represented by line 14, and if the DC level reaches or crosses the threshold then it is indicated that a collision has occurred. As is shown in Figure 2a, during the transmission of a single communications packet, the DC level 12 never reaches threshold level 14 and therefore no collision is detected.

15 Figure 2b illustrates the occurrence of a collision in such a network caused by attempts being made to transmit more than one communications packet on the network at one time. Figure 2b illustrates a situation in which a first communications packet is transmitted onto the communications medium beginning at time T1. This alters the voltage levels on the transmission medium in a corresponding manner to the beginning of diagram 2a. However, at time T2 a  
20 second network device begins applying a second communications packet to the transmission medium. The applied currents are simply additive and therefore the overall voltage level, and in particular the DC voltage level represented by line 12, significantly increases. This pushes the DC value 12 across threshold 14 and the  
25 devices attached to the network detect a collision and assume that neither of the two communications packets have been properly received and that both require retransmission.

At time T3 one of the two communications packets is stopped from

being transmitted and the collision period ends, with the other communications packet continuing to be transmitted until time T4. However, because of the occurrence of the collision period between times T2 and T3 it is assumed, as mentioned above that neither of the two communications packets has been properly transmitted.

Figure 2c illustrates the same situation as Figure 2b as regards the application of communications packets to the communications network, but in this case the communications network has characteristics such that the voltages appearing on the network to it are attenuated. In such a situation, the reception of the data in the communications packets in the absence of collisions may not be significantly affected because, as discussed above, it is represented by the changes between different voltage levels. However, as illustrated in Figure 2c, the operation of the collision detection mechanism is significantly affected by the attenuation in the voltage. In particular, as shown in Figure 2c, even between times T2 and T3 where in fact two communications packets are being applied to the network, DC level 12 never reaches threshold level 14 because of the attenuation and therefore the devices do not properly detect the occurrence of the collision. As the two packets will be interfering with each other during this time their data will be corrupted, but the network devices do not detect that this has occurred, causing a significant deterioration in the operation of the network.

It will therefore be seen from the above discussion that it is important that, at least, the DC levels generated on the network are properly maintained in order to ensure proper functioning of the network and in particular the collision detection.

Returning to Figure 1 each of ports 12a of communications hub 12 is provided with matching circuitry so as to receive data communications via an attached cable segment 13 without reflection and communications hub 12 is arranged such that communications received at any port 12a are distributed to all

of the cable segments 13 attached to the device. It is inevitable, given the nature of the required matching circuitry and the number of cable segments which the signals may be distributed to, that some attenuation of the signals will be caused, but as discussed above, this does not cause significant difficulties for the proper reception of the data by the other network devices 16 attached to network 10.

However, also as discussed above, if this attenuation also arises in the DC signal, this can cause significant difficulties for the proper detection of collisions in the network. As a first step to overcoming this difficulty, the communications hub 12 is arranged such that it presents a low port to port resistance at DC while still presenting, as discussed above, a matched impedance to the cable segments at signal frequencies. This arrangement ensures that the DC level is not significantly attenuated as it passes through the communications hub 12.

This is not sufficient alone to overcome the collision detection problem because now there is a low port to port DC resistance at communications hub 12 the transceivers 17 and termination means 143 all now appear as simple parallel connected devices at DC. The overall resistance presented at DC by the transceivers 17 and termination means 143 will therefore be a function of the number of devices connected to the network and, in this situation, the performance of the collision detection would be dependent upon the number of devices connected to the network, which is clearly unsatisfactory.

As a further measure therefore network 10 is arranged such that transceivers 17 and termination means 143 provide an infinite DC resistance. This can be achieved by using a termination impedance that is matched to the characteristic impedance of the cable at the signal frequency but is open circuit at DC. This may be achieved by using a series R-C combination.

Finally, to ensure proper operation, a single defined DC resistance must be provided and this is arranged by connecting a single resistor of the

required value across the line at one point in network 10. This resistor must be connected across the line via a suitable low pass filter so that it only defines the DC or low frequency load and does not affect the signal frequency impedance.

5 In Figure 1 it is illustrated that this final single resistance means is provided as means 28 in communications hub 12. This is illustrated schematically as a resistor connected via a low pass filter and this is, as mentioned, simply connected across the line.

10 In fact, this single DC resistance can be provided anywhere in network 20 and although it is convenient to provide it in the communications hub which is the centre of the network in at least some circumstances, it may equally well be provided in one of the transceivers 17, perhaps in combination with the circuitry providing the AC termination, or as a further alternative it would be possible to provide it as an entirely separate device having a further connection via a cable segment 13 to one of the ports 12a of communications device 12.

15 It will be seen therefore that this embodiment provides a star or tree connected passive network in which the transmitted data is communicated properly around the network to the various network devices and also the DC level is maintained around the network to ensure that a situation as illustrated in Figure 2c does not occur and collisions may be properly detected as illustrated in Figure 20 2b.

In broad terms then, the network deals with three frequency signal bands in different ways: the high frequency TV signals are simply distributed as in a normal TV distribution system; the lower frequency data signals are communicated throughout the network, albeit with some attenuation, but with proper termination such that reflections do not occur; and the very low frequency and DC signals are passed around the network with no attenuation to ensure 25 proper operation of the collision detection systems.

As illustrated in Figure 1, network devices 16 are connected to cable

segments 16a by way of transceiver devices 17. As mentioned above, these devices are arranged to provide correct termination both at data rates and at DC. They also function to apply the signals to the network communication medium and, in one arrangement, are arranged to apply appropriate currents to the medium, according to the characteristic impedances of the cabling.

Figure 3 illustrates the connection of a network device 16 to a cable segment 16a in an alternative arrangement which facilitates the connection of a network device 16 arranged in a standard fashion as if it were to be attached to a standard Ethernet 10Base-2 network. It is therefore provided with transceiver 161 which is arranged to provide signals to and receive signals from a standard 10Base-2 network and in particular it provides outputs signals at appropriate amplitudes for the characteristic impedance of the cables used in 10Base-2 networks and is arranged to receive signals and the normal amplitudes in such a network.

In the embodiment of Figure 3, network device 16 has associated with it interface means 162 for receiving the signals output from transceiver 161 and also arranged to provide input signals to transceiver 161 in the expected form. In more detail, interface means 162 provides separate signal paths for the incoming and outgoing signals such that these can be treated in different fashions by signal conversion means 162a in order to provide the necessary interfacing between transceiver 161 and cable segments 16a which may have different characteristics from the coaxial cable normally used in Ethernet 10Base-2 networks. It may in fact be only one of the incoming or outgoing signals requires any treatment by signal conversion means 162a and therefore it may be that signal conversion means 162a simply provides a straight through path for the other one of the incoming or outgoing signals.

Figure 4 illustrates a particular embodiment of interface means 162 which is used in one embodiment of this invention. As discussed above, what is important is that the expected voltage levels generated in the network by the

application of the signal currents are at the appropriate levels to enable the correct functioning of the collision detection mechanisms. The impedance presented to transceiver 161 when it is attached in the normal fashion to an Ethernet 10Base-2 network is  $25\Omega$ . If standard TV coaxial cable is used for the cable segments in the network of Figure 1, the characteristic impedance presented by cable segment 16a is  $75\Omega$ . The embodiment illustrated in Figure 4 is arranged to be used in such an embodiment.

Figure 4 schematically illustrates the provision of data frequency line termination by appropriately specified capacitor 44 and the resistor 42.

Outgoing signals transmitted from transceiver 161 are received via line 301 in Figure 4 and are passed through a dual current mirror formed by transistor pairs 304 and resistors R,  $3R$  interconnected in a standard fashion to present a new output signal on line 302. Basically this arrangement reduces by a factor of 3 the current in the output signal and it will be appreciated that, as the load impedance is increased by a factor of 3 this keeps the voltage amplitude the same as that on a conventional 10Base-2 network. The significance of this is that it enables the collision detection mechanisms at the other network devices 16 to function properly as such mechanisms rely on the threshold detection of voltage magnitude.

In this embodiment all of the requisite signal conversion is therefore conducted on the outgoing signals from network devices 16 and therefore incoming signals do not require conversion. It may be therefore that interface means 162 simply provides a straight through path for received signals from cable 16a for presentation to transceiver 161, but it is also possible that an amplifier 46 may be provided before the input is provided on line 32.

It will be appreciated therefore that this invention provides a network of considerable usefulness in that it combines the distribution of both Ethernet and TV signals, and also provides a simple passive arrangement for the transmission of Ethernet signals. Variations on the described arrangements are of course

possible and fall within the scope of the invention. For instance, although the network has been described in simple terms having only a single communication hub, it is equally possible to implement the invention in a tree network having a plurality of interconnected hubs, and such an arrangement may be particularly  
5 advantageous for some required physical arrangements of connected devices.



## CLAIMS:

1. A network comprising a plurality of end stations, a passive communications hub having a plurality of ports and a plurality of cable segments each arranged to connect one of said plurality of end stations to a port of said passive communications hub; wherein
- 5
- said end stations are arranged to apply oscillating electrical signals to the respective cable segments, said oscillating electrical signals having a substantially DC component and an oscillating component in a predetermined
- 10
- frequency range;
- said passive communication hub comprises means defining a low or zero DC resistance between said ports such that a said substantially DC component received at one of said plurality of ports appears substantially without attenuation at the others of said plurality of ports, and impedance means matched
- 15
- to the characteristic impedance of said cable segments arranged such that a said oscillating component received at one of said plurality of ports is received without reflection and appears at the others of said plurality of ports; and
- each of said end stations comprises termination means defining an effectively open circuit DC resistance at the end of the cable segment to which it
- 20
- is attached and an impedance matched to the characteristic impedance of said cable segment in said predetermined frequency range;
- except that there is further provided within the network means defining a predetermined DC resistance effective throughout the network.
- 25
2. A network arranged to distribute TV signals and to carry data communications between computing devices attached to the network, the network comprising a passive communications hub having a plurality of ports, a plurality of cable segments suitable for the transmission of TV signals and a plurality of termination devices, the cable segments each being arranged to connect a

5 termination device to a port on the communications hub, the communications hub  
being arranged to distribute TV signals therethrough and also comprising means  
arranged to receive data communications at any port without reflection and to  
provide the received data communications as outputs at others of said plurality of  
ports, each said termination device comprising termination means arranged such  
10 that data communications are not reflected at such termination means, at least one  
of said termination devices being arranged to present said TV signals as an output  
from the network and at least one of said termination means being arranged to  
present data communications received via a respective cable segment as an output  
10 from the network.

3. A network according to claim 2 in which said passive  
communication hub comprises means defining a low or zero DC resistance  
between said ports such that a said substantially DC component received at one  
15 of said plurality of ports appears substantially without attenuation at the others of  
said plurality of ports; and

each of said termination devices comprises termination means  
defining an effectively open circuit DC resistance at the end of the cable segment  
to which it is attached;

20 except that there is further provided within the network means  
defining a predetermined DC resistance effective throughout the network.

4. A network according to claim 1, 2 or 3 comprising a plurality of said  
communication hubs interconnected by ones of said cable segments.

25 5. A network according to claim 2 or 3 in which one of said ports of  
said communication hub is connected to a source of TV signals and is arranged to  
distribute TV signals received at said one port to the others of said ports and is  
arranged not to output signals received at the others of said ports to said source.

6. A network interface connector for a network device to be attached to a computer network, the device comprising means to convert standard computer network signals suitable for distribution via a network presenting a first characteristic impedance to signals suitable for distribution via a network presenting a second characteristic impedance.

5

7. A network interface device according to claim 6 arranged to convert signals suitable for transmission via a standard 10Base-2 arrangement to signals suitable for transmission via TV cabling.



Application No: GB 9907693.7  
Claims searched: 1-5

Examiner: Mr. Sat Satkurunath  
Date of search: 30 September 1999

**Patents Act 1977**  
**Search Report under Section 17**

**Databases searched:**

UK Patent Office collections, including GB, EP, WO & US patent specifications, in:

UK Cl (Ed.Q): H4P: PPBB, PPBC, PPC. PPNE

Int Cl (Ed.6): H03H, H04H, H04L

Other: Online: WPI, JAPIO, EPODOC

**Documents considered to be relevant:**

Category	Identity of document and relevant passage	Relevant to claims
A	EP 0412220 A1 HEWLETT - see especially abstract and figure 1	1, 2
A	EP 0292072 A1 PHILIPS - see especially abstract and figure 1	1, 2

X	Document indicating lack of novelty or inventive step	A	Document indicating technological background and/or state of the art.
Y	Document indicating lack of inventive step if combined with one or more other documents of same category.	P	Document published on or after the declared priority date but before the filing date of this invention.
&	Member of the same patent family	E	Patent document published on or after, but with priority date earlier than, the filing date of this application.