



US00D845953S

(12) **United States Design Patent** (10) **Patent No.:** **US D845,953 S**
Boehmer et al. (45) **Date of Patent:** **** Apr. 16, 2019**

(54) **ELECTRONIC DEVICE ADAPTER**

FOREIGN PATENT DOCUMENTS

(71) Applicant: **Amazon Technologies, Inc.**, Seattle, WA (US)

CA 166792 11/2016
JP HJ23037712 10/2011

(72) Inventors: **Keeley Justin Boehmer**, San Francisco, CA (US); **Emmanuel J M Laffon de Mazieres**, Burlingame, CA (US)

OTHER PUBLICATIONS

Japanese Office Action dated Mar. 16, 2018 for Japanese Design Application No. 2017-008791, a counterpart foreign application of Design U.S. Appl. No. 29/585,439, 3 pages.

(73) Assignee: **Amazon Technologies, Inc.**, Seattle, WA (US)

(Continued)

(**) Term: **15 Years**

Primary Examiner — Cynthia R Underwood
(74) *Attorney, Agent, or Firm* — Lee & Hayes, P.C.

(21) Appl. No.: **29/585,439**

(57) **CLAIM**

(22) Filed: **Nov. 23, 2016**

The ornamental design for an electronic device adapter, as shown and described.

(51) **LOC (11) Cl.** **14-02**

(52) **U.S. Cl.**
USPC **D14/433**

DESCRIPTION

(58) **Field of Classification Search**
USPC D14/432, 433, 358
CPC H01M 10/44
See application file for complete search history.

FIG. 1 is a front perspective view of a first embodiment of an electronic device adapter;
FIG. 2 is a back perspective view thereof;
FIG. 3 is a top view thereof;
FIG. 4 is a bottom view thereof;
FIG. 5 is a left-side view thereof;
FIG. 6 is a right-side view thereof;
FIG. 7 is a front view thereof;
FIG. 8 is a back view thereof;
FIG. 9 is a front perspective view of a second embodiment of an electronic device adapter;
FIG. 10 is a back perspective view thereof;
FIG. 11 is a top view thereof;
FIG. 12 is a bottom view thereof;
FIG. 13 is a left-side view thereof;
FIG. 14 is a right-side view thereof;
FIG. 15 is a front view thereof; and,
FIG. 16 is a back view thereof.
The broken lines depict portions of the electronic device adapter which form no part of the claimed design.

(56) **References Cited**

U.S. PATENT DOCUMENTS

D600,652	S	*	9/2009	Hong	D13/154
D680,539	S	*	4/2013	Kim	D14/433
D706,752	S	*	6/2014	Myung	D14/240
D707,180	S	*	6/2014	Yi	D13/147
D730,903	S	*	6/2015	Langhammer	D14/433
D731,489	S	*	6/2015	Langhammer	D14/433
D742,320	S	*	11/2015	Akana	D13/147
D755,790	S	*	5/2016	Salvatori	D14/433
D784,340	S	*	4/2017	Laffon de Mazieres	D14/433
D788,112	S	*	5/2017	Liao	D14/433
D789,123	S	*	6/2017	Akana	D6/682.5
D789,935	S	*	6/2017	Zheng	D14/433
D792,409	S	*	7/2017	Shim	D14/435
D798,301	S	*	9/2017	Kujawski	D14/433

(Continued)

1 Claim, 14 Drawing Sheets

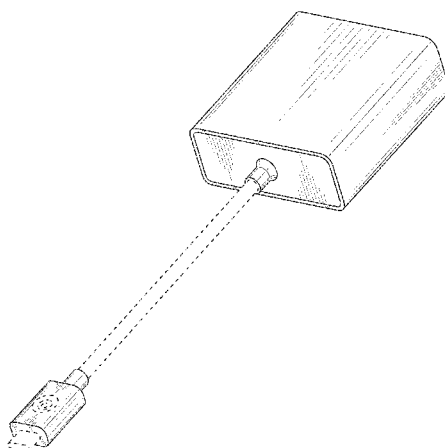

(56)

References Cited

U.S. PATENT DOCUMENTS

D814,423	S	*	4/2018	Akana	D13/147
D814,471	S	*	4/2018	Kim	D14/433
D820,264	S	*	6/2018	Lai	D14/433
10,014,095	B1	*	7/2018	McHatet	H01B 7/40
D828,355	S	*	9/2018	Xie	D14/433
D828,356	S	*	9/2018	Xie	D14/433
D828,839	S	*	9/2018	Zhang	D14/433
D828,840	S	*	9/2018	Zhang	D14/433
D828,841	S	*	9/2018	Zhang	D14/433
D832,260	S	*	10/2018	Hutton	D14/433
D833,445	S	*	11/2018	Xie	D14/433
2007/0293079	A1	*	12/2007	Chao	H01R 13/6275
					439/352
2014/0075051	A1	*	3/2014	Zadesky	G06F 13/122
					710/3

OTHER PUBLICATIONS

Japanese Office Action dated Mar. 16, 2018 for Japanese Design Application No. 2017-008792, a counterpart foreign application of Design U.S. Appl. No. 29/585,439, 3 pages.

Japanese Office Action dated Mar. 16, 2018 for Japanese Design Application No. 2017-008793, a counterpart foreign application of Design U.S. Appl. No. 29/585,439, 3 pages.

Office Action dated Jun. 8, 2017 for Indian design application No. 293639, a counterpart foreign application of Design U.S. Appl. No. 29/585,439, 2 pages.

Office Action dated Jun. 8, 2017 for Indian Design Application No. 293640, a counterpart foreign application of Design U.S. Appl. No. 29/585,439, 2 pages.

Office Action dated Jun. 8, 2017 for Indian design application No. 293641, a counterpart foreign application of Design U.S. Appl. No. 29/585,439, 2 pages.

Chinese Office Action dated Sep. 5, 2017 for Chinese design application No. 201730194893.2, a counterpart foreign application of Design U.S. Appl. No. 29/585,439.

Japanese Office Action dated Sep. 29, 2017 for Japanese Design Application No. 2017-008791, a counterpart foreign application of Design U.S. Appl. No. 29/585,439, 5 pages.

Japanese Office Action dated Sep. 29, 2017 for Japanese Design Application No. 2017-008792, a counterpart foreign application of Design U.S. Appl. No. 29/585,439, 5 pages.

Japanese Office Action dated Sep. 29, 2017 for Japanese Design Application No. 2017-008793, a counterpart foreign application of Design U.S. Appl. No. 29/585,439, 5 pages.

Korean Office Action (Request for Selection) dated Oct. 10, 2017 for Korean design application No. 30-2017-19891 M001, a counterpart foreign application of Design U.S. Appl. No. 29/585,439, 2 pages.

Korean Office Action (Request for Selection) dated Oct. 10, 2017 for Korean design application No. 30-2017-19891 M002, a counterpart foreign application of Design U.S. Appl. No. 29/585,439, 2 pages.

Korean Office Action dated Oct. 10, 2017 for Korean design application No. 30-2017-19891 M001, a counterpart foreign application of Design U.S. Appl. No. 29/585,439, 2 pages.

Korean Office Action dated Oct. 10, 2017 for Korean design application No. 30-2017-19891 M002, a counterpart foreign application of Design U.S. Appl. No. 29/585,439, 2 pages.

Korean Office Action dated Oct. 10, 2017 for Korean design application No. 30-2017-19891 M003, a counterpart foreign application of Design U.S. Appl. No. 29/585,439, 2 pages.

Canadian Office Action dated Dec. 11, 2017 for Canadian Design Application No. 174168, a counterpart foreign application of Design U.S. Appl. No. 29/585,439, 10 pages.

Canadian Office Action dated Nov. 8, 2017 for Canadian design application No. 174166, a counterpart foreign application of Design U.S. Appl. No. 29/585,439, 12 pages.

Canadian Office Action dated Nov. 8, 2017 for Canadian design application No. 174167, a counterpart foreign application of Design U.S. Appl. No. 29/585,439, 12 pages.

Canadian Office Action dated Apr. 12, 2018 for Canadian Design Application No. 174167, a counterpart foreign application of Design U.S. Appl. No. 29/585,439, 10 pages.

Canadian Office Action dated Apr. 12, 2018 for Canadian Design Application No. 174168, a counterpart foreign application of Design U.S. Appl. No. 29/585,439, 3 pages.

* cited by examiner

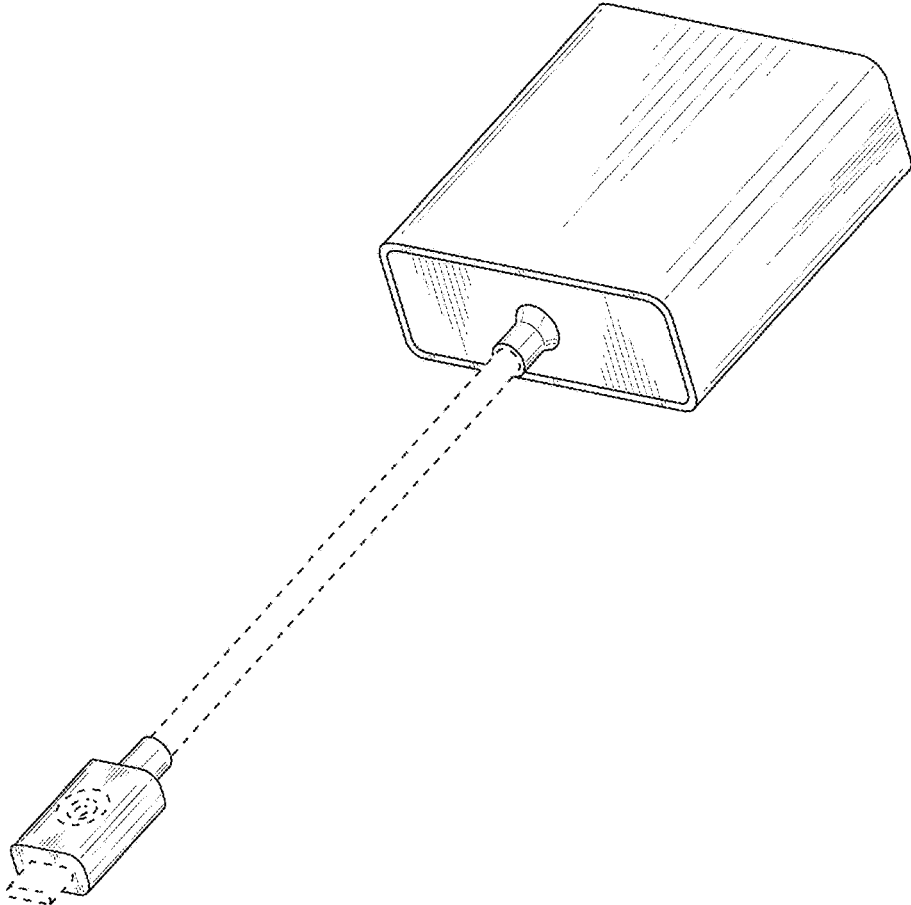

FIG. 1

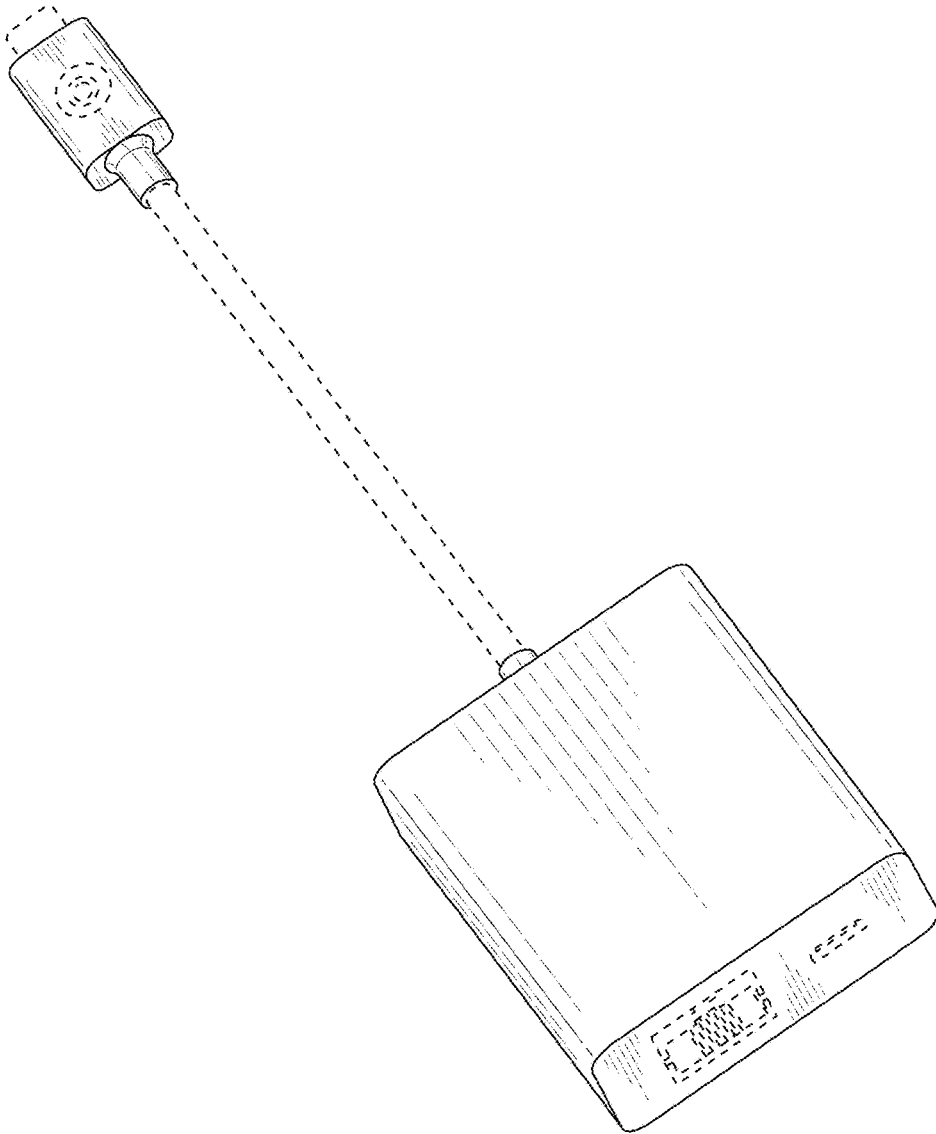

FIG. 2

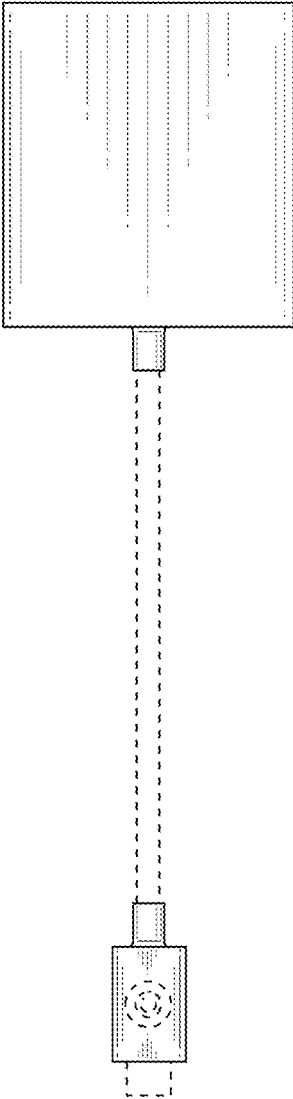

FIG. 3

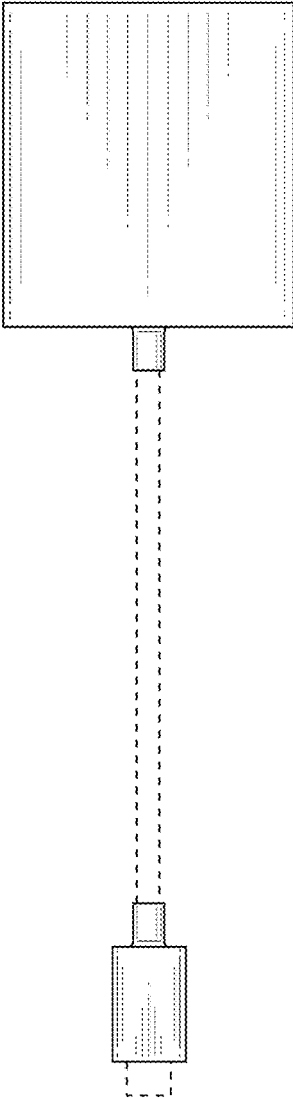

FIG. 4

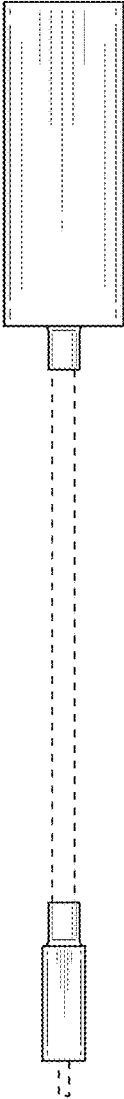

FIG. 5

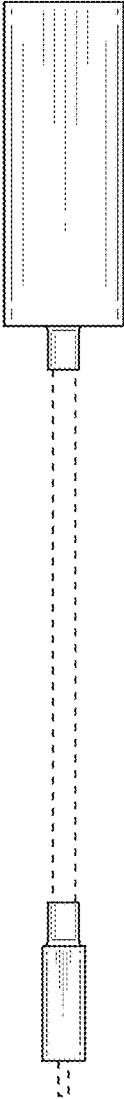

FIG. 6

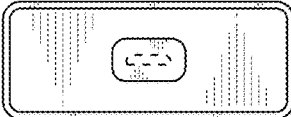

FIG. 7



FIG. 8

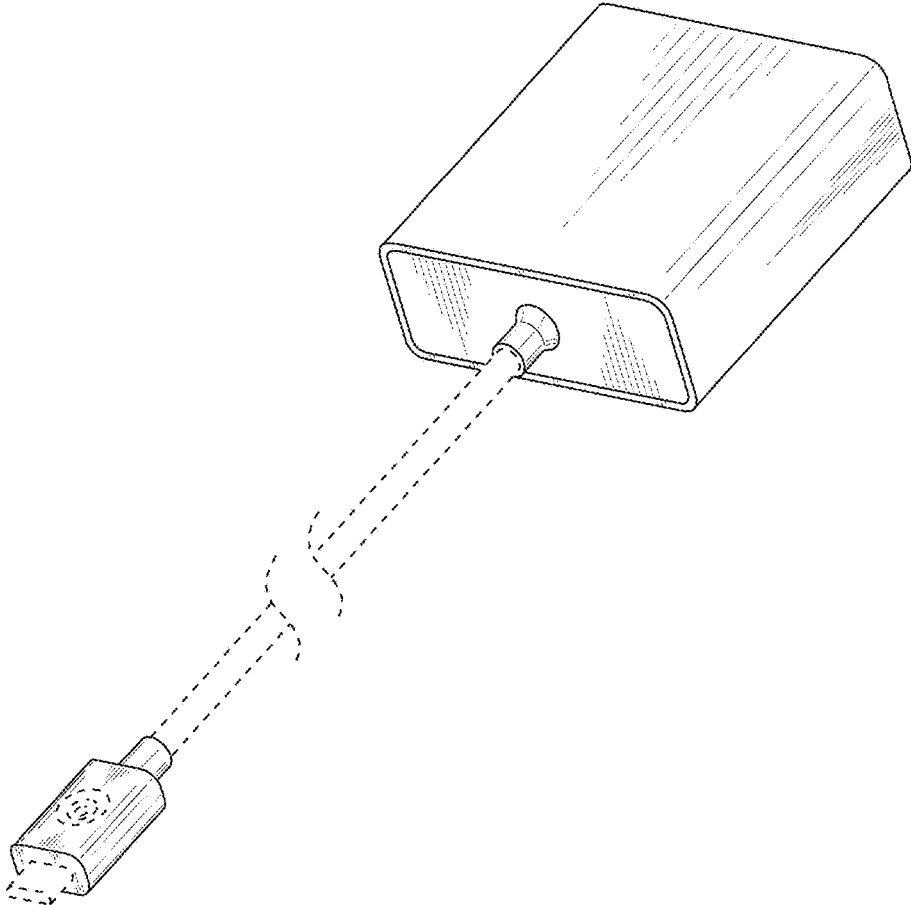

FIG. 9

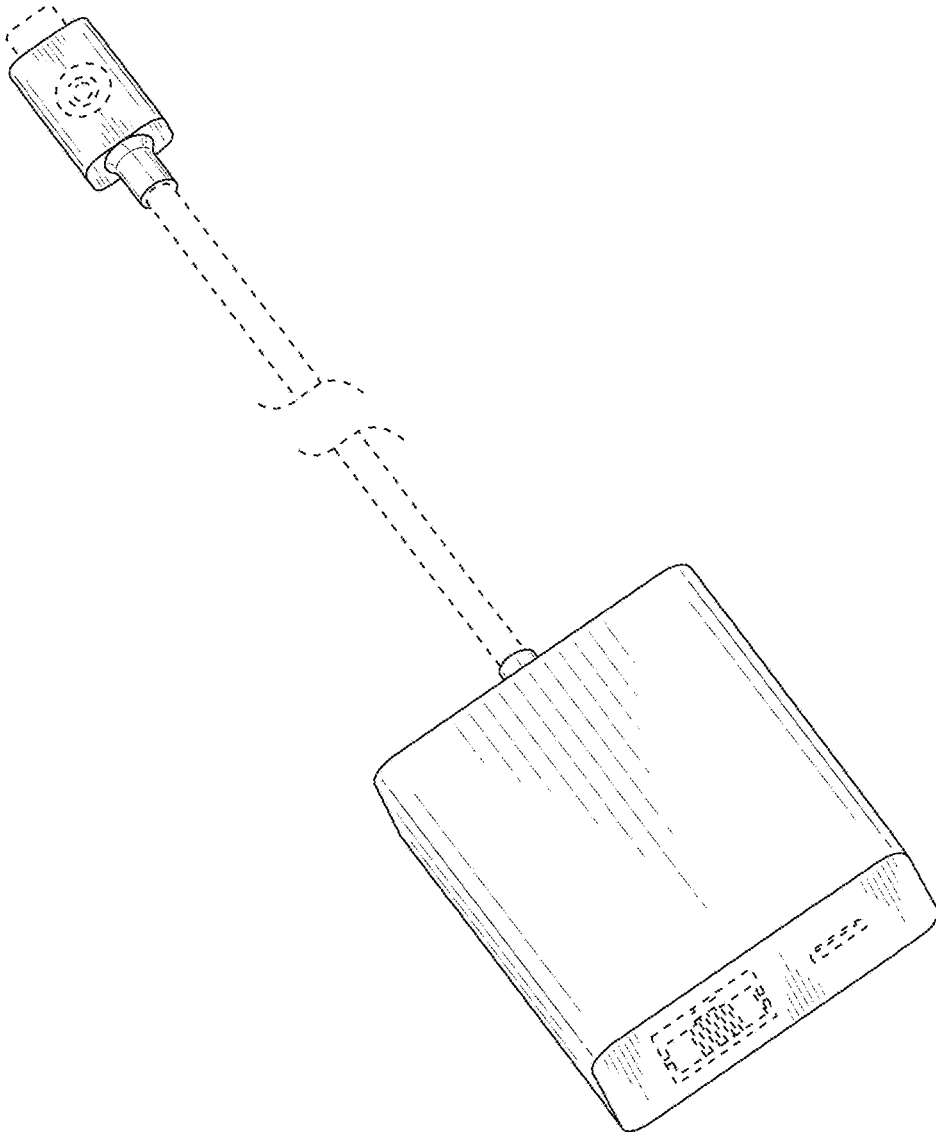

FIG. 10

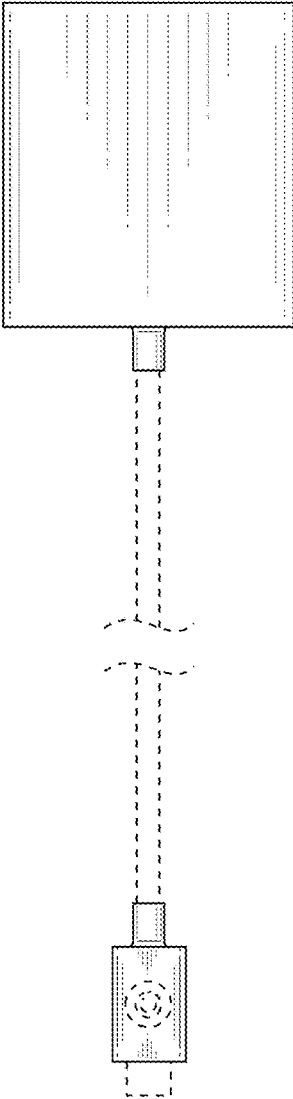

FIG. 11

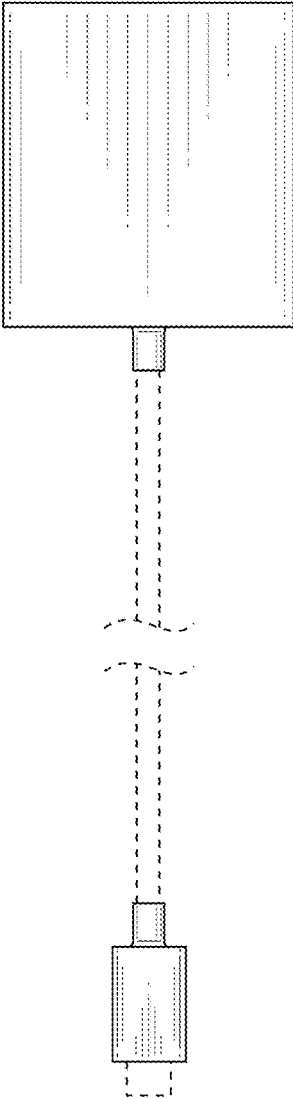

FIG. 12

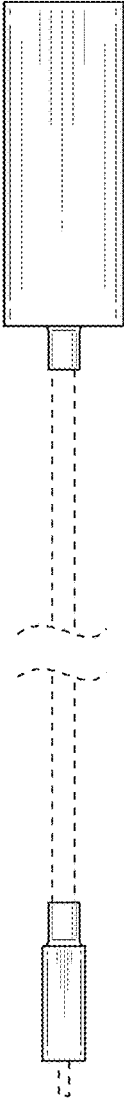

FIG. 13

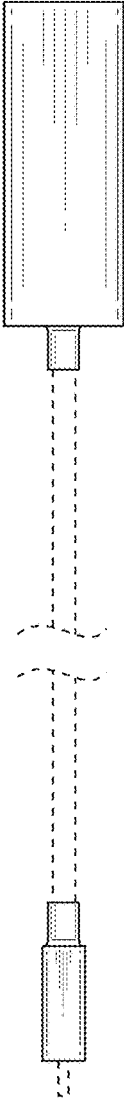

FIG. 14

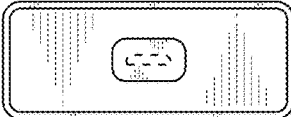

FIG. 15



FIG. 16