



(12) **DEMANDE DE BREVET CANADIEN
CANADIAN PATENT APPLICATION**

(13) **A1**

(86) Date de dépôt PCT/PCT Filing Date: 2017/09/29
 (87) Date publication PCT/PCT Publication Date: 2018/04/05
 (85) Entrée phase nationale/National Entry: 2019/03/26
 (86) N° demande PCT/PCT Application No.: US 2017/054628
 (87) N° publication PCT/PCT Publication No.: 2018/064640
 (30) Priorités/Priorities: 2016/10/01 (US62/403,116);
 2016/10/01 (US62/403,111); 2017/02/10 (US62/457,399);
 2017/02/10 (US62/457,582); 2017/03/13 (US62/470,669)

(51) Cl.Int./Int.Cl. *C40B 20/04* (2006.01),
B01J 19/00 (2006.01), *C40B 40/06* (2006.01),
C40B 70/00 (2006.01)
 (71) Demandeur/Applicant:
 BERKELEY LIGHTS, INC., US
 (72) Inventeurs/Inventors:
 SUOMILLION, MAGALI, US;
 BENNETT, HAYLEY M., US;
 MEJIA GONZALES, YARA X., US;
 TOH, MCKENZI S., US;
 RAMENANI, RAVI K., US
 (74) Agent: CASSAN MACLEAN IP AGENCY INC.

(54) Titre : COMPOSITIONS DE CODE-BARRES D'ADN ET PROCEDES D'IDENTIFICATION IN SITU DANS UN DISPOSITIF MICROFLUIDIQUE
 (54) Title: DNA BARCODE COMPOSITIONS AND METHODS OF IN SITU IDENTIFICATION IN A MICROFLUIDIC DEVICE

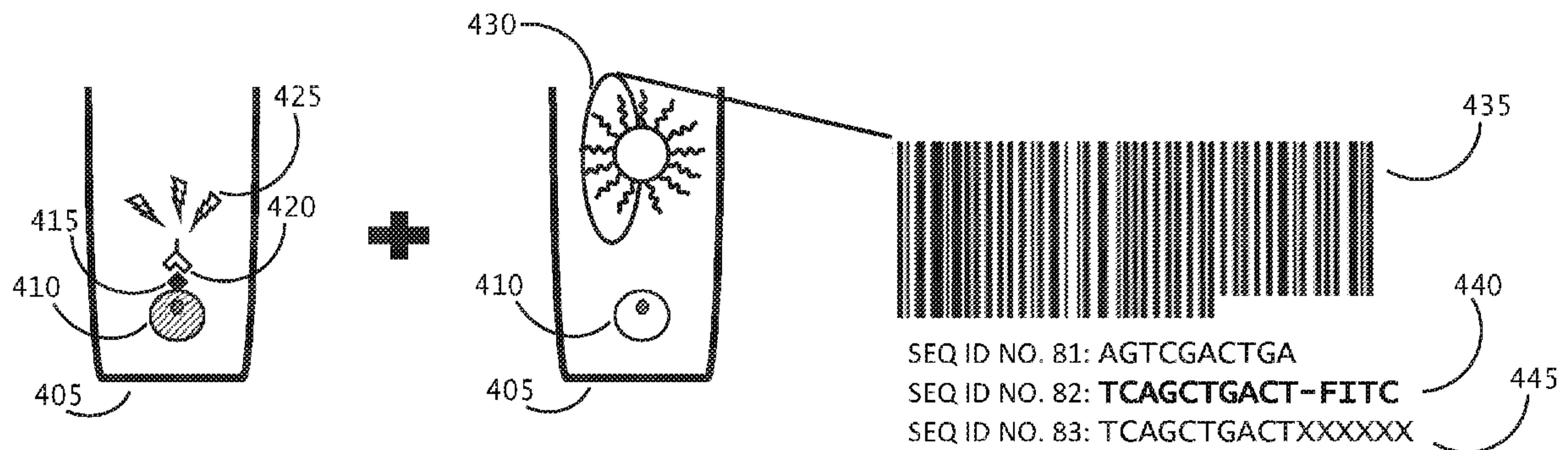

FIG. 4A

(57) **Abrégé/Abstract:**

Apparatuses, compositions and processes for DNA barcode deconvolution are described herein. A DNA barcode may be used to provide a bead specific identifier, which may be detected in situ using hybridization strategies. The DNA barcode provides identification by sequencing analysis. The dual mode of detection may be used in a wide variety of applications to link positional information with assay information including but not limited to genetic analysis. Methods are described for generation of barcoded single cell sequencing libraries. Isolation of nucleic acids from a single cell within a microfluidic environment can provide the foundation for cell specific sequencing library preparation.

(12) INTERNATIONAL APPLICATION PUBLISHED UNDER THE PATENT COOPERATION TREATY (PCT)

REVISED VERSION

(19) World Intellectual Property
Organization
International Bureau

(43) International Publication Date
05 April 2018 (05.04.2018)



(10) International Publication Number
WO 2018/064640 A9

(51) International Patent Classification:

C40B 20/04 (2006.01) *C40B 70/00* (2006.01)
C40B 40/06 (2006.01) *B01J 19/00* (2006.01)

(21) International Application Number:

PCT/US2017/054628

(22) International Filing Date:

29 September 2017 (29.09.2017)

(25) Filing Language:

English

(26) Publication Language:

English

(30) Priority Data:

62/403,116	01 October 2016 (01.10.2016)	US
62/403,111	01 October 2016 (01.10.2016)	US
62/457,399	10 February 2017 (10.02.2017)	US
62/457,582	10 February 2017 (10.02.2017)	US
62/470,669	13 March 2017 (13.03.2017)	US

(71) Applicant: **BERKELEY LIGHTS, INC.** [US/US]; 5858 Horton Street, Suite 320, Emeryville, California 94608 (US).

(72) Inventors; and

(71) Applicants: **SOUMILLON, Magali** [FR/US]; Boston, Massachusetts (US). **BENNETT, Hayley M.** [GB/US]; San Francisco, California (US). **MEJIA GONZALES, Yara**

X. [US/US]; Berkeley, California (US). **TOH, Mckenzi S.** [US/US]; Oakland, California (US). **RAMENANI, Ravi K.** [IN/US]; Fremont, California (US).

(74) Agent: **PRESLEY, Andrew D.** et al.; KILPATRICK TOWNSEND & STOCKTON LLP, Mailstop: IP Docketing - 22, 1100 Peachtree Street, Suite 2800, Atlanta, Georgia 30309 (US).

(81) Designated States (unless otherwise indicated, for every kind of national protection available): AE, AG, AL, AM, AO, AT, AU, AZ, BA, BB, BG, BH, BN, BR, BW, BY, BZ, CA, CH, CL, CN, CO, CR, CU, CZ, DE, DJ, DK, DM, DO, DZ, EC, EE, EG, ES, FI, GB, GD, GE, GH, GM, GT, HN, HR, HU, ID, IL, IN, IR, IS, JO, JP, KE, KG, KH, KN, KP, KR, KW, KZ, LA, LC, LK, LR, LS, LU, LY, MA, MD, ME, MG, MK, MN, MW, MX, MY, MZ, NA, NG, NI, NO, NZ, OM, PA, PE, PG, PH, PL, PT, QA, RO, RS, RU, RW, SA, SC, SD, SE, SG, SK, SL, SM, ST, SV, SY, TH, TJ, TM, TN, TR, TT, TZ, UA, UG, US, UZ, VC, VN, ZA, ZM, ZW.

(84) Designated States (unless otherwise indicated, for every kind of regional protection available): ARIPO (BW, GH, GM, KE, LR, LS, MW, MZ, NA, RW, SD, SL, ST, SZ, TZ, UG, ZM, ZW), Eurasian (AM, AZ, BY, KG, KZ, RU, TJ, TM), European (AL, AT, BE, BG, CH, CY, CZ, DE, DK, EE, ES, FI, FR, GB, GR, HR, HU, IE, IS, IT, LT, LU, LV,

(54) Title: DNA BARCODE COMPOSITIONS AND METHODS OF IN SITU IDENTIFICATION IN A MICROFLUIDIC DEVICE

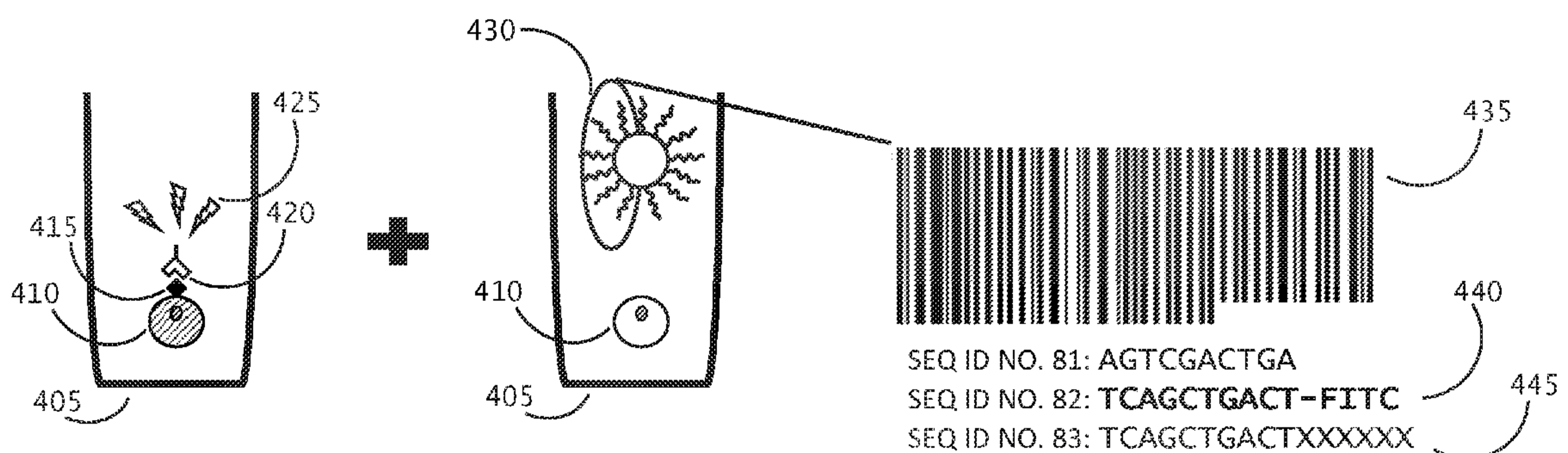

FIG. 4A

(57) Abstract: Apparatuses, compositions and processes for DNA barcode deconvolution are described herein. A DNA barcode may be used to provide a bead specific identifier, which may be detected in situ using hybridization strategies. The DNA barcode provides identification by sequencing analysis. The dual mode of detection may be used in a wide variety of applications to link positional information with assay information including but not limited to genetic analysis. Methods are described for generation of barcoded single cell sequencing libraries. Isolation of nucleic acids from a single cell within a microfluidic environment can provide the foundation for cell specific sequencing library preparation.

[Continued on next page]

WO 2018/064640 A9 

MC, MK, MT, NL, NO, PL, PT, RO, RS, SE, SI, SK, SM,
TR), OAPI (BF, BJ, CF, CG, CI, CM, GA, GN, GQ, GW,
KM, ML, MR, NE, SN, TD, TG).

Published:

- *with international search report (Art. 21(3))*
- *before the expiration of the time limit for amending the claims and to be republished in the event of receipt of amendments (Rule 48.2(h))*

(88) Date of publication of the revised international search report:

31 May 2018 (31.05.2018)

(48) Date of publication of this corrected version:

11 May 2018 (11.05.2018)

(15) Information about Correction:

see Notice of 31 May 2018 (31.05.2018)

Previous Correction:

see Notice of 11 May 2018 (11.05.2018)

DNA BARCODE COMPOSITIONS AND METHODS OF IN SITU IDENTIFICATION IN A MICROFLUIDIC DEVICE

[0001] This application is a non-provisional application claiming the benefit under 35 U.S.C. 119(e) of U.S. Provisional Application No. 62/403,116, filed on October 1, 2016; U.S. Provisional Application No. 62/403,111, filed on October 1, 2016; U.S. Provisional Application No. 62/457,399, filed on February 10, 2017; U.S. Provisional Application No. 62/457,582, filed on February 10, 2017; and of U.S. Provisional Application No. 62/470,669, filed on March 13, 2017, each of which disclosures is herein incorporated by reference in its entirety.

BACKGROUND OF THE DISCLOSURE

[0002] The advent of single cell genome amplification techniques and next generation sequencing methods have led to breakthroughs in our ability to sequence the genome and transcriptome of individual biological cells. Despite these advances, it has remained extremely difficult – and often impossible – to link the genome and transcriptome sequence to the specific phenotype of the cell that was sequenced. As described further herein, the ability to decipher barcodes, such as DNA barcodes, within a microfluidic environment can enable linkage of genomic and transcriptomic data with the cell of origin and its phenotype.

SUMMARY OF THE DISCLOSURE

[0003] Compositions, kits and methods are described herein relating to barcoded capture objects, which may be used to generate barcoded RNA-seq libraries and/or genomic DNA libraries from single cells, or small clonal populations of cells, and link sequence obtained from libraries back to the individual cells/clonal populations. The methods are performed in a microfluidic device having an enclosure containing one of more sequestration pens. One advantage of the methods is that cells may be selectively disposed within corresponding sequestration pens in the microfluidic device and their phenotypes may be observed prior to being processed for genome and/or transcriptome sequencing. A key feature of the barcoded capture objects and related methods is that the barcode can be “read” both *in situ* in the microfluidic device and in the sequence reads obtained from the genomic/transcriptomic libraries, thereby enabling linkage of the genomic/transcriptomic data with the observed phenotype of the source cell.

[0004] In one aspect, capture objects are provided. The capture objects comprise at least two (e.g., a plurality of) capture oligonucleotides covalently linked to a solid support (e.g., a bead), each capture oligonucleotide having a barcode sequence, a priming sequence, and a capture sequence. The barcode sequences are designed using cassette oligonucleotide sequences that form a set of non-identical oligonucleotide sequences (also termed “sub-barcode” sequences or

“words”). Unique combinations of the cassette oligonucleotide sequences are linked together to form unique barcode sequences (or “sentences”). Because the cassette oligonucleotide sequences can be individually decoded using labeled (e.g., fluorescently labeled) probes, a set of hybridization probes complementary to the set of cassette oligonucleotide sequences is sufficient to identify *in situ* all possible combinations of the cassette oligonucleotide sequences, and thus all possible barcode sequences that can be generated from the set of cassette oligonucleotide sequences.

[0005] In another aspect, methods for *in situ* identification of capture objects within a microfluidic device, as well as for correlation of genomic/transcriptomic data with biological micro-objects, are provided. The methods involve disposing a capture object, which can be as described above or elsewhere herein, within a microfluidic device, and identifying/decoding the barcode sequence of the capture oligonucleotides of the capture object *in situ*, using a set of complementary hybridization probes. The microfluidic device in which the *in situ* identification is performed includes an enclosure comprising a flow region and a plurality of sequestration pens that are fluidically connected to the flow region, with the capture object being disposed within one of the sequestration pens. Each of the plurality of sequestration pens can hold at least one biological micro-object and at least one capture object.

[0006] One or more hybridization probes containing oligonucleotide sequences complementary to the cassette oligonucleotide sequences of the barcode, may be introduced to the sequestration pen by flowing a solution including the probes into the flow region of the device. These hybridization probes, which may comprise a label, such as a fluorescent label, are annealed to their target complementary sequences (i.e., corresponding cassette oligonucleotide sequences) within the barcode sequence of the capture oligonucleotides, thereby allowing the deciphering of the barcoded bead by label (e.g., fluorescence) observed due to the probe/cassette oligonucleotide sequence complementarity. The identification of the capture object barcode may be performed at various points during the process of capturing nucleic acids from the biological micro-object and the process of nucleic acid library preparation. The identification process may be performed either before or after nucleic acid from the one biological micro-object has been captured to the capture oligonucleotides or after transcription/reverse transcription. Alternatively, the identification of the capture object may be performed before the biological micro-object is disposed in the sequestration pen of the microfluidic device. The decoding process can be conducted with a system comprising an image acquisition unit.

[0007] In certain embodiments, a number of biological micro-objects (e.g., a single cell or a clonal population) may be disclosed in the sequestration pen, either before or after the capture

object is disposed within the sequestration pen. The number of capture objects and biological micro-objects introduced into the sequestration pen can be deterministically set. For example, a single capture object and a single biological micro-object can be disposed in a single sequestration pen, a single capture object and a clonal population of biological cells can be disposed in a single sequestration pen, or multiple capture objects and one or more biological micro-objects can be disposed in a single sequestration pen. Prior to introduction into the sequestration pen, the source population of the biological micro-objects can be noted.

[0008] Upon lysis of the biological micro-object in the sequestration pen, the capture object can capture the nucleic acids released. The barcode becomes covalently bound to/incorporated within transcripts/genomic DNA fragments of the captured nucleic acids by different mechanisms such reverse-transcription, optionally coupled with PCR (RT-PCR). The barcoded transcripts may be further processed and subsequently sequenced. The genomic data and associated barcodes can be deciphered to permit a match between the specific source sequestration pen and thereby to a source biological micro-object and phenotype thereof.

[0009] The process of identification of the barcode of the capture oligonucleotide, and thereby the capture object at a particular location, may be an automated process. The image acquisition unit described herein can further comprise an imaging element configured to capture one or more images of the plurality of sequestration pens and the flow region of the microfluidic device. The system can further comprise an image processing unit communicatively connected to the image acquisition unit. The image processing unit can comprise an area of interest determination engine configured to receive each captured image and define an area of interest for each sequestration pen depicted in the image. The image processing unit can further comprise a scoring engine configured to analyze at least a portion of the image area within the area of interest of each sequestration pen, to determine scores that are indicative of the presence of a particular micro-object and any associated signal arising from a labeled hybridization probe associated therewith in each sequestration pen. The microfluidic device may further comprise at least one coated surface. In some embodiments of the methods, the enclosure of the microfluidic device may include at least one conditioned surface, which may comprise molecules covalently bound thereto, such as hydrophilic polymers and/or anionic polymers.

[0010] In another aspect, a method is provided for providing a barcoded cDNA library from a biological cell, including: disposing the biological cell within a sequestration pen located within an enclosure of a microfluidic device; disposing a capture object within the sequestration pen, wherein the capture object comprises a plurality of capture oligonucleotides, each capture oligonucleotide of the plurality including: a priming sequence that binds a primer; a capture

sequence; and a barcode sequence, wherein the barcode sequence includes three or more cassette oligonucleotide sequences, each cassette oligonucleotide sequence being non-identical to every other cassette oligonucleotide sequences of the barcode sequence; lysing the biological cell and allowing nucleic acids released from the lysed biological cell to be captured by the plurality of capture oligonucleotides comprised by the capture object; and transcribing the captured nucleic acids, thereby producing a plurality of barcoded cDNAs decorating the capture object, each barcoded cDNA including (i) an oligonucleotide sequence complementary to a corresponding one of the captured nucleic acids, covalently linked to (ii) one of the plurality of capture oligonucleotides.

10 [0011] In some embodiments, the gene-specific primer sequence may target an mRNA sequence encoding a T cell receptor (TCR). In other embodiments, the gene-specific primer sequence may target an mRNA sequence encoding a B-cell receptor (BCR).

[0012] In some embodiments, the method may further include: identifying the barcode sequence of the plurality of capture oligonucleotides of the capture object in situ, while the capture object is located within the sequestration pen. In some other embodiments, the method may further include exporting said capture object or said plurality of said capture objects from said microfluidic device.

15 [0013] In various embodiments, the enclosure of the microfluidic device may further include a dielectrophoretic (DEP) configuration, and wherein disposing the biological cell and/or disposing the capture object is performed by applying a dielectrophoretic (DEP) force on or proximal to the biological cell and/or the capture object.

[0014] Capture objects decorated with barcoded cDNAs may then be exported for further library preparation and sequencing. Barcodes and cDNA may be sequenced and genomic data can be matched to the source sequestration pen number and individual cells/colonies. This process may also be performed within the microfluidic device by an automated process as described herein.

20 [0015] In another aspect, a method is provided for providing a barcoded genomic DNA library from a biological micro-object, including disposing a biological micro-object including genomic DNA within a sequestration pen located within an enclosure of a microfluidic device; contacting the biological micro-object with a lysing reagent capable of disrupting a nuclear envelope of the biological micro-object, thereby releasing genomic DNA of the biological micro-object; tagging the released genomic DNA, thereby producing a plurality of tagged genomic DNA fragments having a first end defined by a first tagmentation insert sequence and a second end defined by a second tagmentation insert sequence; disposing a capture object within the

sequestration pen, wherein the capture object comprises a plurality of capture oligonucleotides, each capture oligonucleotide of the plurality including: a first priming sequence; a first tagmentation insert capture sequence; and a barcode sequence, wherein the barcode sequence includes three or more casetable oligonucleotide sequences, each casetable oligonucleotide sequence being non-identical to every other casetable oligonucleotide sequence of the barcode sequence; contacting ones of the plurality of tagmented genomic DNA fragments with (i) the first tagmentation insert capture sequence of ones of the plurality of capture oligonucleotides of the capture object, (ii) an amplification oligonucleotide including a second priming sequence linked to a second tagmentation insert capture sequence, a randomized primer sequence, or a gene-specific primer sequence, and (iii) an enzymatic mixture including a strand displacement enzyme and a polymerase; incubating the contacted plurality of tagmented genomic DNA fragments for a period of time, thereby simultaneously amplifying the ones of the plurality of tagmented genomic DNA fragments and adding the capture oligonucleotide and the amplification oligonucleotide to the ends of the ones of the plurality of tagmented genomic DNA fragments to produce the barcoded genomic DNA library; and exporting the barcoded genomic DNA library from the microfluidic device.

[0016] In some embodiments, the tagmenting may include contacting the released genomic DNA with a transposase loaded with (i) a first double-stranded DNA fragment including the first tagmentation insert sequence, and (ii) a second double-stranded DNA fragment including the second tagmentation insert sequence.

[0017] In some embodiments, the first double-stranded DNA fragment may include a first mosaic end sequence linked to a third priming sequence, and wherein the second double-stranded DNA fragment may include a second mosaic end sequence linked to a fourth priming sequence.

[0018] In some embodiments, the method may further include: identifying the barcode sequence of the plurality of capture oligonucleotides of the capture object in situ, while the capture object is located within the sequestration pen.

[0019] In various embodiments, the enclosure of the microfluidic device further comprises a dielectrophoretic (DEP) configuration, and wherein disposing the biological micro-object and/or disposing the capture object is performed by applying a dielectrophoretic (DEP) force on or proximal to the biological cell and/or the capture object.

[0020] In another aspect, a method is provided for providing a barcoded cDNA library and a barcoded genomic DNA library from a single biological cell, including: disposing the biological cell within a sequestration pen located within an enclosure of a microfluidic device; disposing a first capture object within the sequestration pen, where the first capture object comprises a

plurality of capture oligonucleotides, each capture oligonucleotide of the plurality comprising: a first priming sequence; a first capture sequence; and a first barcode sequence, wherein the first barcode sequence comprises three or more cassette oligonucleotide sequences, each cassette oligonucleotide sequence being non-identical to every other cassette oligonucleotide sequence of the first barcode sequence; obtaining the barcoded cDNA library by performing any method of obtaining a cDNA library as described herein, where lysing the biological cell is performed such that a plasma membrane of the biological cell is degraded, releasing cytoplasmic RNA from the biological cell, while leaving a nuclear envelope of the biological cell intact, thereby providing the first capture object decorated with the barcoded cDNA library from the RNA of the biological cell; exporting the cDNA library-decorated first capture object from the microfluidic device; disposing a second capture object within the sequestration pen, wherein the second capture object comprises a plurality of capture oligonucleotides, each including: a second priming sequence; a first tagmentation insert capture sequence; and a second barcode sequence, wherein the second barcode sequence comprises three or more cassette oligonucleotide sequences, each cassette oligonucleotide sequence being non-identical to every other cassette oligonucleotide sequence of the second barcode sequence; obtaining the barcoded genomic DNA library by performing any method of obtaining a barcoded genomic DNA library as described herein, where a plurality of tagmented genomic DNA fragments from the biological cell are contacted with the first tagmentation insert capture sequence of ones of the plurality of capture oligonucleotides of the second capture object, thereby providing the barcoded genomic DNA library from the genomic DNA of the biological cell; and exporting the barcoded genomic DNA library from the microfluidic device.

[0021] In some embodiments, the method may further include: identifying the barcode sequence of the plurality of capture oligonucleotides of the first capture object. In some embodiments, identifying the barcode sequence of the plurality of capture oligonucleotides of the first capture object may be performed before disposing the biological cell in the sequestration pen; before obtaining the barcoded cDNA library from the RNA of the biological cell; or before exporting the barcoded cDNA library-decorated first capture object from the microfluidic device. In some embodiments, the method may further include: identifying the barcode sequence of the plurality of oligonucleotides of the second capture object.

[0022] In yet another aspect, a method is provided for providing a barcoded B cell receptor (BCR) sequencing library, including: generating a barcoded cDNA library from a B lymphocyte, where the generating is performed according to any method of generating a barcoded cDNA as described herein, where the barcoded cDNA library decorates a capture object including a

plurality of capture oligonucleotides, each capture oligonucleotide of the plurality including a NotI restriction site sequence; amplifying the barcoded cDNA library; selecting for barcoded BCR sequences from the barcoded cDNA library, thereby producing a library enriched for barcoded BCR sequences; circularizing sequences from the library enriched for barcoded BCR sequences, thereby producing a library of circularized barcoded BCR sequences; relinearizing the library of circularized barcoded BCR sequences to provide a library of rearranged barcoded BCR sequences, each presenting a constant (C) region of the BCR sequence 3' to a respective variable (V) sub-region and/or a respective diversity (D) sub-region; and, adding a sequencing adaptor and sub-selecting for the V sub-region and/or the D sub-region, thereby producing a barcoded BCR sequencing library.

[0023] In various embodiments, the method may further include: identifying a barcode sequence of the plurality of capture oligonucleotides of the capture object using any method of identifying a barcode in-situ as described herein. In some embodiments, identifying may be performed before amplifying the barcoded cDNA library. In other embodiments, identifying may be performed while generating the barcoded cDNA library.

BRIEF DESCRIPTION OF THE DRAWINGS

[0024] Figure 1A illustrates an example of a system for use with a microfluidic device and associated control equipment according to some embodiments of the disclosure.

[0025] Figures 1B and 1C illustrate a microfluidic device according to some embodiments of the disclosure.

[0026] Figures 2A and 2B illustrate isolation pens according to some embodiments of the disclosure.

[0027] Figure 2C illustrates a detailed sequestration pen according to some embodiments of the disclosure.

[0028] Figures 2D-F illustrate sequestration pens according to some other embodiments of the disclosure.

[0029] Figure 2G illustrates a microfluidic device according to an embodiment of the disclosure.

[0030] Figure 2H illustrates a coated surface of the microfluidic device according to an embodiment of the disclosure.

[0031] Figure 3A illustrates a specific example of a system for use with a microfluidic device and associated control equipment according to some embodiments of the disclosure.

[0032] Figure 3B illustrates an imaging device according to some embodiments of the disclosure.

[0033] Figure 4A illustrates the relationship between an in-situ detectable barcode sequence of a capture object and sequencing data for nucleic acid from a biological cell, where the nucleic acid is captured while within a microfluidic environment and sequenced after export.

5 [0034] Figure 4B is a schematic representation of a variety of nucleic acid workflows possible using an in-situ detectable barcode sequence of a capture object according to an embodiment of the disclosure.

[0035] Figure 5 is a schematic representation of an embodiment of a capture oligonucleotide of a capture object of the disclosure.

10 [0036] Figure 6 is a schematic representation of an embodiment of capture oligonucleotides of a capture object of the disclosure, having barcode diversity of 10,000 arising from different combinations of cassette sequences forming the barcode sequences.

[0037] Figure 7A is a schematic representation of a process for in-situ detection of a barcode of a capture object according to one embodiment of the disclosure.

15 [0038] Figures 7B and 7C are photographic representations of a method of in-situ detection of a barcode sequence of a capture object according to one embodiment of the disclosure.

[0039] Figures 8A-C are schematic representations of a method of in-situ detection of a barcode sequence of a capture object according to another embodiment of the disclosure.

20 [0040] Figures 8D-8F are photographic representations of method of in-situ detection of two or more cassette oligonucleotide sequences of a barcode sequence of a capture object according to another embodiment of the disclosure.

[0041] Figure 9 illustrates schematic representations of a workflow for single cell RNA capture, library preparation, and sequencing, according to one embodiment of the disclosure.

25 [0042] Figures 10A-10D are photographic representations of one embodiment of a process for lysis of an outer cell membrane with subsequent RNA capture, according to one embodiment of the disclosure.

[0043] Figure 11A is a schematic representation of portions of a workflow providing a RNA library, according to an embodiment of the disclosure.

[0044] Figures 11B and 11C are graphical representations of analyses of sequencing library quality according to an embodiment of the disclosure.

30 [0045] Figures 12 A-12F are pictorial representations of a workflow for single cell lysis, DNA library preparation, and sequencing, according to an embodiment of the disclosure.

[0046] Figure 12G is a schematic representation of single cell DNA library preparation.

[0047] Figures 13A and 13B are schematic representation of a workflow for single cell B cell receptor (BCR) capture, library preparation and sequencing.

[0048] Figure 14A is a photographic representation of an embodiment of a method of in-situ detection of a barcode sequence of a capture object according to the disclosure.

[0049] Figure 14B is a photographic representation of export of a cDNA decorated capture object according to an embodiment of the disclosure.

5 [0050] Figures 14C and 14D are graphical representations of the analysis of the quality of a sequencing library according to an embodiment of the disclosure.

[0051] Figures 15A and 15B are graphical representations of sequencing reads from a library prepared via an embodiment of the disclosure.

10 [0052] Figures 16A-16D are graphical representations of sequencing results obtained from a cDNA sequencing library prepared according to an embodiment of the disclosure.

[0053] Figure 17 is a graphical representation of the variance in sets of barcode sequences detected across experiments, testing randomization of capture object delivery.

[0054] Figure 18 is a graphical representation of the recovery of barcode sequence reads per experiment for an embodiment of a method according to the disclosure.

15 [0055] Figure 19 is a photographic representation of T-cells within a microfluidic device in an embodiment of the disclosure.

[0056] Figures 20A and 20B are photographic representations of a specific cell during culture, staining for antigen and in-situ barcode sequence detection according to an embodiment of the disclosure.

20 [0057] Figures 21A and 21B are photographic representations of a specific cell during culture, staining for antigen and in-situ barcode sequence detection according to an embodiment of the disclosure.

[0058] Figures 22A and 22B are photographic representations of a specific cell during culture, staining for antigen and in-situ barcode sequence detection according to an embodiment of the disclosure.

25 [0059] Figure 23 is a graphical representation of sequencing results across activated, activated antigen-positive and activated antigen-negative cells according to an embodiment of the disclosure.

[0060] Figure 24 is a photographic representation of substantially singly distributed cells according to an embodiment of the disclosure.

30 [0061] Figure 25 is a photographic representation of a process for lysing and releasing nuclear DNA according to an embodiment of the disclosure.

[0062] Figures 26A and 26B are photographic representations of stained cells prior to and subsequent to lysis according to an embodiment of the disclosure.

[0063] Figure 27 is a graphical representation of the distribution of genomic DNA in a sequencing library according to an embodiment of the disclosure.

[0064] Figure 28 is a graphical representation of expected length of chromosomes in sample genomic DNA and further including the experimental coverage observed for each chromosome
5 according to one embodiment of the disclosure.

[0065] Figures 29A-29D are graphical representations of the genomic DNA library quality according to an embodiment of the disclosure.

[0066] Figures 30A-30F are photographic representations of a method of obtaining both RNA and genomic DNA sequencing libraries from a single cell, according to an embodiment of the
10 disclosure.

[0067] Figures 31A and 31B are photographic representations of a method of detecting a barcode sequence on a capture object according to an embodiment of the disclosure.

[0068] Figure 32 is a graphical representation of a correlation between an *in situ* determined barcode sequence, and sequencing results determining the barcode and genomic data according to
15 an embodiment of the disclosure.

DETAILED DESCRIPTION OF THE INVENTION

[0069] This specification describes exemplary embodiments and applications of the disclosure. The disclosure, however, is not limited to these exemplary embodiments and applications or to the manner in which the exemplary embodiments and applications operate or
20 are described herein. Moreover, the figures may show simplified or partial views, and the dimensions of elements in the figures may be exaggerated or otherwise not in proportion. In addition, as the terms "on," "attached to," "connected to," "coupled to," or similar words are used herein, one element (e.g., a material, a layer, a substrate, etc.) can be "on," "attached to,"
"connected to," or "coupled to" another element regardless of whether the one element is directly
25 on, attached to, connected to, or coupled to the other element or there are one or more intervening elements between the one element and the other element. Also, unless the context dictates otherwise, directions (e.g., above, below, top, bottom, side, up, down, under, over, upper, lower, horizontal, vertical, "x," "y," "z," etc.), if provided, are relative and provided solely
by way of example and for ease of illustration and discussion and not by way of limitation. In
30 addition, where reference is made to a list of elements (e.g., elements a, b, c), such reference is intended to include any one of the listed elements by itself, any combination of less than all of the listed elements, and/or a combination of all of the listed elements. Section divisions in the specification are for ease of review only and do not limit any combination of elements discussed.

[0070] Where dimensions of microfluidic features are described as having a width or an area, the dimension typically is described relative to an x-axial and/or y-axial dimension, both of which lie within a plane that is parallel to the substrate and/or cover of the microfluidic device. The height of a microfluidic feature may be described relative to a z-axial direction, which is perpendicular to a plane that is parallel to the substrate and/or cover of the microfluidic device. In some instances, a cross sectional area of a microfluidic feature, such as a channel or a passageway, may be in reference to a x-axial/z-axial, a y-axial/z-axial, or an x-axial/y-axial area.

[0071] As used herein, "substantially" means sufficient to work for the intended purpose. The term "substantially" thus allows for minor, insignificant variations from an absolute or perfect state, dimension, measurement, result, or the like such as would be expected by a person of ordinary skill in the field but that do not appreciably affect overall performance. When used with respect to numerical values or parameters or characteristics that can be expressed as numerical values, "substantially" means within ten percent.

[0072] The term "ones" means more than one.

[0073] As used herein, the term "plurality" can be 2, 3, 4, 5, 6, 7, 8, 9, 10, or more.

[0074] As used herein: μm means micrometer, μm^3 means cubic micrometer, pL means picoliter, nL means nanoliter, and μL (or uL) means microliter.

[0075] As used herein, the term "disposed" encompasses within its meaning "located"; and the term "disposing" encompasses within its meaning "placing."

[0076] As used herein, a "microfluidic device" or "microfluidic apparatus" is a device that includes one or more discrete microfluidic circuits configured to hold a fluid, each microfluidic circuit comprised of fluidically interconnected circuit elements, including but not limited to region(s), flow path(s), channel(s), chamber(s), and/or pen(s), and at least one port configured to allow the fluid (and, optionally, micro-objects suspended in the fluid) to flow into and/or out of the microfluidic device. Typically, a microfluidic circuit of a microfluidic device will include a flow region, which may include a microfluidic channel, and at least one chamber, and will hold a volume of fluid of less than about 1 mL, e.g., less than about 750, 500, 250, 200, 150, 100, 75, 50, 25, 20, 15, 10, 9, 8, 7, 6, 5, 4, 3, or 2 μL . In certain embodiments, the microfluidic circuit holds about 1-2, 1-3, 1-4, 1-5, 2-5, 2-8, 2-10, 2-12, 2-15, 2-20, 5-20, 5-30, 5-40, 5-50, 10-50, 10-75, 10-100, 20-100, 20-150, 20-200, 50-200, 50-250, or 50-300 μL . The microfluidic circuit may be configured to have a first end fluidically connected with a first port (e.g., an inlet) in the microfluidic device and a second end fluidically connected with a second port (e.g., an outlet) in the microfluidic device.

[0077] As used herein, a “nanofluidic device” or “nanofluidic apparatus” is a type of microfluidic device having a microfluidic circuit that contains at least one circuit element configured to hold a volume of fluid of less than about 1 μ L, e.g., less than about 750, 500, 250, 200, 150, 100, 75, 50, 25, 20, 15, 10, 9, 8, 7, 6, 5, 4, 3, 2, 1 nL or less. A nanofluidic device may
5 comprise a plurality of circuit elements (e.g., at least 2, 3, 4, 5, 6, 7, 8, 9, 10, 15, 20, 25, 50, 75, 100, 150, 200, 250, 300, 400, 500, 600, 700, 800, 900, 1000, 1500, 2000, 2500, 3000, 3500, 4000, 4500, 5000, 6000, 7000, 8000, 9000, 10,000, or more). In certain embodiments, one or more (e.g., all) of the at least one circuit elements is configured to hold a volume of fluid of about 100 pL to 1 nL, 100 pL to 2 nL, 100 pL to 5 nL, 250 pL to 2 nL, 250 pL to 5 nL, 250 pL
10 to 10 nL, 500 pL to 5 nL, 500 pL to 10 nL, 500 pL to 15 nL, 750 pL to 10 nL, 750 pL to 15 nL, 750 pL to 20 nL, 1 to 10 nL, 1 to 15 nL, 1 to 20 nL, 1 to 25 nL, or 1 to 50 nL. In other embodiments, one or more (e.g., all) of the at least one circuit elements are configured to hold a volume of fluid of about 20 nL to 200 nL, 100 to 200 nL, 100 to 300 nL, 100 to 400 nL, 100 to 500 nL, 200 to 300 nL, 200 to 400 nL, 200 to 500 nL, 200 to 600 nL, 200 to 700 nL, 250 to 400
15 nL, 250 to 500 nL, 250 to 600 nL, or 250 to 750 nL.

[0078] A microfluidic device or a nanofluidic device may be referred to herein as a “microfluidic chip” or a “chip”; or “nanofluidic chip” or “chip”.

[0079] A “microfluidic channel” or “flow channel” as used herein refers to flow region of a microfluidic device having a length that is significantly longer than both the horizontal and
20 vertical dimensions. For example, the flow channel can be at least 5 times the length of either the horizontal or vertical dimension, e.g., at least 10 times the length, at least 25 times the length, at least 100 times the length, at least 200 times the length, at least 500 times the length, at least 1,000 times the length, at least 5,000 times the length, or longer. In some embodiments, the length of a flow channel is about 100,000 microns to about 500,000 microns, including any
25 value therebetween. In some embodiments, the horizontal dimension is about 100 microns to about 1000 microns (e.g., about 150 to about 500 microns) and the vertical dimension is about 25 microns to about 200 microns, (e.g., from about 40 to about 150 microns). It is noted that a flow channel may have a variety of different spatial configurations in a microfluidic device, and thus is not restricted to a perfectly linear element. For example, a flow channel may be, or
30 include one or more sections having, the following configurations: curve, bend, spiral, incline, decline, fork (e.g., multiple different flow paths), and any combination thereof. In addition, a flow channel may have different cross-sectional areas along its path, widening and constricting to provide a desired fluid flow therein. The flow channel may include valves, and the valves may be of any type known in the art of microfluidics. Examples of microfluidic channels that

include valves are disclosed in U.S. Patents 6,408,878 and 9,227,200, each of which is herein incorporated by reference in its entirety.

[0080] As used herein, the term “obstruction” refers generally to a bump or similar type of structure that is sufficiently large so as to partially (but not completely) impede movement of target micro-objects between two different regions or circuit elements in a microfluidic device. The two different regions/circuit elements can be, for example, the connection region and the isolation region of a microfluidic sequestration pen.

[0081] As used herein, the term “constriction” refers generally to a narrowing of a width of a circuit element (or an interface between two circuit elements) in a microfluidic device. The constriction can be located, for example, at the interface between the isolation region and the connection region of a microfluidic sequestration pen of the instant disclosure.

[0082] As used herein, the term “transparent” refers to a material which allows visible light to pass through without substantially altering the light as it passes through.

[0083] As used herein, the term “micro-object” refers generally to any microscopic object that may be isolated and/or manipulated in accordance with the present disclosure. Non-limiting examples of micro-objects include: inanimate micro-objects such as microparticles; microbeads (e.g., polystyrene beads, Luminex™ beads, or the like); magnetic beads; microrods; microwires; quantum dots, and the like; biological micro-objects such as cells; biological organelles; vesicles, or complexes; synthetic vesicles; liposomes (e.g., synthetic or derived from membrane preparations); lipid nanorrafts, and the like; or a combination of inanimate micro-objects and biological micro-objects (e.g., microbeads attached to cells, liposome-coated micro-beads, liposome-coated magnetic beads, or the like). Beads may include moieties/molecules covalently or non-covalently attached, such as detectable labels, proteins, carbohydrates, antigens, small molecule signaling moieties, or other chemical/biological species capable of use in an assay. Lipid nanorrafts have been described, for example, in Ritchie et al. (2009) “Reconstitution of Membrane Proteins in Phospholipid Bilayer Nanodiscs,” *Methods Enzymol.*, 464:211-231.

[0084] As used herein, the term “cell” is used interchangeably with the term “biological cell.” Non-limiting examples of biological cells include eukaryotic cells, plant cells, animal cells, such as mammalian cells, reptilian cells, avian cells, fish cells, or the like, prokaryotic cells, bacterial cells, fungal cells, protozoan cells, or the like, cells dissociated from a tissue, such as muscle, cartilage, fat, skin, liver, lung, neural tissue, and the like, immunological cells, such as T cells, B cells, natural killer cells, macrophages, and the like, embryos (e.g., zygotes), oocytes, ova, sperm cells, hybridomas, cultured cells, cells from a cell line, cancer cells, infected cells, transfected

and/or transformed cells, reporter cells, and the like. A mammalian cell can be, for example, from a human, a mouse, a rat, a horse, a goat, a sheep, a cow, a primate, or the like.

[0085] A colony of biological cells is “clonal” if all of the living cells in the colony that are capable of reproducing are daughter cells derived from a single parent cell. In certain
5 embodiments, all the daughter cells in a clonal colony are derived from the single parent cell by no more than 10 divisions. In other embodiments, all the daughter cells in a clonal colony are derived from the single parent cell by no more than 14 divisions. In other embodiments, all the daughter cells in a clonal colony are derived from the single parent cell by no more than 17
10 divisions. In other embodiments, all the daughter cells in a clonal colony are derived from the single parent cell by no more than 20 divisions. The term “clonal cells” refers to cells of the same clonal colony.

[0086] As used herein, a “colony” of biological cells refers to 2 or more cells (e.g. about 2 to about 20, about 4 to about 40, about 6 to about 60, about 8 to about 80, about 10 to about 100, about 20 to about 200, about 40 to about 400, about 60 to about 600, about 80 to about 800,
15 about 100 to about 1000, or greater than 1000 cells).

[0087] As used herein, the term “maintaining (a) cell(s)” refers to providing an environment comprising both fluidic and gaseous components and, optionally a surface, that provides the conditions necessary to keep the cells viable and/or expanding.

[0088] As used herein, the term “expanding” when referring to cells, refers to increasing in
20 cell number.

[0089] A “component” of a fluidic medium is any chemical or biochemical molecule present in the medium, including solvent molecules, ions, small molecules, antibiotics, nucleotides and nucleosides, nucleic acids, amino acids, peptides, proteins, sugars, carbohydrates, lipids, fatty acids, cholesterol, metabolites, or the like.

[0090] As used herein, “capture moiety” is a chemical or biological species, functionality, or motif that provides a recognition site for a micro-object. A selected class of micro-objects may recognize the in situ-generated capture moiety and may bind or have an affinity for the in situ-generated capture moiety. Non-limiting examples include antigens, antibodies, and cell surface binding motifs.

[0091] As used herein, “B” used to denote a single nucleotide, is a nucleotide selected from G (guanosine), C (cytidine) and T (thymidine) nucleotides but does not include A (adenine).

[0092] As used herein, “H” used to denote a single nucleotide, is a nucleotide selected from A, C and T, but does not include G.

[0093] As used herein, “D” used to denote a single nucleotide, is a nucleotide selected from A, G, and T, but does not include C.

[0094] As used herein, “V” used to denote a single nucleotide, is a nucleotide selected from A, G, and C, and does not include T.

5 [0095] As used herein, “N” used to denote a single nucleotide, is a nucleotide selected from A, C, G, and T.

[0096] As used herein, “S” used to denote a single nucleotide, is a nucleotide selected from G and C.

10 [0097] As used herein, “Y” used to denote a single nucleotide, is a nucleotide selected from C and T.

[0098] As used herein, A, C, T, G followed by “*” indicates phosphorothioate substitution in the phosphate linkage of that nucleotide.

[0099] As used herein, IsoG is isoguanosine; IsoC is isocytidine; IsodG is a isoguanosine deoxyribonucleotide and IsodC is a isocytidine deoxyribonucleotide. Each of the isoguanosine and isocytidine ribo- or deoxyribo- nucleotides contain a nucleobase that is isomeric to guanine
15 nucleobase or cytosine nucleobase, respectively, usually incorporated within RNA or DNA.

[00100] As used herein, rG denotes a ribonucleotide included within a nucleic acid otherwise containing deoxyribonucleotides. A nucleic acid containing all ribonucleotides may not include labeling to indicated that each nucleotide is a ribonucleotide, but is made clear by context.

20 [00101] As used herein, a “priming sequence” is an oligonucleotide sequence which is part of a larger oligonucleotide and, when separated from the larger oligonucleotide such that the priming sequence includes a free 3' end, can function as a primer in a DNA (or RNA) polymerization reaction.

[00102] As used herein, “antibody” refers to an immunoglobulin (Ig) and includes both
25 polyclonal and monoclonal antibodies; primatized (e.g., humanized); murine; mouse-human; mouse-primate; and chimeric; and may be an intact molecule, a fragment thereof (such as scFv, Fv, Fd, Fab, Fab' and F(ab)'2 fragments), or multimers or aggregates of intact molecules and/or fragments; and may occur in nature or be produced, e.g., by immunization, synthesis or genetic engineering. An “antibody fragment,” as used herein, refers to fragments, derived from or
30 related to an antibody, which bind antigen and which in some embodiments may be derivatized to exhibit structural features that facilitate clearance and uptake, e.g., by the incorporation of galactose residues. This includes, e.g., F(ab), F(ab)'2, scFv, light chain variable region (VL), heavy chain variable region (VH), and combinations thereof.

[00103] An antigen, as referred to herein, is a molecule or portion thereof that can bind with specificity to another molecule, such as an Ag-specific receptor. Antigens may be capable of inducing an immune response within an organism, such as a mammal (e.g., a human, mouse, rat, rabbit, etc.), although the antigen may be insufficient to induce such an immune response by itself. An antigen may be any portion of a molecule, such as a conformational epitope or a linear molecular fragment, and often can be recognized by highly variable antigen receptors (B-cell receptor or T-cell receptor) of the adaptive immune system. An antigen may include a peptide, polysaccharide, or lipid. An antigen may be characterized by its ability to bind to an antibody's variable Fab region. Different antibodies have the potential to discriminate among different epitopes present on the antigen surface, the structure of which may be modulated by the presence of a hapten, which may be a small molecule.

[00104] In some embodiments, an antigen is a cancer cell-associated antigen. The cancer cell-associated antigen can be simple or complex; the antigen can be an epitope on a protein, a carbohydrate group or chain, a biological or chemical agent other than a protein or carbohydrate, or any combination thereof; the epitope may be linear or conformational.

[00105] The cancer cell-associated antigen can be an antigen that uniquely identifies cancer cells (e.g., one or more particular types of cancer cells) or is upregulated on cancer cells as compared to its expression on normal cells. Typically, the cancer cell-associated antigen is present on the surface of the cancer cell, thus ensuring that it can be recognized by an antibody. The antigen can be associated with any type of cancer cell, including any type of cancer cell that can be found in a tumor known in the art or described herein. In particular, the antigen can be associated with lung cancer, breast cancer, melanoma, and the like. As used herein, the term “associated with a cancer cells,” when used in reference to an antigen, means that the antigen is produced directly by the cancer cell or results from an interaction between the cancer cell and normal cells.

[00106] As used herein in reference to a fluidic medium, “diffuse” and “diffusion” refer to thermodynamic movement of a component of the fluidic medium down a concentration gradient.

[00107] The phrase “flow of a medium” means bulk movement of a fluidic medium primarily due to any mechanism other than diffusion. For example, flow of a medium can involve movement of the fluidic medium from one point to another point due to a pressure differential between the points. Such flow can include a continuous, pulsed, periodic, random, intermittent, or reciprocating flow of the liquid, or any combination thereof. When one fluidic medium flows into another fluidic medium, turbulence and mixing of the media can result.

[00108] The phrase “substantially no flow” refers to a rate of flow of a fluidic medium that, averaged over time, is less than the rate of diffusion of components of a material (e.g., an analyte of interest) into or within the fluidic medium. The rate of diffusion of components of such a material can depend on, for example, temperature, the size of the components, and the strength of interactions between the components and the fluidic medium.

[00109] As used herein in reference to different regions within a microfluidic device, the phrase “fluidically connected” means that, when the different regions are substantially filled with fluid, such as fluidic media, the fluid in each of the regions is connected so as to form a single body of fluid. This does not mean that the fluids (or fluidic media) in the different regions are necessarily identical in composition. Rather, the fluids in different fluidically connected regions of a microfluidic device can have different compositions (e.g., different concentrations of solutes, such as proteins, carbohydrates, ions, or other molecules) which are in flux as solutes move down their respective concentration gradients and/or fluids flow through the microfluidic device.

[00110] As used herein, a “flow path” refers to one or more fluidically connected circuit elements (e.g. channel(s), region(s), chamber(s) and the like) that define, and are subject to, the trajectory of a flow of medium. A flow path is thus an example of a swept region of a microfluidic device. Other circuit elements (e.g., unswept regions) may be fluidically connected with the circuit elements that comprise the flow path without being subject to the flow of medium in the flow path.

[00111] As used herein, “isolating a micro-object” confines a micro-object to a defined area within the microfluidic device.

[00112] A microfluidic (or nanofluidic) device can comprise “swept” regions and “unswept” regions. As used herein, a “swept” region is comprised of one or more fluidically interconnected circuit elements of a microfluidic circuit, each of which experiences a flow of medium when fluid is flowing through the microfluidic circuit. The circuit elements of a swept region can include, for example, regions, channels, and all or parts of chambers. As used herein, an “unswept” region is comprised of one or more fluidically interconnected circuit element of a microfluidic circuit, each of which experiences substantially no flux of fluid when fluid is flowing through the microfluidic circuit. An unswept region can be fluidically connected to a swept region, provided the fluidic connections are structured to enable diffusion but substantially no flow of media between the swept region and the unswept region. The microfluidic device can thus be structured to substantially isolate an unswept region from a flow of medium in a swept region, while enabling substantially only diffusive fluidic communication

between the swept region and the unswept region. For example, a flow channel of a microfluidic device is an example of a swept region while an isolation region (described in further detail below) of a microfluidic device is an example of an unswept region.

[00113] **Generating gDNA sequencing libraries from one or more cells within a**

5 **microfluidic environment.** Generation of DNA sequencing data with a cross-reference to the physical location of cells cultured, observed or phenotyped within a microfluidic device is a highly desirable improvement to currently available sequencing strategies. Reasons for sequencing gDNA include characterization of variation or mutations within the DNA of cells, assessment of gene editing events, and process validation for clonality. The ability to correlate
10 sequencing data to the specific cell(s) from which the DNA was isolated has not been previously available.

[00114] A workflow for generating DNA sequencing libraries from cells within a microfluidic device which introduces a barcode sequence that can be read both in-situ within the microfluidic device and from the resultant sequencing data is described herein. The ability to decipher
15 barcodes within the microfluidic environment permits linkage of genomic data to cellular phenotype. As shown in Figure 4, a biological cell 410 may be disposed within a sequestration pen 405 within the enclosure of a microfluidic device, and maintained and assayed there. During the assay, which may be, but is not limited to an assay detecting a cell surface marker 415, a reagent 420 (e.g., which may be an antibody) may bind to the cell surface marked 415 and
20 permit detection of a detectable signal 425 upon so binding. This phenotype can be connected to genomic data from that specific biological cell 410, by using the methods described herein to capture nucleic acid released from cell 410 with capture object 430, which includes a barcode sequence 435 comprising three or more cassette oligonucleotide sequences. The barcode 435 can be detected in-situ by fluorescent probe 440 in detection methods described herein. The
25 released nucleic acid captured to the capture object 430 can be used to generate a sequencing library, which upon being sequenced, provides sequencing data 445 that includes both the genomic information from the released nucleic acid of biological cell 405 and the sequence of the associated barcode 435. A correlation between phenotype and genomic data is thus provided. This ability provides entry into a generalized workflow as shown in Figure 4B. For instance,
30 cells coming through a pathway, which may include gene editing 450, functional /phenotypic assay or a labeling assay 455, either before, after or during cell culture 460, can enter a linking process 465 using barcoded capture beads 470, to then capture RNA (475) and/or DNA (480), and provide RNA-seq 482, T cell Receptor (TCR)-seq 484, B cell Receptor (BCR)-seq 486; or

DNA seq (488) data that is correlated back to the source cell. If the cell was part of a clonal population, positive clone export 490 can result.

[00115] Further, using the protocols described herein for RNA capture/library prep, and DNA capture/library prep, sequencing results for both RNA and DNA may be obtained from the same single cell, and may be correlated to the location within the microfluidic device of the specific single cell source of the sequenced RNA and DNA.

[00116] DNA barcodes 525 are described herein, which are designed using cassette (e.g., changeable sub-units 435a, 435b, 435c, 435d, that in some embodiments, may be completely interchangeable) sub-barcodes or “words” that are individually decoded using fluorescence, as shown schematically in Figure 5. Detection of the barcode may be performed in-situ, by detecting each of the four cassette oligonucleotide sequences using complementary fluorescently labeled hybridization probes. As shown here, cassette oligonucleotide sequence 435a is detected in-situ by hybridization with hybridization probe 440a, which includes fluorophore Fluor 1. Respectively, the second cassette oligonucleotide sequence 435b may be similarly detected by hybridization probe 440b (including Fluor 2); the third cassette oligonucleotide sequence 435c may be detected by hybridization probe 440c having Fluor 3, and the fourth cassette oligonucleotide sequence 435d may be detected by hybridization probe 440d, having Fluor 4. Each of the fluorophores Fluor 1, Fluor 2, Fluor 3, and Fluor 4 are spectrally distinguishable, permitting unequivocal identification of each respective cassette oligonucleotide sequence.

[00117] In the method illustrated in Figure 5, capture objects 430, which comprise beads 510 carrying a plurality of capture oligonucleotides (a single capture oligonucleotide 550 of the plurality is shown) which each include the DNA barcode 525 along with a priming sequence 520 may be introduced to each sequestration pen 405 as one capture object 430 /one barcode 525 for one cell 410 /one cell colony (not shown). In some other embodiments, more than one capture object may be placed into a sequestration pen to capture a greater quantity of nucleic acid from the biological cells under examination.

[00118] A schematic representation is presented in Figure 5 of the capture of nucleic acid released from the biological cell 410 upon lysis (the released nucleic acid may be RNA 505), by the capture object 430 comprising a bead 510 linked via linker 515 to the capture oligonucleotide 550 including a priming sequence 520, barcode 525, optional Unique Molecular Identifier (UMI) 525, and capture sequence 535. In this example, barcode 525 includes four cassette oligonucleotide sequences 435a, 435b, 435c, and 435d. In this example, capture

sequence 535 of the capture oligonucleotide captures the released nucleic acid 505 by hybridizing with the PolyA segment of the released nucleic acid 505.

[00119] Cells to be lysed may either be imported into the microfluidic device specifically for library preparation and sequencing or may be present within the microfluidic device, being
5 maintained for any desirable period of time.

[00120] **Capture object.** A capture object may include a plurality of capture oligonucleotides, wherein each of said plurality includes: a priming sequence which is a primer binding sequence; a capture sequence; and a barcode sequence comprising three or more cassette oligonucleotide sequences, each cassette oligonucleotide sequence being non-identical to the other cassette
10 oligonucleotide sequences of said barcode sequence. In various embodiments, the capture object may include a plurality of capture oligonucleotides. Each capture oligonucleotide comprises a 5'-most nucleotide and a 3'-most nucleotide. In various embodiments, the priming sequence may be adjacent to or comprises said 5'-most nucleotide. In various embodiments, the capture sequence may be adjacent to or comprises said 3'-most nucleotide. Typically, the barcode
15 sequence may be located 3' to the priming sequence and 5' to the capture sequence.

[00121] **Capture object composition.** Typically, the capture object has a composition such that it is amenable to movement using a dielectrophoretic (DEP) force, such as a negative DEP force. For example, the capture object can be a bead (or similar object) having a core that includes a paramagnetic material, a polymeric material and/or glass. The polymeric material
20 may be polystyrene or any other plastic material which may be functionalized to link the capture oligonucleotide. The core material of the capture object may be coated to provide a suitable material to attach linkers to the capture oligonucleotide, which may include functionalized polymers, although other arrangements are possible. The linkers used to link the capture oligonucleotides to the capture object may be any suitable linker as is known in the art. The
25 linker may include hydrocarbon chains, which may be unsubstituted or substituted, or interrupted or non-interrupted with functional groups such as amide, ether or keto- groups, which may provide desirable physicochemical properties. The linker may have sufficient length to permit access by processing enzymes to priming sites near the end of the capture oligonucleotide linked to the linker. The capture oligonucleotides may be linked to the linker
30 covalently or non-covalently, as is known in the art. A nonlimiting example of a non-covalent linkage to the linker may be via a biotin/streptavidin pair.

[00122] The capture object may be of any suitable size, as long as it is small enough to passage through the flow channel(s) of the flow region and into/out of a sequestration pen of any microfluidic device as described herein. Further, the capture object may be selected to have a

sufficiently large number of capture oligonucleotides linked thereto, such that nucleic acid may be captured in sufficient quantity to generate a nucleic acid library useful for sequencing. In some embodiments, the capture object may be a spherical or partially spherical bead and have a diameter greater than about 5 microns and less than about 40 microns. In some embodiments, the spherical or partially spherical bead may have a diameter of about 5, about 7, about 8, about 10, about 12, about 14, about 16, about 18, about 20, about 22, about 24, or about 26 microns.

[00123] Typically, each capture oligonucleotide attached to a capture object has the same barcode sequence, and in many embodiments, each capture object has a unique barcode sequence. Using capture beads having unique barcodes on each capture bead permits unique identification of the sequestration pen into which the capture object is placed. In experiments where a plurality of cells is placed within sequestration pens, often singly, a plurality of capture objects are also delivered and placed into the occupied sequestration pens, one capture bead per sequestration. Each of the plurality of capture beads has a unique barcode, and the barcode is non-identical to any other barcode of any other capture present within the microfluidic device. As a result, the cell (or, in some embodiments, cells) within the sequestration pen, will have a unique barcode identifier incorporated within its sequencing library.

[00124] **Barcode Sequence.** The barcode sequence may include two or more (e.g., 2, 3, 4, 5, or more) cassette oligonucleotide sequences, each of which is non-identical to the other cassette oligonucleotide sequences of the barcode sequence. A barcode sequence is “non-identical” to other barcode sequences in a set when the n (e.g., three or more) cassette oligonucleotide sequences of any one barcode sequence in the set of barcode sequences do not completely overlap with the n’ (e.g., three or more) cassette oligonucleotide sequences of any other barcode sequence in the set of barcode sequences; partial overlap (e.g., up to n-1) is permissible, so long as each barcode sequence in the set is different from every other barcode sequence in the set by a minimum of 1 cassette oligonucleotide sequence. In certain embodiments, the barcode sequence consists of (or consists essentially of) two or more (e.g., 2, 3, 4, 5, or more) cassette oligonucleotide sequences. As used herein, a “cassette oligonucleotide sequence” is an oligonucleotide sequence that is one of a defined set of oligonucleotide sequences (e.g., a set of 12 or more oligonucleotide sequences) wherein, for each oligonucleotide sequence in the defined set, the complementary oligonucleotide sequence (which can be part of a hybridization probe, as described elsewhere herein) does not substantially hybridize to any of the other oligonucleotide sequences in the defined set of oligonucleotide sequences. In certain embodiments, all (or substantially all) of the oligonucleotide sequences in the defined set will have the same length (or number of

nucleotides). For example, the oligonucleotides sequences in the defined set can all have a length of 10 nucleotides. However, other lengths are also suitable for use in the present invention, ranging from about 6 nucleotides to about 15 nucleotides. Thus, for example, each oligonucleotide sequence in the defined set, for substantially all oligonucleotide sequences in the defined set, can have a length of 6 nucleotides, 7 nucleotides, 8 nucleotides, 9 nucleotides, 10 nucleotides, 11 nucleotides, 12 nucleotides, 13 nucleotides, 14 nucleotides, or 15 nucleotides. Alternatively, each or substantially all oligonucleotide sequences in the defined set may have length of 6-8, 7-9, 8-10, 9-11, 10-12, 11-12, 12-14, or 13-16 nucleotides.

5 [00125] Each oligonucleotide sequence selected from the defined set of oligonucleotide sequences (and, thus, in a barcode sequence) can be said to be “non-identical” to the other oligonucleotide sequences in the defined set (and thus, the barcode sequence) because each oligonucleotide sequence can be specifically identified as being present in a barcode sequence based on its unique nucleotide sequence, which can be detected both by (i) sequencing the barcode sequence, and (ii) performing a hybridization reaction with a probe (e.g., hybridization probe) that contains an oligonucleotide sequence that is complementary to the cassetteable oligonucleotide sequence.

10 [00126] In some embodiments, the three or more cassetteable oligonucleotide sequences of the barcode sequence are linked in tandem without any intervening oligonucleotide sequences. In other embodiments, the three or more cassetteable oligonucleotide sequences may have one or more linkage between one of the cassetteable oligonucleotides and its neighboring cassetteable oligonucleotide that is not a direct linkage. Such linkages between any of the three or more cassetteable oligonucleotide sequences may be present to facilitate synthesis by ligation rather than by total synthesis. In various embodiments, however, the oligonucleotide sequences of the cassetteable oligonucleotides are not interrupted by any other of the other oligonucleotide sequences forming one or more priming sequences, optional index sequences, optional Unique Molecular Identifier sequences or optional restriction sites, including but not limited to NotI restriction site sequences.

25 [00127] As used herein in connection with cassetteable oligonucleotide sequences and their complementary oligonucleotide sequences (including hybridization probes that contain all or part of such complementary oligonucleotide sequences), the term “substantially hybridize” means that the level of hybridization between a cassetteable oligonucleotide sequence and its complementary oligonucleotide sequence is above a threshold level, wherein the threshold level is greater than and experimentally distinguishable from a level of cross-hybridization between the complementary oligonucleotide sequence and any other cassetteable oligonucleotide sequence

in the defined set of oligonucleotide sequences. As persons skilled in the art will readily understand, the threshold for determining whether a complementary oligonucleotide sequence does or does not substantially hybridize to a particular cassette oligonucleotide sequence depends upon a number of factors, including the length of the cassette oligonucleotide sequences, the components of the solution in which the hybridization reaction is taking place, the temperature at which the hybridization reaction is taking place, and the chemical properties of the label (which may be attached to the complementary oligonucleotide sequence) used to detect hybridization. Applicants have provided exemplary conditions that can be used to defined sets of oligonucleotide sequences that are non-identical, but persons skilled in the art can readily identify additional conditions that are suitable.

[00128] Each of the three or more cassette oligonucleotide sequences may be selected from a set of at least 12 cassette oligonucleotide sequences. For example, the set can include at least 12, 15, 16, 18, 20, 21, 24, 25, 27, 28, 30, 32, 33, 35, 36, 39, 40, 42, 44, 45, 48, 50, 51, 52, 54, 55, 56, 57, 60, 63, 64, 65, 66, 68, 69, 70, 72, 75, 76, 78, 80, 81, 84, 85, 87, 88, 90, 92, 93, 95, 96, 99, 100, or more, including any number in between any of the foregoing.

[00129] A set of forty cassette oligonucleotide sequences SEQ ID. Nos. 1-40 as shown in Table 1 has been designed for use in the in-situ detection methods, using 10-mer oligonucleotides, which optimally permits fluorophore probe hybridization during detection. At least 6 bases of the 10mer are differentiated to prevent mis-annealing in the detection methods. The set was designed using the barcode generator python script from the Comai lab: (http://comailab.genomecenter.ucdavis.edu/index.php/Barcode_generator), and further selection to the sequences shown, was based on selecting for sequences having a T_m (Melting Temperature) of equal to or greater than 28°C. The T_m calculation was performed using the IDT OligoAnalyzer 3.1(<https://www.idtdna.com/calc/analyzer>).

[00130] **Table 1.** Cassette oligonucleotide sequences for incorporation within a barcode, and hybridization probe sequences for in-situ detection thereof.

Barcode name	SEQ ID No.	Barcode sequence	Probe name	SEQ ID No.	Probe sequence	Fluorescent channel
BC1_C1	1	CAGCCTTCTG	probe_C1	41	CAGAAGGCTG/3AlexF647N/	Cy5
BC1_C2	2	TGTGAGTTCC	probe_C2	42	GGAACTCACA/3AlexF647N/	Cy5
BC1_C3	3	GAATACGGGG	probe_C3	43	CCCCGTATTC/3AlexF647N/	Cy5
BC1_C4	4	CTTTGGACCC	probe_C4	44	GGGTCCAAAG/3AlexF647N/	Cy5
BC1_C5	5	GCCATACACG	probe_C5	45	CGTGTATGGC/3AlexF647N/	Cy5
BC1_C6	6	AAGCTGAAGC	probe_C6	46	GCTTCAGCTT/3AlexF647N/	Cy5
BC1_C7	7	TGTGGCCATT	probe_C7	47	AATGGCCACA/3AlexF647N/	Cy5
BC1_C8	8	CGCAATCTCA	probe_C8	48	TGAGATTGCG/3AlexF647N/	Cy5

BC1_C9	9	TGCGTTGTTG	probe_C9	49	CAACAACGCA/3AlexF647N/	Cy5
BC1_C10	10	TACAGTTGGC	probe_C10	50	GCCAACTGTA/3AlexF647N/	Cy5
BC2_D11	11	TTCCTCTCGT	probe_D11	51	/5AlexF405N/ACGAGAGGAA	Dapi
BC2_D12	12	GACGTTACGA	probe_D12	52	/5AlexF405N/TCGTAACGTC	Dapi
BC2_D13	13	ACTGACGCGT	probe_D13	53	/5AlexF405N/ACGCGTCAGT	Dapi
BC2_D14	14	AGGAGCAGCA	probe_D14	54	/5AlexF405N/TGCTGCTCCT	Dapi
BC2_D15	15	TGACGCGCAA	probe_D15	55	/5AlexF405N/TTGCGCGTCA	Dapi
BC2_D16	16	TCCTCGCCAT	probe_D16	56	/5AlexF405N/ATGGCGAGGA	Dapi
BC2_D17	17	TAGCAGCCCA	probe_D17	57	/5AlexF405N/TGGGCTGCTA	Dapi
BC2_D18	18	CAGACGCTGT	probe_D18	58	/5AlexF405N/ACAGCGTCTG	Dapi
BC2_D19	19	TGGAAAGCGG	probe_D19	59	/5AlexF405N/CCGCTTTCCA	Dapi
BC2_D20	20	GCGACAAGAC	probe_D20	60	/5AlexF405N/GTCTTGTCGC	Dapi
BC3_F21	21	TGTCCGAAAG	probe_F21	61	CTTTCGGACA/3AlexF488N/	FITC
BC3_F22	22	AACATCCCTC	probe_F22	62	GAGGGATGTT/3AlexF488N/	FITC
BC3_F23	23	AAATGTCCCG	probe_F23	63	CGGGACATTT/3AlexF488N/	FITC
BC3_F24	24	TTAGCGCGTC	probe_F24	64	GACGCGCTAA/3AlexF488N/	FITC
BC3_F25	25	AGTTCAGGCG	probe_F25	65	CGCCTGAACT/3AlexF488N/	FITC
BC3_F26	26	ACAGGGGAAC	probe_F26	66	GTTCCCCTGT/3AlexF488N/	FITC
BC3_F27	27	ACCGGATTGG	probe_F27	67	CCAATCCGGT/3AlexF488N/	FITC
BC3_F28	28	TCGTGTGTGA	probe_F28	68	TCACACACGA/3AlexF488N/	FITC
BC3_F29	29	TAGGTCTGCG	probe_F29	69	CGCAGACCTA/3AlexF488N/	FITC
BC3_F30	30	ACCCATACCC	probe_F30	70	GGGTATGGGT/3AlexF488N/	FITC
BC4_T31	31	CCGCACTTCT	probe_T31	71	AGAAGTGCGG/3AlexF594N/	Texas Red
BC4_T32	32	TTGGGTACAG	probe_T32	72	CTGTACCCAA/3AlexF594N/	Texas Red
BC4_T33	33	ATTCGTCGGA	probe_T33	73	TCCGACGAAT/3AlexF594N/	Texas Red
BC4_T34	34	GCCAGCGTAT	probe_T34	74	ATACGCTGGC/3AlexF594N/	Texas Red
BC4_T35	35	GTTGAGCAGG	probe_T35	75	CCTGCTCAAC/3AlexF594N/	Texas Red
BC4_T36	36	GGTACCTGGT	probe_T36	76	ACCAGGTACC/3AlexF594N/	Texas Red
BC4_T37	37	GCATGAACGT	probe_T37	77	ACGTTTCATGC/3AlexF594N/	Texas Red
BC4_T38	38	TGGCTACGAT	probe_T38	78	ATCGTAGCCA/3AlexF594N/	Texas Red
BC4_T39	39	CGAAGGTAGG	probe_T39	79	CCTACCTTCG/3AlexF594N/	Texas Red
BC4_T40	40	TTCAACCGAG	probe_T40	80	CTCGGTTGAA/3AlexF594N/	Texas Red

[00131] In various embodiments, each of the three or more cassette oligonucleotides sequences of a barcode sequence has a sequence of any one of SEQ ID NOs: 1-40, wherein none of the three or more cassette oligonucleotides are identical. The cassette sequences may be presented within the capture oligonucleotide in any order; the order does not change the in-situ detection and the sequences of each of the cassette oligonucleotide sequences can be deconvoluted from the sequencing reads. In some embodiments, the barcode sequence may have four cassette oligonucleotide sequences.

[00132] In some embodiments, a first cassette oligonucleotide sequence of a barcode has a sequence selected from a first sub-set of SEQ ID Nos. 1-40; a second cassette sequence of a barcode has a sequence selected from a second sub-set of SEQ ID Nos. 1-40; a third cassette sequence of a barcode has a sequence selected from a third sub-set of SEQ ID Nos. 1-40; and a

fourth cassetable sequence of a barcode has a sequence selected from a fourth sub-set of SEQ ID Nos. 1-40;

[00133] In some embodiments, a first cassetable oligonucleotide sequence of a barcode has a sequence of any one of SEQ ID NOs: 1-10; a second cassetable oligonucleotide sequence of the barcode has a sequence of any one of SEQ ID NOs: 11- 20; a third cassetable oligonucleotide sequence of the barcode has a sequence of any one of SEQ ID NOs: 21-30; and a fourth cassetable oligonucleotide sequence of the barcode has a sequence of any one of SEQ ID NOs: 31-40. In some embodiments, when a first cassetable oligonucleotide sequence of a barcode has a sequence of any one of SEQ ID NOs: 1-10; a second cassetable oligonucleotide sequence of the barcode has a sequence of any one of SEQ ID NOs: 11- 20; a third cassetable oligonucleotide sequence of the barcode has a sequence of any one of SEQ ID NOs: 21-30; and a fourth cassetable oligonucleotide sequence of the barcode has a sequence of any one of SEQ ID NOs: 31-40, each of the first, second, third and fourth cassetable oligonucleotide sequences are located along the length of the capture oligonucleotide in order, 5' to 3' of the barcode sequence. That is, the first cassetable oligonucleotide will be 5' to the second cassetable oligonucleotide sequence, which is in turn located 5' to the third cassetable oligonucleotide sequence, which is located 5' to the fourth cassetable oligonucleotide sequence. This is shown schematically in Figure 6, where one of cassetable oligonucleotide sequences G1-G10 is located in the first cassetable oligonucleotide sequence position; one of Y1-Y10 sequences is placed in the second cassetable oligonucleotide sequence position, one of R1-R10 sequences is placed in the third cassetable oligonucleotide sequence position, and one of B1-B10 sequences is placed in the fourth cassetable oligonucleotide sequence position of the barcode. However, the order does not matter and the in-situ detection and the sequencing read determining the presence or absence does not rely upon the order of presentation.

[00134] **Capture sequence.** The capture object includes a capture sequence configured to capture nucleic acid. The capture sequence is an oligonucleotide sequence having from about 6 to about 50 nucleotides. In some embodiments, the capture oligonucleotide sequence captures a nucleic acid by hybridizing to a nucleic acid released from a cell of interest. One non-limiting example includes polyT sequences, (having about 30 to about 40 nucleotides) which can capture and hybridize to RNA fragments having PolyA at their 3' ends. The polyT sequence may further contain two nucleotides VN at its 3' end. Other examples of capture oligonucleotides include random hexamers ("randomers") which may be used in a mixture to hybridize to and thus capture complementary nucleic acids. Alternatively, complements to gene specific

sequences may be used for targeted capture of nucleic acids, such as B cell receptor or T cell receptor sequences.

[00135] In another embodiment, a capture oligonucleotide sequence may be used to capture nucleic acid released from a cell, by shepherding recognizable end sequences through
5 recombinase/polymerase directed strand extension to effectively “capture” appropriately tagged released nucleic acid, to thereby add sequencing adaptors, barcodes, and indices. Examples of this type of capture oligonucleotide sequence includes a mosaic end (ME) sequence or other tagmentation insert sequence, as is known in the art. A mosaic end insert sequence is a short oligonucleotide that is easily recognized by transposons and can be used to provide
10 priming/tagging to nucleic acid fragments. A suitable oligonucleotide sequence for this purpose may contain about 8 nucleotides to about 50 nucleotides. In some embodiments, ME plus additional insert sequence may be about 33 nucleotides long, and may be inserted by use of commercially available tagmentation kits, such as Nextera DNA Library Prep Kit, Illumina, Cat. # 15028212, and the like. In this embodiment, the capture performed by the capture sequence is
15 not a hybridization event but a shepherding and directing interaction between the capture oligonucleotide, the tagged DNA, and the recombinase/ polymerase machinery to the priming sequence(s), barcode sequence and any other indices, adaptors, or functional sites such as, but not limited to a NotI restriction site sequence (as discussed below), onto the tagmented DNA fragment. The shepherding and directing interaction provides an equivalent product to the
20 cDNA product described above using a hybridization interaction to capture released nucleic acids. In both cases, an augmented nucleic acid fragment is provided from the released nucleic acid, which now includes at least sequencing adaptor(s) and the barcode, permitting amplification, further sequencing library adaptation, and the ability to obtain sequenced barcode and sample nucleic acid reads.

25 [00136] **Priming sequence.** The capture oligonucleotide of the capture object has a priming sequence, and the priming sequence may be adjacent to or comprises the 5'-most nucleotide of the capture oligonucleotide(s). The priming sequence may be a generic or a sequence-specific priming sequence. The priming sequence may bind to a primer that, upon binding, primes a reverse transcriptase or a polymerase. In some embodiments, the generic priming sequence may
30 bind to a P7 (5'-CAAGCAGAAGACGGCATAACGAGAT-3' (SEQ ID. NO 107)) or a P5 (5'-CAAGCAGAAGACGGCATAACGAGAT-3' (SEQ ID NO. 108)) primer.

[00137] In other embodiments, the generic priming sequence may bind to a primer having a sequence of one of the following:

5'-Me-isodC//Me-isodG//Me-isodC/ACACTCTTTCCCTACACGACGCrGrGrG-3' (SEQ ID. NO. 103);

5'-ACACTCTTTCCCTACACGACGCTCTTCCGATCT-3' (SEQ ID. NO. 104);

5'-/5Biosg/ACACTCTTTCCCT ACACGACGC-3' (SEQ ID. NO. 105);

5'-AATGATACGGCGACCACCGAGATCTACACTCTTTCCCTACACGACGCTCTTC
C*G*A*T*C*T-3' (SEQ ID NO. 106);

5'-/5BiotinTEG/CAAGCAGAAGACGGCATAACGAGATTCGCCTTAGTCTCGTGG-
GCTCG*G-3' (SEQ ID No. 109);

5' /5BiotinTEG/CAAGCAGAAGACGGCATAACGAGATCTAGTACGGTCTCGTG-
GGCTCG*G-3' (SEQ ID NO. 110); and

5'-/5BiotinTEG/CAAGCAGAAGACGGCATAACGAGATCTAGTACGGTCTCGTG-
GGCTCG*G (SEQ ID NO. 111).

[00138] **Additional priming and/or adaptor sequences.** The capture oligonucleotide(s) may optionally have one or more additional priming/adaptor sequences, which either provide a landing site for primer extension or a site for immobilization to complementary hybridizing anchor sites within a massively parallel sequencing array or flow cell.

[00139] **Optional oligonucleotide sequences.** Each capture oligonucleotide of the plurality of capture oligonucleotides may optionally further include a unique molecule identifier (UMI) sequence. Each capture oligonucleotide of the plurality may have a different UMI from the other capture oligonucleotides of a capture object, permitting identification of unique captures as opposed to numbers of amplified sequences. In some embodiments, the UMI may be located 3' to the priming sequence and 5' to the capture sequence. The UMI sequence may be an oligonucleotide having about 5 to about 20 nucleotides. In some embodiments, the oligonucleotide sequence of the UMI sequence may have about 10 nucleotides.

[00140] In some embodiments, each capture oligonucleotide of the plurality of capture oligonucleotides may also include a NotI restriction site sequence (GCGGCCGC, SEQ ID NO. 160). The NotI restriction site sequence may be located 5' to the capture sequence of the capture oligonucleotide. In some embodiments, the NotI restriction site sequence may be located 3' to the barcode sequence of the capture oligonucleotide.

[00141] In other embodiments, each capture oligonucleotide of the plurality of capture oligonucleotides may also include additional indicia such as a pool Index sequence. The Index sequence is a sequence of 4 to 10 oligonucleotides which uniquely identify a set of capture objects belonging to one experiment, permitting multiplex sequencing combining sequencing libraries from several different experiments to save on sequencing run cost and time, while still

permitting deconvolution of the sequencing data, and correlation back to the correct experiment and capture objects associated therein.

[00142] Some exemplary, but not limiting capture objects are illustrated in Table 2, where only one capture oligonucleotide is shown, for clarity. Capture objects including a priming sequence, a barcode, a UMI and a capture sequence for capturing RNA may be a capture object having SEQ ID No. 97, SEQ ID No. 98, SEQ ID No. 99, or SEQ ID No. 100. A capture object including a priming sequence, a barcode, a UMI, a Not1 sequence, and a capture sequence for capturing RNA may be a capture object having SEQ ID NO. 101 or SEQ ID NO. 102.

[00143] Table 2. Exemplary capture objects.

SEQ ID NO	Sequence
97	Bead-5'-Linker- ACACTCTTTCCCTACACGACGCTCTTCCGATCTCAGCCTTCTGTTCCCTCTCGTT GTCCGAAAGCCGCACTTCTNNNNNNNNNNNTTTTTTTTTTTTTTTTTTTVN- 3'
98	Bead-5'-Linker- ACACTCTTTCCCTACACGACGCTCTTCCGATCTCGCAATCTCACAGACGCTGT TCGTGTGTGATGGCTACGATNNNNNNNNNNNTTTTTTTTTTTTTTTTTTTVN- 3'
99	Bead-5'-Linker- ACACTCTTTCCCTACACGACGCTCTTCCGATCTCAGCCTTCTGTTCCCTCTCGTT GTCCGAAAGCCGCACTTCTNNNNNNNNNNNTTTTTTTTTTTTTTTTTTTVN- 3'
100	Bead-5'-Linker- ACACTCTTTCCCTACACGACGCTCTTCCGATCTCAGCCTTCTGTTCCCTCTCGTT GTCCGAAAGCCGCACTTCTNNNNNNNNNNNTTTTTTTTTTTTTTTTTTTVN- 3'
101	Bead-5'-Linker- ACACTCTTTCCCTACACGACGCTCTTCCGATCTCAGCCTTCTGTTCCCTCTCGTT GTCCGAAAGCCGCACTTCTNNNNNNNNNNNATCTCGTATGCCGTCTTCTGCTT GGCGGCCGCTTTTTTTTTTTTTTTTTTTVN
102	Bead-5'-Linker- ACACTCTTTCCCTACACGACGCTCTTCCGATCTTGCGTTGTTGTGGAAAGCGG TAGGTCTGCGCGAAGGTAGGNNNNNNNNNNATCTCGTATGCCGTCTTCTGCT TGGCGGCCGCTTTTTTTTTTTTTTTTTTTVN- 3'

10 [00144] **A plurality of capture objects.** A plurality of capture objects is provided for use in multiplex nucleic acid capture. Each capture object of the plurality is a capture object according to any capture object described herein, where, for each capture object of the plurality, each capture oligonucleotide of that capture object has the same barcode sequence, and wherein the barcode sequence of the capture oligonucleotides of each capture object of the plurality is
15 different from the barcode sequence of the capture oligonucleotides of every other capture object of the plurality. In some embodiments, the plurality of capture objects may include at least 256 capture objects. In other embodiments, the plurality of capture objects may include at least 10,000 capture objects. A schematic showing the construction of a plurality of capture objects is shown in Figure 6. The capture object 630 has a bead 510 to which capture oligonucleotide 550

is attached via linker 515. Linker 515 attaches to the 5' end of the capture oligonucleotide 550, and in particular to the 5' end of the priming sequence 520. Linker 515 and priming sequence 520 (shown here as 33 bp in length) are common to all capture oligonucleotides of all capture objects in this example, but in other embodiments, the linker and/or the priming sequence may be different for different capture oligonucleotides on a capture object or alternatively the linker and/or the priming sequence may be different for different capture objects in the plurality.

Capture sequence 535 of the capture oligonucleotide 550 is located at or proximal to the 3' end of the capture oligonucleotide 550. In this non-limiting example, the capture sequence 535 is shown as a PolyT-VN sequence, which generically captures released RNA. In some embodiments, the capture sequence 535 is common to all capture oligonucleotides 550 of all of the capture objects 630 of the plurality of capture objects. However, in other pluralities of capture objects, the capture sequence 535 on each capture oligonucleotide of the plurality of capture oligonucleotides 550 of the capture object 630 may not necessarily be the same. In this example, an optional Unique Molecular Identifier (UMI) 530 is present, and is located 5' to the capture sequence 535 but 3' to the priming sequence 520. In this particular example, the UMI 530 is located along the capture oligonucleotide 3' to the barcode sequence 525. However, in other embodiments, a UMI 530 may be located 5' to the barcode. However, a UMI 530 is located 3' to the priming sequence 520, in order to be incorporated within the amplified nucleic acid product. In this example, the UMI 530 is 10bp in length. Here the UMI 530 is shown having a sequence of NNNNNNNNNN (SEQ. ID NO 84). Generally, the UMI 530 may be composed of a random combination of any nucleotides, with the proviso that it is not identical to any of the cassetteable oligonucleotides sequences 435a, 435b, 435c, 435d of the barcode 525 nor is it identical to the priming sequence 520. In many embodiments, the UMI is designed to not include a sequence of ten T, which would overlap with the capture sequence 535, as shown in for this case. The UMI 530 is unique for each capture oligonucleotide 550 of each capture object 630. In some embodiments, the unique UMI 530 of each capture oligonucleotide 550 of a capture object 630 may be used within a capture oligonucleotide 550 of a different capture object 630 of the plurality, as the barcode 525 of the different capture object 630 can permit deconvolution of the sequencing reads.

[00145] Barcode 525 of the capture oligonucleotide is 3' to the priming sequence, and contains 4 cassetteable sequences 435a, 435b, 435c, and 435d, which each are 10 bp in length. Each capture oligonucleotide of the plurality of capture oligonucleotides 550 of on a single capture object 630 has an identical barcode 525, and the barcode 525 for the plurality of capture objects are different for each of the capture object 630 of the plurality. The diversity of the barcodes

525 for each of the capture objects may be obtained by making the selection for the cassetable oligonucleotides from defined sets of oligonucleotides as described below. In this example, 10,000 different barcodes can be made by choosing one of each of the four defined sets of oligonucleotides, each of which contain 10 different possible choices.

5 [00146] **Cassetable oligonucleotide sequence.** A cassetable oligonucleotide sequence is provided for use within a barcode as described herein and may have an oligonucleotides sequence of any one of SEQ ID Nos. 1 to 40.

[00147] **Barcode sequence.** A barcode sequence is provided for use within the capture oligonucleotide of the capture object and methods described herein, where the barcode sequence
10 may include three or more cassetable oligonucleotide sequences, wherein each of the three or more cassetable oligonucleotides sequences of the barcode sequence has a sequence of any one of SEQ ID NOs: 1-40, and wherein each cassetable oligonucleotide sequence of the barcode sequence is non-identical to the other cassetable oligonucleotide sequences of the barcode sequence. The barcode sequence comprises two or more (e.g., 2, 3, 4, 5, or more) cassetable
15 oligonucleotide sequences, each of which is non-identical to the other cassetable oligonucleotide sequences of the barcode sequence. In certain embodiments, the barcode sequence consists of (or consists essentially of) two or more (e.g., 2, 3, 4, 5, or more) cassetable oligonucleotide sequences. The cassetable oligonucleotide sequences of the barcode sequence can be as described elsewhere herein. For example, each of the two or more cassetable oligonucleotide
20 sequences can be one from a defined set of oligonucleotide sequences (e.g., a set of 12 or more oligonucleotide sequences) wherein, for each oligonucleotide sequence in the defined set, the complementary oligonucleotide sequence does not substantially hybridize to any of the other oligonucleotide sequences in the defined set. In certain embodiments, each of the two or more cassetable oligonucleotide sequences in the barcode sequence can comprise 6 to 15 nucleotides
25 (e.g., a length of 6, 7, 8, 9, 10, 11, 12, 13, 14, or 15 nucleotides). In other embodiments, each of the two or more cassetable oligonucleotide sequences can consist of (or consist essentially of) 6 to 15 nucleotides (e.g., a length of 6, 7, 8, 9, 10, 11, 12, 13, 14, or 15 nucleotides). In still other embodiments, each of the two or more cassetable sequences in the barcode sequence can comprise, consist or consist essentially of 6-8, 7-9, 8-10, 9-11, 10-12, 11-13, 12-14 or 13-15
30 nucleotides. In a specific embodiment, the cassetable oligonucleotides sequences can be any one of the set defined by SEQ ID NOs: 1-40. In some embodiments, the barcode may include three or four cassetable oligonucleotide sequences. In various embodiments, the three or four cassetable oligonucleotide sequences of the barcode are linked in tandem without any intervening oligonucleotide sequences. In other embodiments, one or more of the three or four

cassetable oligonucleotide sequences may be linked together using intervening one, two or three nucleotides between the cassetable oligonucleotide sequences. This is useful when the cassetable oligonucleotides sequences are linked using ligation chemistry. In some embodiments, no other nucleotide sequences having other functions within the capture
5 oligonucleotide interrupt the linkage of the three or four cassetable oligonucleotide sequences.

[00148] **Set of barcode sequences.** A set of barcode sequences is provided, which includes at least 64 non-identical barcode sequences, each barcode sequence of the set having a structure according to any barcode as described herein. As used herein, a barcode sequence is “non-identical” to other barcode sequences in a set when the n (e.g., three or more) cassetable
10 oligonucleotide sequences of any one barcode sequence in the set of barcode sequences do not completely overlap with the n' (e.g., three or more) cassetable oligonucleotide sequences of any other barcode sequence in the set of barcode sequences; partial overlap (e.g., up to $n-1$) is permissible, so long as each barcode sequence in the set is different from every other barcode sequence in the set by a minimum of 1 cassetable oligonucleotide sequence. In some
15 embodiments, the set of barcode sequences may consist essentially of 64, 81, 100, 125, 216, 256, 343, 512, 625, 729, 1000, 1296, 2401, 4096, 6561, or 10,000 barcode sequences.

[00149] **Hybridization probes.** Also disclosed are hybridization probes which have an oligonucleotide sequence which is complementary to a cassetable oligonucleotide sequence; and a detectable label. The detectable label can be, for example, a fluorescent label, such as, but not
20 limited to a fluorescein, a cyanine, a rhodamine, a phenyl indole, a coumarin, or an acridine dye. Some non-limiting examples include Alexa Fluor dyes such as Alexa Fluor® 647, Alexa Fluor® 405, Alexa Fluor® 488; Cyanine dyes such as Cy® 5 or Cy® 7, or any suitable fluorescent label as known in the art. Any set of distinguishable fluorophores may be selected to be present on hybridization probes flowed into the microfluidic environment for detection of the barcode,
25 as long as each dye's fluorescent signal is detectable distinguishable. Alternatively, the detectable label can be luminescent agent such as a luciferase reporter, lanthanide tag or an inorganic phosphor, a Quantum Dot, which may be tunable and may include semiconductor materials. Other types of detectable labels may be incorporated such as FRET labels which can include quencher molecules along with fluorophore molecules. FRET labels can include dark
30 quenchers such as Black Hole Quencher® (Biosearch); Iowa Black™ or dabsyl. The FRET labels may be any of TaqMan® probes, hairpin probes, Scorpion® probes, Molecular Beacon probes and the like.

[00150] Further details of the hybridization conditions are described below, and one of skill may determine other variations of such conditions suitable to gain binding specificity for a range of barcodes and their hybridization probe pairs.

[00151] **Hybridization probe.** A hybridization probe is provided including an oligonucleotide sequence having a sequence of any one of SEQ ID NOs: 41 to 80 (See Table 1); and a detectable label. The detectable label may be a rhodamine, cyanine or fluorescein fluorescent dye label. In various embodiments, the oligonucleotide sequence of the hybridization probe consists essentially of one sequence of any one of SEQ ID Nos. 41-80, and has no other nucleotides forming part of the hybridization probe.

10 [00152] **Hybridization Reagent.** A hybridization reagent is provided, including a plurality of hybridization probes, where each hybridization probe of the plurality is a hybridization probe as described herein, and where each hybridization probe of the plurality (i) comprises an oligonucleotide sequence which is non-identical to the oligonucleotide sequence of every other hybridization probe of the plurality and (ii) comprises a detectable label which is spectrally
15 distinguishable from the detectable label of every other hybridization probe of the plurality. Also disclosed are reagents that comprise a plurality of (e.g., 2, 3, 4, 5, or more) hybridization probes. The hybridization probes can be any of the hybridization probes disclosed herein. The reagent can be a liquid, such as a solution. Alternatively, the reagent can be a solid, such as a lyophilized powder. When provided as a solid, the addition of an appropriate volume of water
20 (or a suitable solution) can be added to generate a liquid reagent suitable for introduction into a microfluidic device.

[00153] In some embodiments, the plurality of hybridization probes consists of two to four hybridization probes. In some embodiments of the plurality of hybridization probes, a first hybridization probe of the plurality includes a sequence selected from a first subset of SEQ ID
25 NOs: 41-80, and a first detectable label; and a second hybridization probe of the plurality includes a sequence selected from a second subset of SEQ ID NOs: 41-80, and a second detectable label which is spectrally distinguishable from the first detectable label, and where the first and second subsets of SEQ ID NOs: 41-80 are non-overlapping subsets.

[00154] The first hybridization probe can include a sequence that comprises all or part (e.g., 8
30 to 10 nucleotides) of one of the sequences set forth in SEQ ID NOs: 41-80, or a subset of sequences thereof. In certain embodiments, the first hybridization probe can include a sequence that consists of (or consists essentially of) all or part (e.g., 8 to 10 nucleotides) of one of the sequences set forth in SEQ ID NOs: 41-80, or a subset of sequences thereof. The second hybridization probe can include a sequence that comprises all or part (e.g., 8 to 10 nucleotides)

of one of the sequences set forth in SEQ ID NOs: 41-80, or a subset of sequences thereof (e.g., a subset that does not include the sequence present in the first hybridization probe, or a subset that is non-overlapping with the subset from which the sequence present in the first hybridization probe is selected). In certain embodiments, the second hybridization probe can include a
5 sequence that consists of (or consists essentially of) all or part (e.g., 8 to 10 nucleotides) of one of the sequences set forth in SEQ ID NOs: 41-80, or a subset of sequences thereof (e.g., a subset that does not include the sequence present in the first hybridization probe, or a subset that is non-overlapping with the subset from which the sequence present in the first hybridization probe is selected). The third hybridization probe (if present) can include a sequence that comprises all
10 or part (e.g., 8 to 10 nucleotides) of one of the sequences set forth in SEQ ID NOs: 41-80, or a subset of sequences thereof (e.g., a subset that does not include the sequences present in the first and second hybridization probes, or a subset that is non-overlapping with the subsets from which the sequences present in the first and second hybridization probes are selected). In certain embodiments, the third hybridization probe (if present) can include a sequence that consists of
15 (or consists essentially of) all or part (e.g., 8 to 10 nucleotides) of one of the sequences set forth in SEQ ID NOs: 41-80, or a subset of sequences thereof (e.g., a subset that does not include the sequences present in the first and second hybridization probes, or a subset that is non-overlapping with the subsets from which the sequences present in the first and second hybridization probes are selected). The fourth hybridization probe (if present) can include a
20 sequence that comprises all or part (e.g., 8 to 10 nucleotides) of one of the sequences set forth in SEQ ID NOs: 41-80, or a subset of sequences thereof (e.g., a subset that does not include the sequences present in the first, second, and third hybridization probes, or a subset that is non-overlapping with the subsets from which the sequences present in the first, second, and third hybridization probes are selected). In certain embodiments, the fourth hybridization probe (if
25 present) can include a sequence that consists of (or consists essentially of) all or part (e.g., 8 to 10 nucleotides) of one of the sequences set forth in SEQ ID NOs: 41-80, or a subset of sequences thereof (e.g., a subset that does not include the sequences present in the first, second, and third hybridization probes, or a subset that is non-overlapping with the subsets from which the sequences present in the first, second, and third hybridization probes are selected). As will
30 be evident to persons skilled in the art, the reagent could include fifth, sixth, etc. hybridization probes, which can have properties analogous to the first, second, third, and fourth hybridization probes.

[00155] In some embodiments, the third hybridization probe of the plurality may include a sequence selected from a third subset of SEQ ID NOs: 41-80, and a third detectable label which

is spectrally distinguishable from each of the first and second detectable labels, wherein the first, second, and third subsets of SEQ ID NOs: 41-80 are non-overlapping subsets.

[00156] In yet other embodiments, the reagent may further include a fourth hybridization probe of the plurality, wherein the fourth hybridization probe may include a sequence selected from a
5 fourth subset of SEQ ID NOs: 41-80, and a fourth detectable label which is spectrally distinguishable from each of the first, second, and third detectable labels, wherein the first, second, third, and fourth subsets of SEQ ID NOs: 41-80 are non-overlapping subsets.

[00157] In various embodiments of the hybridization reagent, each subset of SEQ ID NOs: 41-80 may include at least 10 sequences. In various embodiments of the hybridization reagent, the
10 first subset contains SEQ ID NOs: 41-50, the second subset contains SEQ ID NOs: 51-60, the third subset contains SEQ ID NOs: 61-70, and the fourth subset contains SEQ ID NOs: 71-80.

[00158] **Kit.** A kit for detecting the cassette oligonucleotide sequences of the barcode of a capture object is provided, where the kit includes a plurality of reagents as described herein, wherein the plurality of hybridization probes of each reagent forms a set that is non-overlapping
15 with the set of hybridization probes of every other reagent in the plurality. In some embodiments, the kit may include 3, 4, 5, 6, 7, 8, 9, or 10 of the reagents.

[00159] **Method for in-situ identification of capture object(s).** Also provided is a method of in-situ identification of one or more capture objects within a microfluidic device, where the method includes:

20 [00160] disposing a single capture object of the one or more capture objects into each of one or more sequestration pens located within an enclosure of the microfluidic device, wherein each capture object has a plurality of capture oligonucleotides, and where each capture oligonucleotide of the plurality includes: a priming sequence; a capture sequence; and a barcode sequence, where the barcode sequence includes three or more cassette oligonucleotide
25 sequences, each cassette oligonucleotide sequence being non-identical to the other cassette oligonucleotide sequences of the barcode sequence;

[00161] flowing a first reagent solution including a first set of hybridization probes into a flow region within the enclosure of the microfluidic device, where the flow region is fluidically connected to each of the one or more sequestration pens, and where each hybridization probe of
30 the first set has an oligonucleotide sequence complementary to a cassette oligonucleotide sequence comprised by any of the barcode sequences of any of the capture oligonucleotides of any of the one or more capture objects, where the complementary oligonucleotide sequence of each hybridization probe in the first set is non-identical to every other complementary oligonucleotide sequence of the hybridization probes in the first set; and a detectable label

selected from a set of spectrally distinguishable detectable labels, where the detectable label of each hybridization probe in the first set is different from the detectable label of every other hybridization probe in the first set of hybridization probes;

[00162] hybridizing the hybridization probes of the first set to corresponding cassette oligonucleotide sequences in any of the barcode sequences of any of the capture oligonucleotides of any of the one or more capture objects;

[00163] detecting, for each hybridization probe of the first set of hybridization probes, a corresponding detectable signal associated with any of the one or more capture objects; and

[00164] generating a record, for each capture object disposed within one of the one or more sequestration pens, including (i) a location of the sequestration pen within the enclosure of the microfluidic device, and (ii) an association or non-association of the corresponding fluorescent signal of each hybridization probe of the first set of hybridization probes with the capture object, where the record of associations and non-associations constitute a barcode which links the capture object with the sequestration pen.

[00165] The one or more capture objects, as used in this method, may each be any capture object as described herein. Generally, all of the barcode sequences will have the same number of cassette oligonucleotide sequences, and each capture oligonucleotide of the plurality of capture oligonucleotide that are comprised by a particular capture object will have the same barcode sequence. As discussed above, the three or more cassette oligonucleotide sequences of each barcode sequence are selected from a set of non-identical cassette oligonucleotide sequences. The set of cassette oligonucleotide sequences can, for example, include 12 to 100 (or more) non-identical oligonucleotide sequences. Thus, the set of cassette oligonucleotide sequences can comprise a number of cassette oligonucleotide sequences greater than the number of spectrally distinguishable labels in the set of spectrally distinguishable labels, which can include 2 or more (e.g., 2 to 5) spectrally distinguishable labels.

[00166] The number of hybridization probes in the first (or subsequent) set can be identical to the number of cassette oligonucleotides in each barcode sequence. However, these numbers do not have to be the same. For example, the number of hybridization probes in the first (or any subsequent) set can be greater than the number of cassette oligonucleotides in each barcode sequence.

[00167] Detecting each hybridization probe (or class of label) comprises identifying distinguishing spectral characteristics of each hybridization probe (or label) of the first set of hybridization probes. Furthermore, detecting a given hybridization probe generally requires detection of a level of the distinguishing spectral characteristic(s) that exceeds a background or

threshold level associated with the system (e.g., optical train) used to detect the distinguishing spectral characteristic(s). Following such identification, any detected label can be correlated with the presence of a cassette oligonucleotide sequence which is complementary to the oligonucleotide sequence of the hybridization probe. The detectable label can be, for example, a fluorescent label, such as, but not limited to a fluorescein, a cyanine, a rhodamine, a phenyl indole, a coumarin, or an acridine dye. Some non-limiting examples include Alexa Fluor dyes such as Alexa Fluor® 647, Alexa Fluor® 405, Alexa Fluor® 488; Cyanine dyes such as Cy® 5 or Cy® 7, or any suitable fluorescent label as known in the art. Any set of distinguishable fluorophores may be selected to be present on hybridization probes flowed into the microfluidic environment for detection of the barcode, as long as each dye's fluorescent signal is detectable distinguishable. Alternatively, the detectable label can be luminescent agent such as a luciferase reporter, lanthanide tag or an inorganic phosphor, a Quantum Dot, which may be tunable and may include semiconductor materials. Other types of detectable labels may be incorporated such as FRET labels which can include quencher molecules along with fluorophore molecules. FRET labels can include dark quenchers such as Black Hole Quencher® (Biosearch); Iowa Black™ or dabsyl. The FRET labels may be any of TaqMan® probes, hairpin probes, Scorpion® probes, Molecular Beacon probes and the like.

[00168] Detecting and/or generating a record can be automated, for example, by means of a controller.

[00169] The method of in-situ identification may further include flowing an n^{th} reagent solution comprising an n^{th} set of hybridization probes into the flow region of the microfluidic device, where each hybridization probe of the n^{th} set may include: an oligonucleotide sequence complementary to a cassette oligonucleotide sequence comprised by any of the barcode sequences of any of the capture oligonucleotides of any of the one or more capture objects, wherein the complementary oligonucleotide sequence of each hybridization probe in the n^{th} set is non-identical to every other complementary oligonucleotide sequence of the hybridization probes in the n^{th} set and any other set of hybridization probes flowed into the flow region of the microfluidic device; and a detectable label selected from a set of spectrally distinguishable detectable labels, wherein the detectable label of each hybridization probe in the n^{th} set is different from the detectable label of every other hybridization probe in the n^{th} set of hybridization probes;

[00170] hybridizing the hybridization probes of the n^{th} set to corresponding cassette oligonucleotide sequences in any of the barcode sequences of any of the capture oligonucleotides of any of the one or more capture objects;

[00171] detecting, for each hybridization probe of the n^{th} set of hybridization probes, a corresponding detectable signal associated with any of the one or more capture objects; and

[00172] supplementing the record, for each capture object disposed within one of the one or more sequestration pens, with an association or non-association of the corresponding detectable signal of each hybridization probe of the n^{th} set of hybridization probes with the capture object, where n is a set of positive integers having values of $\{2, \dots, m\}$, where m is a positive integer having a value of 2 or greater, and where the foregoing steps of flowing the n^{th} reagent, hybridizing the n^{th} set of hybridization probes, detecting the corresponding detectable signals, and supplementing the records are repeated for each value of n in the set of positive integers $\{2, \dots, m\}$.

[00173] In various embodiments, m may have a value greater than or equal to 3 and less than or equal to 20 (e.g., greater than or equal to 5 and less than or equal to 15). In some embodiments, m may have a value greater than or equal to 8 and less than or equal to 12 (e.g., 10).

[00174] In various embodiments, flowing the first reagent solution and/or the n^{th} reagent solution into the flow region may further include permitting the first reagent solution and/or the n^{th} reagent solution to equilibrate by diffusion into the one or more sequestration pens.

[00175] Detecting the corresponding fluorescent signal associated with any of the one or more capture objects may further include: flowing a rinsing solution having no hybridization probes through the flow region of the microfluidic device; and equilibrating by diffusion the rinsing solution into the one or more sequestration pens, thereby allowing unhybridized hybridization probes of the first set or any of the n^{th} sets to diffuse out of the one or more sequestration pens. In some embodiments, the flowing of the rinsing solution may be performed before detecting the fluorescent signal.

[00176] In some embodiments of the method of in-situ detection, each barcode sequence of each capture oligonucleotide of each capture object may include three cassette oligonucleotide sequences. In some embodiments, the first set of hybridization probes and each of the n^{th} sets of hybridization probes may include three hybridization probes.

[00177] In various embodiments of the method of in-situ detection, each barcode sequence of each capture oligonucleotide of each capture object may include four cassette oligonucleotide sequences. In some embodiments, the first set of hybridization probes and each of the n^{th} sets of hybridization probes comprise four hybridization probes.

[00178] Disposing each of the one or more capture objects may include disposing each of the one or more capture objects within an isolation region of the one or more sequestration pens within the microfluidic device.

[00179] In some embodiments, the method may further include disposing one or more
5 biological cells within the one or more sequestration pens of the microfluidic device. In some embodiments, each one of the one or more biological cells may be disposed in a different one of the one or more sequestration pens. The one or more biological cells may be disposed within the isolation regions of the one or more sequestration pens of the microfluidic device. In some
10 embodiments of the method, at least one of the one or more biological cells may be disposed within a sequestration pen having one of the one or more capture objects disposed therein. In some embodiments, the one or more biological cells may be a plurality of biological cells from a clonal population. In various embodiments of the method, disposing the one or more biological cells may be performed before disposing the one or more capture objects.

[00180] In various embodiments of the method of in-situ detection, the enclosure of the
15 microfluidic device may further include a dielectrophoretic (DEP) configuration, and disposing the one or more capture objects into one or more sequestration pens may be performed using dielectrophoretic (DEP) force. In various embodiments of the method of in-situ detection, the enclosure of the microfluidic device may further include a dielectrophoretic (DEP)
20 configuration, and disposing the one or more biological cells within the one or more sequestration pens may be performed using dielectrophoretic (DEP) forces. The microfluidic device can be any microfluidic device disclosed herein. For example, the microfluidic device can comprise at least one coated surface (e.g., a covalently bound surface). The at least one coated surface can comprise a hydrophilic or a negatively charged coated surface.

[00181] In various embodiments of the method of in-situ identification, at least one of the
25 plurality of capture oligonucleotides of each capture object may further include a target nucleic acid captured thereto by the capture sequence.

[00182] Turning to Figure 7A for better understanding of the method of in-situ identification of capture object(s) within a microfluidic device, a schematic is shown of capture object 430, having capture oligonucleotides including barcodes as described herein, being exposed to a flow
30 of hybridization probes 440a, which include a detectable label as described herein. Upon associating of the probe 440a with its target cassette oligonucleotide of the capture oligonucleotide, a hybridized probe: cassette oligonucleotide sequence is formed upon the capture oligonucleotide length 755. This gives rise to a capture object having multiple hybridized probe: cassette oligonucleotide pairs along at least a portion of the capture

oligonucleotides of the capture object 730. Figure 7B shows a photograph of the microfluidic channel within the microfluidic device having sequestration pens opening off of the channel where capture objects (not seen in this photograph) have been disposed within the sequestration pens. Additionally, while there were capture objects within the pens opening to all three of the channel lengths visible, only capture objects placed within the sequestration pens at the bottom most channel length had a barcode that included the target cassette oligonucleotide of probe 440a. The capture objects in the sequestration pens opening to the uppermost channel or the middle channel had no cassette oligonucleotides on their respective capture oligonucleotides that were hybridization targets for probe 440a. The photograph shows a timepoint when reagent flow including hybridization probe 440a was being flowed through the flow channel and was diffusing into the sequestration pens. The fluorescence of the detectable label of probe was visible throughout the flow channel and within the sequestration pens. After permitting reagent flow for about 20 min, a rinsing flow, having no hybridization probe 440a, was performed as described herein. Figure 7B shows the same field of view, under fluorescent excitation appropriate to excite the detectable label of probe 440a, after the rinsing flow was completed. What was seen was capture objects 730 in the sequestration pens opening off the bottommost channel, providing a detectable signal from the hybridization probes 440a hybridized there. What was also seen was that the other classes of capture objects, within the sequestration pens opening off the uppermost and middle channel lengths, were not visible under fluorescent illumination. This illustrated the specific and selective identification of only the target cassette oligonucleotide sequence within the microfluidic device using hybridization probes to perform the identification.

[00183] Figures 8A-8C show how the multiplexed and multiple flows of reagent having, in this example, four different hybridization probes may be used to identify each barcode of each capture object within a sequestration pen of a microfluidic device. Figure 8A shows a schematic representation of detection of the barcode for each of four sequestration pens illustrated, Pen# 84, Pen # 12, Pen #126, and Pen # 260, each pen having a capture object present within it. Each capture object has a unique barcode which includes four cassette oligonucleotide sequences. The capture object in Pen # 84 has a barcode having a sequence:

GGGGGCCCCCTTTTTTTTTTCCGGCCGGCCAAAATTTTT (SEQ ID NO. 89). The capture object in Pen # 12 has a barcode having a sequence of:

AAAAAAAAAATTTTTTTTTTGGGGGGGGGGCCCCCCCC (SEQ ID NO. 90). The capture object in Pen # 126 has a barcode having a sequence of:

GGGGGCCCCCTTAATTAATTCCGGCCGGCCAAAATTTTT (SEQ ID 91). The capture

object in Pen #260 has a barcode having a sequence of:

GGGGGCCCCCTTTTTTTTTTGGGGGGGGGGCCCCCCCC (SEQ ID No. 92).

[00184] The first reagent flow 820 includes four hybridization probes having sequences and detectable labels as follows: a first probe 440a-1 having a sequence of TTTTTTTTTT (SEQ ID 5 85)(for this illustration, the choice of sequence is only for explication, and does not represent a probe sequence used in combination with a capture sequence of PolyT) having a first detectable label selected from a set of four distinguishable labels (represented as a circle having pattern 1); a second probe 440b-1 having a sequence of AAAAAAAAAA (SEQ ID NO. 86), having a second detectable label selected from the set of distinguishable labels (represented as the circle 10 having pattern 2); a third probe 440c-1 having a sequence of CCCCCCCCCC (SEQ ID No. 87) and a third detectable label selected from the set of distinguishable labels (represented as the circle having pattern 3); and a fourth probe 440d-1, having a sequence of GGGGGGGGGG (SEQ ID NO. 88), and a fourth detectable label selected from the set of distinguishable labels (represented as the circle having pattern 4).

15 [00185] After the first flow 810 has been permitted to diffuse into the sequestration pens, and the probes have hybridized to any target cassette oligonucleotide sequences present in any of the barcodes, flushing with probe-free medium is performed to remove unhybridized probes, while retaining hybridized probes in place. This is accomplished by use of medium that does not dissociate hybridized pairs of probes from their target, such as use of DPBS or Duplex 20 buffer, as described below in the Experimental section. After the excess, unhybridized probe containing medium has been flushed, excitation with the appropriate excitation wavelengths permit detection of the detectable labels on the probes still hybridized to their targets. In this example, it is observed that for Pen #84, a signal is observed for the wavelength of the second distinguishable detection, and no other. This is notated with the patterned circle next to Pen #84 25 indicating pattern 2 was observed in Flow 1 (810). For Pen #12, signals in all four distinguishable detection wavelengths is observed, and notated with the corresponding patterns 1-4. For Pen # 126, no detectable signal observed, and the circles along the figure so notate. Last, Pen #260, three of the probes, 440b-1, 440c-1 and 440d-1 bind, and notation of the detectable signals observed is made showing pattern 2, 3, and 4.

30 [00186] It can be seen that not all cassette oligonucleotide sequences have been detected, so a second flow 815 is then performed as shown in Figure 8B. The second flow contains four non-identical probes, probe 440a-2 having a sequence of CCCCCGGGGG (SEQ ID NO. 93) with detectable label 1 of the set of distinguishable labels (represented as pattern 1); a second probe 440b-2 having a sequence of AATTAATTAA (SSEQ ID No. 94) having detectable label

2 of the set (represented as pattern 2); a third probe 440c-2, having a sequence of GGCCGGCCGG (SEQ ID No. 95) having the third detectable label of the set (represented as pattern 3); and a fourth probe 440d-2, having a sequence of TTTTAAAAA (SSEQ ID No. 96) with the fourth detectable label of the set (represented as pattern 4).

5 [00187] The same process of flowing the reagent flow 2 (815) in, permitting diffusion and binding, flushing unhybridized probes and then detecting in each of the four distinguishable wavelengths is performed. As shown in Figure 8B, Pen #12 has no detectable signals as none of the probes of the second flow are configured to hybridize with any of the cassette sequences therein. Further, all of the cassette sequences of the barcode of the capture object in Pen #12
10 were already detected. Additionally, in these methods, it is noted when a signal in one of the detectable label wavelength channels has been detected as the cassette sequences are selected to have only one of each detectable signal and will have no repeats. Detectable signals in that channel in later flows may be disregarded as the probe that binds that cassette oligonucleotide sequence of the barcode has already been detected. In some instances, signal may be seen in
15 later flows, but that is a result of probes from an earlier flow still remaining hybridized to the barcode sequence, not of the new flow reagents binding to the cassette oligonucleotide sequence.

[00188] Returning to the analysis from detection of the second flow 815, the capture object in Pen #84 is noted to having signal in the first, third and fourth detectable signal wavelength
20 channel, and notated with the first, third and fourth pattern. The capture object in Pen #126 has all four probes binding, so is notated with the first, second, third and fourth pattern. The capture object in Pen #260 is notated as having signal in the first detectable label signal wavelength channel, and notated with the first pattern. The results can be tabulated as in Figure 8C, for the first flow 810, second flow 815, a third flow 820 and so on to the xth Flow 895, until the entire
25 reference set of cassette sequences has been tested with corresponding hybridization probes.

[00189] The sequence of each barcode on a capture object in a specific sequestration pen can be derived as shown, matching the detected signal pattern to the complementary sequence of each cassette oligonucleotide as the sequence of the hybridization probe is known. The sequence of the capture object can then be assigned as shown, where the barcode of the capture
30 object in Pen #12 is determined by the in-situ method of detection to have a sequence of SEQ ID NO. 90; the barcode of the capture object in Pen #84 to have a sequence of SEQ ID NO. 89; the barcode of the capture object in Pen #126 to have a sequence of SEQ ID No. 91, and the barcode of the capture object in Pen # 260 to have a sequence of SEQ ID NO. 92.

[00190] Figures 8D-F illustrate another experiment showing the ability to hybridize and detect multiple probes along the barcode sequence at the same time. In this experiment, the dyes that were utilized on the hybridization probes used were Alexa Fluor® 647 (detectable in a Cy®5 channel (e.g. detection filters that will detect a Cy®5 dye but can also detect an Alexa Fluor® 647 dye) and Alexa Fluor® 594 (detectable in a Texas Red channel (Detection filter that can also detect Alexa Fluor® 594)). In this experiment, a plurality of capture objects all having the same two cassette oligonucleotide sequences, which were situated adjacent to each other within the barcode sequence, were flowed into the microfluidic channel 120 within the microfluidic device 800, and no attempt to dispose them into sequestration pens was made. A flow was then made including a first hybridization probe having a sequence that binds the first cassette oligonucleotide of the barcode of the capture objects and an Alexa Fluor® 594 dye. The flow also contained a second hybridization probe having a sequence that binds the second cassette oligonucleotide of the barcode of the capture objects and an Alexa Fluor 647® dye. After permitting diffusion, hybridization and flushing to remove unhybridized probes,

[00191] Figures 8D, 8E and 8F each showed the detection channel (filter) for different wavelength regions. Figure 8D shows a Texas Red detection channel, with a 200 ms exposure, and capture objects 830 that have been excited and were detected. This confirmed that the Alexa Fluor® 594 label of the first hybridization probe was present (e.g., was bound to the cassette oligonucleotide sequence of the barcode). Figure 8E shows the same view within the microfluidic device channel 120, and is the Cy®5 detection channel, 800ms exposure, which detected Alexa Fluor 647 labels that are bound to a capture object. Capture objects 830 also were detected able in this channel, confirming that the second hybridization probe was bound to the capture objects 830 at the same time as the first hybridization probe, and that both signals are detectable. Figure 8F is the same view in a FITC detection (filter) channel, 2000 ms exposure, where no signal from capture objects in the channel were seen. This experiment demonstrated the ability to hybridize side-by-side fluorescent probes, with no loss of detection specificity.

[00192] In various embodiments, the detectable labels used may include Alexa Fluor® 647, which is detected in the Cy®5 fluorescent channel of the optical system that used to excite, observe and record events within the microfluidic device; Alexa Fluor® 405, which is detectable in the Dapi fluorescent channel of the optical system; Alexa Fluor® 488 which is detectable in the FITC fluorescent channel of the optical system; and Alexa Fluor® 594, which is detectable in the Texas Red fluorescent channel of the optical system. The fluorophores may be attached to the hybridization probe as is suitable for synthesis and can be at the 5' or the 3' end of the probe.

Hybridization of two probes, one labeled at the 5' end and one labeled at the 3' end, was found to be unaffected by the presence of adjacent labels (data not shown).

[00193] **Method of correlating genomic data with a cell in a microfluidic device.** A method is provided for correlating genomic data with a biological cell in a microfluidic device,
5 including:

[00194] disposing a capture object (which may be a single capture object) into a sequestration pen of a microfluidic device, where the capture object includes a plurality of capture oligonucleotides, where each capture oligonucleotide of the plurality includes: a priming sequence; a capture sequence; and a barcode sequence, where the barcode sequence includes
10 three or more cassetable oligonucleotide sequences, each cassetable oligonucleotide sequence being non-identical to the other cassetable oligonucleotide sequences of the barcode sequence; and where each capture oligonucleotide of the plurality includes the same barcode sequence;

[00195] identifying the barcode sequence of the plurality of capture oligonucleotides in-situ and recording an association between the identified barcode sequence and the sequestration pen
15 (i.e., identifying a location of the capture object within the microfluidic device);

[00196] disposing the biological cell into the sequestration pen;

[00197] lysing the biological cell and allowing nucleic acids released from the lysed biological cell to be captured by the plurality of capture oligonucleotides comprised by the capture object;

[00198] transcribing (e.g., reverse transcribing) the captured nucleic acids, thereby producing a
20 plurality (which could be a library) of barcoded cDNAs, each barcoded cDNA including a complementary captured nucleic acid sequence covalently linked to one of the capture oligonucleotides;

[00199] sequencing the transcribed nucleic acids and the barcode sequence, thereby obtaining read sequences of the plurality of transcribed nucleic acids associated with read sequences of the
25 barcode sequence;

[00200] identifying the barcode sequence based upon the read sequences; and

[00201] using the read sequence-identified barcode sequence and the in situ-identified barcode sequence to link the read sequences of the plurality of transcribed nucleic acids with the sequestration pen and thereby correlate the read sequences of the plurality of transcribed nucleic
30 acids with the biological cell placed into the sequestration pen.

[00202] In some embodiments, a single biological cell may be disposed in the sequestration pen and subjected to the above method. Alternatively, more than one biological cell (e.g., a group of two or more biological cells that are from the same clonal population of cells) may be disposed within the sequestration pen and subjected to the above method.

[00203] The disposing of the capture object, identifying of the barcode of the capture object, disposing the biological cell, lysing/transcribing/ sequencing, and identifying the barcode sequence based upon the read sequence of the foregoing method can be performed in the order in which they are written or in other orders, with the limitation that the rearrangement of the order of these activities does not violate logical order (e.g., transcribing before lysing, and so on). As an example, in situ identification of the barcode sequence can be performed after introducing the biological cell into the sequestration pen, after lysing the biological cell, or after transcribing the captured nucleic acids. Likewise, the step of introducing the capture object into the sequestration pen can be performed after introducing the at least one biological cell into the sequestration pen.

[00204] In various embodiments, the method of correlating genomic data with a biological cell, may further include observing a phenotype of the biological cell; and correlating the read sequences of the plurality of transcribed nucleic acids with the phenotype of the biological cell. The method may additionally include observing a phenotype of the biological cell, where the biological cell is a representative of a clonal population; and correlating the read sequences of the plurality of transcribed nucleic acids with the phenotype of the biological cell and the clonal population. In some embodiments, observing the phenotype of the biological cell may include observing at least one physical characteristic of the at least one biological cell. In other embodiments, observing the phenotype of the biological cell may include performing an assay on the biological cell and observing a detectable signal generated during the assay. In some embodiments, the assay may be a protein expression assay.

[00205] For example, observing the phenotype of the biological cell can include observing a detectable signal generated when the biological cell interacts with an assay reagent. The detectable signal can be a fluorescent signal. Alternatively, the assay can be based upon the lack of a detectable signal. Further examples of assays that may be performed that provide a detectable signal identifying observation about the phenotype of the biological cell may be found within the disclosures of WO2015/061497 (Hobbs et al.); US2015/0165436 (Chapman et al.); and, International Application Serial No. PCT/US2017/027795 (Lionberger, et al.), each of which disclosures are hereby incorporated by reference in its entirety.

[00206] In various embodiments, identifying the barcode sequence of the plurality of capture oligonucleotides in-situ and recording an association between the identified barcode sequence and the sequestration pen may be performed before disposing the biological cell into the sequestration pen. In some other embodiments, identifying the barcode sequence of the plurality of capture oligonucleotides in-situ and recording an association between the identified barcode

sequence and the sequestration pen may be performed after introducing the biological cell into the sequestration pen.

[00207] In yet other embodiments, disposing the capture object and, optionally, identifying the barcode sequence of the plurality of capture oligonucleotides in-situ and recording an association between the identified barcode sequence and the sequestration pen may be performed after observing a phenotype of the biological cell. In some embodiments, identifying the barcode sequence of the plurality of capture oligonucleotides in-situ and recording an association between the identified barcode sequence and the sequestration pen may be performed after lysing the biological cell and allowing the nucleic acids released from the lysed biological cell to be captured by the plurality of capture oligonucleotides comprised by the capture object. In various embodiments, identifying the barcode sequence of the plurality of capture oligonucleotide in-situ may include performing any variation of the method as described herein. In various embodiments of the method of correlating genomic data with a biological cell in a microfluidic device, the capture object may be any capture object as described herein.

[00208] In various embodiments of the method, the enclosure of the microfluidic device may include a dielectrophoretic (DEP) configuration, and disposing the capture object into the sequestration pen may include using dielectrophoretic (DEP) forces to move the capture object. In some other embodiments of the method, the enclosure of the microfluidic device may further include a dielectrophoretic (DEP) configuration, and disposing the biological cell within the sequestration pen may include using dielectrophoretic (DEP) forces to move the biological cell.

[00209] In various embodiments of the method of correlating genomic data with a biological cell in a microfluidic device, the method may further include: disposing a plurality of capture objects into a corresponding plurality of sequestration pens of the microfluidic device (e.g., this may include disposing a single capture object per sequestration pen); disposing a plurality of biological cells into the corresponding plurality of sequestration pens, and processing each of the plurality of capture objects and plurality of biological cells according to the additional steps of the method.

[00210] A kit for producing a nucleic acid library. A kit is also provided for producing a nucleic acid library, including: a microfluidic device comprising an enclosure, where the enclosure includes a flow region and a plurality of sequestration pens opening off of the flow region; and a plurality of capture objects, where each capture object of the plurality includes a plurality of capture oligonucleotides, each capture oligonucleotide of the plurality including: a capture sequence; and a barcode sequence comprising at least three cassette oligonucleotide sequences, where each cassette oligonucleotide sequence of the barcode sequence is non-

identical to the other cassetable oligonucleotide sequences of the barcode sequence, and where each capture oligonucleotide of the plurality comprises the same barcode sequence.

[00211] Each capture oligonucleotide of the plurality may include at least two cassetable oligonucleotide sequences (e.g., three, four, five, or more cassetable oligonucleotide sequences).

5 The cassetable oligonucleotide sequences can be as described elsewhere herein. For example, the cassetable oligonucleotide sequences can be selected from a set of non-identical cassetable oligonucleotide sequences. The set can include 12 or more (e.g., 12 to 100) non-identical cassetable oligonucleotide sequences.

[00212] The microfluidic device can be any microfluidic device as described herein. In various
10 embodiments, the enclosure of the microfluidic device may further include a dielectrophoretic (DEP) configuration.

[00213] In various embodiments of the kit for producing a nucleic acid library, the plurality of capture objects may be any plurality of capture objects as described herein. In some
15 embodiments, each of the plurality of capture objects may be disposed singly into corresponding sequestration pens of plurality.

[00214] In various embodiments of the kit for producing a nucleic acid library, the kit may further include an identification table, wherein the identification table correlates the barcode sequence of the plurality of capture oligonucleotides of each of the plurality of capture objects with the corresponding sequestration pens of the plurality.

20 [00215] In various embodiments of the kit for producing a nucleic acid library, the kit may further include: a plurality of hybridization probes, where each hybridization probe includes: an oligonucleotide sequence complementary to any one of the cassetable oligonucleotide sequences of the plurality of capture oligonucleotides of any one of the plurality of capture objects; and a label, where the complementary sequence of each hybridization probe of the plurality is
25 complementary to a different cassetable oligonucleotide sequence; and where the label of each hybridization probe of the plurality is selected from a set of spectrally distinguishable labels. In various embodiments, each complementary sequence of a hybridization probe of the plurality may include an oligonucleotide sequence comprising a sequence of any one of SEQ ID NOs: 41 to 80. In various embodiments, the label may be a fluorescent label.

30 [00216] **Method for producing a capture object.** A method is also provided for producing a capture object having a plurality of capture oligonucleotides, including: chemically linking each of the plurality of capture oligonucleotides to the capture object, wherein each capture oligonucleotide of the plurality includes: a priming sequence which binds to a primer; a capture sequence (e.g., configured to hybridize with a target nucleic acid); and a barcode sequence,

wherein the barcode sequence includes three or more cassetable oligonucleotide sequences, each cassetable oligonucleotide sequence being non-identical to the other cassetable oligonucleotide sequences of the barcode sequence; and wherein each capture oligonucleotide of the plurality comprises the same barcode sequence.

5 [00217] In various embodiments, the capture object may be a bead. For example, the capture object can be a bead (or similar object) having a core that includes a paramagnetic material, a polymeric material and/or glass. The polymeric material may be polystyrene or any other plastic material which may be functionalized to link the capture oligonucleotide. The core material of the capture object may be coated to provide a suitable material to attach linkers to the capture
10 oligonucleotide, which may include functionalized polymers, although other arrangements are possible.

[00218] In various embodiments, linking may include covalently linking each of the plurality of capture oligonucleotides to the capture object. Alternatively, each of the plurality of capture oligonucleotides may be non-covalently linked to the bead, which may be via a
15 streptavidin/biotin linkage. The barcoded beads may be synthesized in any suitable manner as is known in the art. The priming sequence/Unique molecular identifier tag/Cell Barcode/primer sequence may be synthesized by total oligonucleotide synthesis, split and pool synthesis, ligation of oligonucleotide segments of any length, or any combination thereof.

[00219] Each capture oligonucleotide of the plurality may include a 5'-most nucleotide and a
20 3'-most nucleotide, where the priming sequence may be adjacent to or comprises the 5'-most nucleotide, where the capture sequence may be adjacent to or comprises the 3'-most nucleotide, and where the barcode sequence may be located 3' to the priming sequence and 5' to the capture sequence.

[00220] In various embodiments, the three or more cassetable oligonucleotide sequences of
25 each barcode sequence may be linked in tandem without any intervening oligonucleotide sequences. In some other embodiments, the one or more of the cassetable oligonucleotides may be linked to another cassetable oligonucleotide sequence via intervening one or two nucleotides to permit linking via ligation chemistry.

[00221] In various embodiments, the method may further include: introducing each of the three
30 or more cassetable oligonucleotide sequences into the capture oligonucleotides of the plurality via a split and pool synthesis.

[00222] In various embodiments of the method of producing a capture object, each cassetable oligonucleotide sequence may include about 6 to 15 nucleotides, and may include about 10 nucleotides.

[00223] In various embodiments, the method may further include: selecting each of the three or more cassetable oligonucleotide sequences of each barcode sequence from a set of 12 to 100 non-identical cassetable oligonucleotide sequences. In some embodiments, the method may include selecting each of the three or more cassetable oligonucleotides sequences of each
5 barcode sequence from SEQ ID NOs: 1-40.

[00224] In some embodiments, the cell-associated barcode sequence may include four cassetable oligonucleotide sequences. In various embodiments, the method may include selecting: a first cassetable oligonucleotide sequence from any one of SEQ ID NOs: 1-10; selecting a second cassetable oligonucleotide sequence from any one of SEQ ID NOs: 11- 20;
10 selecting a third cassetable oligonucleotide sequence from any one of SEQ ID NOs: 21-30; and selecting a fourth cassetable oligonucleotide sequence from any one of SEQ ID NOs: 31-40.

[00225] In various embodiments of the method of producing a capture object, the when separated from said capture oligonucleotide, primes a DNA polymerase. In some embodiments, the DNA polymerase is a reverse transcriptase. In some embodiments, the priming sequence
15 comprises a sequence of a P7 or P5 primer.

[00226] In some embodiments, the method may further include: introducing a unique molecule identifier (UMI) sequence into each capture oligonucleotide of the plurality, such that each capture oligonucleotide of the plurality includes a different UMI. The UMI may be an oligonucleotide sequence comprising 5 to 20 nucleotides (e.g., 8 to 15 nucleotides).

20 [00227] In various embodiments of the method of producing a capture object, the capture sequence may include a poly-dT sequence, a random hexamer, or a mosaic end sequence.

[00228] In various embodiments of the method of producing a capture object, the method may further include: introducing the primer sequence into each capture oligonucleotide of the plurality near a 5' end of the capture oligonucleotide; and, introducing the capture sequence into
25 each capture oligonucleotide of the plurality near a 3' end of the capture oligonucleotide. In some embodiments, the method may further include: introducing the barcode sequence into each capture oligonucleotide of the plurality after introducing the priming sequence and before introducing the capture sequence.

[00229] In some embodiments, the method may further include: introducing the UMI into each
30 capture oligonucleotide of the plurality after introducing the priming sequence and before introducing the capture sequence. In yet other embodiments, the method may further include: introducing a sequence comprising a NotI restriction site into each capture oligonucleotide of the plurality. In some embodiments, the method may further include: introducing the sequence

comprising the NotI restriction site after introducing the barcode sequence and before introducing the capture sequence.

[00230] In various embodiments of the method of producing a capture object, the method may further include: introducing one or more adapter sequences into each capture oligonucleotide of the plurality.

[00231] **Methods of Generating Sequencing Libraries.** Based on the workflows described herein, a variety of sequencing libraries may be prepared that will permit correlation of genomic data with the location of the source cell as well as phenotype information observed for that cell. The approaches shown here are adapted for eventual use with Illumina® sequencing by synthesis chemistries, but are not so limited. Any sort of sequencing chemistries may be suitable for use within these methods and may include emulsion PCR, sequencing by synthesis, pyrosequencing and semiconductor detection. One of skill can adapt the methods and construction of the capture oligonucleotides and associated adaptors, primers and the like to use these methods within other massively parallel sequencing platforms and chemistries such as PacBio long read systems (SMRT, Pacific Biosystems), Ion Torrent (ThermoFisher Scientific), Roche 454, Oxford Nanopore, and the like.

[00232] **RNA capture and library preparation.** Also, a method is provided for providing a barcoded cDNA library from a biological cell, including: disposing the biological cell within a sequestration pen located within an enclosure of a microfluidic device; disposing a capture object within the sequestration pen, wherein the capture object comprises a plurality of capture oligonucleotides, each capture oligonucleotide of the plurality including: a priming sequence; a capture sequence; and a barcode sequence, wherein the barcode sequence comprises three or more cassetable oligonucleotide sequences, each cassetable oligonucleotide sequence being non-identical to every other cassetable oligonucleotide sequence of the barcode sequence; lysing the biological cell and allowing nucleic acids released from the lysed biological cell to be captured by the plurality of capture oligonucleotides comprised by the capture object; and

[00233] transcribing the captured nucleic acids, thereby producing a plurality of barcoded cDNAs decorating the capture object, each barcoded cDNA comprising (i) an oligonucleotide sequence complementary to a corresponding one of the captured nucleic acids, covalently linked to (ii) one of the plurality of capture oligonucleotides. The capture object may be a single capture object. The nucleic acids released from the lysed biological cell may be captured by the capture sequence of each of the plurality of capture oligonucleotides of the capture object. In some embodiments, transcribing may include reverse transcribing. The capture object and/or biological cell can be, for example, disposed within an isolation region of the sequestration pen.

[00234] In some embodiments, the biological cell may be an immune cell, for example a T cell, B cell, NK cell, macrophage, and the like. In some embodiments, the biological cell may be a cancer cell, such as a melanoma cancer cell, breast cancer cell, neurological cancer cell, etc. In other embodiments, the biological cell may be a stem cell (e.g., embryonic stem cell, induced pluripotent (iPS) stem cell, etc.) or a progenitor cell. In yet other embodiments, the biological cell may be an embryo (e.g., a zygote, a 2 to 200 cell embryo, a blastula, etc.). In various embodiments, the biological cell may be a single biological cell. Alternatively, the biological cell can be a plurality of biological cells, such as a clonal population.

[00235] In various embodiments, disposing the biological cell may further include marking the biological cell (e.g., with a marker for nucleic acids, such as Dapi or Hoechst stain).

[00236] The capture object may be any capture object as described herein.

[00237] In some embodiments, the capture sequence of one or more (which can be each) of the plurality of capture oligonucleotides may include an oligo-dT primer sequence. In other embodiments, the capture sequence of one or more (e.g., each) of the plurality of capture oligonucleotides may include a gene-specific primer sequence. In some embodiments, the gene-specific primer sequence may target (or may bind to) an mRNA sequence encoding a T cell receptor (TCR) (e.g., a TCR alpha chain or TCR beta chain, particularly a region of the mRNA encoding a variable region or a region of the mRNA located 3' but proximal to the variable region). In other embodiments, the gene-specific primer sequence may target (or may bind to) an mRNA sequence encoding a B-cell receptor (BCR) (e.g., a BCR light chain or BCR heavy chain, particularly a region of the mRNA encoding a variable region or a region of the mRNA located 3' but proximal to the variable region).

[00238] In various embodiments, the capture sequence of one or more (e.g., all or substantially all) of the plurality of capture oligonucleotides may bind to one of the released nucleic acids and primes the released nucleic acid, thereby allowing a polymerase (e.g., reverse transcriptase) to transcribe the captured nucleic acids.

[00239] In various embodiments, the capture object may include a magnetic component (e.g., a magnetic bead). Alternatively, the capture object can be non-magnetic.

[00240] In some embodiments, disposing the biological cell within the sequestration pen may be performed before disposing the capture object within the sequestration pen. In some embodiments, disposing the capture object within the sequestration pen may be performed before disposing the biological cell within the sequestration pen.

[00241] In various embodiments, the method may further include: identifying the barcode sequence of the plurality of capture oligonucleotides of the capture object in situ, while the

capture object is located within the sequestration pen. Identifying the barcode may be performed using any method of identifying the barcode as described herein. In various embodiments, identifying the barcode sequence may be performed before lysing the biological cell.

5 [00242] In some embodiments, the enclosure of the microfluidic device may include at least one coated surface. The coated surface can be coated with Tris and/or a polymer, such as a PEG-PPG block co-polymer. In yet other embodiments, the enclosure of the microfluidic device may include at least one conditioned surface.

[00243] The at least one conditioned surface may include a covalently bound hydrophilic moiety or a negatively charged moiety. A covalently bound hydrophilic moiety or negatively charged moiety can be a hydrophilic or negatively charged polymer.

[00244] In various embodiments, the enclosure of the microfluidic device may further include a dielectrophoretic (DEP) configuration. Disposing the biological cell and/or disposing the capture object may be performed by applying a dielectrophoretic (DEP) force on or proximal to the biological cell and/or the capture object.

[00245] The microfluidic device may further include a plurality of sequestration pens. In various embodiments, the method may further include disposing a plurality of the biological cells within the plurality of sequestration pens. In various embodiments, the plurality of the biological cells may be a clonal population. In various embodiments, disposing the plurality of the biological cells within the plurality of sequestration pens may include disposing substantially only one biological cell of the plurality in corresponding sequestration pens of the plurality. Thus, each sequestration pen of the plurality having a biological cell disposed therein will generally contain a single biological cell. For example, less than 10%, 7%, 5%, 3% or 1% of occupied sequestration pens may contain more than one biological cell.

25 [00246] In various embodiments, the method may further include: disposing a plurality of the capture objects within the plurality of sequestration pens. In some embodiments, disposing the plurality of the capture objects within the plurality of sequestration pens may include disposing substantially only one capture object within corresponding ones of sequestration pens of the plurality. In some embodiments, disposing the plurality of capture objects within the plurality of sequestration pens may be performed before the lysing the biological cell or the plurality of the biological cells. The plurality of the capture objects may be any plurality of capture objects as described herein.

[00247] In various embodiments, the method may further include: exporting the capture object or the plurality of the capture objects from the microfluidic device. In some embodiments, the

capture object or capture objects are cDNA decorated capture objects. In some embodiments, exporting the plurality of the capture objects may include exporting each of the plurality of the capture objects individually, (i.e., one at a time). In various embodiments, the method may further include: delivering each the capture object of the plurality to a separate destination
5 container outside of the microfluidic device.

[00248] In various embodiments, one or more of the disposing the biological cell or plurality of the biological cells; the disposing the capture object or the plurality of the capture objects; the lysing the biological cell or the plurality of the biological cells and the allowing nucleic acids released from the lysed biological cell or the plurality of the biological cells to be captured; the
10 transcribing; and the identifying the barcode sequence of the capture object or each the capture object of the plurality in-situ (if performed), may be performed in an automated manner.

[00249] Also, a method is provided for providing a barcoded sequencing library, including: amplifying a cDNA library of a capture object or a cDNA library of each of a plurality of the capture objects obtained by any method described herein; and tagging the amplified DNA
15 library or the plurality of cDNA libraries, thereby producing one or a plurality of barcoded sequencing libraries. In various embodiments, amplifying the cDNA library or the plurality of cDNA libraries may include introducing a pool index sequence, wherein the pool index sequence comprises 4 to 10 nucleotides. In other embodiments, the method may further include combining a plurality of the barcoded sequencing libraries, wherein each barcoded sequencing
20 library of the plurality comprises a different barcode sequence and/or a different pool index sequence.

[00250] The method of obtaining cDNA from released nucleic acid, such as RNA, may be more fully understood by turning to Figure 9, which is a schematic representation of the process. For Cell Isolation and Cell Lysis Box 902, a biological cell 410 may be placed within a
25 sequestration pen within a microfluidic device. A capture object 930, which may be configured as any capture object described herein, may be disposed into the same sequestration pen, which may be performed before or after disposing the cell 410 into the sequestration pen. The cell 410 may be lysed using a lysis reagent which lyses the outer cell membrane of cell 410 but not the nuclear membrane, as is described in the Examples below. A lysed cell 410' results from this
30 process and releases nucleic acid 905, e.g., RNA. The capture oligo nucleotide of capture object 930 includes a priming sequence 520, which has a sequence of 5'-
ACACTCTTTCCCTACACGACGCTCTTCCGATCT (SEQ ID NO. 104), and a barcode sequence 525, which may be configured like any barcode described herein. The capture oligonucleotide of capture object 930 may optionally include a UMI 530. The capture

oligonucleotide of capture object 930 includes a capture sequence, which in this case includes a PolyT sequence which can capture the released nucleic acid 905 having a PolyA sequence at its 3' end. The capture sequence 535 captures the released nucleic acid 905. In the Cellular and Molecular barcoding box 904 and Reverse Transcription box 906 the capture oligonucleotide is, and reversed transcribed from the released nucleic acid 905 while in the presence of template switching oligonucleotide 915, which has a sequence of /5Me-isodC//isodG//iMe-isodC/ACACTCTTTCCCTACACGACGCrGrGrG (SEQ ID NO. 103). Identification of the barcode 912 may be performed, using any of the methods described herein either before RNA capture to the barcoded beads; before reverse transcription of the RNA captured to the beads, or after reverse transcription of the RNA on the bead. In some embodiments, identification of the cell specific barcode may be performed after reverse transcription of RNA captured to the bead. After both reverse transcription and in-situ identification of the barcode of the capture object has been achieved, the cDNA decorated capture object is exported out of the microfluidic device. A plurality of cDNA capture objects may be exported at the same time and the Pooling and cDNA amplification box 912 (creating DNA amplicons 92) is performed, using an amplification primer having a sequence of 5'-/5Biosg/ACACTCTTTCCCT ACACGACGC-3' (SEQ ID NO. 105). Adapting, sizing and indexing box 916 is then performed on the amplified DNA 920. This includes the One Sided Tagmentation box 914 which fragments DNA to size the DNA 925 and insert tagmentation adaptors 942. While tagmentation is illustrated herein, this process can also be performed by enzymatic fragmentation, such as using fragmentase (NEB, Kapa), followed by end repair.

[00251] Also included in box 0916 is Pool Indexing box 918 where tagmented DNA 940 is acted upon by primers 935a and 935b. A first primer 935a, directed against the tagmentation adaptor 942 introduce a P7 sequencing adaptor 932, having a sequence of:
 5'-CAAGCAGAAGACGGCATACGAGAT-3 (SEQ ID NO. 107);
 and also introduces optional Pool Index 934. A second primer 935b, having a sequence of:
 (5'- AATGATACGGCGACCACCGAGATCTACACTCTTTCCCTACACGACGCTCTTC
 C*G*A*T*C*T-3 (SEQ ID No. 106) has a portion directed against priming sequence 520 and introduces a P5 sequencing adaptor sequence 936. The sized, indexed and adapted sequencing library 950 may be sequenced in the Sequencing box 922, where a first sequencing read 955 (point of sequence read initiation reads the barcode 525 and optional UMI 539. A second sequencing read 960 reads Pool Index 934. A third sequencing read 965 reads a desired number of bp within the DNA library itself, to generate genomic reads.

[00252] Figures 10A-10D are photographic representations of one embodiment of a process for lysis of an outer cell membrane with subsequent RNA capture according to one embodiment of the disclosure. Figure 10A shows a brightfield image showing the capture object 430 and cell 430 prior to lysis, each disposed within a sequestration pen within microfluidic device 1000. Figure 5 10B shows fluorescence from DAPI stained nucleic of the intact cells 410 at the same timepoint, before lysis. Figure 10C shows brightfield image of the capture object 930 and the remaining, unlysed nuclei 410' after lysis has been completed. Figure 10D shows a fluorescent image at the same timepoint as Figure 10C after lysis, showing DAPI fluorescence from the unbreached nuclei 410', showing that the nucleus is intact.

10 [00253] Figure 11A is a schematic representation of the processing of the cDNA resulting from the capture of RNA as shown in Figure 9, that is performed outside of the microfluidic environment, including cDNA amplification box 912, One-sided Tagmentation box 914, Pool Indexing box 918 and Sequencing box 922, along with some quality analysis. The QC after cDNA amplification box 912 is shown for amplified DNA 920 in Figure 11B, showing a size distribution 15 having a large amount of product having a size of 700 to well over 1000bp. After completion of the tagmentation step, the size distribution of the resultant fragments in the barcoded library is shown in Figure 11C, and is within 300-800 bp, which is optimal for sequencing by synthesis protocols. Quantitation measured by Qubit shows that about 1.160 ng/ microliter of barcoded DNA sample was obtained from a single cell. For a sequencing run, and individually barcoded 20 material from about 100 single cells was pooled to perform a sequencing run, providing sequencing data for each of the about 100 single cells.

[00254] This workflow may also be adapted to PacBio library preparation (SMRT system, Pacific Biosystems) by processing the barcoded cDNA obtained above, and SMRTbell adaptors may be directly ligated to the full length barcoded transcripts.

25 [00255] **DNA capture and generation of sequencing libraries.** Also, a method is provided for providing a barcoded genomic DNA library from a biological micro-object, including disposing a biological micro-object comprising genomic DNA within a sequestration pen located within an enclosure of a microfluidic device; contacting the biological micro-object with a lysing reagent capable of disrupting a nuclear envelope of the biological micro-object, thereby releasing 30 genomic DNA of the biological micro-object; tagmenting the released genomic DNA, thereby producing a plurality of tagmented genomic DNA fragments having a first end defined by a first tagmentation insert sequence and a second end defined by a second tagmentation insert sequence; disposing a capture object within the sequestration pen, wherein the capture object comprises a plurality of capture oligonucleotides, each capture oligonucleotide of the plurality comprising: a

first priming sequence; a first tagmentation insert capture sequence; and a barcode sequence, wherein the barcode sequence comprises three or more casetable oligonucleotide sequences, each casetable oligonucleotide sequence being non-identical to every other casetable oligonucleotide sequence of the barcode sequence; contacting ones of the plurality of tagmented genomic DNA fragments with (i) the first tagmentation insert capture sequence of ones of the plurality of capture oligonucleotides of the capture object, (ii) an amplification oligonucleotide comprising a second priming sequence linked to a second tagmentation insert capture sequence, a randomized primer sequence, or a gene-specific primer sequence, and (iii) an enzymatic mixture comprising a strand displacement enzyme and a polymerase; incubating the contacted plurality of tagmented genomic DNA fragments for a period of time, thereby simultaneously amplifying the ones of the plurality of tagmented genomic DNA fragments and adding the capture oligonucleotide and the amplification oligonucleotide to the ends of the ones of the plurality of tagmented genomic DNA fragments to produce the barcoded genomic DNA library; and exporting the barcoded genomic DNA library from the microfluidic device.

15 [00256] In some embodiments, the genomic DNA can include mitochondrial DNA.

[00257] In various embodiments, the capture object can be placed in sequestration pen before or after the tagmenting step. In various embodiments, incubation can be performed under isothermal conditions (e.g., about 30°C to about 45°C, typically about 37°C).

20 [00258] Exporting can include allowing the amplified genomic DNA to diffuse out of the sequestration pen into a flow region (e.g., a channel) to which the sequestration pen is connected, and then flowing medium (e.g., amplification buffer, export buffer, or the like) through the flow region, out of the microfluidic device, and into an appropriate receptacle (e.g., a well of a well-plate, a tube, such as a microcentrifuge tube, or the like).

[00259] In some embodiments, disposing the biological micro-object within the sequestration pen may be performed before disposing the capture object within the sequestration pen.

[00260] In some embodiments, the biological micro-object may be a biological cell. In other embodiments, the biological micro-object may be a nucleus of a biological cell (e.g., a eukaryotic cell).

30 [00261] In some embodiments, the biological cell is an immune cell (e.g., T cell, B cell, NK cell, macrophage, etc.). In some embodiments, the biological cell may be a cancer cell (e.g., melanoma cancer cell, breast cancer cell, neurological cancer cell, etc.).

[00262] In some embodiments, the lysing reagent may include at least one ribonuclease inhibitor.

[00263] In various embodiments, the tagmenting may include contacting the released genomic DNA with a transposase loaded with (i) a first double-stranded DNA fragment comprising the first tagmentation insert sequence, and (ii) a second double-stranded DNA fragment comprising the second tagmentation insert sequence. In some embodiments, the first double-stranded DNA fragment may include a first mosaic end sequence linked to a third priming sequence, and the second double-stranded DNA fragment may include a second mosaic end sequence linked to a fourth priming sequence.

[00264] In some embodiments, the first tagmentation insert capture sequence of each capture oligonucleotide of the capture object may include a sequence which is at least partially (or in some embodiment, it may be fully) complementary to the first tagmentation insert sequence. In some embodiments, the second tagmentation insert capture sequence of the amplification oligonucleotide comprises a sequence which is at least partially (or in some embodiments, it may be fully) complementary to the second tagmentation insert sequence. For example, the first tagmentation insert capture sequence of each capture oligonucleotide can be at least partially (e.g., fully) complementary to the first mosaic end sequence and/or the third priming sequence of the first tagmentation insert sequence. In other examples, the second tagmentation insert capture sequence of the amplification oligonucleotide can be at least partially (e.g., fully) complementary to the second mosaic end sequence and/or the fourth priming sequence of the second tagmentation insert sequence.

[00265] In various embodiments, the capture object may be any capture object as described herein. In some embodiments, the capture object may include a magnetic component (e.g., a magnetic bead). Alternatively, the capture object can be non-magnetic.

[00266] In various embodiments of the method providing a barcoded genomic DNA library, the method may further include: identifying the barcode sequence of the plurality of capture oligonucleotides of the capture object in situ, while the capture object is located within the sequestration pen. In some embodiments, identifying the barcode sequence may be performed using any method as described herein. In some other embodiments, identifying the barcode sequence is performed before lysing the biological cell. Alternatively, identifying the barcode sequence can be performed before tagmenting the released genomic DNA, or after exporting the barcoded genomic DNA library.

[00267] In some embodiments, the enclosure of the microfluidic device may include at least one coated surface. The coated surface can be coated with Tris and/or a polymer, such as a PEG-PPG block co-polymer. In some other embodiments, the enclosure of the microfluidic device comprises at least one conditioned surface. The method of claim 141, wherein the at

least one conditioned surface comprises a covalently bound hydrophilic moiety or a negatively charged moiety. In some embodiments, the covalently bound hydrophilic or negatively charged moiety can be a hydrophilic or negatively charged polymer.

[00268] In various embodiments, the enclosure of the microfluidic device may further include a dielectrophoretic (DEP) configuration, and disposing the biological micro-object and/or disposing the capture object may be performed by applying a dielectrophoretic (DEP) force on or proximal to the biological cell and/or the capture object.

[00269] In some embodiments, the microfluidic device may further include a plurality of sequestration pens. In various embodiments, the method may further include disposing a plurality of the biological micro-objects within the plurality of sequestration pens. In some embodiments, disposing the plurality of the biological micro-objects within the plurality of sequestration pens may include disposing substantially only one biological micro-object of the plurality in corresponding sequestration pens of the plurality.

[00270] Thus, each sequestration pen of the plurality having a biological micro-object disposed therein will generally contain a single biological micro-object. For example, less than 10%, 7%, 5%, 3% or 1% of occupied sequestration pens may contain more than one biological micro-object. In some embodiments, the plurality of the biological micro-objects may be a clonal population of biological cells.

[00271] In various embodiments, the method may further include: disposing a plurality of the capture objects within the plurality of sequestration pens. In some embodiments, disposing the plurality of the capture objects within the plurality of sequestration pens may include disposing substantially only one capture object within corresponding ones of sequestration pens of the plurality. In other embodiments, disposing the plurality of capture objects within the plurality of sequestration pens may be performed before the lysing the biological micro-object or the plurality of the biological micro-objects.

[00272] In some embodiments, the plurality of the capture objects may be any plurality of capture objects as described herein.

[00273] In various embodiments, the steps of tagmenting, contacting, and incubating may be performed at substantially the same time for each of the sequestration pens containing one of the plurality of biological micro-objects.

[00274] In some embodiments, one or more of the disposing the biological micro-object or the plurality of the biological micro-objects; the disposing the capture object or the plurality of the capture objects; the lysing the biological micro-object or the plurality of the biological micro-objects and the allowing nucleic acids released from the lysed biological cell or the plurality of

the biological cells to be captured; the fragmenting the released genomic DNA; the contacting ones of the plurality of fragmented genomic DNA fragments; the incubating the contacted plurality of fragmented genomic DNA fragments; the exporting the barcoded genomic DNA library or the plurality of DNA libraries; and the identifying the barcode sequence of the capture object or each the capture object of the plurality in-situ may be performed in an automated manner.

[00275] In some embodiments, the method may further include: exporting the capture object or the plurality of the capture objects from the microfluidic device. Exporting the plurality of the capture objects may include exporting each of the plurality of the capture objects individually.

10 In some embodiments, the method may further include: delivering each the capture object of the plurality to a separate destination container outside of the microfluidic device.

[00276] The methods may be better understood by turning to Figures 12A-G and Examples 3 and 4 below. Figures 12A-12F illustrate a workflow for obtaining a sequencing library having an in-situ detectable barcode as described herein. A biological cell 410 is disposed within a sequestration pen 405 which opens to a microfluidic channel (not shown) within a microfluidic device (Figure 12A). The cell is lysed to breach both the cell membrane and also the nuclear membrane, and release genomic DNA 1220, as in Figure 12B. Figure 12C illustrates the next process, fragmentation which is employed to create properly sized fragments and to insert tags providing fragmented DNA 1225 that permits capture and amplification. In Figure 12D, the capture object 1230 having a plurality of capture oligonucleotides is introduced to the pen 405 containing the fragmented DNA 1225. Each of the plurality of capture oligonucleotides includes an in-situ detectable barcode, priming sequence, and a capture sequence. In Figure 12E, fragmented DNA 1225 is subjected to an isothermal amplification using a recombinase/polymerase amplification, where the capture sequence of the capture oligonucleotides shepherd and direct (capture object 1230') the fragmented DNA, in the presence of the recombinase/polymerase machinery, to provided amplified DNA 1235, which includes sequencing adaptors, the barcode, and optional indices such as UMI or pool Index. Throughout amplification and thereafter, the amplified adapted barcoded DNA 1235 diffuses out of the sequestration pen 405 and into the microfluidic channel 122 to which the sequestration pens open, and are exported out of the microfluidic device using fluidic medium flow 242 (Figure 12F). Once exported, the amplified adapted barcoded DNA 1235 is quantified for use as a sequencing library, and may be pooled with other libraries for the sequencing run. After export of the DNA 1235 is complete, the in-situ determination of the barcode of the capture oligonucleotides of the capture object 1230 is performed using any of the methods described herein (Figure 12F).

[00277] Figure 12G shows schematic representations of the capture oligonucleotide and DNA processing in the method of generating a sequencing library from DNA of a cell. Each of the capture oligonucleotides of the capture object 1230 is linked, covalently or non-covalently via linker 1215, and includes, from the 5' end of the capture oligonucleotide: priming sequence/adaptor 1240; barcode 1245, optional UMI 1250 and capture sequence 1255, which has a tagmentation insert capture sequence and may capture (e.g., shepherd and direct) a Mosaic End insert sequence. The barcode sequence 1245 may be any barcode sequence containing at least three cassette oligonucleotide sequences as described herein. Tagmented DNA 1225 has tagmentation insert sequences 1255, which may be Mosaic End sequence insert, and DNA fragment 1260. It is primed during the isothermal recombinase polymerase driven amplification by either a generic primer 1275 having a P5 adaptor/priming sequence 1270, an optional Pool Index 1265 and the tagmentation insert capture sequence 1255. Alternatively, a gene specific primer 1275' may be used, where a portion of the primer 1261 is directed to select for a sub-set of DNA, e.g. a gene specific sequence.

[00278] The product of the isothermal amplification, which forms the sequencing library is amplified and adapted DNA 1280 or 1280'. Amplified and adapted DNA 1280 is the product of generic primer 1275, and includes generic library of DNA fragments 1260, while amplified DNA 1280', has a DNA fragment region 1262 (remainder of gene specific DNA primed by the gene specific priming sequence) plus 1261(gene specific priming sequence) which include gene specific amplification products.

[00279] **Generation of a barcoded cDNA library and a barcoded genomic DNA library from the same cell.** Also, a method is provided for providing a barcoded cDNA library and a barcoded genomic DNA library from a single biological cell, including: disposing the biological cell within a sequestration pen located within an enclosure of a microfluidic device; disposing a first capture object within the sequestration pen, where the first capture object comprises a plurality of capture oligonucleotides, each capture oligonucleotide of the plurality comprising: a first priming sequence; a first capture sequence (e.g., configured to capture a released nucleic acid); and a first barcode sequence, wherein the first barcode sequence comprises three or more cassette oligonucleotide sequences, each cassette oligonucleotide sequence being non-identical to every other cassette oligonucleotide sequence of the first barcode sequence; obtaining the barcoded cDNA library by performing any method of obtaining a cDNA library as described herein, where lysing the biological cell is performed such that a plasma membrane of the biological cell is degraded, releasing cytoplasmic RNA from the biological cell, while leaving a nuclear envelope of the biological cell intact, thereby providing the first capture object decorated

with the barcoded cDNA library from the RNA of the biological cell; exporting the cDNA library-decorated first capture object from the microfluidic device; disposing a second capture object within the sequestration pen, wherein the second capture object comprises a plurality of capture oligonucleotides, each including: a second priming sequence; a first tagmentation insert capture sequence; and a second barcode sequence, wherein the second barcode sequence comprises three or more cassetable oligonucleotide sequences, each cassetable oligonucleotide sequence being non-identical to every other cassetable oligonucleotide sequence of the second barcode sequence; obtaining the barcoded genomic DNA library by performing any method of obtaining a barcoded genomic DNA library as described herein, where a plurality of tagmented genomic DNA fragments from the biological cell are contacted with the first tagmentation insert capture sequence of ones of the plurality of capture oligonucleotides of the second capture object, thereby providing the barcoded genomic DNA library from the genomic DNA of the biological cell; and exporting the barcoded genomic DNA library from the microfluidic device.

[00280] In some embodiments, the method may further include: identifying the barcode sequence of the plurality of capture oligonucleotides of the first capture object. In some embodiments, identifying the barcode sequence of the plurality of capture oligonucleotides of the first capture object may be performed before disposing the biological cell in the sequestration pen; before obtaining the barcoded cDNA library from the RNA of the biological cell; or before exporting the barcoded cDNA library-decorated first capture object from the microfluidic device.

[00281] In some embodiments, the method may further include: identifying the barcode sequence of the plurality of oligonucleotides of the second capture object.

[00281] In various embodiments, identifying the barcode sequence of the plurality of capture oligonucleotides of the second capture may be performed before obtaining the barcoded genomic DNA library or after exporting the barcoded genomic DNA library from the microfluidic device.

[00282] In various embodiments, identifying the barcode sequence of the plurality of capture oligonucleotides of the first or the second capture object may be performed using any method of identifying a barcode in-situ as described herein.

[00283] In various embodiments, the first capture object and the second capture object may each be any capture object as described herein.

[00284] In some embodiments, the first priming sequence of the plurality of capture oligonucleotides of the first capture object may be different from the second priming sequence of the plurality of capture oligonucleotides of the second capture object. In other embodiments, the first capture sequence of the plurality of capture oligonucleotides of the first capture object may

be different from the first tagmentation insert capture sequence of the plurality of capture oligonucleotides of the second capture object.

[00285] In various embodiments, the barcode sequence of the plurality of capture oligonucleotides of the first capture object may be the same as the barcode sequence of the plurality of capture oligonucleotides of the second capture object. In other embodiments, the barcode sequence of the plurality of capture oligonucleotides of the first capture object may differ from the barcode sequence of the plurality of capture oligonucleotides of the second capture object.

[00286] **Generation of B cell Receptor sequencing libraries.**

10 [00287] A method is provided for providing a barcoded B cell receptor (BCR) sequencing library, including: generating a barcoded cDNA library from a B lymphocyte, where the generating is performed according to any method of generation a barcoded cDNA library as described herein, where the barcoded cDNA library decorates a capture object including a plurality of capture oligonucleotides, each capture oligonucleotide of the plurality including a NotI restriction site sequence; amplifying the barcoded cDNA library; selecting for barcoded BCR sequences from the barcoded cDNA library, thereby producing a library enriched for barcoded BCR sequences; circularizing sequences from the library enriched for barcoded BCR sequences, thereby producing a library of circularized barcoded BCR sequences; relinearizing the library of circularized barcoded BCR sequences to provide a library of rearranged barcoded BCR sequences, each presenting a constant (C) region of the BCR sequence 3' to a respective variable (V) sub-region and/or a respective diversity (D) sub-region; and, adding a sequencing adaptor and sub-selecting for the V sub-region and/or the D sub-region, thereby producing a barcoded BCR sequencing library.

[00288] In various embodiments, the method may further include amplifying the BCR sequencing library to provide an amplified library of barcoded BCR sub-region sequences. In some embodiments, amplifying the barcoded cDNA library may be performed using a universal primer.

[00289] In some embodiments, selecting for a BCR sequence region may include performing a polymerase chain reaction (PCR) selective for BCR sequences, thereby producing the library of barcoded BCR region selective amplified DNA. In some embodiments, selecting for barcoded BCR sequences may further include adding at least one sequencing primer sequence and/or at least one index sequence. In various embodiments, circularizing sequences from the library enriched for barcoded BCR sequences may include ligating a 5' end of each barcoded BCR sequence to its respective 3' end. In various embodiments, relinearizing the library of

circularized barcoded BCR sequences may include digesting each of the library of circularized barcoded BCR sequences at the NotI restriction site.

[00290] In other embodiments, adding the sequencing adaptor and sub-selecting for V and/or D sub-regions may include performing PCR, thereby adding a sequencing adaptor and sub-selecting for the V and/or D sub-regions.

[00291] In some other embodiments, the capture object is any capture object as described herein.

[00292] In various embodiments, the method may further include: identifying a barcode sequence of the plurality of capture oligonucleotides of the capture object using any method of identifying a barcode in-situ as described herein. In some embodiments, identifying may be performed before amplifying the barcoded cDNA library. In other embodiments, identifying may be performed while generating the barcoded cDNA library.

[00293] In various embodiments, any of amplifying the barcoded cDNA library; performing the polymerase chain reaction (PCR) selective for barcoded BCR sequences; circularizing sequences; relinearizing the library of circularized barcoded BCR sequences at the NotI restriction site; and adding the sequencing adaptor and sub-selecting for V and/or D sub-regions may be performed within a sequestration pen located within an enclosure of a microfluidic device.

[00294] The methods for generating B cell Receptor (BCR) sequencing libraries may be better understood by turning to Figures 13A-B. Figures 13A-B are schematic representations of process of generating a BCR sequencing library as described here and in Example 7. Capture object 1330 includes a bead 1310 with only one capture oligonucleotide of the plurality of capture oligonucleotides shown for clarity. The capture oligonucleotide of capture object 1330 is linked to the bead 1310 via a linker 1315, which may be covalent or non-covalent. The linker 1315 is linked to the 5' end of the capture oligonucleotide where priming sequence 1 (1320) is located along the length of the capture oligonucleotide. The capture oligonucleotide also includes barcode 1325, which may be any in-situ detectable barcode as described herein; an optional UMI 1335; a sequencing adaptor sequence 1340; a NotI restriction site sequence and a capture sequence 1350, which in this example is a generic capture sequence for RNA, Poly T (which may have two additional nucleotides at the 3' end, VN). The NotI sequence 1345 is to the 5' of the capture sequence 1350 and is 3' to the barcode 1325, priming sequence 1320, sequencing adaptor 1340 and any UMI 1335. The capture oligonucleotide is configured to capture RNA 505, having RNA sequences of interest 1301 (other than PolyA sequence 1350') which is released upon lysis of the cell membrane of the source cell. The RNA is captured to the

capture object by hybridizing its Poly A sequence 1350' to the PolyT capture sequence 1350 of the capture object, thus forming modified capture object 1330'. Reverse transcription box 1365, in the presence of template switching oligonucleotide 1306, provides cDNA decorated capture objects, where the capture oligonucleotide now contains a region of reverse transcribed nucleic acid 1355. Amplification of the cDNA via PCR, using generic primers 1311, 1312 (See Table 6, SEQ ID NO. 113) directed to the priming sequence 1 (1320) and to the portion of the Template switching oligonucleotide 1307 incorporated into the cDNA, provides an amplified DNA library 1370. Selection PCR 1375 using primer 1302 (which has a sequence 1320 directed against priming sequence 1(1320) of DNA 1370; optional Pool Index 1305 and Sequencing priming sequence 2 (1304) and BCR selective primer 1303, which selects only for BCR sequences, and species dependent. BCR selective primer 1303 may be a mixture of primers, which can target heavy or light chain regions (1356). See Table 6, SEQ ID Nos. 114-150). The product selected DNA 1380 has the priming sequence, UMI, barcode sequences as listed above for the product of the amplification 1370, but the DNA fragment now contains BCR region 1357 only, where the 5'most region of the BCR region 1357 is the full-length constant (C) sub-region 1351 of the BCR, with the Join (J) region 1352 (if present in the species under study); Diversity (D) sub-region 1353, and finally, to the 3' end Variable (V) region 1354.

[00295] To make the BCR sub-regions of greater interest (V, D, J) more amenable to sequencing analysis, a rearrangement is performed. Selected DNA 1380 is circularized via ligation, to yield circularized DNA library 1385 in Figure 13B. Circularized DNA library 1385 is then digested at the NotI restriction site 1345 (black arrow) to yield a re-linearize DNA library 1390. The effect of the circularization and relinearization is to bring the BCR sub-regions of greater interest (V, D, J) to better proximity of sequencing priming sites so that higher quality reads can be achieved. In the relinearized DNA library 1390, the order of the BCR sub-region sequences 5' to 3' have been reversed, and Variable (V) region 1354 is now disposed towards the 5' end of all of the BCR sub-regions, followed in order in the 3' direction by Diversity (D) sub-region 1353; Join (J) region 1352 (if present in the species under study); and finally, full length constant (C) sub-region 1351 of the BCR at the 3' most section of the BCR region sequence 1357.

[00296] Sub-selection PCR 1394 is performed next, where a primer 1308, including primer sequence 1360 and selection region 1351'', is directed towards a sequence 1351' of the constant (C) sub-region. The sequence 135' is selected to be close to the 5' end of the C sub-region) to excise much of the C sub-region. This yields sub-selected DNA library 1395, which has had priming sequence 1360 added as well. The sub-selected BCR region now permits higher quality

reads and length of read into the V, D, and J regions by placing it in better juxtaposition with sequencing priming sites and by 1) removing the polyT sequence 1350 entirely and 2) removing a substantial region of BCR C sub-region. Sequencing 1396 is performed upon the sub-selected DNA library 1395, and yields a first read of barcode 1325 and optional UMI 1335. Sequencing
5 1392 reads the optional pool index. Sequencing 1393 and 1397 reads the sub-selected BCR 1357'.

[00297] Any of the methods for generating a sequencing library may also be performed by introducing two or more capture objects to the sequestration pen. Each of the two or more capture objects may two or more capture oligonucleotides having a cell-associated barcode
10 including one or more cassetable sub-units as described above, as well as a priming sequence. In some embodiments, each of the two or more capture objects may have the same barcode. In some other embodiments, when two or capture objects are introduced to the same pen, each capture object may have a different cell-associated barcode. In other embodiments, each of the two or more capture objects may have the same cell-associated barcode. Using more than one
15 capture object may permit more nucleic acid capture capacity. The methods of in-situ identification described herein may easily be extended to identify two or more capture objects within one sequestration pen.

[00298] **Microfluidic devices and systems for operating and observing such devices.**

Figure 1A illustrates an example of a microfluidic device 100 and a system 150 which can be
20 used for maintaining, isolating, assaying or culturing biological micro-objects. A perspective view of the microfluidic device 100 is shown having a partial cut-away of its cover 110 to provide a partial view into the microfluidic device 100. The microfluidic device 100 generally comprises a microfluidic circuit 120 comprising a flow path 106 through which a fluidic medium 180 can flow, optionally carrying one or more micro-objects (not shown) into and/or
25 through the microfluidic circuit 120. Although a single microfluidic circuit 120 is illustrated in Figure 1A, suitable microfluidic devices can include a plurality (e.g., 2 or 3) of such microfluidic circuits. Regardless, the microfluidic device 100 can be configured to be a nanofluidic device. As illustrated in Figure 1A, the microfluidic circuit 120 may include a plurality of microfluidic sequestration pens 124, 126, 128, and 130, where each sequestration
30 pens may have one or more openings in fluidic communication with flow path 106. In some embodiments of the device of Figure 1A, the sequestration pens may have only a single opening in fluidic communication with the flow path 106. As discussed further below, the microfluidic sequestration pens comprise various features and structures that have been optimized for retaining micro-objects in the microfluidic device, such as microfluidic device 100, even when a

medium 180 is flowing through the flow path 106. Before turning to the foregoing, however, a brief description of microfluidic device 100 and system 150 is provided.

[00299] As generally illustrated in Figure 1A, the microfluidic circuit 120 is defined by an enclosure 102. Although the enclosure 102 can be physically structured in different configurations, in the example shown in Figure 1A the enclosure 102 is depicted as comprising a support structure 104 (e.g., a base), a microfluidic circuit structure 108, and a cover 110. The support structure 104, microfluidic circuit structure 108, and cover 110 can be attached to each other. For example, the microfluidic circuit structure 108 can be disposed on an inner surface 109 of the support structure 104, and the cover 110 can be disposed over the microfluidic circuit structure 108. Together with the support structure 104 and cover 110, the microfluidic circuit structure 108 can define the elements of the microfluidic circuit 120.

[00300] The support structure 104 can be at the bottom and the cover 110 at the top of the microfluidic circuit 120 as illustrated in Figure 1A. Alternatively, the support structure 104 and the cover 110 can be configured in other orientations. For example, the support structure 104 can be at the top and the cover 110 at the bottom of the microfluidic circuit 120. Regardless, there can be one or more ports 107 each comprising a passage into or out of the enclosure 102. Examples of a passage include a valve, a gate, a pass-through hole, or the like. As illustrated, port 107 is a pass-through hole created by a gap in the microfluidic circuit structure 108. However, the port 107 can be situated in other components of the enclosure 102, such as the cover 110. Only one port 107 is illustrated in Figure 1A but the microfluidic circuit 120 can have two or more ports 107. For example, there can be a first port 107 that functions as an inlet for fluid entering the microfluidic circuit 120, and there can be a second port 107 that functions as an outlet for fluid exiting the microfluidic circuit 120. Whether a port 107 function as an inlet or an outlet can depend upon the direction that fluid flows through flow path 106.

[00301] The support structure 104 can comprise one or more electrodes (not shown) and a substrate or a plurality of interconnected substrates. For example, the support structure 104 can comprise one or more semiconductor substrates, each of which is electrically connected to an electrode (e.g., all or a subset of the semiconductor substrates can be electrically connected to a single electrode). The support structure 104 can further comprise a printed circuit board assembly (“PCBA”). For example, the semiconductor substrate(s) can be mounted on a PCBA.

[00302] The microfluidic circuit structure 108 can define circuit elements of the microfluidic circuit 120. Such circuit elements can comprise spaces or regions that can be fluidly interconnected when microfluidic circuit 120 is filled with fluid, such as flow regions (which may include or be one or more flow channels), chambers, pens, traps, and the like. In the microfluidic

circuit 120 illustrated in Figure 1A, the microfluidic circuit structure 108 comprises a frame 114 and a microfluidic circuit material 116. The frame 114 can partially or completely enclose the microfluidic circuit material 116. The frame 114 can be, for example, a relatively rigid structure substantially surrounding the microfluidic circuit material 116. For example, the frame 114 can
5 comprise a metal material.

[00303] The microfluidic circuit material 116 can be patterned with cavities or the like to define circuit elements and interconnections of the microfluidic circuit 120. The microfluidic circuit material 116 can comprise a flexible material, such as a flexible polymer (e.g. rubber, plastic, elastomer, silicone, polydimethylsiloxane (“PDMS”), or the like), which can be gas permeable.
10 Other examples of materials that can compose microfluidic circuit material 116 include molded glass, an etchable material such as silicone (e.g. photo-patternable silicone or “PPS”), photo-resist (e.g., SU8), or the like. In some embodiments, such materials—and thus the microfluidic circuit material 116—can be rigid and/or substantially impermeable to gas. Regardless, microfluidic circuit material 116 can be disposed on the support structure 104 and inside the frame 114.

[00304] The cover 110 can be an integral part of the frame 114 and/or the microfluidic circuit material 116. Alternatively, the cover 110 can be a structurally distinct element, as illustrated in Figure 1A. The cover 110 can comprise the same or different materials than the frame 114 and/or the microfluidic circuit material 116. Similarly, the support structure 104 can be a separate structure from the frame 114 or microfluidic circuit material 116 as illustrated, or an integral part
20 of the frame 114 or microfluidic circuit material 116. Likewise, the frame 114 and microfluidic circuit material 116 can be separate structures as shown in Figure 1A or integral portions of the same structure.

[00305] In some embodiments, the cover 110 can comprise a rigid material. The rigid material may be glass or a material with similar properties. In some embodiments, the cover 110 can
25 comprise a deformable material. The deformable material can be a polymer, such as PDMS. In some embodiments, the cover 110 can comprise both rigid and deformable materials. For example, one or more portions of cover 110 (e.g., one or more portions positioned over sequestration pens 124, 126, 128, 130) can comprise a deformable material that interfaces with rigid materials of the cover 110. In some embodiments, the cover 110 can further include one or
30 more electrodes. The one or more electrodes can comprise a conductive oxide, such as indium-tin-oxide (ITO), which may be coated on glass or a similarly insulating material. Alternatively, the one or more electrodes can be flexible electrodes, such as single-walled nanotubes, multi-walled nanotubes, nanowires, clusters of electrically conductive nanoparticles, or combinations thereof, embedded in a deformable material, such as a polymer (e.g., PDMS). Flexible electrodes

that can be used in microfluidic devices have been described, for example, in U.S. 2012/0325665 (Chiou et al.), the contents of which are incorporated herein by reference. In some embodiments, the cover 110 can be modified (e.g., by conditioning all or part of a surface that faces inward toward the microfluidic circuit 120) to support cell adhesion, viability and/or growth. The modification may include a coating of a synthetic or natural polymer. In some embodiments, the cover 110 and/or the support structure 104 can be transparent to light. The cover 110 may also include at least one material that is gas permeable (e.g., PDMS or PPS).

[00306] Figure 1A also shows a system 150 for operating and controlling microfluidic devices, such as microfluidic device 100. System 150 includes an electrical power source 192, an imaging device, and a tilting device 190 (part of tilting module 166).

[00307] The electrical power source 192 can provide electric power to the microfluidic device 100 and/or tilting device 190, providing biasing voltages or currents as needed. The electrical power source 192 can, for example, comprise one or more alternating current (AC) and/or direct current (DC) voltage or current sources. The imaging device (part of imaging module 164, discussed below) can comprise a device, such as a digital camera, for capturing images inside microfluidic circuit 120. In some instances, the imaging device further comprises a detector having a fast frame rate and/or high sensitivity (e.g. for low light applications). The imaging device can also include a mechanism for directing stimulating radiation and/or light beams into the microfluidic circuit 120 and collecting radiation and/or light beams reflected or emitted from the microfluidic circuit 120 (or micro-objects contained therein). The emitted light beams may be in the visible spectrum and may, e.g., include fluorescent emissions. The reflected light beams may include reflected emissions originating from an LED or a wide spectrum lamp, such as a mercury lamp (e.g. a high pressure mercury lamp) or a Xenon arc lamp. As discussed with respect to Figure 3B, the imaging device may further include a microscope (or an optical train), which may or may not include an eyepiece.

[00308] System 150 further comprises a tilting device 190 (part of tilting module 166, discussed below) configured to rotate a microfluidic device 100 about one or more axes of rotation. In some embodiments, the tilting device 190 is configured to support and/or hold the enclosure 102 comprising the microfluidic circuit 120 about at least one axis such that the microfluidic device 100 (and thus the microfluidic circuit 120) can be held in a level orientation (i.e. at 0° relative to x- and y-axes), a vertical orientation (i.e. at 90° relative to the x-axis and/or the y-axis), or any orientation therebetween. The orientation of the microfluidic device 100 (and the microfluidic circuit 120) relative to an axis is referred to herein as the “tilt” of the microfluidic device 100 (and the microfluidic circuit 120). For example, the tilting device 190 can tilt the microfluidic device

100 at 0.1°, 0.2°, 0.3°, 0.4°, 0.5°, 0.6°, 0.7°, 0.8°, 0.9°, 1°, 2°, 3°, 4°, 5°, 10°, 15°, 20°, 25°, 30°, 35°, 40°, 45°, 50°, 55°, 60°, 65°, 70°, 75°, 80°, 90° relative to the x-axis or any degree therebetween. The level orientation (and thus the x- and y-axes) is defined as normal to a vertical axis defined by the force of gravity. The tilting device can also tilt the microfluidic device 100
5 (and the microfluidic circuit 120) to any degree greater than 90° relative to the x-axis and/or y-axis, or tilt the microfluidic device 100 (and the microfluidic circuit 120) 180° relative to the x-axis or the y-axis in order to fully invert the microfluidic device 100 (and the microfluidic circuit 120). Similarly, in some embodiments, the tilting device 190 tilts the microfluidic device 100 (and the microfluidic circuit 120) about an axis of rotation defined by flow path 106 or some other
10 portion of microfluidic circuit 120.

[00309] In some instances, the microfluidic device 100 is tilted into a vertical orientation such that the flow path 106 is positioned above or below one or more sequestration pens. The term “above” as used herein denotes that the flow path 106 is positioned higher than the one or more sequestration pens on a vertical axis defined by the force of gravity (i.e. an object in a sequestration
15 pen above a flow path 106 would have a higher gravitational potential energy than an object in the flow path). The term “below” as used herein denotes that the flow path 106 is positioned lower than the one or more sequestration pens on a vertical axis defined by the force of gravity (i.e. an object in a sequestration pen below a flow path 106 would have a lower gravitational potential energy than an object in the flow path).

[00310] In some instances, the tilting device 190 tilts the microfluidic device 100 about an axis that is parallel to the flow path 106. Moreover, the microfluidic device 100 can be tilted to an angle of less than 90° such that the flow path 106 is located above or below one or more sequestration pens without being located directly above or below the sequestration pens. In other instances, the tilting device 190 tilts the microfluidic device 100 about an axis perpendicular to
25 the flow path 106. In still other instances, the tilting device 190 tilts the microfluidic device 100 about an axis that is neither parallel nor perpendicular to the flow path 106.

[00311] System 150 can further include a media source 178. The media source 178 (e.g., a container, reservoir, or the like) can comprise multiple sections or containers, each for holding a different fluidic medium 180. Thus, the media source 178 can be a device that is outside of and
30 separate from the microfluidic device 100, as illustrated in Figure 1A. Alternatively, the media source 178 can be located in whole or in part inside the enclosure 102 of the microfluidic device 100. For example, the media source 178 can comprise reservoirs that are part of the microfluidic device 100.

[00312] Figure 1A also illustrates simplified block diagram depictions of examples of control and monitoring equipment 152 that constitute part of system 150 and can be utilized in conjunction with a microfluidic device 100. As shown, examples of such control and monitoring equipment 152 include a master controller 154 comprising a media module 160 for controlling the media source 178, a motive module 162 for controlling movement and/or selection of micro-objects (not shown) and/or medium (e.g., droplets of medium) in the microfluidic circuit 120, an imaging module 164 for controlling an imaging device (e.g., a camera, microscope, light source or any combination thereof) for capturing images (e.g., digital images), and a tilting module 166 for controlling a tilting device 190. The control equipment 152 can also include other modules 168 for controlling, monitoring, or performing other functions with respect to the microfluidic device 100. As shown, the equipment 152 can further include a display device 170 and an input/output device 172.

[00313] The master controller 154 can comprise a control module 156 and a digital memory 158. The control module 156 can comprise, for example, a digital processor configured to operate in accordance with machine executable instructions (e.g., software, firmware, source code, or the like) stored as non-transitory data or signals in the memory 158. Alternatively, or in addition, the control module 156 can comprise hardwired digital circuitry and/or analog circuitry. The media module 160, motive module 162, imaging module 164, tilting module 166, and/or other modules 168 can be similarly configured. Thus, functions, processes acts, actions, or steps of a process discussed herein as being performed with respect to the microfluidic device 100 or any other microfluidic apparatus can be performed by any one or more of the master controller 154, media module 160, motive module 162, imaging module 164, tilting module 166, and/or other modules 168 configured as discussed above. Similarly, the master controller 154, media module 160, motive module 162, imaging module 164, tilting module 166, and/or other modules 168 may be communicatively coupled to transmit and receive data used in any function, process, act, action or step discussed herein.

[00314] The media module 160 controls the media source 178. For example, the media module 160 can control the media source 178 to input a selected fluidic medium 180 into the enclosure 102 (e.g., through an inlet port 107). The media module 160 can also control removal of media from the enclosure 102 (e.g., through an outlet port (not shown)). One or more media can thus be selectively input into and removed from the microfluidic circuit 120. The media module 160 can also control the flow of fluidic medium 180 in the flow path 106 inside the microfluidic circuit 120. For example, in some embodiments media module 160 stops the flow of media 180 in the

flow path 106 and through the enclosure 102 prior to the tilting module 166 causing the tilting device 190 to tilt the microfluidic device 100 to a desired angle of incline.

[00315] The motive module 162 can be configured to control selection, trapping, and movement of micro-objects (not shown) in the microfluidic circuit 120. As discussed below with respect to
5 Figures 1B and 1C, the enclosure 102 can comprise a dielectrophoresis (DEP), optoelectronic tweezers (OET) and/or opto-electrowetting (OEW) configuration (not shown in Figure 1A), and the motive module 162 can control the activation of electrodes and/or transistors (e.g., phototransistors) to select and move micro-objects (not shown) and/or droplets of medium (not shown) in the flow path 106 and/or sequestration pens 124, 126, 128, 130.

10 [00316] The imaging module 164 can control the imaging device. For example, the imaging module 164 can receive and process image data from the imaging device. Image data from the imaging device can comprise any type of information captured by the imaging device (e.g., the presence or absence of micro-objects, droplets of medium, accumulation of detectable label, such as fluorescent label, etc.). Using the information captured by the imaging device, the imaging
15 module 164 can further calculate the position of objects (e.g., micro-objects, droplets of medium) and/or the rate of motion of such objects within the microfluidic device 100.

[00317] The tilting module 166 can control the tilting motions of tilting device 190. Alternatively, or in addition, the tilting module 166 can control the tilting rate and timing to optimize transfer of micro-objects to the one or more sequestration pens via gravitational forces.
20 The tilting module 166 is communicatively coupled with the imaging module 164 to receive data describing the motion of micro-objects and/or droplets of medium in the microfluidic circuit 120. Using this data, the tilting module 166 may adjust the tilt of the microfluidic circuit 120 in order to adjust the rate at which micro-objects and/or droplets of medium move in the microfluidic circuit 120. The tilting module 166 may also use this data to iteratively adjust the position of a
25 micro-object and/or droplet of medium in the microfluidic circuit 120.

[00318] In the example shown in Figure 1A, the microfluidic circuit 120 is illustrated as comprising a microfluidic channel 122 and sequestration pens 124, 126, 128, 130. Each pen comprises an opening to channel 122, but otherwise is enclosed such that the pens can substantially isolate micro-objects inside the pen from fluidic medium 180 and/or micro-objects
30 in the flow path 106 of channel 122 or in other pens. The walls of the sequestration pen extend from the inner surface 109 of the base to the inside surface of the cover 110 to provide enclosure. The opening of the pen to the microfluidic channel 122 is oriented at an angle to the flow 106 of fluidic medium 180 such that flow 106 is not directed into the pens. The flow may be tangential or orthogonal to the plane of the opening of the pen. In some instances, pens 124, 126, 128, 130

are configured to physically corral one or more micro-objects within the microfluidic circuit 120. Sequestration pens in accordance with the present disclosure can comprise various shapes, surfaces and features that are optimized for use with DEP, OET, OEW, fluid flow, and/or gravitational forces, as will be discussed and shown in detail below.

5 [00319] The microfluidic circuit 120 may comprise any number of microfluidic sequestration pens. Although five sequestration pens are shown, microfluidic circuit 120 may have fewer or more sequestration pens. As shown, microfluidic sequestration pens 124, 126, 128, and 130 of microfluidic circuit 120 each comprise differing features and shapes which may provide one or more benefits useful for maintaining, isolating, assaying or culturing biological micro-objects. In
10 some embodiments, the microfluidic circuit 120 comprises a plurality of identical microfluidic sequestration pens.

[00320] In the embodiment illustrated in Figure 1A, a single channel 122 and flow path 106 is shown. However, other embodiments may contain multiple channels 122, each configured to comprise a flow path 106. The microfluidic circuit 120 further comprises an inlet valve or port
15 107 in fluid communication with the flow path 106 and fluidic medium 180, whereby fluidic medium 180 can access channel 122 via the inlet port 107. In some instances, the flow path 106 comprises a single path. In some instances, the single path is arranged in a zigzag pattern whereby the flow path 106 travels across the microfluidic device 100 two or more times in alternating directions.

20 [00321] In some instances, microfluidic circuit 120 comprises a plurality of parallel channels 122 and flow paths 106, wherein the fluidic medium 180 within each flow path 106 flows in the same direction. In some instances, the fluidic medium within each flow path 106 flows in at least one of a forward or reverse direction. In some instances, a plurality of sequestration pens is configured (e.g., relative to a channel 122) such that the sequestration pens can be loaded with
25 target micro-objects in parallel.

[00322] In some embodiments, microfluidic circuit 120 further comprises one or more micro-object traps 132. The traps 132 are generally formed in a wall forming the boundary of a channel 122, and may be positioned opposite an opening of one or more of the microfluidic sequestration pens 124, 126, 128, 130. In some embodiments, the traps 132 are configured to receive or capture
30 a single micro-object from the flow path 106. In some embodiments, the traps 132 are configured to receive or capture a plurality of micro-objects from the flow path 106. In some instances, the traps 132 comprise a volume approximately equal to the volume of a single target micro-object.

[00323] The traps 132 may further comprise an opening which is configured to assist the flow of targeted micro-objects into the traps 132. In some instances, the traps 132 comprise an opening

having a height and width that is approximately equal to the dimensions of a single target micro-object, whereby larger micro-objects are prevented from entering into the micro-object trap. The traps 132 may further comprise other features configured to assist in retention of targeted micro-objects within the trap 132. In some instances, the trap 132 is aligned with and situated on the opposite side of a channel 122 relative to the opening of a microfluidic sequestration pen, such that upon tilting the microfluidic device 100 about an axis parallel to the microfluidic channel 122, the trapped micro-object exits the trap 132 at a trajectory that causes the micro-object to fall into the opening of the sequestration pen. In some instances, the trap 132 comprises a side passage 134 that is smaller than the target micro-object in order to facilitate flow through the trap 132 and thereby increase the likelihood of capturing a micro-object in the trap 132.

[00324] In some embodiments, dielectrophoretic (DEP) forces are applied across the fluidic medium 180 (e.g., in the flow path and/or in the sequestration pens) via one or more electrodes (not shown) to manipulate, transport, separate and sort micro-objects located therein. For example, in some embodiments, DEP forces are applied to one or more portions of microfluidic circuit 120 in order to transfer a single micro-object from the flow path 106 into a desired microfluidic sequestration pen. In some embodiments, DEP forces are used to prevent a micro-object within a sequestration pen (e.g., sequestration pen 124, 126, 128, or 130) from being displaced therefrom. Further, in some embodiments, DEP forces are used to selectively remove a micro-object from a sequestration pen that was previously collected in accordance with the embodiments of the current disclosure. In some embodiments, the DEP forces comprise optoelectronic tweezer (OET) forces.

[00325] In other embodiments, optoelectrowetting (OEW) forces are applied to one or more positions in the support structure 104 (and/or the cover 110) of the microfluidic device 100 (e.g., positions helping to define the flow path and/or the sequestration pens) via one or more electrodes (not shown) to manipulate, transport, separate and sort droplets located in the microfluidic circuit 120. For example, in some embodiments, OEW forces are applied to one or more positions in the support structure 104 (and/or the cover 110) in order to transfer a single droplet from the flow path 106 into a desired microfluidic sequestration pen. In some embodiments, OEW forces are used to prevent a droplet within a sequestration pen (e.g., sequestration pen 124, 126, 128, or 130) from being displaced therefrom. Further, in some embodiments, OEW forces are used to selectively remove a droplet from a sequestration pen that was previously collected in accordance with the embodiments of the current disclosure.

[00326] In some embodiments, DEP and/or OEW forces are combined with other forces, such as flow and/or gravitational force, so as to manipulate, transport, separate and sort micro-objects

and/or droplets within the microfluidic circuit 120. For example, the enclosure 102 can be tilted (e.g., by tilting device 190) to position the flow path 106 and micro-objects located therein above the microfluidic sequestration pens, and the force of gravity can transport the micro-objects and/or droplets into the pens. In some embodiments, the DEP and/or OEW forces can be applied prior to the other forces. In other embodiments, the DEP and/or OEW forces can be applied after the other forces. In still other instances, the DEP and/or OEW forces can be applied at the same time as the other forces or in an alternating manner with the other forces.

[00327] Figures 1B, 1C, and 2A-2H illustrates various embodiments of microfluidic devices that can be used in the practice of the embodiments of the present disclosure. Figure 1B depicts an embodiment in which the microfluidic device 200 is configured as an optically-actuated electrokinetic device. A variety of optically-actuated electrokinetic devices are known in the art, including devices having an optoelectronic tweezer (OET) configuration and devices having an opto-electrowetting (OEW) configuration. Examples of suitable OET configurations are illustrated in the following U.S. patent documents, each of which is incorporated herein by reference in its entirety: U.S. Patent No. RE 44,711 (Wu et al.) (originally issued as U.S. Patent No. 7,612,355); and U.S. Patent No. 7,956,339 (Ohta et al.). Examples of OEW configurations are illustrated in U.S. Patent No. 6,958,132 (Chiou et al.) and U.S. Patent Application Publication No. 2012/0024708 (Chiou et al.), both of which are incorporated by reference herein in their entirety. Yet another example of an optically-actuated electrokinetic device includes a combined OET/OEW configuration, examples of which are shown in U.S. Patent Publication Nos. 20150306598 (Khandros et al.) and 20150306599 (Khandros et al.) and their corresponding PCT Publications WO2015/164846 and WO2015/164847, all of which are incorporated herein by reference in their entirety.

[00328] Examples of microfluidic devices having pens in which biological micro-objects can be placed, cultured, and/or monitored have been described, for example, in US 2014/0116881 (application no. 14/060,117, filed October 22, 2013), US 2015/0151298 (application no. 14/520,568, filed October 22, 2014), and US 2015/0165436 (application no. 14/521,447, filed October 22, 2014), each of which is incorporated herein by reference in its entirety. US application nos. 14/520,568 and 14/521,447 also describe exemplary methods of analyzing secretions of cells cultured in a microfluidic device. Each of the foregoing applications further describes microfluidic devices configured to produce dielectrophoretic (DEP) forces, such as optoelectronic tweezers (OET) or configured to provide opto-electro wetting (OEW). For example, the optoelectronic tweezers device illustrated in Figure 2 of US 2014/0116881 is an

example of a device that can be utilized in embodiments of the present disclosure to select and move an individual biological micro-object or a group of biological micro-objects.

[00329] **Microfluidic device motive configurations.** As described above, the control and monitoring equipment of the system can comprise a motive module for selecting and moving
5 objects, such as micro-objects or droplets, in the microfluidic circuit of a microfluidic device. The microfluidic device can have a variety of motive configurations, depending upon the type of object being moved and other considerations. For example, a dielectrophoresis (DEP) configuration can be utilized to select and move micro-objects in the microfluidic circuit. Thus, the support structure
10 104 and/or cover 110 of the microfluidic device 100 can comprise a DEP configuration for selectively inducing DEP forces on micro-objects in a fluidic medium 180 in the microfluidic circuit 120 and thereby select, capture, and/or move individual micro-objects or groups of micro-objects. Alternatively, the support structure 104 and/or cover 110 of the microfluidic device 100 can comprise an electrowetting (EW) configuration for selectively inducing EW forces on droplets
15 in a fluidic medium 180 in the microfluidic circuit 120 and thereby select, capture, and/or move individual droplets or groups of droplets.

[00330] One example of a microfluidic device 200 comprising a DEP configuration is illustrated in Figures 1B and 1C. While for purposes of simplicity Figures 1B and 1C show a side cross-sectional view and a top cross-sectional view, respectively, of a portion of an enclosure 102 of the microfluidic device 200 having a region/chamber 202, it should be understood that the
20 region/chamber 202 may be part of a fluidic circuit element having a more detailed structure, such as a growth chamber, a sequestration pen, a flow region, or a flow channel. Furthermore, the microfluidic device 200 may include other fluidic circuit elements. For example, the microfluidic device 200 can include a plurality of growth chambers or sequestration pens and/or one or more flow regions or flow channels, such as those described herein with respect to microfluidic device
25 100. A DEP configuration may be incorporated into any such fluidic circuit elements of the microfluidic device 200, or select portions thereof. It should be further appreciated that any of the above or below described microfluidic device components and system components may be incorporated in and/or used in combination with the microfluidic device 200. For example, system
30 150 including control and monitoring equipment 152, described above, may be used with microfluidic device 200, including one or more of the media module 160, motive module 162, imaging module 164, tilting module 166, and other modules 168.

[00331] As seen in Figure 1B, the microfluidic device 200 includes a support structure 104 having a bottom electrode 204 and an electrode activation substrate 206 overlying the bottom electrode 204, and a cover 110 having a top electrode 210, with the top electrode 210 spaced apart

from the bottom electrode 204. The top electrode 210 and the electrode activation substrate 206 define opposing surfaces of the region/chamber 202. A medium 180 contained in the region/chamber 202 thus provides a resistive connection between the top electrode 210 and the electrode activation substrate 206. A power source 212 configured to be connected to the bottom electrode 204 and the top electrode 210 and create a biasing voltage between the electrodes, as required for the generation of DEP forces in the region/chamber 202, is also shown. The power source 212 can be, for example, an alternating current (AC) power source.

[00332] In certain embodiments, the microfluidic device 200 illustrated in Figures 1B and 1C can have an optically-actuated DEP configuration. Accordingly, changing patterns of light 218 from the light source 216, which may be controlled by the motive module 162, can selectively activate and deactivate changing patterns of DEP electrodes at regions 214 of the inner surface 208 of the electrode activation substrate 206. (Hereinafter the regions 214 of a microfluidic device having a DEP configuration are referred to as “DEP electrode regions.”) As illustrated in Figure 1C, a light pattern 218 directed onto the inner surface 208 of the electrode activation substrate 206 can illuminate select DEP electrode regions 214a (shown in white) in a pattern, such as a square. The non-illuminated DEP electrode regions 214 (cross-hatched) are hereinafter referred to as “dark” DEP electrode regions 214. The relative electrical impedance through the DEP electrode activation substrate 206 (i.e., from the bottom electrode 204 up to the inner surface 208 of the electrode activation substrate 206 which interfaces with the medium 180 in the flow region 106) is greater than the relative electrical impedance through the medium 180 in the region/chamber 202 (i.e., from the inner surface 208 of the electrode activation substrate 206 to the top electrode 210 of the cover 110) at each dark DEP electrode region 214. An illuminated DEP electrode region 214a, however, exhibits a reduced relative impedance through the electrode activation substrate 206 that is less than the relative impedance through the medium 180 in the region/chamber 202 at each illuminated DEP electrode region 214a.

[00333] With the power source 212 activated, the foregoing DEP configuration creates an electric field gradient in the fluidic medium 180 between illuminated DEP electrode regions 214a and adjacent dark DEP electrode regions 214, which in turn creates local DEP forces that attract or repel nearby micro-objects (not shown) in the fluidic medium 180. DEP electrodes that attract or repel micro-objects in the fluidic medium 180 can thus be selectively activated and deactivated at many different such DEP electrode regions 214 at the inner surface 208 of the region/chamber 202 by changing light patterns 218 projected from a light source 216 into the microfluidic device 200. Whether the DEP forces attract or repel nearby micro-objects can depend on such parameters

as the frequency of the power source 212 and the dielectric properties of the medium 180 and/or micro-objects (not shown).

[00334] The square pattern 220 of illuminated DEP electrode regions 214a illustrated in Figure 1C is an example only. Any pattern of the DEP electrode regions 214 can be illuminated (and thereby activated) by the pattern of light 218 projected into the microfluidic device 200, and the pattern of illuminated/activated DEP electrode regions 214 can be repeatedly changed by changing or moving the light pattern 218.

[00335] In some embodiments, the electrode activation substrate 206 can comprise or consist of a photoconductive material. In such embodiments, the inner surface 208 of the electrode activation substrate 206 can be featureless. For example, the electrode activation substrate 206 can comprise or consist of a layer of hydrogenated amorphous silicon (a-Si:H). The a-Si:H can comprise, for example, about 8% to 40% hydrogen (calculated as $100 * \frac{\text{number of hydrogen atoms}}{\text{total number of hydrogen and silicon atoms}}$). The layer of a-Si:H can have a thickness of about 500 nm to about 2.0 μm . In such embodiments, the DEP electrode regions 214 can be created anywhere and in any pattern on the inner surface 208 of the electrode activation substrate 206, in accordance with the light pattern 218. The number and pattern of the DEP electrode regions 214 thus need not be fixed, but can correspond to the light pattern 218. Examples of microfluidic devices having a DEP configuration comprising a photoconductive layer such as discussed above have been described, for example, in U.S. Patent No. RE 44,711 (Wu et al.) (originally issued as U.S. Patent No. 7,612,355), the entire contents of which are incorporated herein by reference.

[00336] In other embodiments, the electrode activation substrate 206 can comprise a substrate comprising a plurality of doped layers, electrically insulating layers (or regions), and electrically conductive layers that form semiconductor integrated circuits, such as is known in semiconductor fields. For example, the electrode activation substrate 206 can comprise a plurality of phototransistors, including, for example, lateral bipolar phototransistors, each phototransistor corresponding to a DEP electrode region 214. Alternatively, the electrode activation substrate 206 can comprise electrodes (e.g., conductive metal electrodes) controlled by phototransistor switches, with each such electrode corresponding to a DEP electrode region 214. The electrode activation substrate 206 can include a pattern of such phototransistors or phototransistor-controlled electrodes. The pattern, for example, can be an array of substantially square phototransistors or phototransistor-controlled electrodes arranged in rows and columns, such as shown in Fig. 2B. Alternatively, the pattern can be an array of substantially hexagonal phototransistors or phototransistor-controlled electrodes that form a hexagonal lattice. Regardless

of the pattern, electric circuit elements can form electrical connections between the DEP electrode regions 214 at the inner surface 208 of the electrode activation substrate 206 and the bottom electrode 210, and those electrical connections (i.e., phototransistors or electrodes) can be selectively activated and deactivated by the light pattern 218. When not activated, each electrical connection can have high impedance such that the relative impedance through the electrode activation substrate 206 (i.e., from the bottom electrode 204 to the inner surface 208 of the electrode activation substrate 206 which interfaces with the medium 180 in the region/chamber 202) is greater than the relative impedance through the medium 180 (i.e., from the inner surface 208 of the electrode activation substrate 206 to the top electrode 210 of the cover 110) at the corresponding DEP electrode region 214. When activated by light in the light pattern 218, however, the relative impedance through the electrode activation substrate 206 is less than the relative impedance through the medium 180 at each illuminated DEP electrode region 214, thereby activating the DEP electrode at the corresponding DEP electrode region 214 as discussed above. DEP electrodes that attract or repel micro-objects (not shown) in the medium 180 can thus be selectively activated and deactivated at many different DEP electrode regions 214 at the inner surface 208 of the electrode activation substrate 206 in the region/chamber 202 in a manner determined by the light pattern 218.

[00337] Examples of microfluidic devices having electrode activation substrates that comprise phototransistors have been described, for example, in U.S. Patent No. 7,956,339 (Ohta et al.) (see, e.g., device 300 illustrated in Figures 21 and 22, and descriptions thereof), the entire contents of which are incorporated herein by reference. Examples of microfluidic devices having electrode activation substrates that comprise electrodes controlled by phototransistor switches have been described, for example, in U.S. Patent Publication No. 2014/0124370 (Short et al.) (see, e.g., devices 200, 400, 500, 600, and 900 illustrated throughout the drawings, and descriptions thereof), the entire contents of which are incorporated herein by reference.

[00338] In some embodiments of a DEP configured microfluidic device, the top electrode 210 is part of a first wall (or cover 110) of the enclosure 102, and the electrode activation substrate 206 and bottom electrode 204 are part of a second wall (or support structure 104) of the enclosure 102. The region/chamber 202 can be between the first wall and the second wall. In other embodiments, the electrode 210 is part of the second wall (or support structure 104) and one or both of the electrode activation substrate 206 and/or the electrode 210 are part of the first wall (or cover 110). Moreover, the light source 216 can alternatively be used to illuminate the enclosure 102 from below.

[00339] With the microfluidic device 200 of Figures 1B-1C having a DEP configuration, the motive module 162 can select a micro-object (not shown) in the medium 180 in the region/chamber 202 by projecting a light pattern 218 into the microfluidic device 200 to activate a first set of one or more DEP electrodes at DEP electrode regions 214a of the inner surface 208 of the electrode activation substrate 206 in a pattern (e.g., square pattern 220) that surrounds and captures the micro-object. The motive module 162 can then move the in situ-generated captured micro-object by moving the light pattern 218 relative to the microfluidic device 200 to activate a second set of one or more DEP electrodes at DEP electrode regions 214. Alternatively, the microfluidic device 200 can be moved relative to the light pattern 218.

10 [00340] In other embodiments, the microfluidic device 200 can have a DEP configuration that does not rely upon light activation of DEP electrodes at the inner surface 208 of the electrode activation substrate 206. For example, the electrode activation substrate 206 can comprise selectively addressable and energizable electrodes positioned opposite to a surface including at least one electrode (e.g., cover 110). Switches (e.g., transistor switches in a semiconductor substrate) may be selectively opened and closed to activate or inactivate DEP electrodes at DEP electrode regions 214, thereby creating a net DEP force on a micro-object (not shown) in region/chamber 202 in the vicinity of the activated DEP electrodes. Depending on such characteristics as the frequency of the power source 212 and the dielectric properties of the medium (not shown) and/or micro-objects in the region/chamber 202, the DEP force can attract or repel a nearby micro-object. By selectively activating and deactivating a set of DEP electrodes (e.g., at a set of DEP electrodes regions 214 that forms a square pattern 220), one or more micro-objects in region/chamber 202 can be trapped and moved within the region/chamber 202. The motive module 162 in Figure 1A can control such switches and thus activate and deactivate individual ones of the DEP electrodes to select, trap, and move particular micro-objects (not shown) around the region/chamber 202. Microfluidic devices having a DEP configuration that includes selectively addressable and energizable electrodes are known in the art and have been described, for example, in U.S. Patent Nos. 6,294,063 (Becker et al.) and 6,942,776 (Medoro), the entire contents of which are incorporated herein by reference.

[00341] As yet another example, the microfluidic device 200 can have an electrowetting (EW) configuration, which can be in place of the DEP configuration or can be located in a portion of the microfluidic device 200 that is separate from the portion which has the DEP configuration. The EW configuration can be an opto-electrowetting configuration or an electrowetting on dielectric (EWOD) configuration, both of which are known in the art. In some EW configurations, the support structure 104 has an electrode activation substrate 206 sandwiched between a dielectric

layer (not shown) and the bottom electrode 204. The dielectric layer can comprise a hydrophobic material and/or can be coated with a hydrophobic material, as described below. For microfluidic devices 200 that have an EW configuration, the inner surface 208 of the support structure 104 is the inner surface of the dielectric layer or its hydrophobic coating.

5 [00342] The dielectric layer (not shown) can comprise one or more oxide layers, and can have a thickness of about 50 nm to about 250 nm (e.g., about 125 nm to about 175 nm). In certain embodiments, the dielectric layer may comprise a layer of oxide, such as a metal oxide (e.g., aluminum oxide or hafnium oxide). In certain embodiments, the dielectric layer can comprise a dielectric material other than a metal oxide, such as silicon oxide or a nitride. Regardless of the
10 exact composition and thickness, the dielectric layer can have an impedance of about 10 kOhms to about 50 kOhms.

[00343] In some embodiments, the surface of the dielectric layer that faces inward toward region/chamber 202 is coated with a hydrophobic material. The hydrophobic material can comprise, for example, fluorinated carbon molecules. Examples of fluorinated carbon molecules
15 include perfluoro-polymers such as polytetrafluoroethylene (e.g., TEFLON®) or poly(2,3-difluoromethylenyl-perfluorotetrahydrofuran) (e.g., CYTOP™). Molecules that make up the hydrophobic material can be covalently bonded to the surface of the dielectric layer. For example, molecules of the hydrophobic material can be covalently bound to the surface of the dielectric layer by means of a linker such as a siloxane group, a phosphonic acid group, or a thiol group.
20 Thus, in some embodiments, the hydrophobic material can comprise alkyl-terminated siloxane, alkyl-termination phosphonic acid, or alkyl-terminated thiol. The alkyl group can be long-chain hydrocarbons (e.g., having a chain of at least 10 carbons, or at least 16, 18, 20, 22, or more carbons). Alternatively, fluorinated (or perfluorinated) carbon chains can be used in place of the alkyl groups. Thus, for example, the hydrophobic material can comprise fluoroalkyl-terminated
25 siloxane, fluoroalkyl-terminated phosphonic acid, or fluoroalkyl-terminated thiol. In some embodiments, the hydrophobic coating has a thickness of about 10 nm to about 50 nm. In other embodiments, the hydrophobic coating has a thickness of less than 10 nm (e.g., less than 5 nm, or about 1.5 to 3.0 nm).

[00344] In some embodiments, the cover 110 of a microfluidic device 200 having an
30 electrowetting configuration is coated with a hydrophobic material (not shown) as well. The hydrophobic material can be the same hydrophobic material used to coat the dielectric layer of the support structure 104, and the hydrophobic coating can have a thickness that is substantially the same as the thickness of the hydrophobic coating on the dielectric layer of the support structure 104. Moreover, the cover 110 can comprise an electrode activation substrate 206 sandwiched

between a dielectric layer and the top electrode 210, in the manner of the support structure 104. The electrode activation substrate 206 and the dielectric layer of the cover 110 can have the same composition and/or dimensions as the electrode activation substrate 206 and the dielectric layer of the support structure 104. Thus, the microfluidic device 200 can have two electrowetting
5 surfaces.

[00345] In some embodiments, the electrode activation substrate 206 can comprise a photoconductive material, such as described above. Accordingly, in certain embodiments, the electrode activation substrate 206 can comprise or consist of a layer of hydrogenated amorphous silicon (a-Si:H). The a-Si:H can comprise, for example, about 8% to 40% hydrogen (calculated
10 as $100 * \frac{\text{the number of hydrogen atoms}}{\text{the total number of hydrogen and silicon atoms}}$). The layer of a-Si:H can have a thickness of about 500 nm to about 2.0 μm . Alternatively, the electrode activation substrate 206 can comprise electrodes (e.g., conductive metal electrodes) controlled by phototransistor switches, as described above. Microfluidic devices having an opto-electrowetting configuration are known in the art and/or can be constructed with electrode activation substrates
15 known in the art. For example, U.S. Patent No. 6,958,132 (Chiou et al.), the entire contents of which are incorporated herein by reference, discloses opto-electrowetting configurations having a photoconductive material such as a-Si:H, while U.S. Patent Publication No. 2014/0124370 (Short et al.), referenced above, discloses electrode activation substrates having electrodes controlled by phototransistor switches.

[00346] The microfluidic device 200 thus can have an opto-electrowetting configuration, and light patterns 218 can be used to activate photoconductive EW regions or photoresponsive EW electrodes in the electrode activation substrate 206. Such activated EW regions or EW electrodes of the electrode activation substrate 206 can generate an electrowetting force at the inner surface
20 208 of the support structure 104 (i.e., the inner surface of the overlaying dielectric layer or its hydrophobic coating). By changing the light patterns 218 (or moving microfluidic device 200 relative to the light source 216) incident on the electrode activation substrate 206, droplets (e.g., containing an aqueous medium, solution, or solvent) contacting the inner surface 208 of the support structure 104 can be moved through an immiscible fluid (e.g., an oil medium) present in the region/chamber 202.
25

[00347] In other embodiments, microfluidic devices 200 can have an EWOD configuration, and the electrode activation substrate 206 can comprise selectively addressable and energizable electrodes that do not rely upon light for activation. The electrode activation substrate 206 thus can include a pattern of such electrowetting (EW) electrodes. The pattern, for example, can be an array of substantially square EW electrodes arranged in rows and columns, such as shown in Fig.
30

2B. Alternatively, the pattern can be an array of substantially hexagonal EW electrodes that form a hexagonal lattice. Regardless of the pattern, the EW electrodes can be selectively activated (or deactivated) by electrical switches (e.g., transistor switches in a semiconductor substrate). By selectively activating and deactivating EW electrodes in the electrode activation substrate 206, droplets (not shown) contacting the inner surface 208 of the overlaying dielectric layer or its hydrophobic coating can be moved within the region/chamber 202. The motive module 162 in Figure 1A can control such switches and thus activate and deactivate individual EW electrodes to select and move particular droplets around region/chamber 202. Microfluidic devices having a EWOD configuration with selectively addressable and energizable electrodes are known in the art and have been described, for example, in U.S. Patent No. 8,685,344 (Sundarsan et al.), the entire contents of which are incorporated herein by reference.

[00348] Regardless of the configuration of the microfluidic device 200, a power source 212 can be used to provide a potential (e.g., an AC voltage potential) that powers the electrical circuits of the microfluidic device 200. The power source 212 can be the same as, or a component of, the power source 192 referenced in Fig. 1. Power source 212 can be configured to provide an AC voltage and/or current to the top electrode 210 and the bottom electrode 204. For an AC voltage, the power source 212 can provide a frequency range and an average or peak power (e.g., voltage or current) range sufficient to generate net DEP forces (or electrowetting forces) strong enough to trap and move individual micro-objects (not shown) in the region/chamber 202, as discussed above, and/or to change the wetting properties of the inner surface 208 of the support structure 104 (i.e., the dielectric layer and/or the hydrophobic coating on the dielectric layer) in the region/chamber 202, as also discussed above. Such frequency ranges and average or peak power ranges are known in the art. See, e.g., US Patent No. 6,958,132 (Chiou et al.), US Patent No. RE44,711 (Wu et al.) (originally issued as US Patent No. 7,612,355), and US Patent Application Publication Nos. US2014/0124370 (Short et al.), US2015/0306598 (Khandros et al.), and US2015/0306599 (Khandros et al.).

[00349] **Sequestration pens.** Non-limiting examples of generic sequestration pens 224, 226, and 228 are shown within the microfluidic device 230 depicted in Figures 2A-2C. Each sequestration pen 224, 226, and 228 can comprise an isolation structure 232 defining an isolation region 240 and a connection region 236 fluidically connecting the isolation region 240 to a channel 122. The connection region 236 can comprise a proximal opening 234 to the microfluidic channel 122 and a distal opening 238 to the isolation region 240. The connection region 236 can be configured so that the maximum penetration depth of a flow of a fluidic medium (not shown) flowing from the microfluidic channel 122 into the sequestration pen 224, 226, 228 does not

extend into the isolation region 240. Thus, due to the connection region 236, a micro-object (not shown) or other material (not shown) disposed in an isolation region 240 of a sequestration pen 224, 226, 228 can thus be isolated from, and not substantially affected by, a flow of medium 180 in the microfluidic channel 122.

5 [00350] The sequestration pens 224, 226, and 228 of Figures 2A-2C each have a single opening which opens directly to the microfluidic channel 122. The opening of the sequestration pen opens laterally from the microfluidic channel 122. The electrode activation substrate 206 underlays both the microfluidic channel 122 and the sequestration pens 224, 226, and 228. The upper surface of the electrode activation substrate 206 within the enclosure of a sequestration pen, forming the
10 floor of the sequestration pen, is disposed at the same level or substantially the same level of the upper surface the of electrode activation substrate 206 within the microfluidic channel 122 (or flow region if a channel is not present), forming the floor of the flow channel (or flow region, respectively) of the microfluidic device. The electrode activation substrate 206 may be featureless or may have an irregular or patterned surface that varies from its highest elevation to its lowest
15 depression by less than about 3 microns, 2.5 microns, 2 microns, 1.5 microns, 1 micron, 0.9 microns, 0.5 microns, 0.4 microns, 0.2 microns, 0.1 microns or less. The variation of elevation in the upper surface of the substrate across both the microfluidic channel 122 (or flow region) and sequestration pens may be less than about 3%, 2%, 1%, 0.9%, 0.8%, 0.5%, 0.3% or 0.1% of the height of the walls of the sequestration pen or walls of the microfluidic device. While described
20 in detail for the microfluidic device 200, this also applies to any of the microfluidic devices 100, 230, 250, 280, 290, 300, 700, 800, 1000 described herein.

[00351] The microfluidic channel 122 can thus be an example of a swept region, and the isolation regions 240 of the sequestration pens 224, 226, 228 can be examples of unswept regions. As noted, the microfluidic channel 122 and sequestration pens 224, 226, 228 can be configured to
25 contain one or more fluidic media 180. In the example shown in Figures 2A-2B, the ports 222 are connected to the microfluidic channel 122 and allow a fluidic medium 180 to be introduced into or removed from the microfluidic device 230. Prior to introduction of the fluidic medium 180, the microfluidic device may be primed with a gas such as carbon dioxide gas. Once the microfluidic device 230 contains the fluidic medium 180, the flow 242 of fluidic medium 180 in
30 the microfluidic channel 122 can be selectively generated and stopped. For example, as shown, the ports 222 can be disposed at different locations (e.g., opposite ends) of the microfluidic channel 122, and a flow 242 of medium can be created from one port 222 functioning as an inlet to another port 222 functioning as an outlet.

[00352] Figure 2C illustrates a detailed view of an example of a sequestration pen 224 according to the present disclosure. Examples of micro-objects 246 are also shown.

[00353] As is known, a flow 242 of fluidic medium 180 in a microfluidic channel 122 past a proximal opening 234 of sequestration pen 224 can cause a secondary flow 244 of the medium 180 into and/or out of the sequestration pen 224. To isolate micro-objects 246 in the isolation region 240 of a sequestration pen 224 from the secondary flow 244, the length L_{con} of the connection region 236 of the sequestration pen 224 (i.e., from the proximal opening 234 to the distal opening 238) should be greater than the penetration depth D_p of the secondary flow 244 into the connection region 236. The penetration depth D_p of the secondary flow 244 depends upon the velocity of the fluidic medium 180 flowing in the microfluidic channel 122 and various parameters relating to the configuration of the microfluidic channel 122 and the proximal opening 234 of the connection region 236 to the microfluidic channel 122. For a given microfluidic device, the configurations of the microfluidic channel 122 and the opening 234 will be fixed, whereas the rate of flow 242 of fluidic medium 180 in the microfluidic channel 122 will be variable. Accordingly, for each sequestration pen 224, a maximal velocity V_{max} for the flow 242 of fluidic medium 180 in channel 122 can be identified that ensures that the penetration depth D_p of the secondary flow 244 does not exceed the length L_{con} of the connection region 236. As long as the rate of the flow 242 of fluidic medium 180 in the microfluidic channel 122 does not exceed the maximum velocity V_{max} , the resulting secondary flow 244 can be limited to the microfluidic channel 122 and the connection region 236 and kept out of the isolation region 240. The flow 242 of medium 180 in the microfluidic channel 122 will thus not draw micro-objects 246 out of the isolation region 240. Rather, micro-objects 246 located in the isolation region 240 will stay in the isolation region 240 regardless of the flow 242 of fluidic medium 180 in the microfluidic channel 122.

[00354] Moreover, as long as the rate of flow 242 of medium 180 in the microfluidic channel 122 does not exceed V_{max} , the flow 242 of fluidic medium 180 in the microfluidic channel 122 will not move miscellaneous particles (e.g., microparticles and/or nanoparticles) from the microfluidic channel 122 into the isolation region 240 of a sequestration pen 224. Having the length L_{con} of the connection region 236 be greater than the maximum penetration depth D_p of the secondary flow 244 can thus prevent contamination of one sequestration pen 224 with miscellaneous particles from the microfluidic channel 122 or another sequestration pen (e.g., sequestration pens 226, 228 in Fig. 2D).

[00355] Because the microfluidic channel 122 and the connection regions 236 of the sequestration pens 224, 226, 228 can be affected by the flow 242 of medium 180 in the microfluidic channel 122, the microfluidic channel 122 and connection regions 236 can be deemed

swept (or flow) regions of the microfluidic device 230. The isolation regions 240 of the sequestration pens 224, 226, 228, on the other hand, can be deemed unswept (or non-flow) regions. For example, components (not shown) in a first fluidic medium 180 in the microfluidic channel 122 can mix with a second fluidic medium 248 in the isolation region 240 substantially only by diffusion of components of the first medium 180 from the microfluidic channel 122 through the connection region 236 and into the second fluidic medium 248 in the isolation region 240. Similarly, components (not shown) of the second medium 248 in the isolation region 240 can mix with the first medium 180 in the microfluidic channel 122 substantially only by diffusion of components of the second medium 248 from the isolation region 240 through the connection region 236 and into the first medium 180 in the microfluidic channel 122. In some embodiments, the extent of fluidic medium exchange between the isolation region of a sequestration pen and the flow region by diffusion is greater than about 90%, 91%, 92%, 93%, 94% 95%, 96%, 97%, 98%, or greater than about 99% of fluidic exchange. The first medium 180 can be the same medium or a different medium than the second medium 248. Moreover, the first medium 180 and the second medium 248 can start out being the same, then become different (e.g., through conditioning of the second medium 248 by one or more cells in the isolation region 240, or by changing the medium 180 flowing through the microfluidic channel 122).

[00356] The maximum penetration depth D_p of the secondary flow 244 caused by the flow 242 of fluidic medium 180 in the microfluidic channel 122 can depend on a number of parameters, as mentioned above. Examples of such parameters include: the shape of the microfluidic channel 122 (e.g., the microfluidic channel can direct medium into the connection region 236, divert medium away from the connection region 236, or direct medium in a direction substantially perpendicular to the proximal opening 234 of the connection region 236 to the microfluidic channel 122); a width W_{ch} (or cross-sectional area) of the microfluidic channel 122 at the proximal opening 234; and a width W_{con} (or cross-sectional area) of the connection region 236 at the proximal opening 234; the velocity V of the flow 242 of fluidic medium 180 in the microfluidic channel 122; the viscosity of the first medium 180 and/or the second medium 248, or the like.

[00357] In some embodiments, the dimensions of the microfluidic channel 122 and sequestration pens 224, 226, 228 can be oriented as follows with respect to the vector of the flow 242 of fluidic medium 180 in the microfluidic channel 122: the microfluidic channel width W_{ch} (or cross-sectional area of the microfluidic channel 122) can be substantially perpendicular to the flow 242 of medium 180; the width W_{con} (or cross-sectional area) of the connection region 236 at opening 234 can be substantially parallel to the flow 242 of medium 180 in the microfluidic channel 122; and/or the length L_{con} of the connection region can be substantially perpendicular to the flow 242

of medium 180 in the microfluidic channel 122. The foregoing are examples only, and the relative position of the microfluidic channel 122 and sequestration pens 224, 226, 228 can be in other orientations with respect to each other.

[00358] As illustrated in Figure 2C, the width W_{con} of the connection region 236 can be uniform
5 from the proximal opening 234 to the distal opening 238. The width W_{con} of the connection region 236 at the distal opening 238 can thus be any of the values identified herein for the width W_{con} of the connection region 236 at the proximal opening 234. Alternatively, the width W_{con} of the connection region 236 at the distal opening 238 can be larger than the width W_{con} of the connection region 236 at the proximal opening 234.

10 [00359] As illustrated in Figure 2C, the width of the isolation region 240 at the distal opening 238 can be substantially the same as the width W_{con} of the connection region 236 at the proximal opening 234. The width of the isolation region 240 at the distal opening 238 can thus be any of the values identified herein for the width W_{con} of the connection region 236 at the proximal opening 234. Alternatively, the width of the isolation region 240 at the distal opening 238 can be
15 larger or smaller than the width W_{con} of the connection region 236 at the proximal opening 234. Moreover, the distal opening 238 may be smaller than the proximal opening 234 and the width W_{con} of the connection region 236 may be narrowed between the proximal opening 234 and distal opening 238. For example, the connection region 236 may be narrowed between the proximal opening and the distal opening, using a variety of different geometries (e.g. chamfering the
20 connection region, beveling the connection region). Further, any part or subpart of the connection region 236 may be narrowed (e.g. a portion of the connection region adjacent to the proximal opening 234).

[00360] Figures 2D-2F depict another exemplary embodiment of a microfluidic device 250
25 containing a microfluidic circuit 262 and flow channels 264, which are variations of the respective microfluidic device 100, circuit 132 and channel 134 of Figure 1A. The microfluidic device 250 also has a plurality of sequestration pens 266 that are additional variations of the above-described sequestration pens 124, 126, 128, 130, 224, 226 or 228. In particular, it should be appreciated that the sequestration pens 266 of device 250 shown in Figures 2D-2F can replace any of the above-described sequestration pens 124, 126, 128, 130, 224, 226 or 228 in devices 100, 200, 230, 280,
30 290, 300, 700, 800, 1000. Likewise, the microfluidic device 250 is another variant of the microfluidic device 100, and may also have the same or a different DEP configuration as the above-described microfluidic device 100, 200, 230, 280, 290, 300, 700, 800, 1000 as well as any of the other microfluidic system components described herein.

[00361] The microfluidic device 250 of Figures 2D-2F comprises a support structure (not visible in Figures 2D-2F, but can be the same or generally similar to the support structure 104 of device 100 depicted in Figure 1A), a microfluidic circuit structure 256, and a cover (not visible in Figures 2D-2F, but can be the same or generally similar to the cover 122 of device 100 depicted in Figure 1A). The microfluidic circuit structure 256 includes a frame 252 and microfluidic circuit material 260, which can be the same as or generally similar to the frame 114 and microfluidic circuit material 116 of device 100 shown in Figure 1A. As shown in Figure 2D, the microfluidic circuit 262 defined by the microfluidic circuit material 260 can comprise multiple channels 264 (two are shown but there can be more) to which multiple sequestration pens 266 are fluidically connected.

10 [00362] Each sequestration pen 266 can comprise an isolation structure 272, an isolation region 270 within the isolation structure 272, and a connection region 268. From a proximal opening 274 at the microfluidic channel 264 to a distal opening 276 at the isolation structure 272, the connection region 268 fluidically connects the microfluidic channel 264 to the isolation region 270. Generally, in accordance with the above discussion of Figures 2B and 2C, a flow 278 of a first fluidic medium 254 in a channel 264 can create secondary flows 282 of the first medium 254 from the microfluidic channel 264 into and/or out of the respective connection regions 268 of the sequestration pens 266.

[00363] As illustrated in Figure 2E, the connection region 268 of each sequestration pen 266 generally includes the area extending between the proximal opening 274 to a channel 264 and the distal opening 276 to an isolation structure 272. The length L_{con} of the connection region 268 can be greater than the maximum penetration depth D_p of secondary flow 282, in which case the secondary flow 282 will extend into the connection region 268 without being redirected toward the isolation region 270 (as shown in Figure 2D). Alternatively, as illustrated in Figure 2F, the connection region 268 can have a length L_{con} that is less than the maximum penetration depth D_p , in which case the secondary flow 282 will extend through the connection region 268 and be redirected toward the isolation region 270. In this latter situation, the sum of lengths L_{c1} and L_{c2} of connection region 268 is greater than the maximum penetration depth D_p , so that secondary flow 282 will not extend into isolation region 270. Whether length L_{con} of connection region 268 is greater than the penetration depth D_p , or the sum of lengths L_{c1} and L_{c2} of connection region 268 is greater than the penetration depth D_p , a flow 278 of a first medium 254 in channel 264 that does not exceed a maximum velocity V_{max} will produce a secondary flow having a penetration depth D_p , and micro-objects (not shown but can be the same or generally similar to the micro-objects 246 shown in Figure 2C) in the isolation region 270 of a sequestration pen 266 will not be drawn out of the isolation region 270 by a flow 278 of first medium 254 in channel 264. Nor will

the flow 278 in channel 264 draw miscellaneous materials (not shown) from channel 264 into the isolation region 270 of a sequestration pen 266. As such, diffusion is the only mechanism by which components in a first medium 254 in the microfluidic channel 264 can move from the microfluidic channel 264 into a second medium 258 in an isolation region 270 of a sequestration pen 266. Likewise, diffusion is the only mechanism by which components in a second medium 258 in an isolation region 270 of a sequestration pen 266 can move from the isolation region 270 to a first medium 254 in the microfluidic channel 264. The first medium 254 can be the same medium as the second medium 258, or the first medium 254 can be a different medium than the second medium 258. Alternatively, the first medium 254 and the second medium 258 can start out being the same, then become different, e.g., through conditioning of the second medium by one or more cells in the isolation region 270, or by changing the medium flowing through the microfluidic channel 264.

[00364] As illustrated in Figure 2E, the width W_{ch} of the microfluidic channels 264 (i.e., taken transverse to the direction of a fluid medium flow through the microfluidic channel indicated by arrows 278 in Figure 2D) in the microfluidic channel 264 can be substantially perpendicular to a width W_{con1} of the proximal opening 274 and thus substantially parallel to a width W_{con2} of the distal opening 276. The width W_{con1} of the proximal opening 274 and the width W_{con2} of the distal opening 276, however, need not be substantially perpendicular to each other. For example, an angle between an axis (not shown) on which the width W_{con1} of the proximal opening 274 is oriented and another axis on which the width W_{con2} of the distal opening 276 is oriented can be other than perpendicular and thus other than 90° . Examples of alternatively oriented angles include angles of: about 30° to about 90° , about 45° to about 90° , about 60° to about 90° , or the like.

[00365] In various embodiments of sequestration pens (e.g. 124, 126, 128, 130, 224, 226, 228, or 266), the isolation region (e.g. 240 or 270) is configured to contain a plurality of micro-objects. In other embodiments, the isolation region can be configured to contain only one, two, three, four, five, or a similar relatively small number of micro-objects. Accordingly, the volume of an isolation region can be, for example, at least 1×10^6 , 2×10^6 , 4×10^6 , 6×10^6 cubic microns, or more.

[00366] In various embodiments of sequestration pens, the width W_{ch} of the microfluidic channel (e.g., 122) at a proximal opening (e.g. 234) can be about 50-1000 microns, 50-500 microns, 50-400 microns, 50-300 microns, 50-250 microns, 50-200 microns, 50-150 microns, 50-100 microns, 70-500 microns, 70-400 microns, 70-300 microns, 70-250 microns, 70-200 microns, 70-150 microns, 90-400 microns, 90-300 microns, 90-250 microns, 90-200 microns, 90-150 microns, 100-300 microns, 100-250 microns, 100-200 microns, 100-150 microns, or 100-120 microns. In

some other embodiments, the width W_{ch} of the microfluidic channel (e.g., 122) at a proximal opening (e.g. 234) can be about 200-800 microns, 200-700 microns, or 200-600 microns. The foregoing are examples only, and the width W_{ch} of the microfluidic channel 122 can be any width within any of the endpoints listed above. Moreover, the W_{ch} of the microfluidic channel 122 can be selected to be in any of these widths in regions of the microfluidic channel other than at a proximal opening of a sequestration pen.

[00367] In some embodiments, a sequestration pen has a height of about 30 to about 200 microns, or about 50 to about 150 microns. In some embodiments, the sequestration pen has a cross-sectional area of about $1 \times 10^4 - 3 \times 10^6$ square microns, $2 \times 10^4 - 2 \times 10^6$ square microns, $4 \times 10^4 - 1 \times 10^6$ square microns, $2 \times 10^4 - 5 \times 10^5$ square microns, $2 \times 10^4 - 1 \times 10^5$ square microns or about $2 \times 10^5 - 2 \times 10^6$ square microns.

[00368] In various embodiments of sequestration pens, the height H_{ch} of the microfluidic channel (e.g.,122) at a proximal opening (e.g., 234) can be a height within any of the following heights: 20-100 microns, 20-90 microns, 20-80 microns, 20-70 microns, 20-60 microns, 20-50 microns, 30-100 microns, 30-90 microns, 30-80 microns, 30-70 microns, 30-60 microns, 30-50 microns, 40-100 microns, 40-90 microns, 40-80 microns, 40-70 microns, 40-60 microns, or 40-50 microns. The foregoing are examples only, and the height H_{ch} of the microfluidic channel (e.g.,122) can be a height within any of the endpoints listed above. The height H_{ch} of the microfluidic channel 122 can be selected to be in any of these heights in regions of the microfluidic channel other than at a proximal opening of a sequestration pen.

[00369] In various embodiments of sequestration pens a cross-sectional area of the microfluidic channel (e.g., 122) at a proximal opening (e.g., 234) can be about 500-50,000 square microns, 500-40,000 square microns, 500-30,000 square microns, 500-25,000 square microns, 500-20,000 square microns, 500-15,000 square microns, 500-10,000 square microns, 500-7,500 square microns, 500-5,000 square microns, 1,000-25,000 square microns, 1,000-20,000 square microns, 1,000-15,000 square microns, 1,000-10,000 square microns, 1,000-7,500 square microns, 1,000-5,000 square microns, 2,000-20,000 square microns, 2,000-15,000 square microns, 2,000-10,000 square microns, 2,000-7,500 square microns, 2,000-6,000 square microns, 3,000-20,000 square microns, 3,000-15,000 square microns, 3,000-10,000 square microns, 3,000-7,500 square microns, or 3,000 to 6,000 square microns. The foregoing are examples only, and the cross-sectional area of the microfluidic channel (e.g., 122) at a proximal opening (e.g., 234) can be any area within any of the endpoints listed above.

[00370] In various embodiments of sequestration pens, the length L_{con} of the connection region (e.g., 236) can be about 1-600 microns, 5-550 microns, 10-500 microns, 15-400 microns, 20-300

microns, 20-500 microns, 40-400 microns, 60-300 microns, 80-200 microns, or about 100-150 microns. The foregoing are examples only, and length L_{con} of a connection region (e.g., 236) can be in any length within any of the endpoints listed above.

[00371] In various embodiments of sequestration pens the width W_{con} of a connection region (e.g., 236) at a proximal opening (e.g., 234) can be about 20-500 microns, 20-400 microns, 20-300 microns, 20-200 microns, 20-150 microns, 20-100 microns, 20-80 microns, 20-60 microns, 30-400 microns, 30-300 microns, 30-200 microns, 30-150 microns, 30-100 microns, 30-80 microns, 30-60 microns, 40-300 microns, 40-200 microns, 40-150 microns, 40-100 microns, 40-80 microns, 40-60 microns, 50-250 microns, 50-200 microns, 50-150 microns, 50-100 microns, 10 50-80 microns, 60-200 microns, 60-150 microns, 60-100 microns, 60-80 microns, 70-150 microns, 70-100 microns, or 80-100 microns. The foregoing are examples only, and the width W_{con} of a connection region (e.g., 236) at a proximal opening (e.g., 234) can be different than the foregoing examples (e.g., any value within any of the endpoints listed above).

[00372] In various embodiments of sequestration pens, the width W_{con} of a connection region (e.g., 236) at a proximal opening (e.g., 234) can be at least as large as the largest dimension of a micro-object (e.g., biological cell which may be a T cell, B cell, or an ovum or embryo) that the sequestration pen is intended for. The foregoing are examples only, and the width W_{con} of a connection region (e.g., 236) at a proximal opening (e.g., 234) can be different than the foregoing examples (e.g., a width within any of the endpoints listed above).

[00373] In various embodiments of sequestration pens, the width W_{pr} of a proximal opening of a connection region may be at least as large as the largest dimension of a micro-object (e.g., a biological micro-object such as a cell) that the sequestration pen is intended for. For example, the width W_{pr} may be about 50 microns, about 60 microns, about 100 microns, about 200 microns, about 300 microns or may be about 50-300 microns, about 50-200 microns, about 50-100 25 microns, about 75-150 microns, about 75-100 microns, or about 200-300 microns.

[00374] In various embodiments of sequestration pens, a ratio of the length L_{con} of a connection region (e.g., 236) to a width W_{con} of the connection region (e.g., 236) at the proximal opening 234 can be greater than or equal to any of the following ratios: 0.5, 1.0, 1.5, 2.0, 2.5, 3.0, 3.5, 4.0, 4.5, 5.0, 6.0, 7.0, 8.0, 9.0, 10.0, or more. The foregoing are examples only, and the ratio of the length 30 L_{con} of a connection region 236 to a width W_{con} of the connection region 236 at the proximal opening 234 can be different than the foregoing examples.

[00375] In various embodiments of microfluidic devices 100, 200, 23, 250, 280, 290, 300, 700, 800, 1000, V_{max} can be set around 0.2, 0.5, 0.7, 1.0, 1.3, 1.5, 2.0, 2.5, 3.0, 3.5, 4.0, 4.5, 5.0, 5.5, 6.0, 6.7, 7.0, 7.5, 8.0, 8.5, 9.0, 10, 11, 12, 13, 14, or 15 microliters/sec.

[00376] In various embodiments of microfluidic devices having sequestration pens, the volume of an isolation region (e.g., 240) of a sequestration pen can be, for example, at least 5×10^5 , 8×10^5 , 1×10^6 , 2×10^6 , 4×10^6 , 6×10^6 , 8×10^6 , 1×10^7 , 5×10^7 , 1×10^8 , 5×10^8 , or 8×10^8 cubic microns, or more. In various embodiments of microfluidic devices having sequestration pens, the volume of a sequestration pen may be about 5×10^5 , 6×10^5 , 8×10^5 , 1×10^6 , 2×10^6 , 4×10^6 , 8×10^6 , 1×10^7 , 3×10^7 , 5×10^7 , or about 8×10^7 cubic microns, or more. In some other embodiments, the volume of a sequestration pen may be about 1 nanoliter to about 50 nanoliters, 2 nanoliters to about 25 nanoliters, 2 nanoliters to about 20 nanoliters, about 2 nanoliters to about 15 nanoliters, or about 2 nanoliters to about 10 nanoliters.

10 [00377] In various embodiment, the microfluidic device has sequestration pens configured as in any of the embodiments discussed herein where the microfluidic device has about 5 to about 10 sequestration pens, about 10 to about 50 sequestration pens, about 100 to about 500 sequestration pens; about 200 to about 1000 sequestration pens, about 500 to about 1500 sequestration pens, about 1000 to about 2000 sequestration pens, about 1000 to about 3500 sequestration pens, about 15 3000 to about 7000 sequestration pens, about 5000 to about 10,000 sequestration pens, about 9,000 to about 15,000 sequestration pens, or about 12, 000 to about 20,000 sequestration pens. The sequestration pens need not all be the same size and may include a variety of configurations (e.g., different widths, different features within the sequestration pen).

[00378] Figure 2G illustrates a microfluidic device 280 according to one embodiment. The microfluidic device 280 illustrated in Figure 2G is a stylized diagram of a microfluidic device 100. In practice the microfluidic device 280 and its constituent circuit elements (e.g. channels 122 and sequestration pens 128) would have the dimensions discussed herein. The microfluidic circuit 120 illustrated in Figure 2G has two ports 107, four distinct channels 122 and four distinct flow paths 106. The microfluidic device 280 further comprises a plurality of sequestration pens opening off of each channel 122. In the microfluidic device illustrated in Figure 2G, the sequestration pens have a geometry similar to the pens illustrated in Figure 2C and thus, have both connection regions and isolation regions. Accordingly, the microfluidic circuit 120 includes both swept regions (e.g. channels 122 and portions of the connection regions 236 within the maximum penetration depth D_p of the secondary flow 244) and non-swept regions (e.g. isolation regions 240 and portions of the connection regions 236 not within the maximum penetration depth D_p of the secondary flow 244).

[00379] Figures 3A through 3B shows various embodiments of system 150 which can be used to operate and observe microfluidic devices (e.g. 100, 200, 230, 250, 280, 290, 300, 700, 800, 1000) according to the present disclosure. As illustrated in Figure 3A, the system 150 can include

a structure (“nest”) 300 configured to hold a microfluidic device 100 (not shown), or any other microfluidic device described herein. The nest 300 can include a socket 302 capable of interfacing with the microfluidic device 320 (e.g., an optically-actuated electrokinetic device 100) and providing electrical connections from power source 192 to microfluidic device 320. The nest 300
5 can further include an integrated electrical signal generation subsystem 304. The electrical signal generation subsystem 304 can be configured to supply a biasing voltage to socket 302 such that the biasing voltage is applied across a pair of electrodes in the microfluidic device 320 when it is being held by socket 302. Thus, the electrical signal generation subsystem 304 can be part of power source 192. The ability to apply a biasing voltage to microfluidic device 320 does not mean
10 that a biasing voltage will be applied at all times when the microfluidic device 320 is held by the socket 302. Rather, in most cases, the biasing voltage will be applied intermittently, e.g., only as needed to facilitate the generation of electrokinetic forces, such as dielectrophoresis or electro-wetting, in the microfluidic device 320.

[00380] As illustrated in Figure 3A, the nest 300 can include a printed circuit board assembly
15 (PCBA) 322. The electrical signal generation subsystem 304 can be mounted on and electrically integrated into the PCBA 322. The exemplary support includes socket 302 mounted on PCBA 322, as well.

[00381] Typically, the electrical signal generation subsystem 304 will include a waveform
20 generator (not shown). The electrical signal generation subsystem 304 can further include an oscilloscope (not shown) and/or a waveform amplification circuit (not shown) configured to amplify a waveform received from the waveform generator. The oscilloscope, if present, can be configured to measure the waveform supplied to the microfluidic device 320 held by the socket 302. In certain embodiments, the oscilloscope measures the waveform at a location proximal to the microfluidic device 320 (and distal to the waveform generator), thus ensuring greater accuracy
25 in measuring the waveform actually applied to the device. Data obtained from the oscilloscope measurement can be, for example, provided as feedback to the waveform generator, and the waveform generator can be configured to adjust its output based on such feedback. An example of a suitable combined waveform generator and oscilloscope is the Red Pitaya™.

[00382] In certain embodiments, the nest 300 further comprises a controller 308, such as a
30 microprocessor used to sense and/or control the electrical signal generation subsystem 304. Examples of suitable microprocessors include the Arduino™ microprocessors, such as the Arduino Nano™. The controller 308 may be used to perform functions and analysis or may communicate with an external master controller 154 (shown in Figure 1A) to perform functions

and analysis. In the embodiment illustrated in Figure 3A the controller 308 communicates with a master controller 154 through an interface 310 (e.g., a plug or connector).

[00383] In some embodiments, the nest 300 can comprise an electrical signal generation subsystem 304 comprising a Red Pitaya™ waveform generator/oscilloscope unit (“Red Pitaya unit”) and a waveform amplification circuit that amplifies the waveform generated by the Red Pitaya unit and passes the amplified voltage to the microfluidic device 100. In some embodiments, the Red Pitaya unit is configured to measure the amplified voltage at the microfluidic device 320 and then adjust its own output voltage as needed such that the measured voltage at the microfluidic device 320 is the desired value. In some embodiments, the waveform amplification circuit can have a +6.5V to -6.5V power supply generated by a pair of DC-DC converters mounted on the PCBA 322, resulting in a signal of up to 13 V_{pp} at the microfluidic device 100.

[00384] As illustrated in Figure 3A, the support structure 300 (e.g., nest) can further include a thermal control subsystem 306. The thermal control subsystem 306 can be configured to regulate the temperature of microfluidic device 320 held by the support structure 300. For example, the thermal control subsystem 306 can include a Peltier thermoelectric device (not shown) and a cooling unit (not shown). The Peltier thermoelectric device can have a first surface configured to interface with at least one surface of the microfluidic device 320. The cooling unit can be, for example, a cooling block (not shown), such as a liquid-cooled aluminum block. A second surface of the Peltier thermoelectric device (e.g., a surface opposite the first surface) can be configured to interface with a surface of such a cooling block. The cooling block can be connected to a fluidic path 314 configured to circulate cooled fluid through the cooling block. In the embodiment illustrated in Figure 3A, the support structure 300 comprises an inlet 316 and an outlet 318 to receive cooled fluid from an external reservoir (not shown), introduce the cooled fluid into the fluidic path 314 and through the cooling block, and then return the cooled fluid to the external reservoir. In some embodiments, the Peltier thermoelectric device, the cooling unit, and/or the fluidic path 314 can be mounted on a casing 312 of the support structure 300. In some embodiments, the thermal control subsystem 306 is configured to regulate the temperature of the Peltier thermoelectric device so as to achieve a target temperature for the microfluidic device 320. Temperature regulation of the Peltier thermoelectric device can be achieved, for example, by a thermoelectric power supply, such as a Pololu™ thermoelectric power supply (Pololu Robotics and Electronics Corp.). The thermal control subsystem 306 can include a feedback circuit, such as a temperature value provided by an analog circuit. Alternatively, the feedback circuit can be provided by a digital circuit.

[00385] In some embodiments, the nest 300 can include a thermal control subsystem 306 with a feedback circuit that is an analog voltage divider circuit (not shown) which includes a resistor (e.g., with resistance 1 kOhm \pm 0.1 %, temperature coefficient \pm 0.02 ppm/C) and a NTC thermistor (e.g., with nominal resistance 1 kOhm \pm 0.01 %). In some instances, the thermal control subsystem 306 measures the voltage from the feedback circuit and then uses the calculated temperature value as input to an on-board PID control loop algorithm. Output from the PID control loop algorithm can drive, for example, both a directional and a pulse-width-modulated signal pin on a Pololu™ motor drive (not shown) to actuate the thermoelectric power supply, thereby controlling the Peltier thermoelectric device.

10 [00386] The nest 300 can include a serial port 324 which allows the microprocessor of the controller 308 to communicate with an external master controller 154 via the interface 310 (not shown). In addition, the microprocessor of the controller 308 can communicate (e.g., via a Plink tool (not shown)) with the electrical signal generation subsystem 304 and thermal control subsystem 306. Thus, via the combination of the controller 308, the interface 310, and the serial
15 port 324, the electrical signal generation subsystem 304 and the thermal control subsystem 306 can communicate with the external master controller 154. In this manner, the master controller 154 can, among other things, assist the electrical signal generation subsystem 304 by performing scaling calculations for output voltage adjustments. A Graphical User Interface (GUI) (not shown) provided via a display device 170 coupled to the external master controller 154, can be
20 configured to plot temperature and waveform data obtained from the thermal control subsystem 306 and the electrical signal generation subsystem 304, respectively. Alternatively, or in addition, the GUI can allow for updates to the controller 308, the thermal control subsystem 306, and the electrical signal generation subsystem 304.

[00387] As discussed above, system 150 can include an imaging device. In some embodiments,
25 the imaging device comprises a light modulating subsystem 330 (See Figure 3B). The light modulating subsystem 330 can include a digital mirror device (DMD) or a microshutter array system (MSA), either of which can be configured to receive light from a light source 332 and transmits a subset of the received light into an optical train of microscope 350. Alternatively, the light modulating subsystem 330 can include a device that produces its own light (and thus
30 dispenses with the need for a light source 332), such as an organic light emitting diode display (OLED), a liquid crystal on silicon (LCOS) device, a ferroelectric liquid crystal on silicon device (FLCOS), or a transmissive liquid crystal display (LCD). The light modulating subsystem 330 can be, for example, a projector. Thus, the light modulating subsystem 330 can be capable of

emitting both structured and unstructured light. In certain embodiments, imaging module 164 and/or motive module 162 of system 150 can control the light modulating subsystem 330.

[00388] In certain embodiments, the imaging device further comprises a microscope 350. In such embodiments, the nest 300 and light modulating subsystem 330 can be individually
5 configured to be mounted on the microscope 350. The microscope 350 can be, for example, a standard research-grade light microscope or fluorescence microscope. Thus, the nest 300 can be configured to be mounted on the stage 344 of the microscope 350 and/or the light modulating subsystem 330 can be configured to mount on a port of microscope 350. In other embodiments, the nest 300 and the light modulating subsystem 330 described herein can be integral components
10 of microscope 350.

[00389] In certain embodiments, the microscope 350 can further include one or more detectors 348. In some embodiments, the detector 348 is controlled by the imaging module 164. The detector 348 can include an eye piece, a charge-coupled device (CCD), a camera (e.g., a digital camera), or any combination thereof. If at least two detectors 348 are present, one detector can
15 be, for example, a fast-frame-rate camera while the other detector can be a high sensitivity camera. Furthermore, the microscope 350 can include an optical train configured to receive reflected and/or emitted light from the microfluidic device 320 and focus at least a portion of the reflected and/or emitted light on the one or more detectors 348. The optical train of the microscope can also include different tube lenses (not shown) for the different detectors, such that the final
20 magnification on each detector can be different.

[00390] In certain embodiments, the imaging device is configured to use at least two light sources. For example, a first light source 332 can be used to produce structured light (e.g., via the light modulating subsystem 330) and a second light source 334 can be used to provide unstructured light. The first light source 332 can produce structured light for optically-actuated electrokinesis
25 and/or fluorescent excitation, and the second light source 334 can be used to provide bright field illumination. In these embodiments, the motive module 164 can be used to control the first light source 332 and the imaging module 164 can be used to control the second light source 334. The optical train of the microscope 350 can be configured to (1) receive structured light from the light modulating subsystem 330 and focus the structured light on at least a first region in a microfluidic device, such as an optically-actuated electrokinetic device, when the device is being held by the
30 nest 300, and (2) receive reflected and/or emitted light from the microfluidic device and focus at least a portion of such reflected and/or emitted light onto detector 348. The optical train can be further configured to receive unstructured light from a second light source and focus the unstructured light on at least a second region of the microfluidic device, when the device is held

by the nest 300. In certain embodiments, the first and second regions of the microfluidic device can be overlapping regions. For example, the first region can be a subset of the second region. In other embodiments, the second light source 334 may additionally or alternatively include a laser, which may have any suitable wavelength of light. The representation of the optical system shown in Figure 3B is a schematic representation only, and the optical system may include additional filters, notch filters, lenses and the like. When the second light source 334 includes one or more light source(s) for brightfield and/or fluorescent excitation, as well as laser illumination the physical arrangement of the light source(s) may vary from that shown in Figure 3B, and the laser illumination may be introduced at any suitable physical location within the optical system. The schematic locations of light source 334 and light source 332/light modulating subsystem 330 may be interchanged as well.

[00391] In Figure 3B, the first light source 332 is shown supplying light to a light modulating subsystem 330, which provides structured light to the optical train of the microscope 350 of system 355 (not shown). The second light source 334 is shown providing unstructured light to the optical train via a beam splitter 336. Structured light from the light modulating subsystem 330 and unstructured light from the second light source 334 travel from the beam splitter 336 through the optical train together to reach a second beam splitter (or dichroic filter 338, depending on the light provided by the light modulating subsystem 330), where the light gets reflected down through the objective 336 to the sample plane 342. Reflected and/or emitted light from the sample plane 342 then travels back up through the objective 340, through the beam splitter and/or dichroic filter 338, and to a dichroic filter 346. Only a fraction of the light reaching dichroic filter 346 passes through and reaches the detector 348.

[00392] In some embodiments, the second light source 334 emits blue light. With an appropriate dichroic filter 346, blue light reflected from the sample plane 342 is able to pass through dichroic filter 346 and reach the detector 348. In contrast, structured light coming from the light modulating subsystem 330 gets reflected from the sample plane 342, but does not pass through the dichroic filter 346. In this example, the dichroic filter 346 is filtering out visible light having a wavelength longer than 495 nm. Such filtering out of the light from the light modulating subsystem 330 would only be complete (as shown) if the light emitted from the light modulating subsystem did not include any wavelengths shorter than 495 nm. In practice, if the light coming from the light modulating subsystem 330 includes wavelengths shorter than 495 nm (e.g., blue wavelengths), then some of the light from the light modulating subsystem would pass through filter 346 to reach the detector 348. In such an embodiment, the filter 346 acts to change the balance between the amount of light that reaches the detector 348 from the first light source 332

and the second light source 334. This can be beneficial if the first light source 332 is significantly stronger than the second light source 334. In other embodiments, the second light source 334 can emit red light, and the dichroic filter 346 can filter out visible light other than red light (e.g., visible light having a wavelength shorter than 650 nm).

5 [00393] **Coating solutions and coating agents.** Without intending to be limited by theory, maintenance of a biological micro-object (e.g., a biological cell) within a microfluidic device (e.g., a DEP-configured and/or EW-configured microfluidic device) may be facilitated (i.e., the biological micro-object exhibits increased viability, greater expansion and/or greater portability within the microfluidic device) when at least one or more inner surfaces of the microfluidic
10 device have been conditioned or coated so as to present a layer of organic and/or hydrophilic molecules that provides the primary interface between the microfluidic device and biological micro-object(s) maintained therein. In some embodiments, one or more of the inner surfaces of the microfluidic device (e.g. the inner surface of the electrode activation substrate of a DEP-configured microfluidic device, the cover of the microfluidic device, and/or the surfaces of the
15 circuit material) may be treated with or modified by a coating solution and/or coating agent to generate the desired layer of organic and/or hydrophilic molecules.

[00394] The coating may be applied before or after introduction of biological micro-object(s), or may be introduced concurrently with the biological micro-object(s). In some embodiments, the biological micro-object(s) may be imported into the microfluidic device in a fluidic medium
20 that includes one or more coating agents. In other embodiments, the inner surface(s) of the microfluidic device (e.g., a DEP-configured microfluidic device) are treated or “primed” with a coating solution comprising a coating agent prior to introduction of the biological micro-object(s) into the microfluidic device.

[00395] In some embodiments, at least one surface of the microfluidic device includes a
25 coating material that provides a layer of organic and/or hydrophilic molecules suitable for maintenance and/or expansion of biological micro-object(s) (e.g. provides a conditioned surface as described below). In some embodiments, substantially all the inner surfaces of the microfluidic device include the coating material. The coated inner surface(s) may include the surface of a flow region (e.g., channel), chamber, or sequestration pen, or a combination thereof.
30 In some embodiments, each of a plurality of sequestration pens has at least one inner surface coated with coating materials. In other embodiments, each of a plurality of flow regions or channels has at least one inner surface coated with coating materials. In some embodiments, at least one inner surface of each of a plurality of sequestration pens and each of a plurality of channels is coated with coating materials.

[00396] **Coating agent/Solution.** Any convenient coating agent/coating solution can be used, including but not limited to: serum or serum factors, bovine serum albumin (BSA), polymers, detergents, enzymes, and any combination thereof.

[00397] **Polymer-based coating materials.** The at least one inner surface may include a coating material that comprises a polymer. The polymer may be covalently or non-covalently bound (or may be non-specifically adhered) to the at least one surface. The polymer may have a variety of structural motifs, such as found in block polymers (and copolymers), star polymers (star copolymers), and graft or comb polymers (graft copolymers), all of which may be suitable for the methods disclosed herein.

5 [00398] The polymer may include a polymer including alkylene ether moieties. A wide variety of alkylene ether containing polymers may be suitable for use in the microfluidic devices described herein. One non-limiting exemplary class of alkylene ether containing polymers are amphiphilic nonionic block copolymers which include blocks of polyethylene oxide (PEO) and polypropylene oxide (PPO) subunits in differing ratios and locations within the polymer chain.

10 Pluronic® polymers (BASF) are block copolymers of this type and are known in the art to be suitable for use when in contact with living cells. The polymers may range in average molecular mass M_w from about 2000Da to about 20KDa. In some embodiments, the PEO-PPO block copolymer can have a hydrophilic-lipophilic balance (HLB) greater than about 10 (e.g. 12-18). Specific Pluronic® polymers useful for yielding a coated surface include Pluronic® L44, L64,

15 P85, and F127 (including F127NF). Another class of alkylene ether containing polymers is polyethylene glycol (PEG $M_w < 100,000$ Da) or alternatively polyethylene oxide (PEO, $M_w > 100,000$). In some embodiments, a PEG may have an M_w of about 1000Da, 5000Da, 10,000Da or 20,000Da.

[00399] In other embodiments, the coating material may include a polymer containing

25 carboxylic acid moieties. The carboxylic acid subunit may be an alkyl, alkenyl or aromatic moiety containing subunit. One non-limiting example is polylactic acid (PLA). In other embodiments, the coating material may include a polymer containing phosphate moieties, either at a terminus of the polymer backbone or pendant from the backbone of the polymer. In yet other embodiments, the coating material may include a polymer containing sulfonic acid

30 moieties. The sulfonic acid subunit may be an alkyl, alkenyl or aromatic moiety containing subunit. One non-limiting example is polystyrene sulfonic acid (PSSA) or polyanethole sulfonic acid. In further embodiments, the coating material may include a polymer including amine moieties. The polyamino polymer may include a natural polyamine polymer or a synthetic

polyamine polymer. Examples of natural polyamines include spermine, spermidine, and putrescine.

[00400] In other embodiments, the coating material may include a polymer containing saccharide moieties. In a non-limiting example, polysaccharides such as xanthan gum or dextran
5 may be suitable to form a material which may reduce or prevent cell sticking in the microfluidic device. For example, a dextran polymer having a size about 3kDa may be used to provide a coating material for a surface within a microfluidic device.

[00401] In other embodiments, the coating material may include a polymer containing nucleotide moieties, i.e. a nucleic acid, which may have ribonucleotide moieties or
10 deoxyribonucleotide moieties, providing a polyelectrolyte surface. The nucleic acid may contain only natural nucleotide moieties or may contain unnatural nucleotide moieties which comprise nucleobase, ribose or phosphate moiety analogs such as 7-deazaadenine, pentose, methyl phosphonate or phosphorothioate moieties without limitation.

[00402] In yet other embodiments, the coating material may include a polymer containing
15 amino acid moieties. The polymer containing amino acid moieties may include a natural amino acid containing polymer or an unnatural amino acid containing polymer, either of which may include a peptide, a polypeptide or a protein. In one non-limiting example, the protein may be bovine serum albumin (BSA) and/or serum (or a combination of multiple different sera) comprising albumin and/or one or more other similar proteins as coating agents. The serum can
20 be from any convenient source, including but not limited to fetal calf serum, sheep serum, goat serum, horse serum, and the like. In certain embodiments, BSA in a coating solution is present in a concentration from about 1 mg/mL to about 100 mg/mL, including 5 mg/mL, 10 mg/mL, 20 mg/mL, 30 mg/mL, 40 mg/mL, 50 mg/mL, 60 mg/mL, 70 mg/mL, 80 mg/mL, 90 mg/mL, or more or anywhere in between. In certain embodiments, serum in a coating solution may be
25 present in a concentration of about 20% (v/v) to about 50% v/v, including 25%, 30%, 35%, 40%, 45%, or more or anywhere in between. In some embodiments, BSA may be present as a coating agent in a coating solution at 5 mg/mL, whereas in other embodiments, BSA may be present as a coating agent in a coating solution at 70 mg/mL. In certain embodiments, serum is present as a coating agent in a coating solution at 30%. In some embodiments, an extracellular
30 matrix (ECM) protein may be provided within the coating material for optimized cell adhesion to foster cell growth. A cell matrix protein, which may be included in a coating material, can include, but is not limited to, a collagen, an elastin, an RGD-containing peptide (e.g. a fibronectin), or a laminin. In yet other embodiments, growth factors, cytokines, hormones or

other cell signaling species may be provided within the coating material of the microfluidic device.

[00403] In some embodiments, the coating material may include a polymer containing more than one of alkylene oxide moieties, carboxylic acid moieties, sulfonic acid moieties, phosphate moieties, saccharide moieties, nucleotide moieties, or amino acid moieties. In other
5 embodiments, the polymer conditioned surface may include a mixture of more than one polymer each having alkylene oxide moieties, carboxylic acid moieties, sulfonic acid moieties, phosphate moieties, saccharide moieties, nucleotide moieties, and/or amino acid moieties, which may be independently or simultaneously incorporated into the coating material.

10 [00404] **Covalently linked coating materials.** In some embodiments, the at least one inner surface includes covalently linked molecules that provide a layer of organic and/or hydrophilic molecules suitable for maintenance/expansion of biological micro-object(s) within the microfluidic device, providing a conditioned surface for such cells.

[00405] The covalently linked molecules include a linking group, wherein the linking group is
15 covalently linked to one or more surfaces of the microfluidic device, as described below. The linking group is also covalently linked to a moiety configured to provide a layer of organic and/or hydrophilic molecules suitable for maintenance/expansion of biological micro-object(s).

[00406] In some embodiments, the covalently linked moiety configured to provide a layer of organic and/or hydrophilic molecules suitable for maintenance/expansion of biological micro-
20 object(s) may include alkyl or fluoroalkyl (which includes perfluoroalkyl) moieties; mono- or polysaccharides (which may include but is not limited to dextran); alcohols (including but not limited to propargyl alcohol); polyalcohols, including but not limited to polyvinyl alcohol; alkylene ethers, including but not limited to polyethylene glycol; polyelectrolytes (including but not limited to polyacrylic acid or polyvinyl phosphonic acid); amino groups (including
25 derivatives thereof, such as, but not limited to alkylated amines, hydroxyalkylated amino group, guanidinium, and heterocyclic groups containing an unaromatized nitrogen ring atom, such as, but not limited to morpholinyl or piperazinyl); carboxylic acids including but not limited to propionic acid (which may provide a carboxylate anionic surface); phosphonic acids, including but not limited to ethynyl phosphonic acid (which may provide a phosphonate anionic surface);
30 sulfonate anions; carboxybetaines; sulfobetaines; sulfamic acids; or amino acids.

[00407] In various embodiments, the covalently linked moiety configured to provide a layer of organic and/or hydrophilic molecules suitable for maintenance/expansion of biological micro-object(s) in the microfluidic device may include non-polymeric moieties such as an alkyl moiety, a substituted alkyl moiety, such as a fluoroalkyl moiety (including but not limited to a

perfluoroalkyl moiety), amino acid moiety, alcohol moiety, amino moiety, carboxylic acid moiety, phosphonic acid moiety, sulfonic acid moiety, sulfamic acid moiety, or saccharide moiety. Alternatively, the covalently linked moiety may include polymeric moieties, which may be any of the moieties described above.

5 [00408] In some embodiments, the covalently linked alkyl moiety may comprise carbon atoms forming a linear chain (e.g., a linear chain of at least 10 carbons, or at least 14, 16, 18, 20, 22, or more carbons) and may be an unbranched alkyl moiety. In some embodiments, the alkyl group may include a substituted alkyl group (e.g., some of the carbons in the alkyl group can be fluorinated or perfluorinated). In some embodiments, the alkyl group may include a first
10 segment, which may include a perfluoroalkyl group, joined to a second segment, which may include a non-substituted alkyl group, where the first and second segments may be joined directly or indirectly (e.g., by means of an ether linkage). The first segment of the alkyl group may be located distal to the linking group, and the second segment of the alkyl group may be located proximal to the linking group.

15 [00409] In other embodiments, the covalently linked moiety may include at least one amino acid, which may include more than one type of amino acid. Thus, the covalently linked moiety may include a peptide or a protein. In some embodiments, the covalently linked moiety may include an amino acid which may provide a zwitterionic surface to support cell growth, viability, portability, or any combination thereof.

20 [00410] In other embodiments, the covalently linked moiety may include at least one alkylene oxide moiety, and may include any alkylene oxide polymer as described above. One useful class of alkylene ether containing polymers is polyethylene glycol (PEG $M_w < 100,000\text{Da}$) or alternatively polyethylene oxide (PEO, $M_w > 100,000$). In some embodiments, a PEG may have an M_w of about 1000Da, 5000Da, 10,000Da or 20,000Da.

25 [00411] The covalently linked moiety may include one or more saccharides. The covalently linked saccharides may be mono-, di-, or polysaccharides. The covalently linked saccharides may be modified to introduce a reactive pairing moiety which permits coupling or elaboration for attachment to the surface. Exemplary reactive pairing moieties may include aldehyde, alkyne or halo moieties. A polysaccharide may be modified in a random fashion, wherein each
30 of the saccharide monomers may be modified or only a portion of the saccharide monomers within the polysaccharide are modified to provide a reactive pairing moiety that may be coupled directly or indirectly to a surface. One exemplar may include a dextran polysaccharide, which may be coupled indirectly to a surface via an unbranched linker.

[00412] The covalently linked moiety may include one or more amino groups. The amino group may be a substituted amine moiety, guanidine moiety, nitrogen-containing heterocyclic moiety or heteroaryl moiety. The amino containing moieties may have structures permitting pH modification of the environment within the microfluidic device, and optionally, within the
5 sequestration pens and/or flow regions (e.g., channels).

[00413] The coating material providing a conditioned surface may comprise only one kind of covalently linked moiety or may include more than one different kind of covalently linked moiety. For example, the fluoroalkyl conditioned surfaces (including perfluoroalkyl) may have a plurality of covalently linked moieties which are all the same, e.g., having the same linking
10 group and covalent attachment to the surface, the same overall length, and the same number of fluoromethylene units comprising the fluoroalkyl moiety. Alternatively, the coating material may have more than one kind of covalently linked moiety attached to the surface. For example, the coating material may include molecules having covalently linked alkyl or fluoroalkyl moieties having a specified number of methylene or fluoromethylene units and may further
15 include a further set of molecules having charged moieties covalently attached to an alkyl or fluoroalkyl chain having a greater number of methylene or fluoromethylene units, which may provide capacity to present bulkier moieties at the coated surface. In this instance, the first set of molecules having different, less sterically demanding termini and fewer backbone atoms can help to functionalize the entire substrate surface and thereby prevent undesired adhesion or
20 contact with the silicon/silicon oxide, hafnium oxide or alumina making up the substrate itself. In another example, the covalently linked moieties may provide a zwitterionic surface presenting alternating charges in a random fashion on the surface.

[00414] **Conditioned surface properties.** Aside from the composition of the conditioned surface, other factors such as physical thickness of the hydrophobic material can impact DEP
25 force. Various factors can alter the physical thickness of the conditioned surface, such as the manner in which the conditioned surface is formed on the substrate (e.g. vapor deposition, liquid phase deposition, spin coating, flooding, and electrostatic coating). In some embodiments, the conditioned surface has a thickness of about 1nm to about 10nm; about 1 nm to about 7 nm; about 1nm to about 5nm; or any individual value therebetween. In other embodiments, the
30 conditioned surface formed by the covalently linked moieties may have a thickness of about 10 nm to about 50 nm. In various embodiments, the conditioned surface prepared as described herein has a thickness of less than 10nm. In some embodiments, the covalently linked moieties of the conditioned surface may form a monolayer when covalently linked to the surface of the microfluidic device (e.g., a DEP configured substrate surface) and may have a thickness of less

than 10 nm (e.g., less than 5 nm, or about 1.5 to 3.0 nm). These values are in contrast to that of a surface prepared by spin coating, for example, which may typically have a thickness of about 30nm. In some embodiments, the conditioned surface does not require a perfectly formed monolayer to be suitably functional for operation within a DEP-configured microfluidic device.

5 [00415] In various embodiments, the coating material providing a conditioned surface of the microfluidic device may provide desirable electrical properties. Without intending to be limited by theory, one factor that impacts robustness of a surface coated with a particular coating material is intrinsic charge trapping. Different coating materials may trap electrons, which can lead to breakdown of the coating material. Defects in the coating material may increase charge
10 trapping and lead to further breakdown of the coating material. Similarly, different coating materials have different dielectric strengths (i.e. the minimum applied electric field that results in dielectric breakdown), which may impact charge trapping. In certain embodiments, the coating material can have an overall structure (e.g., a densely-packed monolayer structure) that reduces or limits that amount of charge trapping.

15 [00416] In addition to its electrical properties, the conditioned surface may also have properties that are beneficial in use with biological molecules. For example, a conditioned surface that contains fluorinated (or perfluorinated) carbon chains may provide a benefit relative to alkyl-terminated chains in reducing the amount of surface fouling. Surface fouling, as used herein, refers to the amount of indiscriminate material deposition on the surface of the microfluidic
20 device, which may include permanent or semi-permanent deposition of biomaterials such as protein and its degradation products, nucleic acids and respective degradation products and the like.

[00417] **Unitary or Multi-part conditioned surface.** The covalently linked coating material may be formed by reaction of a molecule which already contains the moiety configured to
25 provide a layer of organic and/or hydrophilic molecules suitable for maintenance/expansion of biological micro-object(s) in the microfluidic device, as is described below. Alternatively, the covalently linked coating material may be formed in a two-part sequence by coupling the moiety configured to provide a layer of organic and/or hydrophilic molecules suitable for maintenance/expansion of biological micro-object(s) to a surface modifying ligand that itself has
30 been covalently linked to the surface.

[00418] **Methods of preparing a covalently linked coating material.** In some embodiments, a coating material that is covalently linked to the surface of a microfluidic device (e.g., including at least one surface of the sequestration pens and/or flow regions) has a structure of Formula 1 or Formula 2. When the coating material is introduced to the surface in one step, it has a structure

of Formula 1, while when the coating material is introduced in a multiple step process, it has a structure of Formula 2.

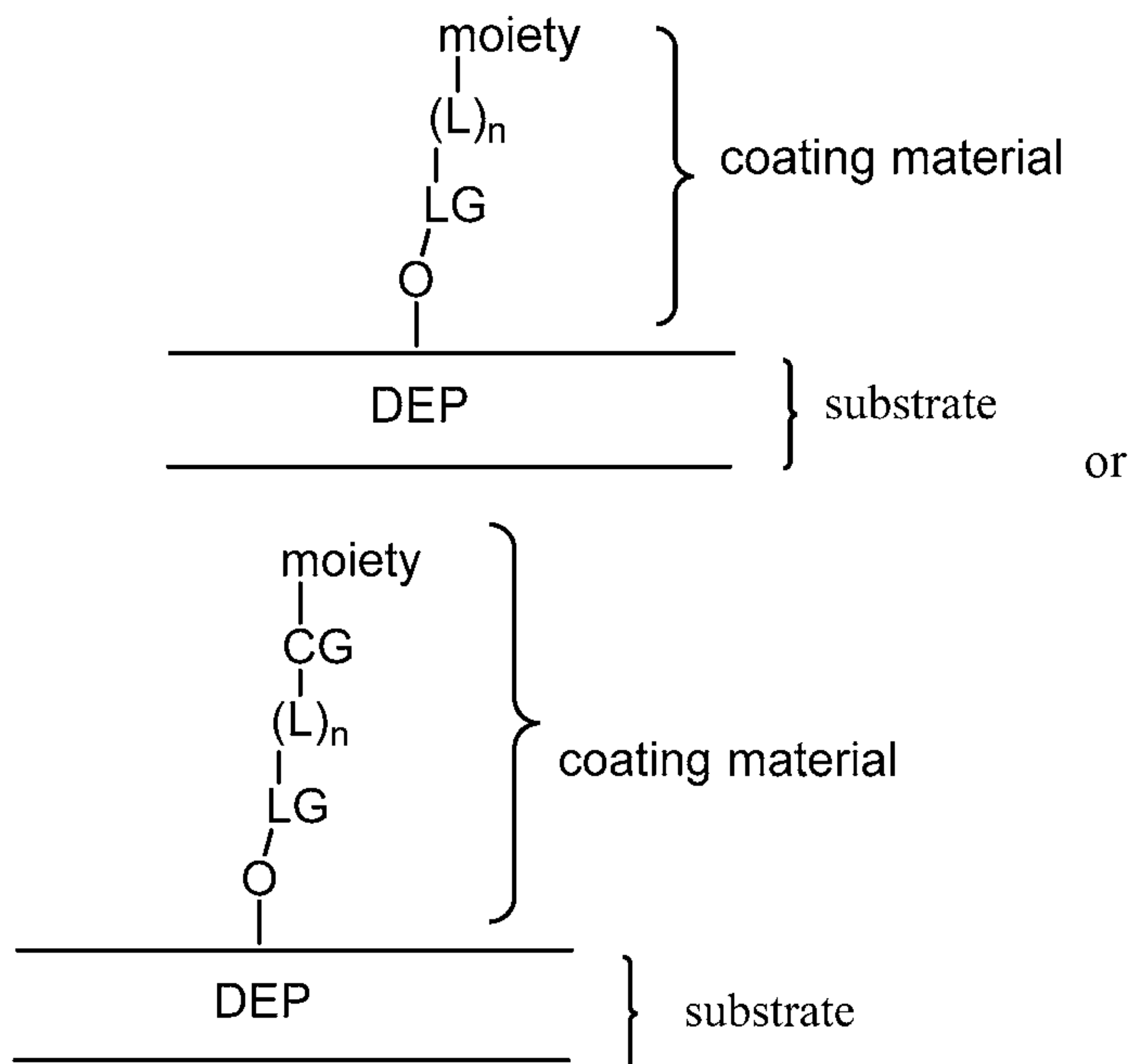

5 Formula 1

Formula 2

[00419] The coating material may be linked covalently to oxides of the surface of a DEP-configured or EW- configured substrate. The DEP- or EW- configured substrate may comprise silicon, silicon oxide, alumina, or hafnium oxide. Oxides may be present as part of the native chemical structure of the substrate or may be introduced as discussed below.

10 [00420] The coating material may be attached to the oxides via a linking group (“LG”), which may be a siloxy or phosphonate ester group formed from the reaction of a siloxane or phosphonic acid group with the oxides. The moiety configured to provide a layer of organic and/or hydrophilic molecules suitable for maintenance/expansion of biological micro-object(s) in the microfluidic device can be any of the moieties described herein. The linking group LG

15 may be directly or indirectly connected to the moiety configured to provide a layer of organic and/or hydrophilic molecules suitable for maintenance/expansion of biological micro-object(s) in the microfluidic device. When the linking group LG is directly connected to the moiety, optional linker (“L”) is not present and n is 0. When the linking group LG is indirectly connected to the moiety, linker L is present and n is 1. The linker L may have a linear portion

20 where a backbone of the linear portion may include 1 to 200 non-hydrogen atoms selected from any combination of silicon, carbon, nitrogen, oxygen, sulfur and/or phosphorus atoms, subject to chemical bonding limitations as is known in the art. It may be interrupted with any combination of one or more moieties, which may be chosen from ether, amino, carbonyl, amido, and/or phosphonate groups, arylene, heteroarylene, or heterocyclic groups. In some embodiments, the

backbone of the linker L may include 10 to 20 atoms. In other embodiments, the backbone of the linker L may include about 5 atoms to about 200 atoms; about 10 atoms to about 80 atoms; about 10 atoms to about 50 atoms; or about 10 atoms to about 40 atoms. In some embodiments, the backbone atoms are all carbon atoms.

5 [00421] In some embodiments, the moiety configured to provide a layer of organic and/or hydrophilic molecules suitable for maintenance/expansion of biological micro-object(s) may be added to the surface of the substrate in a multi-step process, and has a structure of Formula 2, as shown above. The moiety may be any of the moieties described above.

[00422] In some embodiments, the coupling group CG represents the resultant group from
10 reaction of a reactive moiety R_x and a reactive pairing moiety R_{px} (i.e., a moiety configured to react with the reactive moiety R_x). For example, one typical coupling group CG may include a carboxamidyl group, which is the result of the reaction of an amino group with a derivative of a carboxylic acid, such as an activated ester, an acid chloride or the like. Other CG may include a triazolylene group, a carboxamidyl, thioamidyl, an oxime, a mercaptyl, a disulfide, an ether, or
15 alkenyl group, or any other suitable group that may be formed upon reaction of a reactive moiety with its respective reactive pairing moiety. The coupling group CG may be located at the second end (i.e., the end proximal to the moiety configured to provide a layer of organic and/or hydrophilic molecules suitable for maintenance/expansion of biological micro-object(s) in the microfluidic device) of linker L, which may include any combination of elements as described
20 above. In some other embodiments, the coupling group CG may interrupt the backbone of the linker L. When the coupling group CG is triazolylene, it may be the product resulting from a Click coupling reaction and may be further substituted (e.g., a dibenzocyclooctenyl fused triazolylene group).

[00423] In some embodiments, the coating material (or surface modifying ligand) is deposited
25 on the inner surfaces of the microfluidic device using chemical vapor deposition. The vapor deposition process can be optionally improved, for example, by pre-cleaning the cover 110, the microfluidic circuit material 116, and/or the substrate (e.g., the inner surface 208 of the electrode activation substrate 206 of a DEP-configured substrate, or a dielectric layer of the support structure 104 of an EW-configured substrate), by exposure to a solvent bath, sonication or a
30 combination thereof. Alternatively, or in addition, such pre-cleaning can include treating the cover 110, the microfluidic circuit material 116, and/or the substrate in an oxygen plasma cleaner, which can remove various impurities, while at the same time introducing an oxidized surface (e.g. oxides at the surface, which may be covalently modified as described herein). Alternatively, liquid-phase treatments, such as a mixture of hydrochloric acid and hydrogen

peroxide or a mixture of sulfuric acid and hydrogen peroxide (e.g., piranha solution, which may have a ratio of sulfuric acid to hydrogen peroxide from about 3:1 to about 7:1) may be used in place of an oxygen plasma cleaner.

[00424] In some embodiments, vapor deposition is used to coat the inner surfaces of the microfluidic device 200 after the microfluidic device 200 has been assembled to form an enclosure 102 defining a microfluidic circuit 120. Without intending to be limited by theory, depositing such a coating material on a fully-assembled microfluidic circuit 120 may be beneficial in preventing delamination caused by a weakened bond between the microfluidic circuit material 116 and the electrode activation substrate 206 dielectric layer and/or the cover 110. In embodiments where a two-step process is employed the surface modifying ligand may be introduced via vapor deposition as described above, with subsequent introduction of the moiety configured provide a layer of organic and/or hydrophilic molecules suitable for maintenance/expansion of biological micro-object(s). The subsequent reaction may be performed by exposing the surface modified microfluidic device to a suitable coupling reagent in solution.

[00425] Figure 2H depicts a cross-sectional view of a microfluidic device 290 having an exemplary covalently linked coating material providing a conditioned surface. As illustrated, the coating materials 298 (shown schematically) can comprise a monolayer of densely-packed molecules covalently bound to both the inner surface 294 of a base 286, which may be a DEP substrate, and the inner surface 292 of a cover 288 of the microfluidic device 290. The coating material 298 can be disposed on substantially all inner surfaces 294, 292 proximal to, and facing inwards towards, the enclosure 284 of the microfluidic device 290, including, in some embodiments and as discussed above, the surfaces of microfluidic circuit material (not shown) used to define circuit elements and/or structures within the microfluidic device 290. In alternate embodiments, the coating material 298 can be disposed on only one or some of the inner surfaces of the microfluidic device 290.

[00426] In the embodiment shown in Figure 2H, the coating material 298 can include a monolayer of organosiloxane molecules, each molecule covalently bonded to the inner surfaces 292, 294 of the microfluidic device 290 via a siloxy linker 296. Any of the above-discussed coating materials 298 can be used (e.g. an alkyl-terminated, a fluoroalkyl terminated moiety, a PEG- terminated moiety, a dextran terminated moiety, or a terminal moiety containing positive or negative charges for the organosiloxy moieties), where the terminal moiety is disposed at its enclosure-facing terminus (i.e. the portion of the monolayer of the coating material 298 that is not bound to the inner surfaces 292, 294 and is proximal to the enclosure 284).

[00427] In other embodiments, the coating material 298 used to coat the inner surface(s) 292, 294 of the microfluidic device 290 can include anionic, cationic, or zwitterionic moieties, or any combination thereof. Without intending to be limited by theory, by presenting cationic moieties, anionic moieties, and/or zwitterionic moieties at the inner surfaces of the enclosure 284 of the microfluidic circuit 120, the coating material 298 can form strong hydrogen bonds with water molecules such that the resulting water of hydration acts as a layer (or “shield”) that separates the biological micro-objects from interactions with non-biological molecules (e.g., the silicon and/or silicon oxide of the substrate). In addition, in embodiments in which the coating material 298 is used in conjunction with coating agents, the anions, cations, and/or zwitterions of the coating material 298 can form ionic bonds with the charged portions of non-covalent coating agents (e.g. proteins in solution) that are present in a medium 180 (e.g. a coating solution) in the enclosure 284.

[00428] In still other embodiments, the coating material may comprise or be chemically modified to present a hydrophilic coating agent at its enclosure-facing terminus. In some embodiments, the coating material may include an alkylene ether containing polymer, such as PEG. In some embodiments, the coating material may include a polysaccharide, such as dextran. Like the charged moieties discussed above (e.g., anionic, cationic, and zwitterionic moieties), the hydrophilic coating agent can form strong hydrogen bonds with water molecules such that the resulting water of hydration acts as a layer (or “shield”) that separates the biological micro-objects from interactions with non-biological molecules (e.g., the silicon and/or silicon oxide of the substrate).

[00429] Further details of appropriate coating treatments and modifications may be found at U.S. Application Serial No. 15/135,707, filed on April 22, 2016, and is incorporated by reference in its entirety.

[00430] **Additional system components for maintenance of viability of cells within the sequestration pens of the microfluidic device.** In order to promote growth and/or expansion of cell populations, environmental conditions conducive to maintaining functional cells may be provided by additional components of the system. For example, such additional components can provide nutrients, cell growth signaling species, pH modulation, gas exchange, temperature control, and removal of waste products from cells.

[00431] **Additional system components for maintenance of viability of cells within the sequestration pens of the microfluidic device.** In order to promote growth and/or expansion of cell populations, environmental conditions conducive to maintaining functional cells may be provided by additional components of the system. For example, such additional components can

provide nutrients, cell growth signaling species, pH modulation, gas exchange, temperature control, and removal of waste products from cells.

[00432] **Methods of loading.** Loading of biological micro-objects or micro-objects such as, but not limited to, beads, can involve the use of fluid flow, gravity, a dielectrophoresis (DEP) force, electrowetting, a magnetic force, or any combination thereof as described herein. The DEP force can be generated optically, such as by an optoelectronic tweezers (OET) configuration and/or electrically, such as by activation of electrodes/electrode regions in a temporal/spatial pattern. Similarly, electrowetting force may be provided optically, such as by an opto-electro wetting (OEW) configuration and/or electrically, such as by activation of electrodes/electrode regions in a temporal spatial pattern.

Experimental

[00433] System and Microfluidic device. System and Microfluidic device: Manufactured by Berkeley Lights, Inc. The system included at least a flow controller, temperature controller, fluidic medium conditioning and pump component, light source for light activated DEP configurations, mounting stage for the microfluidic device, and a camera. T The microfluidic device was an OptoSelect™ device (Berkeley Lights, Inc.), configured with OptoElectroPositioning (OEP™) technology. The microfluidic device included a microfluidic channel and a plurality of NanoPen™ chambers fluidically connected thereto, with the chambers having a volume of about 7×10^5 cubic microns.

[00434] Priming regime. 250 microliters of 100% carbon dioxide was flowed in at a rate of 12 microliters/sec. This was followed by 250 microliters of a priming medium composed as follows: 1000 ml Iscove's Modified Dulbecco's Medium (ATCC® Catalog No. 30-2005), 200 ml Fetal Bovine Serum (ATCC® Cat. #30-2020), 10 ml penicillin- streptomycin (Life Technologies® Cat. # 15140-122), and 10 mL Pluronic F-127 (Life Tech Catalog No. 50-310-494). The final step of priming included 250 microliters of the priming medium, flowed in at 12 microliters/sec. Introduction of the culture medium follows.

[00435] Perfusion regime. The perfusion method was either of the following two methods:

[00436] 1. Perfuse at 0.01 microliters/sec for 2h; perfuse at 2 microliters/sec for 64 sec; and repeat.

[00437] 2. Perfuse at 0.02 microliters/sec for 100 sec; stop flow 500 sec; perfuse at 2 microliters/sec for 64 sec; and repeat.

[00438] Barcoded nucleic acid capture beads: Beads were either polystyrene (16 micron) or magnetic (22 micron), Spherotech #SVP-150-4 or #SVM-200-4. Beads were modified to

include oligonucleotides having a barcode as described herein. The barcoded beads may be synthesized in any suitable manner as is known in the art.

[00439] Table 3. Primers used in this experiment.

SEQ ID No.	
103	/5Me-isodC//isodG//iMe-isodC/ACACTCTTTCCCTACACGACGCrGrGrG
104	5'-ACACTCTTTCCCTACACGACGCTCTTCCGATCT
105	5'-/5Biosg/ACACTCTTTCCCTACACGACGC-3'
106	(5'- AATGATACGGCGACCACCGAGATCTACACTCTTTCCCTACACGACG CTCTTC C*G*A*T*C*T-3'
107	5'-CAAGCAGAAGACGGCATAACGAGAT-3'
108	5'-AATGATACGGCGACCACCGA-3'

5 [00440] **RNA sequencing:** The beads were modified to display an oligo(dT) capture sequence/Unique Molecular Identifier sequence/barcode/priming sequence. The barcode was selected to be unique for each bead. The oligo(dT) primer/Unique molecular identifier tag/Cell Barcode/primer sequence may be synthesized by total oligonucleotide synthesis, split and pool synthesis, ligation of oligonucleotide segments of any length, or any combination thereof. The
10 oligo(dT) primer/Unique molecular identifier tag/Cell Barcode/primer sequence may be covalently attached directly or indirectly to the bead or may be attached non-covalently, e.g., via a streptavidin/biotin linker or the like. In this experiment, a fully synthesized oligonucleotide including the capture sequence, UMI, barcode and priming sequence was attached to the bead via a non-covalent biotin/streptavidin linkage.

15 [00441] **Example 1.** RNA capture, sequencing library preparation and sequencing results as demonstrated for OKT3 cells.

[00442] Cells: OKT3 cells, a murine myeloma hybridoma cell line, were obtained from the ATCC (ATCC® Cat. # CRL-8001™). The cells were provided as a suspension cell line. Cultures were maintained by seeding about 1×10^5 to about 2×10^5 viable cells/mL and incubating
20 at 37°C, using 5% carbon dioxide in air as the gaseous environment. Cells were split every 2-3 days. OKT3 cell number and viability were counted and cell density is adjusted to 5×10^5 /ml for loading to the microfluidic device.

[00443] Culture medium: 1000 ml Iscove's Modified Dulbecco's Medium (ATCC® Catalog No. 30-2005), 200 ml Fetal Bovine Serum (ATCC® Cat. #30-2020) and 10 ml penicillin-streptomycin (Life Technologies® Cat. # 15140-122) were combined to make the culture
25 medium. The complete medium was filtered through a 0.22µm filter and stored away from light at 4°C until use.

[00444] When perfusing during incubation periods, the culture medium was conditioned continuously with 5% carbon dioxide in air before introduction into the OptoSelect device.

[00445] **Experiment:** A sample of OKT3 cells were introduced into the OptoSelect device at a density of 2E6 in 200 microliters. 250 of the cells were moved by optically actuated dielectrophoretic force to load one cell per NanoPen chamber. Each cell was positioned within the section of the chamber furthest from the opening to the microfluidic channel (e.g., isolation region). A single uniquely barcoded bead was subsequently loaded into each of the occupied chambers. The total number of beads loaded to the NanoPen chambers having single biological cells was 223, and each bead was also positioned within the portion of each chamber that was not subjected to penetrating fluidic flow. In this experiment, 256 uniquely barcoded beads were created, each having a total of 4 cassetable sequences. Diversity was created by selecting by selecting one of four possible sequences in a first position; one of four of a second, different set of four possible sequences in a second position, one of four of a third different set of four possible sequences in a third position and one of four of a fourth different set of four possible sequences in a four position within the barcode.

[00446] Lysis reagent (Single Cell Lysis Kit, Ambion Catalog No. 4458235) was flowed into the microfluidic channel and permitted to diffuse into the NanoPen chambers. The individually penned OKT3 cells were exposed to the lysis buffer for 10 minutes. Lysis was stopped by flowing in stop lysis buffer (Single Cell Lysis Kit, Ambion Catalog No. 4458235) and incubating for 2 minutes at room temperature while there was no flow in the microfluidic channel. Similar results can be obtained using other lysis buffers, including but not limited to Clontech lysis buffer, Cat #635013, which does not require a stop lysis treatment step. Under the conditions used, the nuclear membrane was not disrupted. The released mRNA was captured onto the barcoded bead present within the same NanoPen chamber.

[00447] The captured RNA was reverse transcribed to cDNA by flowing in a RT reagent mixture (Thermo Scientific™ Maxima™ H Minus RT (ThermoFisher, Catalog No. EP0751): 4 microliters of RT buffer; 2 microliters of 10 millimolar each of dNTPs (New England Biolabs Cat #NO447L); 2 microliters of 10 micromolar E5V6 primer (5Me-isodC//iisodG//iMe-isodC/ACACTCTTTCCCTACACGACGCrGrGrG; SEQ ID No. 103); 1 microliter H Minus RT enzyme; 11 microliters of water). Alternatively, a Clontech SMARTscribe™ reverse transcriptase kit (Cat. # 639536), including enzyme, buffer and DTT can be used to obtain cDNA from the captured nucleic acid. Diffusion of the reagent mixture into the NanoPen Chamber was permitted during a 20 minute period at 16°C, followed by a reaction period of 90 minutes at 42°C.

[00448] After reverse transcription, a blank export of 12 microliters at 3microliters/sec was performed as negative control. This control was then processed separately but similarly to handling of the export group of beads as described below.

[00449] The unique Cell Barcode was then identified for each bead by multiplexed flows of
5 fluorescently labeled hybridization probes as described above. Fluorescently labeled probes (provided in sets of four probes per reagent flow, each probe containing a different fluorophore and a non-identical oligonucleotide sequence from any of the other probes in the flow) were flowed, each group of four probes having distinguishable fluorescent labels, into the
microfluidic channel of the microfluidic device at 1 micromolar diluted in 1 x DPBS from a 100
10 mM stock, and permitted to diffuse into the NanoPen chambers at 16°C over a period of 20 min, and then permitted to hybridize for 90 minutes at 42C.. (Alternatively, a different buffer solution, IDT Duplex buffer Cat. # 11-05-01-12 was also used successfully. Use of this buffer, which is nuclease free, and contains 30 mM Hepes, and 100 mM potassium acetate at pH7.5, also facilitated excellent duplex formation under these conditions.) After completion of the
15 hybridization period, fresh medium (DPBS or Duplex buffer) was flowed through the microfluidic device for 20 min (300 microliters, at 0.25 microliter/sec) to flush unassociated hybridization probes out of the flow region of the microfluidic device. The flush period was selected to be long enough for unhybridized hybridization probes to diffuse out of each NanoPen chamber. Each distinguishable fluorescent wavelength (Cy5, FITC, DAPI, and Texas Red
20 channels) was subsequently excited, and identification of which, if any of the NanoPen chambers demonstrated a fluorescent signal. The location and color of the fluorescent label of each probe localized to a NanoPen chamber was noted, and correlated to the known sequence and fluorescent label of the hybridization probes of the first reagent flow, and the identity of the corresponding cassette sequence of the barcode on the bead was assigned. Successive
25 additional reagent flows of further sets of fluorescently labeled hybridization probes, each having non-identical oligonucleotide sequences to each other and different from the sequences of the first and any other preceding reagent flows were flowed in as above and detection continued. Between each round of reagent flow and detection, flushing was performed using a first flush of 100 microliters of 1X DPBS (Dulbecco's PBS), followed by a second 50 microliter
30 flush of the same medium, both performed at 0.5 microliters/sec. To minimize misidentification of a cassette sequence in a second or further reagent flow, only the first identified fluorescent signal of each distinguishable fluorophore was used to assign cassette sequence identity for the barcode. Upon completing reagent flows totaling all of the cassette sequences used in the barcodes of all the beads within the microfluidic device, the barcodes for all beads in the

NanoPen chambers were assigned to each respective single NanoPen chamber. The assigned location of a specific barcode sequence assigned by this method was used to identify from which specific cell the RNA was captured to the bead, e.g., the location of the source nucleic acid within the Nanopen chambers of the microfluidic device. Figure 14A shows successive points in the process for one NanoPen chamber, #470. Each of the distinguishable fluorescent signal regions as shown at the top of each column labeled A-D. Each flow is shown vertically, labeled 1-4. After the probes of flow 1 have been allowed to hybridize, and flushing completed, the bead in NanoPen chamber 470 had a fluorescent signal only in color channel B. Detecting after the second reagent flow has been introduced, hybridization permitted, and flushing, no additional labels were detected. Note that, while NanoPen chamber #470 shows a signal during the second flow in the “B” fluorescence channel, each barcode and each probe was designed so that each barcode had only one cassette sequence having each of the distinguishable fluorescent labels. This second signaling is not recorded as it represented first flow probe remaining bound to the bead. No additional cassette sequences were identified by the probes of reagent flow 2, nor by reagent flow 3. However, fluorescent signal was identified in the fourth flow for each of the other three fluorescent channels. As a result, the barcode for the bead in NanoPen chamber 470, the barcode was identified as having the sequence correlated with A4B1C4D4 cassette sequences. After detection, remaining hybridization probes were removed by flushing the flow region of the microfluidic device twice with 10mM Tris-HCl (200 microliters at 0.5microliters/sec), prior to further manipulation.

[00450] Optically actuated dielectrophoretic force was then used to export the barcoded beads from the NanoPen chambers into the flow region (e.g., flow channel) in a displacement buffer, 10 micromolar Tris, as shown in Figure 14B. The beads that were exported from the NanoPen chambers were exported out of the microfluidic device using flow and pooled. Positive control beads were present in the export group. After reverse transcriptase inactivation by incubation for 10 minutes at 80°C and treatment with Exonuclease I (NEB, catalog number M0293L) in Exo 1 buffer (17 microliters of exported beads, 1 microliter of exonuclease solution and 2 microliters of Exo I buffer), the export group of beads (20 microliter volume) was added to 5microliters of 10X Advantage 2 PCR buffer, dNTPs, 10 micromolar SNGV6 primer (5’- /5Biosg/ACACTCTTTCCT ACACGACGC-3’; SEQ ID No. 105), 1 microliter Advantage 2 polymerase mix; and 22 microliters water. This sequence was present both on the E5V6 primer and is present within the oligo on the beads and was used to amplify the cDNA, via single primer PCR to enrich for full length cDNA over shorter fragments. The cDNA was subjected to 18 cycles of DNA amplification (Advantage® 2 PCR kit, Clontech, Catalog no. 639206).

[00451] Initial purification of the crude amplification mixture for the export group was performed using 0.6x SPRI (Solid Phase Reversible Immobilization) beads (Agencourt AMPure XP beads (Beckman Coulter, catalog no. A63881)) according to supplier instructions. Quantification was performed (Bioanalyzer 2100, Agilent, Inc.) electrophoretically and/or
5 fluorescently (Qubit™, ThermoFisher Scientific) (Figure 14C) and showed acceptable recovery of amplified DNA. for use in before further library preparation performing one-sided tagmentation (Nextera XT DNA Library Preparation Kit, Illumina®, Inc.), according to supplier instructions. After a second 0.6x SPRI purification, size selection was performed (Pre-Cast Agarose Gel Electrophoresis System. Ladder: 50 bp ladder (ThermoFisher, catalog no. 10488-
10 099). E-gel®: 2% Agarose (Thermofisher, catalog no. G501802). Gel Extraction Kit: QIAquick Gel Extraction Kit (Qiagen, #28704). Quantification was performed as above, providing a library having the appropriate 300- 800 bp size for sequencing. (Figure 14D)

[00452] Sequencing was performed using a MiSeq Sequencer (Illumina®, Inc.). Initial analysis of sequencing results indicated that data obtained from the blank control export looks
15 different from the export group of DNA bearing beads, and the sequencing reads appear to be related with positive control sequences. (data not shown). Analyzing barcode identity within the blank control export, it was seen that most highly represented barcodes were derived from the positive control beads. (data not shown). Because the barcodes were linkable to a specific NanoPen chamber, comparison of cell barcodes showed that the Cell Barcodes from detected
20 and exported beads (“unpenned”) were far more represented than the Cell Barcodes that were detected but had not been exported from its specific NanoPen chamber location (“not unpenned”). As shown in Figure 15A, the heatmap representation showed a large group of detected barcodes from beads known to be exported from the NanoPen chamber (“unpenned”), labeled as “DU”. Most of the detected DU barcodes were at higher y-axis locations of the
25 heatmap designating more frequently identified sequences. The smaller set of detected barcodes that were known to be associated with beads that were not exported are shown in the column labeled “DN” (e.g., detected but not unpenned). Again, the vertical position of each DN barcode indicated its relative frequency of barcode sequence identification. Sequencing was performed using a MiSeq Sequencer (Illumina®, Inc.) 55 cycles of sequencing was performed on read 1 to
30 sequence 40bp of barcode and 10bp of UMIs. 4 additional cycles were required in between the first two “words” of the full-length barcode and the following two as 4 bp were used for barcode ligation in that specific experiment. The last cycle was used for base-calling purposes. An additional 8bp was sequenced, which represents the pool index added during the Nextera library preparation and allowed for multiplexing of several chip/experiments on the same sequencing

run. Finally, an additional 46 cycles of sequencing were performed on read 2 (paired-end run) that provided the sequences of the cDNA (transcript/gene). Additional cycles are possible to be performed, depending on the sequencing kit used and the information desired. Figure 15B showed a boxplot depiction of the same data. Without being bound by theory, these cell

5 barcodes from detected but not unpenned locations may have arisen as an artifact of primers and/or bead synthesis. Comparison of the representation of barcodes found in the sequencing data shows that the bead export sample looks significantly different from the barcodes retrieved from the blank export.

[00453] Figures 16A and B illustrate additional quality evaluations of the sequencing data and

10 library preparation, using these methods. Figure 16A lists two different experiments, A and B, performed as above, differing in the length of time (60 min, 90 min) the reverse transcription step was performed. Experiment A included data from a DNA library resulting from export of 108 beads (capturing RNA from 108 cells). Experiment B included data from a DNA library resulting from export of 120 beads (capturing RNA from 120 cells). In Figure 16B, the Total

15 column showed the total number of reads obtained from the sequencing data for each experiment. The Assigned column represented the number of reads which 1) map to a barcode and 2) have a sequencing quality above a preselected quality threshold. The Aligned column showed the number of reads that map to the genome of interest. Assigned reads that mapped to pseudogenes, mis-annotated genes, and intergenic regions which were not in the reference were

20 removed to obtain this total. The Mito Total column included the number of reads mapping to a mitochondrial reference, which relate to cells in poor physiological condition, which usually express increased numbers of mitochondrial genes. The Mito UMI column represented the number of reads with distinct Unique Molecule Identifiers which mapped to the Mitochondrial reference. The Refseq Total column represented the number of reads aligned to the mRNA

25 Refseq reference which the Refseq UMI column represented the number of reads with distinct UMIs aligned to the mRNA Refseq reference, and represented the original number of molecules captured by the capture beads upon lysis of the cell. All of these numbers indicate that the DNA libraries provided by these methods yield good quality sequencing data, representative of the repertoire of the cell.

30 [00454] Some other analyses were used to evaluate the quality of the sequencing sample library. An off-chip experiment was conducted using 1ng of extracted total RNA from a pool of the same cells. cDNA was prepared using a mix of beads containing all 256 barcode combinations. The downstream processing was performed as described above, providing a bulk control, requiring no identification of barcodes. Equal amounts of input DNA were sequenced

from each of these inputs. Comparison of the sequencing data obtained from these samples is shown in Figures 16C and D. The percentage of barcode reads that were identifiable within the sequencing data ranges from about 78% to about 87% of the total read number and the sequences covered by the sequencing reads ranged from about 49% to about 61% when aligned to the reference transcriptome. (Figure 16C). Finally, the top 5 expressed genes included RPl28 (ribosomal protein); Emb (B cell specific); Rpl24 (B cell specific); Dcun1d5 (B cell specific), Rp35a (ribosomal protein) and Ddt (B cell specific), which were consistent with the cell type and origin. (Figure 16D). Figure 17 showed that across experiments 100, 98, 105, 106, using 90 minute reverse transcription reaction periods, the sets of barcodes detected between each of the experiments varied, indicating good randomization of bead delivery to NanoPen chambers. The comparison of the off- chip experiment (labeled 256), blank (XXX-bl) and the exported bead data for each of four experiments (experiments 100, 98, 105, 106) is shown in Figure 18. Figure 18 showed retrieval of sequenced reads for a number of NanoPen chambers. For each experiment, XXX-E1 was a first export of cDNA decorated beads, and XXX-E2 was a subsequent second export from the same pens. The y axis of the violin plot of Figure 18 was the amount of barcode reads from each sample. The off-microfluidic device control 256 had all barcode represented equivalently. The exported bead data (XXX-E1 or XXX-E2) showed less than all barcodes represented and the amount of barcode reads also was less equivalently represented. Unsurprisingly, samples XXX-E2 showed even fewer reads, but with more variable numbers of those reads. Finally, blank reads showed, as discussed before, a very low number of barcode reads, but with one or two of the reads having a reasonable frequency of occurrence.

[00455] Example 2. T cell phenotyping, culturing, assaying and RNA sequencing.

Linkage of phenotype to genomic information.

[00456] The microfluidic system, materials and methods were the same as in Experiment 1, except for the following:

[00457] Cells: Control cells were human peripheral blood T cells. Sample cells were human T cells derived from a human tumor sample.

[00458] Culture medium: RPMI 1640 medium (Gibco, #12633-012), 10% Fetal Bovine Serum (FBS), (Seradigm, #1500-500); 2% Human AB Serum (Zen-bio, #HSER-ABP100ml), IL-2 (R&D Systems, 202-IL-010) 2U/ml; IL-7 (PeproTech, #200-07) 10ng/ml; IL-15 {PeproTech, #200-15) 10ng/ml, 1X Pluronic F-127 (Life Tech Catalog No. 50-310-494).

[00459] Human T cells derived from a human tumor sample were stained with an antigen off-chip then introduced to the microfluidic channel of the OptoSelect device at a density of at a

density of 5x10⁶ cells/ml. Both antigen positive T cells (P-Ag) and antigen negative cells (N-Ag) were moved by optically actuated dielectrophoretic force to isolate a single T cell into an individual NanoPen chamber, forming a plurality of populated NanoPen chambers.

[00460] Human peripheral blood T cells were activated in the presence of CD3/28 beads (Dynabeads® Human T-Activator CD2/CD28, ThermoFisher No. Gibco™ #11131D), during a four day culture period (Figure 19), forming an activated but not antigen specific population. Treatment with a labeled antigen did not result in labeled control- activated T cells. A population of these control activated T cells were introduced into the microfluidic channel at a density of 5x10⁶ cells/ml and a selected plurality of the control activated T cells were moved by optically actuated dielectrophoretic force to place a single control activated T cell into each of a plurality of Nanopen chambers, which were different from the set of NanoPen chambers containing the set of T cells derived from the tumor sample.

[00461] To each occupied chamber, were added a single barcoded bead which were synthesized via ligation (in this specific experiment). Each bead included a priming sequence, a barcode sequence, a UMI sequence, and a capture sequence as described above. Lysis and capture of RNA followed, as described above. Under the conditions used, the nuclear membrane is not disrupted. The released mRNA was captured onto the barcoded bead present within the same NanoPen chamber.

[00462] In Figures 20A, 21A, and 22A, a set of four photographic images illustrates representative occupied Nanopen chambers. Each set of the photographs, from left to right, showed: 1) brightfield illumination of a T cell after placement into the NanoPen chamber using optically actuated dielectrophoretic force; 2) fluorescent detection (Texas Red channel) probing for antigen- specific staining; 3) brightfield illumination of the Nanopen chamber after one barcoded capture bead was imported using optically actuated dielectrophoretic force; and 4) brightfield illumination after lysis. As above, the lysis conditions ruptured the cell membrane but did not disturb the nuclear membrane.

[00463] In Figure 20A, a NanoPen chamber having a location identifier of 1446, was shown to be occupied by one cell. This cell was an antigen positive stained cell (P-Ag), as shown by the second photograph of the set of Figure 20A, having a fluorescent signal (shown within the white circle within the NanoPen chamber). The third photograph of the set of Figure 20A showed that a single bead was placed within the NanoPen chamber, and the fourth photograph of the set of Figure 20A shows that the bead and the remaining nucleus was still located within the NanoPen chamber. In Figure 21A, similar placement of a cell (first photograph of the second set) and a bead (third photograph of the second set) into the NanoPen chamber No. 547 was shown.

However, this cell did not stain with the antigen; and t no fluorescent signal was detected in the second photograph of the set of photographs of Figure 21A. Therefore, this cell was identified as an antigen negative T cell (N-Ag). In Figure 22A, an equivalent set of photographs was shown for NanoPen chamber, 3431, containing a control activated T cell. As expected, there
5 was no fluorescent signal in the second photograph of the set, corroborating that this cell is not antigen positive.

[00464] **RNA release, capture, library prep and sequencing.** The protocol described in Example 1 for reverse transcription and barcode reading within the microfluidic environment was performed and identification of the barcode for each NanoPen chamber was recorded. In
10 Figures 20B, 21B and 22B, images of the barcode detection process of the respective NanoPen chambers are shown. NanoPen chamber 1446 was determined to have a bead containing the barcode A1B1C1D4; NanoPen chamber 547 had a bead having the barcode A1B3C3D4; and NanoPen chamber 3431 had a bead containing the barcode A2B3C4D4. Bead export, and off chip amplification, tagmentation, purification, and size selection of the cDNA from the exported
15 decorated beads was performed as described in Example 1.

[00465] Sequencing was performed using a MiSeq Sequencer (Illumina®, Inc.) A first sequencing read sequenced 55 cycles on read 1 to sequence 40bp of barcode and 10bp of UMIs. 4 additional cycles were required in between the first two cassette sequences and the last two cassette sequences of the full-length barcode as an additional 4 bp were used for barcode
20 ligation in this specific experiment. The last cycle was used for base-calling purposes. A second sequencing read sequenced 8bp representing the pool index added during the Nextera library preparation, allowing for multiplexing of several experiments on the same sequencing run. Finally, an additional 46 cycles was sequenced on read 2 (paired-end run) that provides sequencing of the cDNA (transcript/gene). Longer reads may be obtained, if desired, but was
25 not used in this experiment.

[00466] Figure 23 shows the heat map of the sequencing results of this experiment, having columns of sequencing reads, each column representing RNA captured to a single bead from the one cell in the NanoPen chamber, which was 1) tumor antigen exposed, positive for Antigen; 2) tumor antigen exposed, negative for antigen; or 3) negative control, activated T cell but not
30 antigen exposed. The columns are arranged according to their similarity in sequencing reads, which is correlated with gene expression information. The color (dark vs light bands) represented the level of expression. Columns 1-14 were more closely related to each other than to Columns 15-36. Since the readable barcodes were identifiable for each column (each bead, from one cell), the location from which the bead was retrieved was determined, and, the

phenotype of the cell from which the RNA was sourced. For example, the three beads identified above, from NanoPen chambers 1446 (labelled 2EB1p_1466 (P-Ag), found at column #6 within group A), 547 (2EB1n_547 (N-Ag), found at column #8 within Group A), and 3431 (labelled EA1NC_3431 (NC) found at column #33 in Group B), provided gene expression profiles shown at the respective highlighted and labeled columns. The difference between the gene expression for columns 15-36 (clustered in group B in the relationship bracket at the top of the heat map), and that of Columns 1-14 (group A) was seen to be substantially dependent on exposure to the tumor antigen. The source cells for substantially all the columns 1-14 of group A had been exposed to tumor antigen, whether positive or negative for antigen staining. In contrast, all of the source cells of Columns 15-36, were negative control cells, and had not been exposed to tumor antigen. Each column represents sequencing reads for one experiment and the color represents the level of expression. The sequencing reads of each of the bead-activated, antigen nonspecific control T cell (NC) were clearly differentiable from either of the sequencing reads of an antigen-positive tumor derived T cell (P-Ag) or an antigen-negative tumor derived (N-Ag) T cell. Specific and differentiable single cell RNA sequencing was demonstrated. Further, it was shown that phenotypic information was linkable to the gene expression profile for a single cell

[00467] **Example 3. DNA capture, sequencing library preparation and sequencing results as demonstrated for OKT3 cells.** Apparatus, priming and perfusion regimes, cell source and preparation were used/performed as in the general methods above, unless specifically noted in this example. The media and OptoSelect device were maintained at 37°C, unless otherwise specified.

[00468] Table 4. Primers for use in this experiment.

SEQ ID No.	Sequence/s
109	BiotinTEG_N701 /5BiotinTEG/CAAGCAGAAGACGGCATAACGAGATTCGCCTTAGTCTCG TGGGCTCG*G
110	BiotinTEG_N702 /5BiotinTEG/CAAGCAGAAGACGGCATAACGAGATCTAGTACGGTCTCG TGGGCTCG*G
111	BiotinTEG_S506 /5BiotinTEG/AATGATACGGCGACCACCGAGATCTACACACTGCATAT CGTCGGCAGCGT*C

[00469] This experiment demonstrated that Nextera sequencing libraries (Illumina) can be generated with isothermal PCR using one biotinylated priming sequence (carrying a barcode) attached to a bead and one primer free in solution. OKT3 cells (150) were imported into the OptoSelect device, and loaded using optically actuated dielectrophoretic forces into NanoPen

chambers. Figure 24 showed the cells after delivery to the NanoPen chambers. The optically actuated dielectrophoretic forces delivered one cell per NanoPen chamber for 7 NanoPen chambers, missed delivering a cell to one NanoPen chamber, and delivered 2 cells to one NanoPen chamber, thereby delivering substantially only one cell per NanoPen chamber.

5 [00470] **Lysis.** The lysis procedure was performed using an automated sequence, but may be suitably performed via manual control of each step. Lysis buffer was flowed into the OptoSelect device (Buffer TCL (Qiagen, Catalog # 1031576)) and flow was then stopped for 2 mins to permit buffer diffusion into the pens. Lysis of both the cell membrane and the nuclear membrane was effected. The OptoSelect device was then flushed three times with 50 microliters of culture
10 media, including a 30 second pause after each 50 microliter flush. Proteinase K (Ambion Catalog # AM2546, 20 mg/ml) at a concentration of 800 micrograms/milliliter was introduced to the OptoSelect device and maintained without perfusion for 20 min. Proteinase K diffused into the NanoPen chamber and proteolyzed undesired proteins and disrupted chromatin to permit gDNA extraction. After completion, the OptoSelect device was flushed with three cycles of 50
15 microliters of PBS including 10 min hold periods after each flow.

[00471] **Staining with SYBR® Green I stain** (ThermoFisher Scientific, Catalog # S7585), at 1:1000 in 1xPBS, was performed to demonstrate that compacted DNA 2510 of the nucleus was present, as shown in Figure 25. Additionally, a sweep using optically actuated dielectrophoresis forces scanning vertically in both directions (up and down, crossing over) through the NanoPen
20 chambers was performed. In figure 25, the two light patterns (“OEP bars”) are shown that were used to create the vertical “crossover” sweep. This resulted in a blurred and enlarged area of fluorescent signal from released DNA 2515 of the nucleus, demonstrating the ability to drag the compacted DNA from the compacted form to a larger, more dispersed area, indicating lysis of the nuclear membrane. Figure 26A shows a photograph of a set of specific NanoPen chambers
25 each containing a stained OKT3 cell before lysis, and Figure 26B shows a photograph of the same NanoPen chambers after the OEP sweep, demonstrating dispersion of the stain (e.g., DNA) to a larger area within the chamber.

[00472] **Tagmentation.** Tagmentation of DNA with transposase. A protocol for tagmentation was followed by introducing a 15 microliter volume of transposome reagents (Nextera DNA
30 Library Prep Kit, Illumina, Cat. # 15028212) including 3.3 microliters of Tagment DNA Buffer (TD); 16 microliters of Tagment DNA enzyme mix (TDE1 Buffer); and 14 microliters of nuclease free H₂O (Ambion Cat. # AM9937) into the OptoSelect device. The tagmentation reagents diffused into the Nanopen chambers over a 15 minute period. The OptoSelect device was then flushed extensively, including clearing the inlet and outlet lines with 100 microliters of

PBS, and flushing the device itself with 50 microliters of PBS. Figure 27 shows graphical distribution (Bioanalyzer, Agilent) of the size of tagmented products obtained via this protocol, with a maximum of the distribution just under 300bp and little of the tagmented products having a size greater than about 600 bp, which demonstrated suitability for massively parallel
5 sequencing methods.

[00473] **DNA capture to beads.** Biotinylated 16 micron polystyrene capture beads (Spherotech) were modified by streptavidin labelled oligonucleotides. The oligonucleotides included a priming sequence, a barcode sequence, and a capture sequence (e.g., mosaic sequence), in 5' to 3' order. The barcode sequence contained at least one sub-barcode module,
10 permitting identification of the source cell within a specific NanoPen chamber of the OptoSelect device. The priming sequence incorporated within the oligonucleotide was P7 (P7 adaptor sequence), in this experiment. (However, other priming sequences may be utilized such as P5 or a priming sequence specifically designed for compatibility with the recombinase and polymerase of the RPA process. After binding with an excess of SA- oligonucleotide for 15 min in a
15 binding buffer including 1M NaCl, 20 mM TrisHCl, 1 mM EDTA and 0.00002 % Triton-X with agitation at speeds up to about 300rpm (VWR Analog vortex mixer), the beads were washed with three aliquots of fresh binding buffer, followed by 50 microliters of PBS. Freshly prepared beads containing P7 priming sequence(sequencing adaptor)/barcode/ capture sequence oligonucleotides were delivered to the NanoPen chambers which had contained cells prior to
20 lysis. This step was performed using an automated sequence including OEP delivery to the NanoPen chambers, but may also be performed manually if desired. In this experiment, the specific automated process used took 1h to complete. More rapid delivery can be advantageous. Additionally, reduced temperature below 37° C may be advantageous for effective DNA capture.

25 [00474] **Isothermal Amplification.** Isothermal amplification of the captured DNA on the beads was performed using a recombinase polymerase amplification (RPA) reaction, (TwistAMP TABA S03, TwistDX,), also including a single-strand DNA (ss-DNA) binding protein which stabilizes displacement loops (D-loops) formed during the process. Also present in the reaction mixture were P5-Mosaic sequence, P7 and P5 primers (IDT). The following mixture: dry
30 enzyme pellet of the TwistDx kit; 27.1 microliters of resuspension buffer; 2.4 microliters of 10 micromolar P5 primer; 2.4 microliters of 10 micromolar P7 primer; and 2.4 microliters of 10 micromolar P5 end index primer (e.g. S521) was added to 2.5 microliters of 280 millimolar magnesium acetate (MgOAc) and vortexed within a microfuge tube. Fifteen microliters of this solubilized and spun solution were imported into the microfluidic channel of the OptoSelect

device at a rate of 1 microliter/second, and permitted to diffuse into the NanoPen chambers and contact the captured DNA on the beads for 40 to 60 minutes.

[00475] After completion of the isothermal amplification period, 50 microliters of fluidic medium were exported from the OptoSelect device, using PBS. The exported solution
5 (“Immediate Export”) containing amplified DNA that had diffused out of the NanoPen chambers) was cleaned up using 1x AMPure® beads (Agencourt Bioscience), removing primers and other nucleic acid materials of less than 100bp size.

[00476] The OptoSelect Device still containing beads and amplified DNA that did not diffuse into the channel was maintained at 4°C overnight, and a second export using 50 microliters of
10 PBS was made, capturing amplification product then present in the microfluidic channel, “2nd Export”. The two samples were further separately amplified via PCR for quantitation and size analysis, each using 5 cycles PCT in a 25 microliter reaction with KAPA HiFi Hotstart (KAPA Biosystems), 1 microliter of 10 micromolar P5 primer, and 1 microliter of 10 micromolar P7 primer. Each of the Immediate Export and 2nd Export samples were cleaned up to remove
15 primers by repeating treatment with 1x AMPure® beads. The Immediate Export sample yielded 40 ng total having fragment sizes suitable for sequencing, having an average size of about 312 bp (data not shown). The 2nd Export sample yielded 85 ng total, with an average size of about 760 bp (data not shown), which were not suitable for further sequencing by NGS parallel techniques.

[00477] The Immediate Export sample was sequenced within a shared Miseq massively
20 parallel sequencing experiment (Illumina). The coverage was low (mean = 0.002731), but reads mapped throughout the mouse genome, as shown in Figure 28. In Figure 28, each chromosome is displayed along the x axis. The left-hand light colored bar represents the expected length of each chromosome while the right hand dark colored bar represents the percentage of total
25 mapped reads seen in the data from the Immediate Export sample. While some chromosomes were overrepresented in the data (chr 2, chr 16), other chromosomes were underrepresented (chr 8, chr 12, chr 15). Note that no reads were obtained for the Y chromosome, as expected, as the cells originated from a female mouse. Acceptably low level of adaptor contaminants (0.000013%) were identified. Additionally, particular sequences of interest were also found in
30 the data (e.g. CXCR4 sequence, data not shown).

[00478] **Example 4. DNA isolation, library preparation and sequencing of a mixture of OKT3 cells and human LCL1 cells from human B-Lymphocyte.** Source of LCL1 cells: Coriell Institute. Catalog number: GM128781C. Media used for culture is RPMI-1640 (Life Technologies, Cat #11875-127), 10% FBS, 1% Pen/Strep (1000 U/ml), 2 mM Glutamax.

[00479] Experiments used either 150 OKT3 cells: 150 Hu LCL1 cells or 75 OKT3 cells:75 Hu LCL1 cells. The cells were specifically delivered to individual NanoPen chambers, one cell to a chamber, using OEP forces such that the locations of each OKT3 and each Hu LCL1 cell was known.

5 [00480] The process of lysis and tagmentation, was performed as in Experiment 3, but with Mosaic End plus insert sequences appended to the fragmented DNA by the transposase having one of the following sequences:

Tn5ME-A (Illumina FC-121-1030), 5'-TCGTCGGCAGCGTCAGATGTGTATAAGAGACAG-3' (SEQ ID No. 161);

10 Tn5ME-B (Illumina FC-121-1031), 5'GTCTCGTGGGCTCGGAGATGTGTATAAGAGACAG-3' (SEQ ID NO.162)

[00481] Specific delivery was made of a first set of barcoded beads having a first unique barcode only to the OKT3 cell- containing NanoPens, followed by specific delivery of a second set of barcoded beads having a second unique barcode only to the Hu LCL1 cell- containing NanoPens. This provided specific identifiers for DNA amplified from each set of beads, so that murine DNA reads could be mapped back to murine cells, and Hu LCL1 cell DNA reads could be mapped back to human cells. The beads were delivered to the NanoPen chambers after the tagmentation step. Isothermal amplification was performed as in Experiment 3, yielding 5.67ng (from 300 cells total) or 2.62ng (from 150 cells total). Two cycles of PCR, run as described above were performed on each library to ensure the presence of P5, P7 for NGS sequencing, and clean up was similarly performed. Figures 29A (from 150 cells) and 29B (from 300 cells) shows the two (OKT3/hu LCL1) DNA libraries respectively after the subsequent two cycle PCR amplification and clean up. These results can be compared to size distribution traces of control libraries that were generated from OKT3 cells and also hu LCL1 cells processed individually in a standard well plate format, as shown in Figure 29C (OKT3) and Figure 29D (hu LCL1.) The comparison indicates that further optimization may be desirable to obtain more ideal fragment distribution within the microfluidic protocol. The sequencing results from the mixed OKT3/hu LCL1 DNA libraries showed that reads having each of the two barcodes were obtained (data not shown).

30 [00482] **In-situ barcode detection.** After export of amplified DNA products, sequential flow of fluorescently labeled hybridization probes as described above identified barcode position.

[00483] **Example 5. Introduction of the barcoded beads and in-situ detection of the barcoded beads within the DNA isolation, library preparation and amplification workflow sequence.** Without wishing to be bound by theory, the activity of transposon is directed towards

double stranded nucleic acids, not single stranded bound oligos. The robustness of the capture beads to these conditions was shown in a corollary experiment. Beads, 20 microliters, as prepared for Experiment 3 were exposed to the tagmentation reaction reagents under the conditions for that same experiment. Both transposon-exposed beads and non- exposed control beads were contacted with 1.4 ng of human standard DNA. 2.4 microliters of each bead set were used in an isothermal amplification, using 2.4 microliters of a paired primer (S521, Illumina) in RPA (S521), and provided substantially similar amounts of amplified DNA. The results show that the capture beads exposed to transposon prior to use in DNA capture yielded reasonably equivalent amounts of amplified product, indicating that transposon did not degrade the capture oligonucleotides on the capture bead.

[00484] Table 5. Comparison of yield between beads exposed to tagmentation reaction conditions and unexposed beads, after isothermal amplification.

Condition	Isothermal yield (ng/microliter)
Transposon- exposed	36.4
Non-exposed (control)	33.4
Transposon-exposed	24.4
Non-exposed (control)	31.8

[00485] **Example 6. Sequencing nuclear DNA from the same cells for which RNA sequencing has been performed.** Figures 30A-F each show a row of four NanoPen chambers of an OptoSelect device, containing OKT3 cells and capture beads. The series of photographs were taken during the course of a protocol in which RNA capture, tagmentation and export had been performed, as in Experiment 1. NucBlue® LiveReady Probes® Reagent (Molecular Probes, R37605) stain was added to the cells before import (two drops are added to 200 microliters of cell solution just prior to import). No additional stain was added throughout the protocol. Nuclear dsDNA of each cell was stained and the staining was maintained throughout the steps of RNA capture, tagmentation, and reverse transcription. Figures 30A-30C were taken under brightfield conditions, and Figures 30D to 30F were taken under UV excitation illumination (excitation at 360 nm when bound to DNA, with an emission maximum at 460 nm) and visualized through a DAPI filter at 400- 410 nm. Figures 30A and 30D are paired images of the same Nanopen Chamber containing cell at a timepoint prior to lysis, under brightfield and DAPI filter exposure respectively. 3002 is a barcoded bead and 3004 is a biological cell within the same NanoPen chamber. Other beads and other cells in other of the four NanoPen chambers of the figures are also visible, but not labeled. Figures 30B and 30E are paired images of the same NanoPen chamber as shown in Figures 30A and 30C, under brightfield and 400 nm

illumination respectively. These photographs were taken after outer membrane lysis as described in Experiment 1 was completed. The nuclear DNA 3004 still is visible under the 400nm excitation illumination (Figure 30E) as well as the shape of the nucleus 3004 still remaining under brightfield along with the bead 3002. Figure 30C and 30F are paired images, brightfield, and 400nm excitation illumination respectively, for the same cells within the same group of four NanoPen chambers as Figures 30A-30D. The photographs of Figures 30C and 30F were taken after reverse transcription was complete and the cDNA decorated barcoded beads 3002' were exported out of each NanoPen chamber (see 3002 within the microfluidic channel at the top of the photograph). The compact nucleus 3006 is still visible under brightfield, and Figure 30F shows that the nucleus 3006 still contained nuclear DNA. Since no additional dye was added, there was no staining of the cDNA produced upon the beads.

[00486] Figures 30A- 30F indicate that by using the protocols described herein for RNA capture/library prep, and DNA capture/library prep, the compact nucleus still was a viable source of nuclear dsDNA for DNA library production. Therefore, sequencing results for both RNA and DNA may be obtained from the same single cell, and may be correlated to the location within the OptoSelect device of the specific single cell source of the sequenced RNA and DNA. This ability to correlate the location of the single cell source of RNA/DNA sequencing results may further be correlated to phenotypic observations of the same single cell, such as cells producing antibodies to specific antigens.

[00487] The step of introduction of the barcoded priming sequence bearing beads was shown to be suitably performed either prior to the tagmentation step or after tagmentation (as in Experiment 3).

[00488] Additionally, the step of reading the barcode(s) on barcoded beads placed within the NanoPen chambers may be performed before tagmentation, before isothermal amplification, prior to export of amplified DNA, or after export of amplified DNA (as shown in Exp. 4). Alternatively, beads may be placed within the NanoPen chambers before importation of biological cells. In that embodiment, the barcodes may also be detected before biological cells are brought into the microfluidic environment.

[00489] **Example 7. B-cell receptor (BCR) capture, sequencing library preparation and sequencing results as demonstrated for OKT3 cells and OKT8 cells.**

[00490] **Cells:** OKT3 cells, a murine myeloma hybridoma cell line, were obtained from the ATCC (ATCC® Cat. # CRL-8001™). The cells were provided as a suspension cell line. Cultures were maintained by seeding about 1×10^5 to about 2×10^5 viable cells/mL and incubating at 37°C, using 5% carbon dioxide in air as the gaseous environment. Cells were split every 2-3 days. OKT3

cell number and viability were counted and cell density is adjusted to 5×10^5 /ml for loading to the microfluidic device.

[00491] OKT8 cells, a murine myeloma hybridoma cell line, were obtained from the ATCC (ATCC® Cat. # CRL-8014™). The cells were provided as a suspension cell line. Cultures were maintained by seeding about 1×10^5 to about 2×10^5 viable cells/mL and incubating at 37°C, using 5% carbon dioxide in air as the gaseous environment. Cells were split every 2-3 days. OKT8 cell number and viability were counted and cell density is adjusted to 5×10^5 /ml for loading to the microfluidic device.

[00492] **Culture medium:** Iscove's Modified Dulbecco's Medium (For OKT3; ATCC® Catalog No. 30-2005, for OKT8; ATCC® Catalog No. 30-2005), 10 % Fetal Bovine Serum (ATCC® Cat. #30-2020) and 10 ml penicillin- streptomycin (Life Technologies® Cat. # 15140-122) were combined to make the culture medium. The complete medium was filtered through a 0.22µm filter and stored away from light at 4°C until use.

[00493] When perfusing during incubation periods, the culture medium was conditioned continuously with 5% carbon dioxide in air before introduction into the OptoSelect device.

[00494] Table 6. Oligonucleotide sequences for use in the experiment.

SEQ ID No.	Sequence/s	Name
112	5'-Me-isodC//Me-isodG//Me-isodC/ACACTCTTTCCTACACGACGCrGrGrG-3	
113	5'-ACACTCTTTCCT ACACGACGC-3'	
114	GTT ATT GCT AGC GGC TCA GCC GGC AAT GGC GGA KGT RMA GCT TCA GGA GTC	YarivH-FOR 1
115	GTT ATT GCT AGC GGC TCA GCC GGC AAT GGC GGA GGT BCA GCT BCA GCA GTC	YarivH-FOR 2
116	GTT ATT GCT AGC GGC TCA GCC GGC AAT GGC GGA GGT BCA GCT BCA GCA GTC	YarivH-FOR 3
117	GTT ATT GCT AGC GGC TCA GCC GGC AAT GGC GGA GGT CCA RCT GCA ACA RTC	YarivH-FOR 4
118	GTT ATT GCT AGC GGC TCA GCC GGC AAT GGC GCA GGT YCA GCT BCA GCA RTC	YarivH-FOR 5
119	GTT ATT GCT AGC GGC TCA GCC GGC AAT GGC GCA GGT YCA RCT GCA GCA GTC	YarivH-FOR 6
120	GTT ATT GCT AGC GGC TCA GCC GGC AAT GGC GCA GGT CCA CGT GAA GCA GTC	YarivH-FOR 7
121	GTT ATT GCT AGC GGC TCA GCC GGC AAT GGC GGA GGT GAA SST GGT GGA ATC	YarivH-FOR 8
122	GTT ATT GCT AGC GGC TCA GCC GGC AAT GGC GGA VGT GAW GYT GGT GGA GTC	YarivH-FOR 9
123	GTT ATT GCT AGC GGC TCA GCC GGC AAT GGC GGA GGT GCA GSK GGT GGA GTC	YarivH-FOR 10

124	GTT ATT GCT AGC GGC TCA GCC GGC AAT GGC GGA KGT GCA MCT GGT GGA GTC	YarivH-FOR 11
125	GTT ATT GCT AGC GGC TCA GCC GGC AAT GGC GGA GGT GAA GCT GAT GGA RTC	YarivH-FOR 12
126	GTT ATT GCT AGC GGC TCA GCC GGC AAT GGC GGA GGT GCA RCT TGT TGA GTC	YarivH-FOR 13
127	GTT ATT GCT AGC GGC TCA GCC GGC AAT GGC GGA RGT RAA GCT TCT CGA GTC	YarivH-FOR 14
128	GTT ATT GCT AGC GGC TCA GCC GGC AAT GGC GGA AGT GAA RST TGA GGA GTC	YarivH-FOR 15
129	GTT ATT GCT AGC GGC TCA GCC GGC AAT GGC GCA GGT TAC TCT RAA AGW GTS TG	YarivH-FOR 16
130	GTT ATT GCT AGC GGC TCA GCC GGC AAT GGC GCA GGT CCA ACT VCA GCA RCC	YarivH-FOR 17
131	GTT ATT GCT AGC GGC TCA GCC GGC AAT GGC GGA TGT GAA CTT GGA AGT GTC	YarivH-FOR 18
132	GTT ATT GCT AGC GGC TCA GCC GGC AAT GGC GGA GGT GAA GGT CAT CGA GTC	YarivH-FOR 19
133	AGC CGG CCA TGG CGG AYA TCC AGC TGA CTC AGC C	YarivL-FOR1
134	AGC CGG CCA TGG CGG AYA TTG TTC TCW CCC AGT C	YarivL-FOR2
135	AGC CGG CCA TGG CGG AYA TTG TGM TMA CTC AGT C	YarivL-FOR3
136	AGC CGG CCA TGG CGG AYA TTG TGY TRA CAC AGT C	YarivL-FOR4
137	AGC CGG CCA TGG CGG AYA TTG TRA TGA CMC AGT C	YarivL-FOR5
138	AGC CGG CCA TGG CGG AYA TTM AGA TRA MCC AGT C	YarivL-FOR6
139	AGC CGG CCA TGG CGG AYA TTC AGA TGA YDC AGT C	YarivL-FOR7
140	AGC CGG CCA TGG CGG AYA TYC AGA TGA CAC AGA C	YarivL-FOR8
141	AGC CGG CCA TGG CGG AYA TTG TTC TCA WCC AGT C	YarivL-FOR9
142	AGC CGG CCA TGG CGG AYA TTG WGC TSA CCC AAT C	YarivL-FOR10
143	AGC CGG CCA TGG CGG AYA TTS TRA TGA CCC ART C	YarivL-FOR11
144	AGC CGG CCA TGG CGG AYR TTK TGA TGA CCC ARA C	YarivL-FOR12
145	AGC CGG CCA TGG CGG AYA TTG TGA TGA CBC AGK C	YarivL-FOR13
146	AGC CGG CCA TGG CGG AYA TTG TGA TAA CYC AGG A	YarivL-FOR14
147	AGC CGG CCA TGG CGG AYA TTG TGA TGA CCC AGW T	YarivL-FOR15
148	AGC CGG CCA TGG CGG AYA TTG TGA TGA CAC AAC C	YarivL-FOR16

149	AGC CGG CCA TGG CGG AYA TTT TGC TGA CTC AGT C	YarivL-FOR17
150	AGC CGG CCA TGG CGG ARG CTG TTG TGA CTC AGG AAT C	YarivL-FOR 1 Lambda
151	R702_Opt3_R2R1_combo AGATCGGAAGAGCACACGTCTGAACTCCAGTCACC GATGTACACTCTTTCCCTACACGACGCTCTTCCGAT CT	
152	R709_Opt3_R2R1_combo AGATCGGAAGAGCACACGTCTGAACTCCAGTCACG ATCAGACACTCTTTCCCTACACGACGCTCTTCCGAT CT	
153	5'-CAAGCAGAAGACGGCATAACGAGAT-3'	primer sequence directed against 5' end of 1390 (FIG. 13B)
154	P5 section in bold: P5_IG_GEN1-3_a_rv AATGATACGGCGACCACCGAGATCTACACGGATA GACHGATGGGGSTGTGTT	heavy chain
155	P5 section in bold: P5_IG_KappaCon_rv AATGATACGGCGACCACCGAGATCTACACCTGGA TGGTGGGAAGATGGATACAG	light chain

[00495] **Experiment:** A sample of OKT3 cells were introduced into the OptoSelect device at a density of 2E6 in 200 microliters. Approximately 150 of the cells were moved by optically actuated dielectrophoretic force to load one cell per NanoPen chamber. Each cell was positioned within the section of the chamber furthest from the opening to the microfluidic channel (e.g., isolation region). The OptoSelect device was then flushed once with 50 microliters of priming medium. A brightfield image was taken of the OptoSelect device for the purpose of identifying the locations of penned OKT3 cells (not shown). A sample of OKT8 cells were introduced into the OptoSelect device at a density of 2E6 in 200 microliters. Approximately 150 of the cells were moved by optically actuated dielectrophoretic force to load one cell per NanoPen chamber in fields of view in which OKT3 cells were not penned. The OptoSelect device was then flushed once with 50 microliters of priming medium. A brightfield image was taken of the OptoSelect device for the purpose of identifying the locations of penned OKT8 cells (not shown). A sample of barcoded beads having capture oligos as described herein (two exemplary, but not limiting sequences are SEQ ID NOs. 101 and 102, see Table 2) were introduced into the OptoSelect device at a density of 2E6 in 200 microliters. A single uniquely barcoded bead was subsequently loaded into each of the occupied chambers. The total number of beads loaded to the NanoPen chambers having single biological cells was 126, with 57 beads

assigned to OKT3 cells and 69 beads assigned to OKT8 cells, and each bead was also positioned within the portion of each chamber that was not subjected to penetrating fluidic flow. The OptoSelect device was then flushed once with 50 microliters of 1 x DPBS.

5 [00496] Lysis reagent (Single Cell Lysis Kit, Ambion Catalog No. 4458235) was flowed into the microfluidic channel and permitted to diffuse into the NanoPen chambers. The individually penned OKT3 and OKT8 cells were exposed to the lysis buffer for 10 minutes. The OptoSelect device was then flushed once with 30 microliters of 1 x DPBS. Lysis was stopped by flowing in stop lysis buffer (Single Cell Lysis Kit, Ambion Catalog No. 4458235) and incubating for 2 minutes at room temperature while there was no flow in the microfluidic channel. Alternatively, 10 a lysis buffer such as 10x Lysis Buffer, Catalog No. 635013, Clontech/Takara can be used to provide similar results, with the advantage of not requiring the use of a stop lysis buffer. The OptoSelect device was then flushed once with 30 microliters of 1 x DPBS. Under the conditions used, the nuclear membrane was not disrupted. The released mRNA was captured onto the barcoded bead present within the same NanoPen chamber.

15 [00497] The captured RNA was reverse transcribed to cDNA by flowing in a RT reagent mixture (Thermo Scientific™ Maxima™ H Minus RT (Thermofisher, Catalog No. EP0751)) and template switching oligonucleotide (SEQ ID NO.112). Diffusion of the enzyme into the NanoPen Chamber was permitted during a 20 minute period at 16°C, followed by a reaction period of 90 minutes at 42°C. After reverse transcription, the OptoSelect device was then 20 flushed once with 30 microliters of 1 x DPBS.

[00498] The unique barcode was then identified for each capture bead by multiplexed flows of fluorescently labeled hybridization probes as described herein. Successive reagent flows of each set of fluorescently labeled probes were flowed into the microfluidic channel of the microfluidic device at 1 micromolar diluted in 1 x DPBS (alternatively, IDT Duplex buffer may be used), and 25 permitted to diffuse into the NanoPen chambers. After hybridization background signal was removed by flushing the OptoSelect device with 150 microliters of 1x DPBS. The location of each Cell Barcode so identified (e.g., NanoPen location of the bead labeled with that Cell Barcode) was recorded and was used to identify from which specific cell the BCR sequence was captured to the bead. In Figures 31A and 31B, the images and results are shown for the barcode 30 detection for two individual NanoPen chambers, 3441 and 1451. The barcode for NanoPen chamber 3441 was determined to be C3D11F22T31, where the barcode was formed from four cassetteable sequences GAATACGGGG (SEQ ID NO. 3) TTCCTCTCGT (SEQ ID NO. 11) AACATCCCTC (SEQ ID NO. 22) CCGCACTTCT (SEQ ID NO. 31). The barcode for NanoPen chamber 1451 was determined to be C1D11F24T31, where the barcode was formed

from four cassette sequences CAGCCTTCTG (SEQ ID NO. 1) TTCCTCTCGT (SEQ ID NO. 11) TTAGCGCGTC (SEQ ID NO. 24) CCGCACTTCT (SEQ ID NO. 31)

[00499] After detection, the chip was washed twice with 10 mM Tris-HCl (200 microliters at 0.5 microliters/sec), prior to export of cDNA decorated capture beads.

5 [00500] Optically actuated dielectrophoretic force was used to export selected barcoded cDNA decorated beads from the NanoPen chambers in a displacement buffer, 10 mM Tris-HCl. One export contained 47 beads from OKT3 assigned wells and 69 beads from OKT8 assigned wells. The beads that had been exported from the NanoPen chambers were subsequently exported out of the microfluidic device using flow and pooled.

10 [00501] After treatment with Exonuclease I (NEB, catalog no. M0293L), the export group of beads was subjected to 22 cycles of DNA amplification (Advantage® 2 PCR kit, Clontech, Catalog #. 639206) using as a primer 5'-ACACTCTTTCCT ACACGACGC-3' (SEQ ID NO. 113). Initial purification of the crude amplification mixture for the export group was performed using 1x SPRI (Solid Phase Reversible Immobilization) beads (Agencourt AMPure XP beads
15 (Beckman Coulter, catalog no. A63881)) according to supplier instructions.

[00502] The crude amplification mixture was then split in two, where the first of the two portions was subject to 18 cycles of PCR with a mixture of BCR specific forward primers for heavy chain (SEQ ID NOs 114-132, Table 6) and where the second portion was subjected to 18 cycles of PCR with a mixture of BCR specific forward primers for light chain (SEQ ID NOs
20 133-150, Table 6) (Q5® High-Fidelity DNA polymerase, NEB, catalog no. M0491S). Reverse primers (SEQ ID Nos. 151 and 152) added priming sequences with an index assigned to the export group of beads and heavy or light chain. A touchdown PCR protocol (where the annealing temperature is decreased in successive cycles) was used to increase amplification specificity. Initial purification of the BCR sequence containing amplicons was performed using
25 1x SPRI (Solid Phase Reversible Immobilization) beads (Agencourt AMPure XP beads (Beckman Coulter, catalog no. A63881)) according to supplier instructions and subsequently selected by size on a 2 % Agarose gel (E-gel™ EX Agarose Gels 2%, Catalog no. G401002, ThermoFisher Scientific). Gel extraction was performed according to supplier instructions (Zymoclean™ Gel DNA Recovery Kit, catalog no. D4001, Zymo Research).

30 [00503] Purified and size-selected BCR sequence containing amplicons were treated with T4 polynucleotide kinase (T4 polynucleotide kinase, NEB, catalog no. M0201) then the reaction was purified with using 1x SPRI (Solid Phase Reversible Immobilization) beads (Agencourt AMPure XP beads (Beckman Coulter, catalog no. A63881)) according to supplier instructions. Quantification was performed fluorescently (Qubit™, ThermoFisher Scientific).

[00504] Purified T4 polynucleotide kinase-treated BCR sequence containing amplicons using less than or equal to 10 ng of the BCR amplicons were then self-ligated to create circularized DNA molecules (T4 DNA Ligase, Catalog no. EL0011, ThermoFisher Scientific). Any amount of DNA over the limit of detection, roughly about 0.5 ng will be sufficient to the circularization reaction. Not exceeding about 10 ng is useful to drive to self circularization rather than cross-ligating to another molecule of amplicon.

[00505] The ligation reaction was purified with using 1x SPRI (Solid Phase Reversible Immobilization) beads (Agencourt AMPure XP beads (Beckman Coulter, catalog no. A63881) according to supplier instructions and the circularized DNA molecules subsequently selected by position on a 2 % Agarose gel (E-gel™ EX Agarose Gels 2%, Catalog no. G401002, ThermoFisher Scientific). Gel extraction was performed according to supplier instructions (Zymoclean™ Gel DNA Recovery Kit, catalog no. D4001, Zymo Research).

[00506] Purified circularized DNA molecules were then re-linearized by performing a NotI restriction enzyme digest (NotI-HF, NEB, Catalog no. R3189S) according to manufacturer's directions, and subsequently inactivating the reaction. The re-linearized DNA was purified using 1x SPRI (Solid Phase Reversible Immobilization) beads (Agencourt AMPure XP beads (Beckman Coulter, catalog no. A63881) according to supplier instructions.

[00507] The re-linearized DNA was subject to PCR 16 cycles with a P7 adaptor sequence forward primer (SEQ ID NO. 153, Table 6) and a BCR constant region primer (SEQ ID NO. 154, Table 6) containing the P5 adaptor sequence (KAPA HiFi HotStart ReadyMix, KK2601, KAPA Biosystems/Roche). The amplified DNA molecule was purified using 1 x SPRI (Solid Phase Reversible Immobilization) beads (Agencourt AMPure XP beads (Beckman Coulter, Catalog # A63881) according to supplier instructions. The amplified DNA product was then subject to PCR, 7 cycles for heavy chain and 6 cycles for light chain, with P7 and P5 adaptor sequence primers (SEQ ID NOs. 153 and 155, Table 6) (KAPA HiFi HotStart ReadyMix, KK2601, KAPA Biosystems/Roche). The resulting sequencing library was purified using 1 x SPRI (Solid Phase Reversible Immobilization) beads (Agencourt AMPure XP beads (Beckman Coulter, catalog no. A63881) according to supplier instructions and subsequently selected by size (550-750 bp) on a 2 % Agarose gel (E-gel™ EX Agarose Gels 2%, Catalog no. G401002, ThermoFisher Scientific). Gel extraction was performed according to supplier instructions (Zymoclean™ Gel DNA Recovery Kit, catalog no. D4001, Zymo Research).

[00508] Quantification of the purified sequencing library was performed fluorescently (Qubit™, ThermoFisher Scientific). Sequencing was performed using a MiSeq Sequencer (Illumina®, Inc.).

[00509] Sequencing results were de-plexed to generate FASTQ files of sequence data separate for each pool (including heavy or light chain) via the index included in the read 1 and read 2 primer, and for each cell as identified by the unique barcode sequence. Known CDR3 BCR sequences, containing a critical sub-region, directed to antigen binding sites, of the variable region for the OKT3 and OKT8 cell lines were aligned to the read data for each cell and used to identify the reads as coming from either OKT3 or OKT8 cells. The right hand column within Figure 32 shows that reads from cells 1-8 matched OKT3 sequence identity (SEQ ID NO. 157, Table 6), having a CDR3 sequence of:

TGTGCAAGATATTATGATGATCATTACTGCCTTGACTACTGG (SEQ ID NO.156).

10 [00510] Reads from cells 9-12 matched OKT8 sequence identity (SEQ ID 159, having a CDR2 sequence of:

TGTGGTAGAGGTTATGGTTACTACGTATTTGACCACTGG (SEQ ID No. 158).

[00511] The barcodes for each cell was also determined by sequencing and is shown for each of cells 1-12. Matching the barcodes determined by sequencing to the barcodes determined by the reagent flow methods described above, permitted unequivocal correlation between cell and genome. For example, the barcode determined above for NanoPen chamber 1451 via flow reagent matched to Cell 1, having a CDR3 sequence matching the phenotype for OKT3 cells. The other barcode described above, for NanoPen 3441, matched the barcode for Cell 9, having a CDR3 sequence matching the phenotype for OKT8. As this was a proof of principle experiment, it was known which type of cell was disposed within a specific NanoPen chamber, and the sequencing results showed that the barcode flow reagent detection tied perfectly to the barcode determined by sequencing and with the expected CDR3 sequence. This demonstrated that BCR sequence data was linkable to the physical location of the source cell.

[00512] In addition to any previously indicated modification, numerous other variations and alternative arrangements may be devised by those skilled in the art without departing from the spirit and scope of this description, and appended claims are intended to cover such modifications and arrangements. Thus, while the information has been described above with particularity and detail in connection with what is presently deemed to be the most practical and preferred aspects, it will be apparent to those of ordinary skill in the art that numerous modifications, including, but not limited to, form, function, manner of operation, and use may be made without departing from the principles and concepts set forth herein. Also, as used herein, the examples and embodiments, in all respects, are meant to be illustrative only and should not be construed to be limiting in any manner. Furthermore, where reference is made herein to a list of elements (*e.g.*, elements a, b, c), such reference is intended to include any one of the listed

elements by itself, any combination of less than all of the listed elements, and/or a combination of all of the listed elements. Also, as used herein, the terms a, an, and one may each be interchangeable with the terms at least one and one or more. It should also be noted, that while the term step is used herein, that term may be used to simply draw attention to different portions of the described methods and is not meant to delineate a starting point or a stopping point for any portion of the methods, or to be limiting in any other way.

EXEMPLARY EMBODIMENTS

[00513] Exemplary embodiments provided in accordance with the presently disclosed subject matter include, but are not limited to, the claims and the following embodiments:

10 [00514] 1. A capture object comprising a plurality of capture oligonucleotides, wherein each capture oligonucleotide of said plurality comprises:

a priming sequence;

a capture sequence; and

15 a barcode sequence comprising three or more cassetable oligonucleotide sequences, each cassetable oligonucleotide sequence being non-identical to the other cassetable oligonucleotide sequences of said barcode sequence.

[00515] 2. The capture object of embodiment 1, wherein each capture oligonucleotide of said plurality comprises the same barcode sequence.

20 [00516] 3. The capture object of embodiment 1 or 2, wherein each capture oligonucleotide of said plurality comprises a 5'-most nucleotide and a 3'-most nucleotide,

wherein said priming sequence is adjacent to or comprises said 5'-most nucleotide,

wherein said capture sequence is adjacent to or comprises said 3'-most nucleotide, and

wherein said barcode sequence is located 3' to said priming sequence and 5' to said capture sequence.

25 [00517] 4. The capture object of any one of embodiments 1 to 3, wherein each of said three or more cassetable oligonucleotide sequences comprises 6 to 15 nucleotides.

[00518] 5. The capture object of any one of embodiments 1 to 4, wherein each of said three or more cassetable oligonucleotide sequences comprises 10 nucleotides.

30 [00519] 6. The capture object of any one of embodiments 1 to 5, wherein the three or more cassetable oligonucleotide sequences of said barcode sequence are linked in tandem without any intervening oligonucleotide sequences.

- [00520] 7. The capture object of any one of embodiments 1 to 6, wherein each of said three or more cassette oligonucleotide sequences of said barcode sequence is selected from a plurality of 12 to 100 cassette oligonucleotide sequences.
- [00521] 8. The capture object of any one of embodiments 1 to 7, wherein each of said three or more cassette oligonucleotide sequences of said barcode sequence has a sequence of any one of SEQ ID NOs: 1-40.
- [00522] 9. The capture object of any one of embodiments 1 to 8, wherein said barcode sequence comprises four cassette oligonucleotide sequences.
- [00523] 10. The capture object of embodiment 9, wherein a first cassette oligonucleotide sequence has a sequence of any one of SEQ ID NOs: 1-10; a second cassette oligonucleotide sequence has a sequence of any one of SEQ ID NOs: 11-20; a third cassette oligonucleotide sequence has a sequence of any one of SEQ ID NOs: 21-30; and a fourth cassette oligonucleotide sequence has a sequence of any one of SEQ ID NOs: 31-40.
- [00524] 11. The capture object of any one of embodiments 1 to 10, wherein said priming sequence, when separated from said capture oligonucleotide, primes a polymerase.
- [00525] 12. The capture object of embodiment 11, wherein said priming sequence comprises a sequence of a P7 or P5 primer.
- [00526] 13. The capture object of any one of embodiments 1 to 12, wherein each capture oligonucleotide of said plurality further comprises a unique molecule identifier (UMI) sequence.
- [00527] 14. The capture object of embodiment 13, wherein each capture oligonucleotide of said plurality comprises a different UMI sequence.
- [00528] 15. The capture object of embodiment 13 or 14, wherein said UMI is located 3' to said priming sequence and 5' to said capture sequence.
- [00529] 16. The capture object of any one of embodiments 13 to 15, wherein said UMI sequence is an oligonucleotide sequence comprising 5 to 20 nucleotides.
- [00530] 17. The capture object of any one of embodiments 13 to 15, wherein said oligonucleotide sequence of said UMI comprises 10 nucleotides.
- [00531] 18. The capture object of any one of embodiments 1 to 17, wherein each capture oligonucleotide further comprises a NotI restriction site sequence.
- [00532] 19. The capture object of embodiment 18, wherein said NotI restriction site sequence is located 5' to said capture sequence.
- [00533] 20. The capture object of embodiment 18 or 19, wherein said NotI restriction site sequence is located 3' to said barcode sequence.

- [00534] 21. The capture object of any one of embodiments 1 to 20, wherein each capture oligonucleotide further comprises one or more adapter sequences.
- [00535] 22. The capture object of any one of embodiments 1 to 19, wherein said capture sequence comprises a poly-dT sequence, a random hexamer sequence, or a mosaic end
5 sequence.
- [00536] 23. A plurality of capture objects, wherein each capture object of said plurality is a capture object according to any one of embodiments 1 to 22, wherein, for each capture object of said plurality, each capture oligonucleotide of said capture object comprises the same barcode sequence, and wherein the barcode sequence of the capture oligonucleotides of each capture
10 object of said plurality is different from the barcode sequence of the capture oligonucleotides of every other capture object of said plurality.
- [00537] 24. The plurality of capture objects of embodiment 23, wherein said plurality comprises at least 256 capture objects.
- [00538] 25. The plurality of capture objects of embodiment 23, wherein said plurality
15 comprises at least 10,000 capture objects.
- [00539] 26. A cassetable oligonucleotide sequence comprising an oligonucleotide sequence that comprises a sequence of any one of SEQ ID NOs: 1 to 40.
- [00540] 27. A barcode sequence comprising three or more cassetable oligonucleotide sequences, wherein each of said three or more cassetable oligonucleotides sequences of said
20 barcode sequence has a sequence of any one of SEQ ID NOs: 1-40, and wherein each cassetable oligonucleotide sequence of said barcode sequence is non-identical to the other cassetable oligonucleotide sequences of said barcode sequence.
- [00541] 28. The barcode sequence of embodiment 27 comprising three or four cassetable oligonucleotide sequences.
- [00542] 29. The barcode sequence of embodiment 27 or 28, wherein said three or more
25 cassetable oligonucleotide sequences are linked in tandem without any intervening oligonucleotide sequences.
- [00543] 30. A set of barcode sequences comprising at least 64 non-identical barcode sequences, each barcode sequence of said set having a structure according to any one of
30 embodiments 27 to 29.
- [00544] 31. The set of barcode sequences of embodiment 30, wherein the set consists essentially of 64, 81, 100, 125, 216, 256, 343, 512, 625, 729, 1000, 1296, 2401, 4096, 6561, or 10,000 barcode sequences.

[00545] 32. A hybridization probe comprising: an oligonucleotide sequence comprising a sequence of any one of SEQ ID NOs: 41 to 80; and a fluorescent label.

[00546] 33. A reagent comprising a plurality of hybridization probes, wherein each hybridization probe of said plurality is a hybridization probe according to embodiment 32, and
5 wherein each hybridization probe of said plurality (i) comprises an oligonucleotide sequence which is different from the oligonucleotide sequence of every other hybridization probe of the plurality and (ii) comprises a fluorescent label which is spectrally distinguishable from the fluorescent label of every other hybridization probe of the plurality.

[00547] 34. The reagent of embodiment 33, wherein the plurality of hybridization probes
10 consists of two to four hybridization probes.

[00548] 35. The reagent of embodiment 33 or 34, wherein: a first hybridization probe of the plurality comprises a sequence selected from a first subset of SEQ ID NOs: 41-80, and a first fluorescent label;
a second hybridization probe of the plurality comprises a sequence selected from a second subset
15 of SEQ ID NOs: 41-80, and a second fluorescent label which is spectrally distinguishable from said first fluorescent label, wherein the first and second subsets of SEQ ID NOs: 41-80 are non-overlapping subsets.

[00549] 36. The reagent of embodiment 35, wherein: a third hybridization probe of the plurality comprises a sequence selected from a third subset of SEQ ID NOs: 41-80, and a third
20 fluorescent label which is spectrally distinguishable from each of said first and second fluorescent labels, wherein the first, second, and third subsets of SEQ ID NOs: 41-80 are non-overlapping subsets.

[00550] 37. The reagent of embodiment 36, wherein: a fourth hybridization probe of the plurality comprises a sequence selected from a fourth subset of SEQ ID NOs: 41-80, and a
25 fourth fluorescent label which is spectrally distinguishable from each of said first, second, and third fluorescent labels, wherein the first, second, third, and fourth subsets of SEQ ID NOs: 41-80 are non-overlapping subsets.

[00551] 38. The reagent of any one of embodiments 35 to 37, wherein each subset of SEQ ID NOs: 41-80 comprises at least 10 sequences.

[00552] 39. The reagent of any one of embodiments 35 to 37, wherein said first subset contains SEQ ID NOs: 41-50, wherein said second subset contains SEQ ID NOs: 51-60, wherein said third subset contains SEQ ID NOs: 61-70, and wherein said fourth subset contains SEQ ID
30 NOs: 71-80.

[00553] 40. A kit comprising a plurality of reagents according to any one of embodiments 33 to 39, wherein the plurality of hybridization probes of each reagent forms a set that is non-overlapping with the set of hybridization probes of every other reagent in the plurality.

[00554] 41. The kit of embodiment 40, wherein the kit comprises 3, 4, 5, 6, 7, 8, 9, or 10 said reagents.

[00555] 42. A method of in-situ identification of one or more capture objects within a microfluidic device, the method comprising:

disposing a single capture object of said one or more capture objects into each of one or more sequestration pens located within an enclosure of said microfluidic device, wherein each capture object comprises a plurality of capture oligonucleotides, and wherein each capture oligonucleotide of said plurality comprises:

a priming sequence;

a capture sequence; and

a barcode sequence, wherein said barcode sequence comprises three or more cassette

oligonucleotide sequences, each cassette oligonucleotide sequence being non-identical to the other cassette oligonucleotide sequences of said barcode sequence;

flowing a first reagent solution comprising a first set of hybridization probes into a flow region within said enclosure of said microfluidic device, wherein said flow region is fluidically connected to each of said one or more sequestration pens, and wherein each hybridization probe of said first set comprises:

an oligonucleotide sequence complementary to a cassette oligonucleotide sequence comprised by any of said barcode sequences of any of said capture oligonucleotides of any of said one or more capture objects, wherein said complementary oligonucleotide sequence of each hybridization probe in the first set is non-identical to every other complementary oligonucleotide sequence of said hybridization probes in said first set; and

a fluorescent label selected from a set of spectrally distinguishable fluorescent labels, wherein the fluorescent label of each hybridization probe in said first set is different from the fluorescent label of every other hybridization probe in said first set of hybridization probes;

hybridizing said hybridization probes of said first set to corresponding cassette oligo-

nucleotide sequences in any of said barcode sequences of any of said capture oligonucleotides of any of said one or more capture objects;

detecting, for each hybridization probe of said first set of hybridization probes, a corresponding fluorescent signal associated with any of said one or more capture objects; and

generating a record, for each capture object disposed within one of said one or more sequestration pens, comprising (i) a location of the sequestration pen within said enclosure of said microfluidic device, and (ii) an association or non-association of said corresponding fluorescent signal of each hybridization probe of said first set of hybridization probes with said capture object, wherein said record of associations and non-associations constitute a barcode which links said capture object with said sequestration pen.

[00556] 43. The method of embodiment 42 further comprising:

flowing an n^{th} reagent solution comprising an n^{th} set of hybridization probes into said flow region of said microfluidic device, wherein each hybridization probe of said n^{th} set comprises:
an oligonucleotide sequence complementary to a cassette oligonucleotide sequence comprised by any of said barcode sequences of any of said capture oligonucleotides of any of said one or more capture objects, wherein said complementary oligonucleotide sequence of each hybridization probe in the n^{th} set is non-identical to every other complementary oligonucleotide sequence of said hybridization probes in said n^{th} set and any other set of hybridization probes flowed into said flow region of said microfluidic device; and
a fluorescent label selected from a set of spectrally distinguishable fluorescent labels, wherein the fluorescent label of each hybridization probe in said n^{th} set is different from the fluorescent label of every other hybridization probe in said n^{th} set of hybridization probes;
hybridizing said hybridization probes of said n^{th} set to corresponding cassette oligo-nucleotide sequences in any of said barcode sequences of any of said capture oligonucleotides of any of said one or more capture objects;
detecting, for each hybridization probe of said n^{th} set of hybridization probes, a corresponding fluorescent signal associated with any of said one or more capture objects; and
supplementing said record, for each capture object disposed within one of said one or more sequestration pens, with an association or non-association of said corresponding fluorescent signal of each hybridization probe of said n^{th} set of hybridization probes with said capture object, wherein n is a set of positive integers having values of $\{2, \dots, m\}$, wherein m is a positive integer having a value of 2 or greater, and wherein the foregoing steps of flowing said n^{th} reagent, hybridizing said n^{th} set of hybridization probes, detecting said corresponding fluorescent signals, and supplements said records are repeated for each value of n in said set of positive integers.

[00557] 44. The method of embodiment 43, wherein m has a value greater than or equal to 3 and less than or equal to 20 (e.g., greater than or equal to 5 and less than or equal to 15).

[00558] 45. The method of embodiment 43, wherein m has a value greater than or equal to 8 and less than or equal to 12 (e.g., 10).

[00559] 46. The method of any one of embodiments 43 to 45, wherein flowing said first reagent solution and/or said n^{th} reagent solution into said flow region further comprises
5 permitting said first reagent solution and/or said n^{th} reagent solution to equilibrate by diffusion into said one or more sequestration pens.

[00560] 47. The method of any one of embodiments 43 to 45, wherein detecting said corresponding fluorescent signal associated with any of said one or more capture objects further comprises:
10 flowing a rinsing solution having no hybridization probes through said flow region of said microfluidic device;
equilibrating by diffusion said rinsing solution into said one or more sequestration pens, thereby allowing unhybridized hybridization probes of said first set or any of said n^{th} sets to diffuse out of said one or more sequestration pens; and further wherein said flowing said rinsing solution is
15 performed before detecting said fluorescent signal.

[00561] 48. The method of any one of embodiments 43 to 47, wherein each barcode sequence of each capture oligonucleotide of each capture object comprises three cassette oligonucleotide sequences.

[00562] 49. The method of embodiment 48, wherein said first set of hybridization probes and
20 each of said n^{th} sets of hybridization probes comprise three hybridization probes.

[00563] 50. The method of any one of embodiments 43 to 47, wherein each barcode sequence of each capture oligonucleotide of each capture object comprises four cassette oligonucleotide sequences.

[00564] 51. The method of embodiment 50, wherein said first set of hybridization probes and
25 each of said n^{th} sets of hybridization probes comprise four hybridization probes.

[00565] 52. The method of any one of embodiments 42 to 51, wherein disposing each of said one or more capture objects comprises disposing each of said one or more capture objects within an isolation region of said one or more sequestration pens within said microfluidic device.

[00566] 53. The method of any one of embodiments 42 to 52, further comprising disposing
30 one or more biological cells within said one or more sequestration pens of said microfluidic device.

[00567] 54. The method of embodiment 53, wherein each one of said one or more biological cells are disposed in a different one of said one or more sequestration pens.

[00568] 55. The method of embodiment 53 or 54, wherein said one or more biological cells are disposed within said isolation regions of said one or more sequestration pens of said microfluidic device.

[00569] 56. The method of any one of embodiments 53 to 55, wherein at least one of the one or more biological cells is disposed within a sequestration pen having one of said one or more capture objects disposed therein.

[00570] 57. The method of any one of embodiments 53 to 56, wherein the one or more biological cells is a plurality of biological cells from a clonal population.

[00571] 58. The method of any one of embodiments 53 to 57, wherein disposing said one or more biological cells is performed before disposing said one or more capture objects.

[00572] 59. The method of any one of embodiments 42 to 58, wherein said enclosure of said microfluidic device further comprises a dielectrophoretic (DEP) configuration, and wherein disposing said one or more capture objects into one or more sequestration pens is performed using dielectrophoretic (DEP) force.

[00573] 60. The method of any one of embodiments 53 to 59, wherein said enclosure of said microfluidic device further comprises a dielectrophoretic (DEP) configuration, and said disposing said one or more biological cells within said one or more sequestration pens is performed using dielectrophoretic (DEP) forces.

[00574] 61. The method of any one of embodiments 42 to 60, wherein said one or more capture objects are capture objects according to any one of embodiments 1 to 25.

[00575] 62. The method of any one of embodiments 42 to 61, wherein at least one of said plurality of capture oligonucleotides of each capture object further comprises a target nucleic acid captured thereto by said capture sequence.

[00576] 63. A method of correlating genomic data with a biological cell in a microfluidic device, comprising:
disposing a capture object into a sequestration pen of a microfluidic device, wherein said capture object comprises a plurality of capture oligonucleotides, wherein each capture oligonucleotide of said plurality comprises:
a priming sequence;
a capture sequence; and
a barcode sequence, wherein said barcode sequence comprises three or more cassetable oligonucleotide sequences, each cassetable oligonucleotide sequence being non-identical to the other cassetable oligonucleotide sequences of said barcode sequence; and
wherein each capture oligonucleotide of said plurality comprises the same barcode sequence;

identifying said barcode sequence of said plurality of capture oligonucleotides in-situ and recording an association between said identified barcode sequence and said sequestration pen; disposing said biological cell into said sequestration pen; lysing said biological cell and allowing nucleic acids released from said lysed biological cell to be captured by said plurality of capture oligonucleotides comprised by said capture object; transcribing said captured nucleic acids, thereby producing a plurality of transcribed nucleic acids, each transcribed nucleic acid comprising a complementary captured nucleic acid sequence covalently linked to one of said capture oligonucleotides; sequencing said transcribed nucleic acids and said barcode sequence, thereby obtaining read sequences of said plurality of transcribed nucleic acids associated with read sequences of said barcode sequence; identifying said barcode sequence based upon said read sequences; and using said read sequence-identified barcode sequence and said in situ-identified barcode sequence to link said read sequences of said plurality of transcribed nucleic acids with said sequestration pen and thereby correlate said read sequences of said plurality of transcribed nucleic acids with said biological cell placed into said sequestration pen.

[00577] 64. The method of embodiment 63, further comprising: observing a phenotype of said biological cell; and correlating said read sequences of said plurality of transcribed nucleic acids with said phenotype of said biological cell.

[00578] 65. The method of embodiment 63, further comprising: observing a phenotype of said biological cell, wherein said biological cell is a representative of a clonal population; and correlating said read sequences of said plurality of transcribed nucleic acids with said phenotype of said biological cell and said clonal population.

[00579] 66. The method of embodiment 64 or 65, wherein observing said phenotype of said biological cell comprises observing at least one physical characteristic of said at least one biological cell.

[00580] 67. The method of embodiment 64 or 65, wherein observing said phenotype of said biological cell comprises performing an assay on said biological cell and observing a detectable signal generated during said assay.

[00581] 68. The method of embodiment 67, wherein said assay is a protein expression assay.

[00582] 69. The method of any one of embodiments 63 to 68, wherein identifying said barcode sequence of said plurality of capture oligonucleotides in-situ and recording an association between said identified barcode sequence and said sequestration pen is performed before disposing said biological cell into said sequestration pen.

[00583] 70. The method of any one of embodiments 63 to 68, wherein identifying said barcode sequence of said plurality of capture oligonucleotides in-situ and recording an association between said identified barcode sequence and said sequestration pen is performed after introducing said biological cell into said sequestration pen.

5 [00584] 71. The method of any one of embodiments 64 to 68, wherein disposing said capture object and, identifying said barcode sequence of said plurality of capture oligonucleotides in-situ and recording an association between said identified barcode sequence and said sequestration pen are performed after observing a phenotype of said biological cell.

10 [00585] 72. The method of any one of embodiments 63 to 68, wherein identifying said barcode sequence of said plurality of capture oligonucleotides in-situ and recording an association between said identified barcode sequence and said sequestration pen is performed after lysing said biological cell and allowing said nucleic acids released from said lysed biological cell to be captured by said plurality of capture oligonucleotides comprised by said capture object.

15 [00586] 73. The method of any one of embodiments 63 to 72, wherein identifying said barcode sequence of said plurality of capture oligonucleotide in-situ comprises performing the method of any one of embodiments 42 to 60.

[00587] 74. The method of any one of embodiments 63 to 73, wherein said capture object is a capture object of any one of embodiments 1-23.

20 [00588] 75. The method of any one of embodiments 63 to 74, wherein said enclosure of said microfluidic device comprises a dielectrophoretic (DEP) configuration, and wherein disposing said capture object into said sequestration pen comprises using dielectrophoretic (DEP) forces to move said capture object.

25 [00589] 76. The method of any one of embodiments 63 to 75, wherein said enclosure of said microfluidic device further comprises a dielectrophoretic (DEP) configuration, and wherein disposing said biological cell within said sequestration pen comprises using dielectrophoretic (DEP) forces to move said biological cell.

30 [00590] 77. The method of any one of embodiments 63 to 76 further comprising: disposing a plurality of capture objects into a corresponding plurality of sequestration pens of said microfluidic device;
disposing a plurality of biological cells into said corresponding plurality of sequestration pens,
and,
processing each of said plurality of capture objects and plurality of biological cells according to said additional steps of said method.

[00591] 78. A kit for producing a nucleic acid library, comprising:

a microfluidic device comprising an enclosure, wherein said enclosure comprises a flow region and a plurality of sequestration pens opening off of said flow region; and

a plurality of capture objects, wherein each capture object of said plurality comprises a plurality
5 of capture oligonucleotides, each capture oligonucleotide of said plurality comprising:

a capture sequence; and

a barcode sequence comprising at least three cassetable oligonucleotide sequences, wherein each
casetable oligonucleotide sequence of said barcode sequence is non-identical to the other
casetable oligonucleotide sequences of said barcode sequence, and wherein each capture
10 oligonucleotide of said plurality comprises the same barcode sequence.

[00592] 79. The kit of embodiment 78, wherein said enclosure of said microfluidic device
further comprises a dielectrophoretic (DEP) configuration.

[00593] 80. The kit of embodiment 78 or 79, wherein said plurality of capture objects is a
plurality of capture objects according to any one of embodiments 23 to 25.

15 [00594] 81. The kit of any one of embodiments 78 to 80, wherein each of said plurality of
capture objects is disposed singly into corresponding sequestration pens of plurality.

[00595] 82. The kit of embodiment 81, further comprising an identification table, wherein said
identification table correlates said barcode sequence of said plurality of capture oligonucleotides
of each of said plurality of capture objects with said corresponding sequestration pens of said
20 plurality.

[00596] 83. The kit of any one of embodiments 78 to 82 further comprising: a plurality of
hybridization probes, each hybridization probe comprising:

an oligonucleotide sequence complementary to any one of said cassetable oligonucleotide
sequences of said plurality of capture oligonucleotides of any one of said plurality of capture
25 objects; and

a label, wherein said complementary sequence of each hybridization probe of said plurality is
complementary to a different cassetable oligonucleotide sequence; and

wherein said label of each hybridization probe of said plurality is selected from a set of spectrally
distinguishable labels.

30 [00597] 84. The kit of embodiment 83, wherein each complementary sequence of a
hybridization probe of said plurality comprises an oligonucleotide sequence comprising a
sequence of any one of SEQ ID NOs: 41 to 80.

[00598] 85. The kit of embodiment 83 or 84, said label is a fluorescent label.

- [00599] 86. A method of providing a barcoded cDNA library from a biological cell, comprising:
- disposing said biological cell within a sequestration pen located within an enclosure of a microfluidic device;
- 5 disposing a capture object within said sequestration pen, wherein said capture object comprises a plurality of capture oligonucleotides, each capture oligonucleotide of said plurality comprising:
- a priming sequence that binds a primer;
- a capture sequence; and
- a barcode sequence, wherein said barcode sequence comprises three or more cassetable
- 10 oligonucleotide sequences, each cassetteable oligonucleotide sequence being non-identical to every other cassetteable oligonucleotide sequences of said barcode sequence;
- lysing said biological cell and allowing nucleic acids released from said lysed biological cell to be captured by said plurality of capture oligonucleotides comprised by said capture object; and
- transcribing said captured nucleic acids, thereby producing a plurality of barcoded cDNAs
- 15 decorating said capture object, each barcoded cDNA comprising (i) an oligonucleotide sequence complementary to a corresponding one of said captured nucleic acids, covalently linked to (ii) one of said plurality of capture oligonucleotides.
- [00600] 87. The method of embodiment 86, wherein said biological cell is an immune cell.
- [00601] 88. The method of embodiment 86, wherein said biological cell is a cancer cell.
- 20 [00602] 89. The method of embodiment 86, wherein said biological cell is a stem cell or progenitor cell.
- [00603] 90. The method of embodiment 86, wherein said biological cell is an embryo.
- [00604] 91. The method of any one of embodiments 86 to 90, wherein said biological cell is a single biological cell.
- 25 [00605] 92. The method of any one of embodiments 86 to 91, wherein said disposing said biological cell further comprises marking said biological cell.
- [00606] 93. The method of any one of embodiments 86 to 92, wherein said capture object is a capture object according to any one of embodiments 1 to 22.
- [00607] 94. The method of any one of embodiments 86 to 93, wherein said capture sequence
- 30 of one or more of said plurality of capture oligonucleotides comprises an oligo-dT primer sequence.
- [00608] 95. The method of any one of embodiments 86 to 93, wherein said capture sequence of one or more of said plurality of capture oligonucleotides comprises a gene-specific primer sequence.

- [00609] 96. The method of embodiment 95, wherein said gene-specific primer sequence targets an mRNA sequence encoding a T cell receptor (TCR).
- [00610] 97. The method of embodiment 95, wherein said gene-specific primer sequence targets an mRNA sequence encoding a B-cell receptor (BCR).
- 5 [00611] 98. The method of any one of embodiments 86 to 97, wherein said capture sequence of one or more of said plurality of capture oligonucleotides binds to one of said released nucleic acids and primes said released nucleic acid, thereby allowing a polymerase to transcribe said captured nucleic acids.
- [00612] 99. The method of any one of embodiments 86 to 98, wherein said capture object
10 comprises a magnetic component.
- [00613] 100. The method of any one of embodiments 86 to 99, wherein disposing said biological cell within said sequestration pen is performed before disposing said capture object within said sequestration pen.
- [00614] 101. The method of any one of embodiments 86 to 99, wherein disposing said capture
15 object within said sequestration pen is performed before disposing said biological cell within said sequestration pen.
- [00615] 102. The method of any one of embodiments 86 to 101 further comprising: identifying said barcode sequence of said plurality of capture oligonucleotides of said capture object in situ, while said capture object is located within said sequestration pen.
- 20 [00616] 103. The method of embodiment 102, wherein said identifying said barcode is performed using a method of any one of embodiments 42 to 62.
- [00617] 104. The method of embodiment 102 or 103, wherein identifying said barcode sequence is performed before lysing said biological cell.
- [00618] 105. The method of any one of embodiments 86 to 104, wherein said enclosure of said
25 microfluidic device comprises at least one coated surface.
- [00619] 106. The method of embodiment 105, wherein said at least one coated surface comprises a covalently linked surface.
- [00620] 107. The method of embodiment 105 or 106, wherein said at least one coated surface comprises a hydrophilic or a negatively charged coated surface.
- 30 [00621] 108. The method of any one of embodiments 86 to 107, wherein said enclosure of said microfluidic device further comprises a dielectrophoretic (DEP) configuration, and wherein disposing said biological cell and/or disposing said capture object is performed by applying a dielectrophoretic (DEP) force on or proximal to said biological cell and/or said capture object.

- [00622] 109. The method of any one of embodiments 86 to 108, wherein said microfluidic device further comprises a plurality of sequestration pens.
- [00623] 110. The method of embodiment 109 further comprising: disposing a plurality of said biological cells within said plurality of sequestration pens.
- 5 [00624] 111. The method of embodiment 110, wherein said plurality of said biological cells is a clonal population.
- [00625] 112. The method of embodiment 110 or 111, wherein disposing said plurality of said biological cells within said plurality of sequestration pens comprises disposing substantially only one biological cell of said plurality in corresponding sequestration pens of said plurality.
- 10 [00626] 113. The method of any one of embodiments 109 to 112 further comprising: disposing a plurality of said capture objects within said plurality of sequestration pens.
- [00627] 114. The method of embodiment 113, wherein disposing said plurality of said capture objects within said plurality of sequestration pens comprises disposing substantially only one capture object within corresponding ones of sequestration pens of said plurality.
- 15 [00628] 115. The method of embodiment 113 or 114, wherein disposing said plurality of capture objects within said plurality of sequestration pens is performed before said lysing said biological cell or said plurality of said biological cells.
- [00629] 116. The method of any one of embodiments 113 to 115, wherein said plurality of said capture objects is a plurality of capture objects according to embodiment 23.
- 20 [00630] 117. The method of any one of embodiments 86 to 116 further comprising: exporting said capture object or said plurality of said capture objects from said microfluidic device.
- [00631] 118. The method of embodiment 117, wherein exporting said plurality of said capture objects comprises exporting each of said plurality of said capture objects individually.
- [00632] 119. The method of embodiment 118 further comprising: delivering each said capture object of said plurality to a separate destination container outside of said microfluidic device.
- 25 [00633] 120. The method of any one of embodiments 86 to 119, wherein one or more of said disposing said biological cell or plurality of said biological cells; said disposing said capture object or said plurality of said capture objects; said lysing said biological cell or said plurality of said biological cells and said allowing nucleic acids released from said lysed biological cell or said plurality of said biological cells to be captured; said transcribing; and said identifying said barcode sequence of said capture object or each said capture object of said plurality in-situ is performed in an automated manner.
- 30 [00634] 121. A method of providing a barcoded sequencing library, comprising:

amplifying a cDNA library of a capture object or a cDNA library of each of a plurality of said capture objects obtained by a method of any one of embodiments 86 to 120; and
tagmenting said amplified DNA library or said plurality of cDNA libraries, thereby producing one or a plurality of barcoded sequencing libraries.

5 [00635] 122. The method of embodiment 121, wherein amplifying said cDNA library or said plurality of cDNA libraries comprising introducing a pool index sequence, wherein said pool index sequence comprises 4 to 10 nucleotides.

[00636] 123. The method of embodiment 122, further comprising combining a plurality of said barcoded sequencing libraries, wherein each barcoded sequencing library of said plurality
10 comprises a different barcode sequence and/or a different pool index sequence.

[00637] 124. A method of providing a barcoded genomic DNA library from a biological micro-object, comprising:

disposing a biological micro-object comprising genomic DNA within a sequestration pen located within an enclosure of a microfluidic device;

15 contacting said biological micro-object with a lysing reagent capable of disrupting a nuclear envelope of said biological micro-object, thereby releasing genomic DNA of said biological micro-object;

tagmenting said released genomic DNA, thereby producing a plurality of tagmented genomic DNA fragments having a first end defined by a first tagmentation insert sequence and a second
20 end defined by a second tagmentation insert sequence;

disposing a capture object within said sequestration pen, wherein said capture object comprises a plurality of capture oligonucleotides, each capture oligonucleotide of said plurality comprising:
a first priming sequence;

a first tagmentation insert capture sequence; and

25 a barcode sequence, wherein said barcode sequence comprises three or more cassetable oligonucleotide sequences, each cassetable oligonucleotide sequence being non-identical to every other cassetable oligonucleotide sequence of said barcode sequence;

contacting ones of said plurality of tagmented genomic DNA fragments with (i) said first tagmentation insert capture sequence of ones of said plurality of capture oligonucleotides of said
30 capture object, (ii) an amplification oligonucleotide comprising a second priming sequence linked to a second tagmentation insert capture sequence, a randomized primer sequence, or a gene-specific primer sequence, and (iii) an enzymatic mixture comprising a strand displacement enzyme and a polymerase;

incubating said contacted plurality of tagmented genomic DNA fragments for a period of time, thereby simultaneously amplifying said ones of said plurality of tagmented genomic DNA fragments and adding said capture oligonucleotide and said amplification oligonucleotide to the ends of said ones of said plurality of tagmented genomic DNA fragments to produce said

5 barcoded genomic DNA library; and

exporting said barcoded genomic DNA library from said microfluidic device.

[00638] 125. The method of embodiment 124, wherein disposing said biological micro-object within said sequestration pen is performed before disposing said capture object within said sequestration pen.

10 [00639] 126. The method of embodiment 124 or 125, wherein said biological micro-object is a biological cell.

[00640] 127. The method of embodiment 124 or 125, wherein said biological micro-object is a nucleus of a biological cell (e.g., a eukaryotic cell).

[00641] 128. The method of embodiment 126 or 127, wherein said biological cell is an immune
15 cell.

[00642] 129. The method of embodiment 126 or 127, wherein said biological cell is a cancer cell.

[00643] 130. The method of any one of embodiments 124 to 129, wherein said lysing reagent comprises at least one ribonuclease inhibitor.

20 [00644] 131. The method of any one of embodiments 124 to 130, wherein said tagmenting comprises contacting said released genomic DNA with a transposase loaded with (i) a first double-stranded DNA fragment comprising said first tagmentation insert sequence, and (ii) a second double-stranded DNA fragment comprising said second tagmentation insert sequence.

[00645] 132. The method of embodiments 131, wherein said first double-stranded DNA
25 fragment comprises a first mosaic end sequence linked to a third priming sequence, and wherein said second double-stranded DNA fragment comprises a second mosaic end sequence linked to a fourth priming sequence.

[00646] 133. The method of embodiment 131 or 132, wherein said first tagmentation insert capture sequence of each capture oligonucleotide of said capture object comprises a sequence
30 which is at least partially complementary to said first tagmentation insert sequence.

[00647] 134. The method of any one of embodiments 131 to 133, wherein said second tagmentation insert capture sequence of said amplification oligonucleotide comprises a sequence which is at least partially complementary to said second tagmentation insert sequence.

- [00648] 135. The method of any one of embodiments 124 to 134, wherein said capture object is a capture object according to any one of embodiments 1 to 20.
- [00649] 136. The method of any one of embodiments 124 to 135, wherein said capture object comprises a magnetic component.
- 5 [00650] 137. The method of any one of embodiments 124 to 136 further comprising: identifying said barcode sequence of said plurality of capture oligonucleotides of said capture object in situ, while said capture object is located within said sequestration pen.
- [00651] 138. The method of embodiment 137, wherein said identifying said barcode sequence is performed using a method of any one of embodiments 42 to 62.
- 10 [00652] 139. The method of embodiment 137 or 138, wherein identifying said barcode sequence is performed before lysing said biological cell.
- [00653] 140. The method of any one of embodiments 124 to 139, wherein said enclosure of said microfluidic device comprises at least one coated surface.
- [00654] 141. The method of any one of embodiments 124 to 140, wherein said enclosure of
15 said microfluidic device comprises at least one conditioned surface.
- [00655] 142. The method of embodiment 141, wherein said at least one conditioned surface comprises a covalently bound hydrophilic moiety or a negatively charged moiety.
- [00656] 143. The method of any one of embodiments 124 to 142, wherein said enclosure of
20 said microfluidic device further comprises a dielectrophoretic (DEP) configuration, and wherein disposing said biological micro-object and/or disposing said capture object is performed by applying a dielectrophoretic (DEP) force on or proximal to said biological cell and/or said capture object.
- [00657] 144. The method of any one of embodiments 124 to 143, wherein said microfluidic device further comprises a plurality of sequestration pens.
- 25 [00658] 145. The method of embodiment 144 further comprising: disposing a plurality of said biological micro-objects within said plurality of sequestration pens.
- [00659] 146. The method of embodiment 145, wherein said plurality of said biological micro-objects is a clonal population of biological cells.
- [00660] 147. The method of embodiment 145 or 146, wherein disposing said plurality of said
30 biological micro-objects within said plurality of sequestration pens comprises disposing substantially only one biological micro-object of said plurality in corresponding sequestration pens of said plurality.
- [00661] 148. The method of any one of embodiments 144 to 147 further comprising: disposing a plurality of said capture objects within said plurality of sequestration pens.

[00662] 149. The method of embodiment 148, wherein disposing said plurality of said capture objects within said plurality of sequestration pens comprises disposing substantially only one capture object within corresponding ones of sequestration pens of said plurality.

[00663] 150. The method of embodiment 148 or 149, wherein disposing said plurality of capture objects within said plurality of sequestration pens is performed before lysing said biological micro-object or said plurality of said biological micro-objects.

[00664] 151. The method of any one of embodiments 148 to 150, wherein said plurality of said capture objects is a plurality of capture objects according to embodiment 23.

[00665] 152. The method of any one of embodiments 124 to 151 further comprising: exporting said capture object or said plurality of said capture objects from said microfluidic device.

[00666] 153. The method of embodiment 152, wherein exporting said plurality of said capture objects comprises exporting each of said plurality of said capture objects individually.

[00667] 154. The method of embodiment 153 further comprising: delivering each said capture object of said plurality to a separate destination container outside of said microfluidic device.

[00668] 155. The method of any one of embodiments 145 to 154, wherein said steps of tagging, contacting, and incubating are performed at substantially the same time for each of said sequestration pens containing one of said plurality of biological micro-objects.

[00669] 156. The method of any one of embodiments 124 to 155, wherein one or more of said disposing said biological micro-object or said plurality of said biological micro-objects; said disposing said capture object or said plurality of said capture objects; said lysing said biological micro-object or said plurality of said biological micro-objects and said allowing nucleic acids released from said lysed biological cell or said plurality of said biological cells to be captured; said tagging said released genomic DNA; said contacting ones of said plurality of tagged genomic DNA fragments; said incubating said contacted plurality of tagged genomic DNA fragments; said exporting said barcoded genomic DNA library or said plurality of DNA libraries; and said identifying said barcode sequence of said capture object or each said capture object of said plurality in-situ is performed in an automated manner.

[00670] 157. A method of providing a barcoded cDNA library and a barcoded genomic DNA library from a single biological cell, comprising:
disposing said biological cell within a sequestration pen located within an enclosure of a microfluidic device;
disposing a first capture object within said sequestration pen, wherein said first capture object comprises a plurality of capture oligonucleotides, each capture oligonucleotide of the plurality comprising:

a first priming sequence;
a first capture sequence; and
a first barcode sequence, wherein said first barcode sequence comprises three or more cassetteable oligonucleotide sequences, each cassetteable oligonucleotide sequence being non-identical to every
5 other cassetteable oligonucleotide sequence of said first barcode sequence;
obtaining said barcoded cDNA library by performing a method of any one of embodiments 86 to 123, wherein lysing said biological cell is performed such that a plasma membrane of said biological cell is degraded, releasing cytoplasmic RNA from said biological cell, while leaving a nuclear envelope of said biological cell intact, thereby providing said first capture object
10 decorated with said barcoded cDNA library from said RNA of said biological cell;
exporting said cDNA library-decorated first capture object from said microfluidic device;
disposing a second capture object within said sequestration pen, wherein said second capture object comprises a plurality of capture oligonucleotides, each comprising:
a second priming sequence;
15 a first tagmentation insert capture sequence; and
a second barcode sequence, wherein said second barcode sequence comprises three or more cassetteable oligonucleotide sequences, each cassetteable oligonucleotide sequence being non-identical to every other cassetteable oligonucleotide sequence of said second barcode sequence;
obtaining said barcoded genomic DNA library by performing a method of any one of
20 embodiments 124 to 156, wherein a plurality of tagmented genomic DNA fragments from said biological cell are contacted with said first tagmentation insert capture sequence of ones of said plurality of capture oligonucleotides of said second capture object, thereby providing said barcoded genomic DNA library from said genomic DNA of said biological cell; and
exporting said barcoded genomic DNA library from said microfluidic device.

25 [00671] 158. The method of embodiment 157 further comprising: identifying said barcode sequence of said plurality of capture oligonucleotides of said first capture object.

[00672] 159. The method of embodiment 158, wherein identifying said barcode sequence of said plurality of capture oligonucleotides of said first capture object is performed before
30 disposing said biological cell in said sequestration pen; before obtaining said barcoded cDNA library from said RNA of said biological cell; or before exporting said barcoded cDNA library-decorated first capture object from the microfluidic device.

[00673] 160. The method of any one of embodiments 157 to 159 further comprising:
identifying said barcode sequence of said plurality of oligonucleotides of said second capture object.

[00674] 161. The method of embodiment 160, wherein identifying said barcode sequence of said plurality of capture oligonucleotides of said second capture is performed before obtaining said barcoded genomic DNA library or after exporting said barcoded genomic DNA library from said microfluidic device.

5 [00675] 162. The method of any one of embodiments 157 to 161, wherein identifying said barcode sequence of said plurality of capture oligonucleotides of said first or said second capture object is performed using a method of any one of embodiments 42 to 60.

[00676] 163. The method of any one of embodiments 157 to 162, wherein said first capture object and said second capture object are each a capture object of any one of embodiments 1 to
10 22.

[00677] 164. The method of any one of embodiments 157 to 163, wherein said first priming sequence of said plurality of capture oligonucleotides of said first capture object is different from said second priming sequence of said plurality of capture oligonucleotides of said second capture object.

15 [00678] 165. The method of any one of embodiments 157 to 164, wherein said first capture sequence of said plurality of capture oligonucleotides of said first capture object is different from said first tagmentation insert capture sequence of said plurality of capture oligonucleotides of said second capture object.

[00679] 166. The method of any one of embodiments 157 to 165, wherein said barcode
20 sequence of said plurality of capture oligonucleotides of said first capture object is the same as said barcode sequence of said plurality of capture oligonucleotides of said second capture object.

[00680] 167. A method of providing a barcoded B cell receptor (BCR) sequencing library, comprising:

generating a barcoded cDNA library from a B lymphocyte, wherein said generating is performed
25 according to a method of any one of embodiments 86 to 109, wherein said barcoded cDNA library decorates a capture object comprising a plurality of capture oligonucleotides, each capture oligonucleotide of said plurality comprising a NotI restriction site sequence;

amplifying said barcoded cDNA library;

selecting for barcoded BCR sequences from said barcoded cDNA library, thereby producing a
30 library enriched for barcoded BCR sequences;

circularizing sequences from said library enriched for barcoded BCR sequences, thereby producing a library of circularized barcoded BCR sequences;

relinearizing said library of circularized barcoded BCR sequences to provide a library of rearranged barcoded BCR sequences, each presenting a constant (C) region of said BCR

sequence 3' to a respective variable (V) sub-region and/or a respective diversity (D) sub-region;
and,

adding a sequencing adaptor and sub-selecting for said V sub-region and/or said D sub-region,
thereby producing a barcoded BCR sequencing library.

5 [00681] 168. The method of embodiment 167, further comprising amplifying said BCR
sequencing library to provide an amplified library of barcoded BCR sub-region sequences.

[00682] 169. The method of embodiment 167 or 168, wherein amplifying said barcoded cDNA
library is performed using a universal primer.

[00683] 170. The method of any one of embodiments 167 to 169, wherein said selecting for a
10 BCR sequence region comprises performing a polymerase chain reaction (PCR) selective for
BCR sequences, thereby producing said library of barcoded BCR region selective amplified
DNA.

[00684] 171. The method of any one of embodiments 167 to 170, wherein said selecting for
barcoded BCR sequences further comprises adding at least one sequencing primer sequence
15 and/or at least one index sequence.

[00685] 172. The method of any one of embodiments 167 to 171, wherein circularizing
sequences from said library enriched for barcoded BCR sequences comprises ligating a 5' end of
each barcoded BCR sequence to its respective 3' end.

[00686] 173. The method of any one of embodiments 167 to 172, wherein relinearizing said
20 library of circularized barcoded BCR sequences comprises digesting each of said library of
circularized barcoded BCR sequences at said NotI restriction site.

[00687] 174. The method of any one of embodiments 167 to 173, wherein adding said
sequencing adaptor and sub-selecting for V and/or D sub-regions comprises performing PCR,
thereby adding a sequencing adaptor and sub-selecting for said V and/or D sub-regions.

25 [00688] 175. The method of any one of embodiments 167 to 174, wherein said capture object is
a capture object according to any one of embodiments 1 to 22.

[00689] 176. The method of any one of embodiments 167 to 175 further comprising:
identifying a barcode sequence of said plurality of capture oligonucleotides of said capture
object using a method of any one of embodiments 42 to 60.

30 [00690] 177. The method of embodiment 176, wherein said identifying is performed before
amplifying said barcoded cDNA library.

[00691] 178. The method of embodiment 177, wherein said identifying is performed while
generating said barcoded cDNA library.

[00692] 179. The method of any one of embodiments 167 to 178, wherein any of said amplifying said barcoded cDNA library; performing said polymerase chain reaction (PCR) selective for barcoded BCR sequences; circularizing sequences; relinearizing said library of circularized barcoded BCR sequences at said NotI restriction site; and adding said sequencing adaptor and sub-selecting for V and/or D sub-regions is performed within a sequestration pen located within an enclosure of a microfluidic device.

INFORMAL SEQUENCE LISTING

SEQ ID No.	Sequence	Type
1	CAGCCTTCTG	Artificial sequence
2	TGTGAGTTCC	Artificial sequence
3	GAATACGGGG	Artificial sequence
4	CTTTGGACCC	Artificial sequence
5	GCCATACACG	Artificial sequence
6	AAGCTGAAGC	Artificial sequence
7	TGTGGCCATT	Artificial sequence
8	CGCAATCTCA	Artificial sequence
9	TGCGTTGTTG	Artificial sequence
10	TACAGTTGGC	Artificial sequence
11	TTCCTCTCGT	Artificial sequence
12	GACGTTACGA	Artificial sequence
13	ACTGACGCGT	Artificial sequence
14	AGGAGCAGCA	Artificial sequence
15	TGACGCGCAA	Artificial sequence
16	TCCTCGCCAT	Artificial sequence
17	TAGCAGCCCA	Artificial sequence
18	CAGACGCTGT	Artificial sequence
19	TGGAAAGCGG	Artificial sequence
20	GCGACAAGAC	Artificial sequence
21	TGTCCGAAAG	Artificial sequence
22	AACATCCCTC	Artificial sequence
23	AAATGTCCCG	Artificial sequence
24	TTAGCGCGTC	Artificial sequence
25	AGTTCAGGCG	Artificial sequence
26	ACAGGGGAAC	Artificial sequence
27	ACCGGATTGG	Artificial sequence
28	TCGTGTGTGA	Artificial sequence
29	TAGGTCTGCG	Artificial sequence
30	ACCCATACCC	Artificial sequence
31	CCGCACTTCT	Artificial sequence
32	TTGGGTACAG	Artificial sequence
33	ATTCGTCCGA	Artificial sequence
34	GCCAGCGTAT	Artificial sequence
35	GTTGAGCAGG	Artificial sequence
36	GGTACCTGGT	Artificial sequence

37	GCATGAACGT	Artificial sequence
38	TGGCTACGAT	Artificial sequence
39	CGAAGGTAGG	Artificial sequence
40	TTCAACCGAG	Artificial sequence
41	CAGAAGGCTG/3AlexF647N/	Artificial sequence
42	GGAACTCACA/3AlexF647N/	Artificial sequence
43	CCCCGTATTC/3AlexF647N/	Artificial sequence
44	GGGTCCAAAG/3AlexF647N/	Artificial sequence
45	CGTGTATGGC/3AlexF647N/	Artificial sequence
46	GCTTCAGCTT/3AlexF647N/	Artificial sequence
47	AATGGCCACA/3AlexF647N/	Artificial sequence
48	TGAGATTGCG/3AlexF647N/	Artificial sequence
49	CAACAACGCA/3AlexF647N/	Artificial sequence
50	GCCAACTGTA/3AlexF647N/	Artificial sequence
51	/5AlexF405N/ACGAGAGGAA	Artificial sequence
52	/5AlexF405N/TCGTAACGTC	Artificial sequence
53	/5AlexF405N/ACGCGTCAGT	Artificial sequence
54	/5AlexF405N/TGCTGCTCCT	Artificial sequence
55	/5AlexF405N/TTGCGCGTCA	Artificial sequence
56	/5AlexF405N/ATGGCGAGGA	Artificial sequence
57	/5AlexF405N/TGGGCTGCTA	Artificial sequence
58	/5AlexF405N/ACAGCGTCTG	Artificial sequence
59	/5AlexF405N/CCGCTTTCCA	Artificial sequence
60	/5AlexF405N/GTCTTGTCGC	Artificial sequence
61	CTTTCGGACA/3AlexF488N/	Artificial sequence
62	GAGGGATGTT/3AlexF488N/	Artificial sequence
63	CGGGACATTT/3AlexF488N/	Artificial sequence
64	GACGCGCTAA/3AlexF488N/	Artificial sequence
65	CGCCTGAACT/3AlexF488N/	Artificial sequence
66	GTTCCCCTGT/3AlexF488N/	Artificial sequence
67	CCAATCCGGT/3AlexF488N/	Artificial sequence
68	TCACACACGA/3AlexF488N/	Artificial sequence
69	CGCAGACCTA/3AlexF488N/	Artificial sequence
70	GGGTATGGGT/3AlexF488N/	Artificial sequence
71	AGAAGTGCGG/3AlexF594N/	Artificial sequence
72	CTGTACCCAA/3AlexF594N/	Artificial sequence
73	TCCGACGAAT/3AlexF594N/	Artificial sequence
74	ATACGCTGGC/3AlexF594N/	Artificial sequence
75	CCTGCTCAAC/3AlexF594N/	Artificial sequence
76	ACCAGGTACC/3AlexF594N/	Artificial sequence
77	ACGTTCATGC/3AlexF594N/	Artificial sequence
78	ATCGTAGCCA/3AlexF594N/	Artificial sequence
79	CCTACCTTCG/3AlexF594N/	Artificial sequence
80	CTCGGTTGAA/3AlexF594N/	Artificial sequence
81	AGTCGACTGA	Artificial sequence
82	TCAGCTGACT-FITC	Artificial sequence
83	TCAGCTGACTXXXXXX	Artificial sequence
84	NNNNNNNNNN	Artificial sequence
85	TTTTTTTTTT	Artificial sequence

86	AAAAAAAAAA	Artificial sequence
87	CCCCCCCCC	Artificial sequence
88	GGGGGGGGG	Artificial sequence
89	GGGGGCCCCCTTTTTTTTTTCCGGCCGGCCAAAAATTTTT	Artificial sequence
90	AAAAAAAAAATTTTTTTTTTGGGGGGGGGGCCCCCCCCC	Artificial sequence
91	GGGGGCCCCCTTAATTAATTCCGGCCGGCCAAAAATTTTT	Artificial sequence
92	GGGGGCCCCCTTTTTTTTTTGGGGGGGGGGCCCCCCCCC	Artificial sequence
93	CCCCGGGGG	Artificial sequence
94	AATTAATTAA	Artificial sequence
95	GGCCGGCCGG	Artificial sequence
96	TTTTTAAAAA	Artificial sequence

SEQ ID NO	Sequence	TYPE
97	Bead-5'-Linker- ACACTCTTCCCTACACGACGCTCTCCGATCTCAGCCTTCTGTTCCCTCTCGTT GTCCGAAAGCCGCACTTCTNNNNNNNNNTTTTTTTTTTTTTTTTTTTVN- 3'	Artificial sequence
98	Bead-5'-Linker- ACACTCTTCCCTACACGACGCTCTCCGATCTCGCAATCTCACAGACGCTGTT CGTGTGTGATGGCTACGATNNNNNNNNNTTTTTTTTTTTTTTTTTTTVN- 3'	Artificial sequence
99	Bead-5'-Linker- ACACTCTTCCCTACACGACGCTCTCCGATCTCAGCCTTCTGTTCCCTCTCGTT GTCCGAAAGCCGCACTTCTNNNNNNNNNTTTTTTTTTTTTTTTTTTTVN- 3'	Artificial sequence
100	Bead-5'-Linker- ACACTCTTCCCTACACGACGCTCTCCGATCTCAGCCTTCTGTTCCCTCTCGTT GTCCGAAAGCCGCACTTCTNNNNNNNNNTTTTTTTTTTTTTTTTTTTVN- 3'	Artificial sequence
101	Bead-5'-Linker- ACACTCTTCCCTACACGACGCTCTCCGATCTCAGCCTTCTGTTCCCTCTCGTT GTCCGAAAGCCGCACTTCTNNNNNNNNNATCTCGTATGCCGTCTTCTGCTT GGCGGCCGCTTTTTTTTTTTTTTTTTTTVN	Artificial sequence
102	Bead-5'-Linker- ACACTCTTCCCTACACGACGCTCTCCGATCTTGCGTTGTTGTGGAAAGCGG TAGGTCTGCGGAAGGTAGGNNNNNNNNNATCTCGTATGCCGTCTTCTGC TTGGCGGCCGCTTTTTTTTTTTTTTTTTTTVN- 3'	Artificial sequence

SEQ ID NO.	Sequence/s	TYPE
103	/5Me-isodC//isodG//iMe- isodC/ACACTCTTCCCTACACGACGCrGrGrG	Artificial sequence
104	5'- ACACTCTTCCCTACACGACGCTCTCCGATCT	Artificial sequence
105	5'-/5Biosg/ACACTCTTCCCT ACACGACGC-3'	Artificial sequence
106	(5'- AATGATACGGCGACCACCGAGATCTACACTCTTCCCTACACGACGCTCT TCC*G*A*T*C*T-3'	Artificial sequence
107	5'-CAAGCAGAAGACGGCATAACGAGAT-3'	Artificial sequence
108	5'-AATGATACGGCGACCACCGA-3'	Artificial sequence
109	/5BiotinTEG/CAAGCAGAAGACGGCATAACGAGATTCGCCTTAG TCTCGTGGGCTCG*G	Artificial sequence
110	/5BiotinTEG/CAAGCAGAAGACGGCATAACGAGATCTAGTACG GTCTCGTGGGCTCG*G	Artificial sequence

111	/5BiotinTEG/AATGATACGGCGACCACCGAGATCTACACACTG CATATCGTCGGCAGCGT*C	Artificial sequence
112	5'-Me-isodC//Me-isodG//Me- isodC/ACACTCTTCCCTACACGACGCrGrGrG-3	Artificial sequence
113	5'-ACACTCTTCCCT ACACGACGC-3'	Artificial sequence
114	GTT ATT GCT AGC GGC TCA GCC GGC AAT GGC GGA KGT RMA GCT TCA GGA GTC	Artificial sequence
115	GTT ATT GCT AGC GGC TCA GCC GGC AAT GGC GGA GGT BCA GCT BCA GCA GTC	Artificial sequence
116	GTT ATT GCT AGC GGC TCA GCC GGC AAT GGC GGA GGT BCA GCT BCA GCA GTC	Artificial sequence
117	GTT ATT GCT AGC GGC TCA GCC GGC AAT GGC GGA GGT CCA RCT GCA ACA RTC	Artificial sequence
118	GTT ATT GCT AGC GGC TCA GCC GGC AAT GGC GCA GGT YCA GCT BCA GCA RTC	Artificial sequence
119	GTT ATT GCT AGC GGC TCA GCC GGC AAT GGC GCA GGT YCA RCT GCA GCA GTC	Artificial sequence
120	GTT ATT GCT AGC GGC TCA GCC GGC AAT GGC GCA GGT CCA CGT GAA GCA GTC	Artificial sequence
121	GTT ATT GCT AGC GGC TCA GCC GGC AAT GGC GGA GGT GAA SST GGT GGA ATC	Artificial sequence
122	GTT ATT GCT AGC GGC TCA GCC GGC AAT GGC GGA VGT GAW GYT GGT GGA GTC	Artificial sequence
123	GTT ATT GCT AGC GGC TCA GCC GGC AAT GGC GGA GGT GCA GSK GGT GGA GTC	Artificial sequence
124	GTT ATT GCT AGC GGC TCA GCC GGC AAT GGC GGA KGT GCA MCT GGT GGA GTC	Artificial sequence
125	GTT ATT GCT AGC GGC TCA GCC GGC AAT GGC GGA GGT GAA GCT GAT GGA RTC	Artificial sequence
126	GTT ATT GCT AGC GGC TCA GCC GGC AAT GGC GGA GGT GCA RCT TGT TGA GTC	Artificial sequence
127	GTT ATT GCT AGC GGC TCA GCC GGC AAT GGC GGA RGT RAA GCT TCT CGA GTC	Artificial sequence
128	GTT ATT GCT AGC GGC TCA GCC GGC AAT GGC GGA AGT GAA RST TGA GGA GTC	Artificial sequence
129	GTT ATT GCT AGC GGC TCA GCC GGC AAT GGC GCA GGT TAC TCT RAA AGW GTS TG	Artificial sequence
130	GTT ATT GCT AGC GGC TCA GCC GGC AAT GGC GCA GGT CCA ACT VCA GCA RCC	Artificial sequence
131	GTT ATT GCT AGC GGC TCA GCC GGC AAT GGC GGA TGT GAA CTT GGA AGT GTC	Artificial sequence
132	GTT ATT GCT AGC GGC TCA GCC GGC AAT GGC GGA GGT GAA GGT CAT CGA GTC	Artificial sequence
133	AGC CGG CCA TGG CGG AYA TCC AGC TGA CTC AGC C	Artificial sequence
134	AGC CGG CCA TGG CGG AYA TTG TTC TCW CCC AGT C	Artificial sequence
135	AGC CGG CCA TGG CGG AYA TTG TGM TMA CTC AGT C	Artificial sequence
136	AGC CGG CCA TGG CGG AYA TTG TGY TRA CAC AGT C	Artificial sequence
137	AGC CGG CCA TGG CGG AYA TTG TRA TGA CMC AGT C	Artificial sequence
138	AGC CGG CCA TGG CGG AYA TTM AGA TRA MCC AGT C	Artificial sequence
139	AGC CGG CCA TGG CGG AYA TTC AGA TGA YDC AGT C	Artificial sequence
140	AGC CGG CCA TGG CGG AYA TYC AGA TGA CAC AGA C	Artificial sequence
141	AGC CGG CCA TGG CGG AYA TTG TTC TCA WCC AGT C	Artificial sequence

142	AGC CGG CCA TGG CGG AYA TTG WGC TSA CCC AAT C	Artificial sequence
143	AGC CGG CCA TGG CGG AYA TTS TRA TGA CCC ART C	Artificial sequence
144	AGC CGG CCA TGG CGG AYR TTK TGA TGA CCC ARA C	Artificial sequence
145	AGC CGG CCA TGG CGG AYA TTG TGA TGA CBC AGK C	Artificial sequence
146	AGC CGG CCA TGG CGG AYA TTG TGA TAA CYC AGG A	Artificial sequence
147	AGC CGG CCA TGG CGG AYA TTG TGA TGA CCC AGW T	Artificial sequence
148	AGC CGG CCA TGG CGG AYA TTG TGA TGA CAC AAC C	Artificial sequence
149	AGC CGG CCA TGG CGG AYA TTT TGC TGA CTC AGT C	Artificial sequence
150	AGC CGG CCA TGG CGG ARG CTG TTG TGA CTC AGG AAT C	Artificial sequence
151	AGATCGGAAGAGCACACGTCTGAACTCCAGTCACCGATGTACACTCTTT CCCTACACGACGCTCTTCCGATCT	Artificial sequence
152	AGATCGGAAGAGCACACGTCTGAACTCCAGTCACGATCAGACACTCTTT CCCTACACGACGCTCTTCCGATCT	Artificial sequence
153	5'-CAAGCAGAAGACGGCATAACGAGAT-3'	Artificial sequence
154	AATGATACGGCGACCACCGAGATCTACACGGATAGACHGATGGGGSTG TYGTT	Artificial sequence
155	AATGATACGGCGACCACCGAGATCTACACCTGGATGGTGGGAAGATGG ATACAG	Artificial sequence
156	TGTGCAAGATATTATGATGATCATTACTGCCTTGACTACTGG	Artificial sequence
157	---GCAAGATATTATGATGATCATTACTGCCTTGACTAC---	Natural Organism: Human OKT8, CDR3
158	TGTGGTAGAGGTTATGGTTACTACGTATTTGACCACTGG	Artificial sequence
159	---GGTAGAGGTTATGGTTACTACGTATTTGACCAC---	Natural Organism: Mouse: OKT3, CDR3
160	GCGGCCGC	Artificial sequence
161	5'-TCGTCGGCAGCGTCAGATGTGTATAAGAGACAG-3'	Artificial sequence
162	5'GTCTCGTGGGCTCGGAGATGTGTATAAGAGACAG-3'	Artificial sequence

What is claimed:

- 1 1. A capture object comprising a plurality of capture oligonucleotides, wherein each capture
2 oligonucleotide of said plurality comprises:
3 a priming sequence;
4 a capture sequence; and
5 a barcode sequence comprising three or more cassetable oligonucleotide sequences, each
6 cassetable oligonucleotide sequence being non-identical to the other cassetable oligonucleotide
7 sequences of said barcode sequence, and,
8 wherein each capture oligonucleotide of said plurality comprises the same barcode
9 sequence.
- 1 2. The capture object of claim 1, wherein each capture oligonucleotide of said plurality
2 comprises a 5'-most nucleotide and a 3'-most nucleotide,
3 wherein said priming sequence is adjacent to or comprises said 5'-most nucleotide,
4 wherein said capture sequence is adjacent to or comprises said 3'-most nucleotide, and
5 wherein said barcode sequence is located 3' to said priming sequence and 5' to said
6 capture sequence.
- 1 3. The capture object of claim 1, wherein each of said three or more cassetable
2 oligonucleotide sequences comprises 8 to 12 nucleotides.
- 1 4. The capture object of claim 1, wherein said three or more cassetable oligonucleotide
2 sequences of said barcode sequence are linked in tandem without any intervening oligonucleotide
3 sequences.
- 1 5. The capture object of claim 1, wherein each of said three or more cassetable
2 oligonucleotide sequences of said barcode sequence is selected from a set of 12 to 100 non-
3 identical cassetable oligonucleotide sequences.
- 1 6. The capture object of claim 1, wherein each of said three or more cassetable
2 oligonucleotides sequences of said barcode sequence has a sequence of any one of SEQ ID NOs:
3 1-40.
- 1 7. The capture object of claim 1, wherein said barcode sequence comprises four cassetable
2 oligonucleotide sequences.

- 1 8. The capture object of claim 1, wherein each capture oligonucleotide of said plurality
2 further comprises a unique molecule identifier (UMI) sequence.
- 1 9. The capture object of claim 8, wherein said UMI is located 3' to said priming sequence
2 and 5' to said capture sequence.
- 1 10 The capture object of claim 1, wherein each capture oligonucleotide further comprises a
2 restriction site comprising a recognition sequence of at least 8 base pairs.
- 1 11. The capture object of claim 1, wherein said capture sequence comprises a poly-dT
2 sequence, a random hexamer sequence, a gene specific sequence, or a mosaic end sequence.
- 1 12. A plurality of capture objects, wherein each capture object of said plurality is a capture
2 object of claim 1, wherein said barcode sequence of said capture oligonucleotides of each capture
3 object of said plurality is different from the barcode sequence of the capture oligonucleotides of
4 every other capture object of said plurality.
- 1 13. A hybridization probe comprising:
2 an oligonucleotide sequence comprising a sequence of any one of SEQ ID NOs: 41 to 80;
3 and, a fluorescent label.
- 1 14. A reagent comprising a plurality of hybridization probes, wherein each hybridization
2 probe of said plurality is a hybridization probe according to claim 32, and wherein each
3 hybridization probe of said plurality (i) comprises an oligonucleotide sequence which is non-
4 identical to the oligonucleotide sequence of every other hybridization probe of the plurality and
5 (ii) comprises a fluorescent label which is spectrally distinguishable from the fluorescent label of
6 every other hybridization probe of said plurality.
- 1 15. The reagent of claim 14, wherein said plurality of hybridization probes consists of two to
2 four hybridization probes.
- 1 16. The reagent of claim 14, wherein:
2 a first hybridization probe of said plurality comprises a sequence selected from a first
3 subset of SEQ ID NOs: 41-80, and a first fluorescent label;
4 a second hybridization probe of said plurality comprises a sequence selected from a
5 second subset of SEQ ID NOs: 41-80, and a second fluorescent label which is spectrally
6 distinguishable from said first fluorescent label,

7 a third hybridization probe of said plurality comprises a sequence selected from a third
8 subset of SEQ ID NOs: 41-80, and a third fluorescent label which is spectrally distinguishable
9 from each of said first and second fluorescent labels,

10 wherein said first, second, and third subsets of SEQ ID NOs: 41-80 are non-overlapping
11 subsets.

1 17. The reagent of claim 16, wherein:

2 a fourth hybridization probe of said plurality comprises a sequence selected from a fourth
3 subset of SEQ ID NOs: 41-80, and a fourth fluorescent label which is spectrally distinguishable
4 from each of said first, second, and third fluorescent labels,

5 wherein said first, second, third, and fourth subsets of SEQ ID NOs: 41-80 are non-
6 overlapping subsets.

1 18. A kit comprising a plurality of reagents according to any one of claims 33 to 39, wherein
2 said plurality of hybridization probes of each reagent forms a set that is non-overlapping with
3 said set of hybridization probes of every other reagent in said plurality, and wherein said kit
4 comprises 3, 4, 5, 6, 7, 8, 9, or 10 said reagents.

1 19. A method of in-situ identification of one or more capture objects within a microfluidic
2 device, said method comprising:

3 disposing a single capture object of said one or more capture objects within an isolation
4 region of each of one or more sequestration pens located within an enclosure of said microfluidic
5 device, wherein each capture object comprises a plurality of capture oligonucleotides, and
6 wherein each capture oligonucleotide of said plurality comprises:

7 a priming sequence;

8 a capture sequence; and

9 a barcode sequence, wherein said barcode sequence comprises three or more
10 cassetable oligonucleotide sequences, each cassetable oligonucleotide sequence being
11 non-identical to the other cassetable oligonucleotide sequences of said barcode sequence;
12 flowing a first reagent solution comprising a first set of hybridization probes into a flow
13 region within said enclosure of said microfluidic device, wherein said flow region is fluidically
14 connected to each of said one or more sequestration pens, and wherein each hybridization probe
15 of said first set comprises:

16 an oligonucleotide sequence complementary to a cassetable oligonucleotide

17 sequence comprised by any of said barcode sequences of any of said capture

18 oligonucleotides of any of said one or more capture objects, wherein said complementary

19 oligonucleotide sequence of each hybridization probe in said first set is non-identical to
20 every other complementary oligonucleotide sequence of said hybridization probes in said
21 first set; and

22 a fluorescent label selected from a set of spectrally distinguishable fluorescent
23 labels, wherein said fluorescent label of each hybridization probe in said first set is
24 different from the fluorescent label of every other hybridization probe in said first set of
25 hybridization probes;

26 hybridizing said hybridization probes of said first set to corresponding cassetable oligo-
27 nucleotide sequences in any of said barcode sequences of any of said capture oligonucleotides of
28 any of said one or more capture objects;

29 detecting, for each hybridization probe of said first set of hybridization probes, a
30 corresponding fluorescent signal associated with any of said one or more capture objects; and

31 generating a record, for each capture object disposed within one of said one or more
32 sequestration pens, comprising (i) a location of said sequestration pen within said enclosure of
33 said microfluidic device, and (ii) an association or non-association of said corresponding
34 fluorescent signal of each hybridization probe of said first set of hybridization probes with said
35 capture object, wherein said record of associations and non-associations constitute a barcode
36 which links said capture object with said sequestration pen.

1 20. The method of claim 19, further comprising:

2 flowing an n^{th} reagent solution comprising an n^{th} set of hybridization probes into said
3 flow region of said microfluidic device, wherein each hybridization probe of said n^{th} set
4 comprises:

5 an oligonucleotide sequence complementary to a cassetable oligonucleotide sequence
6 comprised by any of said barcode sequences of any of said capture oligonucleotides of any of
7 said one or more capture objects, wherein said complementary oligonucleotide sequence of
8 each hybridization probe in said n^{th} set is non-identical to every other complementary
9 oligonucleotide sequence of said hybridization probes in said n^{th} set and any other set of
10 hybridization probes flowed into said flow region of said microfluidic device; and

11 a fluorescent label selected from a set of spectrally distinguishable fluorescent labels,
12 wherein said fluorescent label of each hybridization probe in said n^{th} set is different from the
13 fluorescent label of every other hybridization probe in said n^{th} set of hybridization probes;

14 hybridizing said hybridization probes of said n^{th} set to corresponding cassetable oligo-
15 nucleotide sequences in any of said barcode sequences of any of said capture oligonucleotides of
16 any of said one or more capture objects;

17 detecting, for each hybridization probe of said n^{th} set of hybridization probes, a
18 corresponding fluorescent signal associated with any of said one or more capture objects; and
19 supplementing said record, for each capture object disposed within one of said one or
20 more sequestration pens, with an association or non-association of said corresponding fluorescent
21 signal of each hybridization probe of said n^{th} set of hybridization probes with said capture object,
22 wherein n is a set of positive integers having values of $\{2, \dots, m\}$,
23 wherein m is a positive integer having a value of 2 or greater,
24 wherein the foregoing steps of flowing said n^{th} reagent, hybridizing said n^{th} set of
25 hybridization probes, detecting said corresponding fluorescent signals, and supplements said
26 records are repeated for each value of n in said set of positive integers $\{2, \dots, m\}$, and,
27 wherein m has a value greater than or equal to 3 and less than or equal to 20.

1 21. The method of claim 19, wherein detecting said corresponding fluorescent signal
2 associated with any of said one or more capture objects further comprises:

3 flowing a rinsing solution having no hybridization probes through said flow region of said
4 microfluidic device; and

5 equilibrating by diffusion said rinsing solution into said one or more sequestration pens,
6 thereby allowing unhybridized hybridization probes of said first set or any of said n^{th} sets to
7 diffuse out of said one or more sequestration pens; and

8 further wherein said flowing said rinsing solution is performed before detecting said
9 fluorescent signal.

1 22. The method of claim 19, wherein each barcode sequence of each capture oligonucleotide
2 of each capture object comprises three or four cassette oligonucleotide sequences.

1 23. The method of claim 22, wherein said first set of hybridization probes and each of said n^{th}
2 sets of hybridization probes comprise three or four hybridization probes.

1 24. The method of claim 19, further comprising disposing one or more biological cells within
2 said one or more sequestration pens of said microfluidic device, wherein each one of said one or
3 more biological cells are disposed in a different one of said one or more sequestration pens.

1 25. The method of claim 19, wherein said enclosure of said microfluidic device further
2 comprises a dielectrophoretic (DEP) configuration, and wherein disposing said one or more
3 capture objects into one or more sequestration pens is performed using dielectrophoretic (DEP)
4 force.

1 26. The method of claim 19, wherein said enclosure of said microfluidic device further
2 comprises a dielectrophoretic (DEP) configuration, and said disposing said one or more
3 biological cells within said one or more sequestration pens is performed using dielectrophoretic
4 (DEP) forces.

1 27. A method of correlating genomic data with a biological cell in a microfluidic device,
2 comprising:

3 disposing a capture object into a sequestration pen of a microfluidic device, wherein said
4 capture object comprises a plurality of capture oligonucleotides, wherein each capture
5 oligonucleotide of said plurality comprises:

6 a priming sequence;

7 a capture sequence; and

8 a barcode sequence, wherein said barcode sequence comprises three or more
9 cassetable oligonucleotide sequences, each cassetable oligonucleotide sequence being
10 non-identical to the other cassetable oligonucleotide sequences of said barcode sequence;
11 and

12 wherein each capture oligonucleotide of said plurality comprises said same
13 barcode sequence;

14 identifying said barcode sequence of said plurality of capture oligonucleotides in-situ and
15 recording an association between said identified barcode sequence and said sequestration pen;

16 disposing said biological cell into said sequestration pen;

17 lysing said biological cell and allowing nucleic acids released from said lysed biological
18 cell to be captured by said plurality of capture oligonucleotides comprised by said capture object;

19 transcribing said captured nucleic acids, thereby producing a plurality of barcoded
20 cDNAs, each barcoded cDNA comprising a complementary captured nucleic acid sequence
21 covalently linked to one of said capture oligonucleotides;

22 sequencing said transcribed nucleic acids and said barcode sequence, thereby obtaining
23 read sequences of said plurality of transcribed nucleic acids associated with read sequences of
24 said barcode sequence;

25 identifying said barcode sequence based upon said read sequences; and

26 using said read sequence-identified barcode sequence and said in situ-identified barcode
27 sequence to link said read sequences of said plurality of transcribed nucleic acids with said
28 sequestration pen and thereby correlate said read sequences of said plurality of transcribed
29 nucleic acids with said biological cell placed into said sequestration pen.

- 1 28. The method of claim 27, further comprising:
2 observing a phenotype of said biological cell; and
3 correlating said read sequences of said plurality of transcribed nucleic acids with said
4 phenotype of said biological cell.
- 1 29. The method of claim 27, wherein observing said phenotype of said biological cell
2 comprises: observing at least one physical characteristic of said at least one biological cell; or,
3 comprises performing an assay on said biological cell and observing a detectable signal
4 generated during said assay.
- 1 30. The method of claim 27, wherein identifying said barcode sequence of said plurality of
2 capture oligonucleotide in-situ comprises performing the method of claim 19.
- 1 31. The method of claim 27, wherein said enclosure of said microfluidic device comprises a
2 dielectrophoretic (DEP) configuration, and wherein disposing said capture object into said
3 sequestration pen comprises using dielectrophoretic (DEP) forces to move said capture object.
- 1 32. The method of claim 27, wherein said enclosure of said microfluidic device further
2 comprises a dielectrophoretic (DEP) configuration, and wherein disposing said biological cell
3 within said sequestration pen comprises using dielectrophoretic (DEP) forces to move said
4 biological cell.
- 1 33. The method of claim 27, further comprising:
2 disposing a plurality of capture objects into a corresponding plurality of sequestration
3 pens of said microfluidic device;
4 disposing a plurality of biological cells into said corresponding plurality of sequestration
5 pens, and
6 processing each of said plurality of capture objects and plurality of biological cells
7 according to said additional steps of said method.
- 1 34. A kit for producing a nucleic acid library, comprising:
2 a microfluidic device comprising:
3 an enclosure, wherein said enclosure comprises a flow region and a plurality of
4 sequestration pens opening off of said flow region; and,
5 a dielectrophoretic (DEP) configuration; and
6 a plurality of capture objects, wherein each capture object of said plurality comprises a
7 plurality of capture oligonucleotides, each capture oligonucleotide of said plurality comprising:

8 a capture sequence; and
9 a barcode sequence comprising at least three cassetable oligonucleotide
10 sequences, wherein each cassetable oligonucleotide sequence of said barcode sequence is
11 non-identical to the other cassetable oligonucleotide sequences of said barcode sequence,
12 and wherein each capture oligonucleotide of said plurality comprises the same barcode
13 sequence; and wherein said plurality of capture objects is a plurality of capture objects
14 according to claim 12.

1 35. The kit of claim 34, further comprising:
2 a plurality of hybridization probes, each hybridization probe comprising:
3 an oligonucleotide sequence complementary to any one of said cassetable
4 oligonucleotide sequences of said plurality of capture oligonucleotides of any one of said
5 plurality of capture objects; and
6 a label,
7 wherein said complementary sequence of each hybridization probe of said plurality is
8 complementary to a different cassetable oligonucleotide sequence; and
9 wherein said label of each hybridization probe of said plurality is selected from a set of
10 spectrally distinguishable labels.

1 36. The kit of claim 35, wherein each complementary sequence of a hybridization probe of
2 said plurality comprises an oligonucleotide sequence comprising a sequence of any one of SEQ
3 ID NOs: 41 to 80.

1 37. A method of providing a barcoded cDNA library from a biological cell, comprising:
2 disposing said biological cell within a sequestration pen located within an enclosure of a
3 microfluidic device;
4 disposing a capture object within said sequestration pen, wherein said capture object
5 comprises a plurality of capture oligonucleotides, each capture oligonucleotide of said plurality
6 comprising:
7 a priming sequence that binds a primer;
8 a capture sequence; and
9 a barcode sequence, wherein said barcode sequence comprises three or more
10 cassetable oligonucleotide sequences, each cassetable oligonucleotide sequence being
11 non-identical to every other cassetable oligonucleotide sequences of said barcode
12 sequence; and wherein said barcode sequence of each capture oligonucleotide of said
13 plurality is the same;

14 lysing said biological cell and allowing nucleic acids released from said lysed biological
15 cell to be captured by said plurality of capture oligonucleotides comprised by said capture object;
16 and

17 transcribing said captured nucleic acids, thereby producing a plurality of barcoded
18 cDNAs decorating said capture object, each barcoded cDNA comprising (i) an oligonucleotide
19 sequence complementary to a corresponding one of said captured nucleic acids, covalently linked
20 to (ii) one of said plurality of capture oligonucleotides.

1 38. The method of claim 37, wherein said biological cell is an immune cell, a cancer cell, a
2 stem cell, a progenitor cell, or an embryo.

1 39. The method of claim 37, wherein said capture sequence of one or more of said plurality
2 of capture oligonucleotides comprises an oligo-dT primer sequence.

1 40. The method of claim 37, wherein said capture sequence of one or more of said plurality
2 of capture oligonucleotides comprises a gene-specific primer sequence.

1 41. The method of claim 40, wherein said gene-specific primer sequence targets an mRNA
2 sequence encoding a T cell receptor (TCR) or a B-cell receptor (BCR).

1 42. The method of claim 37, further comprising: identifying said barcode sequence of said
2 plurality of capture oligonucleotides of said capture object in situ, while said capture object is
3 located within said sequestration pen.

1 43. The method of claim 42, wherein said identifying said barcode is performed using the
2 method of claim 19.

1 44. The method of claim 37, wherein said enclosure of said microfluidic device further
2 comprises a dielectrophoretic (DEP) configuration, and wherein disposing said biological cell
3 and/or disposing said capture object is performed by applying a dielectrophoretic (DEP) force on
4 or proximal to said biological cell and/or said capture object.

1 45. The method of claim 37, further comprising: exporting said capture object from said
2 microfluidic device.

1 46. A method of providing a barcoded sequencing library, comprising:
2 amplifying a cDNA library of a capture object obtained by a method of claim 37; and
3 tagging said amplified DNA library, thereby producing a sequencing library.

1 47. A method of providing a barcoded genomic DNA library from a biological micro-object,
2 comprising:

3 disposing a biological micro-object comprising genomic DNA within a sequestration pen
4 located within an enclosure of a microfluidic device;

5 contacting said biological micro-object with a lysing reagent capable of disrupting a
6 nuclear envelope of said biological micro-object, thereby releasing genomic DNA of said
7 biological micro-object;

8 tagging said released genomic DNA, thereby producing a plurality of tagmented
9 genomic DNA fragments having a first end defined by a first tagmentation insert sequence and a
10 second end defined by a second tagmentation insert sequence;

11 disposing a capture object within said sequestration pen, wherein said capture object
12 comprises a plurality of capture oligonucleotides, each capture oligonucleotide of said plurality
13 comprising:

14 a first priming sequence;

15 a first tagmentation insert capture sequence; and

16 a barcode sequence, wherein said barcode sequence comprises three or more
17 cassette oligonucleotide sequences, each cassette oligonucleotide sequence being
18 non-identical to every other cassette oligonucleotide sequence of said barcode
19 sequence, and wherein said barcode sequence of each capture oligonucleotide of said
20 plurality is the same;

21 contacting ones of said plurality of tagmented genomic DNA fragments with (i) said first
22 tagmentation insert capture sequence of ones of said plurality of capture oligonucleotides of said
23 capture object, (ii) an amplification oligonucleotide comprising a second priming sequence
24 linked to a second tagmentation insert capture sequence, a randomized primer sequence, or a
25 gene-specific primer sequence, and (iii) an enzymatic mixture comprising a strand displacement
26 enzyme and a polymerase;

27 incubating said contacted plurality of tagmented genomic DNA fragments for a period of
28 time, thereby simultaneously amplifying said ones of said plurality of tagmented genomic DNA
29 fragments and adding said capture oligonucleotide and said amplification oligonucleotide to the
30 ends of said ones of said plurality of tagmented genomic DNA fragments to produce said
31 barcoded genomic DNA library; and

32 exporting said barcoded genomic DNA library from said microfluidic device.

1 48. The method of claim 47, wherein said biological micro-object is a biological cell or a
2 nucleus of a biological cell.

1 49. The method of claim 48, wherein said biological cell is an immune cell or a cancer cell.

1 50. The method of claim 47, wherein said tagmenting comprises contacting said released
2 genomic DNA with a transposase loaded with (i) a first double-stranded DNA fragment
3 comprising said first tagmentation insert sequence, and (ii) a second double-stranded DNA
4 fragment comprising said second tagmentation insert sequence.

1 51. The method of claim 50, wherein said first tagmentation insert capture sequence of each
2 capture oligonucleotide of said capture object comprises a sequence which is at least partially
3 complementary to said first tagmentation insert sequence; and
4 wherein said second tagmentation insert capture sequence of said amplification oligonucleotide
5 comprises a sequence which is at least partially complementary to said second tagmentation
6 insert sequence.

1 52. The method of claim 47, further comprising: identifying said barcode sequence of said
2 plurality of capture oligonucleotides of said capture object in situ, while said capture object is
3 located within said sequestration pen.

1 53. The method of claim 52, wherein said identifying said barcode sequence is performed
2 using a method of claim 19.

1 54. The method of claim 47, wherein said enclosure of said microfluidic device further
2 comprises a dielectrophoretic (DEP) configuration, and wherein disposing said biological micro-
3 object and/or disposing said capture object is performed by applying a dielectrophoretic (DEP)
4 force on or proximal to said biological cell and/or said capture object.

1 55. A method of providing a barcoded cDNA library and a barcoded genomic DNA library
2 from a single biological cell, comprising:
3 disposing said biological cell within a sequestration pen located within an enclosure of a
4 microfluidic device;
5 disposing a first capture object within said sequestration pen, wherein said first capture
6 object comprises a plurality of capture oligonucleotides, each capture oligonucleotide of said
7 plurality comprising:
8 a first priming sequence;

9 a first capture sequence; and
10 a first barcode sequence, wherein said first barcode sequence comprises three or more
11 cassette oligonucleotide sequences, each cassette oligonucleotide sequence being non-
12 identical to every other cassette oligonucleotide sequence of said first barcode sequence, and
13 wherein said barcode sequence of each capture oligonucleotide of said plurality is the same;
14 obtaining said barcoded cDNA library by performing the method of claim 37, wherein
15 lysing said biological cell is performed such that a plasma membrane of said biological cell is
16 degraded, releasing cytoplasmic RNA from said biological cell, while leaving a nuclear envelope
17 of said biological cell intact, thereby providing said first capture object decorated with said
18 barcoded cDNA library from said RNA of said biological cell;
19 exporting said cDNA library-decorated first capture object from said microfluidic device;
20 disposing a second capture object within said sequestration pen, wherein said second
21 capture object comprises a plurality of capture oligonucleotides, each comprising:
22 a second priming sequence;
23 a first tagmentation insert capture sequence; and
24 a second barcode sequence, wherein said second barcode sequence comprises three or
25 more cassette oligonucleotide sequences, each cassette oligonucleotide sequence being non-
26 identical to every other cassette oligonucleotide sequence of said second barcode sequence,
27 and wherein said barcode sequence of each capture oligonucleotide of said plurality is the
28 same;
29 obtaining said barcoded genomic DNA library by performing the method of claim 47,
30 wherein a plurality of tagmented genomic DNA fragments from said biological cell are contacted
31 with said first tagmentation insert capture sequence of ones of said plurality of capture
32 oligonucleotides of said second capture object, thereby providing said barcoded genomic DNA
33 library from said genomic DNA of said biological cell; and
34 exporting said barcoded genomic DNA library from said microfluidic device.

1 56. The method of claim 55, further comprising: identifying said barcode sequence of said
2 plurality of capture oligonucleotides of said first capture object in-situ.

1 57. The method of claim 55, further comprising: identifying said barcode sequence of said
2 plurality of oligonucleotides of said second capture object in-situ.

1 58. The method of claim 56 or 57, wherein identifying said barcode sequence of said plurality
2 of capture oligonucleotides of said first or said second capture object is performed using a
3 method of claim 19.

1 59. A method of providing a barcoded B cell receptor (BCR) sequencing library, comprising:
2 generating a barcoded cDNA library from a B lymphocyte, wherein said generating is
3 performed according to the method of claim 37, wherein said barcoded cDNA library decorates a
4 capture object comprising a plurality of capture oligonucleotides, each capture oligonucleotide of
5 said plurality comprising a NotI restriction site sequence;
6 amplifying said barcoded cDNA library;
7 selecting for barcoded BCR sequences from said barcoded cDNA library, thereby
8 producing a library enriched for barcoded BCR sequences;
9 circularizing sequences from said library enriched for barcoded BCR sequences, thereby
10 producing a library of circularized barcoded BCR sequences;
11 relinearizing said library of circularized barcoded BCR sequences to provide a library of
12 rearranged barcoded BCR sequences, each presenting a constant (C) region of said BCR
13 sequence 3' to a respective variable (V) sub-region and/or a respective diversity (D) sub-region;
14 and,
15 adding a sequencing adaptor and sub-selecting for said V sub-region and/or said D sub-
16 region, thereby producing a barcoded BCR sequencing library.

1 60. The method of claim 59, further comprising amplifying said BCR sequencing library to
2 provide an amplified library of barcoded BCR sub-region sequences.

1 61. The method of claim 59, wherein said selecting for a BCR sequence region comprises
2 performing a polymerase chain reaction (PCR) selective for BCR sequences, thereby producing
3 said library of barcoded BCR region selective amplified DNA.

1 62. The method of claim 59, wherein circularizing sequences from said library enriched for
2 barcoded BCR sequences comprises ligating a 5' end of each barcoded BCR sequence to its
3 respective 3' end.

1 63. The method of claim 59, wherein relinearizing said library of circularized barcoded BCR
2 sequences comprises digesting each of said library of circularized barcoded BCR sequences at
3 said NotI restriction site.

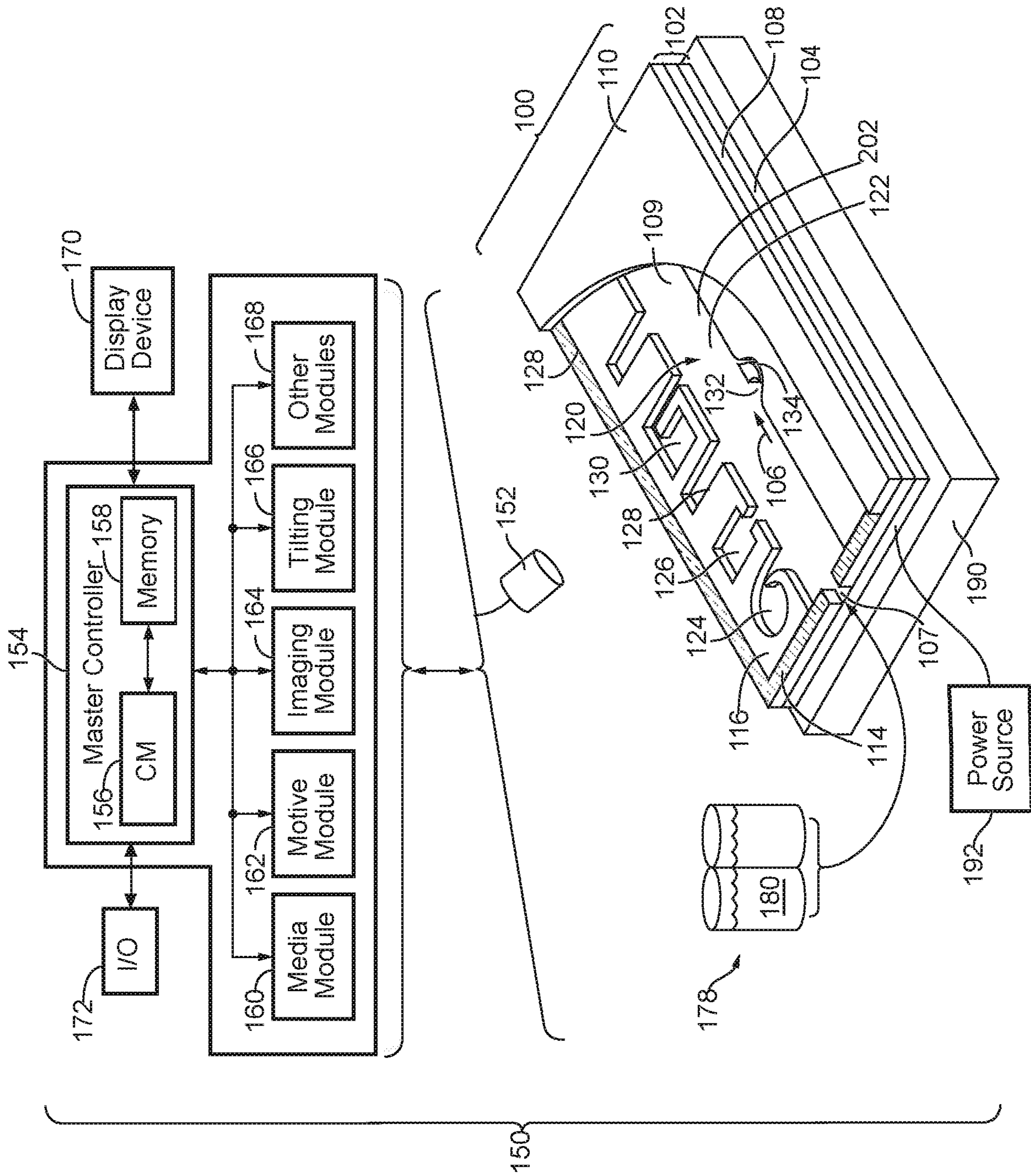

FIG. 1A

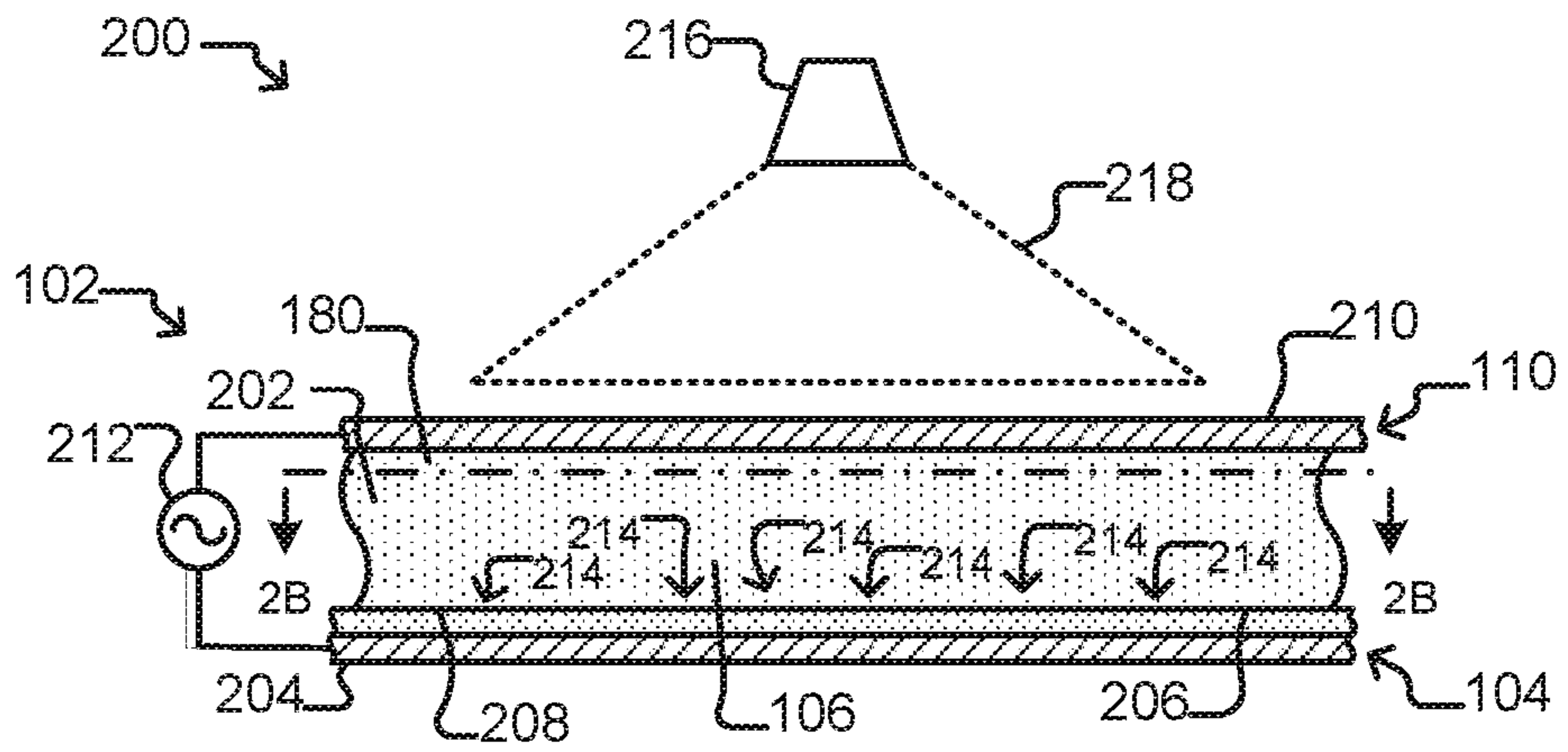

FIG. 1B

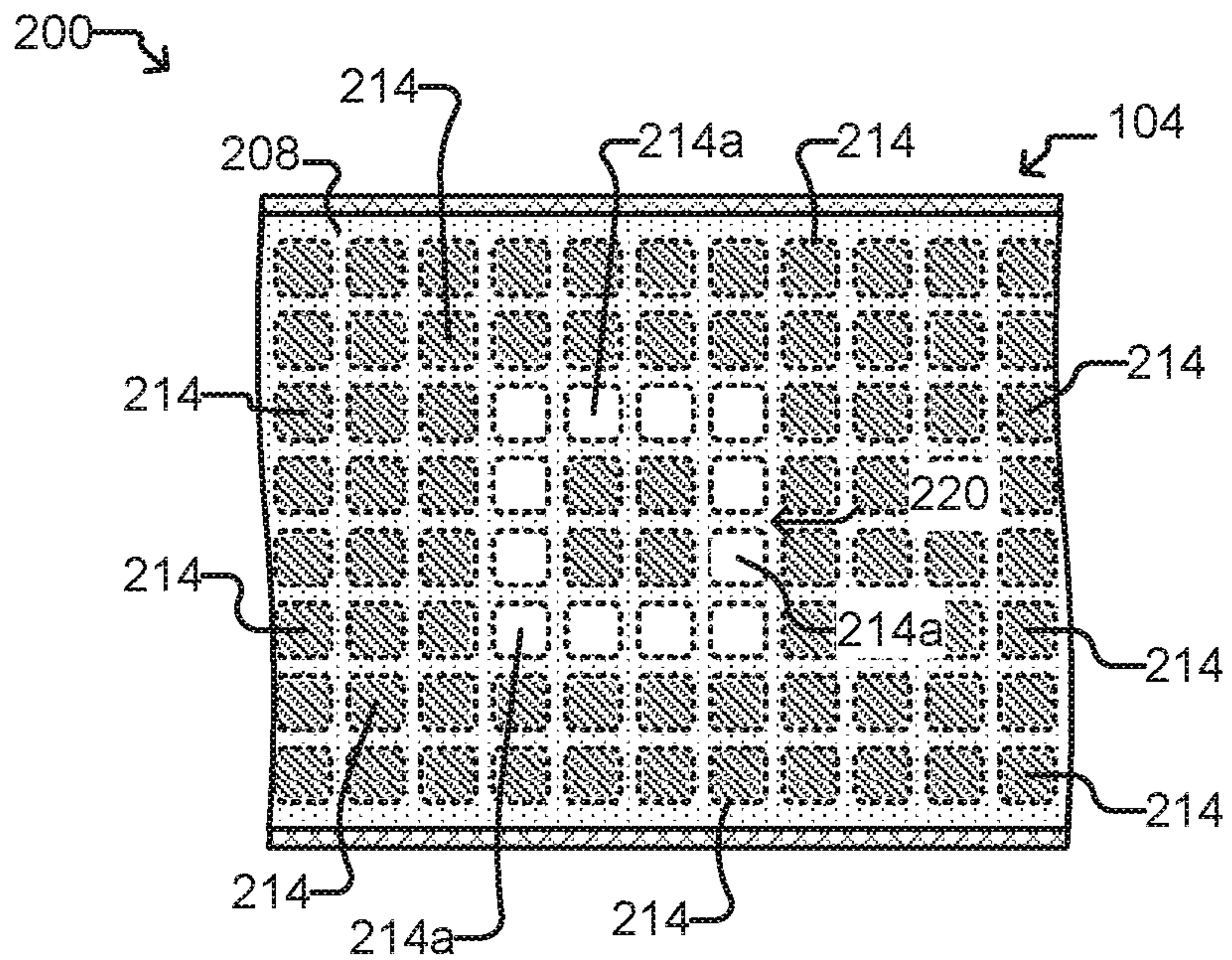

FIG. 1C

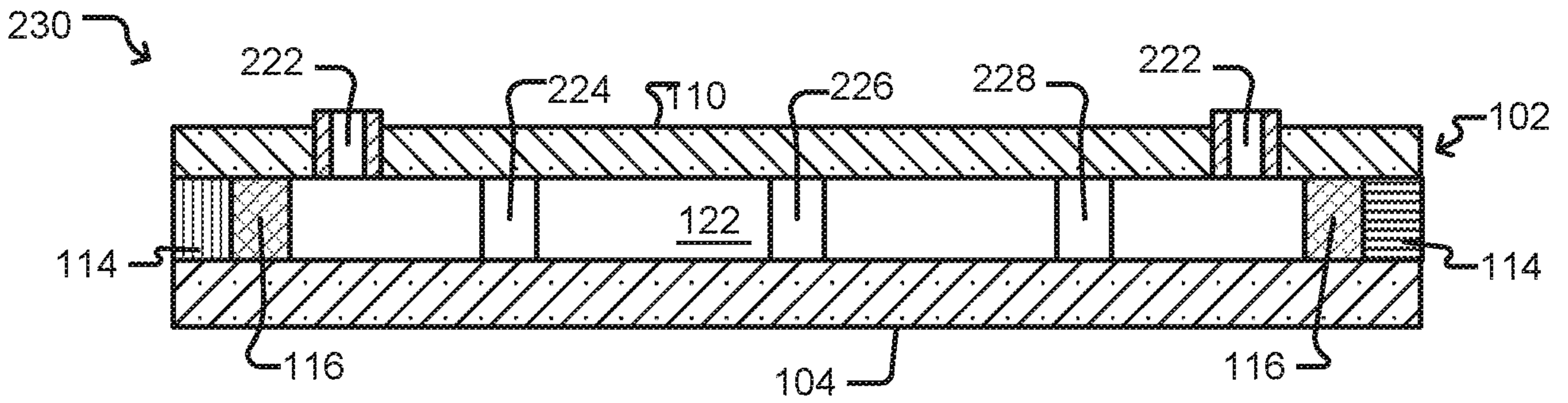

FIG. 2A

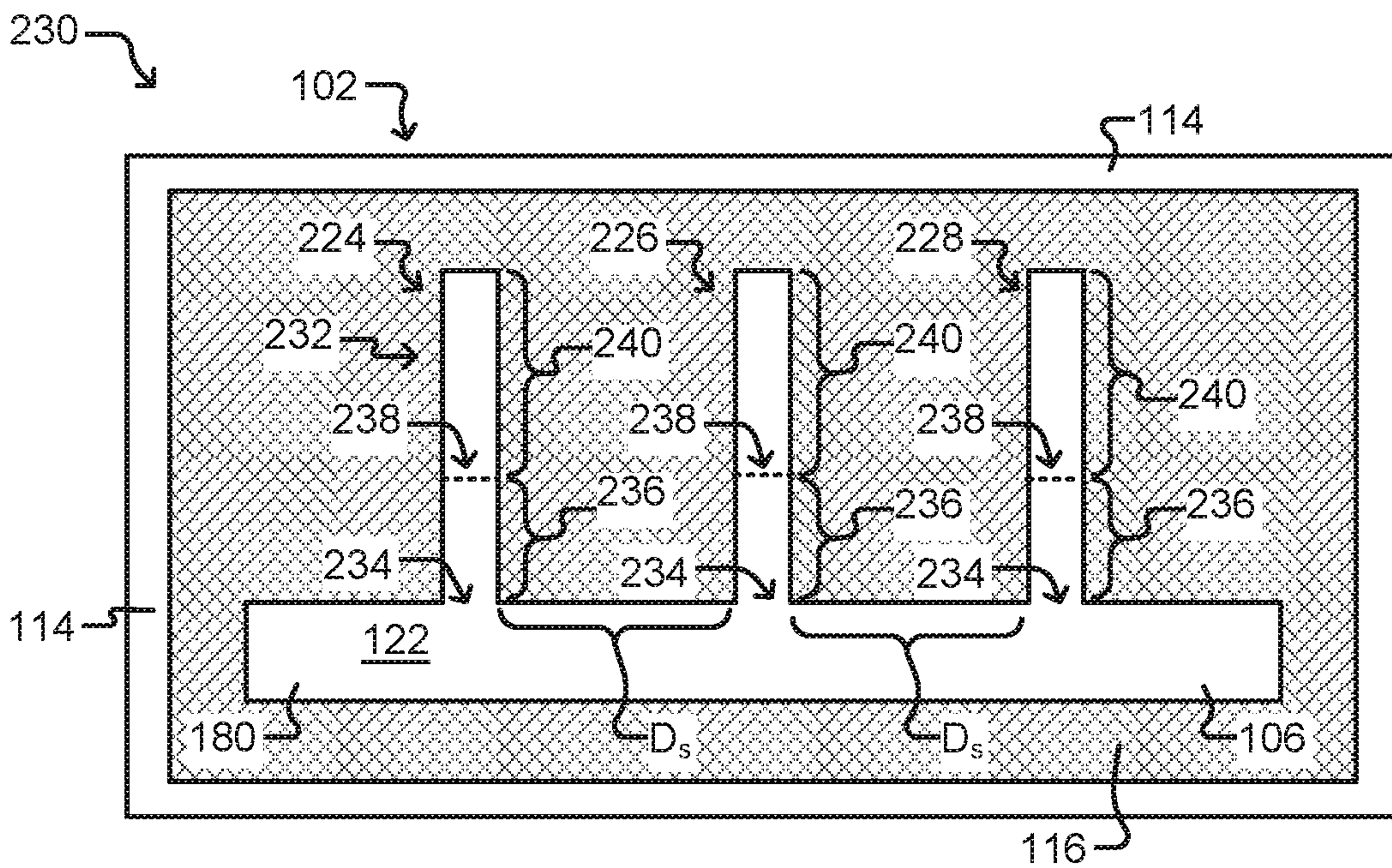

FIG. 2B

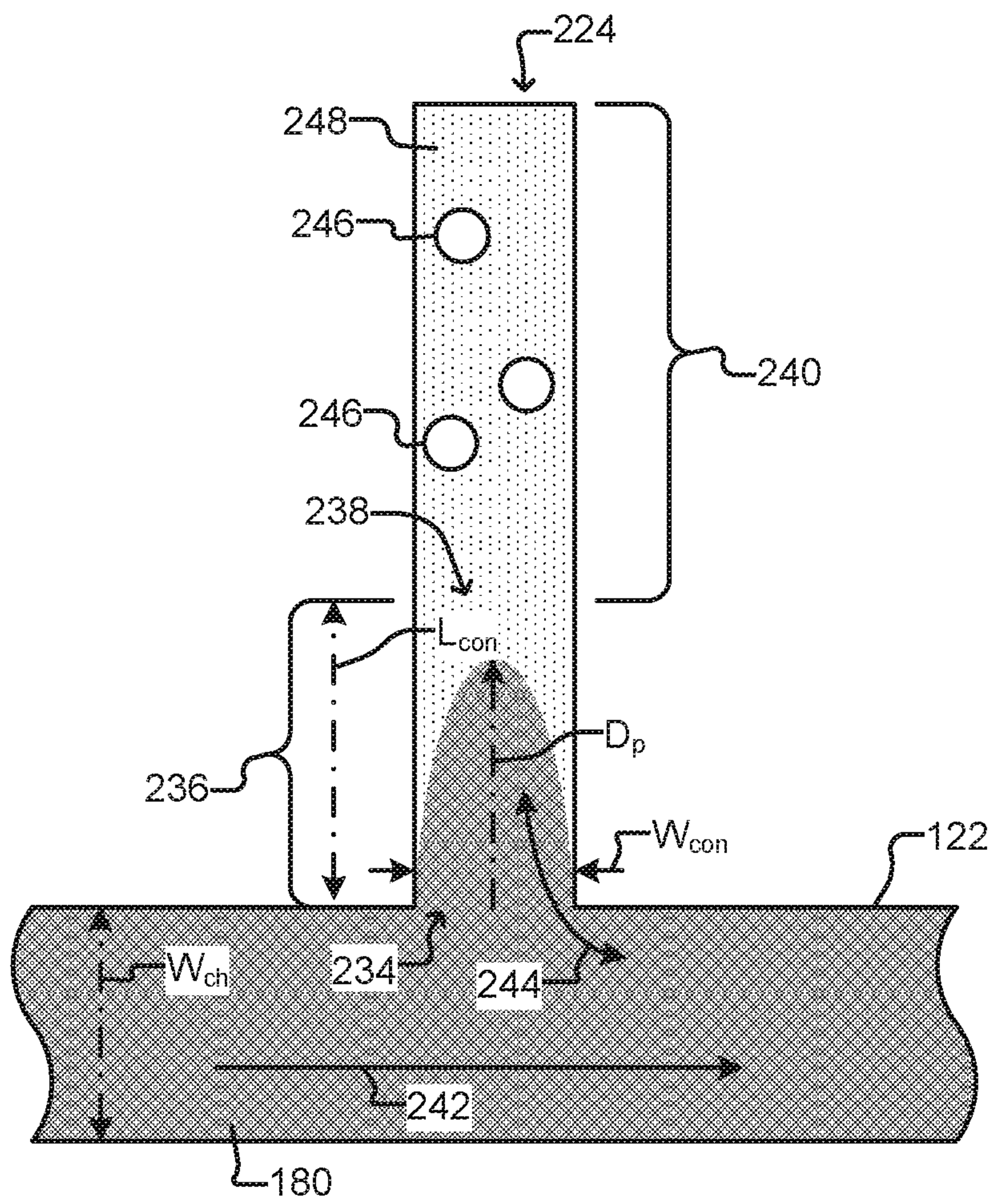

FIG. 2C

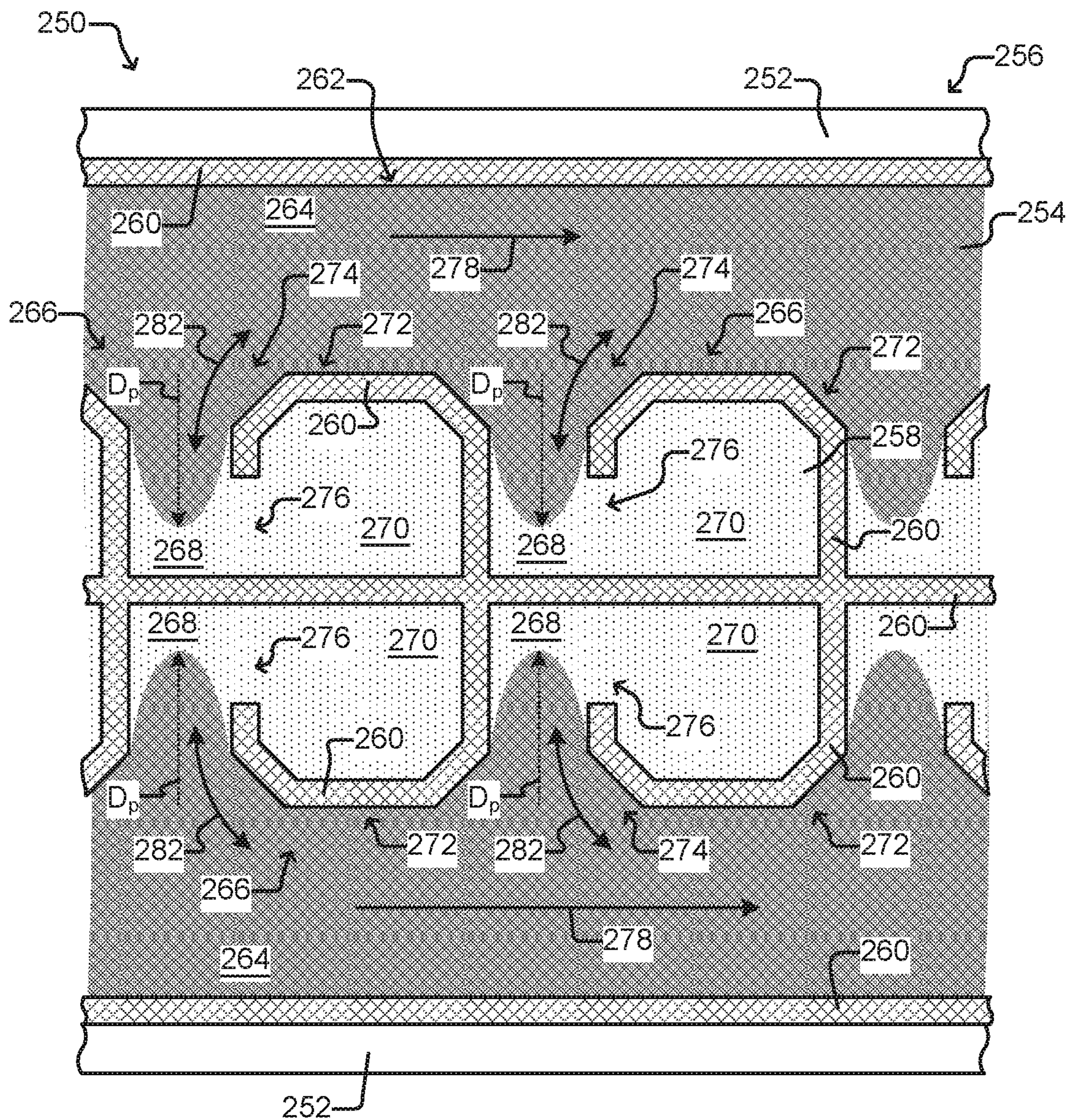

FIG. 2D

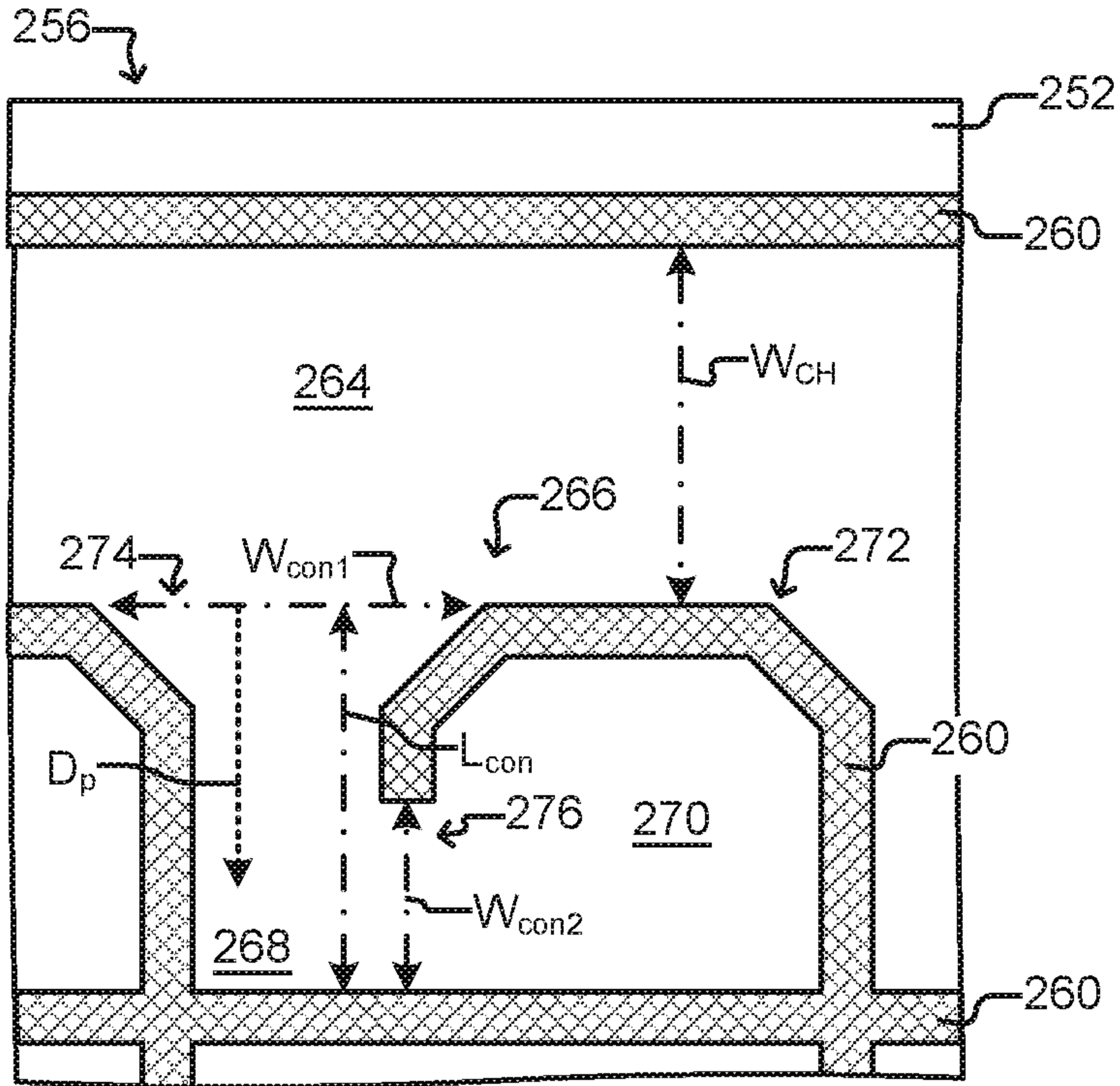

FIG. 2E

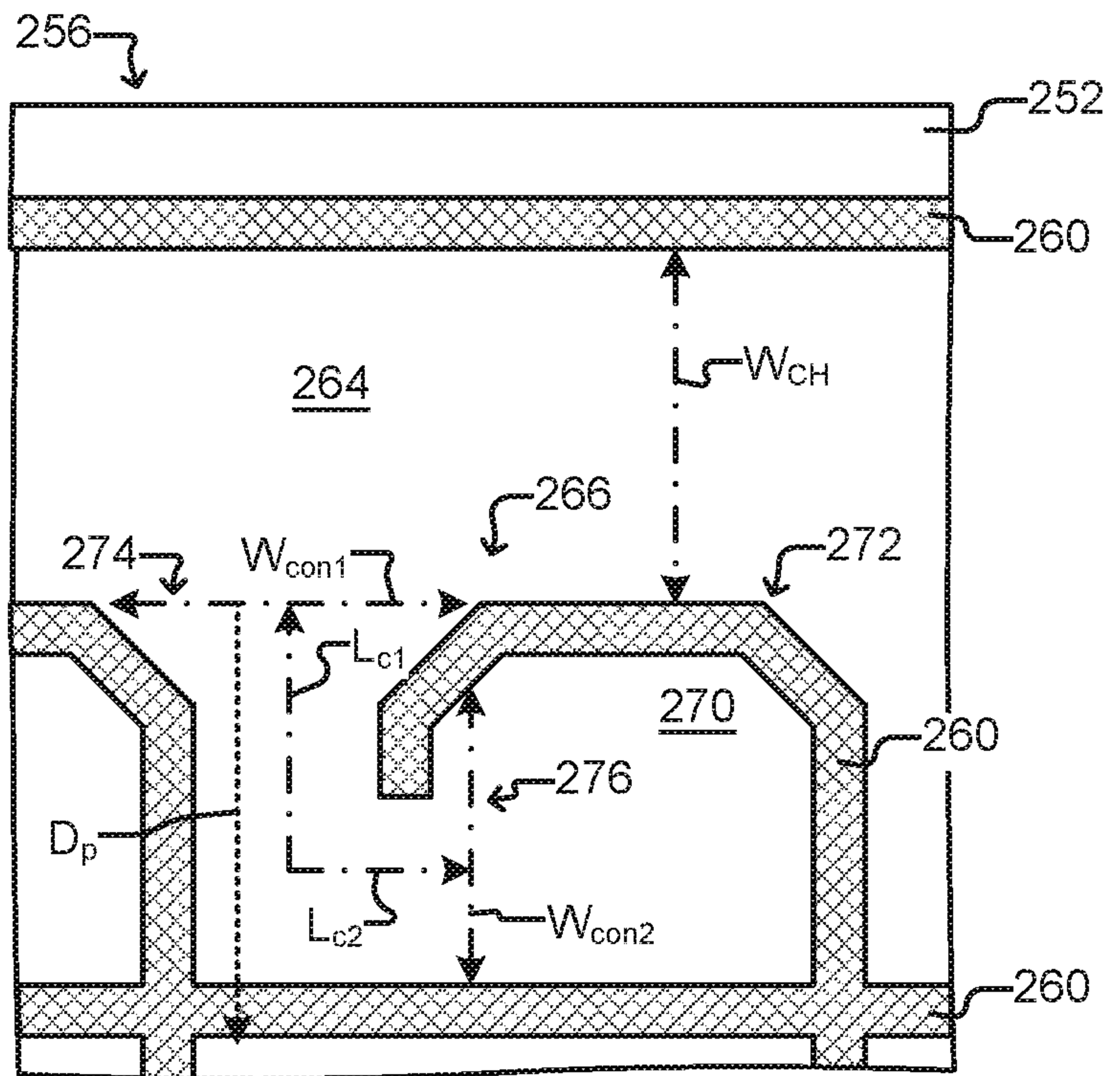

FIG. 2F

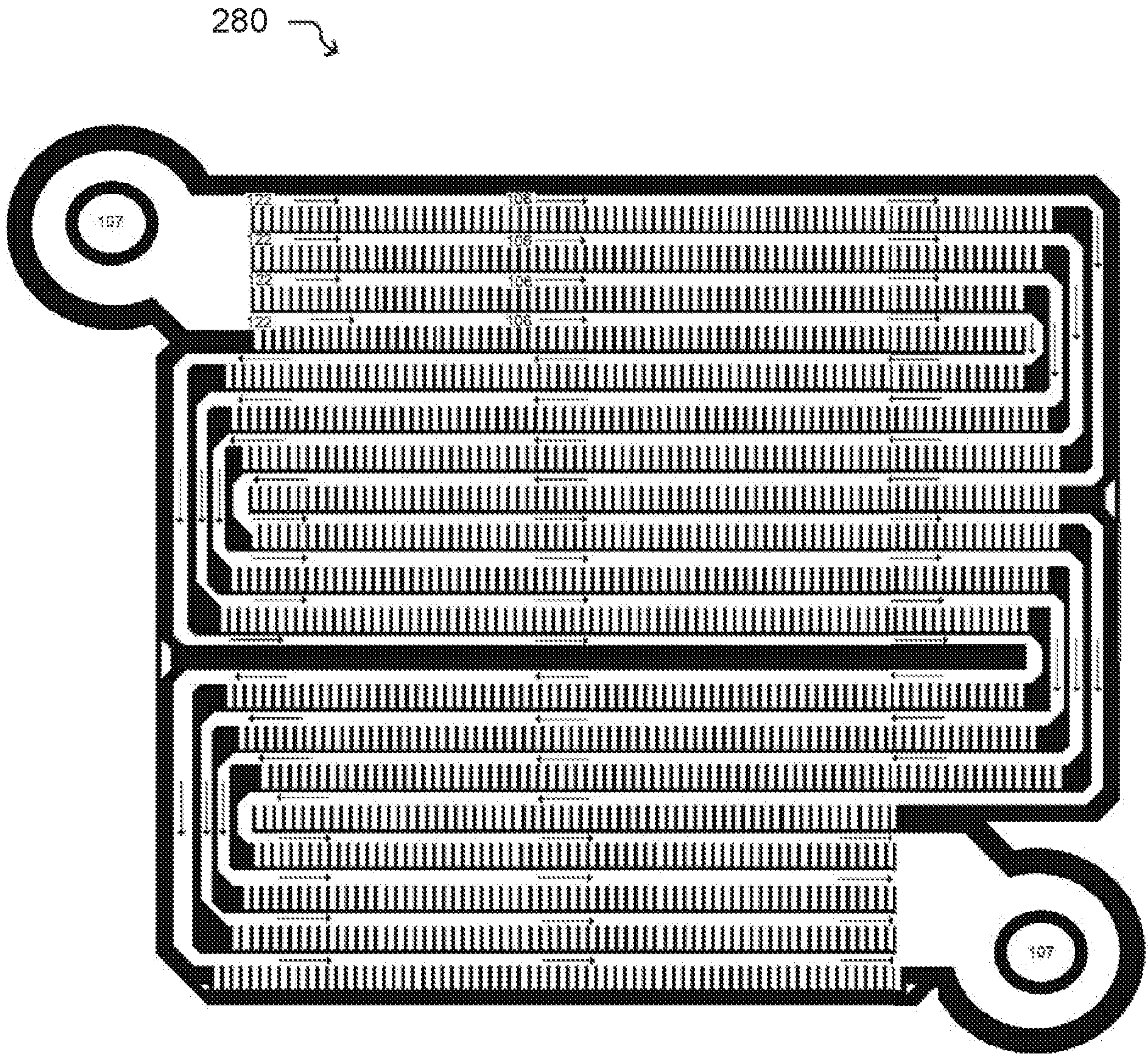

FIG. 2G

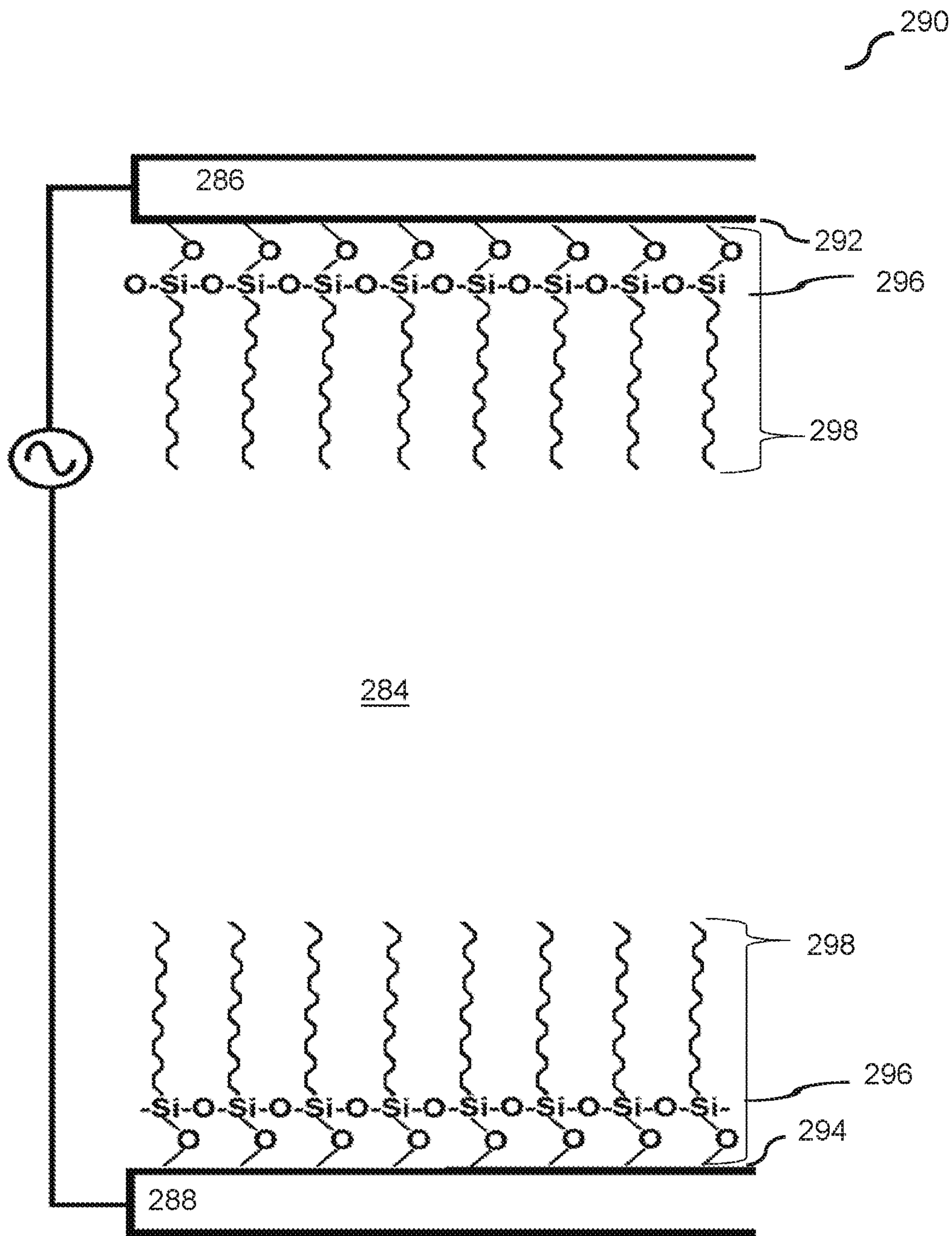

FIG. 2H

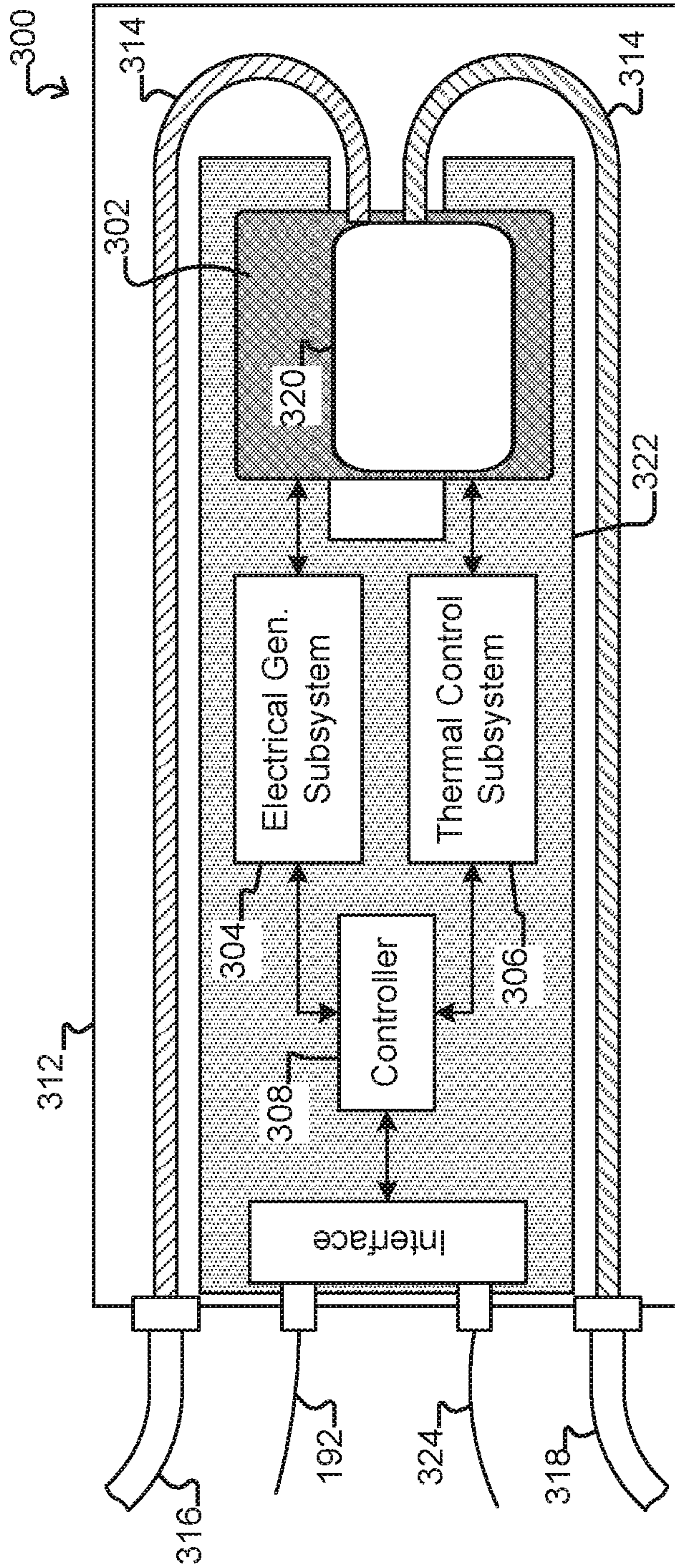

FIG. 3A

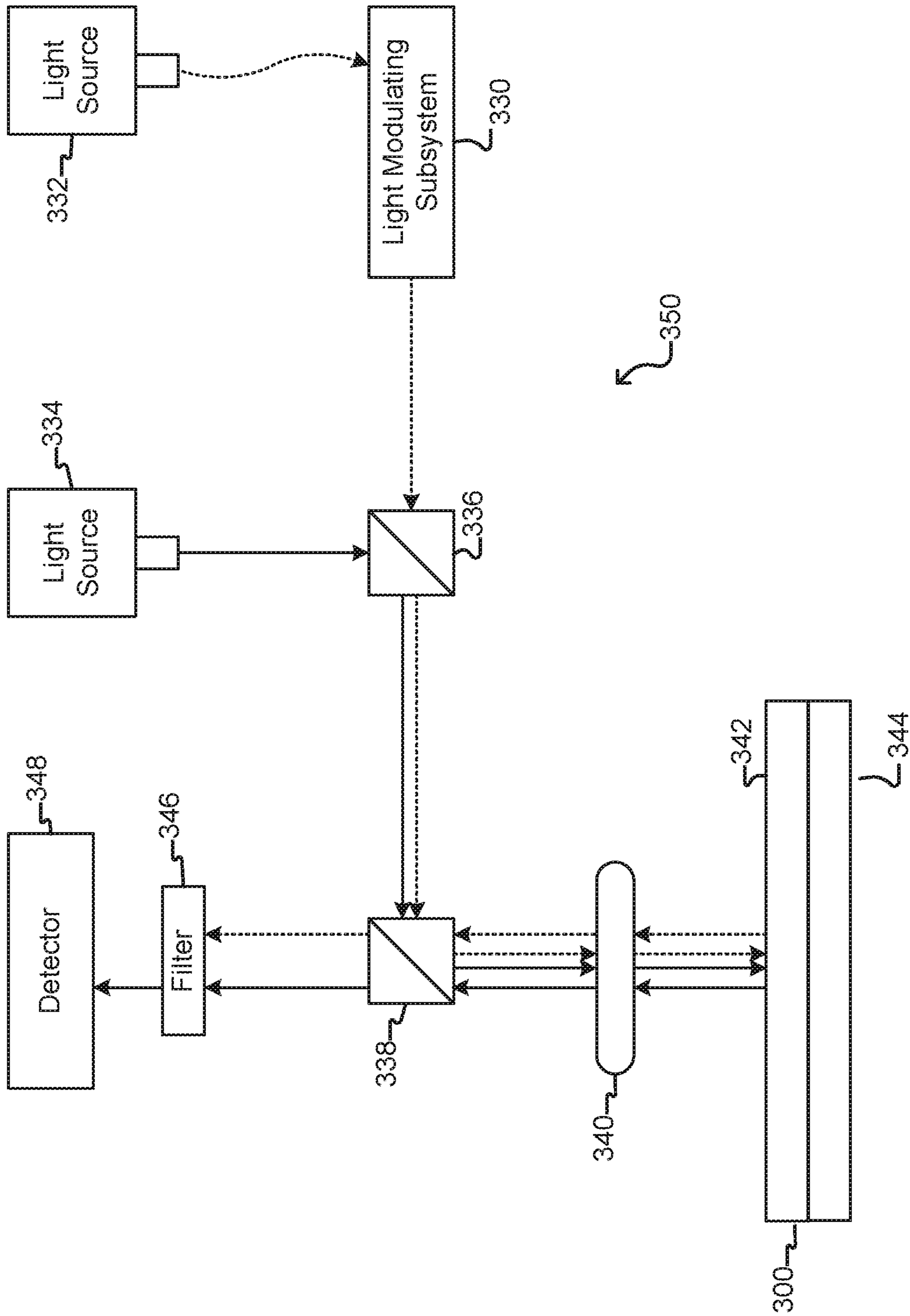

FIG. 3B

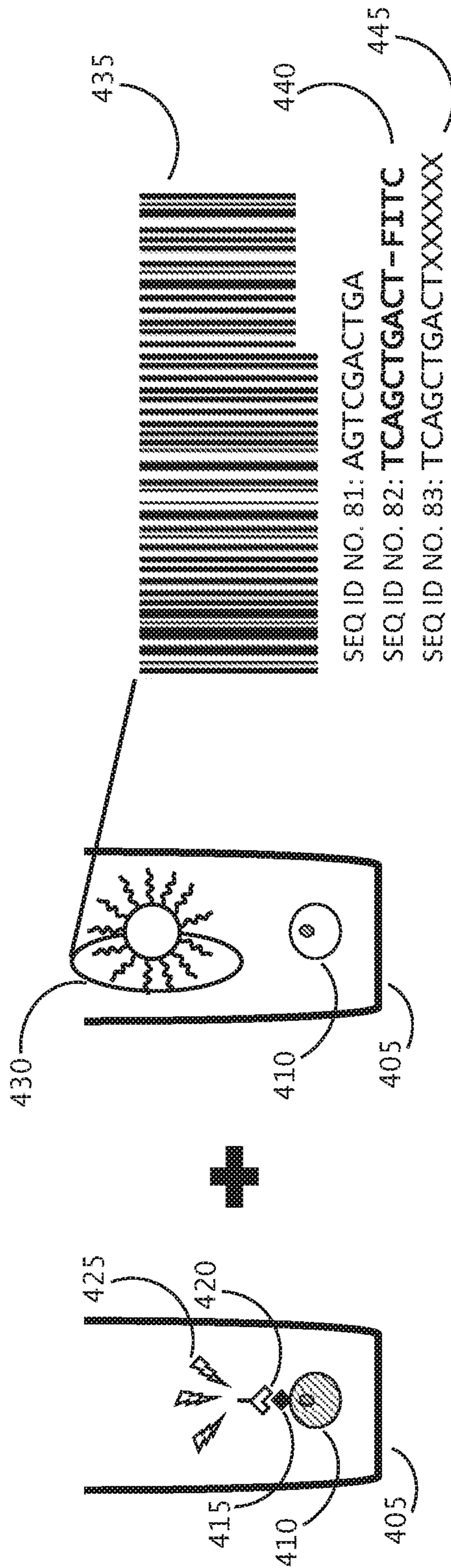

FIG. 4A

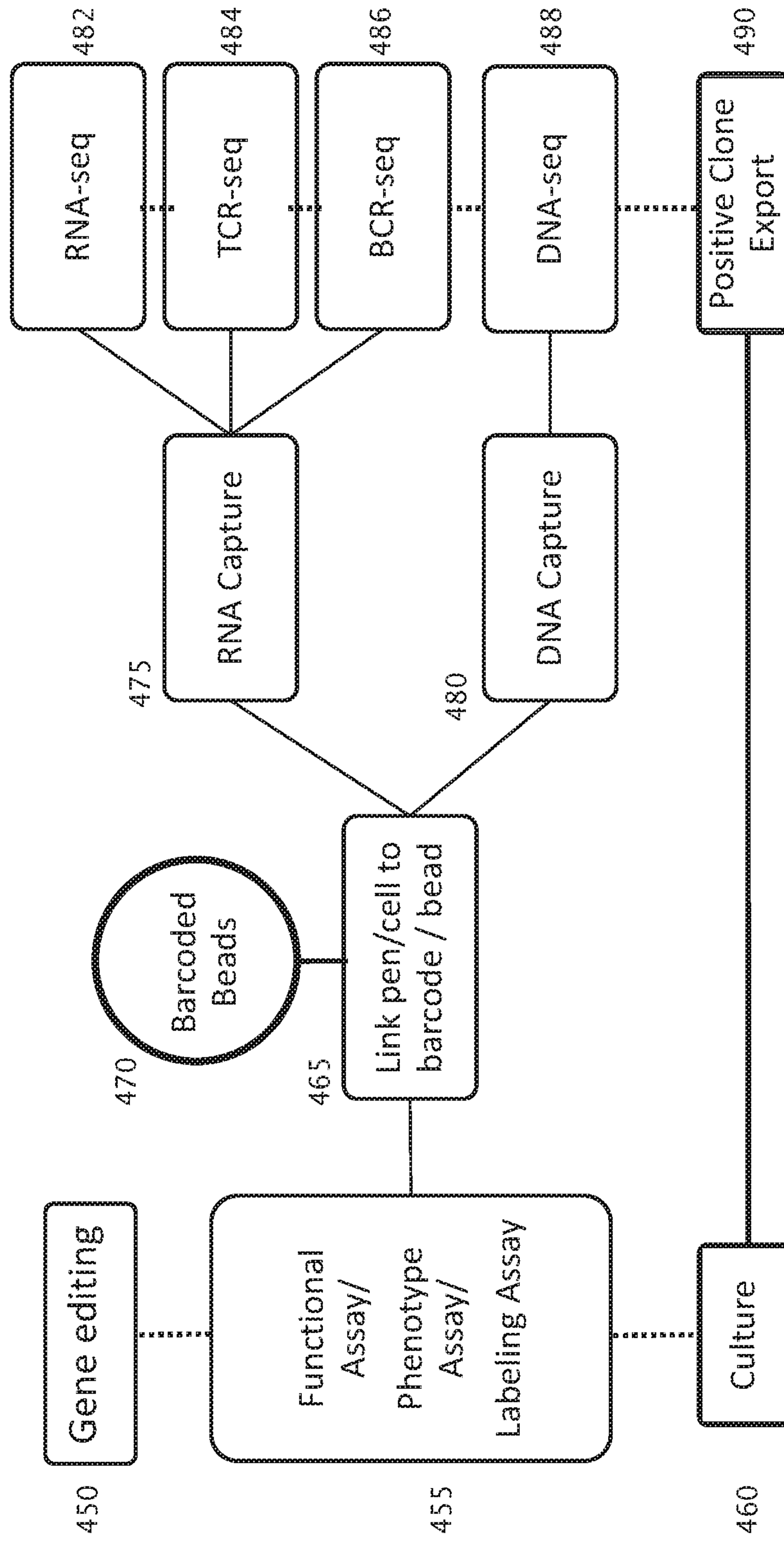

FIG. 4B

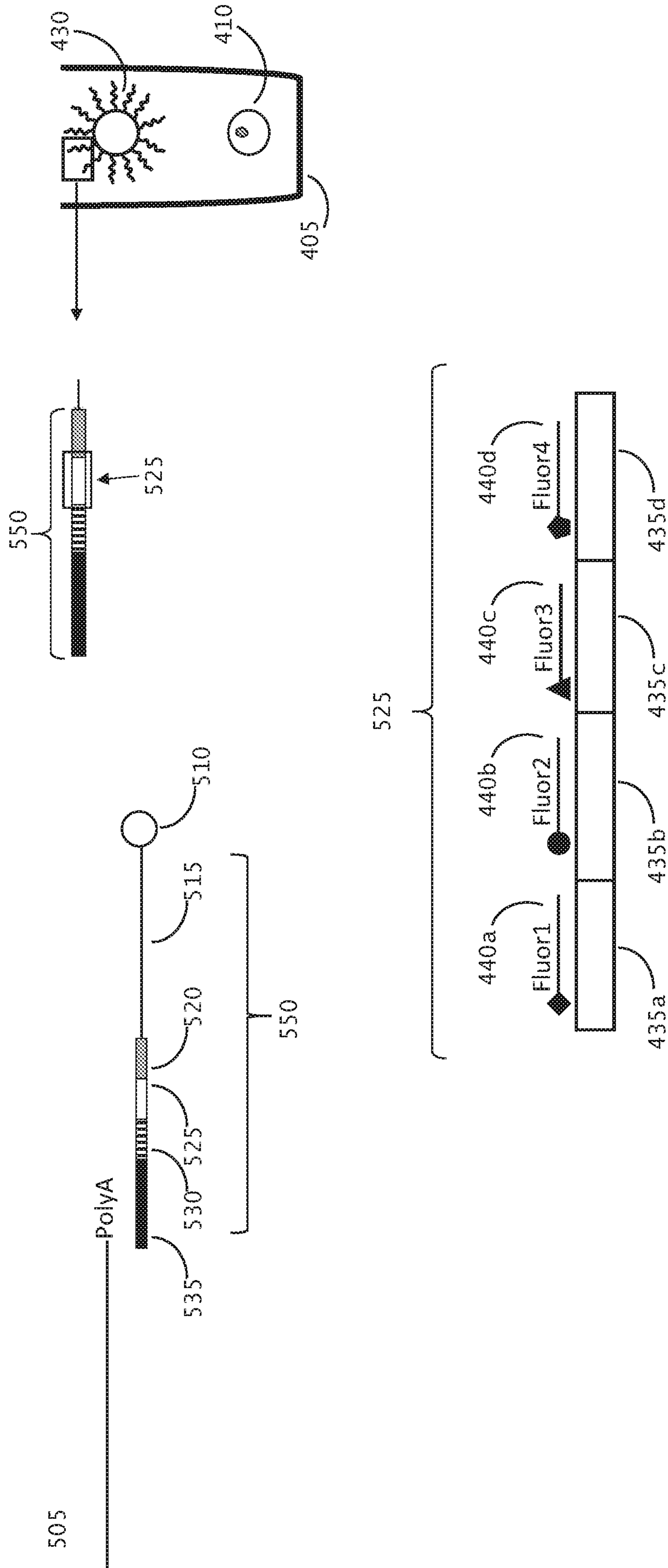

FIG. 5

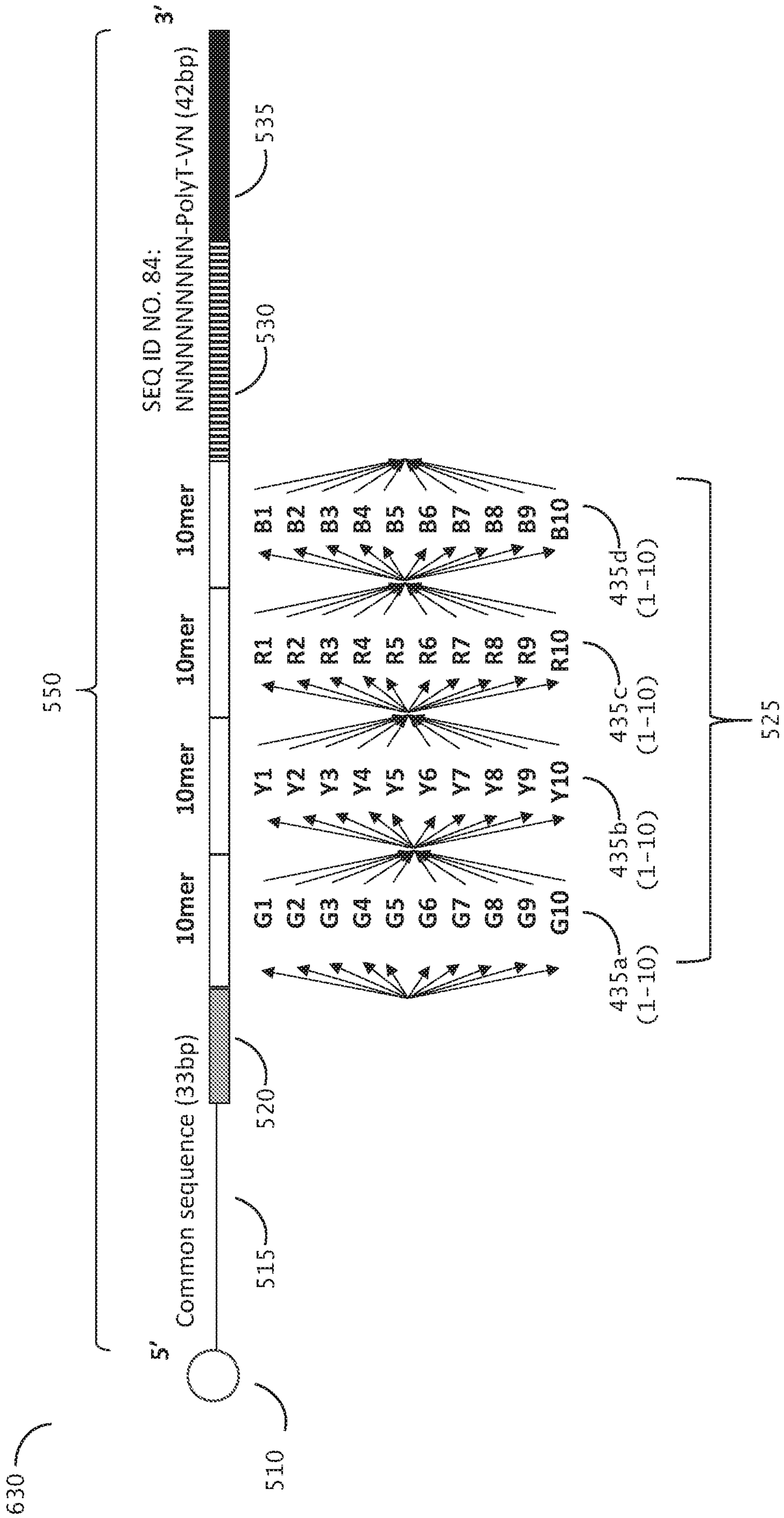

FIG. 6

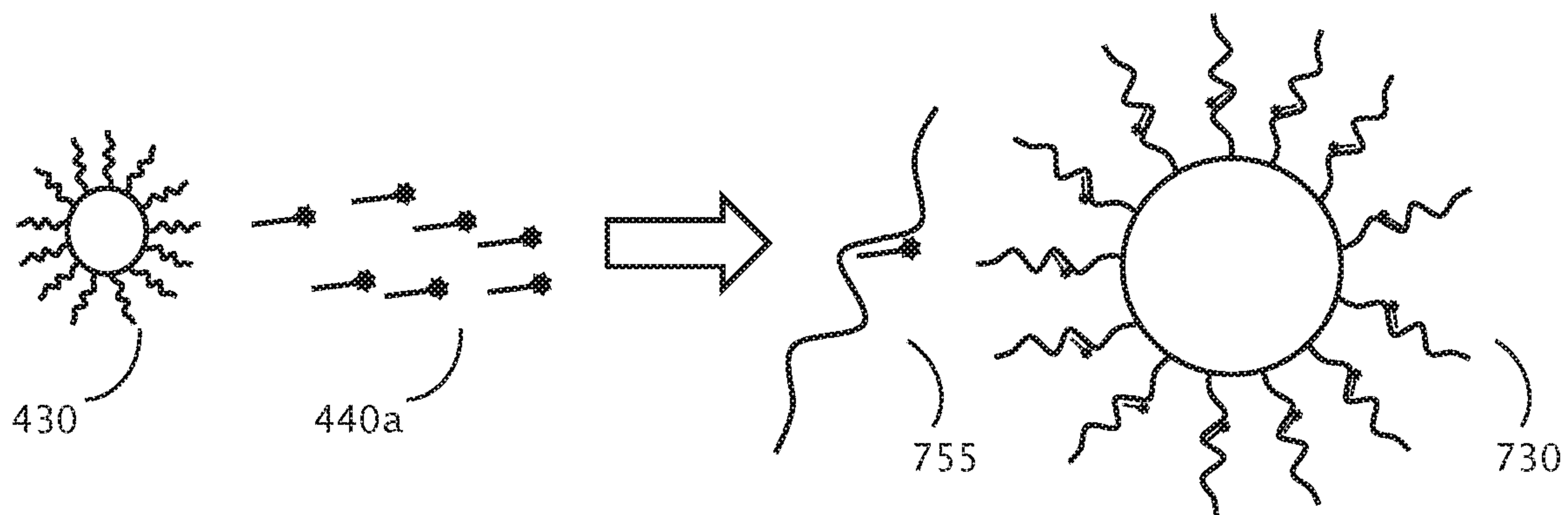

FIG. 7A

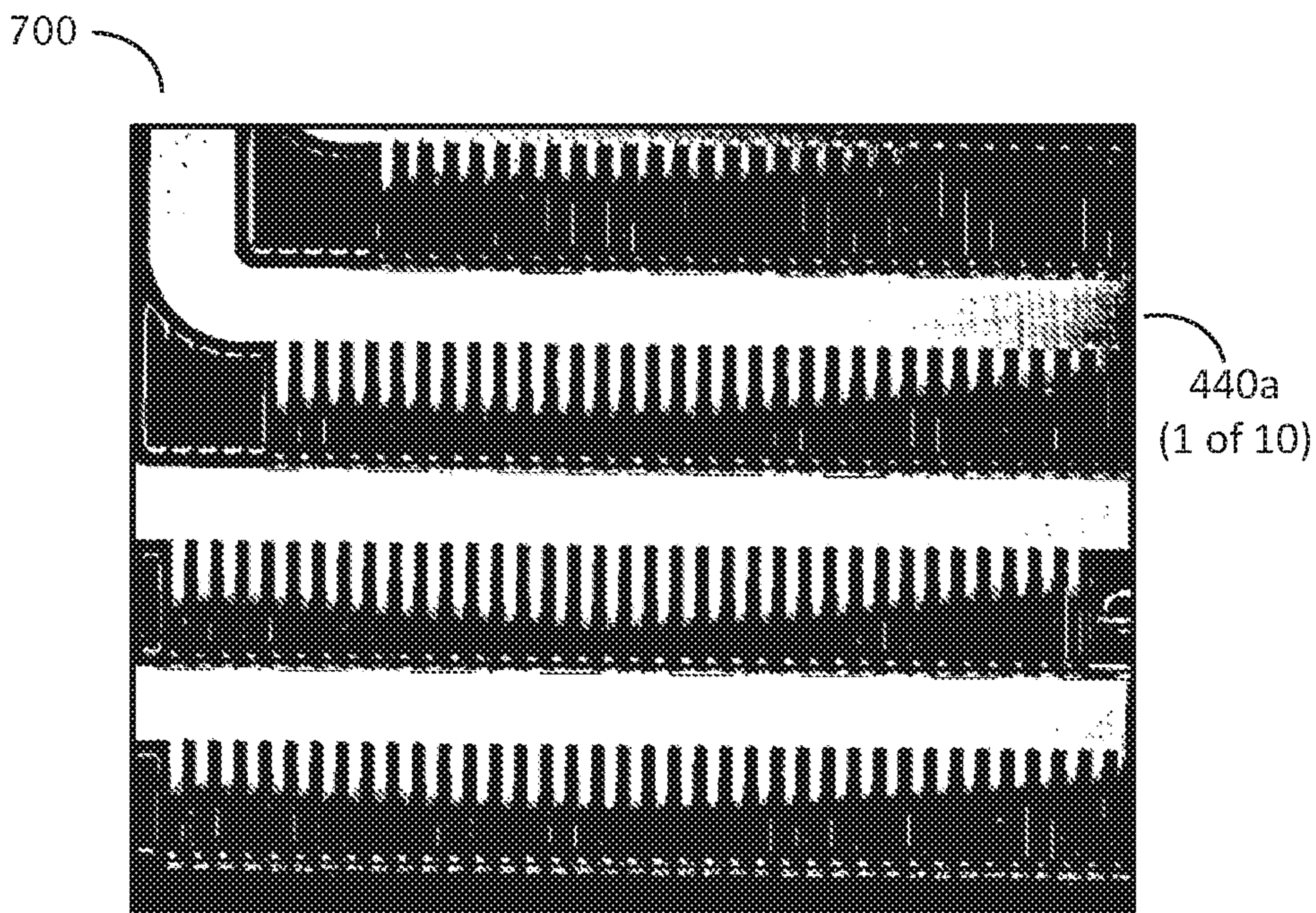

FIG. 7B

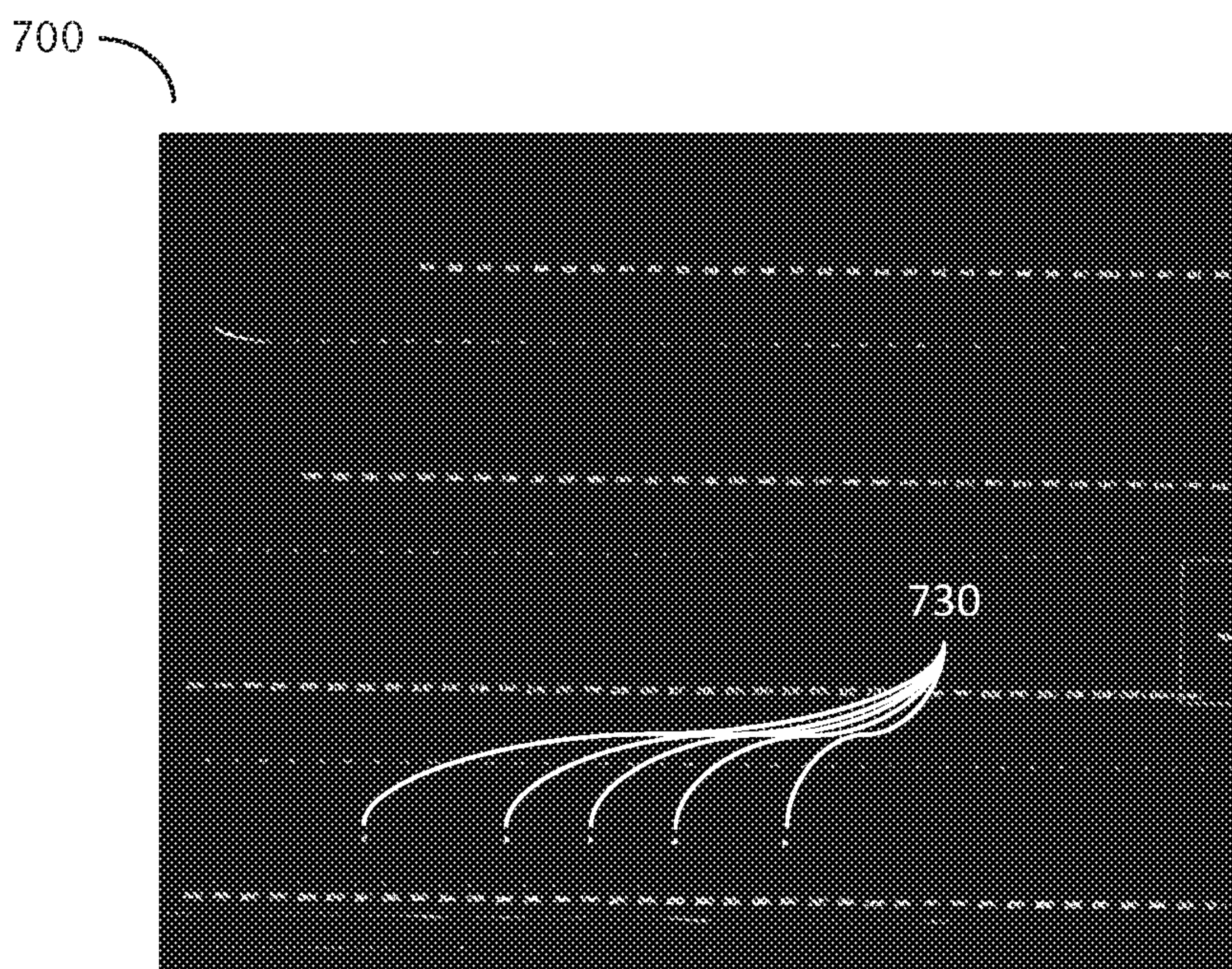

FIG. 7C

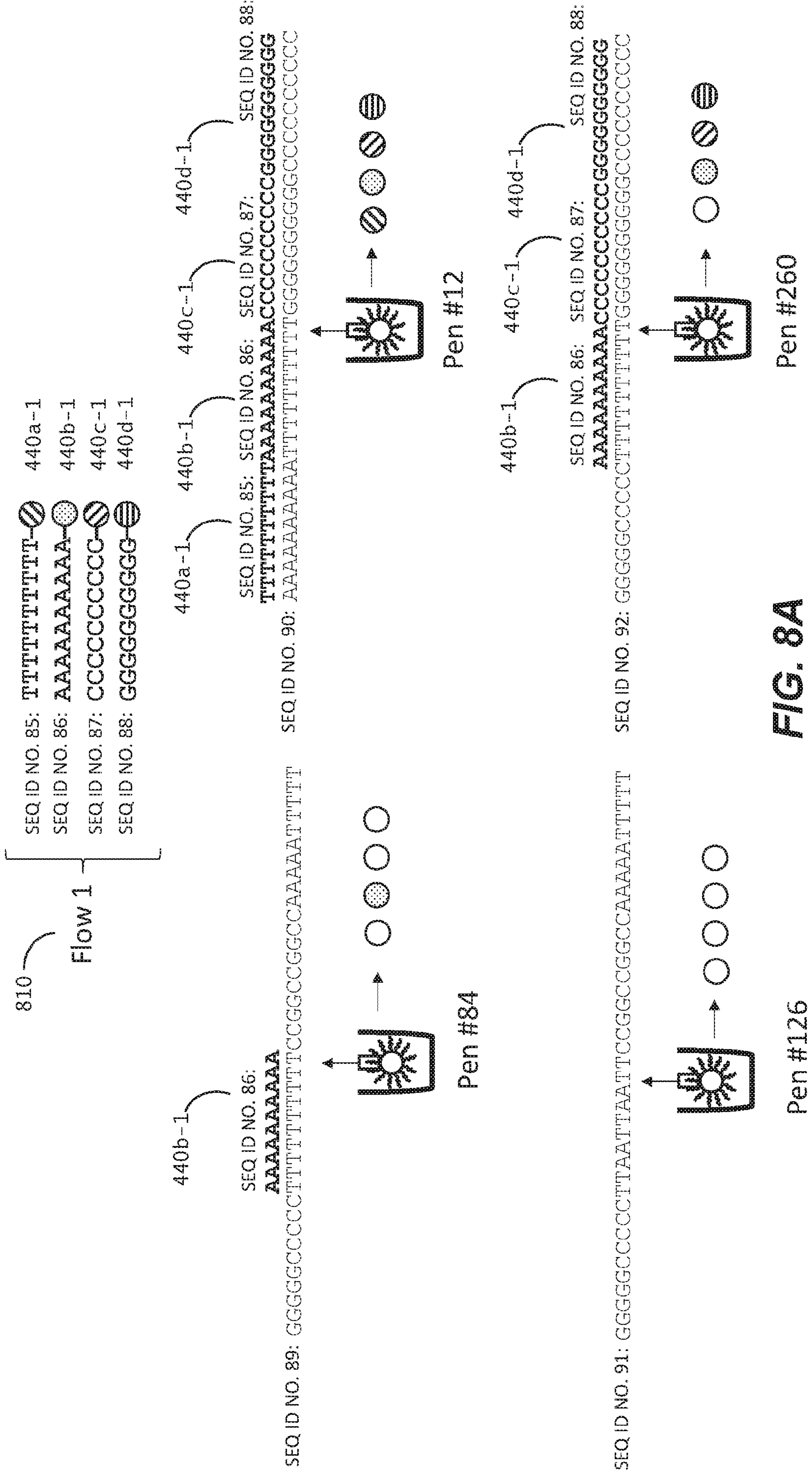

FIG. 8A

815 ————
 Flow 2 ————
 SEQ ID NO. 93: CCCCCGGGGG — 440a-2
 SEQ ID NO. 94: AATTAAATAA — 440b-2
 SEQ ID NO. 95: GGCCGGCCGG — 440c-2
 SEQ ID NO. 96: TTTTAAAAA — 440d-2

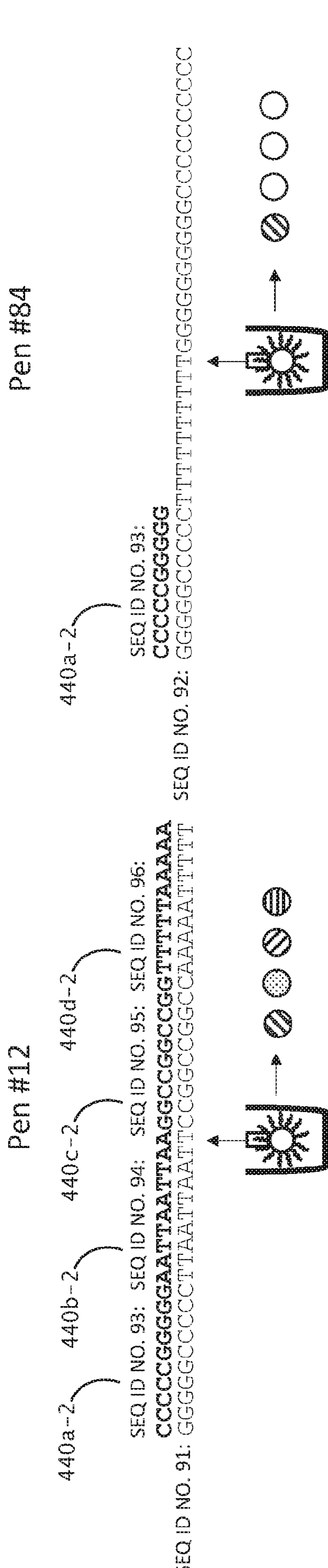
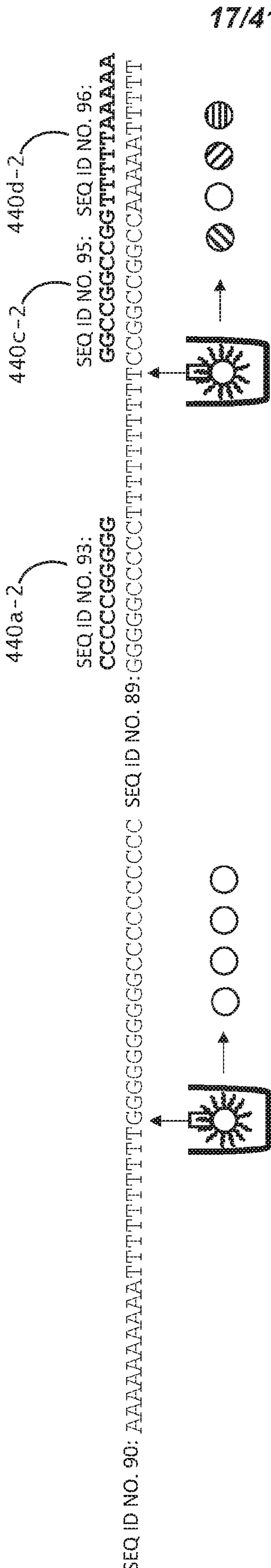

FIG. 8B

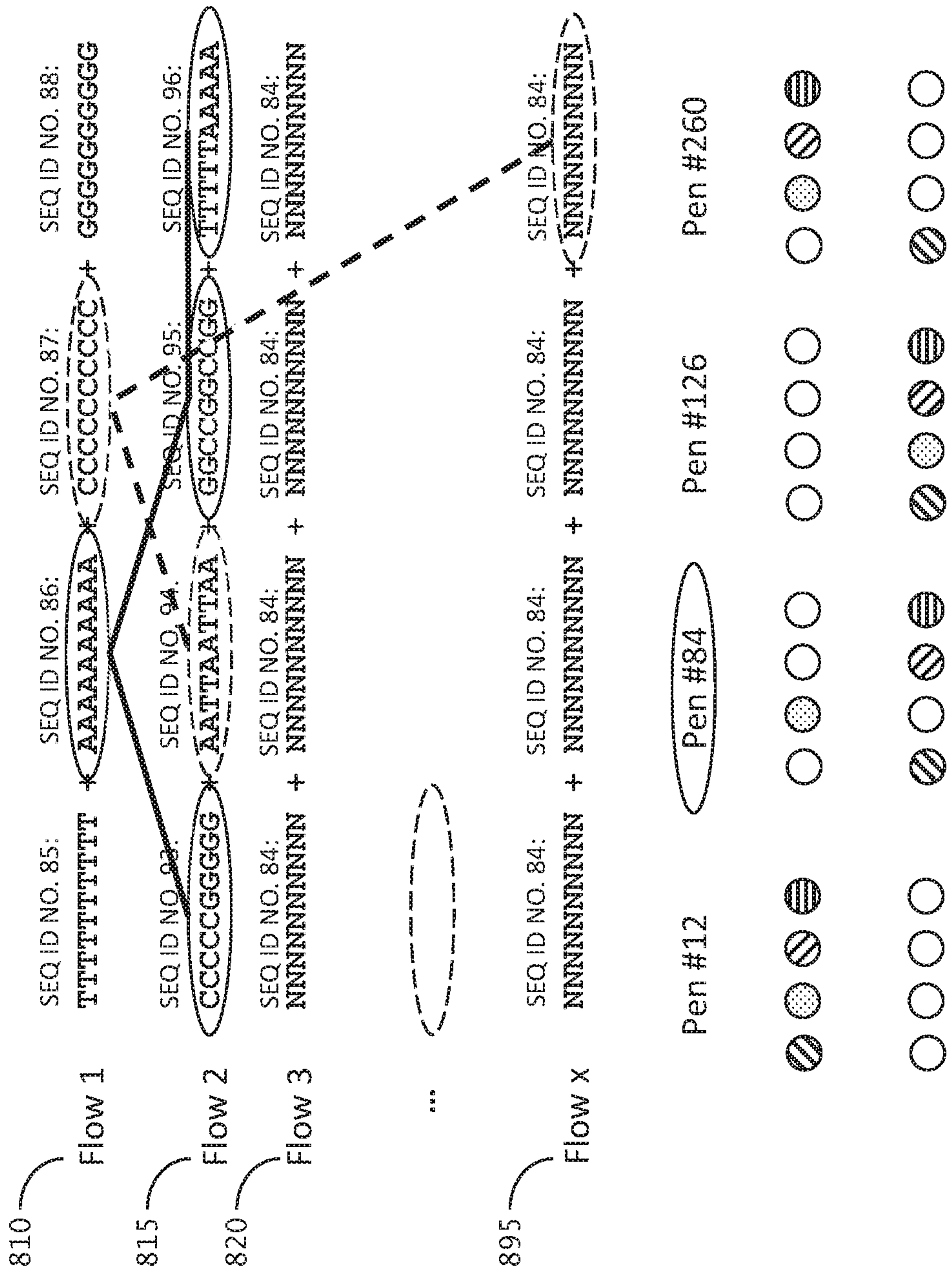

FIG. 8C

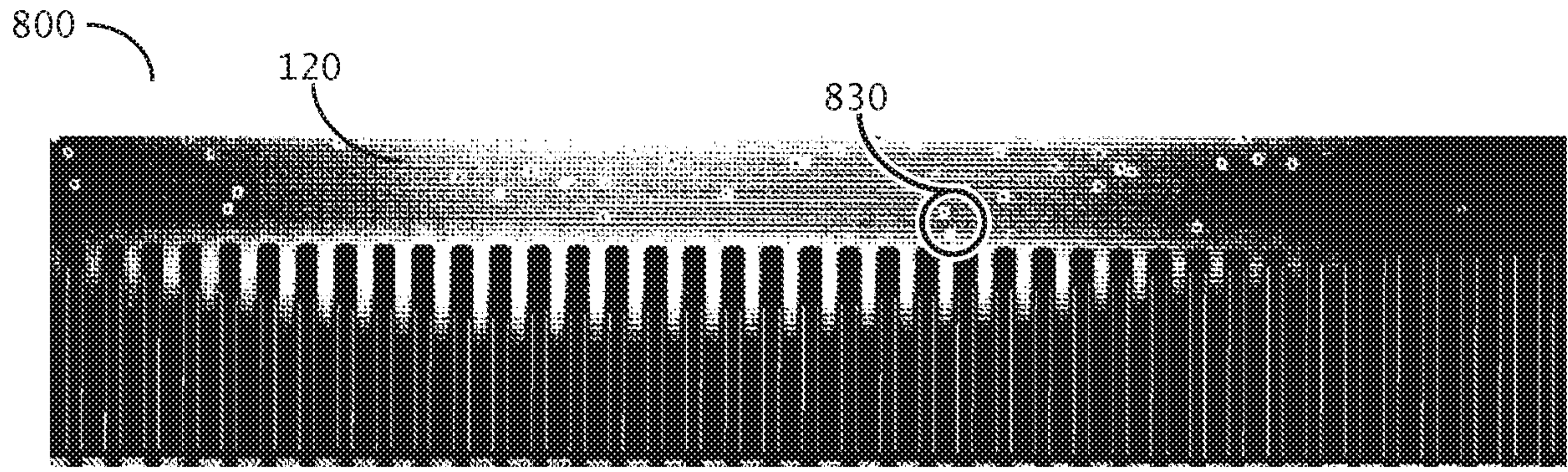

FIG. 8D

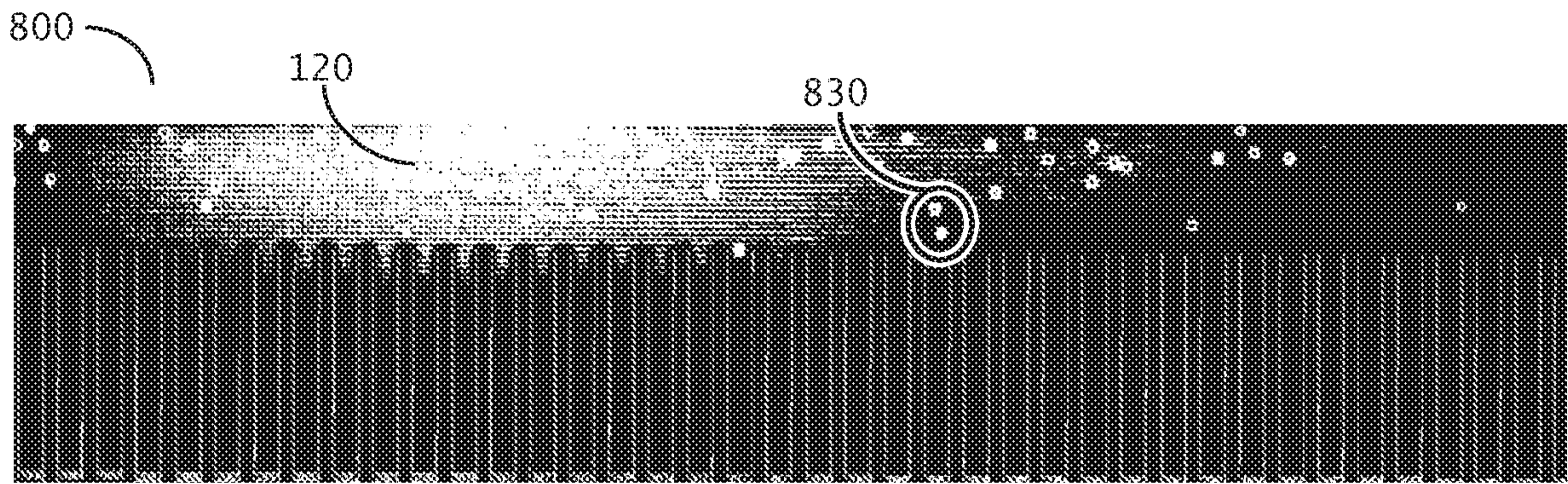

FIG. 8E

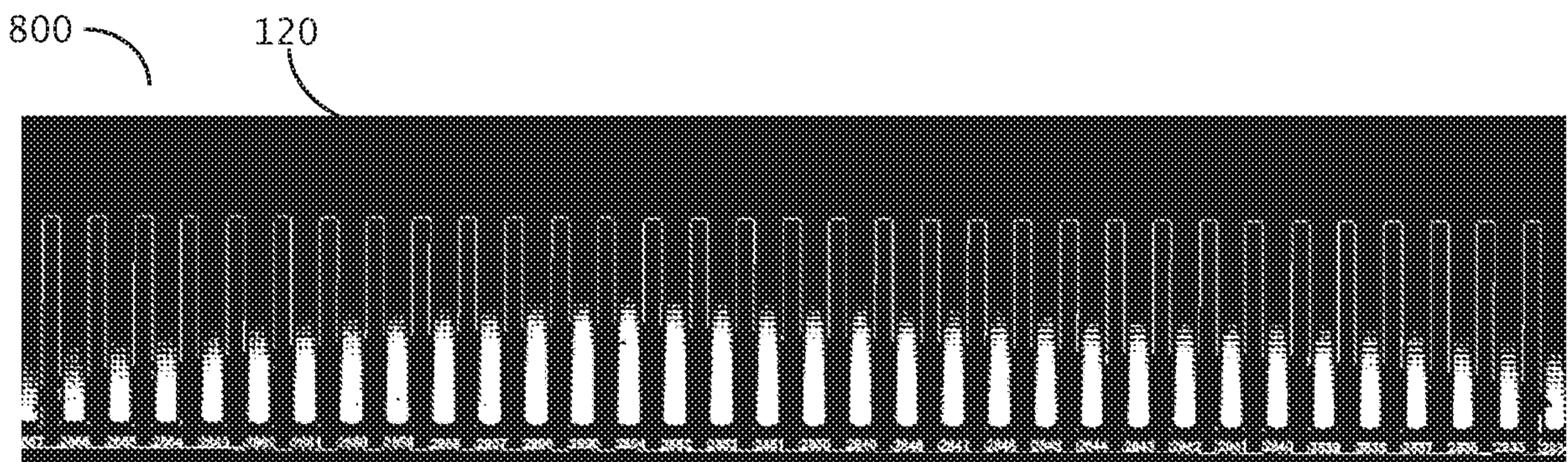
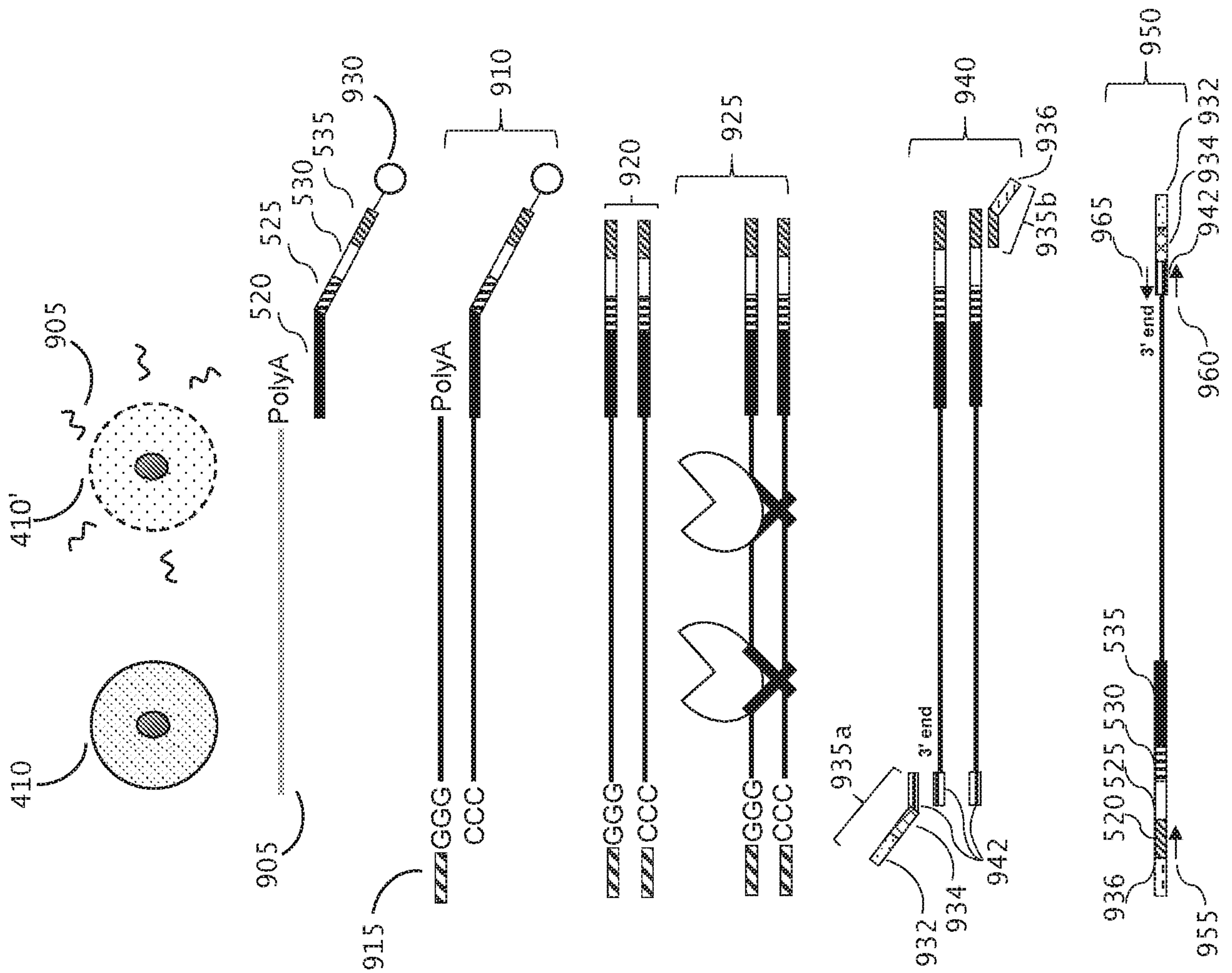
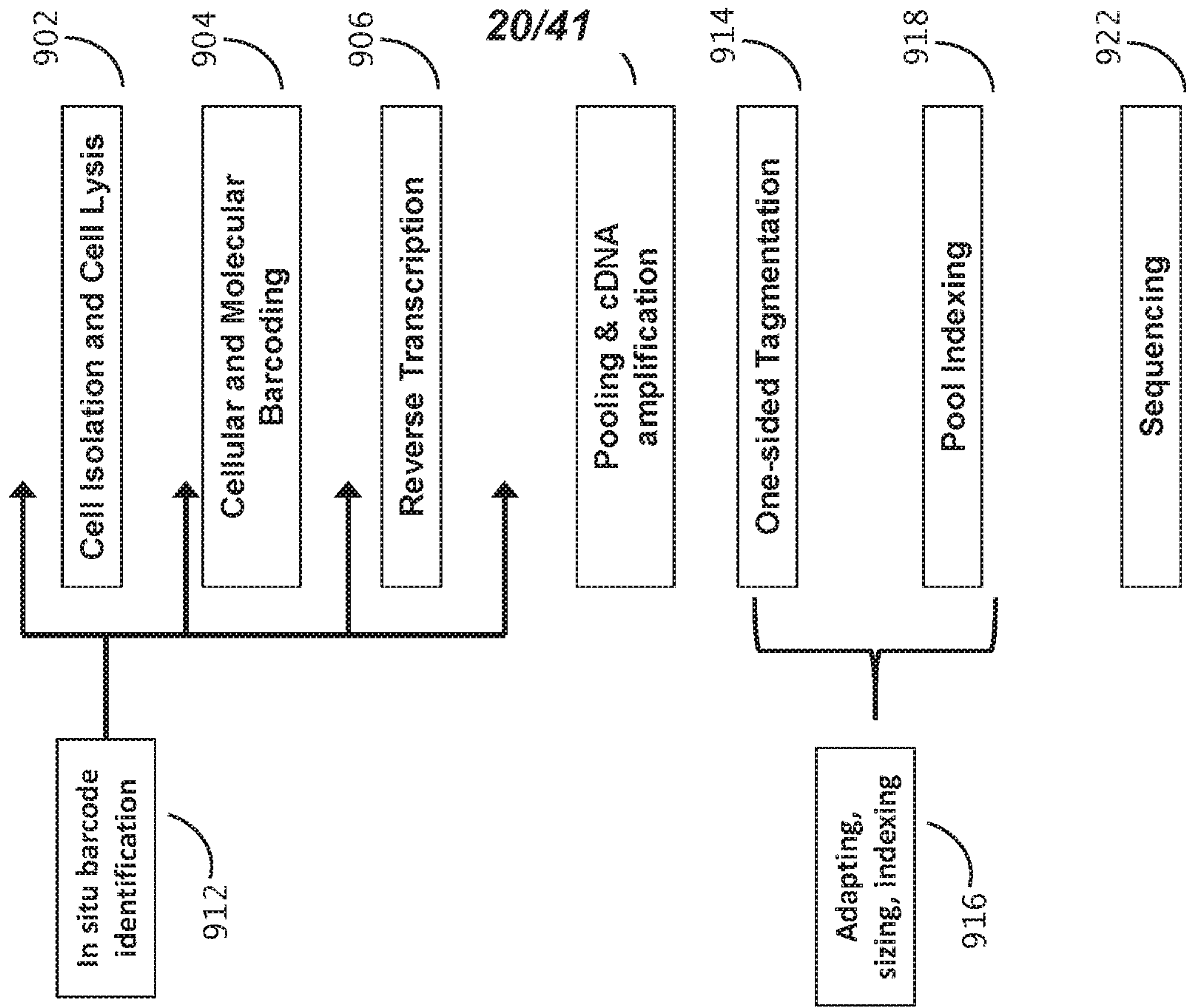

FIG. 8F



SUBSTITUTE SHEET (RULE 26)



20/41

FIG. 9

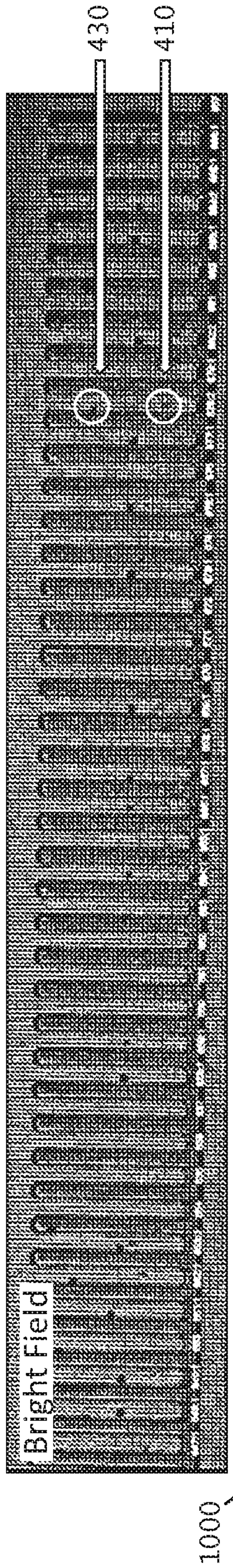

FIG. 10A

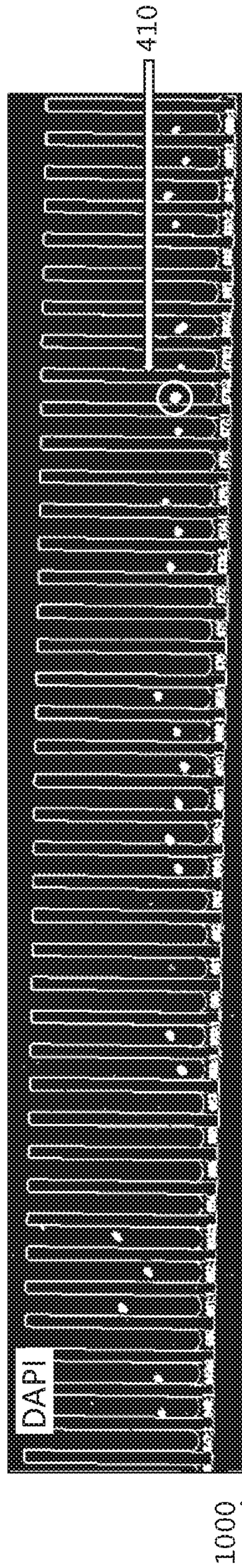

FIG. 10B

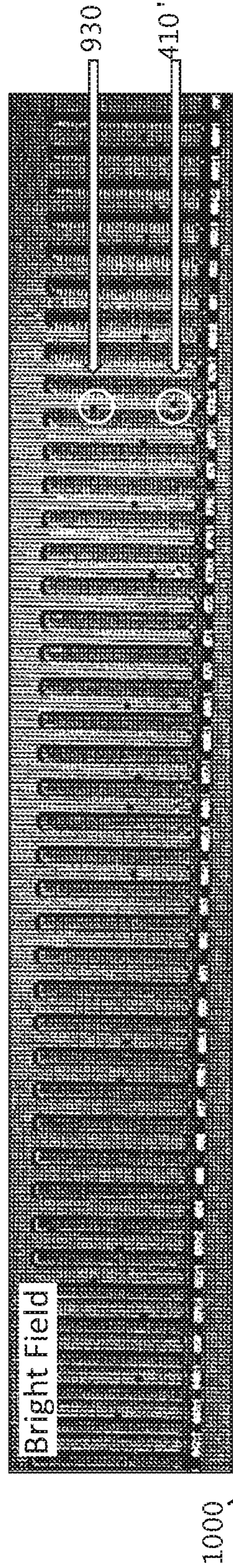

FIG. 10C

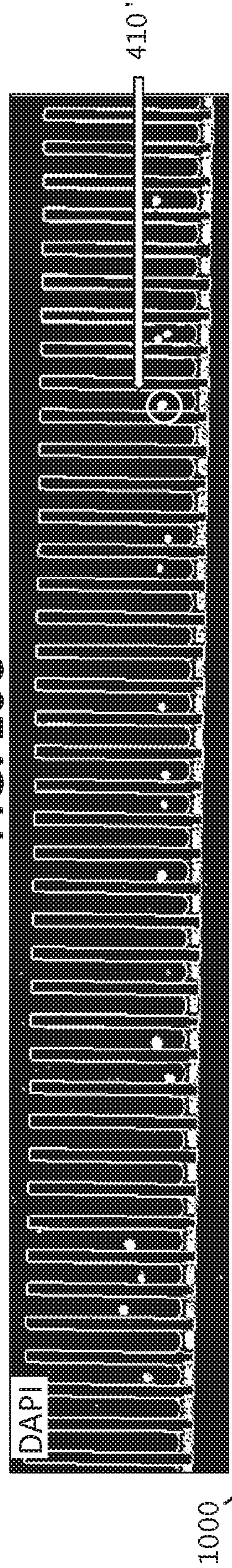

FIG. 10D

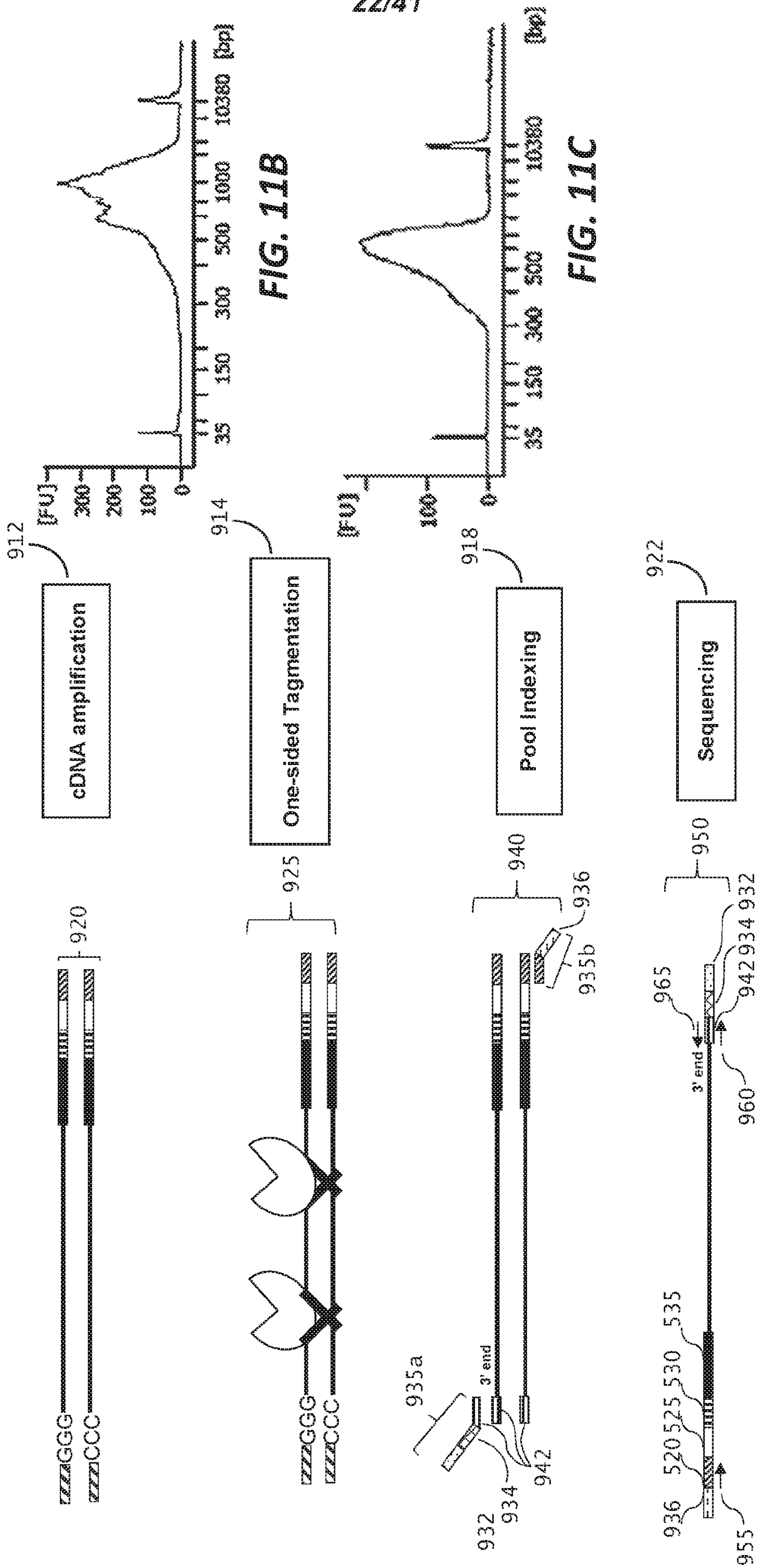

FIG. 11B

FIG. 11C

FIG. 11A

23/41

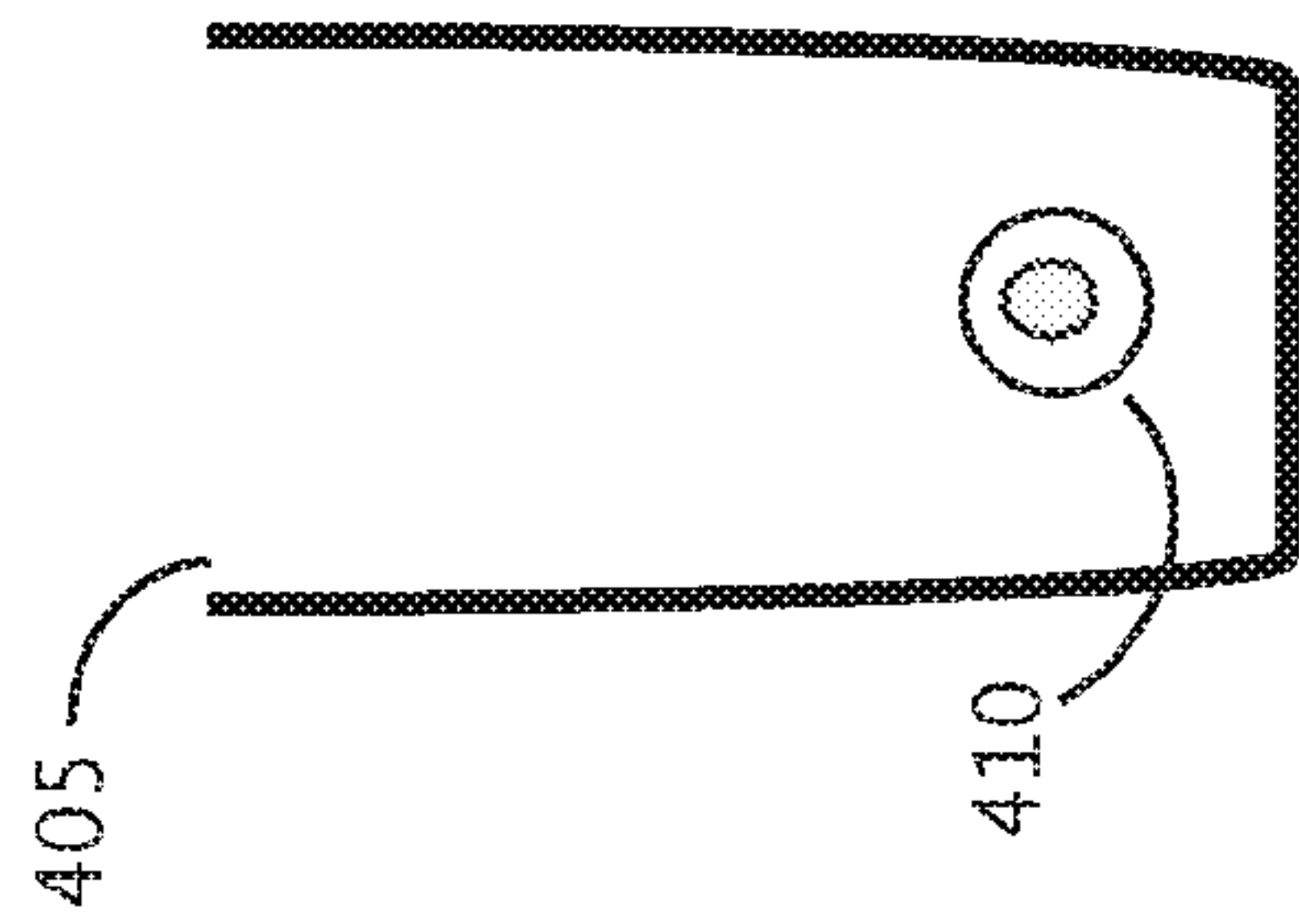

FIG. 12A

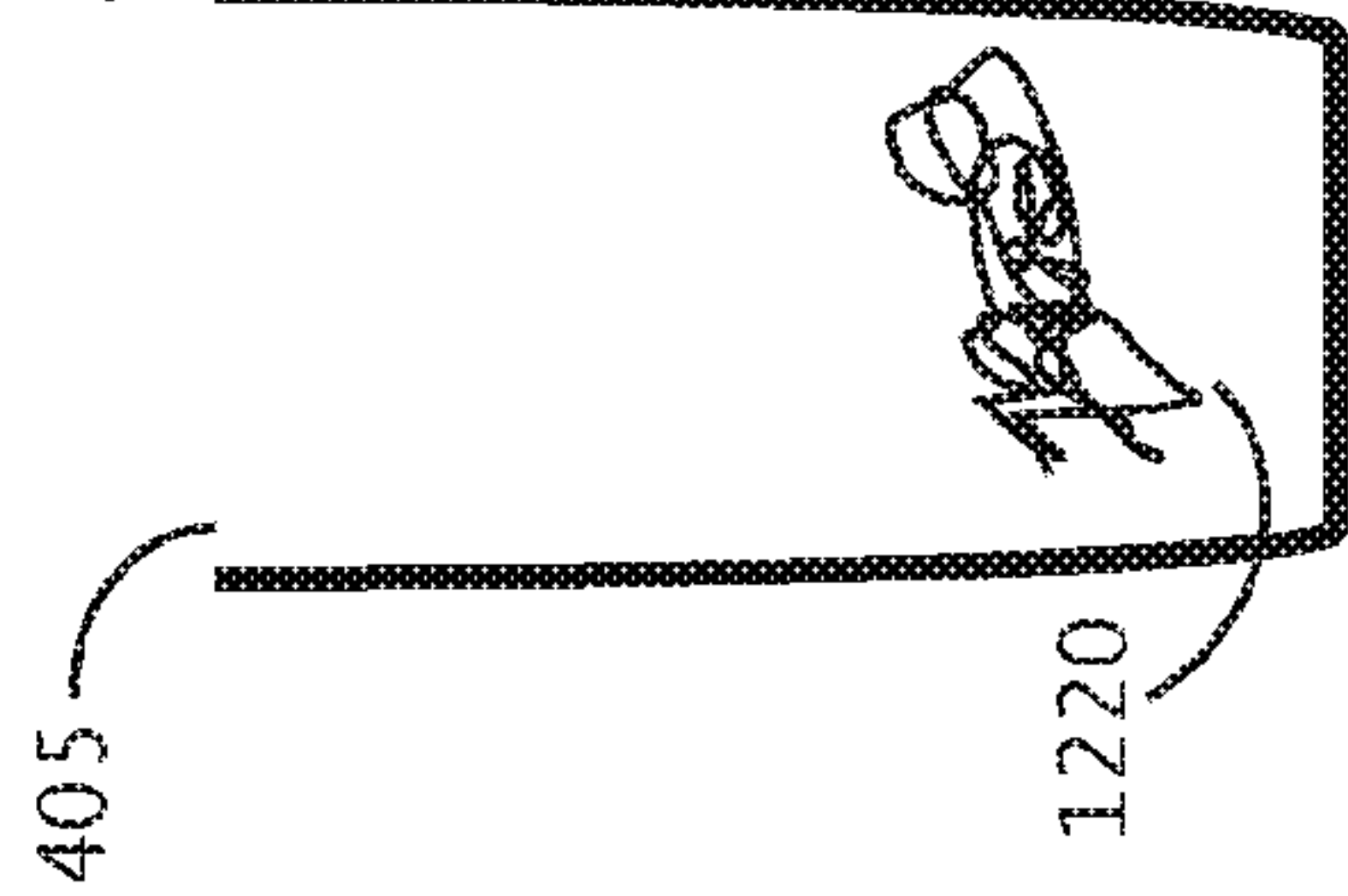

FIG. 12B

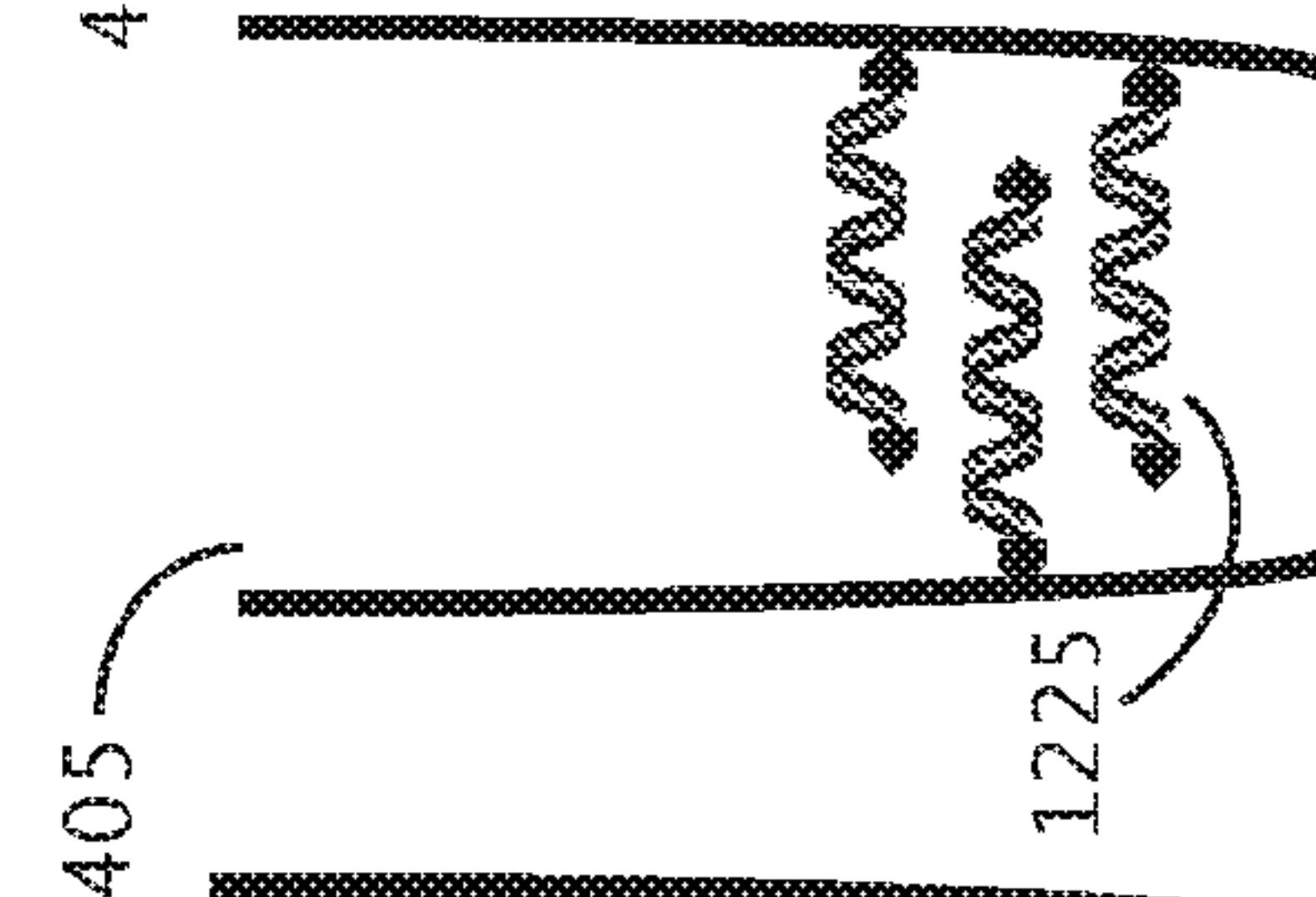

FIG. 12C

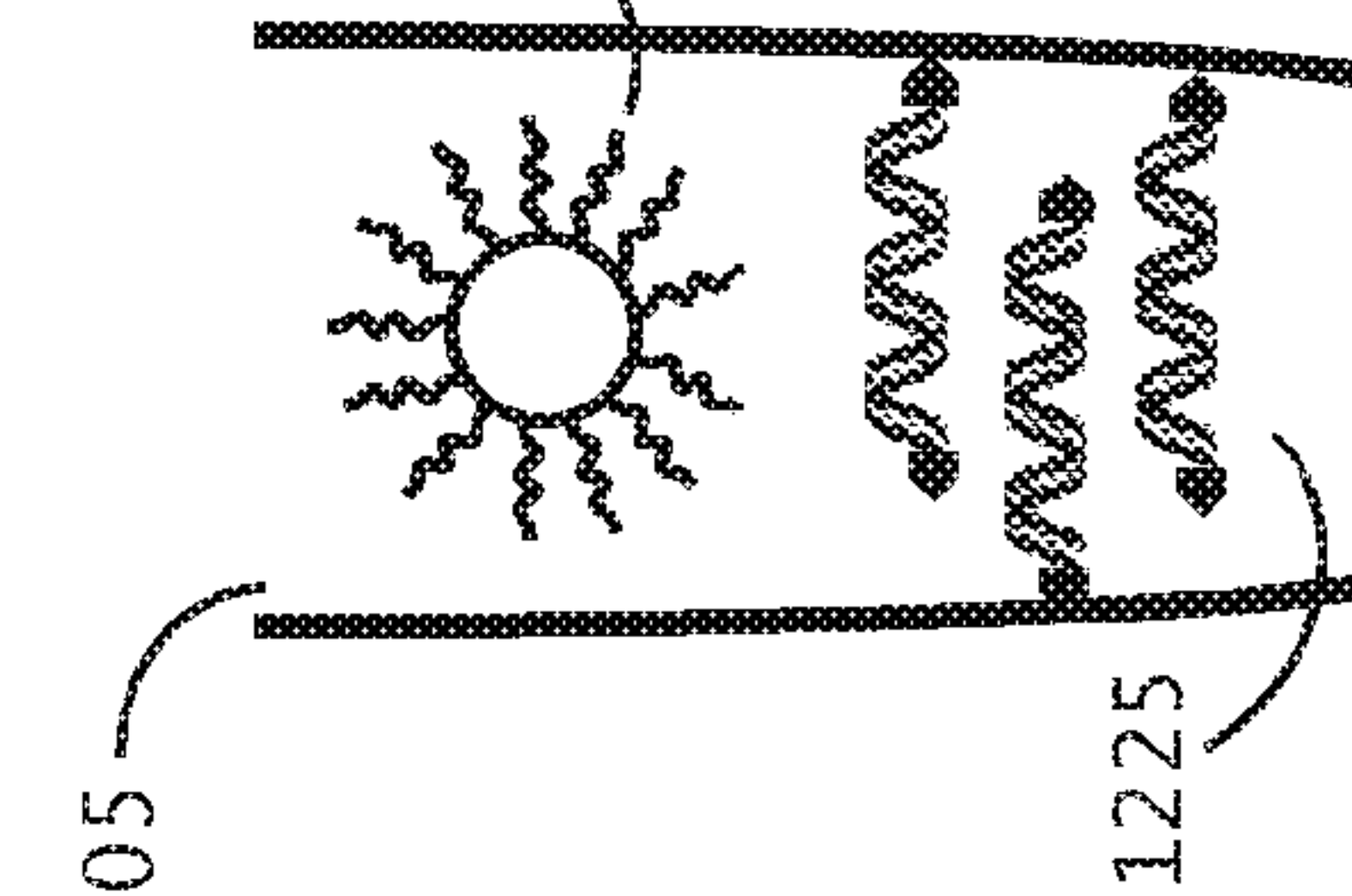

FIG. 12D

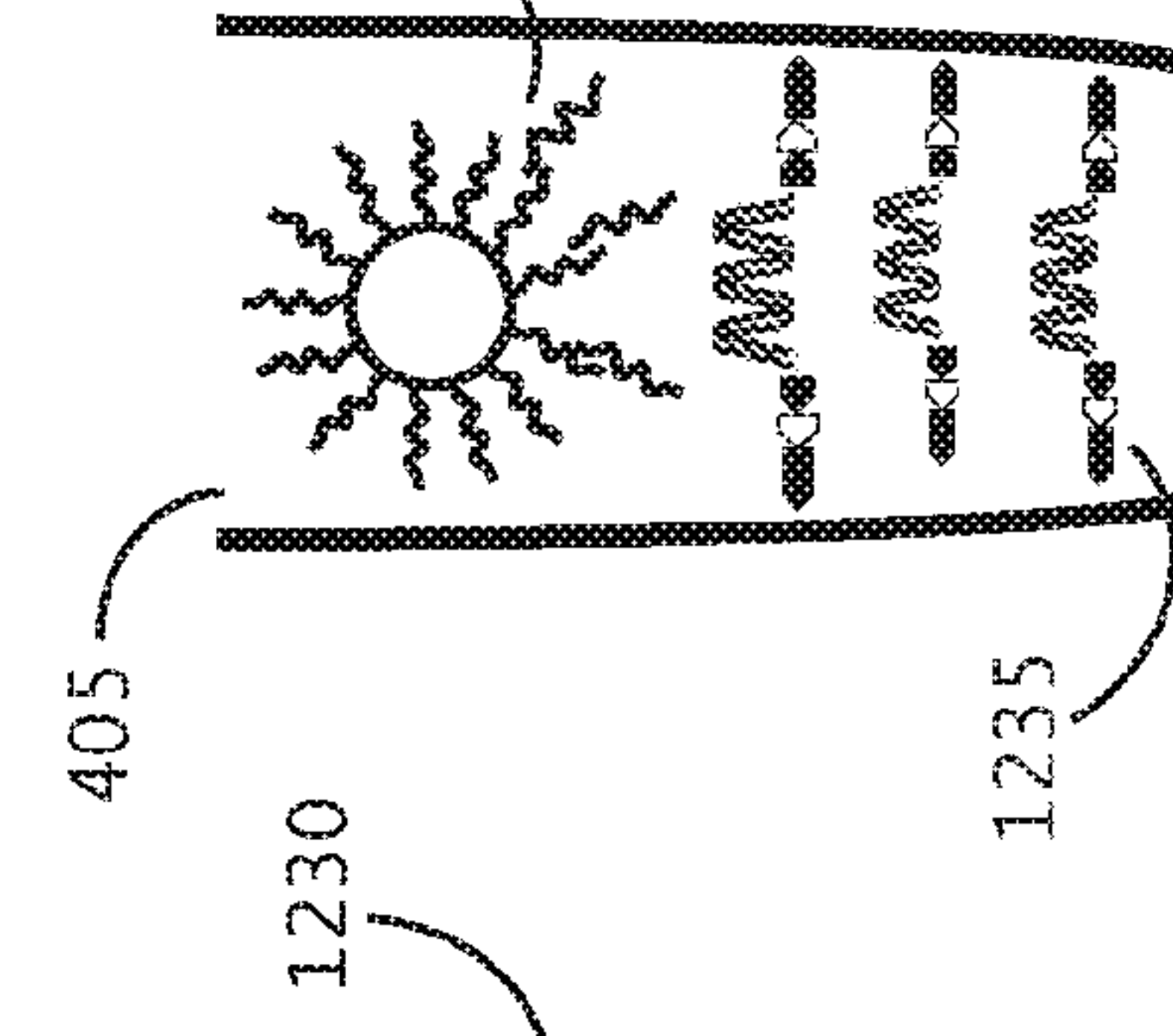

FIG. 12E

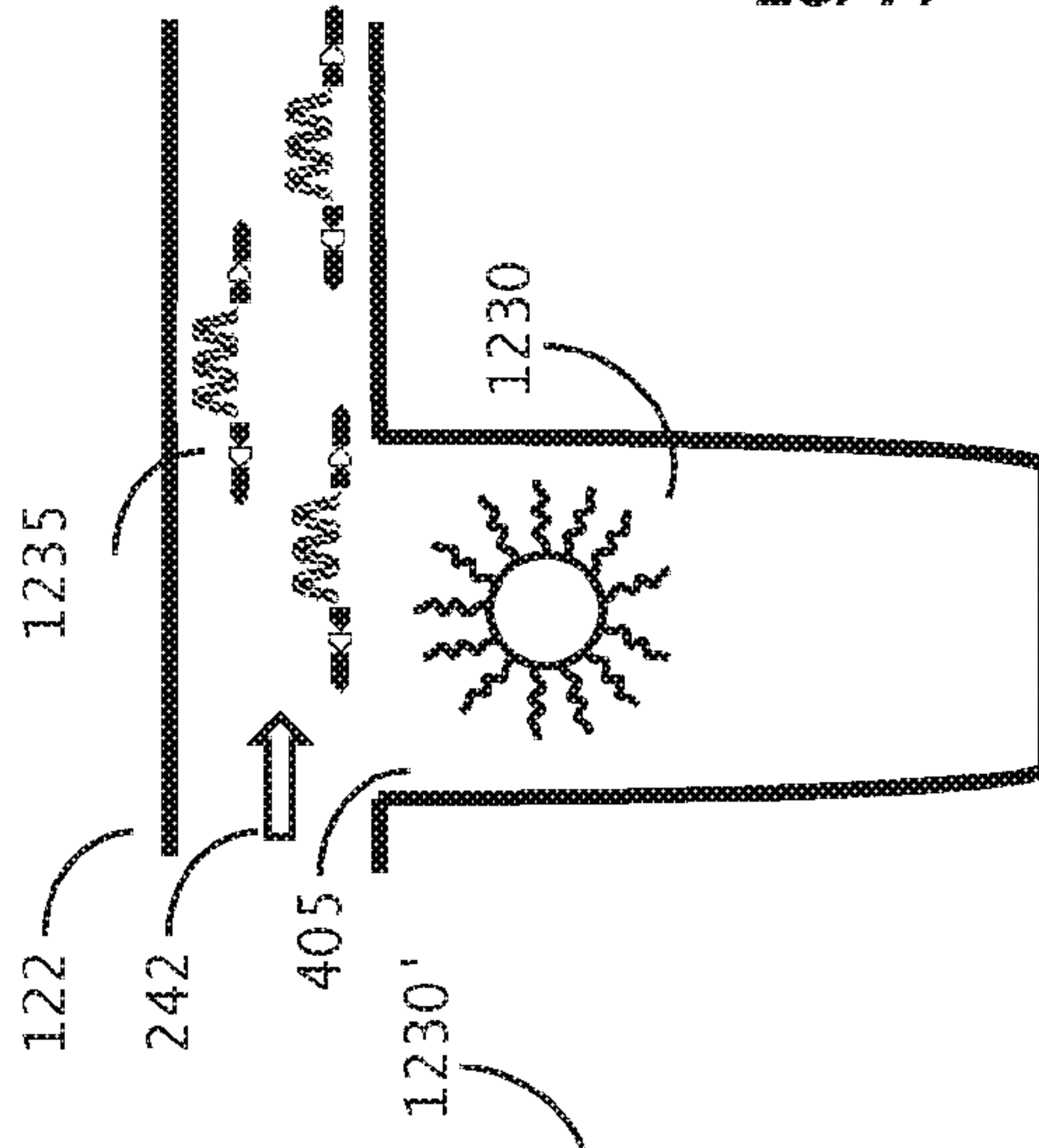

FIG. 12F

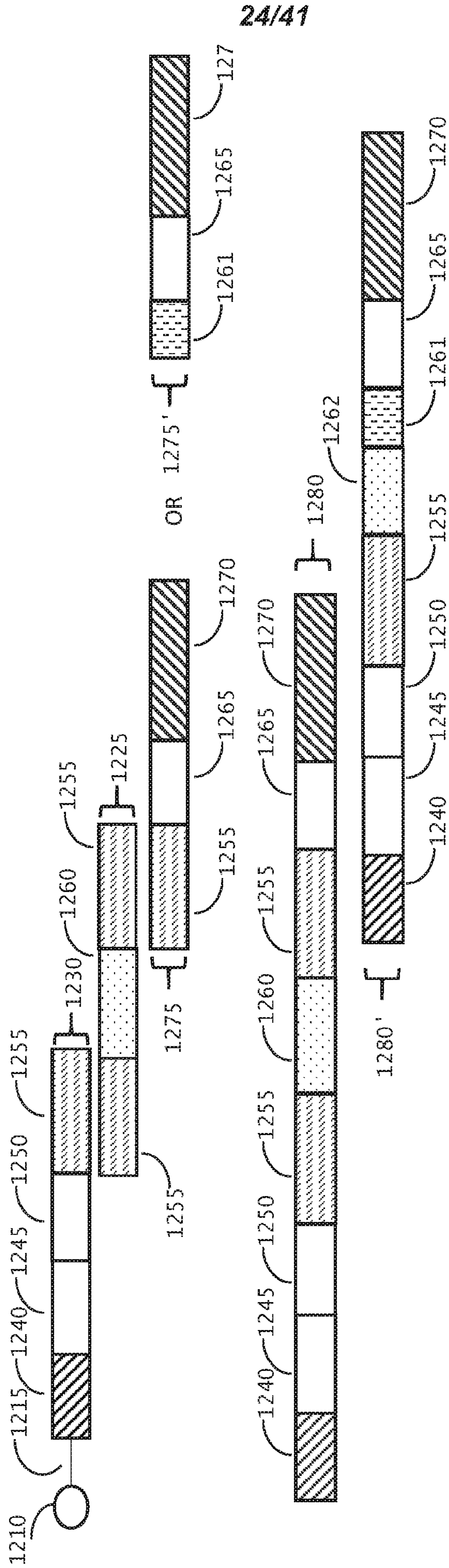

FIG. 12G

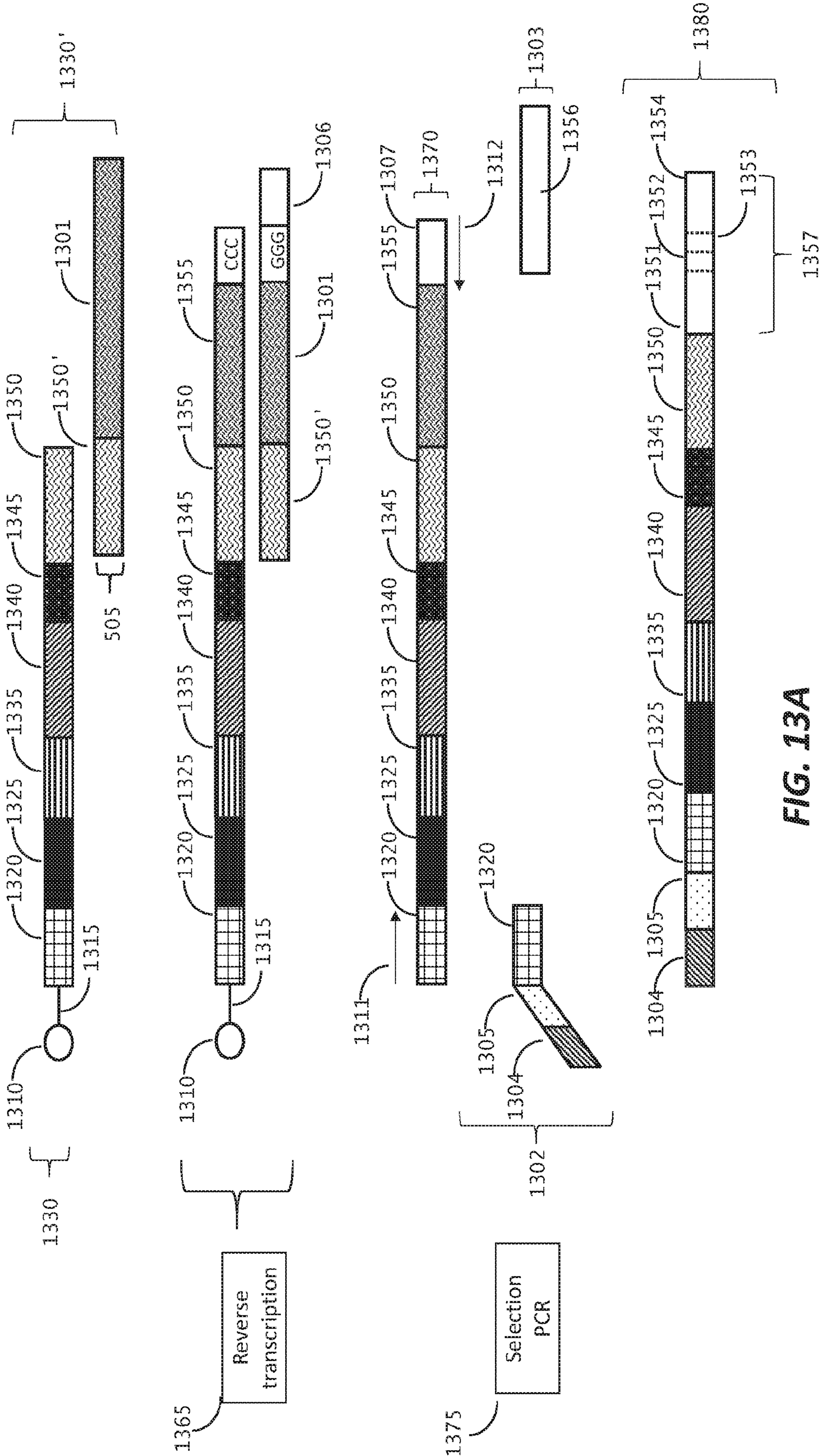

FIG. 13A

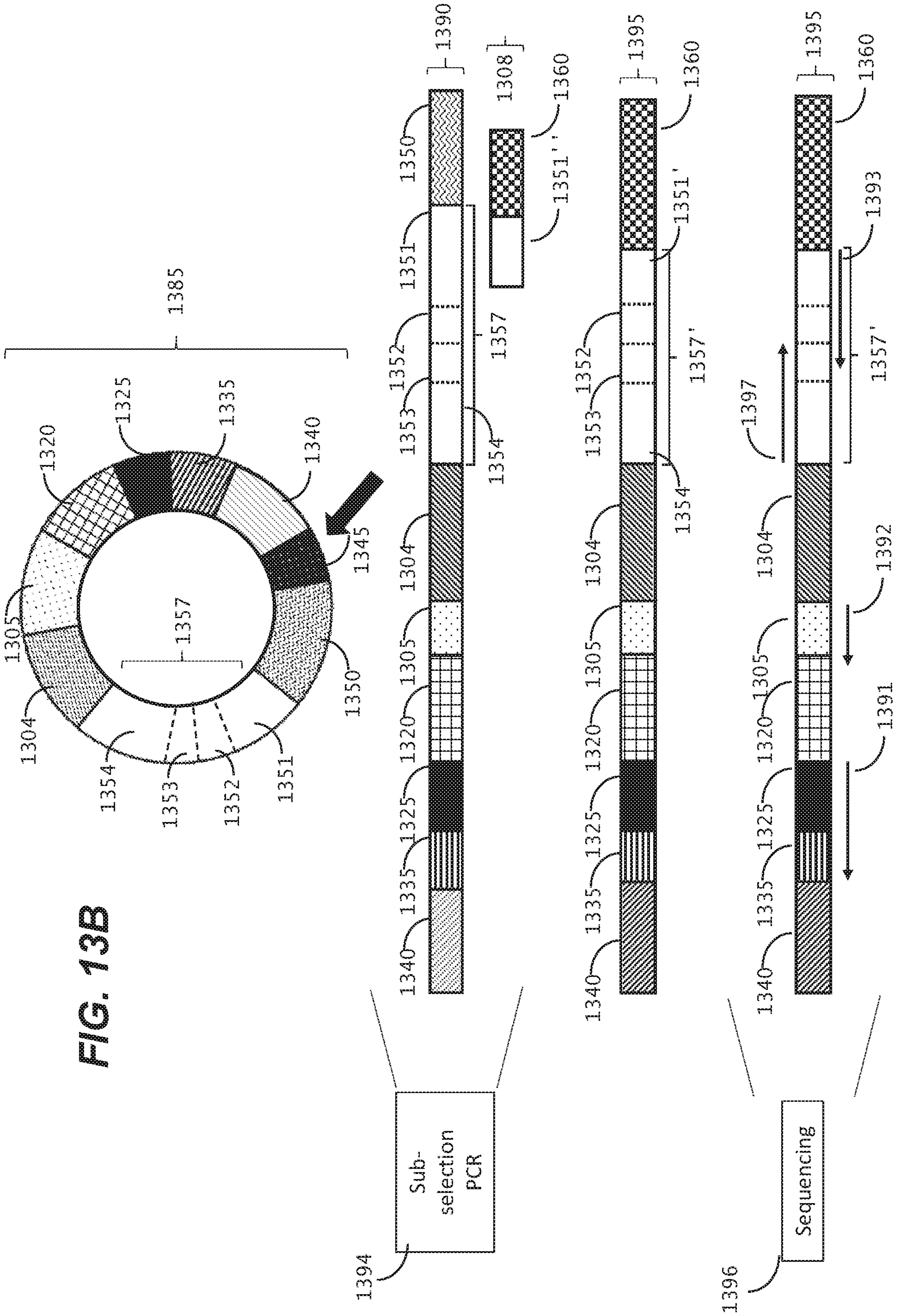

FIG. 13B

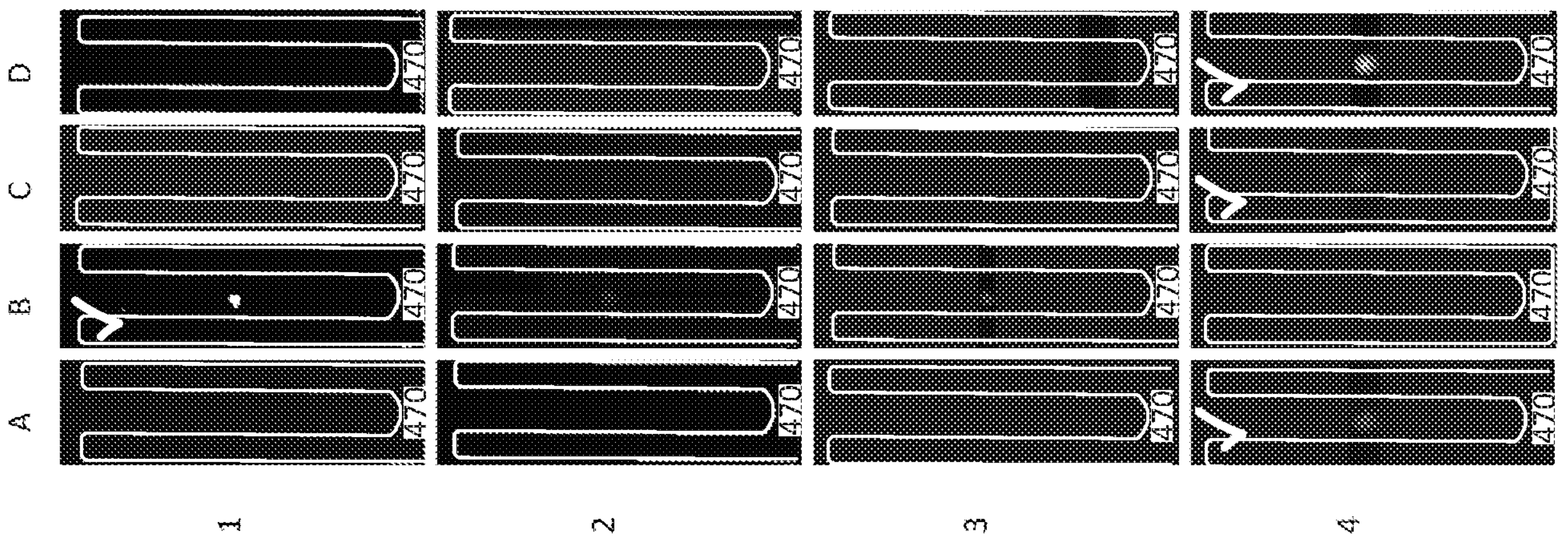

FIG. 14B

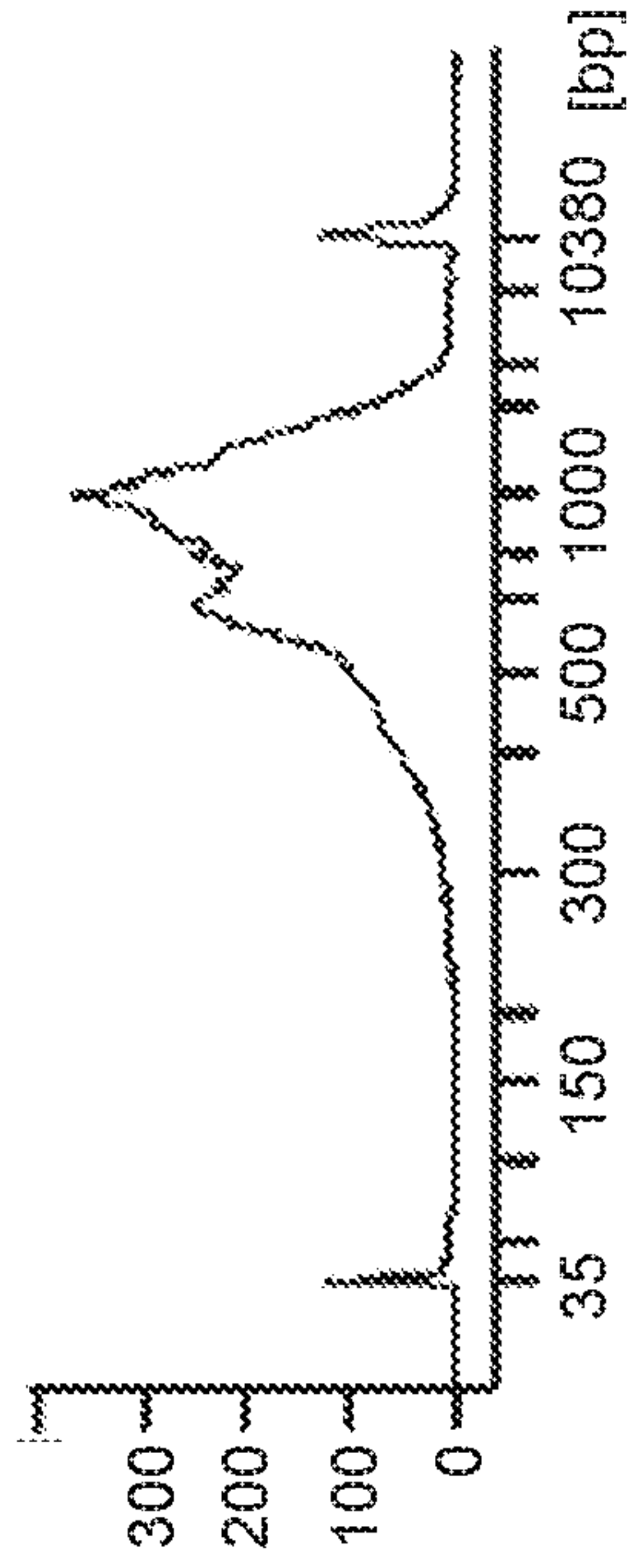

FIG. 14C

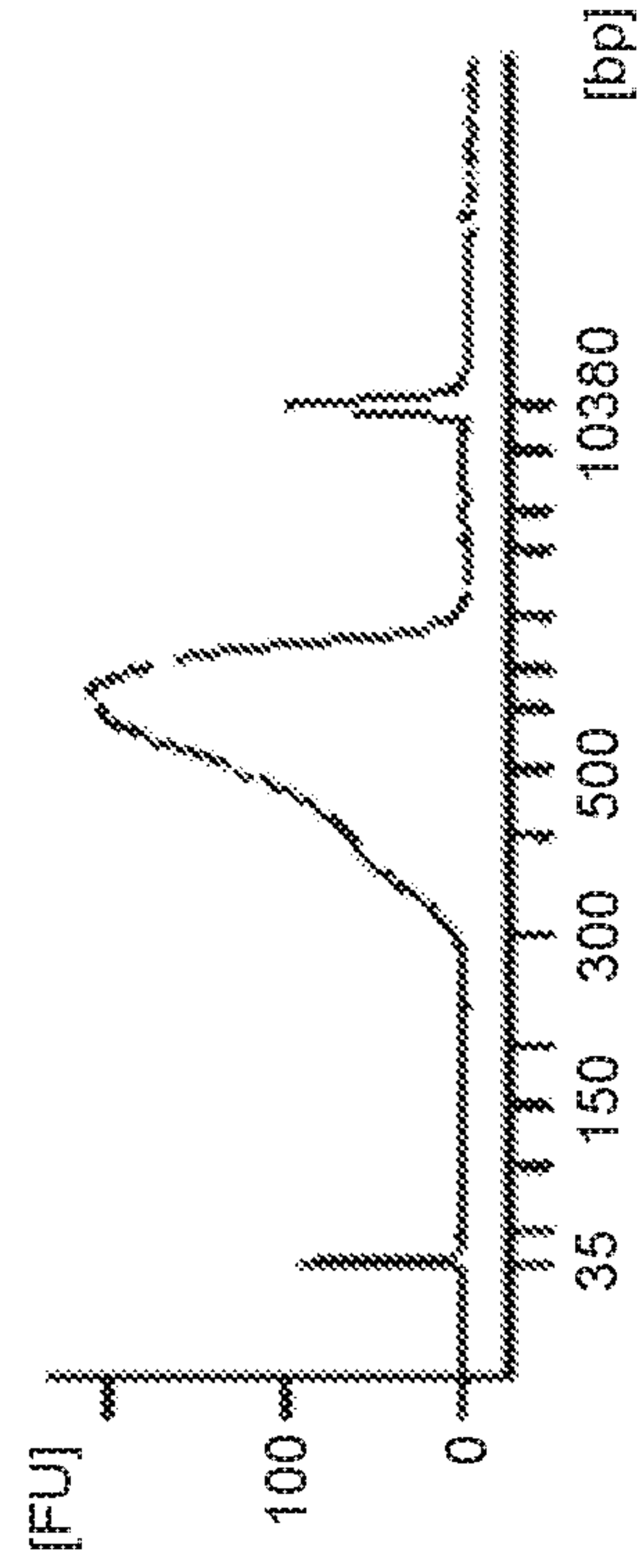

FIG. 14D

FIG. 14A

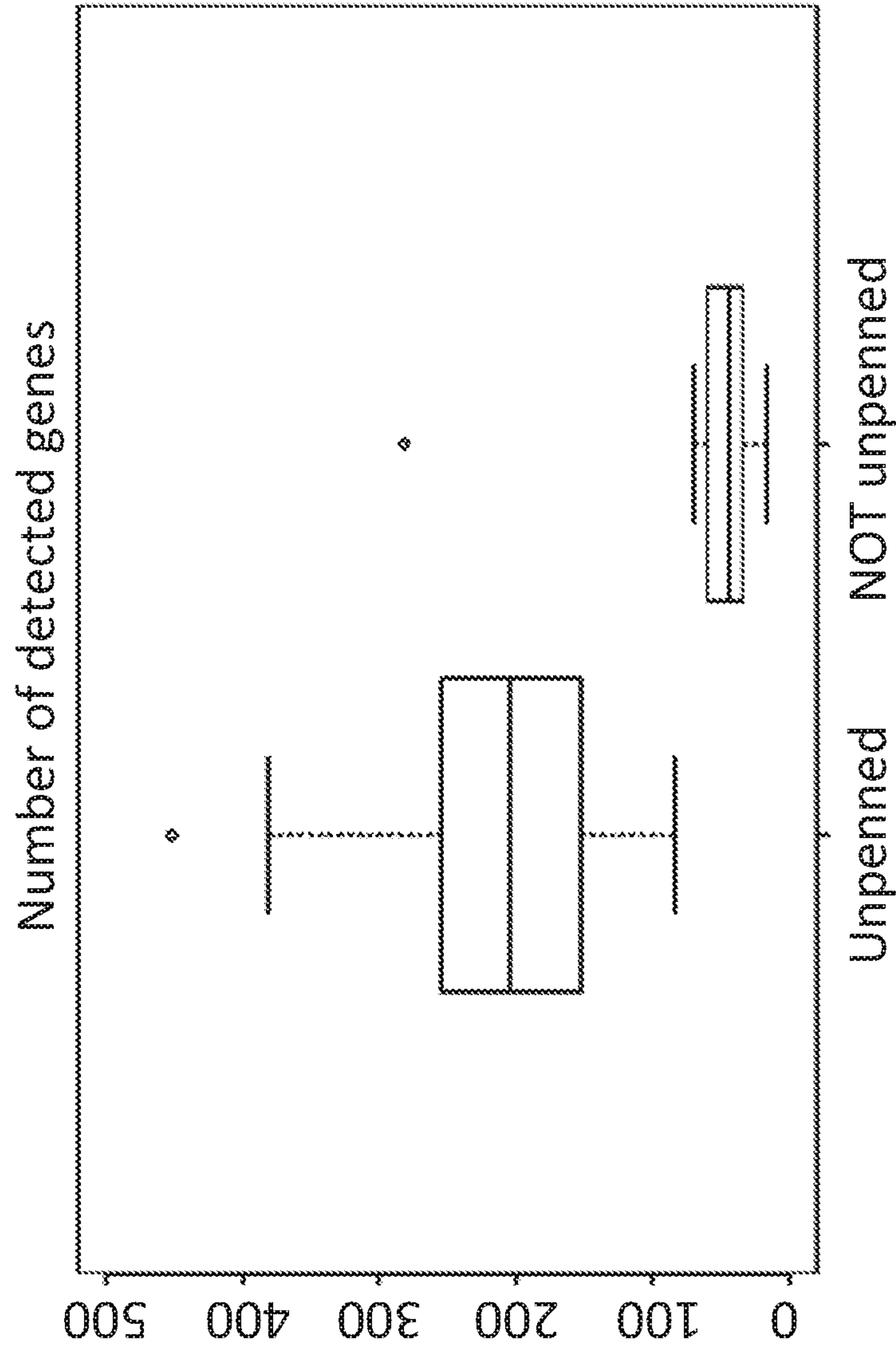

FIG. 15B

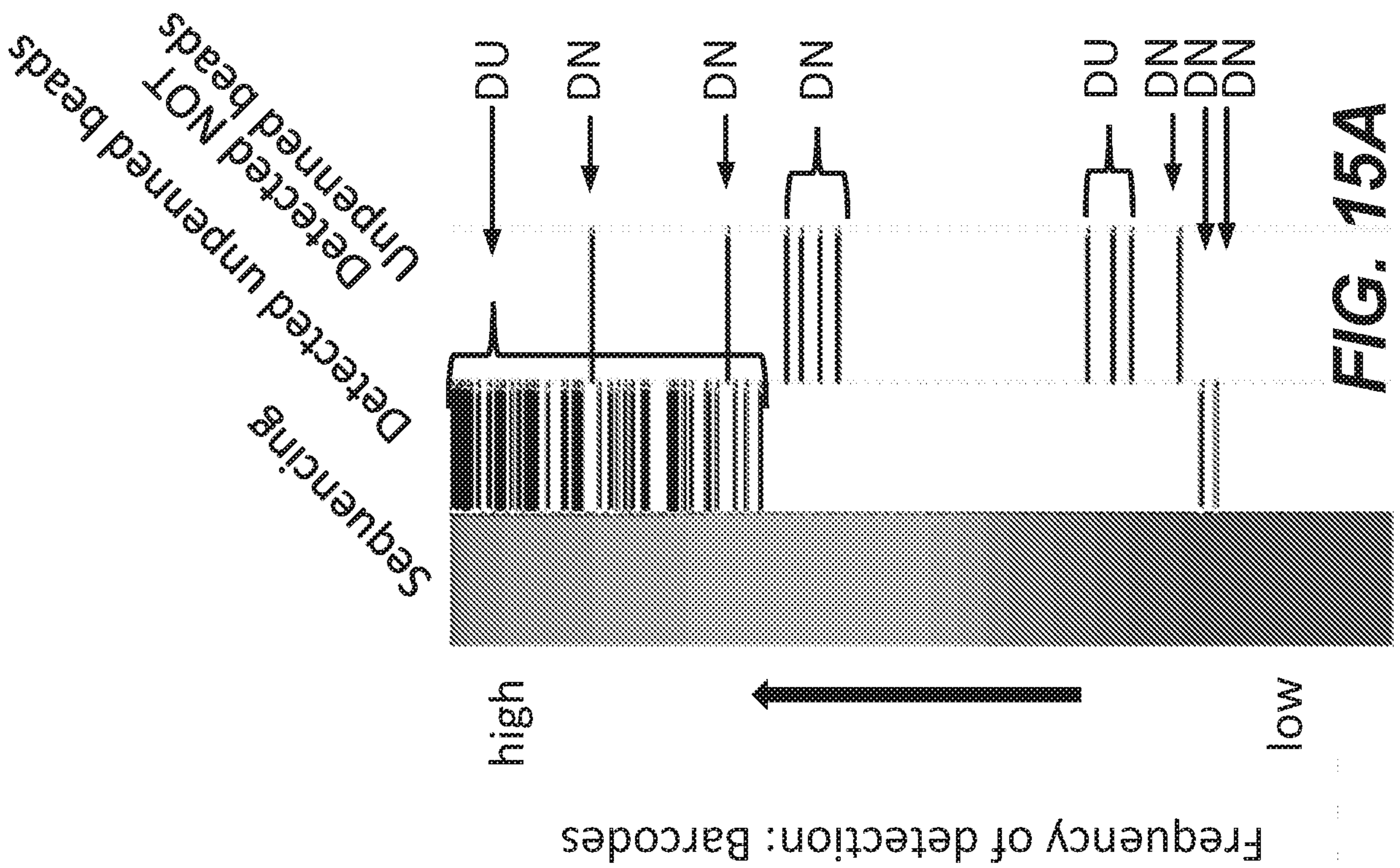

FIG. 15A

Experiment	# Beads per export
A- 60 min RT	108
B- 90 min RT	120

FIG. 16A

Sample_ID	Total	Assigned	Aligned	Mito_Total	Mito_UMI	Refseq_Total	Refseq_UMI
A	4383109	4139242	2538580	7810	711	2114803	281990
B	3313847	3154752	1813561	13489	1875	1540667	332634

FIG. 16B

Sample ID	Barcoded reads	Refseq Transcriptome Alignment
1	87%	61%
2	84%	49%
3	86%	53%
4	86%	62%
5	78%	55%
6	83%	57%

FIG. 16C

Top 5 expressed genes (OKT3)	Description
Rpl28	Ribosomal Protein
Emb	B cell specific
Rpl24	B cell specific
Dcun1d5	B cell specific
Rpl35a	Ribosomal Protein
Ddt	B cell specific

FIG. 16D

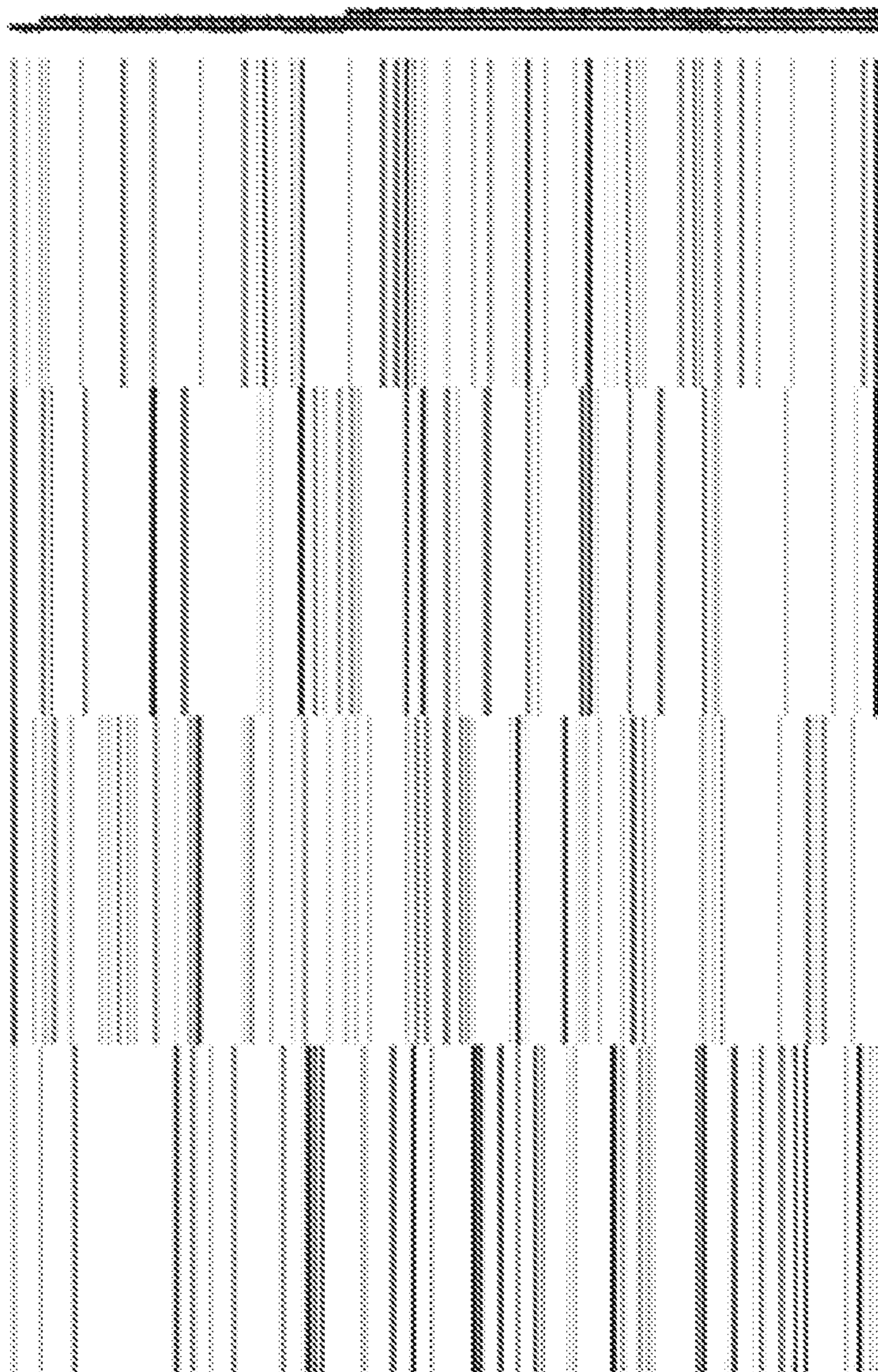
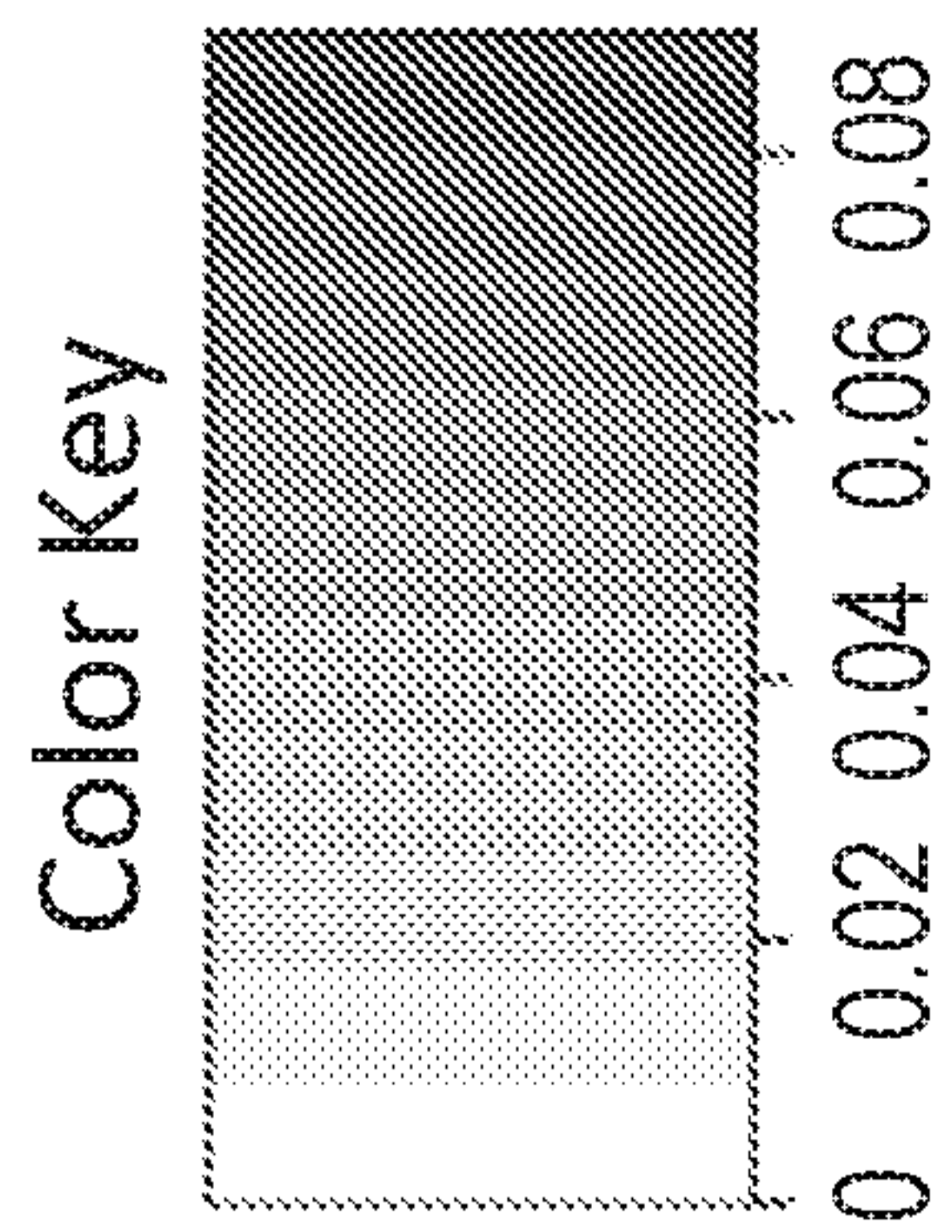

Experiment: 100 98 105 106

FIG. 17

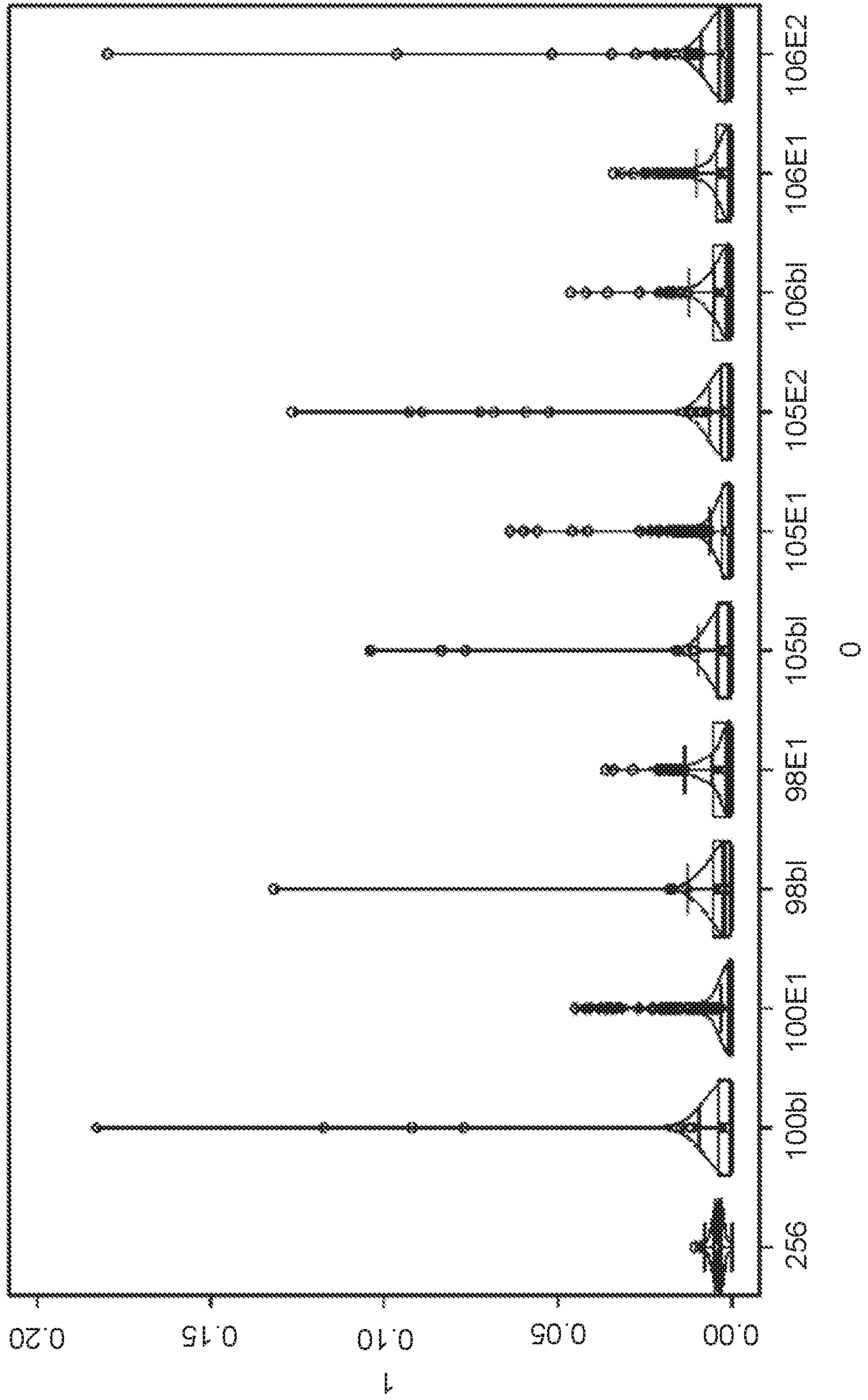

FIG. 18

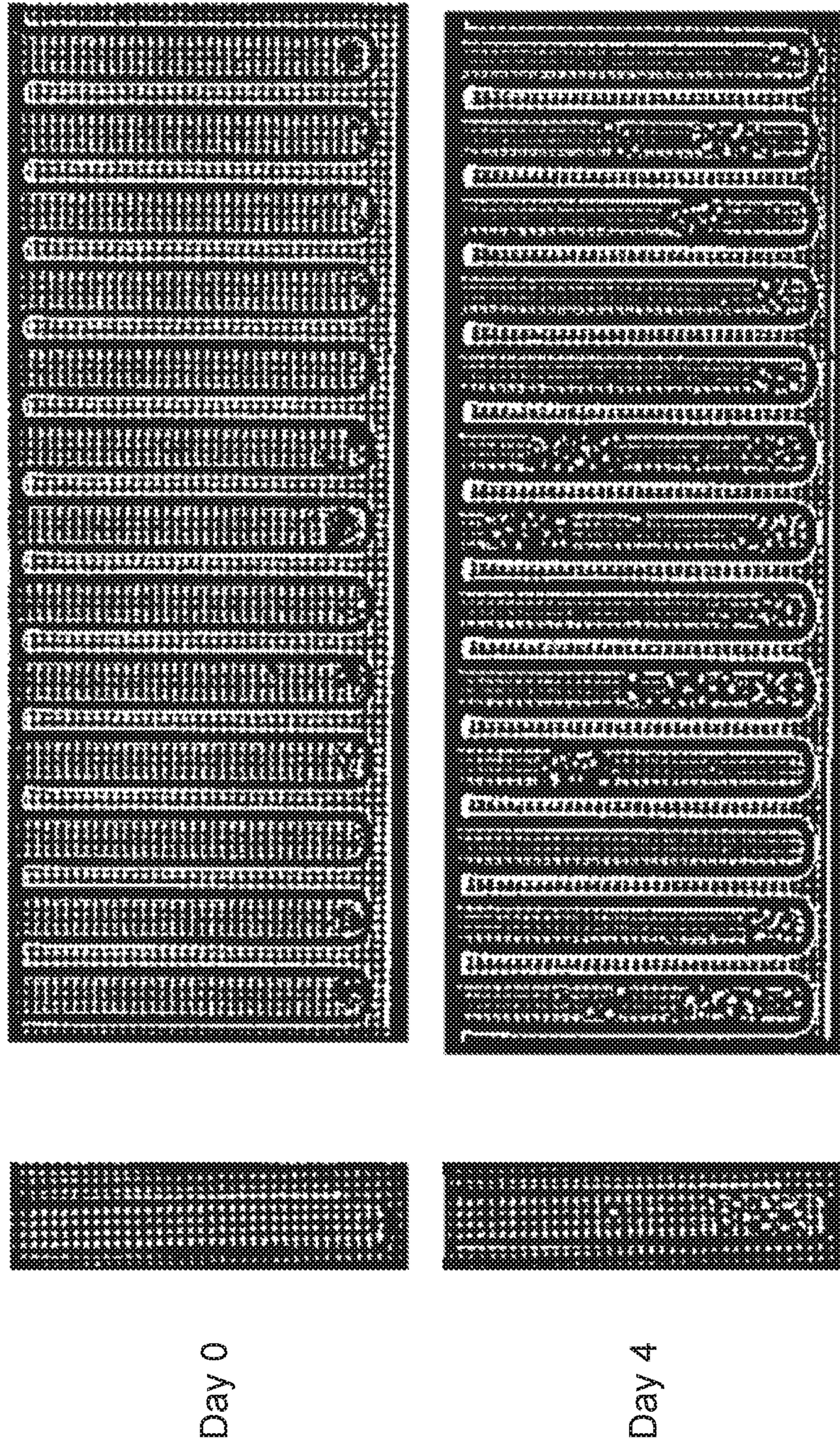

FIG. 19

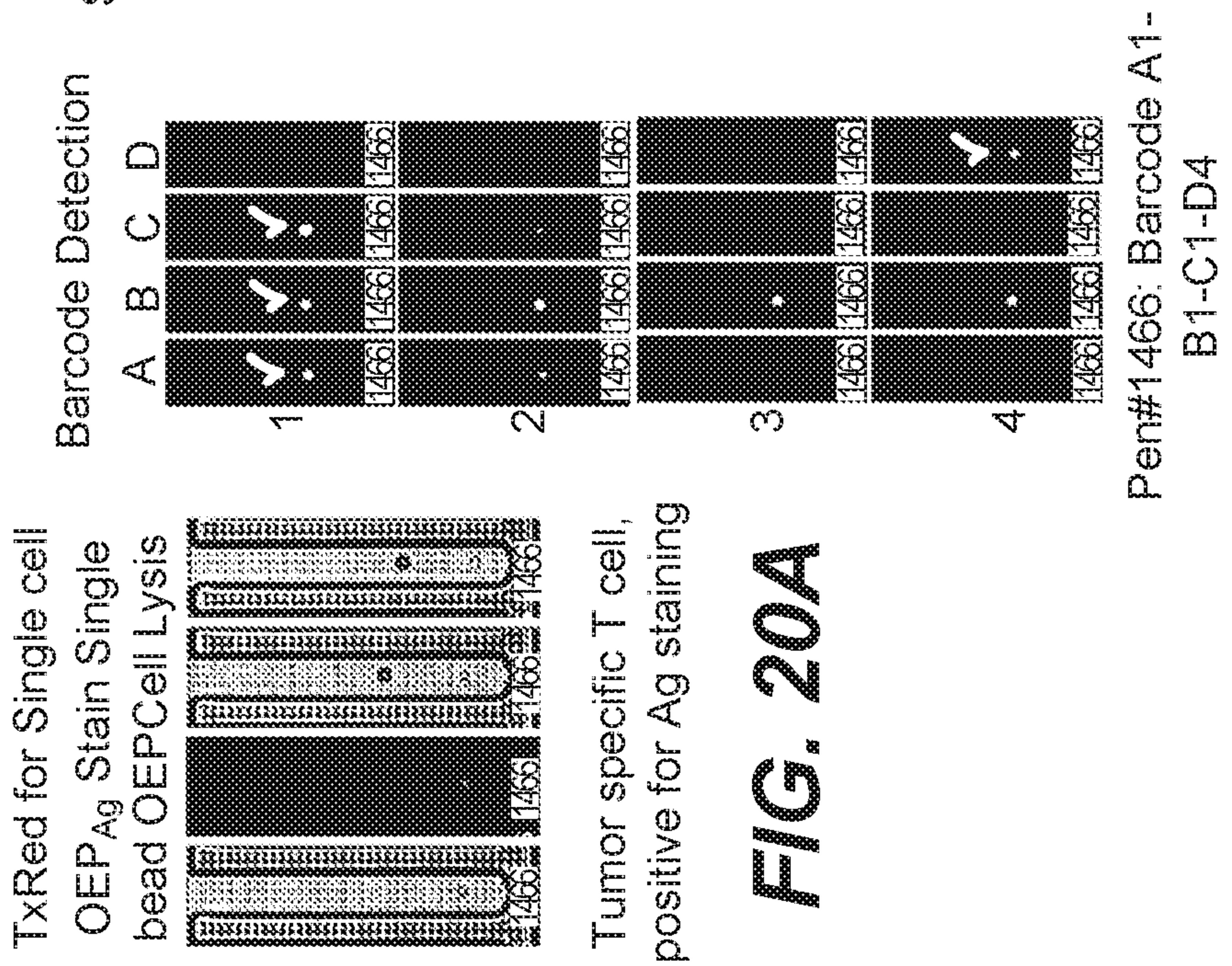
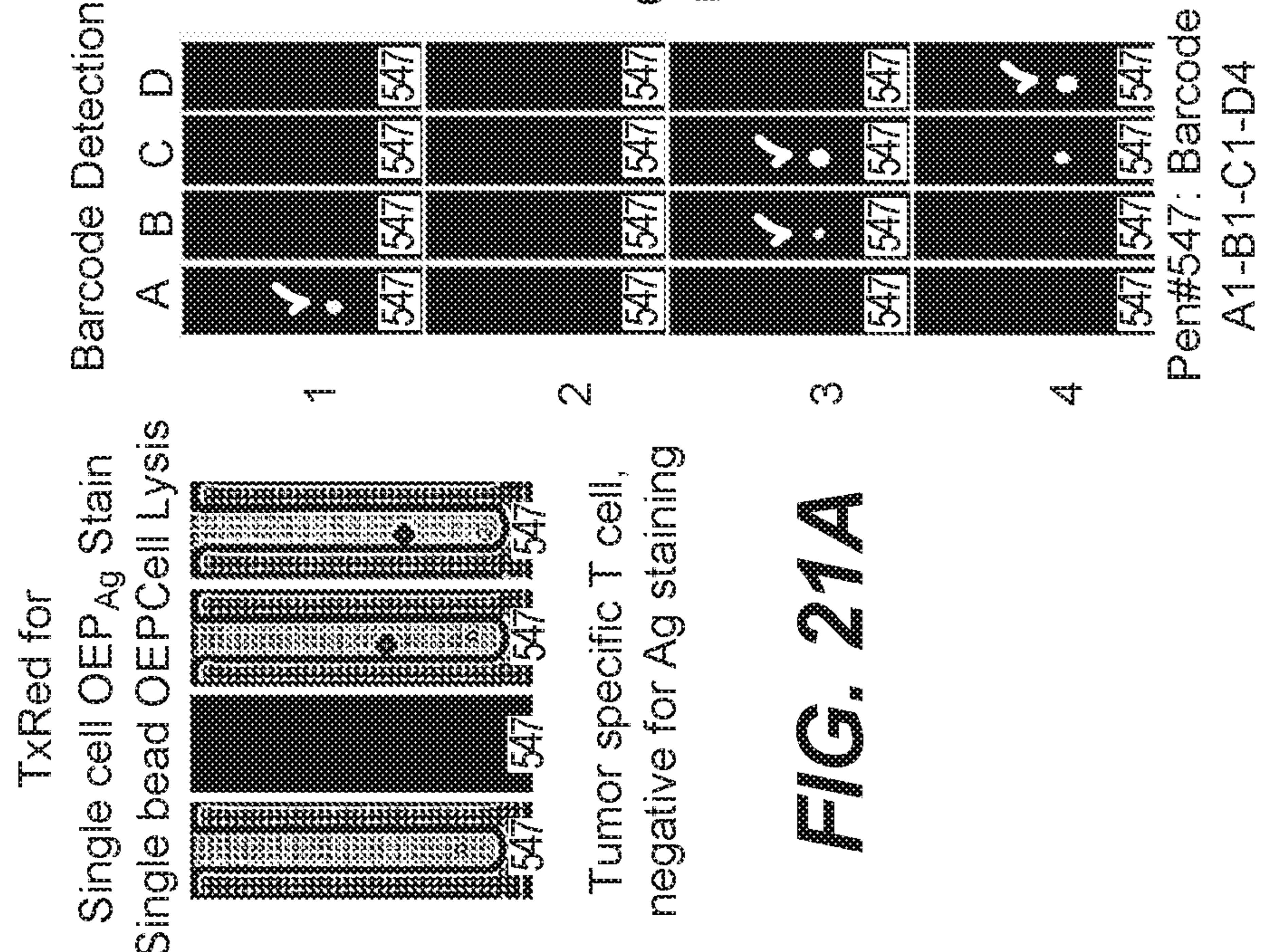
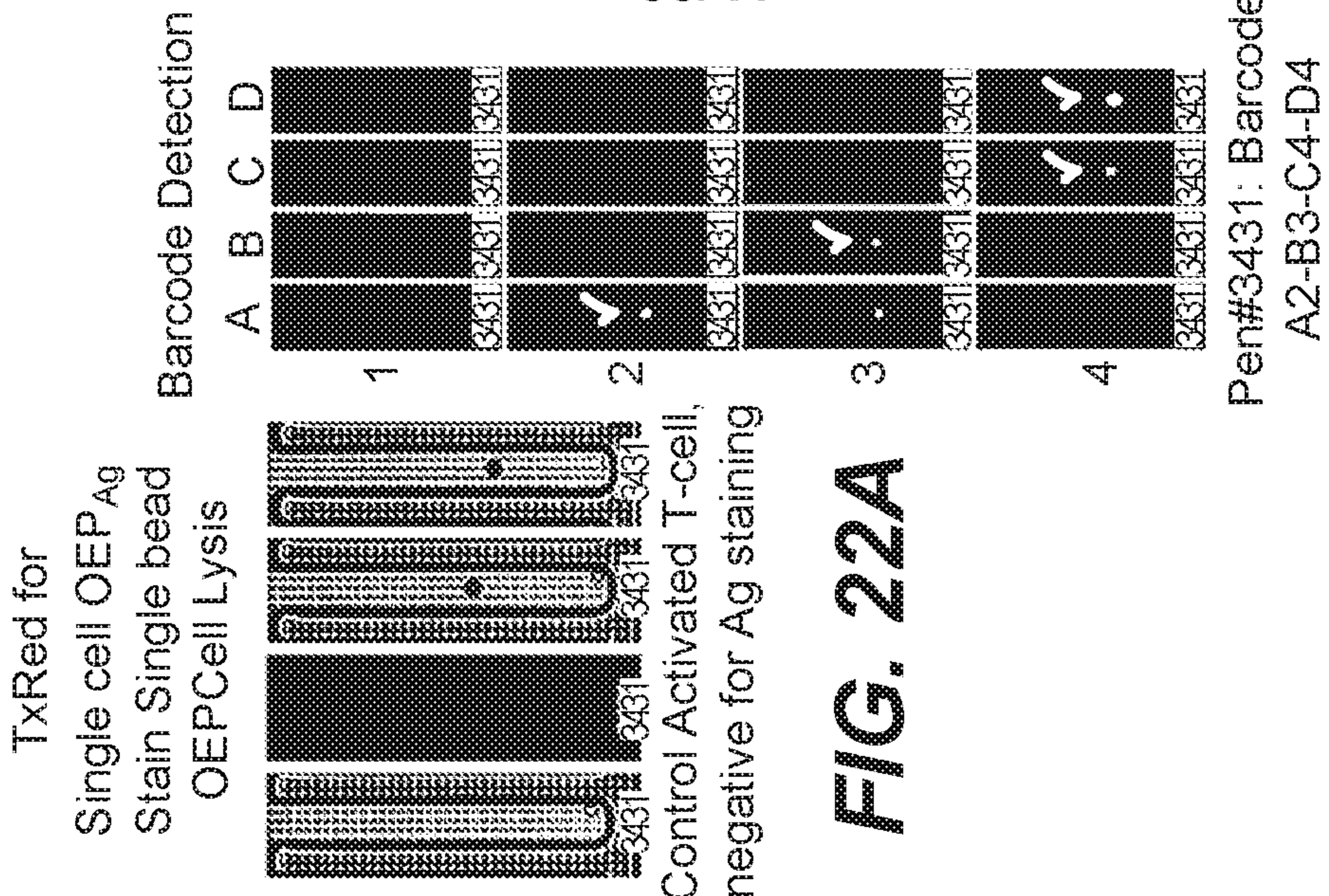
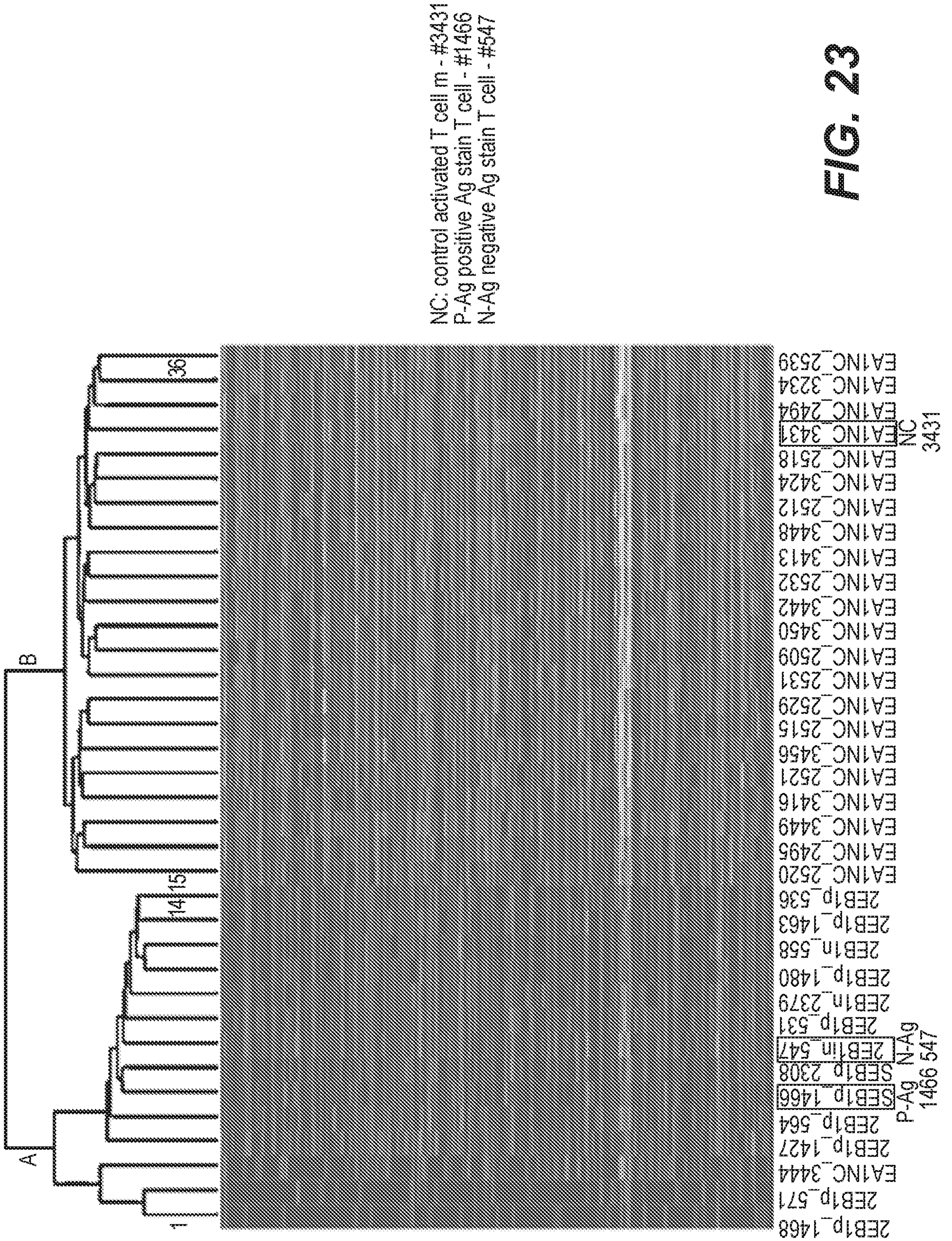

FIG. 22B

FIG. 21B

FIG. 20B



NC: control activated T cell m - #3431
 P-Ag positive Ag stain T cell - #1466
 N-Ag negative Ag stain T cell - #547

FIG. 23

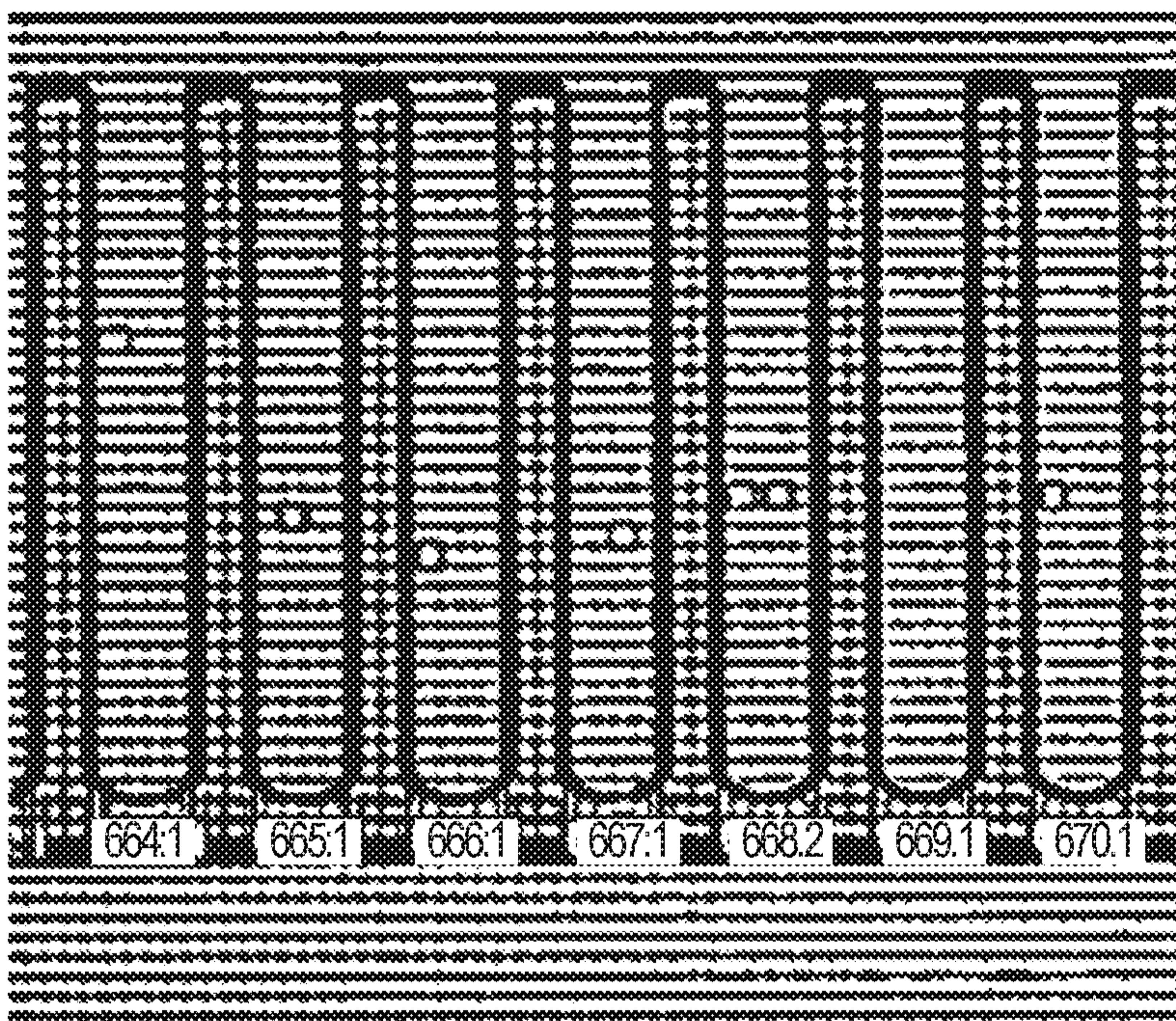

FIG. 24

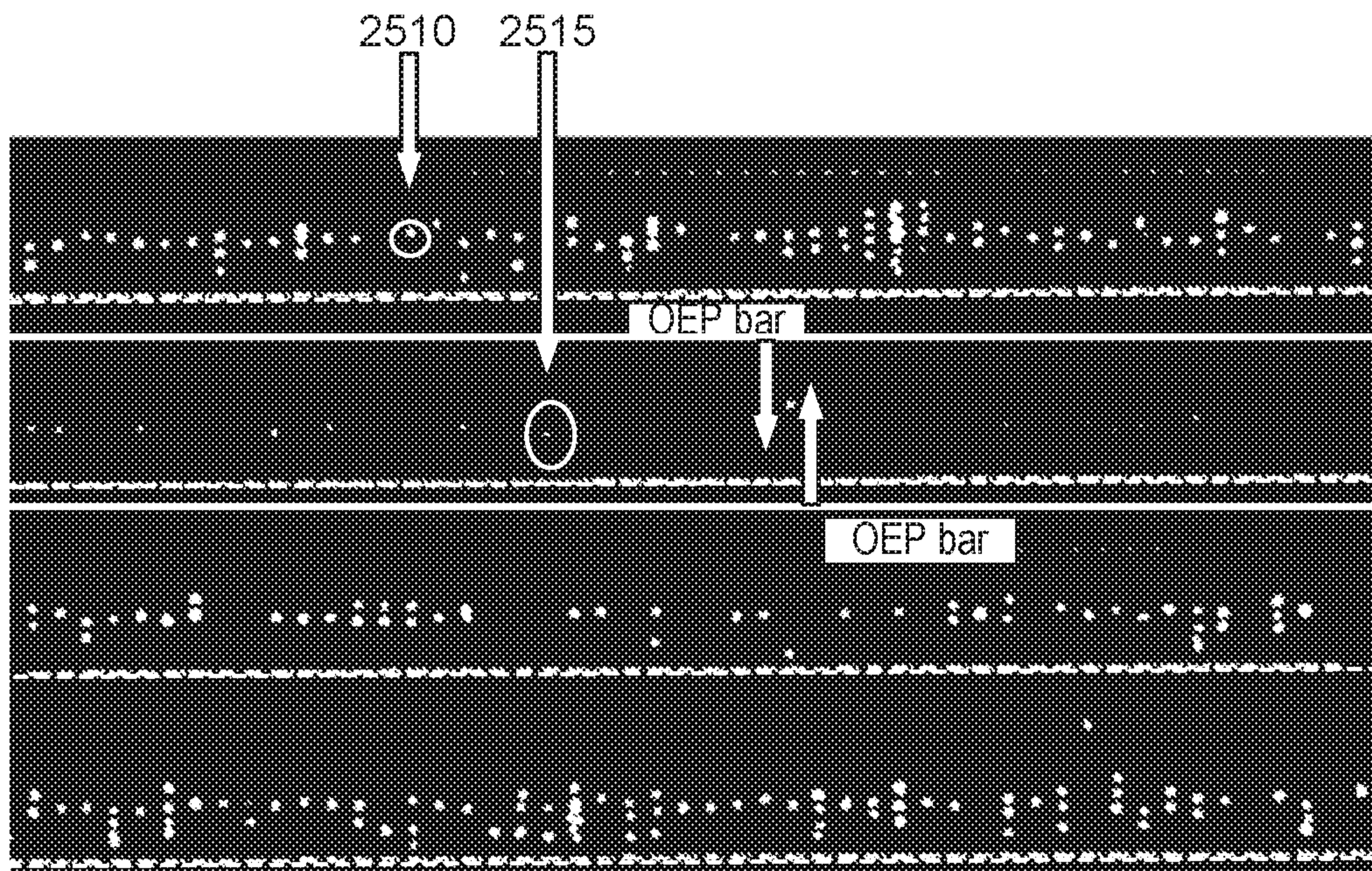

FIG. 25

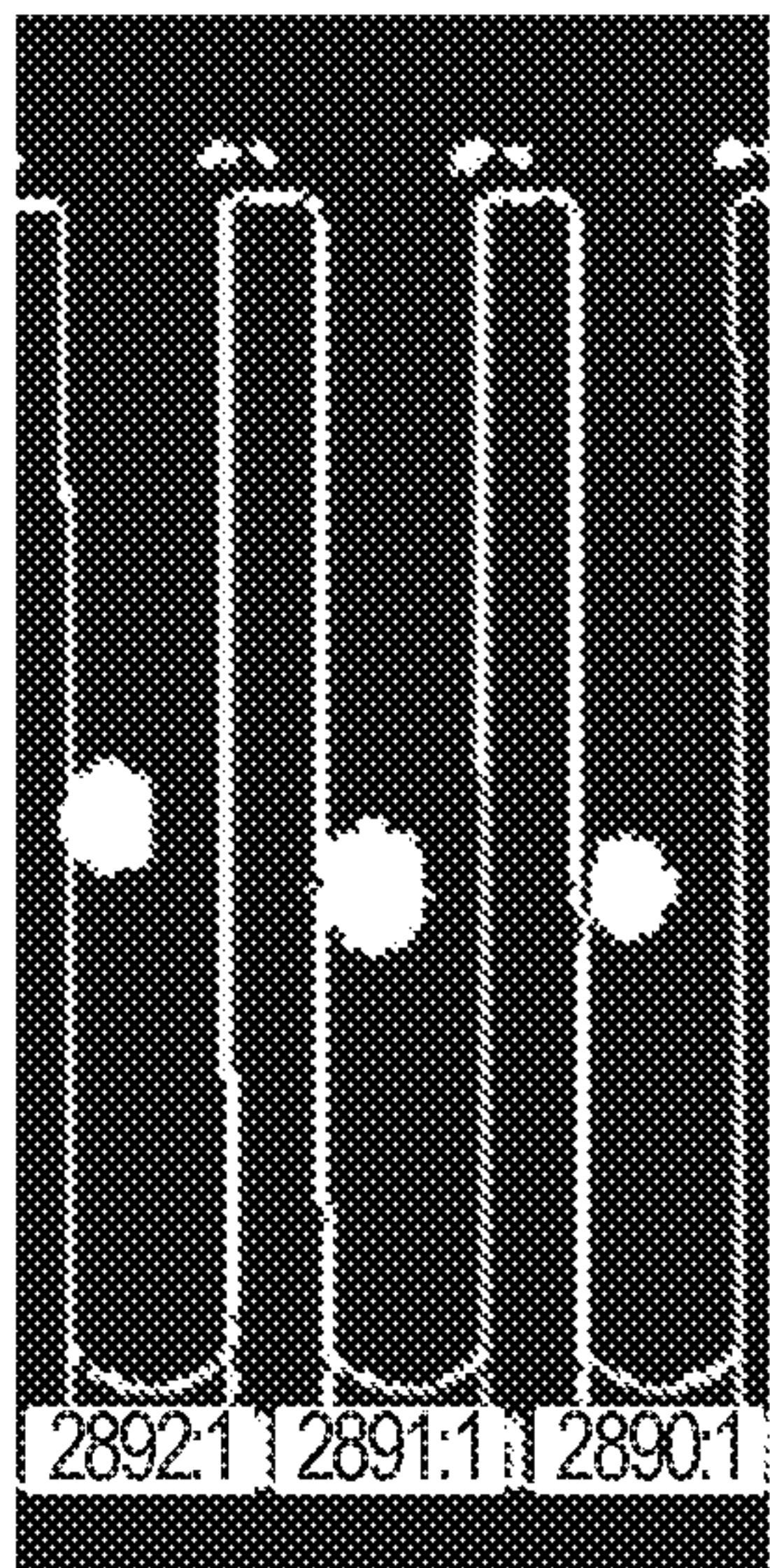

FIG. 26A

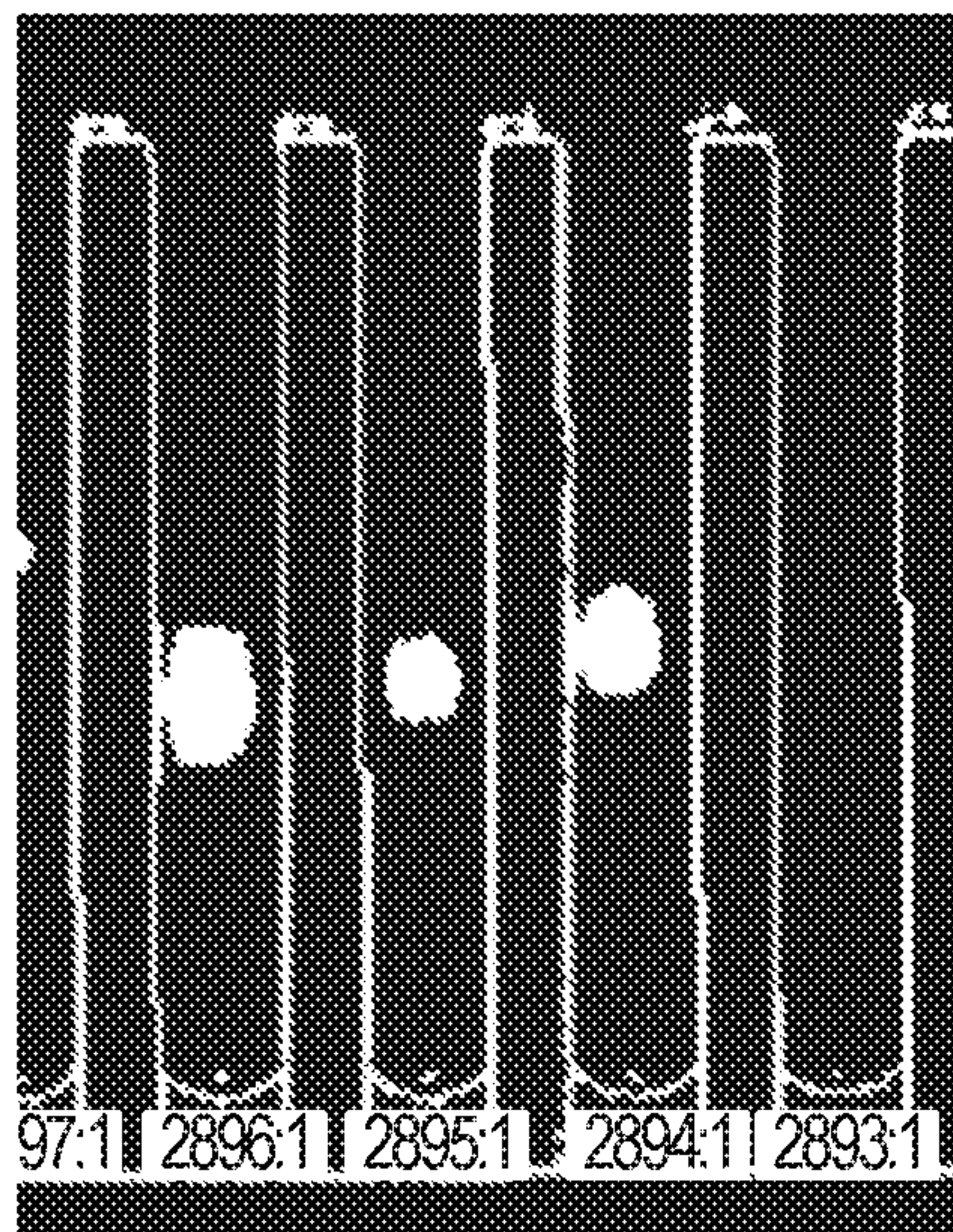

FIG. 26B

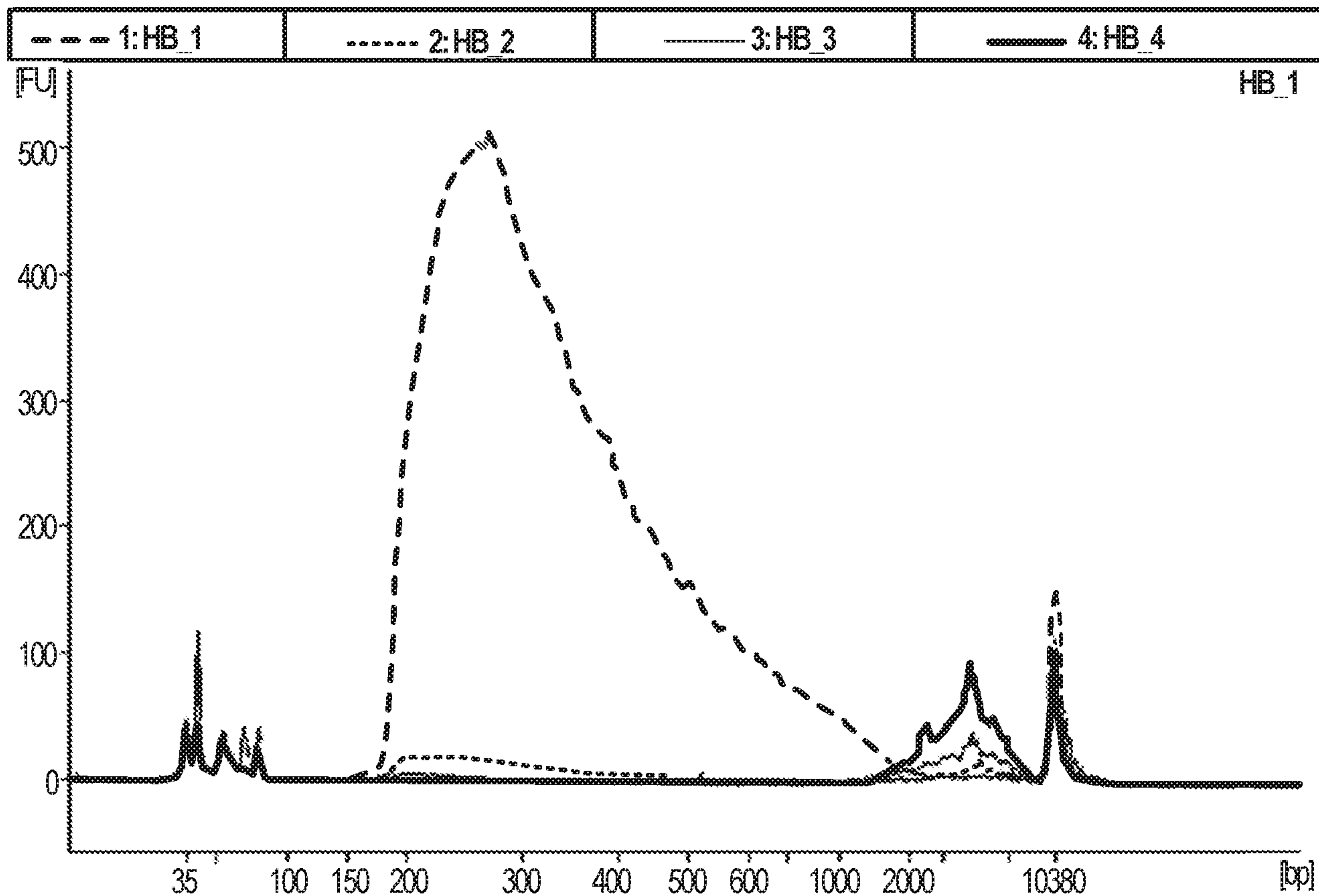

FIG. 27

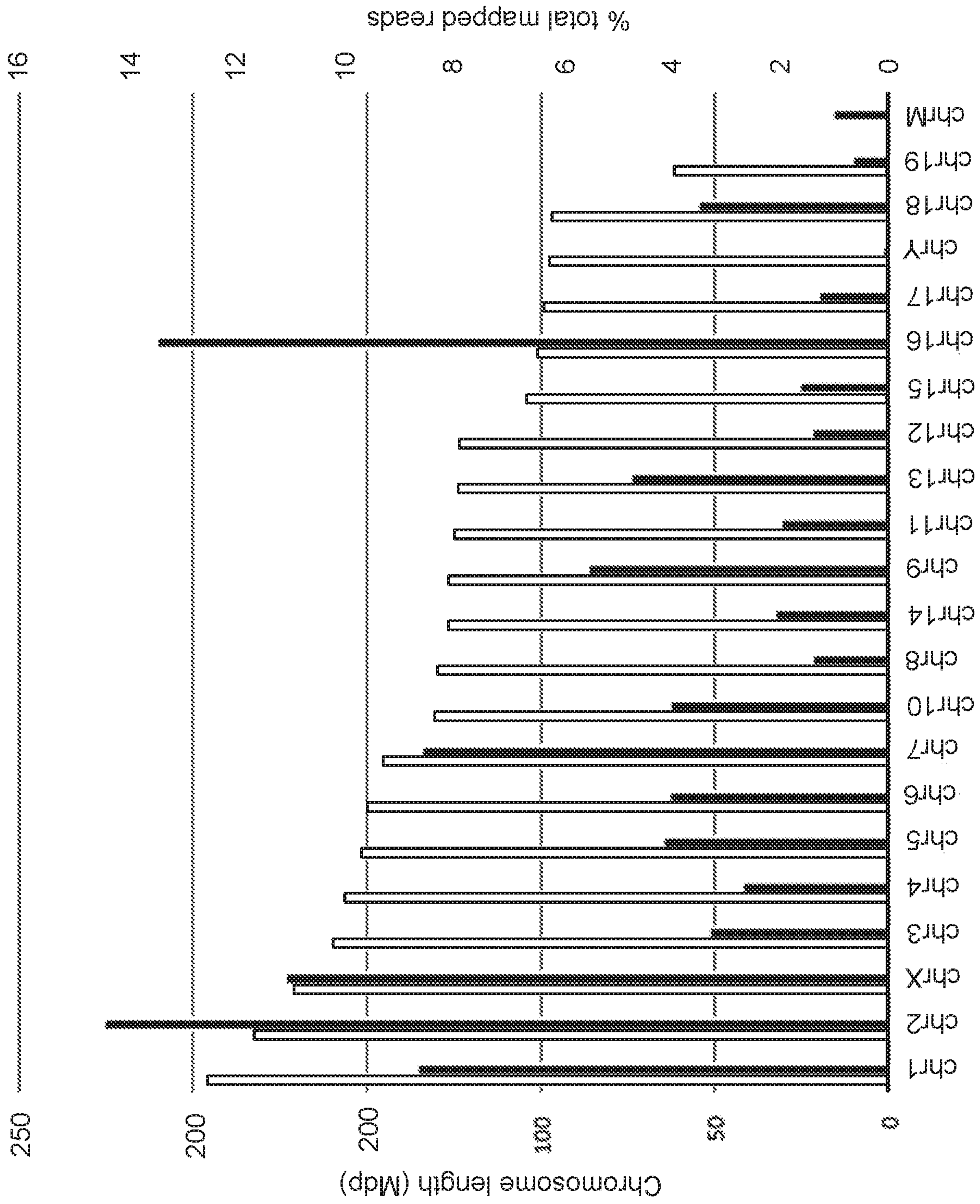

FIG. 28

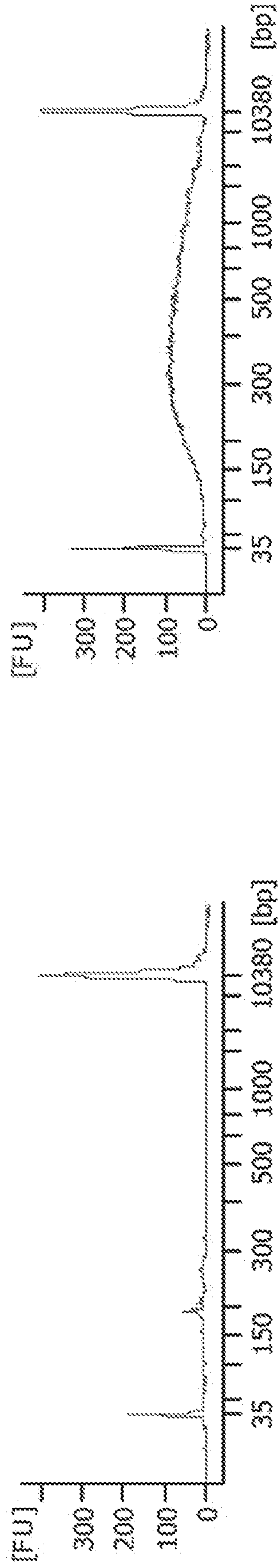

FIG. 29A

FIG. 29B

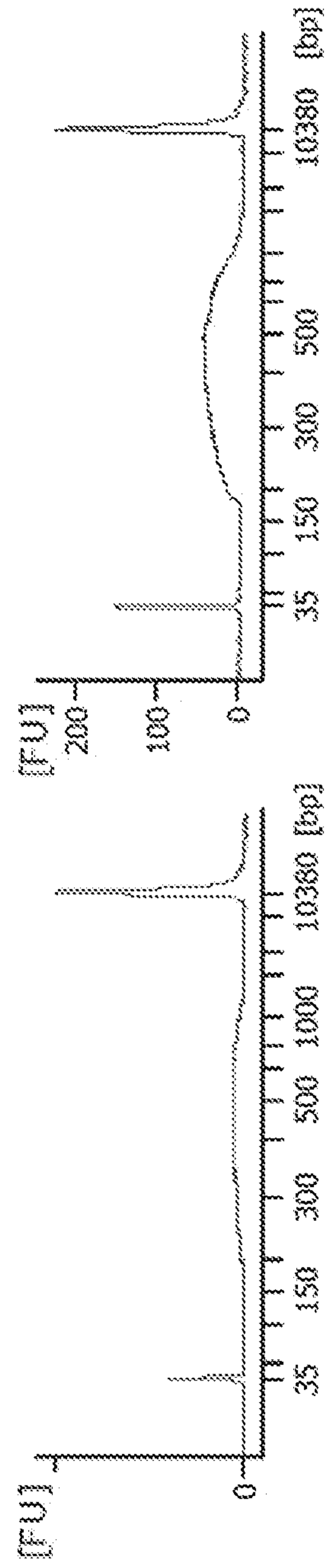

FIG. 29C

FIG. 29D

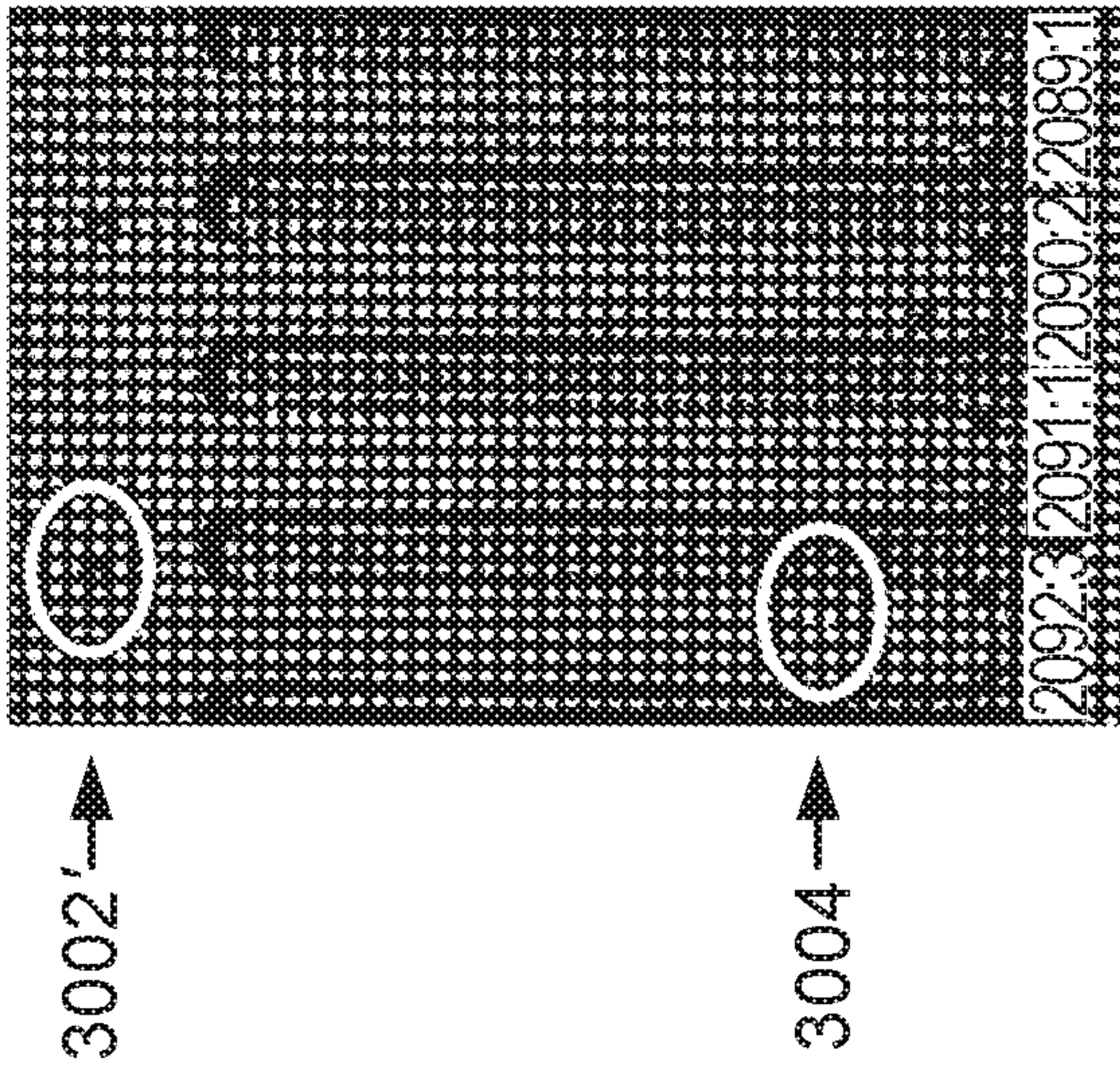

FIG. 30C

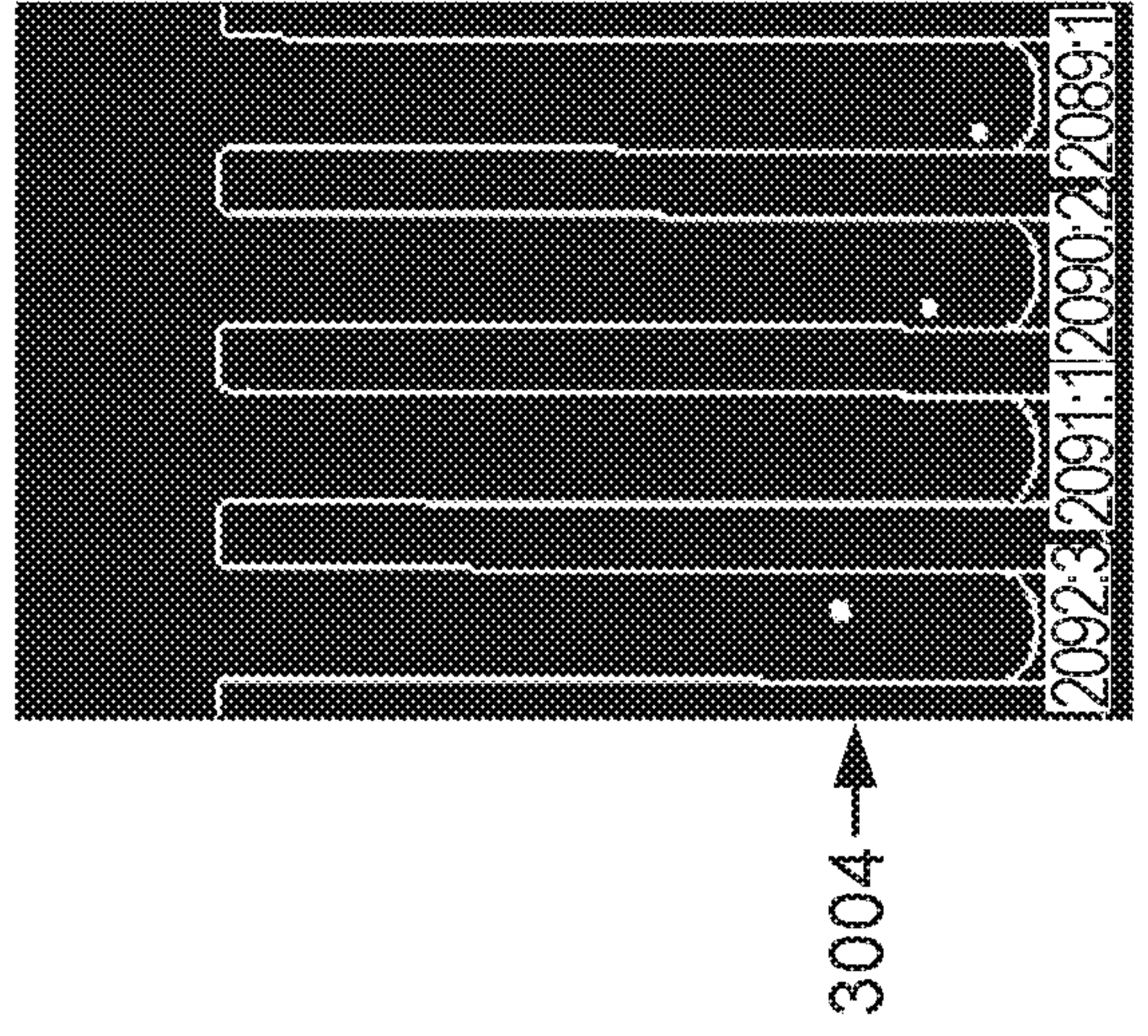

FIG. 30F

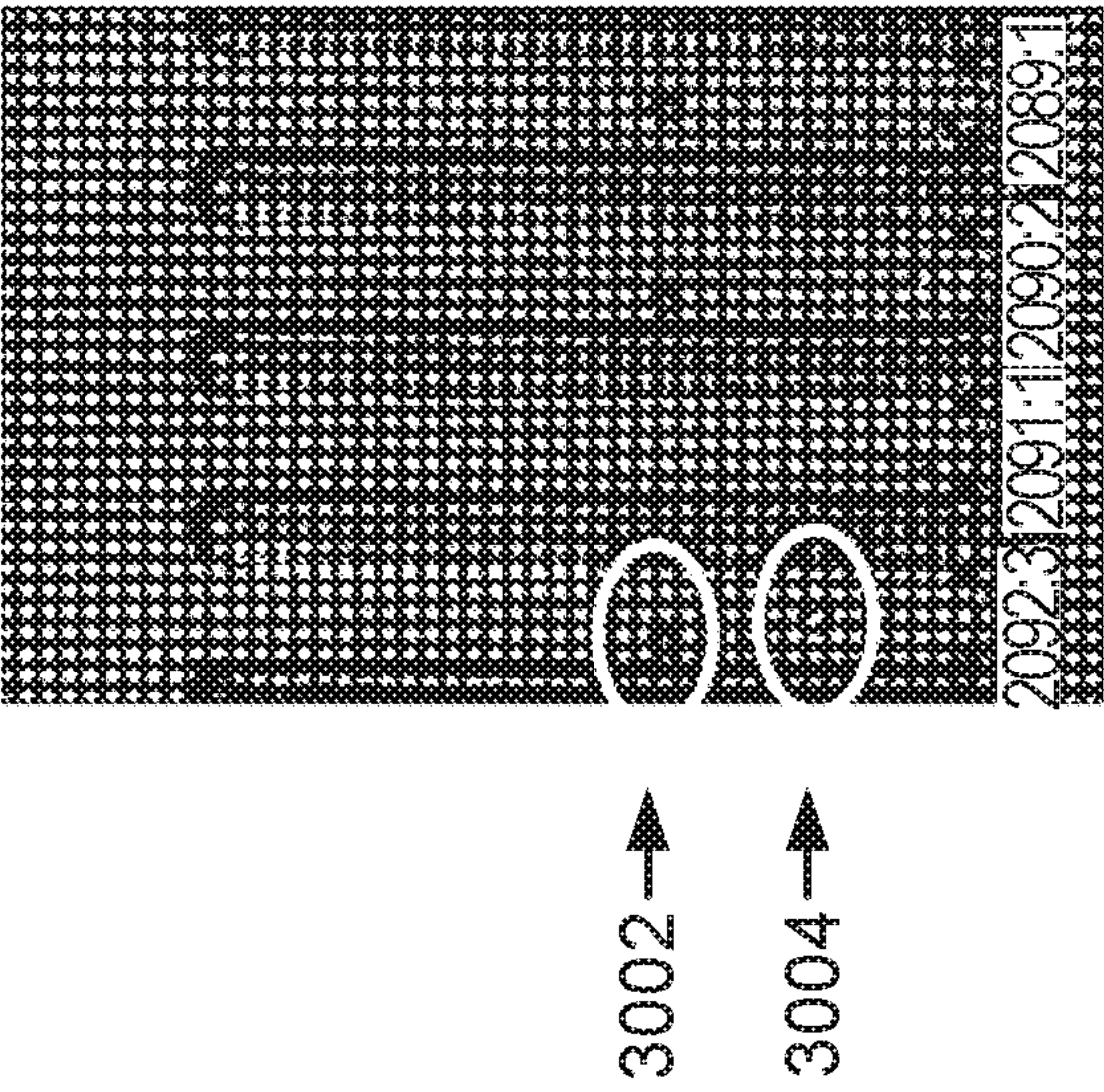

FIG. 30B

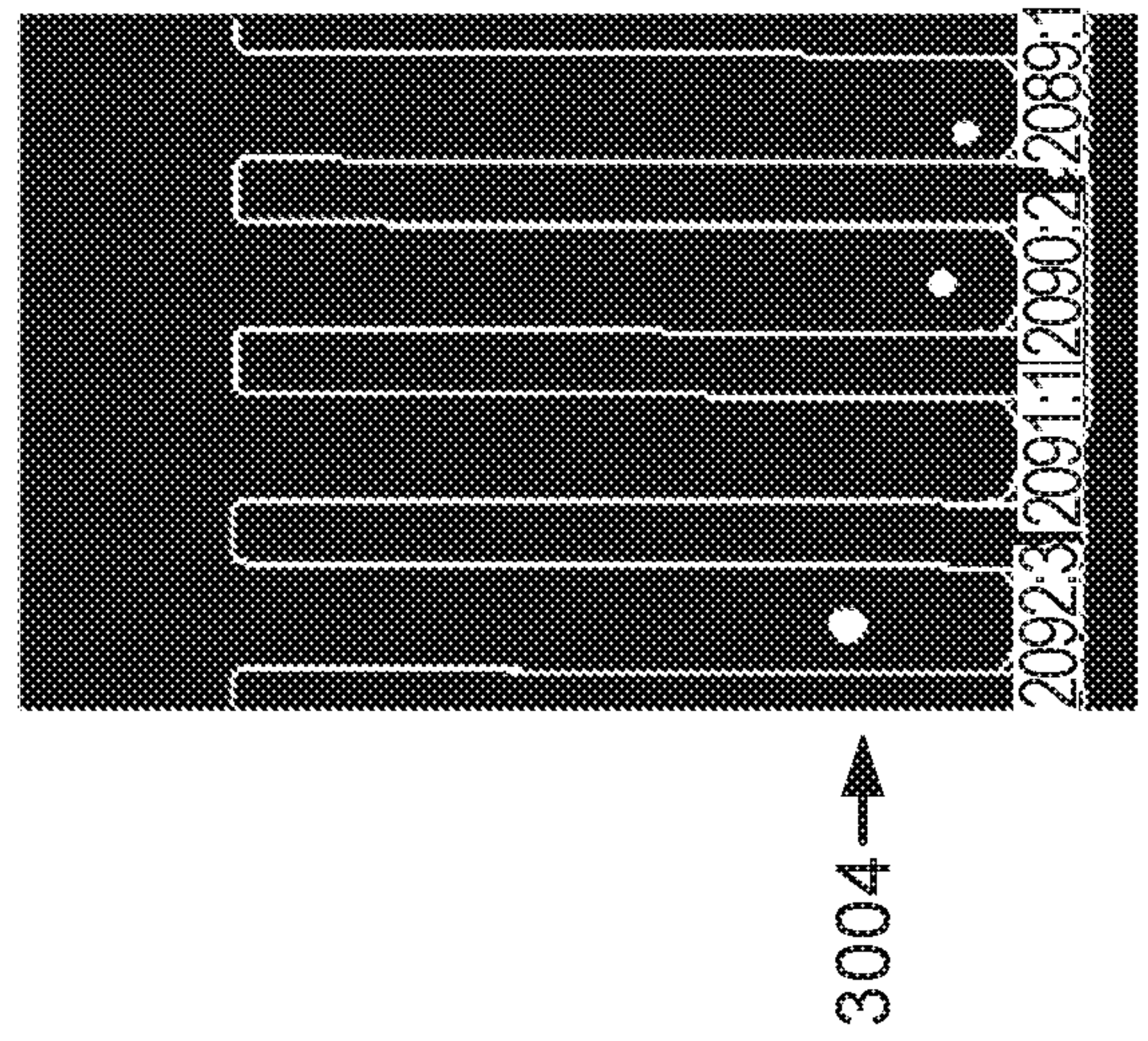

FIG. 30E

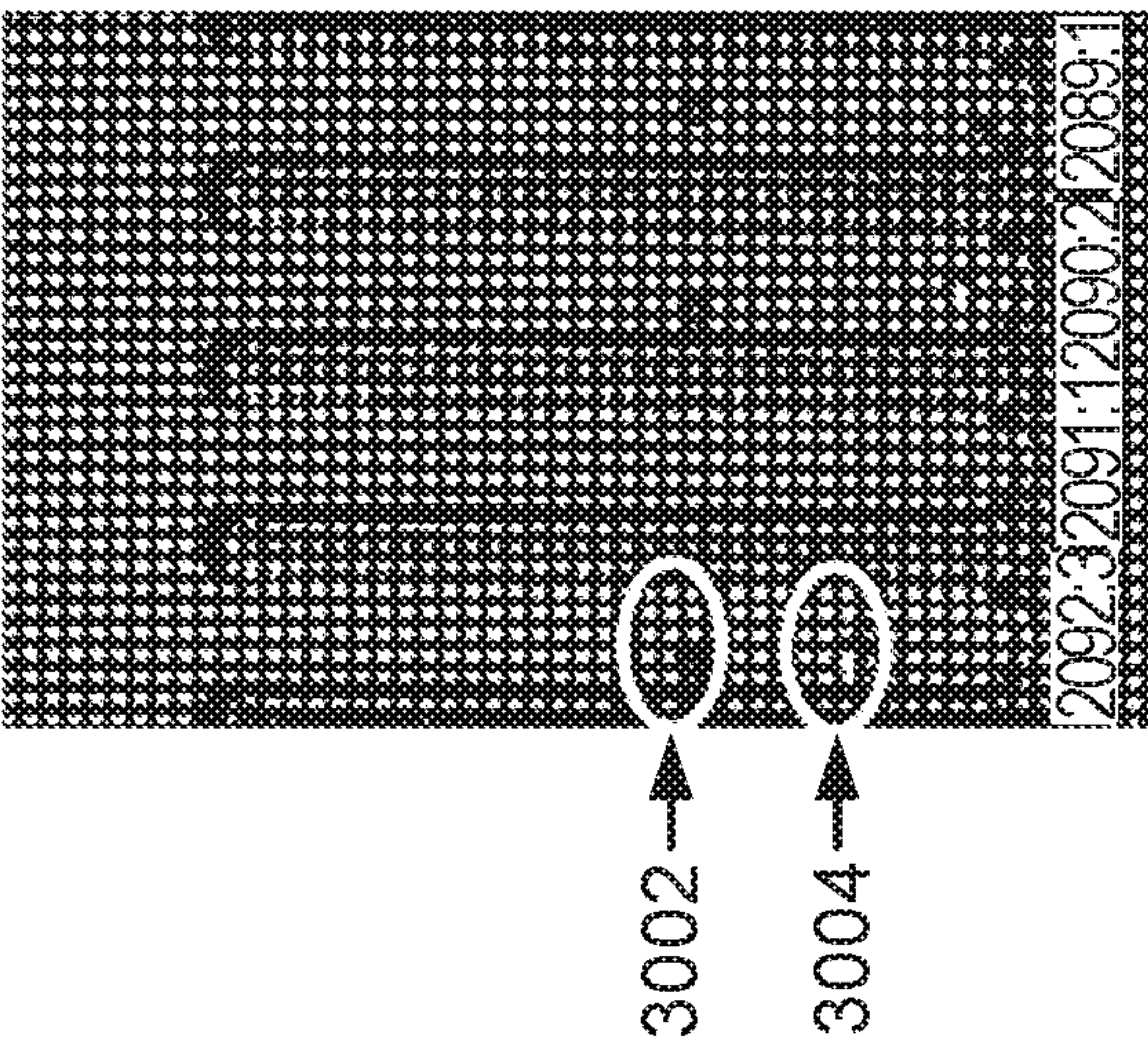

FIG. 30A

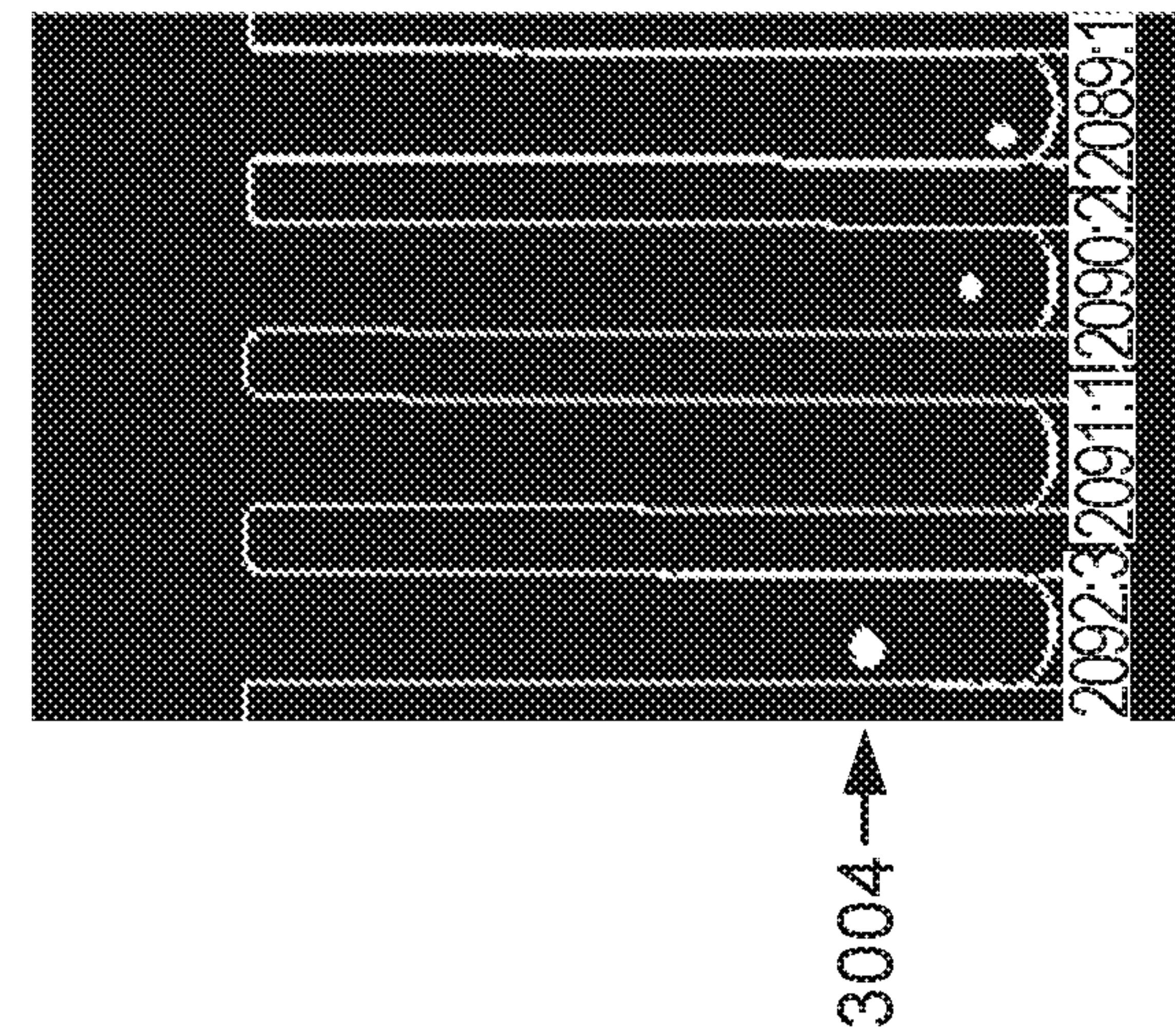
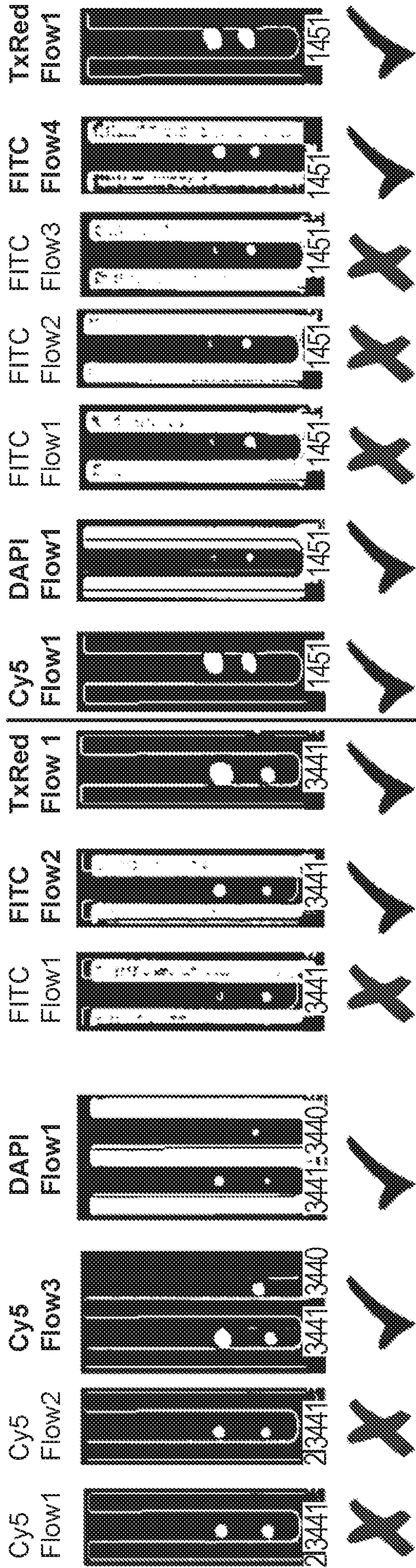

FIG. 30D



Pen 3441
 Barcode: C3D11F22T31
 SEQ ID NO. 3/SEQ ID NO. 11/SEQ ID NO. 22/SEQ ID NO. 31

Pen 1451
 Barcode: C1D11F24T31
 SEQ ID NO. 1/SEQ ID NO. 11/SEQ ID NO. 24/SEQ ID NO. 31

FIG. 31A

FIG. 31B

CLUSTAL O(1.2.4) multiple sequence alignment

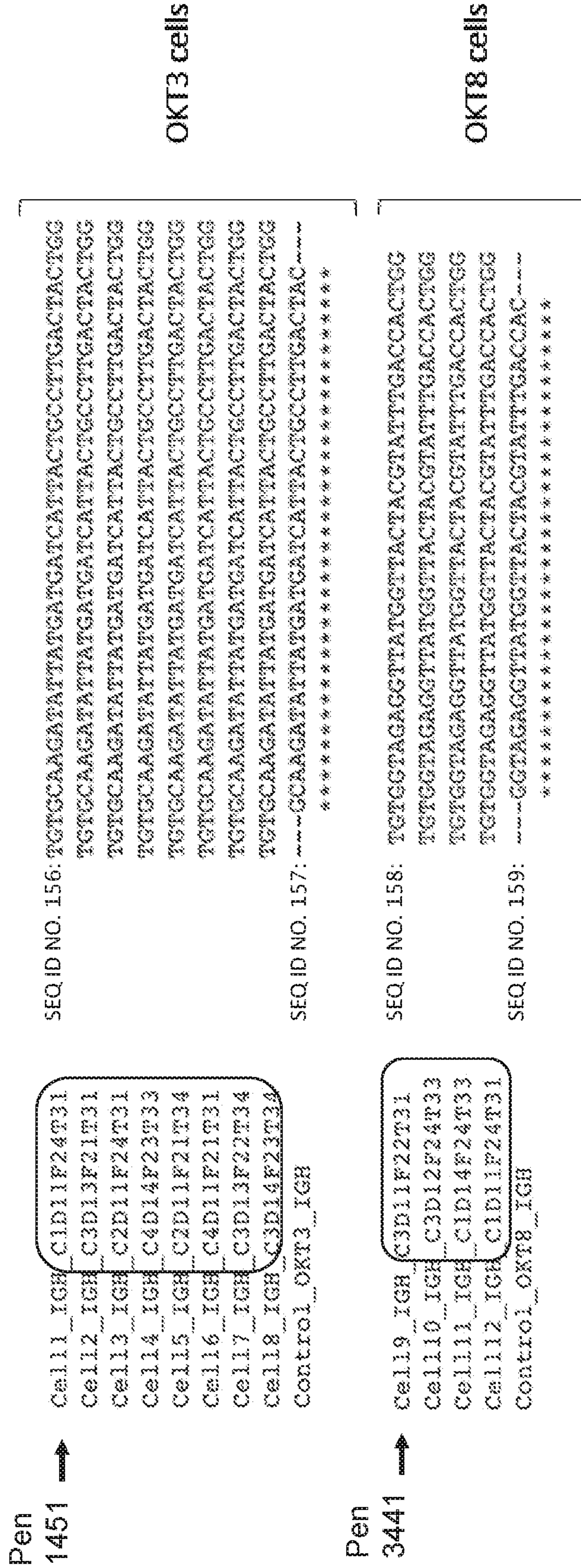

Individual cell barcodes determined by sequencing

Perfectly matching CDR3 sequences from two distinct sets of barcoded cell types

FIG. 32

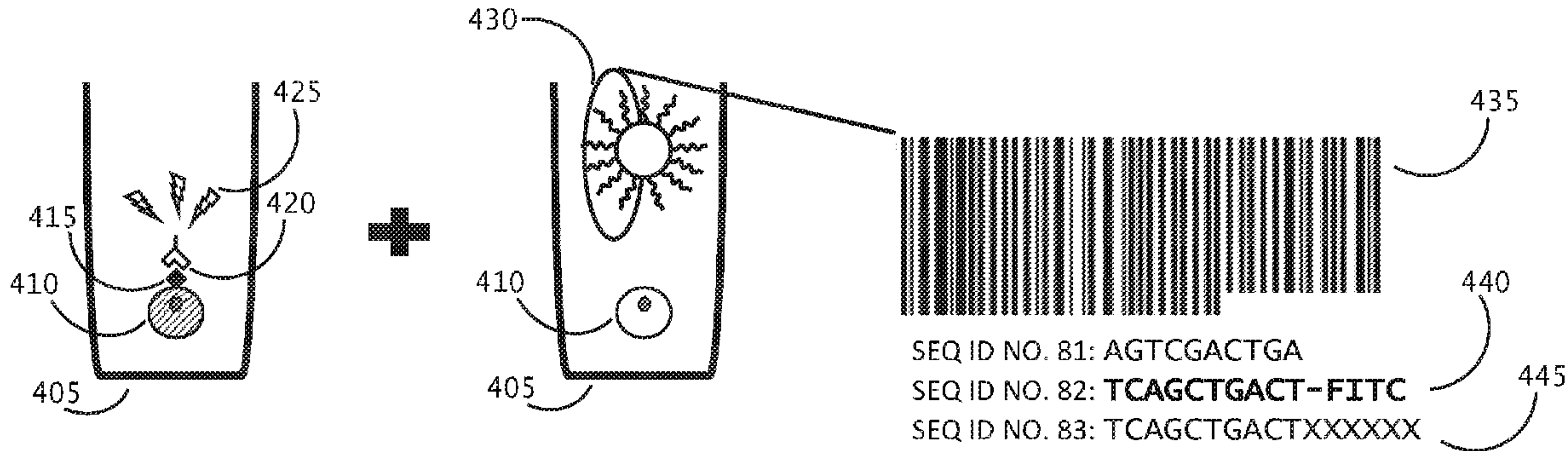

FIG. 4A