



US00D768854S

(12) **United States Design Patent** (10) **Patent No.:** **US D768,854 S**
Halleck et al. (45) **Date of Patent:** **** Oct. 11, 2016**

(54) **ENDOSCOPIC VIDEO CAMERA**
(71) Applicants: **Kevin E. Halleck**, Santa Barbara, CA (US); **Greg M. Chambers**, San Luis Obispo, CA (US); **Judi Wheeler**, Ventura, CA (US)
(72) Inventors: **Kevin E. Halleck**, Santa Barbara, CA (US); **Greg M. Chambers**, San Luis Obispo, CA (US); **Judi Wheeler**, Ventura, CA (US)
(73) Assignee: **Karl Storz Imaging, Inc.**, Goleta, CA (US)
(**) Term: **15 Years**
(21) Appl. No.: **29/530,978**

D598,545 S * 8/2009 Haines, III D24/137
D607,032 S 12/2009 Halleck et al.
D639,428 S * 6/2011 Yasue D24/137
D643,534 S 8/2011 Halleck et al.
D651,312 S 12/2011 Halleck et al.
D664,647 S * 7/2012 Becker D24/133
D664,648 S * 7/2012 Becker D24/133
D664,649 S * 7/2012 Becker D24/133
D669,580 S * 10/2012 Eisenkolb D24/137
D670,383 S * 11/2012 Eisenkolb D24/137
D672,462 S * 12/2012 Campo D24/138
D687,476 S 8/2013 Halleck et al.
D695,228 S 12/2013 Halleck et al.
D716,942 S * 11/2014 Eisenkolb D24/138
D717,432 S * 11/2014 Leroy D24/138
D720,069 S * 12/2014 Kaercher D24/133
D739,016 S * 9/2015 Berci D24/138
D743,027 S * 11/2015 Renner D24/138
2005/0267329 A1 12/2005 Konstorum et al.
2007/0276183 A1 11/2007 Melder
2010/0069711 A1 3/2010 Deng et al.

(22) Filed: **Jun. 22, 2015**
(51) **LOC (10) Cl.** **24-02**
(52) **U.S. Cl.**
USPC **D24/138**
(58) **Field of Classification Search**
USPC D24/133, 137, 138, 222, 141, 108, 111, D24/113, 127, 143, 148, 179, 216, 152, 153, D24/154, 176; D8/4, 29.1, 29.2, 30, 31, 39
CPC A61B 1/00128; A61B 1/018; A61B 17/320016; A61B 17/3423; A61B 1/00135; A61B 1/12; A61B 2017/00477; A61B 2017/347; A61B 17/00234; A61B 17/00491; A61B 1/00066; A61B 1/00133; A61B 1/00147

See application file for complete search history.

(56) **References Cited**

U.S. PATENT DOCUMENTS

D474,276 S 5/2003 Greise et al.
D474,745 S 5/2003 Amling et al.
D482,334 S 11/2003 Amling et al.
D501,864 S 2/2005 Greise et al.
D523,455 S 6/2006 Greise et al.
D581,051 S 11/2008 Melder
D587,804 S 3/2009 Ruiz et al.

OTHER PUBLICATIONS

U.S. Appl. No. 29/441,115, filed Dec. 31, 2012, Mirrer, et al.

* cited by examiner

Primary Examiner — Robert M Spear
Assistant Examiner — Eliza Bennett-Hattan
(74) *Attorney, Agent, or Firm* — Whitmyer IP Group LLC

(57) **CLAIM**

The ornamental design for an endoscopic video camera, as shown and described.

DESCRIPTION

FIG. 1 is a front and right side isometric view of an endoscopic video camera in accordance with the new design;
FIG. 2 is a top plan view thereof;
FIG. 3 is a bottom plan view thereof;
FIG. 4 is a right side elevational view thereof;
FIG. 5 is a left side elevational view thereof;
FIG. 6 is a front elevational view thereof; and,
FIG. 7 is a rear elevational view thereof.

1 Claim, 7 Drawing Sheets

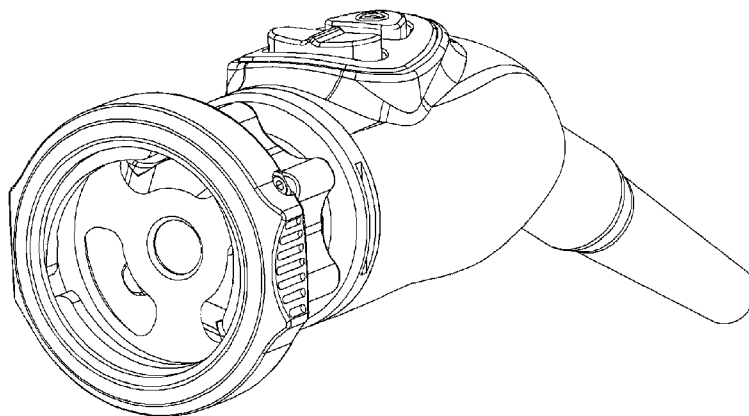

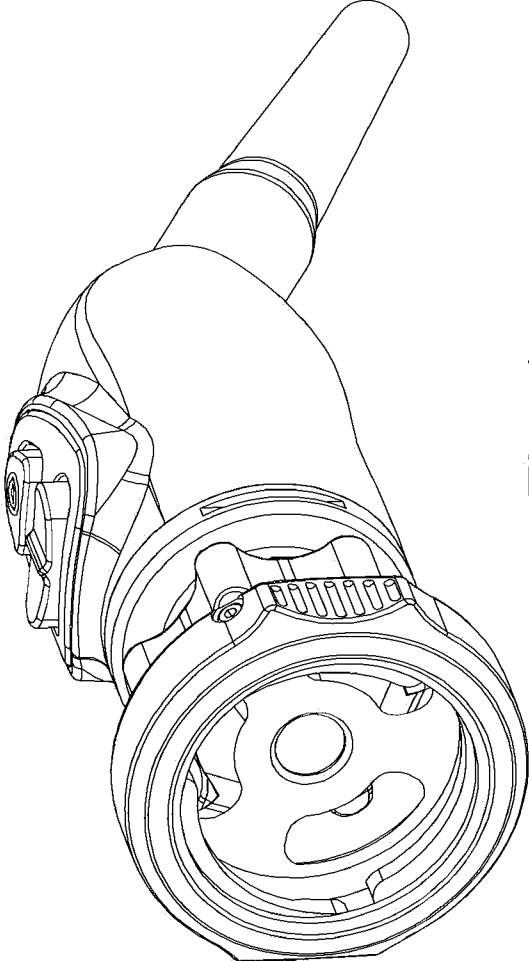

Fig. 1

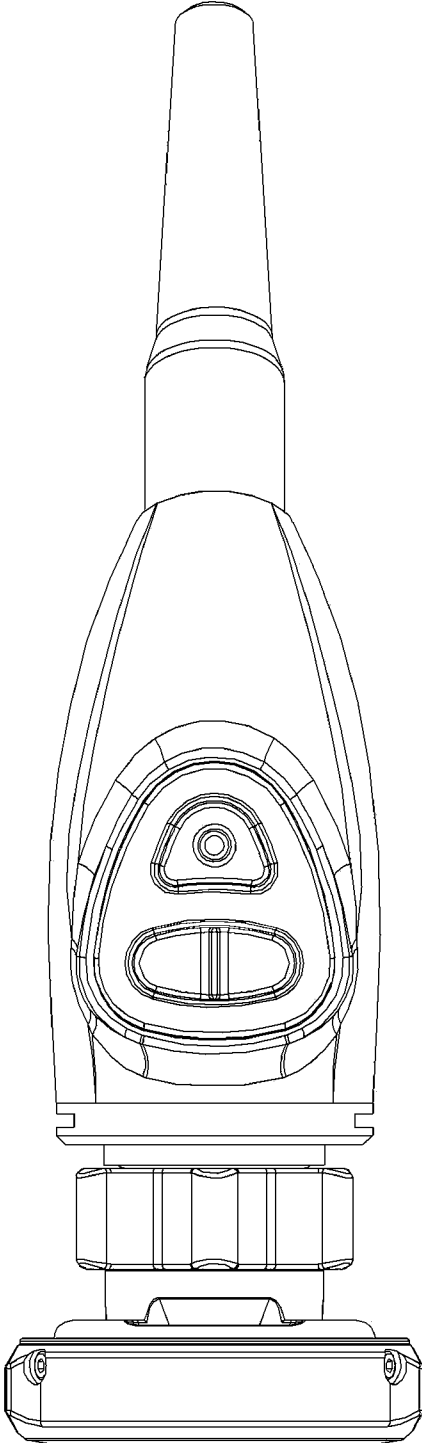

Fig. 2

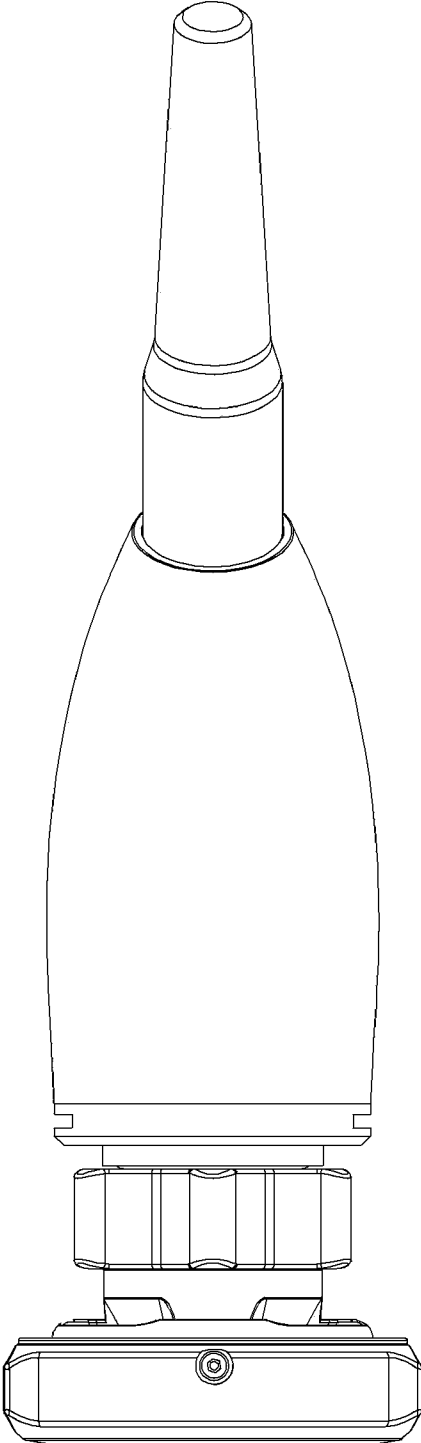

Fig. 3

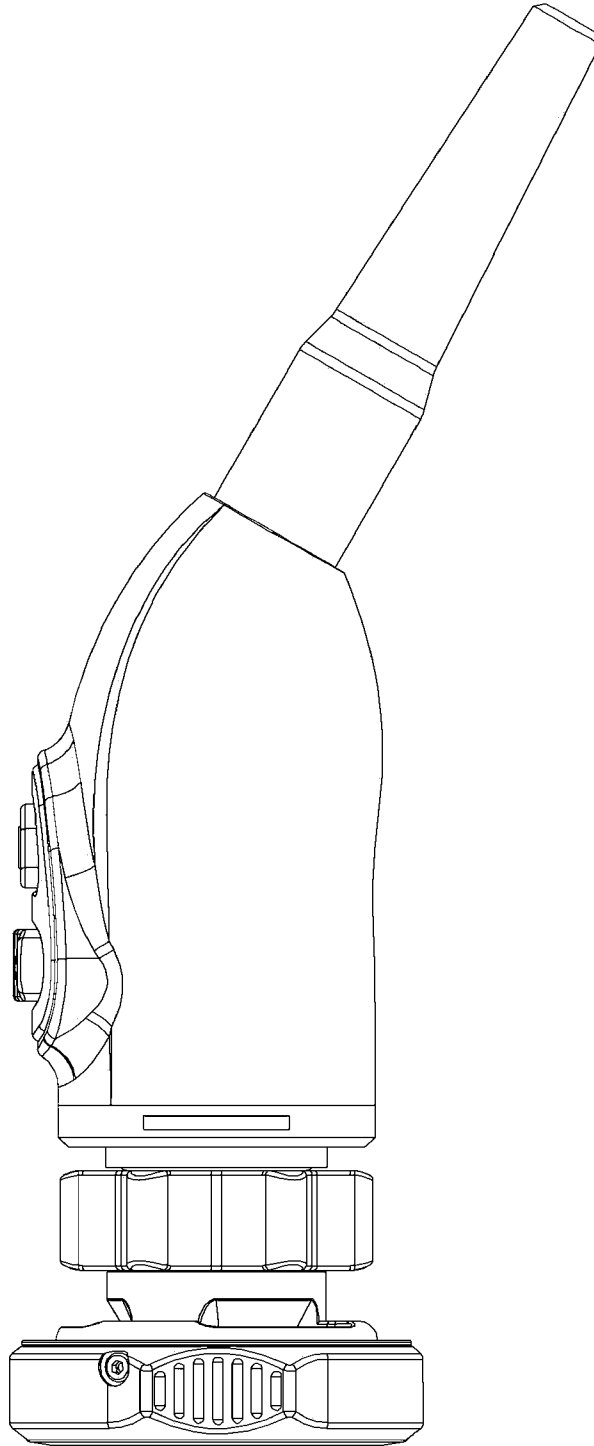

Fig. 4

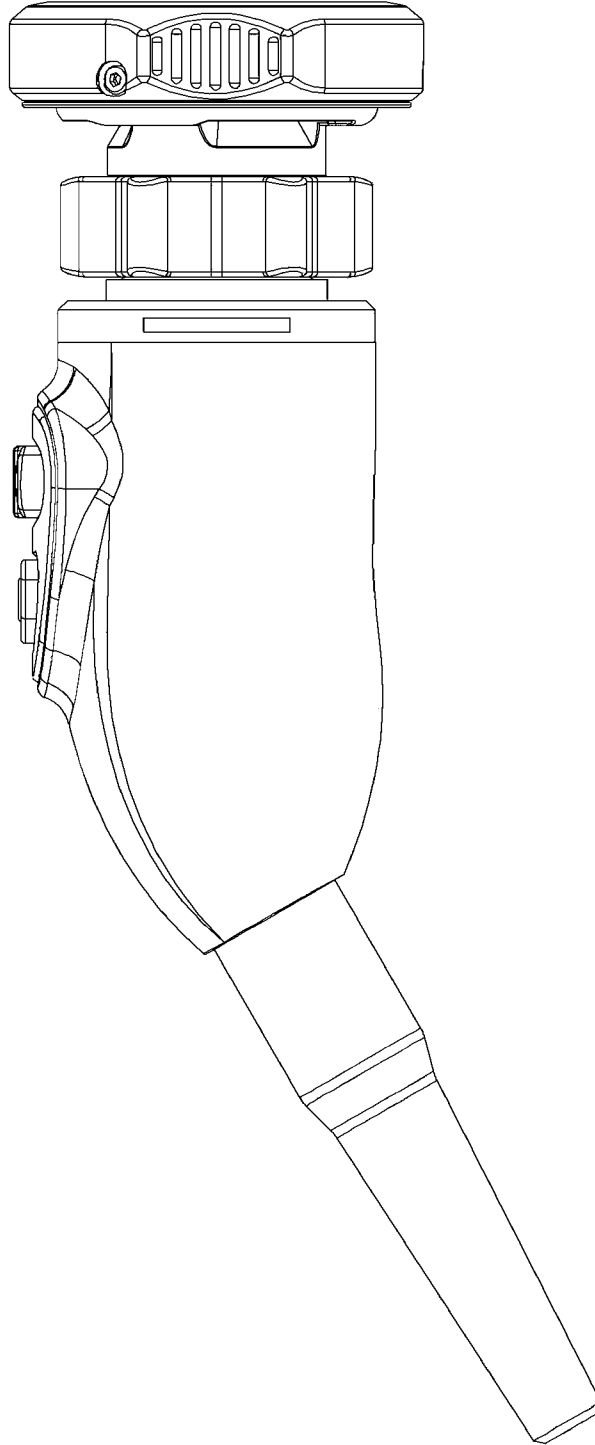

Fig. 5

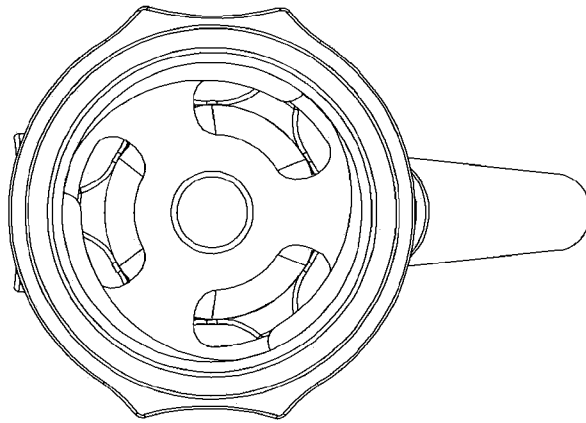

Fig. 6

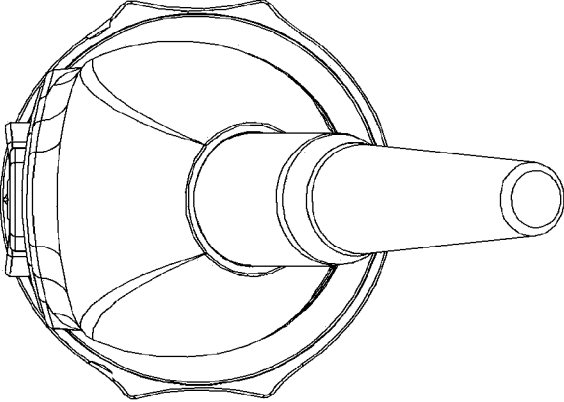

Fig. 7