



US00D983028S

(12) **United States Design Patent** (10) **Patent No.:** **US D983,028 S**  
**Kole et al.** (45) **Date of Patent:** **\*\* Apr. 11, 2023**

(54) **SEAT POST CLAMP ASSEMBLY**

OTHER PUBLICATIONS

- (71) Applicant: **Lyft, Inc.**, San Francisco, CA (US)
- (72) Inventors: **Jared Mitchell Kole**, San Jose, CA (US); **Alejandro Salvador Garcia**, San Francisco, CA (US)
- (73) Assignee: **Lyft, Inc.**, San Francisco, CA (US)
- (\*\*) Term: **15 Years**
- (21) Appl. No.: **29/729,832**
- (22) Filed: **Mar. 30, 2020**

Odier Bike Bicycle Quick Release SeatPost Clamp , Google.com, [online], [site visited Feb. 12, 2022], Available from internet URL: <https://i-deals.net/product/odier-bike-bicycle-quick-release-seatpost-clamp-34-9mm-31-8mm-mtb-bike-road-bike-casual-bike-seatpost-clamp/> (Year: NA).\*

(Continued)

*Primary Examiner* — Michael A. Pratt  
(74) *Attorney, Agent, or Firm* — Baker Botts L.L.P.

(57) **CLAIM**

The ornamental design for a seat post clamp assembly, as shown and described.

**DESCRIPTION**

FIG. 1 is a rear, left, and top perspective view of a seat post clamp assembly embodying the new design;  
 FIG. 2 a front, right, and bottom perspective view thereof;  
 FIG. 3 is a top plan view thereof;  
 FIG. 4 is a bottom plan view thereof;  
 FIG. 5 is a left side elevational view thereof;  
 FIG. 6 is a right side elevational view thereof;  
 FIG. 7 is a rear elevational view thereof;  
 FIG. 8 is a front elevational view thereof;  
 FIG. 9 is a rear, left, and top perspective view thereof for an embodiment of FIGS. 1-8, with certain portions set forth in dashed or dot-dash lines; and,  
 FIG. 10 is a bottom plan view thereof.

The dash lines, the areas within them, and the areas bounded by dot-dash lines that are within portions of the seat post clamp assembly defined by solid lines depict portions of the seat post clamp assembly that form no part of the claimed design. The broken lines immediately adjacent the shaded areas represent the bounds of the claimed design while all other broken lines are directed to environment and are for illustrative purposes only; the broken lines form no part of the claimed design.

**Related U.S. Application Data**

- (63) Continuation of application No. 16/792,177, filed on Feb. 14, 2020.
- (51) **LOC (14) Cl.** ..... **08-08**
- (52) **U.S. Cl.**  
USPC ..... **D8/396**
- (58) **Field of Classification Search**  
USPC .... D8/349, 352, 382, 72, 394, 395, 396, 73, D8/383, 323, 306, 325, 356, 71;  
(Continued)

(56) **References Cited**

**U.S. PATENT DOCUMENTS**

- 5,548,876 A \* 8/1996 Oetiker ..... B65D 63/02  
24/271
- 5,988,694 A \* 11/1999 Brushaber ..... F16L 23/06  
285/365

(Continued)

**FOREIGN PATENT DOCUMENTS**

- CA 152631 \* 2/2015
- KR 300732280.0000 \* 3/2014

**1 Claim, 10 Drawing Sheets**

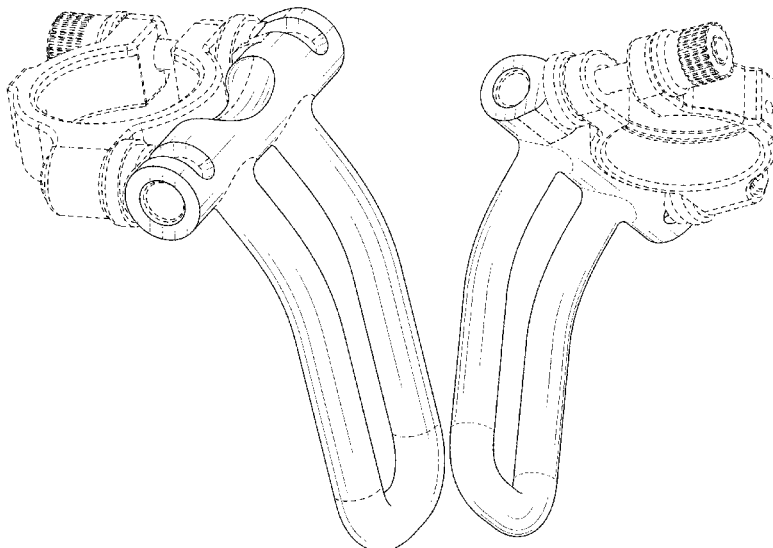

(58) **Field of Classification Search**

USPC ..... D16/242, 245; D23/266, 265; D21/366;  
 D24/230, 127; D7/620  
 CPC . F16L 3/1025; F16L 1/123; F16L 3/08; F16L  
 3/237; F16L 3/1075; F16L 3/24; F16L  
 3/1218; F16L 3/003; E21B 17/1035;  
 E21B 19/02; F16B 2/065; F16B 7/0433;  
 F16B 2/10; Y10T 403/70; Y10T  
 403/5753; A62C 33/04

See application file for complete search history.

D797,549 S \* 9/2017 Dew ..... D8/394  
 D798,699 S \* 10/2017 Roiser ..... D8/396  
 D803,757 S \* 11/2017 Giordano ..... D12/415  
 D809,991 S \* 2/2018 Giordano ..... D12/415  
 D833,265 S \* 11/2018 Meola ..... D8/396  
 10,408,371 B2 \* 9/2019 Floyd ..... F16L 23/06  
 D893,239 S \* 8/2020 Van Den Nieuwenhuizen .....  
 D7/354  
 D938,816 S \* 12/2021 Byerly ..... D8/396  
 2017/0191589 A1 \* 7/2017 Floyd ..... F16L 23/06  
 2020/0049454 A1 \* 2/2020 Leutzinger ..... F21V 21/0885  
 2021/0253191 A1 \* 8/2021 Kole ..... B62K 3/002  
 2022/0090880 A1 \* 3/2022 Leutzinger ..... F21V 21/145

(56) **References Cited**

U.S. PATENT DOCUMENTS

7,303,448 B1 \* 12/2007 Sproesser ..... H01R 11/282  
 439/772  
 D668,522 S \* 10/2012 Henderson ..... D8/73  
 D736,189 S \* 8/2015 Cooper ..... D14/229  
 D777,548 S \* 1/2017 Trotsky ..... D8/72  
 9,543,666 B2 \* 1/2017 Wendt ..... H01R 4/28  
 D780,549 S \* 3/2017 Zhang ..... D8/74  
 D781,122 S \* 3/2017 Zimmerman ..... D15/28

OTHER PUBLICATIONS

31.8 mm Alloy Quick Release Seat Post Clamp , Google.com,  
 [online], [site visited Feb. 12, 2022], Available from internet URL:  
<https://www.homedepot.com/p/Ventura-31-8-mm-Alloy-Quick-Release-Seat-Post-Clamp-250897/206781546?source=shoppingads&locale=en-US#overlay> (Year: NA).\*

\* cited by examiner

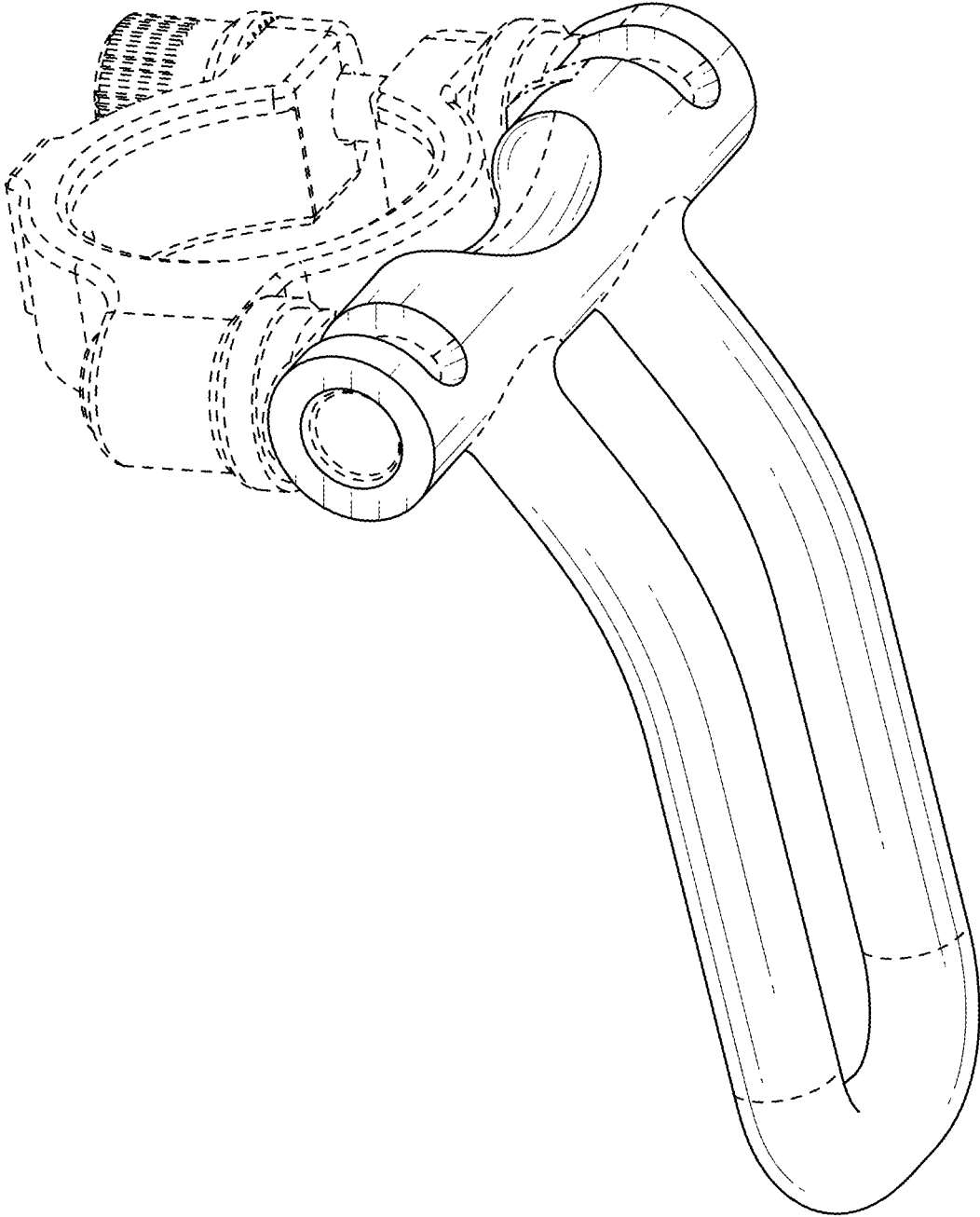

FIG. 1

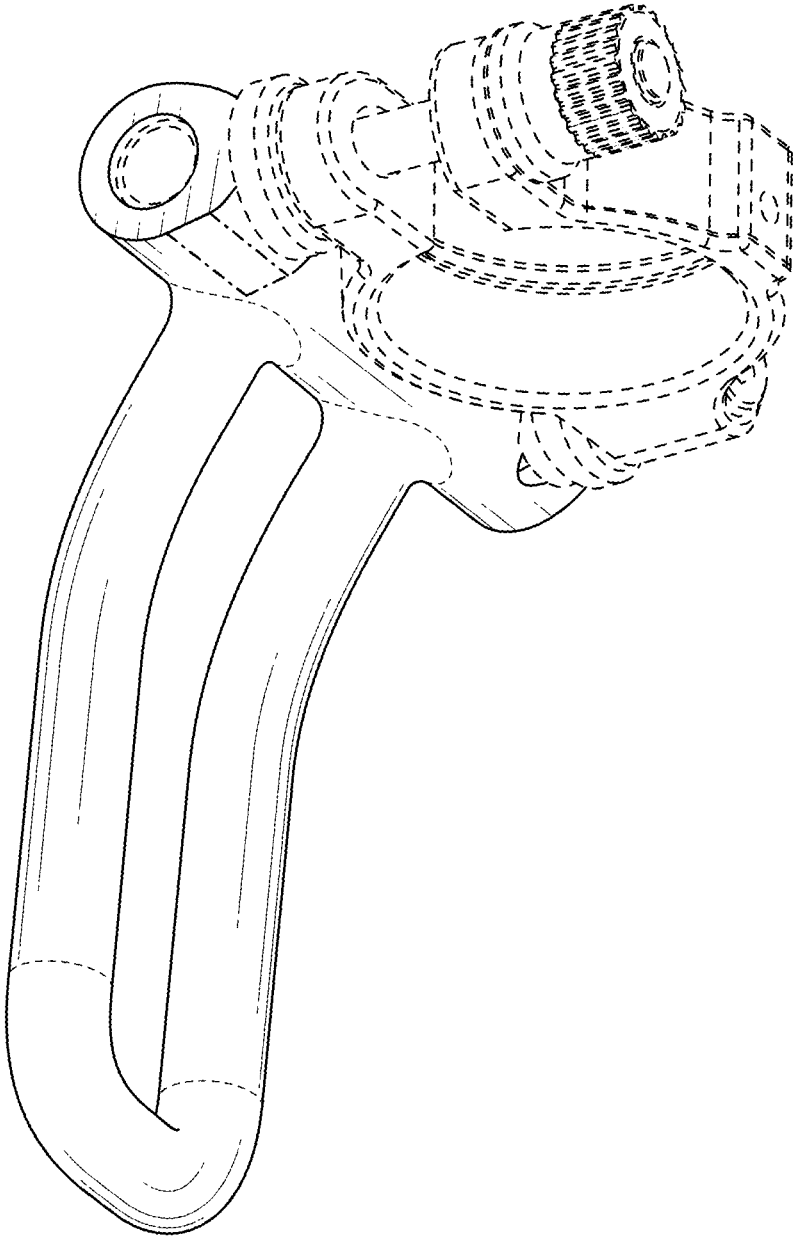

FIG. 2

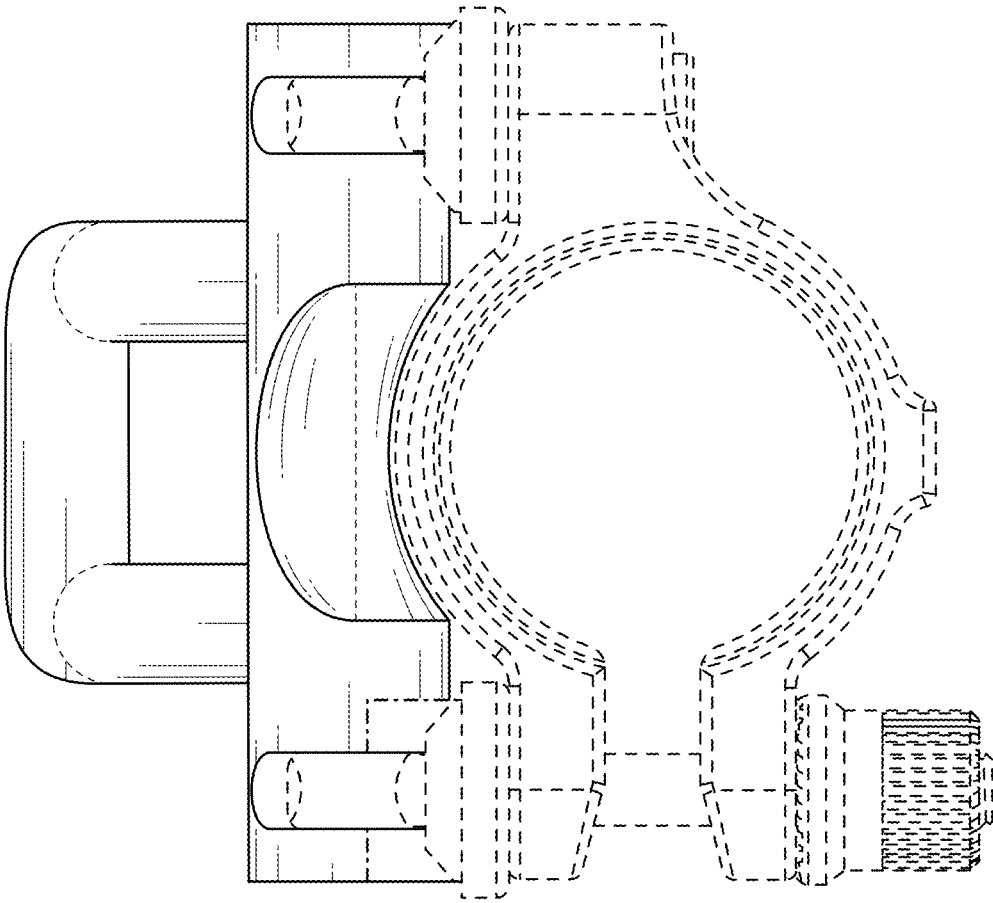

FIG. 3

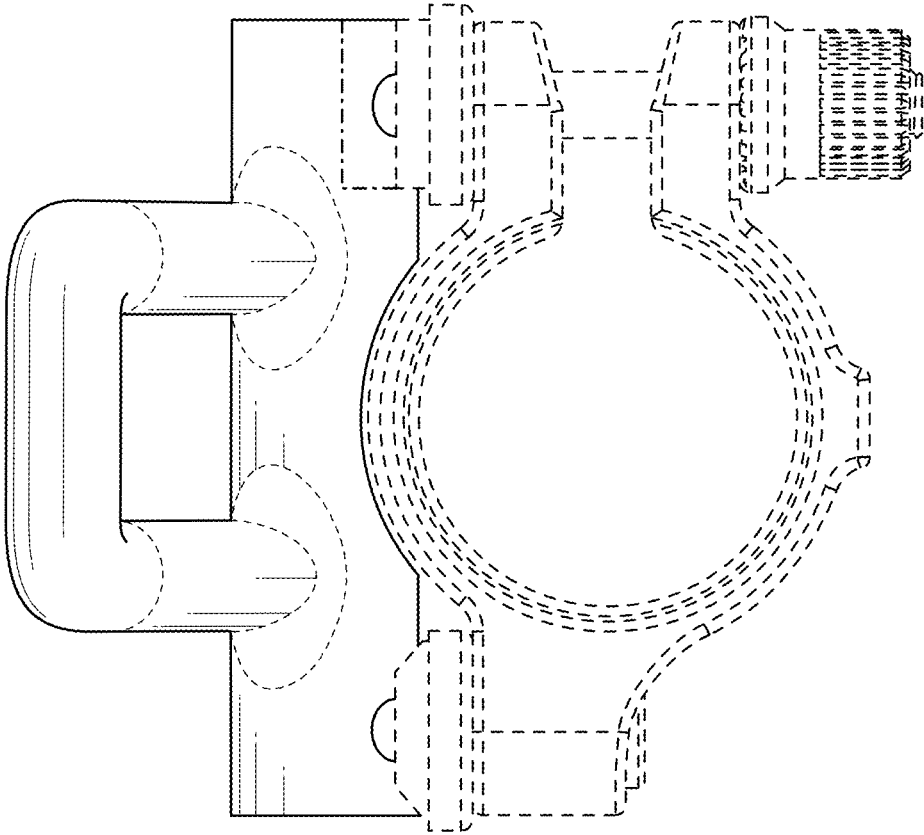

FIG. 4

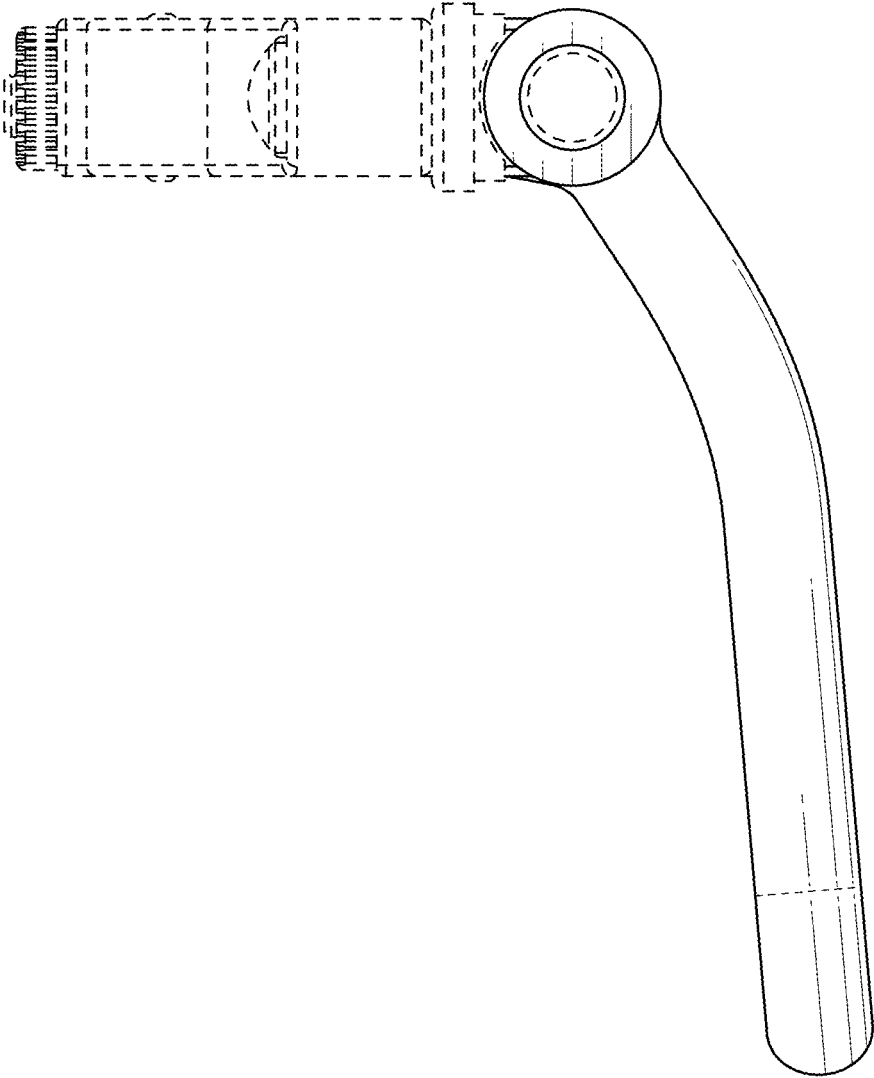

FIG. 5

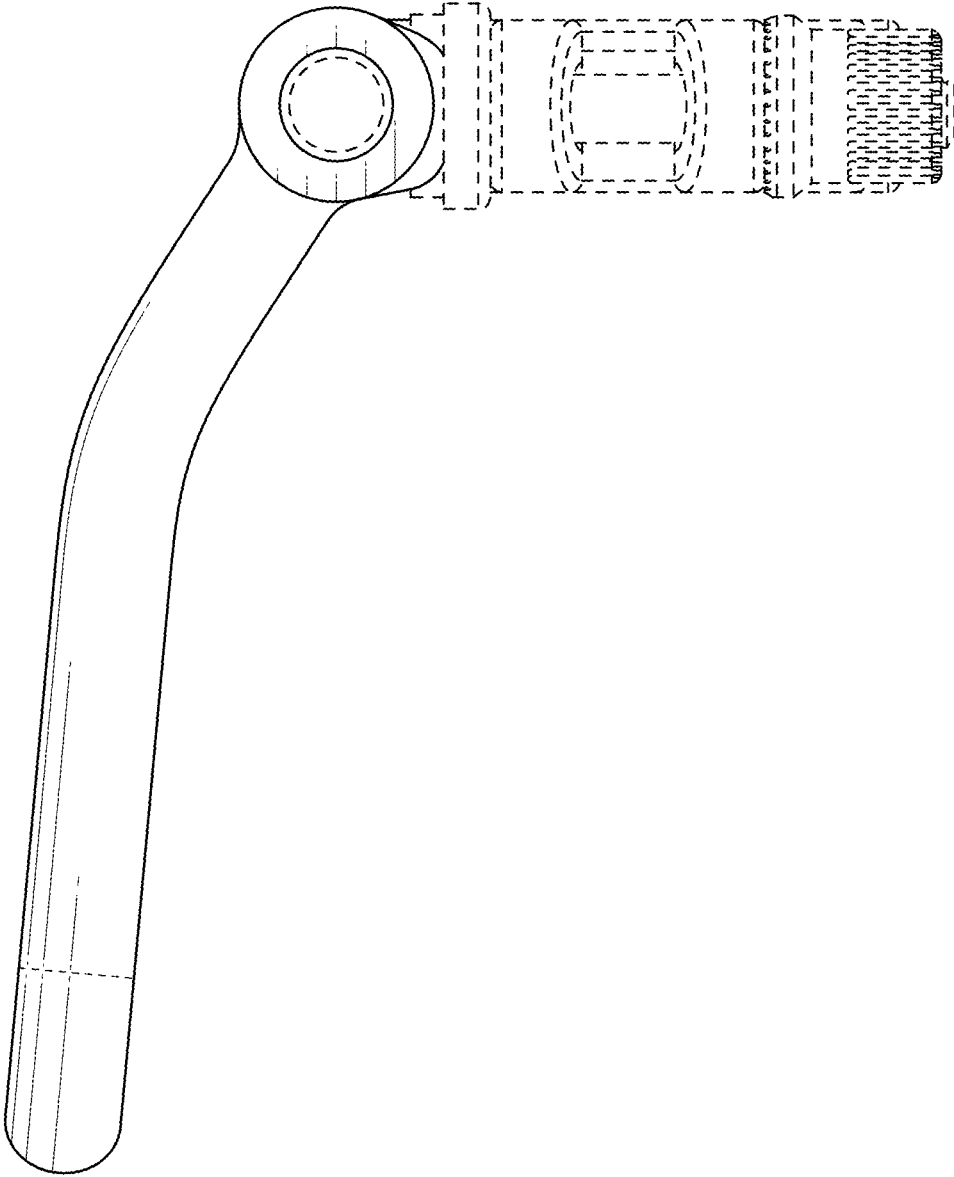

FIG. 6



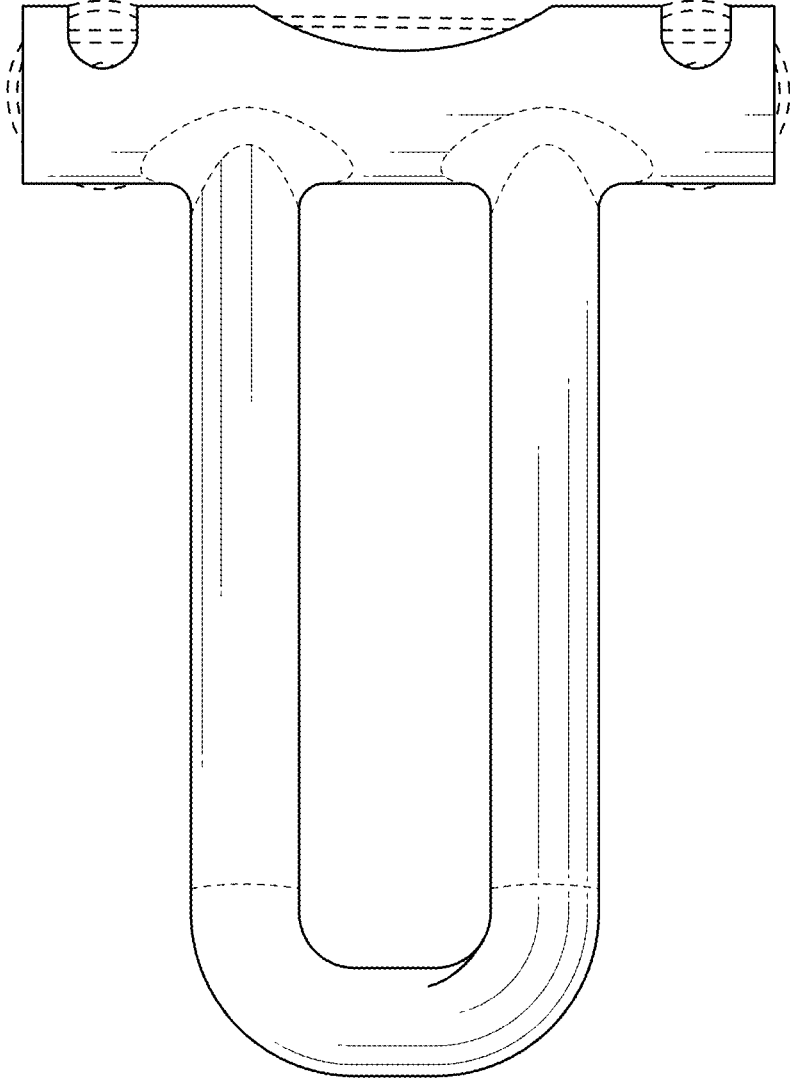

FIG. 7

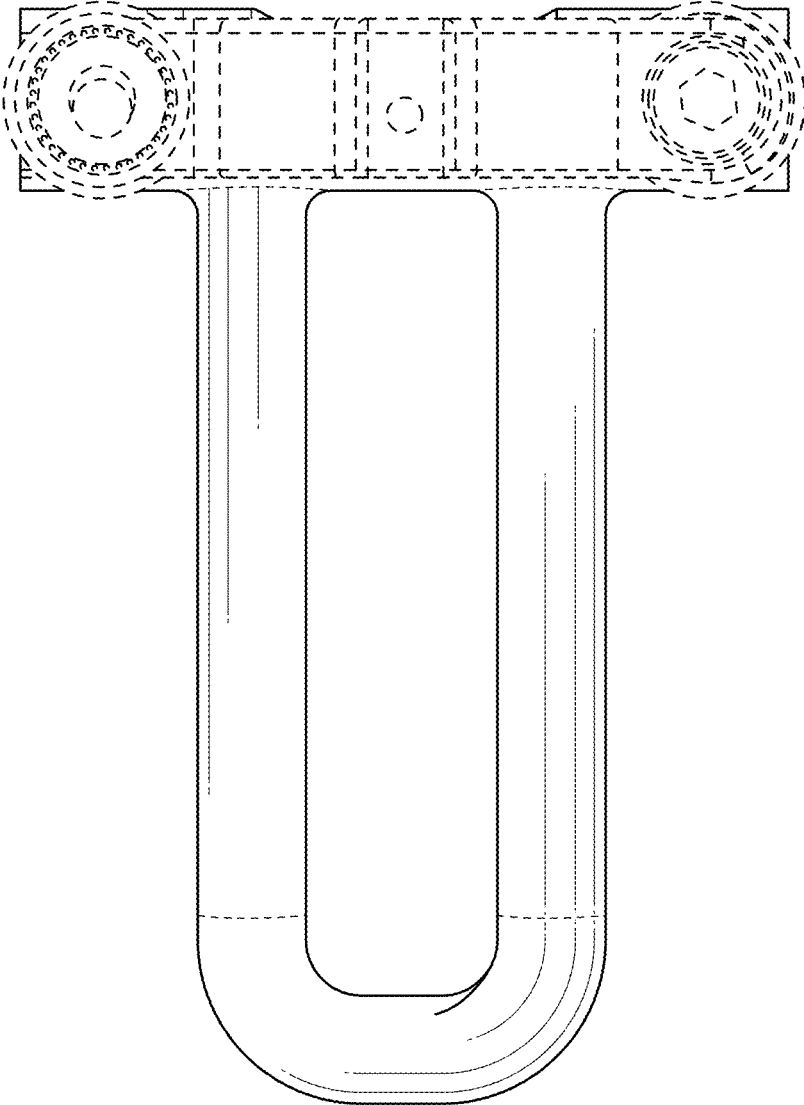

FIG. 8

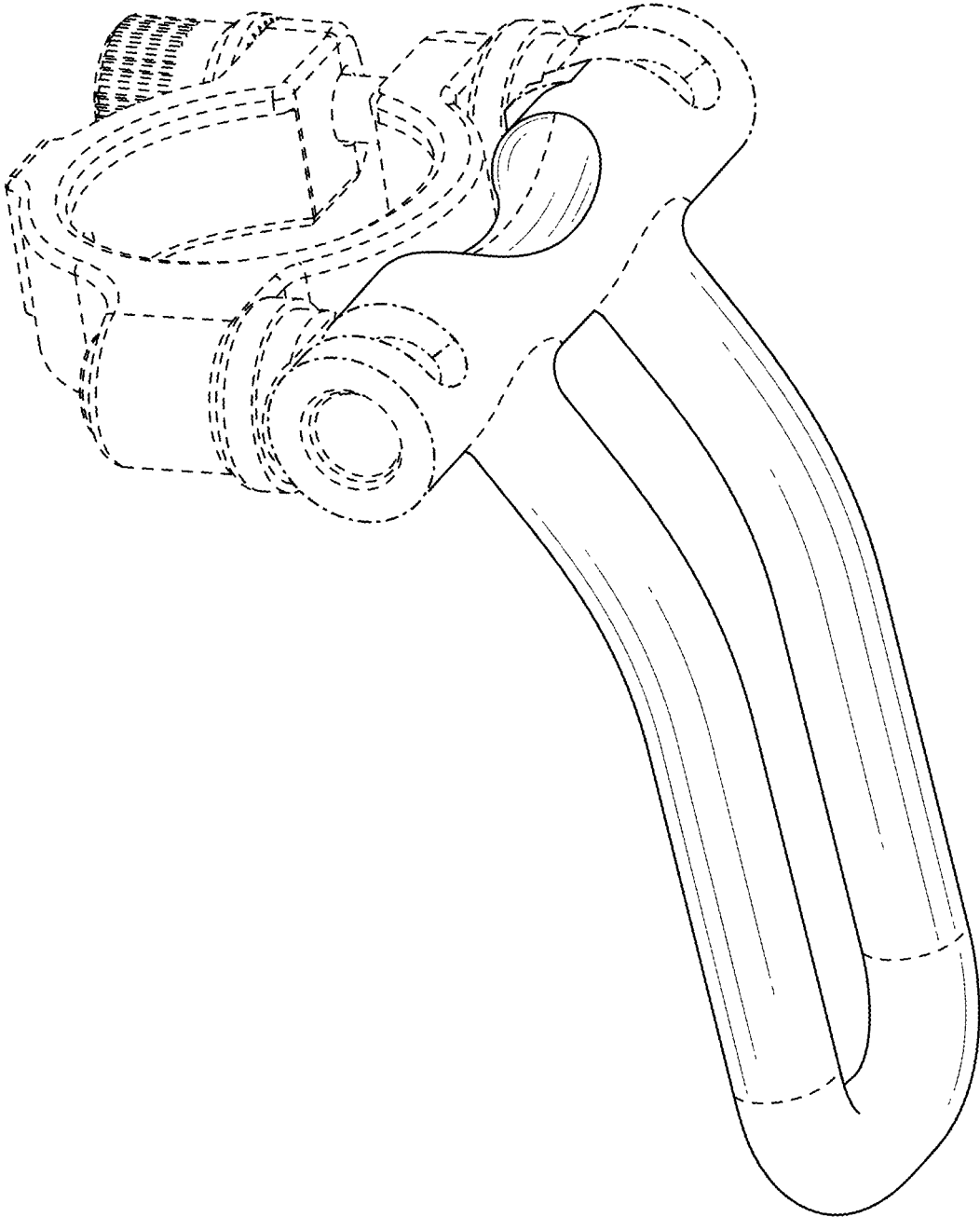

FIG. 9

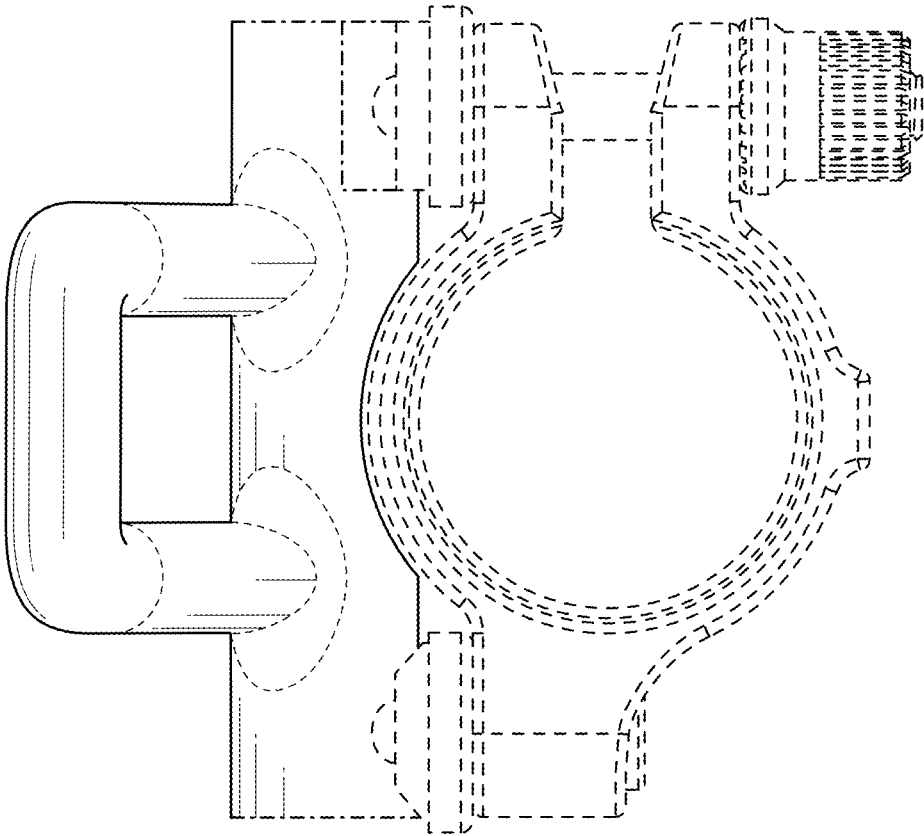

FIG. 10