



US00D764256S

(12) **United States Design Patent** (10) **Patent No.:** **US D764,256 S**
DeDios-Shirley et al. (45) **Date of Patent:** **** Aug. 23, 2016**

(54) **MOUNTING DEVICE** 5,227,582 A * 7/1993 Velasco H04N 5/655
174/372
(71) Applicant: **HIDEit Mounts, Inc., Reno, NV (US)** D409,079 S * 5/1999 Sobczynski D8/354
6,554,527 B1 * 4/2003 O'Donnell F16M 13/02
403/353
(72) Inventors: **Relina Belen DeDios-Shirley, Reno, NV (US); Charles Edward Shirley, Reno, NV (US)** D710,340 S * 8/2014 Wengreen D14/238.1
D734,305 S * 7/2015 Wengreen D14/238
D735,174 S * 7/2015 Wengreen D14/238
2005/0023419 A1 * 2/2005 Frankel A47J 45/02
248/206.3
(73) Assignee: **HIDEit Mounts, Inc., Reno, NV (US)** 2007/0235609 A1 * 10/2007 Chun F16M 11/126
248/231.9
(**) Term: **15 Years** 2012/0312950 A1 * 12/2012 Sears F16M 11/041
248/316.5

(21) Appl. No.: **29/530,127**

* cited by examiner

(22) Filed: **Jun. 12, 2015**

Primary Examiner — Mark Goodwin

(51) **LOC (10) Cl.** **08-08**

(74) *Attorney, Agent, or Firm* — Holland & Hart LLP

(52) **U.S. Cl.** **D8/349**

(58) **Field of Classification Search**

(57) **CLAIM**

The ornamental design for a mounting device, as shown and described.

USPC **D8/349**
D8/380, 349, 381, 373, 354, 363, 355;
D14/432, 434, 447, 357, 299, 496,
D14/203.1–203.8, 238.1; 224/246, 250,
224/269, 901.4, 930, 669, 242; 248/127,
248/307, 309.1, 918; 348/836, 843, 373,
348/376, 825
CPC H05K 5/0204; H05K 7/14; F16M 13/02;
H04N 5/655; H04N 5/64; G06F 1/1601;
G06F 1/16; A45F 5/00; A45F 5/021; A45F
2200/0516; A45F 2200/0508; A45F
2200/0525

DESCRIPTION

FIG. 1 is a perspective view of the mounting device showing our new design;
FIG. 2 is a top plan view of the mounting device shown in FIG. 1;
FIG. 3 is a bottom plan view of the mounting device and mounting apparatus shown in FIG. 1;
FIG. 4 is a right side elevational view of the mounting device and mounting apparatus shown in FIG. 1;
FIG. 5 is a left side elevational view of the mounting device and mounting apparatus shown in FIG. 1;
FIG. 6 is a front elevational view of the mounting device and mounting apparatus shown in FIG. 1; and
FIG. 7 is a back elevational view of the mounting device and mounting apparatus shown in FIG. 1.

See application file for complete search history.

(56) **References Cited**

U.S. PATENT DOCUMENTS

D242,766 S * 12/1976 Neece D12/223
4,467,244 A * 8/1984 Dickie H04N 5/655
313/482

1 Claim, 5 Drawing Sheets

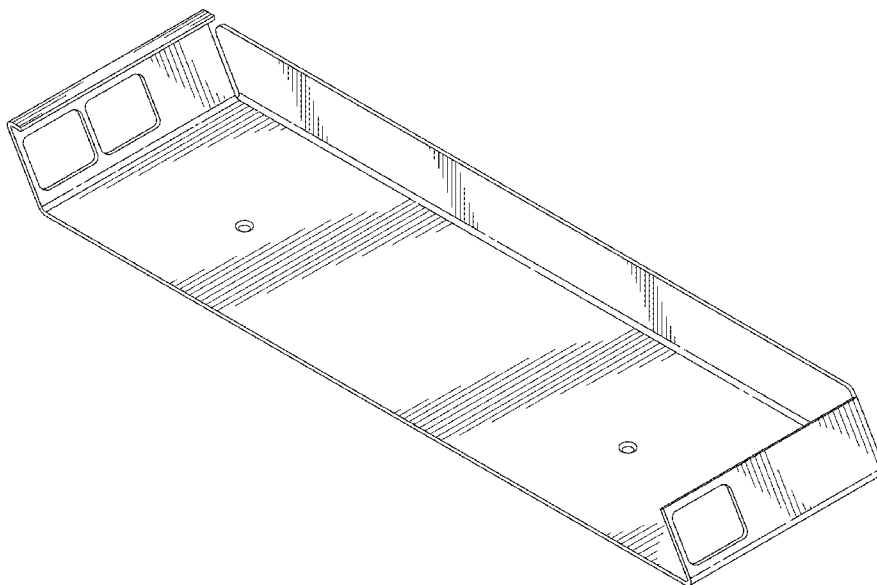

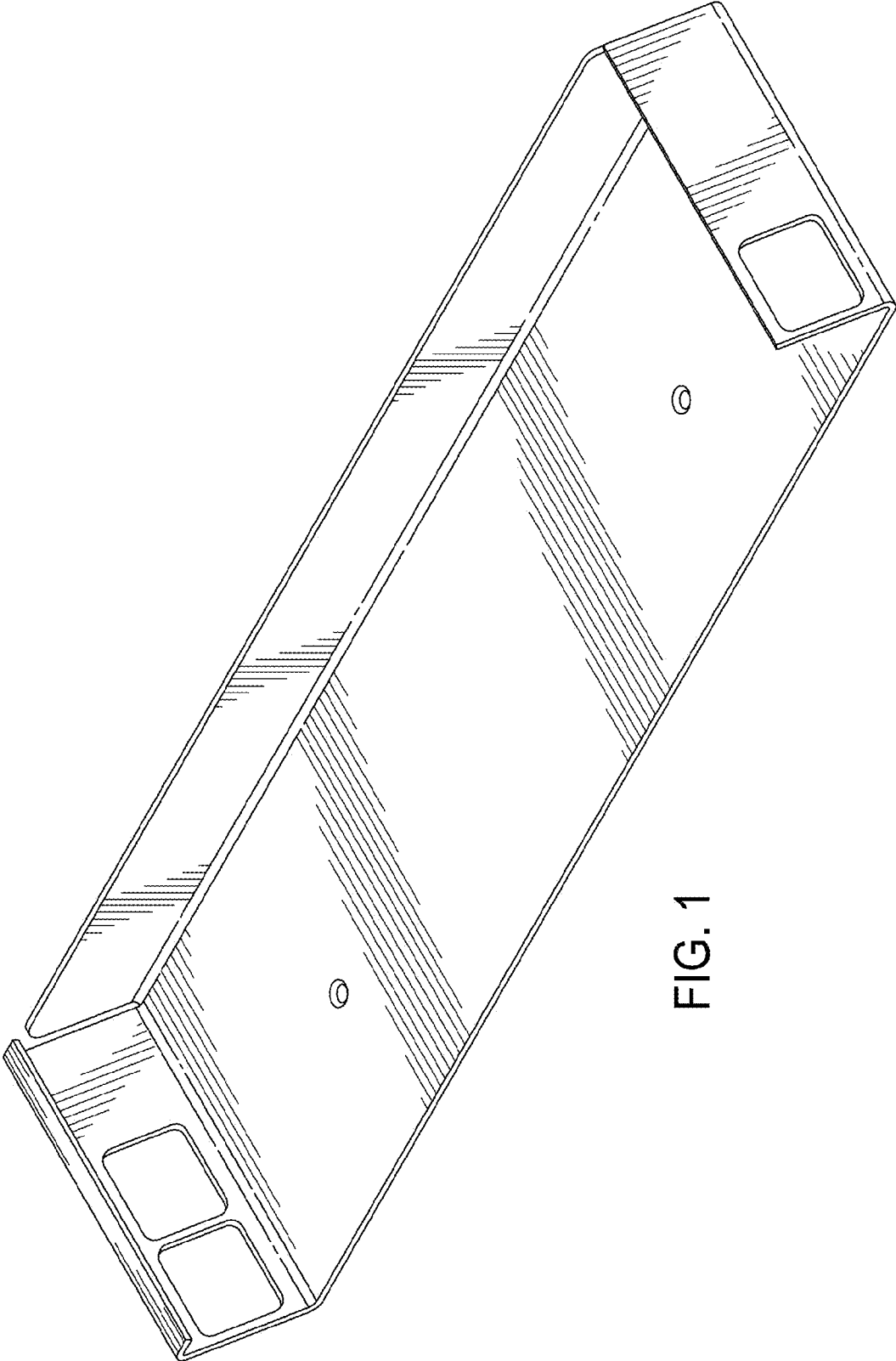

FIG. 1

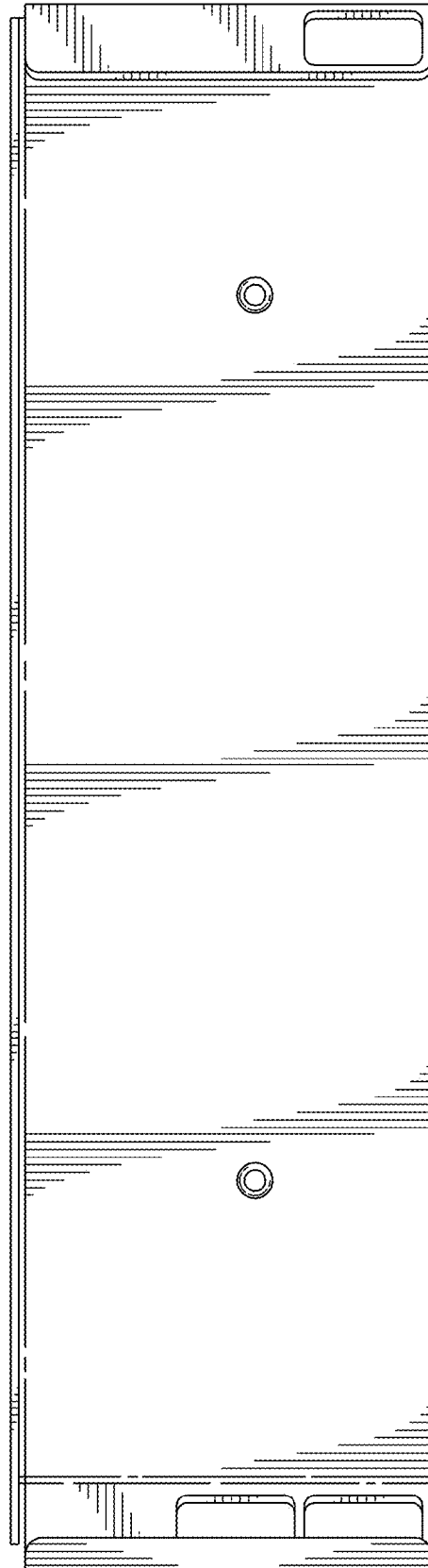

FIG. 2

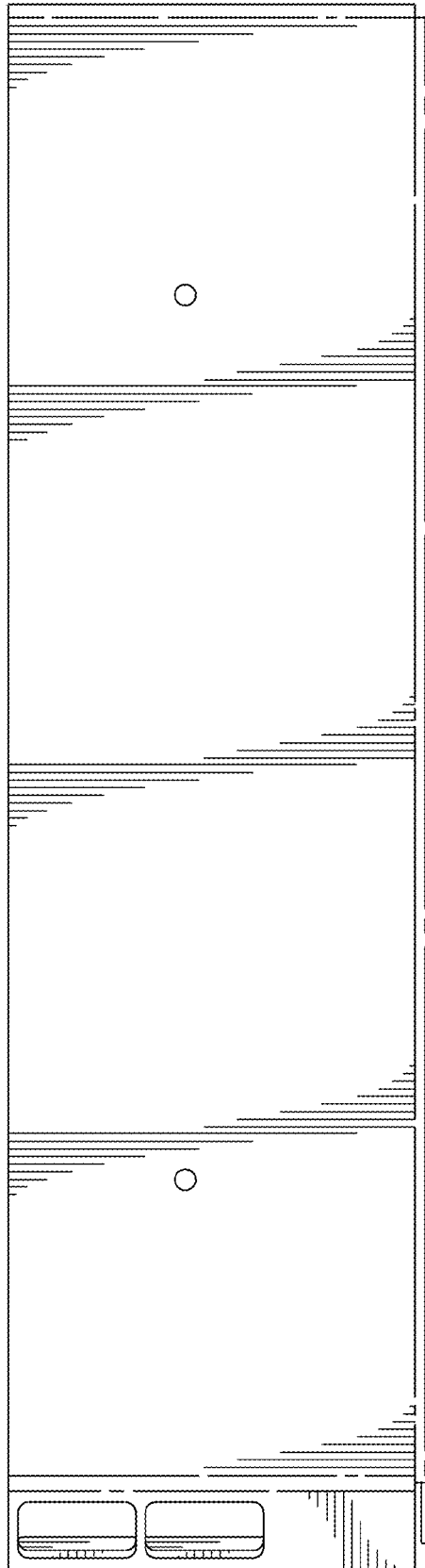

FIG. 3

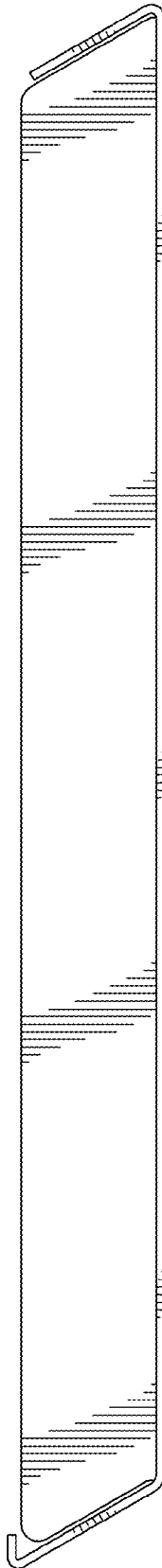

FIG. 4

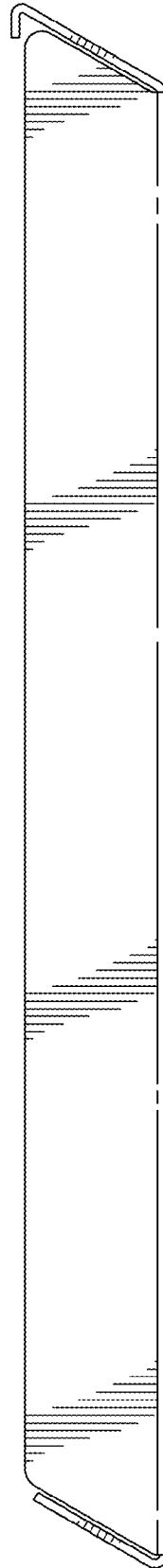

FIG. 5

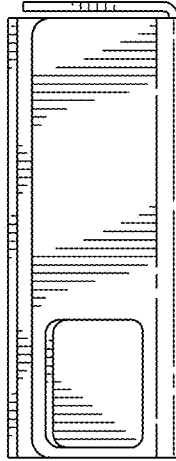

FIG. 7

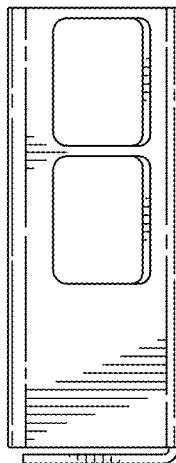

FIG. 6