



US00D715336S

(12) **United States Design Patent**
Sin et al.

(10) **Patent No.:** **US D715,336 S**

(45) **Date of Patent:** **** Oct. 14, 2014**

(54) **DISPENSER FOR REFRIGERATOR**

(71) Applicant: **Samsung Electronics Co., Ltd.**,
Suwon-Si (KR)

(72) Inventors: **Ri-Na Sin**, Seoul (KR); **Min Hyoug Boo**, Seoul (KR); **Eunha Choi**,
Yongin-si (KR); **Hyungyong Choi**,
Yongin-si (KR)

(73) Assignee: **Samsung Electronics Co., Ltd.**,
Gyeonggi-do (KR)

(**) Term: **14 Years**

(21) Appl. No.: **29/454,390**

(22) Filed: **May 9, 2013**

(30) **Foreign Application Priority Data**

Nov. 28, 2012 (KR) 30-2012-0057132

(51) **LOC (10) Cl.** **15-07**

(52) **U.S. Cl.**
USPC **D15/89**

(58) **Field of Classification Search**
USPC D15/79-89, 91; 312/236, 352, 116,
312/400-408; 62/3.1-3.64, 98, 236, 275,
62/293, 331, 344, 352, 371, 440, 467, 529,
62/531; D7/306

See application file for complete search history.

(56) **References Cited**

U.S. PATENT DOCUMENTS

D365,579 S * 12/1995 Baker et al. D15/89
5,474,213 A * 12/1995 Unger 222/108

D568,913 S * 5/2008 Suh et al. D15/89
D569,399 S * 5/2008 Crookshanks et al. D15/89
D582,443 S * 12/2008 Kim et al. D15/89
D589,988 S * 4/2009 Martin et al. D15/89
D697,537 S * 1/2014 Seo et al. D15/89
2010/0319389 A1 * 12/2010 Yang et al. 62/389

* cited by examiner

Primary Examiner — Thomas Johannes

Assistant Examiner — Khawaja Anwar

(74) *Attorney, Agent, or Firm* — Harness, Dickey & Pierce,
P.L.C.

(57) **CLAIM**

The ornamental design for a dispenser for refrigerator, as shown and described.

DESCRIPTION

FIG. 1 is the front/right-side/top perspective view of a dispenser for refrigerator showing our new design; FIG. 2 is the front-side elevational view thereof; FIG. 3 is the rear-side elevational view thereof; FIG. 4 is the left-side elevational view thereof; FIG. 5 is the right-side elevational view thereof; FIG. 6 is the top-side elevational view thereof; and FIG. 7 is the bottom-side elevational view thereof; and, FIG. 8 shows the dispenser for refrigerator is installed on an unclaimed environment.

The surface treatment of the dispenser for refrigerator shown in the figures forms no part of the claimed design, a dispenser for refrigerator according to the claimed design may have any surface treatment.

The broken lines in the drawing show unclaimed environment only and form no part of the claimed design.

1 Claim, 7 Drawing Sheets

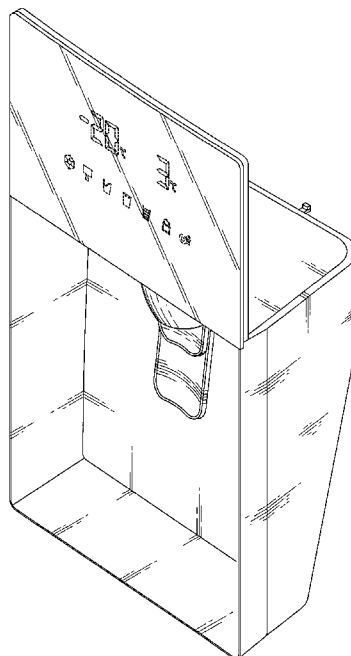

FIG. 1

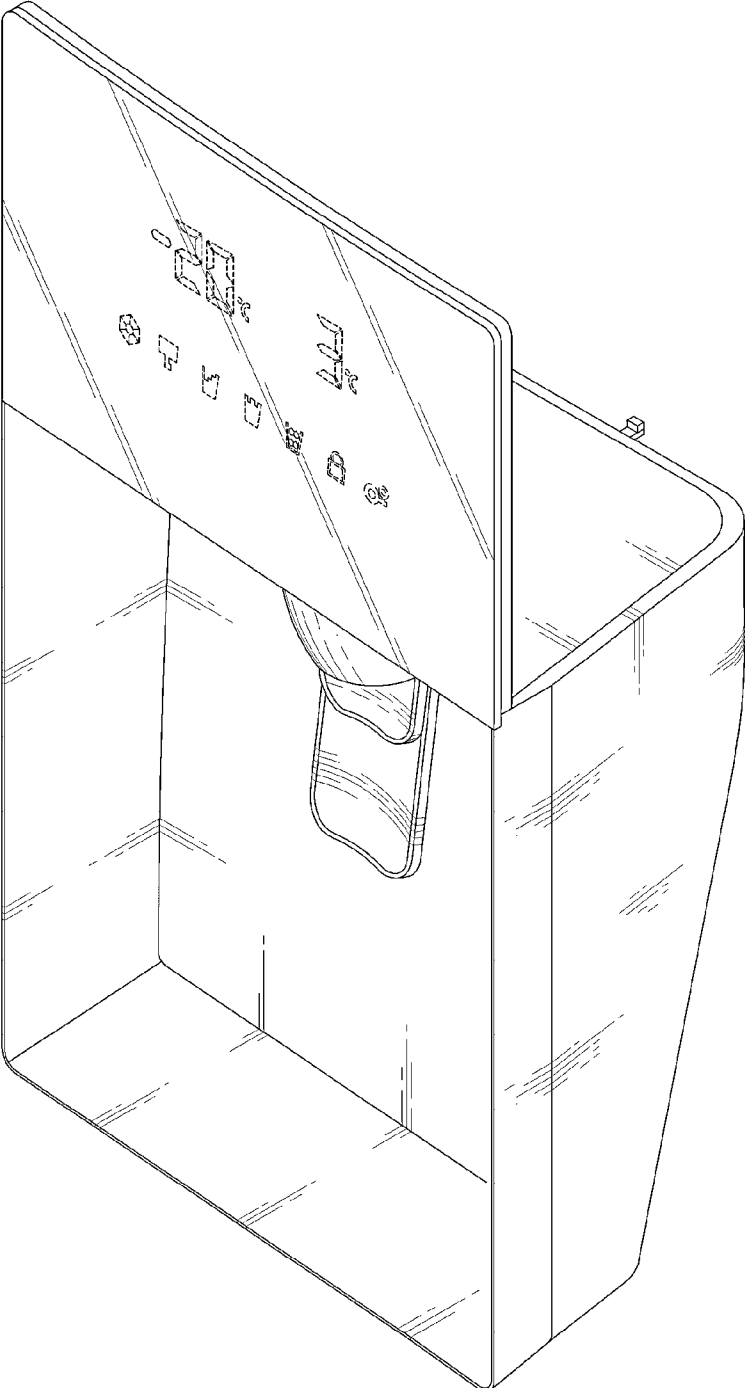

FIG. 2

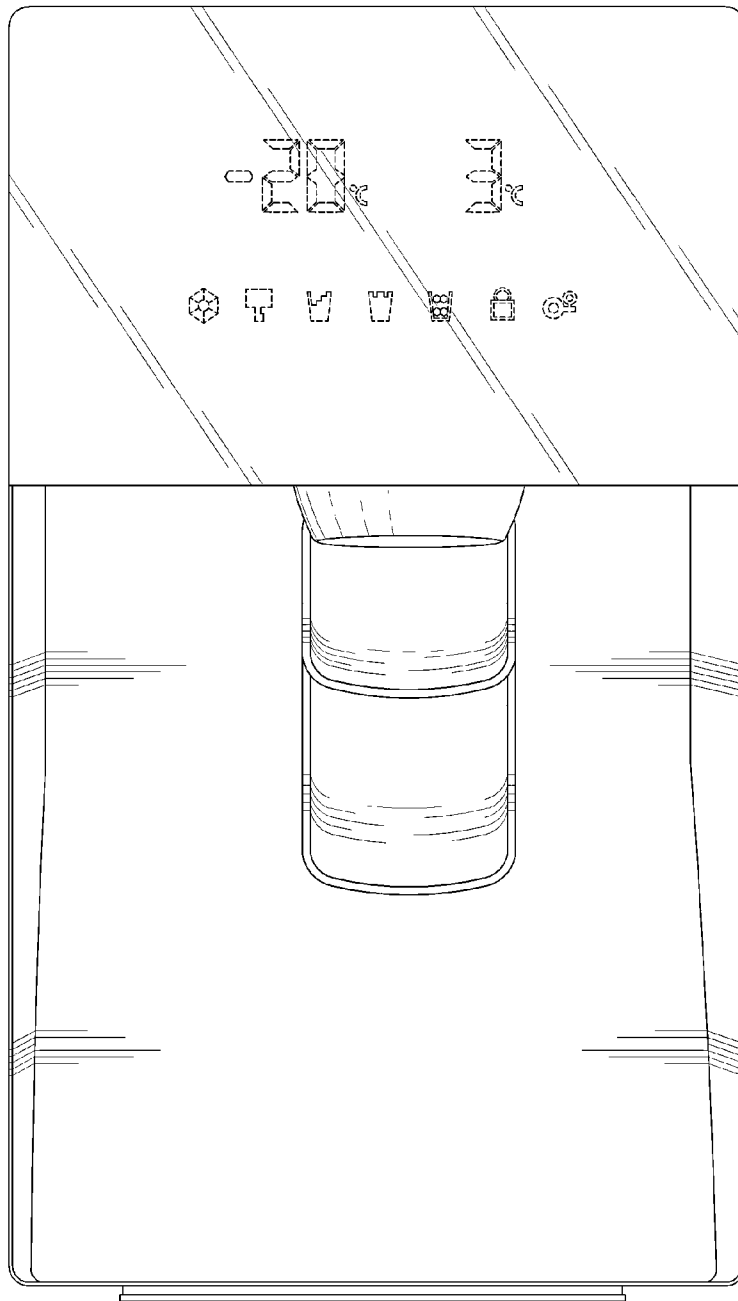

FIG. 3

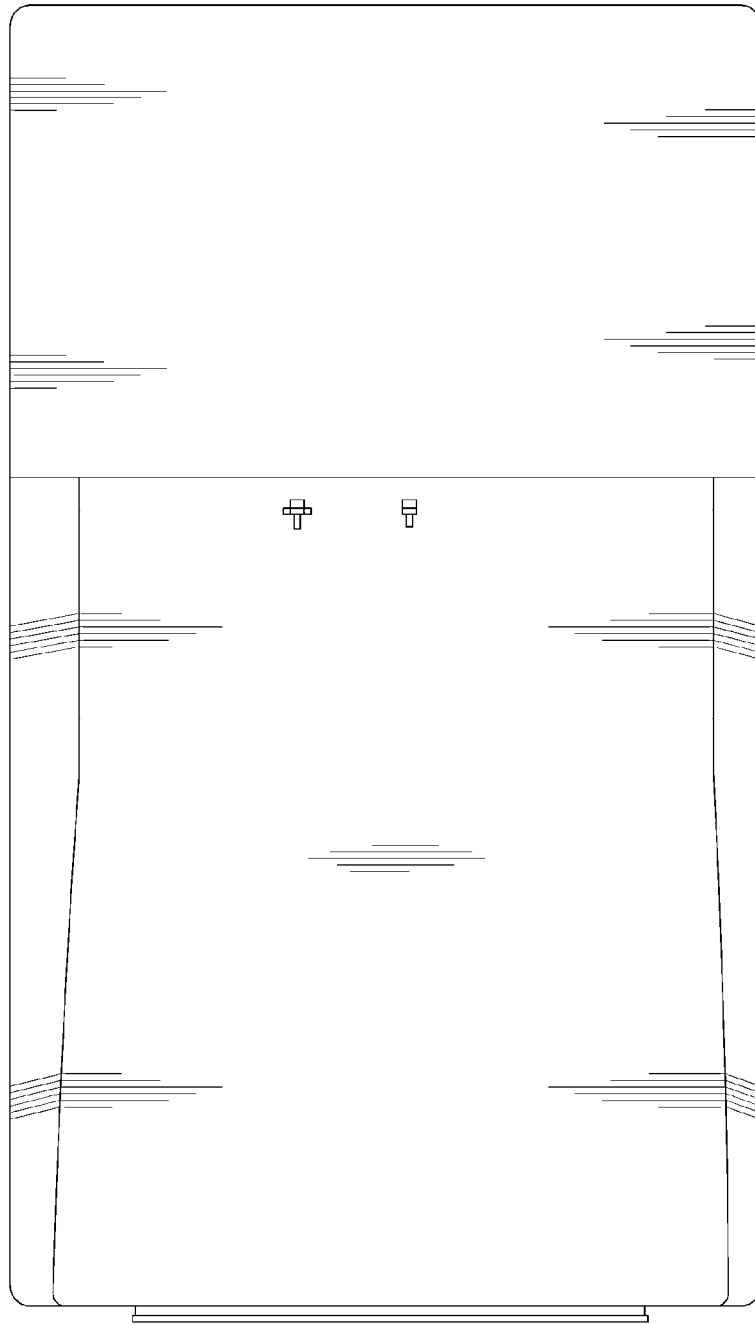

FIG. 4

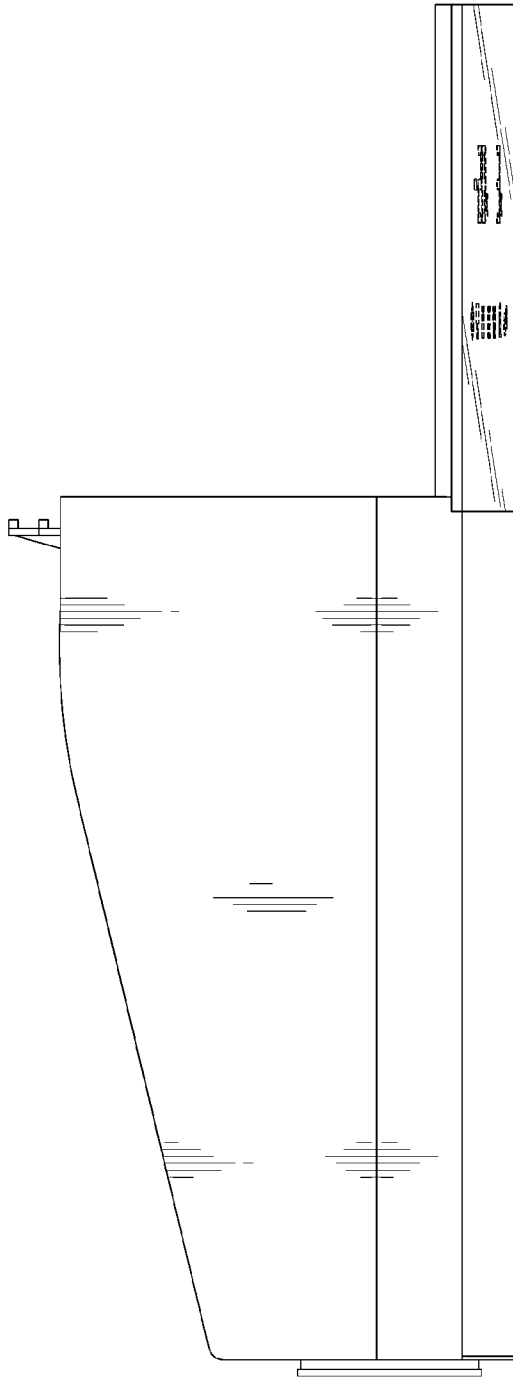

FIG. 5

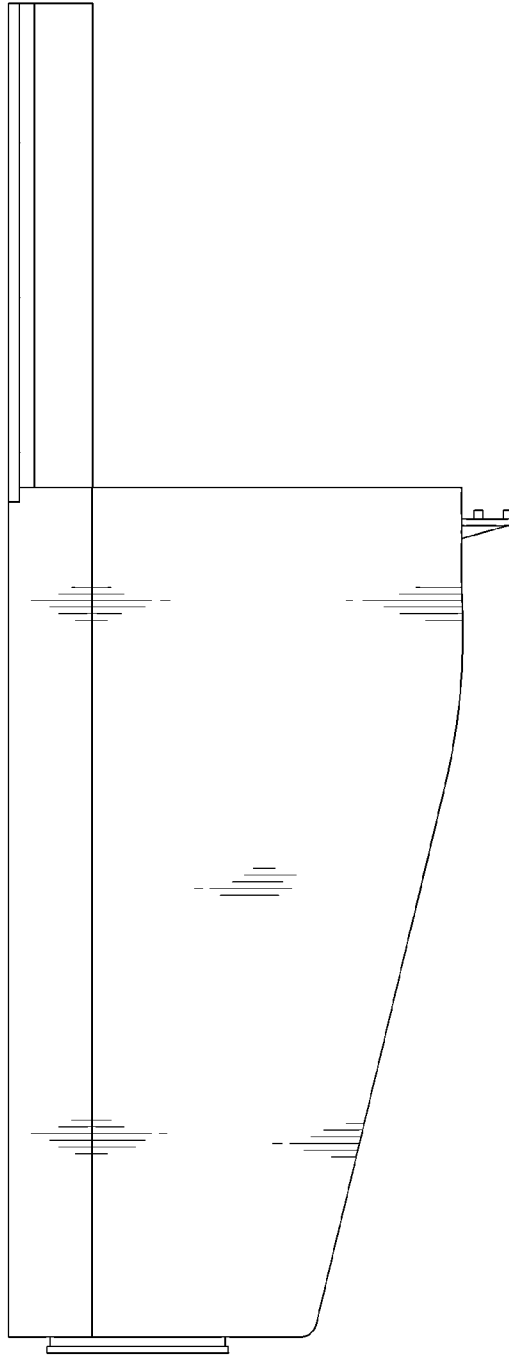

FIG. 6

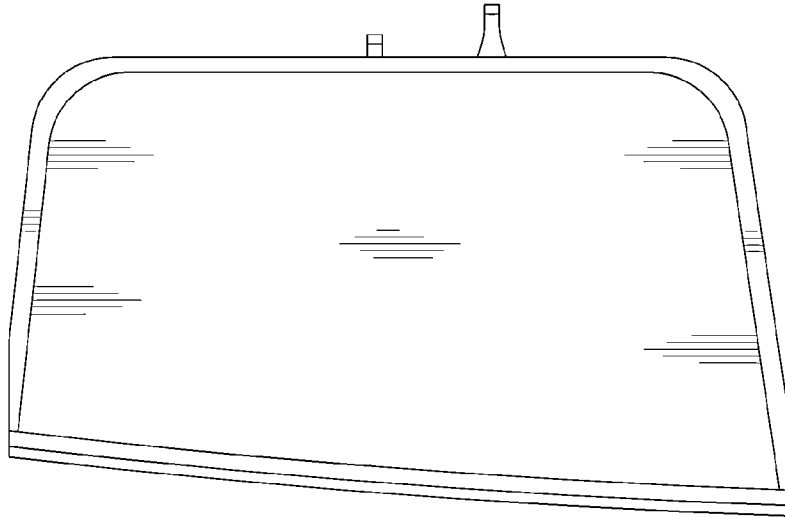

FIG. 7

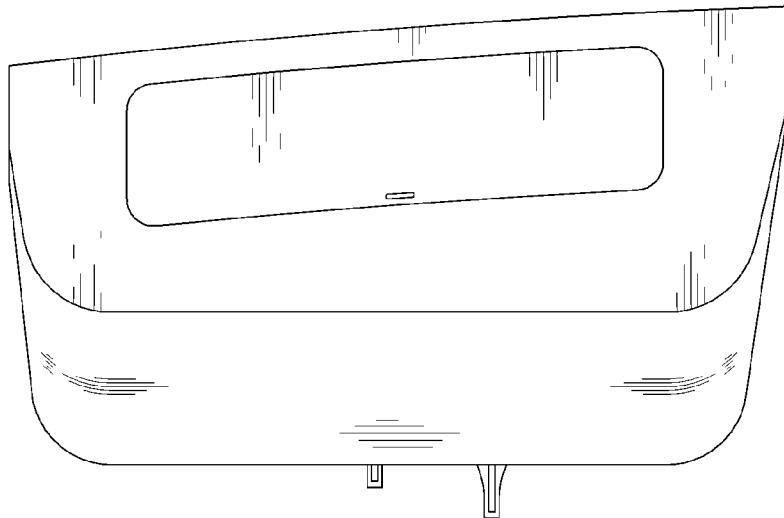

FIG.8

