



(12) **DEMANDE DE BREVET CANADIEN
CANADIAN PATENT APPLICATION**

(13) **A1**

(86) Date de dépôt PCT/PCT Filing Date: 2017/01/06
(87) Date publication PCT/PCT Publication Date: 2017/07/13
(85) Entrée phase nationale/National Entry: 2018/06/28
(86) N° demande PCT/PCT Application No.: US 2017/012513
(87) N° publication PCT/PCT Publication No.: 2017/120456
(30) Priorité/Priority: 2016/01/06 (US62/275,656)

(51) Cl.Int./Int.Cl. *C12Q 1/68* (2018.01)
(71) Demandeur/Applicant:
MYRIAD GENETICS, INC., US
(72) Inventeurs/Inventors:
GUTIN, ALEXANDER, US;
ADAMS, DOUGLAS, US;
FLAKE, DARL, US
(74) Agent: BERESKIN & PARR LLP/S.E.N.C.R.L.,S.R.L.

(54) Titre : GENES ET SIGNATURES GENETIQUES POUR LE DIAGNOSTIC ET LE TRAITEMENT DU MELANOME
(54) Title: GENES AND GENE SIGNATURES FOR DIAGNOSIS AND TREATMENT OF MELANOMA

(57) Abrégé/Abstract:

Panels of biomarkers, methods and systems are disclosed for determining gene expression, and diagnosing and treating melanoma.

(12) INTERNATIONAL APPLICATION PUBLISHED UNDER THE PATENT COOPERATION TREATY (PCT)

(19) World Intellectual Property
Organization
International Bureau(43) International Publication Date
13 July 2017 (13.07.2017)(10) International Publication Number
WO 2017/120456 A1(51) International Patent Classification:
C12Q 1/68 (2006.01)(21) International Application Number:
PCT/US2017/012513(22) International Filing Date:
6 January 2017 (06.01.2017)

(25) Filing Language: English

(26) Publication Language: English

(30) Priority Data:
62/275,656 6 January 2016 (06.01.2016) US(71) Applicant: **MYRIAD GENETICS, INC.** [US/US]; 320
Wakara Way, Salt Lake City, Utah 84108 (US).

(72) Inventors; and

(71) Applicants : **FLAKE, Darl** [US/US]; c/o Myriad Genet-
ics, Inc., 320 Wakara Way, Salt Lake City, Utah 84108
(US). **GUTIN, Alexander** [US/US]; c/o Myriad Genetics,
Inc., 320 Wakara Way, Salt Lake City, Utah 84108 (US).
ADAMS, Douglas [US/US]; c/o Myriad Genetics, Inc.,
320 Wakara Way, Salt Lake City, Utah 84108 (US).(74) Agent: **GORDON, Matthew**; c/o Myriad Genetics, Inc.,
320 Wakara Way, Salt Lake City, Utah 84108 (US).(81) Designated States (*unless otherwise indicated, for every
kind of national protection available*): AE, AG, AL, AM,AO, AT, AU, AZ, BA, BB, BG, BH, BN, BR, BW, BY,
BZ, CA, CH, CL, CN, CO, CR, CU, CZ, DE, DJ, DK, DM,
DO, DZ, EC, EE, EG, ES, FI, GB, GD, GE, GH, GM, GT,
HN, HR, HU, ID, IL, IN, IR, IS, JP, KE, KG, KH, KN,
KP, KR, KW, KZ, LA, LC, LK, LR, LS, LU, LY, MA,
MD, ME, MG, MK, MN, MW, MX, MY, MZ, NA, NG,
NI, NO, NZ, OM, PA, PE, PG, PH, PL, PT, QA, RO, RS,
RU, RW, SA, SC, SD, SE, SG, SK, SL, SM, ST, SV, SY,
TH, TJ, TM, TN, TR, TT, TZ, UA, UG, US, UZ, VC, VN,
ZA, ZM, ZW.(84) Designated States (*unless otherwise indicated, for every
kind of regional protection available*): ARIPO (BW, GH,
GM, KE, LR, LS, MW, MZ, NA, RW, SD, SL, ST, SZ,
TZ, UG, ZM, ZW), Eurasian (AM, AZ, BY, KG, KZ, RU,
TJ, TM), European (AL, AT, BE, BG, CH, CY, CZ, DE,
DK, EE, ES, FI, FR, GB, GR, HR, HU, IE, IS, IT, LT, LU,
LV, MC, MK, MT, NL, NO, PL, PT, RO, RS, SE, SI, SK,
SM, TR), OAPI (BF, BJ, CF, CG, CI, CM, GA, GN, GQ,
GW, KM, ML, MR, NE, SN, TD, TG).**Declarations under Rule 4.17:**— *as to applicant's entitlement to apply for and be granted a
patent (Rule 4.17(ii))***Published:**— *with international search report (Art. 21(3))*

(54) Title: GENES AND GENE SIGNATURES FOR DIAGNOSIS AND TREATMENT OF MELANOMA

(57) Abstract: Panels of biomarkers, methods and systems are disclosed for determining gene expression, and diagnosing and treat-
ing melanoma.

WO 2017/120456 A1

GENES AND GENE SIGNATURES FOR DIAGNOSIS AND TREATMENT OF MELANOMA

RELATED APPLICATIONS

[0001] This application claims priority benefit to U.S. provisional application number 62,275,656 filed January 06, 2016, the entire contents of which are hereby incorporated by reference.

FIELD OF THE INVENTION

[0002] The invention generally relates to a molecular classification of disease and particularly to genes and gene signatures for diagnosis of melanoma and methods of use thereof.

TABLES

[0003] The instant application was filed with four (4) Tables under 37 C.F.R. §§ 1.52(e)(1)(iii) & 1.58(b), submitted electronically as the following text files:

[0004] Table WW:

[0005] File name: "3330-01-1P-2013-03-15-TABLEWW-MSG.txt"

[0006] Creation date: March 15, 2013

[0007] Size: 41,993 bytes

[0008] Table XX:

[0009] File name: "3330-01-1P-2013-03-15-TABLEXX-MSG.txt"

[0010] Creation date: March 15, 2013

[0011] Size: 25,873 bytes

[0012] Table YY:

[0013] File name: "3330-01-1P-2013-03-15-TABLEYY-MSG.txt"

[0014] Creation date: March 15, 2013

[0015] Size: 271,729 bytes

[0016] Table ZZ:

[0017] File name: "3330-01-1P-2013-03-15-TABLEZZ-MSG.txt"

[0018] Creation date: March 15, 2013

[0019] Size: 1,943,509 bytes

[0020] Each of the above files and all their contents are incorporated by reference herein in their entirety.

BACKGROUND OF THE INVENTION

[0021] In the United States, over 76,000 new cases of melanoma will be diagnosed in 2013. American Cancer Society, FACTS AND FIGURES 2013. Treatment of melanoma at an earlier stage is associated with higher survival rates in patients. There is therefore a great need for advances in methods of early diagnosis and treatment of melanoma.

BRIEF SUMMARY OF THE INVENTION

[0022] Panels of biomarkers, methods and systems are disclosed for determining gene expression, and diagnosing and treating melanoma.

[0023] In a first aspect the disclosure is related to methods of diagnosing melanoma in a patient. In general, said methods comprise measuring in a sample obtained from the patient the expression of one or more genes, or a panel of genes. The genes may be cell cycle genes, immune genes or additional genes as defined herein. The genes may be selected from Table 1, Table 3, or one of the many specifically defined panels (Panels A-I, or panels in Tables WW-ZZ). The method may also comprise comparing the measured expression levels of the one or more genes to the expression levels of the same one or more genes measured in a reference sample. Detecting a difference in the expression levels of the one or more genes indicates that the patient has melanoma. The method may also comprise determining the presence or absence of LOH or AI at predetermined genomic locations.

[0024] In a second aspect, the disclosure is related to methods of detecting abnormal levels of gene expression in a skin lesion. In general, the methods comprise measuring in a skin lesion obtained from a patient the expression of one or more genes, or a panel of genes. The genes may be cell cycle genes, immune genes or additional genes as defined herein. The genes may be selected from Table 1, Table 3, or one of the many specifically defined panels (Panels A-I, or panels in Tables WW-ZZ). The method may also comprise comparing the measured expression levels of the one or

more genes to the expression levels of the same one or more genes measured in a reference sample. The method may also comprise detecting an abnormal level of gene expression of at least one of the one or more genes. The method may also comprise determining the presence or absence of LOH or AI at predetermined genomic locations.

[0025] In a third aspect, the disclosure is related to treating a patient with melanoma. In general, the methods comprise measuring in a skin lesion obtained from a patient the expression of one or more genes, or a panel of genes. The genes may be cell cycle genes, immune genes or additional genes as defined herein. The genes may be selected from Table 1, Table 3, or one of the many specifically defined panels (Panels A-I, or panels in Tables WW-ZZ). The method may also comprise comparing the measured expression levels of the one or more genes to the expression levels of the same one or more genes measured in a reference sample. The method may also comprise detecting an abnormal level of gene expression of at least one of the one or more genes, and altering the patient's treatment based at least in part on the difference. The method may also comprise determining the presence or absence of LOH or AI at predetermined genomic locations.

[0026] Also disclosed are systems, compositions and kits to aid in detecting abnormal levels of gene expression, diagnosing melanoma or treating melanoma.

[0027] Unless otherwise defined, all technical and scientific terms used herein have the same meaning as commonly understood by one of ordinary skill in the art to which this invention pertains. Although methods and materials similar or equivalent to those described herein can be used in the practice or testing of the present invention, suitable methods and materials are described below. In case of conflict, the present specification, including definitions, will control. In addition, the materials, methods, and examples are illustrative only and not intended to be limiting.

[0028] Other features and advantages of the invention will be apparent from the following detailed description, and from the claims.

BRIEF DESCRIPTION OF THE DRAWINGS

[0029] Figure 1 shows a system for performing computer-assisted methods of diagnosing, detecting, screening and/or treating melanoma in a patient.

[0030] Figure 2 shows the distribution of the CCP scores from all 30 samples with a score and separated by clinical diagnosis. The melanoma samples have statistically different distributions when compared to the nevi samples.

[0031] Figure 3A shows the distributions of the first 48 of 88 individual amplicon assays tested in Rounds 1, 2, and 3 of biomarker discovery. The analysis was performed on 30 Group 1 samples (black circles) and 53 Group 2 samples (grey circles).

[0032] Figure 3B shows the distributions of the last 40 of 88 individual amplicon assays tested in Rounds 1, 2, and 3 of biomarker discovery. The analysis was performed on 30 Group 1 samples (black circles) and 53 Group 2 samples (grey circles).

[0033] Figure 4A shows distributions of the first 30 of 58 individual amplicon assays tested in Round 1 and 2 of biomarker discovery. Samples are differentiated based on their pathological subtype on the Y-axis. The relative expression (Ct) of each gene (compared to the expression of the housekeeper genes) is graphed on the X-axis. Each amplicon is identified by the gene name and the last three digits of the assay ID.

[0034] Figure 4B shows distributions of the last 28 of 58 individual amplicon assays tested in Round 1 and 2 of biomarker discovery. Samples are differentiated based on their pathological subtype on the Y-axis. The relative expression (Ct) of each gene (compared to the expression of the housekeeper genes) is graphed on the X-axis. Each amplicon is identified by the gene name and the last three digits of the assay ID.

[0035] Figure 5 shows the normalized expression of PRAME in each sample, as differentiated by both site and histological subtype. Malignant samples are black, while benign samples are colored grey.

[0036] Figure 6 shows the expression of each of the best 8 immune genes. Each of the genes had a linear relationship with the average expression of all 8 of the immune genes (indicating that they all measure the same biological process). Furthermore, all immune genes can differentiate melanoma and nevi samples (black and grey colored, respectively).

[0037] Figure 7 shows graphs of the expression of each marker (of PRAME, the average of the 8 immune genes, and S100A9) graphed against the other markers. Data

from each site graphed separately. The lack of high correlation between each biomarker indicates that they each are likely measuring different biological processes and each has independent value.

[0038] Figure 8 shows the score generated by the diagnostic model, using the expression of PRAME, the immune genes, and S100A9. This score was used to differentiate malignant melanoma and benign nevi.

[0039] Figure 9 shows an AUROC curve generated from the dataset, using the score produced from the model. The AUC of the ROC curve is ~0.96.

[0040] Figure 10 shows the distribution of scores (x-axis) from all tested samples. The data are differentiated by primary diagnosis. The top panel shows scores for malignant samples. The bottom panel shows scores of benign samples.

[0041] Figure 11 shows an AUROC curve generated from the dataset based on the ability of the model to differentiate melanoma and nevi samples. The AUC of the ROC is ~ 0.95. Sensitivity and specificity are shown.

[0042] Figure 12 shows the distribution of scores (x-axis) from all tested samples for the validation cohort. The data are differentiated by primary diagnosis. The top panel shows scores for malignant samples. The bottom panel shows scores of benign samples.

[0043] Figure 13 shows an AUROC curve generated based on the validation cohort. The AUC of the ROC is ~ 0.96. Sensitivity and specificity are shown.

[0044] Figure 14 shows the distribution of scores (x-axis) from all tested samples for the validation cohort when implementing the Indeterminate Zone. The data are differentiated by primary diagnosis. The top panel shows scores for malignant samples. The bottom panel shows scores of benign samples.

[0045] Figure 15 shows the percent of melanoma samples in the TCGA cohort with allelic imbalance for each chromosomal position faceted by chromosome. The Y axis designates the proportion of samples tested which had either LOH (black) or AI (blue). The X axis designates the chromosomal position for the chromosome indicated at the top of each graph.

DETAILED DESCRIPTION OF THE INVENTION

Genes and Panels

[0046] Disclosed herein are gene biomarkers and panels of biomarkers, methods and systems for determining gene expression, and methods for diagnosing and treating melanoma. It should be understood that the methods and systems disclosed are all intended to be utilized in conjunction with biomarkers as described herein. In particular, any panel disclosed may be used with any method or system of this disclosure. Furthermore, subpanels of any panel disclosed may furthermore be used, as described below.

[0047] The gene biomarkers and panels of biomarkers are useful, at least in part, for their predictive power in determining whether an individual has melanoma. It has been discovered that the predictive power of a panel or group of genes often ceases to increase significantly beyond a certain number. More specifically, the optimal number of genes in a panel, or used to generate a test value can be found wherever the following is true

$$(P_{n+1} - P_n) < CO,$$

wherein P is the predictive power (i.e., P_n is the predictive power of a signature with n genes and P_{n+1} is the predictive power of a signature with n genes plus one) and CO is some optimization constant. Predictive power can be defined in many ways known to those skilled in the art including, but not limited to, the signature's p-value. CO can be chosen by the artisan based on his or her specific constraints. For example, if cost is not a critical factor and extremely high levels of sensitivity and specificity are desired, CO can be set very low such that only trivial increases in predictive power are disregarded. On the other hand, if cost is decisive and moderate levels of sensitivity and specificity are acceptable, CO can be set higher such that only significant increases in predictive power warrant increasing the number of genes in the signature.

[0048] Additionally, a skilled person would recognize that individual panels may be combined to generate additional panels according to this disclosure, and that combining two panels with acceptable predictive power will result in a combined panel with acceptable predictive power. Additionally, a skilled person would recognize that while individual genes are described herein as belonging to certain groups (i.e. Cell Cycle Genes, immune genes, etc.), all panels and genes disclosed herein are unified by

their common ability to aid in determining gene expression, and treating and diagnosing melanoma.

CCP Genes

[0049] The present invention is based in part on the discovery that the expression levels of CCP genes in a sample from a patient suspected of having melanoma predict whether the patient will be diagnosed with melanoma, and further that other genes, add significant prediction power when combined with CCP genes (“CCGs”).

[0050] “Cell-cycle gene” and “CCG” herein refer to a gene whose expression level closely tracks the progression of the cell through the cell-cycle. See, e.g., Whitfield et al., *Mol. Biol. Cell* (2002) 13:1977-2000. The term “cell-cycle progression” or “CCP” will also be used in this application and will generally be interchangeable with CCG (i.e., a CCP gene is a CCG; a CCP score is a CCG score). More specifically, CCGs show periodic increases and decreases in expression that coincide with certain phases of the cell cycle—e.g., STK15 and PLK show peak expression at G2/M. *Id.* Often CCGs have clear, recognized cell-cycle related function—e.g., in DNA synthesis or repair, in chromosome condensation, in cell-division, etc. However, some CCGs have expression levels that track the cell-cycle without having an obvious, direct role in the cell-cycle—e.g., UBE2S encodes a ubiquitin-conjugating enzyme, yet its expression closely tracks the cell-cycle. Thus a CCG according to the present invention need not have a recognized role in the cell-cycle. Exemplary CCGs are listed in Tables 1, 2, 3, 5, 6, 7, 8 & 9. A fuller discussion of CCGs, including an extensive (though not exhaustive) list of CCGs, can be found in International Application No. PCT /US2010/020397 (pub. no. WO/2010/080933) (see, e.g., Table 1 in WO/2010/080933). International Application No. PCT/US2010/020397 (pub. no. WO/2010/080933 (see also corresponding U.S. Application No. 13/177,887)) and International Application No. PCT/ US2011/043228 (pub no. WO/2012/006447 (see also related U.S. Application No. 13/178,380)) and their contents are hereby incorporated by reference in their entirety.

[0051] Whether a particular gene is a CCG may be determined by any technique known in the art, including those taught in Whitfield et al., *Mol. Biol. Cell* (2002)

13:1977-2000; Whitfield et al., Mol. Cell. Biol. (2000) 20:4188-4198; WO/2010/080933 (¶ [0039]). All of the CCGs in Table 1 below form a panel of CCGs (“Panel A”). As will be shown detail throughout this document, individual CCGs (e.g., CCGs in Table 1) and subsets of these genes can also be used.

Table 1

Gene Symbol	Entrez GeneID	ABI Assay ID	RefSeq Accession Nos.
<i>APOBEC3B</i> *	9582	Hs00358981_m1	NM_004900.3
<i>ASF1B</i> *	55723	Hs00216780_m1	NM_018154.2
<i>ASPM</i> *	259266	Hs00411505_m1	NM_018136.4
<i>ATAD2</i> *	29028	Hs00204205_m1	NM_014109.3
<i>BIRC5</i> *	332	Hs00153353_m1; Hs03043576_m1	NM_001012271.1; NM_001012270.1; NM_001168.2
<i>BLM</i> *	641	Hs00172060_m1	NM_000057.2
<i>BUB1</i>	699	Hs00177821_m1	NM_004336.3
<i>BUB1B</i> *	701	Hs01084828_m1	NM_001211.5
<i>C12orf48</i> *	55010	Hs00215575_m1	NM_017915.2
<i>C18orf24/ SKA1</i> *#	220134	Hs00536843_m1	NM_145060.3; NM_001039535.2
<i>C1orf135</i> *	79000	Hs00225211_m1	NM_024037.1
<i>C21orf45</i> *	54069	Hs00219050_m1	NM_018944.2
<i>CCDC99</i> *	54908	Hs00215019_m1	NM_017785.4
<i>CCNA2</i> *	890	Hs00153138_m1	NM_001237.3
<i>CCNB1</i> *	891	Hs00259126_m1	NM_031966.2
<i>CCNB2</i> *	9133	Hs00270424_m1	NM_004701.2
<i>CCNE1</i> *	898	Hs01026536_m1	NM_001238.1; NM_057182.1
<i>CDC2</i> *	983	Hs00364293_m1	NM_033379.3; NM_001130829.1; NM_001786.3
<i>CDC20</i> *	991	Hs03004916_g1	NM_001255.2
<i>CDC45L</i> *	8318	Hs00185895_m1	NM_003504.3
<i>CDC6</i> *	990	Hs00154374_m1	NM_001254.3
<i>CDCA3</i> *	83461	Hs00229905_m1	NM_031299.4
<i>CDCA8</i> *	55143	Hs00983655_m1	NM_018101.2

<i>CDKN3*</i>	1033	Hs00193192_m1	NM_001130851.1; NM_005192.3
<i>CDT1*</i>	81620	Hs00368864_m1	NM_030928.3
<i>CENPA</i>	1058	Hs00156455_m1	NM_001042426.1; NM_001809.3
<i>CENPE*</i>	1062	Hs00156507_m1	NM_001813.2
<i>CENPF*#</i>	1063	Hs00193201_m1	NM_016343.3
<i>CENPI*</i>	2491	Hs00198791_m1	NM_006733.2
<i>CENPM*</i>	79019	Hs00608780_m1	NM_024053.3
<i>CENPN*</i>	55839	Hs00218401_m1	NM_018455.4; NM_001100624.1; NM_001100625.1
<i>CEP55*#</i>	55165	Hs00216688_m1	NM_018131.4; NM_001127182.1
<i>CHEK1*</i>	1111	Hs00967506_m1	NM_001114121.1; NM_001114122.1; NM_001274.4
<i>CKAP2*</i>	26586	Hs00217068_m1	NM_018204.3; NM_001098525.1
<i>CKS1B*</i>	1163	Hs01029137_g1	NM_001826.2
<i>CKS2*</i>	1164	Hs01048812_g1	NM_001827.1
<i>CTPS*</i>	1503	Hs01041851_m1	NM_001905.2
<i>CTSL2*</i>	1515	Hs00952036_m1	NM_001333.2
<i>DBF4*</i>	10926	Hs00272696_m1	NM_006716.3
<i>DDX39*</i>	10212	Hs00271794_m1	NM_005804.2
<i>DLGAP5/DLG7*#</i>	9787	Hs00207323_m1	NM_014750.3
<i>DONSON*</i>	29980	Hs00375083_m1	NM_017613.2
<i>DSN1*</i>	79980	Hs00227760_m1	NM_024918.2
<i>DTL*#</i>	51514	Hs00978565_m1	NM_016448.2
<i>E2F8*</i>	79733	Hs00226635_m1	NM_024680.2
<i>ECT2*</i>	1894	Hs00216455_m1	NM_018098.4
<i>ESPL1*</i>	9700	Hs00202246_m1	NM_012291.4
<i>EXO1*</i>	9156	Hs00243513_m1	NM_130398.2; NM_003686.3; NM_006027.3

<i>EZH2*</i>	2146	Hs00544830_m1	NM_152998.1; NM_004456.3
<i>FANCI*</i>	55215	Hs00289551_m1	NM_018193.2; NM_001113378.1
<i>FBXO5*</i>	26271	Hs03070834_m1	NM_001142522.1; NM_012177.3
<i>FOXMI*#</i>	2305	Hs01073586_m1	NM_202003.1; NM_202002.1; NM_021953.2
<i>GINS1*</i>	9837	Hs00221421_m1	NM_021067.3
<i>GMPS*</i>	8833	Hs00269500_m1	NM_003875.2
<i>GPSM2*</i>	29899	Hs00203271_m1	NM_013296.4
<i>GTSE1*</i>	51512	Hs00212681_m1	NM_016426.5
<i>H2AFX*</i>	3014	Hs00266783_s1	NM_002105.2
<i>HMMR*</i>	3161	Hs00234864_m1	NM_001142556.1; NM_001142557.1; NM_012484.2; NM_012485.2
<i>HN1*</i>	51155	Hs00602957_m1	NM_001002033.1; NM_001002032.1; NM_016185.2
<i>KIAA0101*</i>	9768	Hs00207134_m1	NM_014736.4
<i>KIF11*</i>	3832	Hs00189698_m1	NM_004523.3
<i>KIF15*</i>	56992	Hs00173349_m1	NM_020242.2
<i>KIF18A*</i>	81930	Hs01015428_m1	NM_031217.3
<i>KIF20A*</i>	10112	Hs00993573_m1	NM_005733.2
<i>KIF20B/ MPHOSPH1*</i>	9585	Hs01027505_m1	NM_016195.2
<i>KIF23*</i>	9493	Hs00370852_m1	NM_138555.1; NM_004856.4
<i>KIF2C*</i>	11004	Hs00199232_m1	NM_006845.3
<i>KIF4A*</i>	24137	Hs01020169_m1	NM_012310.3
<i>KIFC1*</i>	3833	Hs00954801_m1	NM_002263.3
<i>KPNA2</i>	3838	Hs00818252_g1	NM_002266.2

<i>LMNB2*</i>	84823	Hs00383326_m1	NM_032737.2
<i>MAD2L1</i>	4085	Hs01554513_g1	NM_002358.3
<i>MCAM*</i>	4162	Hs00174838_m1	NM_006500.2
<i>MCM10*#</i>	55388	Hs00960349_m1	NM_018518.3; NM_182751.1
<i>MCM2*</i>	4171	Hs00170472_m1	NM_004526.2
<i>MCM4*</i>	4173	Hs00381539_m1	NM_005914.2; NM_182746.1
<i>MCM6*</i>	4175	Hs00195504_m1	NM_005915.4
<i>MCM7*</i>	4176	Hs01097212_m1	NM_005916.3; NM_182776.1
<i>MELK</i>	9833	Hs00207681_m1	NM_014791.2
<i>MKI67*</i>	4288	Hs00606991_m1	NM_002417.3
<i>MYBL2*</i>	4605	Hs00231158_m1	NM_002466.2
<i>NCAPD2*</i>	9918	Hs00274505_m1	NM_014865.3
<i>NCAPG*</i>	64151	Hs00254617_m1	NM_022346.3
<i>NCAPG2*</i>	54892	Hs00375141_m1	NM_017760.5
<i>NCAPH*</i>	23397	Hs01010752_m1	NM_015341.3
<i>NDC80*</i>	10403	Hs00196101_m1	NM_006101.2
<i>NEK2*</i>	4751	Hs00601227_mH	NM_002497.2
<i>NUSAP1*</i>	51203	Hs01006195_m1	NM_018454.6; NM_001129897.1; NM_016359.3
<i>OIP5*</i>	11339	Hs00299079_m1	NM_007280.1
<i>ORC6L*</i>	23594	Hs00204876_m1	NM_014321.2
<i>PAICS*</i>	10606	Hs00272390_m1	NM_001079524.1; NM_001079525.1; NM_006452.3
<i>PBK*#</i>	55872	Hs00218544_m1	NM_018492.2
<i>PCNA*</i>	5111	Hs00427214_g1	NM_182649.1; NM_002592.2
<i>PDSS1*</i>	23590	Hs00372008_m1	NM_014317.3
<i>PLK1*#</i>	5347	Hs00153444_m1	NM_005030.3
<i>PLK4*</i>	10733	Hs00179514_m1	NM_014264.3

<i>POLE2*</i>	5427	Hs00160277_m1	NM_002692.2
<i>PRC1*</i>	9055	Hs00187740_m1	NM_199413.1; NM_199414.1; NM_003981.2
<i>PSMA7*</i>	5688	Hs00895424_m1	NM_002792.2
<i>PSRC1*</i>	84722	Hs00364137_m1	NM_032636.6; NM_001005290.2; NM_001032290.1; NM_001032291.1
<i>PTTG1*</i>	9232	Hs00851754_u1	NM_004219.2
<i>RACGAP1*</i>	29127	Hs00374747_m1	NM_013277.3
<i>RAD51*</i>	5888	Hs00153418_m1	NM_133487.2; NM_002875.3
<i>RAD51AP1*</i>	10635	Hs01548891_m1	NM_001130862.1; NM_006479.4
<i>RAD54B*</i>	25788	Hs00610716_m1	NM_012415.2
<i>RAD54L*</i>	8438	Hs00269177_m1	NM_001142548.1; NM_003579.3
<i>RFC2*</i>	5982	Hs00945948_m1	NM_181471.1; NM_002914.3
<i>RFC4*</i>	5984	Hs00427469_m1	NM_181573.2; NM_002916.3
<i>RFC5*</i>	5985	Hs00738859_m1	NM_181578.2; NM_001130112.1; NM_001130113.1; NM_007370.4
<i>RNASEH2A*</i>	10535	Hs00197370_m1	NM_006397.2
<i>RRM2*#</i>	6241	Hs00357247_g1	NM_001034.2
<i>SHCBP1*</i>	79801	Hs00226915_m1	NM_024745.4
<i>SMC2*</i>	10592	Hs00197593_m1	NM_001042550.1; NM_001042551.1; NM_006444.2

<i>SPAG5*</i>	10615	Hs00197708_m1	NM_006461.3
<i>SPC25*</i>	57405	Hs00221100_m1	NM_020675.3
<i>STIL*</i>	6491	Hs00161700_m1	NM_001048166.1; NM_003035.2
<i>STMN1*</i>	3925	Hs00606370_m1; Hs01033129_m1	NM_005563.3; NM_203399.1
<i>TACC3*</i>	10460	Hs00170751_m1	NM_006342.1
<i>TIMELESS*</i>	8914	Hs01086966_m1	NM_003920.2
<i>TK1*</i>	7083	Hs01062125_m1	NM_003258.4
<i>TOP2A*</i>	7153	Hs00172214_m1	NM_001067.2
<i>TPX2*</i>	22974	Hs00201616_m1	NM_012112.4
<i>TRIP13*</i>	9319	Hs01020073_m1	NM_004237.2
<i>TTK*</i>	7272	Hs00177412_m1	NM_003318.3
<i>TUBA1C*</i>	84790	Hs00733770_m1	NM_032704.3
<i>TYMS*</i>	7298	Hs00426591_m1	NM_001071.2
<i>UBE2C</i>	11065	Hs00964100_g1	NM_181799.1; NM_181800.1; NM_181801.1; NM_181802.1; NM_181803.1; NM_007019.2
<i>UBE2S</i>	27338	Hs00819350_m1	NM_014501.2
<i>VRK1*</i>	7443	Hs00177470_m1	NM_003384.2
<i>ZWILCH*</i>	55055	Hs01555249_m1	NM_017975.3; NR_003105.1
<i>ZWINT*</i>	11130	Hs00199952_m1	NM_032997.2; NM_001005413.1; NM_007057.3

* 124-gene subset of CCGs ("Panel B"). #10-gene subset of CCGs (Panel C). ABI Assay ID means the catalogue ID number for the gene expression assay commercially available from Applied Biosystems Inc. (Foster City, CA) for the particular gene.

[0052] Accordingly, in a first aspect of the present disclosure, panels of genes comprising CCGs for use in determining gene expression, and for diagnosing and treating melanoma are disclosed. In some embodiments, use of panels comprising CCGs comprises determining expression of the CCGs in a sample from an individual or patient.

[0053] Gene expression can be determined either at the RNA level (i.e., mRNA or noncoding RNA (ncRNA)) (e.g., miRNA, tRNA, rRNA, snoRNA, siRNA and piRNA) or at the protein level. Measuring gene expression at the mRNA level includes measuring levels of cDNA corresponding to mRNA. Levels of proteins in a sample can be determined by any known techniques in the art, e.g., HPLC, mass spectrometry, or using antibodies specific to selected proteins (e.g., IHC, ELISA, etc.).

[0054] In one embodiment, the amount of RNA transcribed from the panel of genes including test genes is measured in the sample. In addition, the amount of RNA of one or more housekeeping genes in the sample is also measured, and used to normalize or calibrate the expression of the test genes. The terms “normalizing genes” and “housekeeping genes” are defined herein below.

[0055] In any embodiment of the invention involving a “plurality of test genes,” the plurality of test genes may include at least 2, 3 or 4 cell-cycle genes, which constitute at least 50%, 75% or 80% of the plurality of test genes, and in some embodiments 100% of the plurality of test genes. In some embodiments, the plurality of test genes includes at least 5, 6, 7, or at least 8 cell-cycle genes, which constitute at least 20%, 25%, 30%, 40%, 50%, 60%, 70%, 75%, 80% or 90% of the plurality of test genes, and in some embodiments 100% of the plurality of test genes. As will be clear from the context of this document, a panel of genes is a plurality of genes. Typically these genes are assayed together in one or more samples from a patient.

[0056] In some other embodiments, the plurality of test genes includes at least 8, 10, 12, 15, 20, 25 or 30 cell-cycle genes, which constitute at least 20%, 25%, 30%, 40%, 50%, 60%, 70%, 75%, 80% or 90% of the plurality of test genes, and preferably 100% of the plurality of test genes.

[0057] As will be apparent to a skilled artisan apprised of the present invention and the disclosure herein, “sample” means any biological sample containing one or more suspected melanoma cells, or one or more RNA or protein derived from suspected melanoma cells, and

obtained from a patient. For example, a tissue sample obtained from a mole or nevus is a useful sample in the present invention. The tissue sample can be an FFPE sample, or fresh frozen sample, and preferably contain largely the suspect cells. A single cell from a patient's suspected melanoma is also a useful sample. Such a cell can be obtained directly from the patient's skin, or purified from the patient's bodily fluid (e.g., blood, urine). Thus, a bodily fluid such as blood, urine, sputum and saliva containing one or more suspected to be cancerous cells, or mole or nevus-derived RNA or proteins, can also be useful as a sample for purposes of practicing the present invention.

[0058] Those skilled in the art are familiar with various techniques for determining the status of a gene or protein in a tissue or cell sample including, but not limited to, microarray analysis (e.g., for assaying mRNA or microRNA expression, copy number, etc.), quantitative real-time PCRTM (“qRT-PCRTM”, e.g., TaqManTM), immunoanalysis (e.g., ELISA, immunohistochemistry), etc. The activity level of a polypeptide encoded by a gene may be used in much the same way as the expression level of the gene or polypeptide. Often higher activity levels indicate higher expression levels and while lower activity levels indicate lower expression levels. Thus, in some embodiments, the invention provides any of the methods discussed above, wherein the activity level of a polypeptide encoded by the CCG is determined rather than or in addition to the expression level of the CCG. Those skilled in the art are familiar with techniques for measuring the activity of various such proteins, including those encoded by the genes listed in Table 1. The methods of the invention may be practiced independent of the particular technique used.

[0059] In some embodiments, the expression of one or more normalizing (often called “housekeeping” or “housekeeper”) genes is also obtained for use in normalizing the expression of test genes. As used herein, “normalizing genes” referred to the genes whose expression is used to calibrate or normalize the measured expression of the gene of interest (e.g., test genes). Importantly, the expression of normalizing genes should be independent of cancer diagnosis, and the expression of the normalizing genes is very similar among all the samples. The normalization ensures accurate comparison of expression of a test gene between different samples. For this purpose, housekeeping genes known in the art can be used. Housekeeping genes are well known in the art, with examples including, but are not limited to, GUSB (glucuronidase, beta), HMBS (hydroxymethylbilane synthase), SDHA (succinate dehydrogenase

complex, subunit A, flavoprotein), UBC (ubiquitin C), YWHAZ (tyrosine 3-monooxygenase/tryptophan 5-monooxygenase activation protein, zeta polypeptide), MRFAP1, PSMA1, RPL13A, TXNL1, SLC25A3, RPS29, RPL8, PSMC1 and RPL4. One or more housekeeping genes can be used. Preferably, at least 2, 5, 10 or 15 housekeeping genes are used to provide a combined normalizing gene set. The amount of gene expression of such normalizing genes can be averaged, combined together by straight additions or by a defined algorithm. Some examples of particularly useful housekeeper genes for use in the methods and compositions of the invention include those listed in Table 2 below.

Table 2

Gene Symbol	Entrez GeneID	Applied Biosystems Assay ID	RefSeq Accession Nos.
<i>CLTC</i>	1213	Hs00191535_m1	NM_004859.3
<i>GUSB</i>	2990	Hs99999908_m1	NM_000181.2
<i>HMBS</i>	3145	Hs00609297_m1	NM_000190.3
<i>MMADHC</i>	27249	Hs00739517_g1	NM_015702.2
<i>MRFAP1*</i>	93621	Hs00738144_g1	NM_033296.1
<i>PPP2CA</i>	5515	Hs00427259_m1	NM_002715.2
<i>PSMA1*</i>	5682	Hs00267631_m1	
<i>PSMC1*</i>	5700	Hs02386942_g1	NM_002802.2
<i>RPL13A*</i>	23521	Hs03043885_g1	NM_012423.2
<i>RPL37</i>	6167	Hs02340038_g1	NM_000997.4
<i>RPL38</i>	6169	Hs00605263_g1	NM_000999.3
<i>RPL4*</i>	6124	Hs03044647_g1	NM_000968.2
<i>RPL8*</i>	6132	Hs00361285_g1	NM_033301.1; NM_000973.3
<i>RPS29*</i>	6235	Hs03004310_g1	NM_001030001.1; NM_001032.3
<i>SDHA</i>	6389	Hs00188166_m1	NM_004168.2
<i>SLC25A3*</i>	6515	Hs00358082_m1	NM_213611.1; NM_002635.2; NM_005888.2
<i>TXNL1*</i>	9352	Hs00355488_m1	NR_024546.1; NM_004786.2
<i>UBA52</i>	7311	Hs03004332_g1	NM_001033930.1; NM_003333.3
<i>UBC</i>	7316	Hs00824723_m1	NM_021009.4
<i>YWHAZ</i>	7534	Hs00237047_m1	NM_003406.3

* Subset of housekeeping genes used in, e.g., Example 3.

[0060] In the case of measuring RNA levels for the genes, one convenient and sensitive approach is real-time quantitative PCRTM (qPCR) assay, following a reverse transcription reaction. Typically, a cycle threshold (C_t) is determined for each test gene and each normalizing

gene, i.e., the number of cycles at which the fluorescence from a qPCR reaction above background is detectable.

[0061] The overall expression of the one or more normalizing genes can be represented by a “normalizing value” which can be generated by combining the expression of all normalizing genes, either weighted equally (straight addition or averaging) or by different predefined coefficients. For example, in a simplest manner, the normalizing value C_{tH} can be the cycle threshold (C_t) of one single normalizing gene, or an average of the C_t values of 2 or more, preferably 10 or more, or 15 or more normalizing genes, in which case, the predefined coefficient is $1/N$, where N is the total number of normalizing genes used. Thus, $C_{tH} = (C_{tH1} + C_{tH2} + \dots + C_{tHn})/N$. As will be apparent to skilled artisans, depending on the normalizing genes used, and the weight desired to be given to each normalizing gene, any coefficients (from $0/N$ to N/N) can be given to the normalizing genes in weighting the expression of such normalizing genes. That is, $C_{tH} = xC_{tH1} + yC_{tH2} + \dots + zC_{tHn}$, wherein $x + y + \dots + z = 1$.

[0062] As discussed above, the methods of the invention generally involve determining the level of expression of a panel of CCGs. With modern high-throughput techniques, it is often possible to determine the expression level of tens, hundreds or thousands of genes. Indeed, it is possible to determine the level of expression of the entire transcriptome (i.e., each transcribed sequence in the genome). Once such a global assay has been performed, one may then informatically analyze one or more subsets of transcripts (i.e., panels or, as often used herein, pluralities of test genes). After measuring the expression of hundreds or thousands of transcripts in a sample, for example, one may analyze (e.g., informatically) the expression of a panel or plurality of test genes comprising primarily CCGs according to the present invention by combining the expression level values of the individual test genes to obtain a test value.

[0063] As will be apparent to a skilled artisan, the test value provided in the present invention represents the overall expression level of the plurality of test genes composed substantially of cell-cycle genes. In one embodiment, to provide a test value in the methods of the invention, the normalized expression for a test gene can be obtained by normalizing the measured C_t for the test gene against the C_{tH} , i.e., $\Delta C_{t1} = (C_{t1} - C_{tH})$. Thus, the test value representing the overall expression of the plurality of test genes can be provided by combining the normalized expression of all test genes, either by straight addition or averaging (i.e.,

weighted equally) or by a different predefined coefficient. For example, the simplest approach is averaging the normalized expression of all test genes: test value = $(\Delta C_{t1} + \Delta C_{t2} + \dots + \Delta C_{tn})/n$. As will be apparent to skilled artisans, depending on the test genes used, different weight can also be given to different test genes in the present invention. In each case where this document discloses using the expression of a plurality of genes (e.g., “determining [in a sample from the patient] the expression of a plurality of test genes” or “correlating increased expression of said plurality of test genes to an increased likelihood of having melanoma”), this includes in some embodiments using a test value representing, corresponding to or derived or calculated from the overall expression of this plurality of genes (e.g., “determining [in a sample from the patient] a test value representing the expression of a plurality of test genes” or “correlating an increased test value [or a test value above some reference value] (optionally representing the expression of said plurality of test genes) to an increased likelihood of response”).

[0064] It has been determined that, once the CCP phenomenon reported herein is appreciated, the choice of individual CCGs for a test panel can often be somewhat arbitrary. In other words, many CCGs have been found to be very good surrogates for each other. Thus any CCG (or panel of CCGs) can be used in the various embodiments of the invention. In other embodiments of the invention, optimized CCGs are used. One way of assessing whether particular CCGs will serve well in the methods and compositions of the invention is by assessing their correlation with the mean expression of CCGs (e.g., all known CCGs, a specific set of CCGs, etc.). Those CCGs that correlate particularly well with the mean are expected to perform well in assays of the invention, e.g., because these will reduce noise in the assay.

[0065] Thus, in some embodiments of each of the various aspects of the invention the plurality of test genes comprises the top 2, 3, 4, 5, 6, 7, 8, 9, 10, 11, 12, 13, 14, 15, 20, 25, 30, 35, 40 or more CCGs from Panel A. In some embodiments of each of the various aspects of the invention the plurality of test genes comprises the top 2, 3, 4, 5, 6, 7, 8, 9 or 10 CCGs from Panel B. In some embodiments the plurality of test genes comprises at least some number of CCGs (e.g., at least 3, 4, 5, 6, 7, 8, 9, 10, 15, 20, 25, 30, 35, 40, 45, 50 or more CCGs) and this plurality of CCGs comprises at least 1, 2, 3, 4, 5, 6, 7, 8, 9 or 10 of the genes in Panel B. In some embodiments the plurality of test genes comprises at least some number of CCGs (e.g., at least 3, 4, 5, 6, 7, 8, 9, 10, 15, 20, 25, 30, 35, 40, 45, 50 or more CCGs) and this plurality of CCGs comprises any two, three, four, five, six, seven, eight, nine, or ten of gene numbers 1 & 2, 1 to 3,

1 to 4, 1 to 5, 1 to 6, 1 to 7, 1 to 8, 1 to 9, or 1 to 10 of any of the genes in Panel B (based on order of appearance in Table 1). In some embodiments the plurality of test genes comprises at least some number of CCGs (e.g., at least 3, 4, 5, 6, 7, 8, 9, 10, 15, 20, 25, 30, 35, 40, 45, 50 or more CCGs) and this plurality of CCGs comprises any one, two, three, four, five, six, seven, eight, or nine or all of gene numbers 2 & 3, 2 to 4, 2 to 5, 2 to 6, 2 to 7, 2 to 8, 2 to 9, or 2 to 10 of any of the genes in Panel B (based on order of appearance in Table 1). In some embodiments the plurality of test genes comprises at least some number of CCGs (e.g., at least 3, 4, 5, 6, 7, 8, 9, 10, 15, 20, 25, 30, 35, 40, 45, 50 or more CCGs) and this plurality of CCGs comprises any one, two, three, four, five, six, seven, or eight or all of gene numbers 3 & 4, 3 to 5, 3 to 6, 3 to 7, 3 to 8, 3 to 9, or 3 to 10 of any of the genes in Panel B (based on order of appearance in Table 1). In some embodiments the plurality of test genes comprises at least some number of CCGs (e.g., at least 3, 4, 5, 6, 7, 8, 9, 10, 15, 20, 25, 30, 35, 40, 45, 50 or more CCGs) and this plurality of CCGs comprises any one, two, three, four, five, six, or seven or all of gene numbers 4 & 5, 4 to 6, 4 to 7, 4 to 8, 4 to 9, or 4 to 10 of any of the genes in Panel B (based on order of appearance in Table 1).

[0066] In another embodiment, the plurality of CCGs or panel of CCGs comprises any set of genes from Table WW.

Immune and Additional Genes

[0067] It has additionally surprisingly been discovered that panels of immune genes are diagnostic for melanoma. Accordingly, in another aspect of the present disclosure, panels of genes comprising immune genes for use in determining gene expression, and for diagnosing and treating melanoma are disclosed. In some embodiments, use of panels comprising immune genes comprises determining expression of the immune genes in a sample from an individual or patient.

[0068] “Immune gene” herein refers to a gene associated with or expressed by one or more leukocytes. In particular embodiments, immune genes comprise genes associated with or expressed by lymphocytes. In some embodiments, the immune genes comprise genes expressed by activated lymphocytes. In some embodiments, immune genes comprise genes expressed by T cells. In some embodiments, immune genes comprise genes expressed by activated T cells. In some embodiments, immune genes comprise the immune genes identified in Table 3, below.

TABLE 3

Gene Name	Entrez Gene ID	Ensembl Gene ID	RefSeq Accession Nos.
ARPC2	10109	ENSG00000163466	NM_005731; NM_152862
BCL2A1*	597	ENSG00000140379	NM_004049
CCL19#	6363	ENSG00000172724	NM_006274
CCL3*#	6348	ENSG00000006075 ENSG00000136826	NM_002983; NM_004235
CCL5*#^	6352	ENSG00000161570	NM_002985
CD38*#^	952	ENSG00000004468	NM_001775
CFH*#	3075	ENSG00000000971	NM_000186; NM_001014975.1
CXCL10*#^	3627	ENSG00000169245	NM_001565.2
CXCL12#	6387	ENSG00000107562 ENSG00000126214	NM_000609.4; NM_001033886; NM_199168; NM_005552; NM_182923.3
CXCL13*#	10563	ENSG00000156234	NM_006419
CXCL9*#^	4283	ENSG00000138755	NM_002416
FABP7*	2173	ENSG00000113805	NM_020872
FN1*	2335	ENSG00000115414 ENSG00000197721	NM_002026; NM_054034.2; NM_212474; NM_212476.1; NM_212482.1; NM_175710.1
GDF15	9518		
HCLS1*#	3059	ENSG00000113070 ENSG00000180353	NM_001945; NM_005335
HEY1*	23462	ENSG00000164683	NM_001040708.1; NM_012258

HLA-DMA*#	3108	ENSG00000204257 ENSG00000206229 ENSG00000206293	NM_006120
HLA-DPA1#	3113		
HLA-DPB1#	3115	ENSG00000112242 ENSG00000168383	NM_001949; NM_002121
HLA-DRA*#	3122	ENSG00000143768 ENSG00000204287 ENSG00000206243	NM_003240; NM_019111
HLA-E#	3133	ENSG00000204592	NM_005516
IFI6*#	2537	ENSG00000126709 ENSG00000135047	NM_002038; NM_022872; NM_022873; NM_001912; NM_145918
IGHM#	3507		
IGJ*#	3512	ENSG00000132465 ENSG00000182197	NM_144646; NM_000127
IGLL5/CKA P2#	100423062		
IRF1*#^	3659		
IRF4#	3662	ENSG00000137265	NM_002460
ITGB2*#	3689	ENSG00000160255	NM_000211
KRT15*	3866	ENSG00000171346	NM_002275
LCP2*#^	3937	ENSG00000043462	NM_005565.3
NCOA3	8202	ENSG00000124151	NM_006534; NM_181659
NR4A1	3164	ENSG00000107223 ENSG00000123358	NM_003792; NM_153200; NM_002135; NM_173157; NM_173158
PECAM1*#	5175	ENSG00000173744 ENSG00000198802	NM_004504; NM_000442.3
PHACTR1*	221692	ENSG00000112137	NM_030948.1

PHIP	55023	ENSG00000146247	NM_017934
POU5F1	5460	ENSG00000204531 ENSG00000206349 ENSG00000206454	NM_002701; NM_203289.3
PRAME*	23532	ENSG00000185686	NM_006115 ;NM_206953; NM_206954; NM_206955; NM_206956
PTN*	5764		
PTPN22*#^	26191	ENSG00000134242	NM_012411; NM_015967
PTPRC*#^	5788	ENSG00000081237	NM_002838; NM_080921; NM_080922; NM_080923.2
RGS1*	5996	ENSG00000090104	NM_002922
S100A9*	6280	ENSG00000163220	NM_002965
SELL*	6402	ENSG00000188404	NM_000655.3
SERPINB4#	6318	ENSG00000057149 ENSG00000068796	NM_002974; NM_004520
SOCS3#	9021	ENSG00000184557	NM_003955
SPP1*	6696		
WIF1	11197	ENSG00000125285	NM_007084
WNT2	7472	ENSG00000105989	NM_003391

*Panel of 30 mixed genes (Panel D); #panel of 28 immune genes (Panel E); ^panel of 8 immune genes (Panel F)

[0069] Gene expression of immune genes can be determined as described above with respect to CCGs. In one embodiment, the amount of RNA transcribed from the panel of genes including immune genes is measured in the sample. In addition, the amount of RNA of one or more housekeeping genes in the sample is also measured, and used to normalize or calibrate the expression of the test genes. The terms “normalizing genes” and “housekeeping genes” are defined above.

[0070] In any embodiment of the invention involving a “plurality of test genes,” the plurality of test genes may include at least 2, 3 or 4 immune genes, which constitute at least 50%, 75% or 80% of the plurality of immune genes, and in some embodiments 100% of the plurality of immune genes. In some embodiments, the plurality of immune genes includes at least 5, 6, 7, or at least 8 cell-cycle genes, which constitute at least 20%, 25%, 30%, 40%, 50%, 60%, 70%, 75%, 80% or 90% of the plurality of immune genes, and in some embodiments 100% of the plurality of immune genes. As will be clear from the context of this document, a panel of genes is a plurality of genes. Typically these genes are assayed together in one or more samples from a patient.

[0071] In some other embodiments, the plurality of immune genes includes at least 8, 10, 12, 15, 20, 25 or 30 immune, which constitute at least 20%, 25%, 30%, 40%, 50%, 60%, 70%, 75%, 80% or 90% of the plurality of immune genes, and preferably 100% of the plurality of immune genes.

[0072] The sample used to determine the expression of immune genes may be any sample as described above for CCGs.

[0073] In the case of measuring RNA levels for the immune genes, real-time quantitative PCRTM (qPCR) assay with normalized values, as described above, may be used.

[0074] As discussed above, some embodiments of the methods disclosed generally involve determining the level of expression of a panel comprising immune genes. In some embodiments of the methods disclosed, genes may be assayed at one or more location along the gene sequence. With modern high-throughput techniques, it is often possible to determine the expression level of tens, hundreds or thousands of genes. Indeed, it is possible to determine the level of expression of the entire transcriptome (i.e., each transcribed sequence in the genome). Once such a global assay has been performed, one may then informatically analyze one or more subsets of transcripts (i.e., panels or, as often used herein, pluralities of test genes). After measuring the expression of hundreds or thousands of transcripts in a sample, for example, one may analyze (e.g., informatically) the expression of a panel or plurality of test genes comprising primarily immune genes according to the present invention by combining the expression level values of the individual test genes to obtain a test value.

[0075] Thus, in some embodiments of each of the various aspects of the invention the plurality of test genes comprises any 2, 3, 4, 5, 6, 7, 8, 9, 10, 11, 12, 13, 14, 15, 20, 25, or 28 Immune genes from Panel E. In some embodiments of each of the various aspects of the invention the plurality of test genes comprises 2, 3, 4, 5, 6, 7, 8 immune genes from Panel F. In some embodiments the plurality of test genes comprises at least some number of immune genes (e.g., at least 2, 3, 4, 5, 6, 7, 8, 9, 10, 15, 20, 25, 30, 35, 40, 45, 50 or more immune genes) and this plurality of immune genes comprises at least 1, 2, 3, 4, 5, 6, 7, 8, 9, 10, 15, 20, 25, or 28 of the genes in Panel E, or 2, 3, 4, 5, 6, 7, 8, 9 or 10 immune genes from Panel F.

[0076] It has also been found that additional genes may be diagnostic for melanoma. Without being bound by theory, these additional genes are believed to be non-CCG and non-immune genes, and comprise ARPC2, BCL2A1, FABP7, FN1, GDF15, HEY1, KRT15, NCOA3, NR4A1, PHACTR1, PHIP, POU5F1, PRAME, PTN, RGS1, S100A9, SELL, SPP1, WIF1, and WNT2 (Panel G). Accordingly, in another aspect of the present disclosure, panels of genes comprising these additional genes are disclosed for use in determining gene expression, and for diagnosing and treating melanoma.

[0077] In one embodiment, the panel comprising these additional genes: BCL2A1, FABP7, FN1, HEY1, KRT15, PHACTR1, PRAME, PTN, RGS1, S100A9, SELL, and SPP1 (Panel H). In another embodiment, the panel comprising additional genes comprises PRAME and S100A9.

[0078] In additional embodiments, this disclosure provides for mixed panels of genes which are useful in determining gene expression, and for diagnosing and treating melanoma. These mixed panels may comprise immune genes and CCGs, or immune genes and genes from Panel G or H, or CCGs and genes from panel G or H. In one embodiment, the mixed panel comprises one or more CCGs, one or more immune genes, and one or more additional genes from panel G. In one embodiment, the mixed panel comprises Panel D. In another embodiment, the mixed panel comprises PRAME, S100A9 and the genes of panel F.

[0079] In another embodiment, the mixed panel comprises one or more CCGs, one or more immune genes, and one or more additional genes from panel H. In one embodiment of a mixed panel, the mixed panel (Panel I) comprises the genes from Panel C and the genes from Panel D.

[0080] In one embodiment of a mixed panel, the mixed panel) comprises S100A9 and/or S100A9-related genes. The S100A9 related genes can include genes that have highly correlated expression compared to S100A9. These S100A9-related genes may include genes that are closely clustered with S100A9 on chromosome 1. These S100A9-related genes may also include genes that have similar transcription control as S100A9. The S100A9-related proteins may also be part of the same biological pathway. The S100A9-related genes may also code for proteins that interact with the protein coded by S100A9. As a non-limiting example, the mixed panel may comprise S100A9, S100A7, S100A8, S100A12, PI3, S100A10, and S100A14 (Panel J). As a non-limiting example, the mixed panel may comprise S100A9, S100A7, S100A8, S100A12, and PI3 (Panel L).

[0081] In an alternate embodiment, the mixed panel comprises PRAME. In another embodiment, the mixed panel comprises S100A9. In yet another embodiment, the mixed panel comprises CCL5, CD38, CXCL10, CXCL9, IRF1, LCP2, PTPN22, or PTPRC. In other embodiments the mixed panel comprises S100A7, S100A8, S100A12, PI3, S100A10, and S100A14. In some embodiments, the mixed panel comprises S100A9, S100A7, S100A8, S100A12, and PI3. Thus, in some embodiments of each of the various aspects of the invention the panel of mixed genes comprises any 2, 3, 4, 5, 6, or 7 S100A9-related genes from Panel J. In other embodiments of each of the various aspects of the invention the panel of mixed genes comprises any 2, 3, 4, 5, 6, or 7 S100A9-related genes from Panel L.

[0082] Thus, in some embodiments of each of the various aspects of the invention the panel of mixed genes comprises PRAME, at least one of the genes of Panel J, and at least one of the genes of panel F. In some embodiments, the mixed panel comprises PRAME, S100A9, S100A7, S100A8, S100A12, S100A10, S100A14, PI3, CCL5, CD38, CXCL10, CXCL9, IRF1, LCP2, PTPN22, and PTPRC.

[0083] Thus, in some embodiments of each of the various aspects of the invention the panel of mixed genes comprises PRAME, at least one of the genes of Panel L, and at least one of the genes of panel F. In some embodiments, the mixed panel comprises PRAME,

S100A9, S100A7, S100A8, S100A12, PI3, CCL5, CD38, CXCL10, CXCL9, IRF1, LCP2, PTPN22, and PTPRC.

[0084] Thus, in some embodiments of each of the various aspects of the invention the panel of mixed genes comprises PRAME, S100A9, and at least 1, 2, 3, 4, 5, 6, 7, or 8 genes of panel F. In some embodiments, the panel of mixed genes comprises PRAME and at least 1, 2, 3, 4, 5, 6, or 7 genes of Panel J, and at least 1, 2, 3, 4, 5, 6, 7, or 8 genes of panel F. In some embodiments, the panel of mixed genes comprises PRAME, S100A9, and at least 1, 2, 3, 4, 5, 6, 7, 8, 9, 10, 11, 12, 13, 14, 15, 16, 17, 18, 19, or 20 genes of panel E. In some embodiments, the panel of mixed genes comprises PRAME, and at least 1, 2, 3, 4, 5, 6, or 7 genes of Panel J, and at least 1, 2, 3, 4, 5, 6, 7, 8, 9, 10, 11, 12, 13, 14, 15, 16, 17, 18, 19, or 20 genes of Panel E.

[0085] Thus, in some embodiments of each of the various aspects of the invention the panel of mixed genes comprises at least 1, 2, 3, 4, 5, 6, 7, 8, 9, 10, 11, 12, 13, 14, 15, 16, 17, 18, 19, 20, 21, 22, 23, 24, 25, 26, 27, 28, 29, or 30 genes of Panel D, and S100A9, and at least 1, 2, 3, 4, 5, 6, 7, or 8 genes of panel F. In some embodiments, the panel of mixed genes comprises at least 1, 2, 3, 4, 5, 6, 7, 8, 9, 10, 11, 12, 13, 14, 15, 16, 17, 18, 19, 20, 21, 22, 23, 24, 25, 26, 27, 28, 29, or 30 genes of Panel D and at least 1, 2, 3, 4, 5, 6, or 7 genes of Panel J, and at least 1, 2, 3, 4, 5, 6, 7, or 8 genes of panel F. In some embodiments, the panel of mixed genes comprises at least 1, 2, 3, 4, 5, 6, 7, 8, 9, 10, 11, 12, 13, 14, 15, 16, 17, 18, 19, 20, 21, 22, 23, 24, 25, 26, 27, 28, 29, or 30 genes of Panel D, S100A9, and at least 1, 2, 3, 4, 5, 6, 7, 8, 9, 10, 11, 12, 13, 14, 15, 16, 17, 18, 19, or 20 genes of panel E. In some embodiments, the panel of mixed genes comprises at least 1, 2, 3, 4, 5, 6, 7, 8, 9, 10, 11, 12, 13, 14, 15, 16, 17, 18, 19, 20, 21, 22, 23, 24, 25, 26, 27, 28, 29, or 30 genes of Panel D, and at least 1, 2, 3, 4, 5, 6, or 7 genes of Panel J, and at least 1, 2, 3, 4, 5, 6, 7, 8, 9, 10, 11, 12, 13, 14, 15, 16, 17, 18, 19, or 20 genes of Panel E.

[0086] Thus, in some embodiments of each of the various aspects of the invention the panel of mixed genes comprises at least at least 1, 2, 3, 4, 5, 6, 7, 8, 9, 10, 11, 12, 13, 14, 15, 16, 17, 18, 19, or 20 genes of Panel G, and S100A9, and at least 1, 2, 3, 4, 5, 6, 7, or 8 genes of panel F. In some embodiments, the panel of mixed genes comprises at least at

least 1, 2, 3, 4, 5, 6, 7, 8, 9, 10, 11, 12, 13, 14, 15, 16, 17, 18, 19, or 20 genes of Panel G, and at least 1, 2, 3, 4, 5, 6, or 7 genes of Panel J, and at least 1, 2, 3, 4, 5, 6, 7, or 8 genes of panel F. In some embodiments, the panel of mixed genes comprises at least 1 at least 1, 2, 3, 4, 5, 6, 7, 8, 9, 10, 11, 12, 13, 14, 15, 16, 17, 18, 19, or 20 genes of Panel G, S100A9, and at least 1, 2, 3, 4, 5, 6, 7, 8, 9, 10, 11, 12, 13, 14, 15, 16, 17, 18, 19, or 20 genes of panel E. In some embodiments, the panel of mixed genes comprises at least at least 1, 2, 3, 4, 5, 6, 7, 8, 9, 10, 11, 12, 13, 14, 15, 16, 17, 18, 19, or 20 genes of Panel G, and at least 1, 2, 3, 4, 5, 6, or 7 genes of Panel J, and at least 1, 2, 3, 4, 5, 6, 7, 8, 9, 10, 11, 12, 13, 14, 15, 16, 17, 18, 19, or 20 genes of Panel E.

[0087] Thus, in some embodiments of each of the various aspects of the invention the panel of mixed genes comprises at least at least at least 1, 2, 3, 4, 5, 6, 7, 8, 9, 10, 11, or 12 genes of Panel H, and S100A9, and at least 1, 2, 3, 4, 5, 6, 7, or 8 genes of panel F. In some embodiments, the panel of mixed genes comprises at least at least at least 1, 2, 3, 4, 5, 6, 7, 8, 9, 10, 11, or 12 genes of Panel H, and at least 1, 2, 3, 4, 5, 6, or 7 genes of Panel J, and at least 1, 2, 3, 4, 5, 6, 7, or 8 genes of panel F. In some embodiments, the panel of mixed genes comprises at least 1 at least 1 at least 1, 2, 3, 4, 5, 6, 7, 8, 9, 10, 11, or 12 genes of Panel H, S100A9, and at least 1, 2, 3, 4, 5, 6, 7, 8, 9, 10, 11, 12, 13, 14, 15, 16, 17, 18, 19, or 20 genes of panel E. In some embodiments, the panel of mixed genes comprises at least at least at least 1, 2, 3, 4, 5, 6, 7, 8, 9, 10, 11, or 12 genes of Panel H, and at least 1, 2, 3, 4, 5, 6, or 7 genes of Panel J, and at least 1, 2, 3, 4, 5, 6, 7, 8, 9, 10, 11, 12, 13, 14, 15, 16, 17, 18, 19, or 20 genes of Panel E.

[0088] In one embodiment, the panel comprises any set of two genes from Table XX. In another embodiment, the panel comprises any set of three genes from Table YY. In another embodiment, the panel comprises any set of four genes from Table ZZ.

[0089] In one embodiment of a panel of housekeeper genes, the housekeeper panel (Panel K) comprises one or more genes for use in normalizing the expression of test genes. Panel K can be made up of any gene whose expression is used to calibrate or normalize measured expression of the gene or genes of interest. Panel K can be made up of any housekeeping or housekeeper genes known in the art. Examples of housekeeper genes that can be used in Panel K include CLTC, GUSB, HMBS,

MMADHC, MRFAP1, PPP2CA, PSMA1, PSMC1, RPL13A, RPL37, RPL38, RPL4, RPL8, RPS29, SDHA, SLC25A3, TXNL1, UBA52, UBC, and YWHAZ. In some embodiments, the housekeeper genes used to normalize the expression of test genes can include at least 1, 2, 3, 4, 5, 6, 7, 8, 9, 10, 11, 12, 13, 14, 15, 16, 17, 18, 19, or 20 genes of Panel K.

Methods of Determining Gene Expression

[0090] Accordingly, in a first aspect of the present invention, a method is provided for determining gene expression in a sample from a patient (e.g., one suspected of containing melanoma). Generally, the method includes at least the following steps: (1) obtaining a sample from a patient (e.g., one suspected of containing melanoma); (2) determining the expression of a panel of genes in the sample; and (3) providing a test value by (a) weighting the determined expression of each gene from the panel of genes with a predefined coefficient, and (b) combining the weighted expression of each gene from the panel of genes to provide said test value.

[0091] Weighting the expression of each gene from the panel of genes may be performed individually for each gene, or genes may first be grouped and their normalized expression averaged or otherwise combined before weighting is performed. In some embodiments, genes are grouped based on whether they provide independent information in separating nevi from melanoma. In some examples, CCGs are grouped before weighting. In other embodiments, immune genes are grouped before weighting. The skilled artisan will understand that in some embodiments, grouping may be conceptualized as a way of individually weighting each gene in the pre-defined group to arrive at an intermediate value, which intermediate value is weighted along with other individual gene expression values to obtain a final value. In some embodiments, multiple rounds of grouping may be performed, resulting in multiple intermediate values, which may be in turn grouped to obtain a final value.

[0092] In some embodiments, weighting coefficients are determined which optimize the contribution of each expression profile to the predictive value of any resulting test value. In some embodiments, genes whose expression is more highly correlated or anti-correlated with melanoma receive a larger weighting coefficient in order to maximize the overall predictive power of any resulting test value. In some embodiments, genes whose expression is correlated or anti-correlated with melanoma, but less correlated with the expression of other genes in the

panel receive a larger weighting coefficient in order to maximize the overall predictive power of any resulting test value. In some embodiments, genes whose expression is significantly, moderately, or highly correlated may be grouped.

[0093] In some embodiments, regression analyses are utilized to obtain appropriate weighting coefficients to maximize the predictive power of a test value. In some embodiments, linear regression is used to fit expression levels to a model for providing test values which are diagnostic of melanoma. In other embodiments, logistic regression is used to determine weighting coefficients for expression levels of individual genes or groups of genes in a model for diagnosis of melanoma.

[0094] In some embodiments, weighting the expression of each gene comprises grouping immune genes, and then weighting the expression of immune genes, PRAME and S100A9 to arrive at a test value which is diagnostic for melanoma. In related embodiments, there are 8 immune genes. In related embodiments, the immune genes comprise Panel F. In some embodiments, the weighting to arrive at a test value is as follows: test value = (A x PRAME) + (B x grouped immune) + (C x S100A9). In a related embodiment, A is 0.525, B is 0.677 and C is 0.357.

[0095] In some embodiments, weighting the expression of each gene comprises grouping immune genes, grouping S100A9-related genes and then weighting the expression of immune genes, PRAME and the S100A9-related genes to arrive at a test value which is diagnostic for melanoma. In related embodiments, there are 8 immune genes. In related embodiments, the immune genes comprise Panel F. In related embodiments, there are 7 S100A9-related genes. In related embodiments, the S100A9-related genes comprise Panel J. In related embodiments, the S100A9-related genes comprise Panel L. In some embodiments, the weighting to arrive at a test value is as follows: test value = (A x PRAME) + (B x grouped immune) + (C x grouped S100A9-related). In a related embodiment, A is 1.149, B is 0.698 and C is 0.922.

[0096] In some embodiments, weighting the expression of each gene comprises grouping immune genes, grouping S100A9-related genes and then weighting the expression of immune genes, PRAME and the S100A9-related genes and then adjusting by a linear scale factor to arrive at a test value which is diagnostic for melanoma. In some embodiments, the linear scale

factor adjusts the cutoff value so that the cutoff value is centered about zero. In related embodiments, there are 8 immune genes. In related embodiments, the immune genes comprise Panel F. In related embodiments, there are 7 S100A9-related genes. In related embodiments, the S100A9-related genes comprise Panel J. In separate related embodiments, the S100A9-related genes comprise Panel L. In some embodiments, the weighting to arrive at a test value is as follows: $\text{test value} = (A \times \text{PRAME}) + (B \times \text{grouped immune}) + (C \times \text{grouped S100A9-related}) + D$. In a related embodiment, A is 1.149, B is 0.698, C is 0.922, and D is -0.334.

[0097] In some embodiments, weighting the expression of each gene comprises grouping immune genes, grouping S100A9-related genes and then weighting the expression of immune genes, PRAME and the S100A9-related genes and then adjusting by a linear scale factor to arrive at a test value which is diagnostic for melanoma. In some embodiment, the linear scale factor adjusts the cutoff value so that the cutoff value is centered about zero. In related embodiments, there are 8 immune genes. In related embodiments, the immune genes comprise Panel F. In related embodiments, there are 5 S100A9-related genes. In related embodiments, the S100A9-related genes comprise Panel J. In separate related embodiments, the S100A9-related genes comprise Panel L. In some embodiments two areas of the PRAME gene are assayed. In some embodiments, the weighting to arrive at a test value is as follows: $\text{test value} = (A \times \text{PRAME}) + (B \times \text{grouped immune}) + (C \times \text{grouped S100A9-related}) + D$. In some embodiments A = 1.223, B = 0.704, C = 1.023, and D = 0.267.

[0098] In some embodiments a test value derived from expression levels may be combined with non-expression parameters to arrive at a modified test value or score which is diagnostic for melanoma. In some embodiments, clinical factors may be combined with a test value derived from expression levels in order to provide a score which is diagnostic for melanoma. In related embodiments, clinical staging data may be weighted and combined with a test value based on expression to obtain a score which is diagnostic for melanoma.

[0099] In some embodiments a reference score may be established. In some embodiments samples may be classified by correlating their test score to the reference score. In some embodiments test scores may be classified as either above or below the reference score. In some embodiments two reference scores, a first and a second reference may be established. In

some embodiments samples may be classified by correlating their test score to the reference score. In some embodiments test scores may be classified as above one, above both, below one, below both, or in between the reference scores.

Methods of Diagnosing Melanoma

[00100] Provided herein are also methods of diagnosing melanoma. Generally, a method is provided for diagnosing melanoma, which comprises a) determining in a sample from an individual the expression of a panel of genes; b) comparing the expression of the panel of genes in the sample to the expression of the panel of genes in one or more control samples; and c) diagnosing the individual with melanoma, or concluding that the individual is likely to have melanoma, based at least in part on a difference between the expression of one or more genes of the panel of genes in the sample versus the one or more control samples.

[00101] The step of comparing the expression of the panel of genes may be performed directly (i.e. obtaining an expression value for each gene in the panel of genes in the sample and in the one or more control sample, and determining on a gene by gene basis if there is a significant difference between the expression in the sample versus the one or more controls). Alternately, comparing the expression of the panel of genes in the sample to the expression in one or more control samples may be performed implicitly. In some embodiments, implicit comparison is achieved by building a model based on the one or more control samples and determining where the expression of the panel of genes in the individual sample fits within the model. In one embodiment, implicit comparison of the expression of the panel of genes in the sample to one or more control samples comprises utilizing a pre-determined set of weighting coefficients based on analysis of the one or more control samples to weight the expression of the panel of genes in the sample and arrive at a test value. In a related embodiment, the test value is compared to a pre-determined cutoff value based on analysis of the one or more control samples to achieve implicit comparison.

[00102] In some embodiments, the methods of diagnosis further comprise communicating that the individual is likely to have melanoma.

[00103] As used herein, “communicating” a particular piece of information means to make such information known to another person or transfer such information to a thing (e.g., a computer). In some methods of the invention, a patient’s diagnosis or likelihood of having

melanoma is communicated. In some embodiments, the information used to arrive at such a diagnosis or likelihood prediction is communicated. This communication may be auditory (e.g., verbal), visual (e.g., written), electronic (e.g., data transferred from one computer system to another), etc. In some embodiments, communicating a diagnosis or likelihood of melanoma comprises generating a report that communicates the diagnosis or likelihood of melanoma. In some embodiments the report is a paper report, an auditory report, or an electronic record. In some embodiments the report is displayed and/or stored on a computing device (e.g., handheld device, desktop computer, smart device, website, etc.). In some embodiments the diagnosis or likelihood of melanoma is communicated to a physician (e.g., a report communicating the classification is provided to the physician). In some embodiments the diagnosis or likelihood of melanoma is communicated to a patient (e.g., a report communicating the classification is provided to the patient). Communicating a diagnosis or likelihood of melanoma can also be accomplished by transferring information (e.g., data) embodying the classification to a server computer and allowing an intermediary or end-user to access such information (e.g., by viewing the information as displayed from the server, by downloading the information in the form of one or more files transferred from the server to the intermediary or end-user's device, etc.).

[00104] Wherever an embodiment of the invention comprises concluding some fact (e.g., a patient's likelihood of having melanoma), this may include a computer program concluding such fact, typically after performing an algorithm that applies information on the expression of the panel of genes in the sample, as described above.

[00105] In some embodiments, the method of diagnosis includes (1) obtaining a sample from a patient suspected of having melanoma; (2) determining the expression of a panel of genes in the sample including at least 2, 4, 6, 8 or 10 cell-cycle genes, or at least 2, 4, 6 or 8 immune genes; and (3) providing a test value by (a) weighting the determined expression of each of a plurality of test genes selected from the panel of genes with a predefined coefficient, and (b) combining the weighted expression to provide said test value, wherein at least 20%, 50%, at least 75% or at least 90% of said plurality of test genes are cell-cycle genes, and wherein high expression (or increased expression or overexpression) of the plurality of test genes indicates a increase likelihood of having melanoma. In some embodiments, the method comprises at least one of the following steps: (a) correlating high expression (or increased expression or overexpression) of the plurality of test genes to an increased likelihood of having melanoma; (b)

concluding that the patient has an increased likelihood of having melanoma based at least in part on high expression (or increased expression or overexpression) of the plurality of test genes; or (c) communicating that the patient has an increased likelihood of having melanoma based at least in part on high expression (or increased expression or overexpression) of the plurality of test genes. In some embodiments, the method comprises at least one of the following steps: (a) correlating mixed expression levels of the plurality of test genes to an indeterminate likelihood of having melanoma measured in a sample are (b) concluding that the patient has may or may not have an increased likelihood of having melanoma based at least in part on mixed expression of the plurality of test genes; or (c) communicating that the patient has an indeterminate likelihood of having melanoma based at least in part on the mixed expression (or increased expression or overexpression) of the plurality of test genes.

[00106] In some embodiments, the expression levels measured in a sample are used to derive or calculate a value or score, as described above. This value may be derived solely from expression levels or optionally derived from a combination of the expression value scores with other components (e.g., clinical staging, etc.) to give a potentially more comprehensive value/score. Thus, in every case where an embodiment of the invention described herein involves determining the status of a biomarker (e.g., CCGS, immune genes or additional genes, as defines), related embodiments involve deriving or calculating a value or score from the measured status (e.g., expression score, or combined score).

[00107] In some such embodiments, multiple scores (e.g., expression test value and clinical parameters, such as clinical staging) can be combined into a more comprehensive score. Single component (e.g., CCG) or combined test scores for a particular patient can be compared to single component or combined scores for reference populations, with differences between test and reference scores being correlated to or indicative of some clinical feature. Thus, in some embodiments the invention provides a method of determining a melanoma diagnosis comprising (1) obtaining the measured expression levels of a panel of genes in a sample from the patient, (2) calculating a test value from these measured expression levels, (3) comparing said test value to a reference value calculated from measured expression levels of the panel of genes in a reference population of patients, and (4)(a) correlating a test value greater than the reference value to a diagnosis of melanoma or (4)(b) correlating a test value equal to or less than the reference value to a benign diagnosis.

[00108] In some such embodiments, multiple scores (e.g., expression test value and clinical parameters, such as clinical staging) can be combined into a more comprehensive score. Single component (e.g., CCG) or combined test scores for a particular patient can be compared to single component or combined scores for reference populations, with differences between test and reference scores being correlated to or indicative of some clinical feature. Thus, in some embodiments the invention provides a method of determining a melanoma diagnosis comprising (1) obtaining the measured expression levels of a panel of genes in a sample from the patient, (2) calculating a test value from these measured expression levels, (3) comparing said test value to a reference value calculated from measured expression levels of the panel of genes in a reference population of patients, and (4) correlating a test value to one of two reference values where (a) a test value equal or greater than the first reference value is correlated to a diagnosis of melanoma, (b) a test value equal to or less than the first reference value but greater than the second reference value is correlated to an indeterminate diagnosis, or (c) a test value equal to or less than the second reference value is correlated to a benign diagnosis.

[00109] In some such embodiments the test value is calculated by averaging the measured expression of the panel genes (as discussed below). In some embodiments the test value is calculated by weighting each of the panel of genes in a particular way, as described above.

[00110] In some embodiments the combined score includes CCP score as previously defined. In some embodiments, the combined score includes an immune score as demonstrated in the Examples. In some embodiments the immune score is an average of the expression of the genes in an immune gene panel. In some embodiments, the immune score is an average of the expression of the genes in Table 30. The immune score may be any value used to represent the expression of one or more immune genes as described herein. In some embodiments the immune score is an average of the expression of the genes in an immune gene panel. In some embodiments, the immune score is an average of the expression of the genes in Panel D. In some embodiments the immune score is an average of the expression of the genes in an immune gene panel. In some embodiments, the immune score is an average of the expression of the genes in Panel E. In some embodiments the immune score is an average of the expression of the genes in an immune gene panel. In some embodiments, the immune score is an average of the expression of the genes in Panel F. A combined score may also include individual genes with

independent predictive value, and other non-expression based clinical factors. CCP and immune scores can be a continuous numeric variable.

[00111] In some embodiments the combined score is calculated according to the following formula:

$$(1) \textit{ Combined score} = A*(CCP \textit{ score}) + B*(\textit{immune score}) + \{C*\textit{additional gene X expression}\} + D*\textit{additional gene Y expression...}$$

Where X and Y represent any diagnostic additional gene as described herein, and the ellipsis indicates that extra additional genes, each with their own coefficient may be added.

[00112] Additionally, in some embodiments, the combined score is calculated according to the following formula:

$$(2) \textit{ Combined score} = B*(\textit{immune score}) + \{C*\textit{additional gene X expression}\} + D*\textit{additional gene Y expression...}$$

Where X and Y represent any diagnostic additional gene as described herein, and the ellipsis indicates that extra additional genes, each with their own coefficient may be added. In a related embodiment, additional gene X is PRAME and additional gene Y is S100A9 or an S100 score.

[00113] Furthermore, in yet other embodiments, the combined score is calculated according the following formula:

$$(3) \textit{ Combined score} = B*(\textit{immune score}) + \{C*(\textit{additional gene X expression}\} + D*\textit{additional gene Y expression...}\} + \textit{adjustment factor}$$

Where X and Y represent any diagnostic additional gene as described herein, and the ellipsis indicates that extra additional genes, each with their own coefficient may be added. The adjustment factor represents a scalar factor that can be used to adjust the linear score. For example in some embodiments, the adjustment factor can adjust the score of a particular cutoff value such that the cutoff value is centered at zero. In a related embodiment, additional gene X is PRAME and additional gene Y is S100A9 or an S100 score.

Furthermore, in yet other embodiments, the combined score is calculated according the following formula: (4)
$$\textit{ Combined score} = B*(\textit{immune score}) + \{C*(S100 \textit{ Score}\} + D*\textit{additional gene Y expression...}\} + \textit{adjustment factor}$$

Where Y represents any diagnostic additional gene as described herein, and the ellipsis indicates that extra additional genes, each with their own coefficient may be added. The adjustment factor represents a scalar factor that can be used to adjust the linear score. For example in some embodiments, the adjustment factor can adjust the score of a particular cutoff value such that the cutoff value is centered at zero. The S100 score may be any value used to represent the expression of one or more S100A9 and/or S100A9 related genes as described herein. In some embodiments the S100 score is an average of the expression of the genes in an S100A9 and/or S100A9 related gene panel. In a related embodiment, the S100 score is an average of the expression of the genes in Panel J. In a related embodiment, the S100 score is an average of the expression of the genes in Panel L. In a related embodiment, the S100 score is an average of the expression of S100A9, S100A7, S100A8, S100A12, PI3, S100A10, and S100A14. In a related embodiment, the S100 score is an average of the expression of S100A9, S100A7, S100A8, S100A12, and PI3. In a related embodiment, additional gene Y is PRAME.

[00114] In some embodiments, formula (1) is used in the methods, systems, etc. of the invention to diagnose a patient with melanoma. In some embodiments, formula (2) is used in the methods, systems, etc. of the invention to diagnose a patient with melanoma. . In some embodiments, formula (3) is used in the methods, systems, etc. of the invention to diagnose a patient with melanoma. . In some embodiments, formula (4) is used in the methods, systems, etc. of the invention to diagnose a patient with melanoma. In some embodiments CCP score is the unweighted mean of CT values for expression of the CCP genes being analyzed, optionally normalized by the unweighted mean of the HK genes so that higher values indicate higher expression (in some embodiments one unit is equivalent to a two-fold change in expression). In some embodiments the CCP score ranges from -8 to 8 or from -1.6 to 3.7.

[00115] In some embodiments $A = 0.95$, $B = 0.61$, $C = 0.90$ (where applicable), and $D = 1.00$ (where applicable); $A = 0.57$ and $B = 0.39$; or $A = 0.58$ and $B = 0.41$. In some embodiments, A, B, C, D, and/or the adjustment factor is within rounding of these values (e.g., A is between 0.945 and 0.954, etc.). In some cases a formula may not have all of the specified coefficients (and thus not incorporate the corresponding variable(s)). For example, the embodiment mentioned immediately previously may be applied to formula (2) so that B in formula (2) is 0.61, $C = 0.90$ (where applicable), and $D = 1.00$ (where applicable). A would not be applicable as this coefficient and its corresponding variable is not found in formula (2). In

some embodiments A is between 0.9 and 1, 0.9 and 0.99, 0.9 and 0.95, 0.85 and 0.95, 0.86 and 0.94, 0.87 and 0.93, 0.88 and 0.92, 0.89 and 0.91, 0.85 and 0.9, 0.8 and 0.95, 0.8 and 0.9, 0.8 and 0.85, 0.75 and 0.99, 0.75 and 0.95, 0.75 and 0.9, 0.75 and 0.85, or between 0.75 and 0.8. In some embodiments B is between 0.40 and 1, 0.45 and 0.99, 0.45 and 0.95, 0.55 and 0.8, 0.55 and 0.7, 0.55 and 0.65, 0.59 and 0.63, or between 0.6 and 0.62. In some embodiments C is, where applicable, between 0.9 and 1.5, between .9 and 1.4, between 0.9 and 1.3, between 0.9 and 1.25, between 0.9 and 1.20, between 0.9 and 1.15, between 0.9 and 1.10, between 0.9 and 1.05, between 0.9 and 1, 0.9 and 0.99, 0.9 and 0.95, 0.85 and 0.95, 0.86 and 0.94, 0.87 and 0.93, 0.88 and 0.92, 0.89 and 0.91, 0.85 and 0.9, 0.8 and 0.95, 0.8 and 0.9, 0.8 and 0.85, 0.75 and 0.99, 0.75 and 0.95, 0.75 and 0.9, 0.75 and 0.85, or between 0.75 and 0.8. In some embodiments D is, where applicable, between 0.9 and 1.5, between .9 and 1.4, between 0.9 and 1.3, between 0.9 and 1.25, between 0.9 and 1.20, between 0.9 and 1.15, between 0.9 and 1.10, between 0.9 and 1.05, 0.9 and 1, 0.9 and 0.99, 0.9 and 0.95, 0.85 and 0.95, 0.86 and 0.94, 0.87 and 0.93, 0.88 and 0.92, 0.89 and 0.91, 0.85 and 0.9, 0.8 and 0.95, 0.8 and 0.9, 0.8 and 0.85, 0.75 and 0.99, 0.75 and 0.95, 0.75 and 0.9, 0.75 and 0.85, or between 0.75 and 0.8.

[00116] In some embodiments A is between 0.1 and 0.2, 0.3, 0.4, 0.5, 0.6, 0.7, 0.8, 0.9, 1, 1.5, 2, 2.5, 3, 3.5, 4, 4.5, 5, 6, 7, 8, 9, 10, 11, 12, 13, 14, 15, or 20; or between 0.2 and 0.3, 0.4, 0.5, 0.6, 0.7, 0.8, 0.9, 1, 1.5, 2, 2.5, 3, 3.5, 4, 4.5, 5, 6, 7, 8, 9, 10, 11, 12, 13, 14, 15, or 20; or between 0.3 and 0.4, 0.5, 0.6, 0.7, 0.8, 0.9, 1, 1.5, 2, 2.5, 3, 3.5, 4, 4.5, 5, 6, 7, 8, 9, 10, 11, 12, 13, 14, 15, or 20; or between 0.4 and 0.5, 0.6, 0.7, 0.8, 0.9, 1, 1.5, 2, 2.5, 3, 3.5, 4, 4.5, 5, 6, 7, 8, 9, 10, 11, 12, 13, 14, 15, or 20; or between 0.5 and 0.6, 0.7, 0.8, 0.9, 1, 1.5, 2, 2.5, 3, 3.5, 4, 4.5, 5, 6, 7, 8, 9, 10, 11, 12, 13, 14, 15, or 20; or between 0.6 and 0.7, 0.8, 0.9, 1, 1.5, 2, 2.5, 3, 3.5, 4, 4.5, 5, 6, 7, 8, 9, 10, 11, 12, 13, 14, 15, or 20; or between 0.7 and 0.8, 0.9, 1, 1.5, 2, 2.5, 3, 3.5, 4, 4.5, 5, 6, 7, 8, 9, 10, 11, 12, 13, 14, 15, or 20; or between 0.8 and 0.9, 1, 1.5, 2, 2.5, 3, 3.5, 4, 4.5, 5, 6, 7, 8, 9, 10, 11, 12, 13, 14, 15, or 20; or between 0.9 and 1, 1.5, 2, 2.5, 3, 3.5, 4, 4.5, 5, 6, 7, 8, 9, 10, 11, 12, 13, 14, 15, or 20; or between 1 and 1.5, 2, 2.5, 3, 3.5, 4, 4.5, 5, 6, 7, 8, 9, 10, 11, 12, 13, 14, 15, or 20; or between 1.5 and 2, 2.5, 3, 3.5, 4, 4.5, 5, 6, 7, 8, 9, 10, 11, 12, 13, 14, 15, or 20; or between 2 and 2.5, 3, 3.5, 4, 4.5, 5, 6, 7, 8, 9, 10, 11, 12, 13, 14, 15, or 20; or between 2.5 and 3, 3.5, 4, 4.5, 5, 6, 7, 8, 9, 10, 11, 12, 13, 14, 15, or 20; or between 3 and 3.5, 4, 4.5, 5, 6, 7, 8, 9, 10, 11, 12, 13, 14, 15, or 20; or between 3.5 and 4, 4.5, 5, 6, 7, 8, 9, 10, 11, 12, 13, 14, 15, or 20; or between 4 and 4.5, 5, 6, 7, 8, 9, 10, 11, 12, 13, 14, 15, or 20; or between 4.5 and 5, 6, 7,

8, 9, 10, 11, 12, 13, 14, 15, or 20; or between 5 and 6, 7, 8, 9, 10, 11, 12, 13, 14, 15, or 20; or between 6 and 7, 8, 9, 10, 11, 12, 13, 14, 15, or 20; or between 7 and 8, 9, 10, 11, 12, 13, 14, 15, or 20; or between 8 and 9, 10, 11, 12, 13, 14, 15, or 20; or between 9 and 10, 11, 12, 13, 14, 15, or 20; or between 10 and 11, 12, 13, 14, 15, or 20; or between 11 and 12, 13, 14, 15, or 20; or between 12 and 13, 14, 15, or 20; or between 13 and 14, 15, or 20; or between 14 and 15, or 20; or between 15 and 20; B is between 0.1 and 0.2, 0.3, 0.4, 0.5, 0.6, 0.7, 0.8, 0.9, 1, 1.5, 2, 2.5, 3, 3.5, 4, 4.5, 5, 6, 7, 8, 9, 10, 11, 12, 13, 14, 15, or 20; or between 0.2 and 0.3, 0.4, 0.5, 0.6, 0.7, 0.8, 0.9, 1, 1.5, 2, 2.5, 3, 3.5, 4, 4.5, 5, 6, 7, 8, 9, 10, 11, 12, 13, 14, 15, or 20; or between 0.3 and 0.4, 0.5, 0.6, 0.7, 0.8, 0.9, 1, 1.5, 2, 2.5, 3, 3.5, 4, 4.5, 5, 6, 7, 8, 9, 10, 11, 12, 13, 14, 15, or 20; or between 0.4 and 0.5, 0.6, 0.7, 0.8, 0.9, 1, 1.5, 2, 2.5, 3, 3.5, 4, 4.5, 5, 6, 7, 8, 9, 10, 11, 12, 13, 14, 15, or 20; or between 0.5 and 0.6, 0.7, 0.8, 0.9, 1, 1.5, 2, 2.5, 3, 3.5, 4, 4.5, 5, 6, 7, 8, 9, 10, 11, 12, 13, 14, 15, or 20; or between 0.6 and 0.7, 0.8, 0.9, 1, 1.5, 2, 2.5, 3, 3.5, 4, 4.5, 5, 6, 7, 8, 9, 10, 11, 12, 13, 14, 15, or 20; or between 0.7 and 0.8, 0.9, 1, 1.5, 2, 2.5, 3, 3.5, 4, 4.5, 5, 6, 7, 8, 9, 10, 11, 12, 13, 14, 15, or 20; or between 0.8 and 0.9, 1, 1.5, 2, 2.5, 3, 3.5, 4, 4.5, 5, 6, 7, 8, 9, 10, 11, 12, 13, 14, 15, or 20; or between 0.9 and 1, 1.5, 2, 2.5, 3, 3.5, 4, 4.5, 5, 6, 7, 8, 9, 10, 11, 12, 13, 14, 15, or 20; or between 1 and 1.5, 2, 2.5, 3, 3.5, 4, 4.5, 5, 6, 7, 8, 9, 10, 11, 12, 13, 14, 15, or 20; or between 1.5 and 2, 2.5, 3, 3.5, 4, 4.5, 5, 6, 7, 8, 9, 10, 11, 12, 13, 14, 15, or 20; or between 2 and 2.5, 3, 3.5, 4, 4.5, 5, 6, 7, 8, 9, 10, 11, 12, 13, 14, 15, or 20; or between 2.5 and 3, 3.5, 4, 4.5, 5, 6, 7, 8, 9, 10, 11, 12, 13, 14, 15, or 20; or between 3 and 3.5, 4, 4.5, 5, 6, 7, 8, 9, 10, 11, 12, 13, 14, 15, or 20; or between 3.5 and 4, 4.5, 5, 6, 7, 8, 9, 10, 11, 12, 13, 14, 15, or 20; or between 4 and 4.5, 5, 6, 7, 8, 9, 10, 11, 12, 13, 14, 15, or 20; or between 4.5 and 5, 6, 7, 8, 9, 10, 11, 12, 13, 14, 15, or 20; or between 5 and 6, 7, 8, 9, 10, 11, 12, 13, 14, 15, or 20; or between 6 and 7, 8, 9, 10, 11, 12, 13, 14, 15, or 20; or between 7 and 8, 9, 10, 11, 12, 13, 14, 15, or 20; or between 8 and 9, 10, 11, 12, 13, 14, 15, or 20; or between 9 and 10, 11, 12, 13, 14, 15, or 20; or between 10 and 11, 12, 13, 14, 15, or 20; or between 11 and 12, 13, 14, 15, or 20; or between 12 and 13, 14, 15, or 20; or between 13 and 14, 15, or 20; or between 14 and 15, or 20; or between 15 and 20; C is, where applicable, between 0.1 and 0.2, 0.3, 0.4, 0.5, 0.6, 0.7, 0.8, 0.9, 1, 1.5, 2, 2.5, 3, 3.5, 4, 4.5, 5, 6, 7, 8, 9, 10, 11, 12, 13, 14, 15, or 20; or between 0.2 and 0.3, 0.4, 0.5, 0.6, 0.7, 0.8, 0.9, 1, 1.5, 2, 2.5, 3, 3.5, 4, 4.5, 5, 6, 7, 8, 9, 10, 11, 12, 13, 14, 15, or 20; or between 0.3 and 0.4, 0.5, 0.6, 0.7, 0.8, 0.9, 1, 1.5, 2, 2.5, 3, 3.5, 4, 4.5, 5, 6, 7, 8, 9, 10, 11, 12, 13, 14, 15, or 20; or between 0.4 and 0.5, 0.6, 0.7, 0.8, 0.9, 1, 1.5, 2, 2.5, 3, 3.5, 4, 4.5, 5, 6, 7, 8, 9, 10, 11, 12,

13, 14, 15, or 20; or between 0.5 and 0.6, 0.7, 0.8, 0.9, 1, 1.5, 2, 2.5, 3, 3.5, 4, 4.5, 5, 6, 7, 8, 9, 10, 11, 12, 13, 14, 15, or 20; or between 0.6 and 0.7, 0.8, 0.9, 1, 1.5, 2, 2.5, 3, 3.5, 4, 4.5, 5, 6, 7, 8, 9, 10, 11, 12, 13, 14, 15, or 20; or between 0.7 and 0.8, 0.9, 1, 1.5, 2, 2.5, 3, 3.5, 4, 4.5, 5, 6, 7, 8, 9, 10, 11, 12, 13, 14, 15, or 20; or between 0.8 and 0.9, 1, 1.5, 2, 2.5, 3, 3.5, 4, 4.5, 5, 6, 7, 8, 9, 10, 11, 12, 13, 14, 15, or 20; or between 0.9 and 1, 1.5, 2, 2.5, 3, 3.5, 4, 4.5, 5, 6, 7, 8, 9, 10, 11, 12, 13, 14, 15, or 20; or between 1 and 1.5, 2, 2.5, 3, 3.5, 4, 4.5, 5, 6, 7, 8, 9, 10, 11, 12, 13, 14, 15, or 20; or between 1.5 and 2, 2.5, 3, 3.5, 4, 4.5, 5, 6, 7, 8, 9, 10, 11, 12, 13, 14, 15, or 20; or between 2 and 2.5, 3, 3.5, 4, 4.5, 5, 6, 7, 8, 9, 10, 11, 12, 13, 14, 15, or 20; or between 2.5 and 3, 3.5, 4, 4.5, 5, 6, 7, 8, 9, 10, 11, 12, 13, 14, 15, or 20; or between 3 and 3.5, 4, 4.5, 5, 6, 7, 8, 9, 10, 11, 12, 13, 14, 15, or 20; or between 3.5 and 4, 4.5, 5, 6, 7, 8, 9, 10, 11, 12, 13, 14, 15, or 20; or between 4 and 4.5, 5, 6, 7, 8, 9, 10, 11, 12, 13, 14, 15, or 20; or between 4.5 and 5, 6, 7, 8, 9, 10, 11, 12, 13, 14, 15, or 20; or between 5 and 6, 7, 8, 9, 10, 11, 12, 13, 14, 15, or 20; or between 6 and 7, 8, 9, 10, 11, 12, 13, 14, 15, or 20; or between 7 and 8, 9, 10, 11, 12, 13, 14, 15, or 20; or between 8 and 9, 10, 11, 12, 13, 14, 15, or 20; or between 9 and 10, 11, 12, 13, 14, 15, or 20; or between 10 and 11, 12, 13, 14, 15, or 20; or between 11 and 12, 13, 14, 15, or 20; or between 12 and 13, 14, 15, or 20; or between 13 and 14, 15, or 20; or between 14 and 15, or 20; or between 15 and 20; and D is, where applicable, between 0.1 and 0.2, 0.3, 0.4, 0.5, 0.6, 0.7, 0.8, 0.9, 1, 1.5, 2, 2.5, 3, 3.5, 4, 4.5, 5, 6, 7, 8, 9, 10, 11, 12, 13, 14, 15, or 20; or between 0.2 and 0.3, 0.4, 0.5, 0.6, 0.7, 0.8, 0.9, 1, 1.5, 2, 2.5, 3, 3.5, 4, 4.5, 5, 6, 7, 8, 9, 10, 11, 12, 13, 14, 15, or 20; or between 0.3 and 0.4, 0.5, 0.6, 0.7, 0.8, 0.9, 1, 1.5, 2, 2.5, 3, 3.5, 4, 4.5, 5, 6, 7, 8, 9, 10, 11, 12, 13, 14, 15, or 20; or between 0.4 and 0.5, 0.6, 0.7, 0.8, 0.9, 1, 1.5, 2, 2.5, 3, 3.5, 4, 4.5, 5, 6, 7, 8, 9, 10, 11, 12, 13, 14, 15, or 20; or between 0.5 and 0.6, 0.7, 0.8, 0.9, 1, 1.5, 2, 2.5, 3, 3.5, 4, 4.5, 5, 6, 7, 8, 9, 10, 11, 12, 13, 14, 15, or 20; or between 0.6 and 0.7, 0.8, 0.9, 1, 1.5, 2, 2.5, 3, 3.5, 4, 4.5, 5, 6, 7, 8, 9, 10, 11, 12, 13, 14, 15, or 20; or between 0.7 and 0.8, 0.9, 1, 1.5, 2, 2.5, 3, 3.5, 4, 4.5, 5, 6, 7, 8, 9, 10, 11, 12, 13, 14, 15, or 20; or between 0.8 and 0.9, 1, 1.5, 2, 2.5, 3, 3.5, 4, 4.5, 5, 6, 7, 8, 9, 10, 11, 12, 13, 14, 15, or 20; or between 0.9 and 1, 1.5, 2, 2.5, 3, 3.5, 4, 4.5, 5, 6, 7, 8, 9, 10, 11, 12, 13, 14, 15, or 20; or between 1 and 1.5, 2, 2.5, 3, 3.5, 4, 4.5, 5, 6, 7, 8, 9, 10, 11, 12, 13, 14, 15, or 20; or between 1.5 and 2, 2.5, 3, 3.5, 4, 4.5, 5, 6, 7, 8, 9, 10, 11, 12, 13, 14, 15, or 20; or between 2 and 2.5, 3, 3.5, 4, 4.5, 5, 6, 7, 8, 9, 10, 11, 12, 13, 14, 15, or 20; or between 2.5 and 3, 3.5, 4, 4.5, 5, 6, 7, 8, 9, 10, 11, 12, 13, 14, 15, or 20; or between 3 and 3.5, 4, 4.5, 5, 6, 7, 8, 9, 10, 11, 12, 13, 14, 15, or 20; or between 3.5 and 4, 4.5, 5, 6, 7, 8, 9, 10, 11, 12, 13, 14, 15,

or 20; or between 4 and 4.5, 5, 6, 7, 8, 9, 10, 11, 12, 13, 14, 15, or 20; or between 4.5 and 5, 6, 7, 8, 9, 10, 11, 12, 13, 14, 15, or 20; or between 5 and 6, 7, 8, 9, 10, 11, 12, 13, 14, 15, or 20; or between 6 and 7, 8, 9, 10, 11, 12, 13, 14, 15, or 20; or between 7 and 8, 9, 10, 11, 12, 13, 14, 15, or 20; or between 8 and 9, 10, 11, 12, 13, 14, 15, or 20; or between 9 and 10, 11, 12, 13, 14, 15, or 20; or between 10 and 11, 12, 13, 14, 15, or 20; or between 11 and 12, 13, 14, 15, or 20; or between 12 and 13, 14, 15, or 20; or between 13 and 14, 15, or 20; or between 14 and 15, or 20; or between 15 and 20 ; and the adjustment factor is, where applicable, positive or negative and may be infinitely large or infinitely small. In some embodiments, A, B, C, and/or D, is within rounding of any of these values (e.g., A is between 0.45 and 0.54, etc.).

[00117] As used herein, a patient has an “increased likelihood” of some clinical feature or outcome (e.g., having melanoma) if the probability of the patient having the feature or outcome exceeds some reference probability or value. The reference probability may be the probability of the feature or outcome across the general relevant patient population. For example, if the probability of having melanoma in the general population is X% and a particular patient has been determined by the methods of the present invention to have a probability of Y% of having melanoma, and if $Y > X$, then the patient has an “increased likelihood” of having melanoma. Alternatively, as discussed above, a threshold or reference value may be determined and a particular patient’s probability of having melanoma may be compared to that threshold or reference.

[00118] In some embodiments the method correlates the patient’s specific score (e.g., CCP score, combined score of CCP with clinical variables) to a specific probability (e.g., 10%, 15%, 20%, 25%, 30%, 35%, 40%, 45%, 50%, 55%, 60%, 65%, 70%, 75%, 80%, 85%, 90%, 95%, 99%, 100%) or likelihood of having melanoma.

[00119] In some embodiments the method includes classifying the sample as benign, malignant, or indeterminate based at least in part on comparing the test score to one or more reference scores. In some embodiments a test score below both a first and a second reference score indicates the sample is benign. In some embodiments a sample is classified as indeterminate where the test score is between a first and a second reference. In some embodiments a test score above both a first and a second reference score indicates the sample is benign. In some embodiments the test score and reference scores may be transformed such that a

a test score above both a first and a second reference score indicates the sample is malignant, and a test score below both a first and a second reference score indicates the sample is benign. In some embodiments, the method of diagnosis includes (1) obtaining a sample from a patient suspected of having melanoma; (2) determining the expression of a panel of genes in the sample; (3) calculating test values or scores; and (4) providing a report communicating the test value or scores. In some embodiments the report is a paper report, an auditory report, or an electronic record. In some embodiments the report is displayed and/or stored on a computing device (e.g., handheld device, desktop computer, smart device, website, etc.). In some embodiments the report is communicated to a physician (e.g., a report communicating the test values or scores is provided to the physician). In some embodiments the report is communicated to a patient (e.g., a report communicating the test values or scores is provided to the patient). Providing a report can also be accomplished by transferring information (e.g., data) embodying the test values or scores to a server computer and allowing an intermediary or end-user to access such information (e.g., by viewing the information as displayed from the server, by downloading the information in the form of one or more files transferred from the server to the intermediary or end-user's device, etc.).

[00120] In other embodiments, the report may communicate scores derived from different sources and other relevant patient information. For example, the report may communicate scores derived solely from expression levels. The report may also report the scores as calculated by formula (1) formula (2), formula (3), and/or formula (4). Alternately, the report may communicate scores derived from a combination of expression value scores with other components (e.g. clinical staging, personal/family history, dermatopathology results, etc.) to give a potentially more comprehensive score. In other cases, the report can communicate multiple scores (e.g. expression test value and clinical parameters, such as clinical staging) and/or a more comprehensive score. The report can also communicate scores for individual genes. In some instances, the report can communicate scores along with control or reference values. Some reports may communicate a specific probability (e.g., 10%, 15%, 20%, 25%, 30%, 35%, 40%, 45%, 50%, 55%, 60%, 65%, 70%, 75%, 80%, 85%, 90%, 95%, 99%, 100%) or likelihood of having melanoma. Other reports may communicate classification of the sample as benign or

malignant, predictions of melanoma risk, comparisons of melanoma risk, clinically actionable items, recommendations for cancer risk management and/or recommendations for treatment. Yet other reports may include personal and family medical history.

[00121] In another embodiment, melanoma is diagnosed utilizing loss of heterozygosity or allelic imbalance. In some embodiments, loss of heterozygosity (LOH) at one or more specified genomic locations is indicative that an individual is suffering from melanoma. In some embodiments, allelic imbalance (AI) at one or more specified genomic locations is indicative that an individual is suffering from melanoma. In some embodiments, DNA from a tissue sample is analyzed to determine the presence of LOH. In some embodiments, DNA from a tissue sample is analyzed to determine the presence of AI.

[00122] In some embodiments, the present disclosure provides for a method of diagnosing melanoma in an individual comprising:

- (1) assaying DNA from a tissue sample to determine the presence of loss of heterozygosity (LOH) at one or more specified genomic locations; and
- (2) diagnosing the individual as suffering from melanoma.

[00123] In some related embodiments, the tissue sample is a skin lesion or part of a skin lesion suspected of being cancerous. In another related embodiment, the tissue sample comprises one or more cells derived from the skin of the individual.

[00124] In some related embodiments, DNA is assayed by sequencing. In some embodiments, LOH is determined by comparing SNPs. In some embodiments, SNPs are analyzed at specified genomic locations. In some embodiments, there is one specified genomic location. In some embodiments, there are two specified genomic locations. In some embodiments, there are three specified genomic locations. In some embodiments, there are four specified genomic locations. In some embodiments, there are five specified genomic locations. In some embodiments, there are six specified genomic locations.

[00125] In related embodiments, the genomic locations for SNP analysis to determine LOH are selected from those in Table 17. In some embodiments, the genomic locations comprise the telomere of the q arm of chromosome 1. In a related embodiment, the genomic region to analyze is on chromosome 1 from genomic coordinates 171656124 to the end of the chromosome.

[00126] In some embodiments, the genomic locations comprise the region near the telomere of the q arm of chromosome 5. In a related embodiment, the genomic region to analyze is on chromosome 5 from genomic coordinates 137789519 to 158830819.

[00127] In some embodiments, the genomic locations comprise the q arm of chromosome 6. In a related embodiment, the genomic region to analyze is on chromosome 6 from genomic coordinates 65332657 to the end of the chromosome.

[00128] In some embodiments, the genomic locations comprise the region around the gene CDKN2A. In a related embodiment, the genomic region to analyze is the entire chromosome 9.

[00129] In some embodiments, the genomic locations comprise the q arm of chromosome 10. In a related embodiment, the genomic region to analyze is the entire chromosome 10.

[00130] In some embodiments, the genomic locations comprise the telomere of the q arm of chromosome 11. In a related embodiment, the genomic region to analyze is on chromosome 11 from genomic coordinates 82562486 to the end of the chromosome.

[00131] In some embodiments, the present disclosure provides for a method of diagnosing melanoma in an individual comprising:

- (1) assaying DNA from a tissue sample to determine the presence of allelic imbalance (AI) at one or more specified genomic locations; and
- (2) diagnosing the individual as suffering from melanoma.

[00132] In some related embodiments, the tissue sample is a skin lesion or part of a skin lesion suspected of being cancerous. In another related embodiment, the tissue sample comprises one or more cells derived from the skin of the individual.

[00133] In some related embodiments, DNA is assayed by sequencing. In some embodiments, AI is determined by comparing SNPs. In some embodiments, SNPs are analyzed at specified genomic locations. In some embodiments, there is one specified genomic location. In some embodiments, there are two specified genomic locations. In some embodiments, there are three specified genomic locations. In some embodiments, there are four specified genomic locations. In some embodiments, there are five specified genomic locations. In some embodiments, there are six specified genomic locations.

[00134] In related embodiments, the genomic locations for SNP analysis to determine AI are selected from those in Table 17. In some embodiments, the genomic locations comprise the telomere of the q arm of chromosome 1. In a related embodiment, the genomic region to analyze is on chromosome 1 from genomic coordinates 171656124 to the end of the chromosome.

[00135] In some embodiments, the genomic locations comprise the region near the telomere of the q arm of chromosome 5. In a related embodiment, the genomic region to analyze is on chromosome 5 from genomic coordinates 137789519 to 158830819.

[00136] In some embodiments, the genomic locations comprise the q arm of chromosome 6. In a related embodiment, the genomic region to analyze is on chromosome 6 from genomic coordinates 65332657 to the end of the chromosome.

[00137] In some embodiments, the genomic locations comprise the region around the gene CDKN2A. In a related embodiment, the genomic region to analyze is the entire chromosome 9.

[00138] In some embodiments, the genomic locations comprise the q arm of chromosome 10. In a related embodiment, the genomic region to analyze is the entire chromosome 10.

[00139] In some embodiments, the genomic locations comprise the telomere of the q arm of chromosome 11. In a related embodiment, the genomic region to analyze is on chromosome 11 from genomic coordinates 82562486 to the end of the chromosome.

[00140] In some embodiments, LOH or AI are combined with RNA expression analysis as described above to diagnose melanoma. In a related embodiment, a determination of RNA expression and LOH or AI allows a specificity of at least 99% in detecting melanoma from a tissue sample.

Methods of Treating Melanoma

[00141] In one aspect, the present invention provides methods of treating a patient comprising obtaining gene expression status information for a panel of genes (e.g., obtained by the method described herein), and recommending a treatment, prescribing a treatment, administering a treatment, creating a treatment plan, or modifying a treatment plan for the patient based on the gene expression status. In some embodiments, the method comprises obtaining CCG expression status. In some embodiments, the method comprises obtaining immune gene expression status. In some embodiments, the method comprises obtaining expression status for additional genes as described herein. For example, the invention provides a method of treating a patient comprising:

- (1) determining the status of at least one CCG;
- (2) determining the status of at least one immune gene;
- (3) determining the status of at least one additional gene; and
- (4) recommending, prescribing or administering either
 - (a) an active (including aggressive) treatment if the patient has at least one of increased expression of the CCG, increased expression of immune gene, or expression of an additional gene that differs significantly from expression in a control sample, or
 - (b) a passive (or less aggressive) treatment if the patient has none of increased expression of the CCG, increased expression of immune gene, or expression of an additional gene that differs significantly from expression in a control sample.

[00142] In a related embodiment, the invention provides a method of treating a patient comprising:

- (1) determining the status of at least one immune gene;
- (2) determining the status of at least one additional gene; and
- (3) recommending, prescribing or administering either
 - (a) an active (including aggressive) treatment if the patient has at least one of increased expression of immune gene, or expression of an additional gene that differs significantly from expression in a control sample, or

[00143] (b) a passive (or less aggressive) treatment if the patient has none of increased expression of immune gene, or expression of an additional gene that differs significantly from expression in a control sample. In a related embodiment, the invention provides a method of treating a patient comprising:

- (1) determining the status of at least one immune gene;
- (2) determining the status of at least one additional gene; and
- (3) creating a treatment plan comprising either
 - (a) more aggressive therapy components if the patient has at least one of increased expression of immune gene, or expression of an additional gene that differs significantly from expression in a control sample, or
 - (b) less aggressive therapy components if the patient has none of increased expression of immune gene, or expression of an additional gene that differs significantly from expression in a control sample; and
- (4) implementing the treatment plan.

[00144] In one aspect, the present invention provides methods of treating a patient comprising obtaining gene expression status information for a panel of genes (e.g., obtained by the method described herein), and recommending a treatment, prescribing a treatment, administering a treatment, creating a treatment plan, or modifying a treatment plan for the patient based on the gene expression status. In some embodiments, the method comprises obtaining CCG expression status. In some embodiments, the method comprises obtaining immune gene expression status. In some embodiments, the method comprises obtaining expression status for additional genes as

described herein. For example, the invention provides a method of treating a patient comprising:

- (1) determining the status of at least one CCG;
- (2) determining the status of at least one immune gene;
- (3) determining the status of at least one additional gene; and
- (4) recommending, prescribing or administering any of
 - (a) an active (including aggressive) treatment if the patient has at least one of increased expression of the CCG, increased expression of immune gene, or expression of an additional gene that differs significantly from expression in a control sample,
 - (b) a passive (or less aggressive) treatment if the patient has none of increased expression of the CCG, increased expression of immune gene, or expression of an additional gene that differs significantly from expression in a control sample,
 - (c) an intermediary treatment plan if the patient has some mixed increased, decreased or neutral expression of the CCG, immune or additional genes compared to the expression in a control sample.

[00145] In a related embodiment, the invention provides a method of treating a patient comprising:

- (1) determining the status of at least one immune gene;
- (2) determining the status of at least one additional gene; and
- (3) recommending, prescribing or administering any of
 - (a) an active (including aggressive) treatment if the patient has at least one of increased expression of immune gene, or expression of an additional gene that differs significantly from expression in a control sample, or
 - (b) a passive (or less aggressive) treatment if the patient has none of increased expression of immune gene, or expression of an additional gene that differs significantly from expression in a control sample, or
 - (c) an intermediate treatment if the patients has some mixed increased, decreased or neutral expression of the CCG, immune or additional genes compared to the expression in a control sample.

[00146] In a related embodiment, the invention provides a method of treating a patient comprising:

- (1) determining the status of at least one immune gene;
- (2) determining the status of at least one additional gene; and
- (3) creating a treatment plan comprising any of
 - (a) more aggressive therapy components if the patient has at least one of increased expression of immune gene, or expression of an additional gene that differs significantly from expression in a control sample, or
 - (b) less aggressive therapy components if the patient has none of increased expression of immune gene, or expression of an additional gene that differs significantly from expression in a control sample, or
 - (c) an intermediate treatment if the patients has some mixed increased, decreased or neutral expression of the CCG, immune or additional genes compared to the expression in a control sample; and
- (4) implementing the treatment plan.

[00147] Thus, in general, methods of treatment may comprise a step of administering treatment. Additionally, in some embodiments, methods of treatment comprise a step of creating a treatment plan. In some embodiments, treatment is altered to more aggressive treatment. In some embodiments, treatment is altered to less aggressive treatment.

[00148] In some embodiments, the recommending, prescribing, or administering steps comprise receiving a report communicating the relevant expression status (e.g., CCG status). In some embodiments, the creating a treatment plan step comprises receiving a report communicating the relevant expression status (e.g., CCG status). In some embodiments this report communicates such status in a qualitative manner (e.g., “high” or “increased” expression). In some embodiments this report communicates such status indirectly by communicating a test value or score (e.g., score reflecting likelihood of having melanoma, etc.) that incorporates such status.

[00149] Whether a treatment is aggressive or not will generally depend on the diagnosis or likelihood of having melanoma. For individuals diagnosed with melanoma, or having a high

likelihood of having melanoma, aggressive treatment is preferred. Those skilled in the art are familiar with various other aggressive and less aggressive treatments for each type of cancer. On the other hand, if an individual has a low likelihood of having melanoma, a less aggressive therapy could be prescribed. Therefore, for an individual having a low risk of having melanoma, a medical provider could recommend a regime of “watchful-waiting.” If an individual has an indeterminate likelihood of having melanoma, further testing could be prescribed. Therefore, for an individual having an indeterminate score, a medical provider could recommend further testing of the lesion.

[00150] A range of melanoma treatments and/or therapies are known by those skilled in the art. This range of melanoma therapies can vary in their aggressiveness. In general, as the melanoma therapy increases in aggressiveness, the effectiveness of the treatment increases, but the adverse effects to the patient also increases. Skilled artisans can understand that the aggressiveness of the melanoma therapy that is used to treat the patient must be balanced to take into account both the effectiveness of the treatment and the adverse effects that will likely be experienced by the patient. Therefore, the skilled artisan will seek to maximize the effectiveness of the treatment while minimizing the adverse effects of the treatment by selecting an appropriate level of aggressiveness tailored to the individual patient. The appropriate level of treatment can be selected based at least in part on the report communicating the relevant expression status.

[00151] In some embodiments, a skilled artisan can incorporate the report communicating the relevant expression status into the selection of aggressiveness of treatment. A report communicating a score indicating a high likelihood of melanoma would indicate a more aggressive treatment while a report communicating a score indicating a lower likelihood of melanoma would indicate a less aggressive treatment. In some embodiments, a less aggressive treatment may comprise the removal of the suspected melanoma during a biopsy. In some embodiments, a more aggressive treatment may include removal of the suspected melanoma as well as removal of a small border of normal skin and a layer of tissue beneath both the suspected melanoma and the small border of skin. In other embodiments, a more aggressive treatment may comprise a reexcision of the biopsy site to remove additional tissue that borders the removed biopsy sample. In yet other embodiments, a more aggressive treatment may comprise reexcision of additional tissue surrounding the biopsy site.

[00152] In other embodiments an even more aggressive treatment may include surgery to remove any affected lymph nodes or a lymph node dissection (lymphadenectomy). In other embodiments an even more aggressive treatment may include surgery to remove any affected lymph nodes or a lymph node dissection (lymphadenectomy) followed by adjuvant therapy with interferon. In other embodiments, an even more aggressive treatment may include surgery to remove any affected lymph nodes as well as additional treatments such as chemotherapy and/or radiation therapy. In other embodiments, an even more aggressive treatment can include surgery to remove any affected tissue or organs. In alternate embodiments, even more aggressive treatments can include chemotherapy. Some methods of administering chemotherapy include oral and intravenous treatments. Some methods of administering chemotherapy include isolated limb perfusion of chemotherapy drugs. In other embodiments, even more aggressive treatments can include radiation therapy. In yet other embodiments, even more aggressive treatments can include biological therapy. Some biological therapies can include interferon and/or interleukin-2. Some biological therapies can include antibody-based therapies such as ipilimumab (Yervoy). In other embodiments, even more aggressive therapy can include immunotherapy. Some immunotherapies can include Interferon-alpha, Anti-CTLA-4, vaccines, Bacille Calmette-Guerin vaccine, Interleukin 2, and/or T-cell therapy. Some immunotherapies can also be combined with chemotherapy and/or radiation therapy. In alternate embodiments, even more aggressive therapies can include targeted therapy. Some targeted therapies can include drugs such as vemurafenib (Zelboraf) used to treat advanced melanoma. Other targeted therapies include B-RAF inhibitors and/or KIT inhibitors.

[00153] In some embodiments, the selection of the specific treatment can be based in part on the relative expression status of the tested genes. For example in some embodiments, the expression profile of the individual genes within the panel would be indicative of the selection of the type and/or the class of therapy. A certain expression profile of the individual genes within the panel may be indicative of melanoma that can be effectively treated with surgery alone. On the other hand, another expression profile may be indicative of melanoma that can be effectively treated with surgery combined with radiation therapy. In other cases, another expression profile may be indicative of melanoma that can be effectively treated with surgery combined with chemotherapy. In yet other cases, the expression profile may be indicative of melanoma that can be effectively treated with only careful monitoring and regular follow-up. In alternate

embodiments, the expression profile might be indicative of melanoma that can be effectively treated with higher dosages of therapy administered at shorter intervals whereas other expression profiles might be indicative of lower dosages of therapy administered at longer intervals. In some embodiments, the expression profile may indicate certain combinations, dosages, and/or frequencies of therapies.

[00154] In other embodiments, a skilled artisan can utilize at least in part the report communicating the relevant expression status to guide the selection of appropriate melanoma drugs. For example in some embodiments, the expression profile of the individual genes within the panel may be indicative of the selection of particular melanoma drugs. In some embodiments melanoma drugs may be selected from Aldesleukin, Dabrafenib, Dacarbazine, DTIC-Dome (Dacarbazine), Intron A (Recombinant Interferon Alfa-2b), Ipilimumab, Mekinist (Trametinib), Peginterferon Alfa-2b, PEG-Intron (Peginterferon Alfa-2b), Proleukin (Aldesleukin), Recombinant Interferon Alfa-2b, Sylatron (Peginterferon Alfa-2b), Tafinlar (Dabrafenib), Trametinib, Vemurafenib, Yervoy (Ipilimumab), and/or Zelboraf (Vemurafenib). In other embodiments, melanoma drugs may be selected from Bacille Calmette-Guerin (BCG) vaccine, interleukin-2, imiquimod, cytokines, dacarbazine (DTIC), temozolomide (Temodar), mitogen-activated protein kinase kinase (MEK) inhibitor (trametinib), and/or beta-adrenergic-blocking drugs.

[00155] In some embodiments, patients with melanoma can be treated by selecting the relative aggressiveness of the melanoma therapy based at least in part on the report communicating the relevant expression status (or test values or scores) and then administering this selected therapy. In other embodiments, patients with melanoma can be treated by selecting the relative aggressiveness of the melanoma therapy based at least in part on the report communicating the relevant expression status, administering this selected therapy, measuring the relevant expression status again, comparing the latter expression status with the previous expression status, and continuing or modifying treatment based on the comparison of the previous and latter expression status. In alternate embodiments, the comparison of the relevant expression status can be used to monitor the efficacy of treatment. In some cases a change in the relevant expression status from a score indicative of a higher likelihood of melanoma to a score indicative of a lower likelihood of melanoma may indicate that the treatment is effective. In other cases a change in the relevant expression status from a score indicative of a lower

likelihood of melanoma to a score indicative of a higher likelihood of melanoma may indicate that the treatment is less effective. Where a change in the expression status indicates an effective treatment the treatment may be continued or modified to comprise a less aggressive treatment. Where a change in the expression status indicates a less effective treatment the treatment may be continued or modified to comprise a more aggressive treatment.

[00156] In yet other embodiments, the skilled artisan can create or modify a treatment plan for the individual patient based at least in part on the report communicating the relevant expression status. In some embodiments, the selection of different therapy components that comprise the treatment plan can be based at least in part on the report communicating the relevant expression status (or test values or scores). For example, in some instances, the report will indicate a low likelihood of melanoma and the treatment plan may comprise less aggressive therapy components. The less aggressive therapy components can include removal of the suspected melanoma and follow up monitoring of the patient. In other cases, the report may indicate a high likelihood of melanoma and the treatment plan may comprise more aggressive therapy components. Components of a more aggressive treatment plan can include removal of the suspected melanoma and surrounding tissue, reexcision of the biopsy site to remove additional surrounding tissue, chemotherapy, radiation therapy and/or biological therapy. In alternate embodiments, the report communicating the relevant expression status can be used in part to select the different elements within each component of the treatment plan. As a non-limiting example, the report can be used to select individual melanoma drugs that comprise the chemotherapy component of the treatment plan. In other non-limiting examples, the report can be used to select the types of radiation, the amounts of radiation, and/or the dosing regime of the radiation component of the treatment plan. In some embodiments, the treatment plan can further comprise continued measurement of the relevant expression status to determine the efficacy of the treatment plan. In other embodiments, this continued measurement of the efficacy of treatment can be used to modify the treatment plan.

[00157] In some embodiments of a method of treating melanoma, the decision to treat is based at least in part on a RNA expression score as described herein. In some embodiments, of a method of treating melanoma, the decision to treat is based at least in part on a determination of LOH as described herein. In some embodiments, of a method of treating melanoma, the decision to treat is based at least in part on a determination of AI as described herein

Systems for Diagnosing and Treating Melanoma

[00158] The results of any analyses according to the invention will often be communicated to physicians, genetic counselors and/or patients (or other interested parties such as researchers) in a transmittable form that can be communicated or transmitted to any of the above parties. Such a form can vary and can be tangible or intangible. The results can be embodied in descriptive statements, diagrams, photographs, charts, images or any other visual forms. For example, graphs showing expression or activity level or sequence variation information for various genes can be used in explaining the results. Diagrams showing such information for additional target gene(s) are also useful in indicating some testing results. The statements and visual forms can be recorded on a tangible medium such as papers, computer readable media such as floppy disks, compact disks, etc., or on an intangible medium, e.g., an electronic medium in the form of email or website on internet or intranet. In addition, results can also be recorded in a sound form and transmitted through any suitable medium, e.g., analog or digital cable lines, fiber optic cables, etc., via telephone, facsimile, wireless mobile phone, internet phone and the like.

[00159] Thus, the information and data on a test result can be produced anywhere in the world and transmitted to a different location. As an illustrative example, when an expression level, activity level, or sequencing (or genotyping) assay is conducted outside the United States, the information and data on a test result may be generated, cast in a transmittable form as described above, and then imported into the United States. Accordingly, the present invention also encompasses a method for producing a transmittable form of information on at least one of (a) expression level or (b) activity level for at least one patient sample. The method comprises the steps of (1) determining at least one of (a) or (b) above according to methods of the present invention; and (2) embodying the result of the determining step in a transmittable form. The transmittable form is the product of such a method.

[00160] Techniques for analyzing such expression, activity, and/or sequence data (indeed any data obtained according to the invention) will often be implemented using hardware, software or a combination thereof in one or more computer systems or other processing systems capable of effectuating such analysis.

[00161] Thus, the present invention further provides a system for determining gene expression in a tumor sample, comprising: (1) a sample analyzer for determining the expression levels of a panel of genes in a patient sample, wherein the sample analyzer contains the patient sample, or cDNA molecules from mRNA expressed of the panel of genes derived from the sample; (2) a first computer program for (a) receiving gene expression data from the panel of genes, (b) weighting the determined expression of each of the test genes, and (c) combining the weighted expression to provide a test value; and optionally (3) a second computer program for comparing the test value to one or more reference values each associated with a predetermined degree of risk of melanoma.

[00162] In another embodiment, the amount of RNA transcribed from the panel of genes including test genes is measured in the sample. In addition, the amount of RNA of one or more housekeeping genes in the sample is also measured, and used to normalize or calibrate the expression of the test genes, as described above.

[00163] The sample analyzer can be any instruments useful in determining gene expression, including, e.g., a sequencing machine, a real-time PCR machine, and a microarray instrument.

[00164] The computer-based analysis function can be implemented in any suitable language and/or browsers. For example, it may be implemented with C language and preferably using object-oriented high-level programming languages such as Visual Basic, SmallTalk, C++, and the like. The application can be written to suit environments such as the Microsoft WindowsTM environment including WindowsTM 98, WindowsTM 2000, WindowsTM NT, and the like. In addition, the application can also be written for the MacIntoshTM, SUNTM, UNIX or LINUX environment. In addition, the functional steps can also be implemented using a universal or platform-independent programming language. Examples of such multi-platform programming languages include, but are not limited to, hypertext markup language (HTML), JAVATM, JavaScriptTM, Flash programming language, common gateway interface/structured query language (CGI/SQL), practical extraction report language (PERL), AppleScriptTM and other system script languages, programming language/structured query language (PL/SQL), and the like. JavaTM- or JavaScriptTM-enabled browsers such as HotJavaTM, MicrosoftTM ExplorerTM, or

Netscape™ can be used. When active content web pages are used, they may include Java™ applets or ActiveX™ controls or other active content technologies.

[00165] The analysis function can also be embodied in computer program products and used in the systems described above or other computer- or internet-based systems. Accordingly, another aspect of the present invention relates to a computer program product comprising a computer-usable medium having computer-readable program codes or instructions embodied thereon for enabling a processor to carry out gene status analysis. These computer program instructions may be loaded onto a computer or other programmable apparatus to produce a machine, such that the instructions which execute on the computer or other programmable apparatus create means for implementing the functions or steps described above. These computer program instructions may also be stored in a computer-readable memory or medium that can direct a computer or other programmable apparatus to function in a particular manner, such that the instructions stored in the computer-readable memory or medium produce an article of manufacture including instructions which implement the analysis. The computer program instructions may also be loaded onto a computer or other programmable apparatus to cause a series of operational steps to be performed on the computer or other programmable apparatus to produce a computer implemented process such that the instructions which execute on the computer or other programmable apparatus provide steps for implementing the functions or steps described above.

[00166] Thus one aspect of the present invention provides a system for determining whether a patient has increased likelihood of having melanoma. Generally speaking, the system comprises (1) computer program for receiving, storing, and/or retrieving a patient's gene status data (e.g., expression level, activity level, variants) and optionally clinical parameter data (e.g., clinical staging); (2) computer program for querying this patient data; (3) computer program for concluding whether there is an increased likelihood of having melanoma based on this patient data; and optionally (4) computer program for outputting/displaying this conclusion. In some embodiments this computer program for outputting the conclusion may comprise a computer program for informing a health care professional of the conclusion

[00167] The practice of the present invention may also employ conventional biology methods, software and systems. Computer software products of the invention typically include

computer readable media having computer-executable Instructions for performing the logic steps of the method of the invention. Suitable computer readable medium include floppy disk, CD-ROM/DVD/DVD-ROM, hard-disk drive, flash memory, ROM/RAM, magnetic tapes and etc. Basic computational biology methods are described in, for example, Setubal et al., Introduction to Computational Biology Methods (PWS Publishing Company, Boston, 1997); Salzberg et al. (Ed.), Computational Methods in Molecular Biology, (Elsevier, Amsterdam, 1998); Rashidi & Buehler, Bioinformatics Basics: Application in Biological Science and Medicine (CRC Press, London, 2000); and Ouelette & Bzevanis, Bioinformatics: A Practical Guide for Analysis of Gene and Proteins (Wiley & Sons, Inc., 2nd ed., 2001); see also, U.S. Pat. No. 6,420,108.

[00168] The present invention may also make use of various computer program products and software for a variety of purposes, such as probe design, management of data, analysis, and instrument operation. See U.S. Pat. Nos. 5,593,839; 5,795,716; 5,733,729; 5,974,164; 6,066,454; 6,090,555; 6,185,561; 6,188,783; 6,223,127; 6,229,911 and 6,308,170. Additionally, the present invention may have embodiments that include methods for providing genetic information over networks such as the Internet as shown in U.S. Ser. Nos. 10/197,621 (U.S. Pub. No. 20030097222); 10/063,559 (U.S. Pub. No. 20020183936), 10/065,856 (U.S. Pub. No. 20030100995); 10/065,868 (U.S. Pub. No. 20030120432); 10/423,403 (U.S. Pub. No. 20040049354).

[00169] Techniques for analyzing such expression, activity, and/or sequence data (indeed any data obtained according to the invention) will often be implemented using hardware, software or a combination thereof in one or more computer systems or other processing systems capable of effectuating such analysis.

[00170] Thus one aspect of the present invention provides systems related to the above methods of the invention. In one embodiment the invention provides a system for determining gene expression in a sample, comprising:

- (1) a sample analyzer for determining the expression levels in a sample of a panel of genes, wherein the sample analyzer contains the sample, RNA from the sample and expressed from the panel of genes, or DNA synthesized from said RNA;
- (2) a first computer program for

(a) receiving gene expression data on one or more test genes selected from the panel of genes,

(b) weighting the determined expression of each of the one or more test genes with a predefined coefficient, and

(c) combining the weighted expression to provide a test value; and optionally

(3) a second computer program for comparing the test value to one or more reference values each associated with a predetermined degree of risk of having melanoma.

[00171] In another embodiment the invention provides a system for determining gene expression in a sample, comprising: (1) a sample analyzer for determining the expression levels of a panel of genes in a sample, wherein the sample analyzer contains the sample which is a nevus or mole suspected of having melanoma, RNA from the sample and expressed from the panel of genes, or DNA synthesized from said RNA; (2) a first computer program for (a) receiving gene expression data on one or more test genes selected from the panel of genes, (b) weighting the determined expression of each of the test genes with a predefined coefficient, and (c) combining the weighted expression to provide a test value, wherein the test genes comprise immune genes and additional genes; and optionally (3) a second computer program for comparing the test value to one or more reference values each associated with a predetermined degree of risk of having melanoma. In some embodiments, the system further comprises a display module displaying the comparison between the test value and the one or more reference values, or displaying a result of the comparing step, or displaying the patient's diagnosis and/or degree of risk of having melanoma.

[00172] In a preferred embodiment, the amount of RNA transcribed from the panel of genes including test genes (and/or DNA reverse transcribed therefrom) is measured in the sample. In addition, the amount of RNA of one or more housekeeping genes in the sample (and/or DNA reverse transcribed therefrom) is also measured, and used to normalize or calibrate the expression of the test genes, as described above.

[00173] The sample analyzer can be any instrument useful in determining gene expression, including, e.g., a sequencing machine (e.g., Illumina HiSeqTM, Ion Torrent

PGM, ABI SOLiD™ sequencer, PacBio RS, Helicos Heliscope™, etc.), a real-time PCR machine (e.g., ABI 7900, Fluidigm BioMark™, etc.), a microarray instrument, etc.

[00174] Figure 1 illustrates a system 100 for performing computer-assisted methods of diagnosing, detecting, screening and/or treating melanoma in a patient.

[00175] System 100 comprises a patient/medical provider interface module 10 comprising a medical provider 11 and a patient 12. The medical provider 11 comprises a doctor and/or other medical staff that care for patient 12. The medical provider collects a complete medical history from patient 12 including but not limited to symptoms, past medical history, and/or family history. The medical provider 11 also conducts a physical examination of the patient 12 and obtains a sample of the patient 12.

[00176] System 100 further comprises a data processing device 20 comprising a sample analyzer module 21. The sample of the patient is conveyed from patient/medical provider interface module 10 to the sample analyzer device 20. The sample analyzer module 21 determines the gene expression levels of a panel of biomarkers in the patient sample. The panel of biomarkers may comprise biomarkers useful for determining the presence of melanoma in the patient 12. The panel of biomarkers may further comprise housekeeper genes useful for normalizing the levels of biomarker panel. The sample analyzer module 21 can comprise any instrument useful in determining gene expression levels including, e.g. a sequencing machine (e.g., Illumina HiSeq™, Ion Torrent PGM, ABI SOLiD™ sequencer, PacBio RS, Helicos Heliscope™, etc.), a real-time PCR machine (e.g., ABI 7900, Fluidigm BioMark™, etc.), a microarray instrument, etc.

[00177] System 100 further comprises a data processing device 30 comprising a medical history database module 31. The medical history database module 31 may comprise a complete medical history from patient 12 including family history information comprising the number of family members of a patient diagnosed with cancer, including melanoma. The family history information may also comprise the degree of relationship to a patient of each family member diagnosed with cancer, including melanoma. The medical history database module 31 may be in communication with patient/medical provider interface module 10. The medical history database

module 31 may be configured to receive the patient's medical history from patient/medical provider interface module 10 either as a physical record or as an electronic transmission.

[00178] The system 100 further comprises a data processing device 40 comprising a patient information database module 41. The patient information database module 41 comprises patient information comprising gene expression levels of a panel of biomarkers of the patient 12. The patient information database module 41 may be in communication with sample analyzer module 41. The patient information database module 41 may be configured to receive the patient's gene expression levels from the sample analyzer module 21 either as a physical record or as an electronic transmission.

[00179] System 100 further comprises a data processing device 50 and a data processing device 60. Data processing device 50 comprises a scoring module 51. Data processing device 60 comprises a biomarker information database module 61. The biomarker information database module 61 comprises biomarker information comprising threshold level information for each biomarker of a panel of biomarkers, wherein the panel of biomarkers comprises positive biomarkers, negative biomarkers, or both, wherein a level statistically significantly above a threshold level for each particular positive biomarker is indicative of melanoma in a patient and a level statistically significantly below a threshold level for each particular negative biomarker is indicative of the presence of melanoma in a patient.

[00180] The scoring module 51 may be in communication with the biomarker information database module 61 and the patient information database module 41. The scoring module 51 may be configured to compare biomarker information and patient information to generate a score representing the comparison between the biomarker information and the patient information. The scoring module 51 may be further configured to normalize, average, and apply weighting of sub-groups of biomarkers during the generation of the score. The scoring module 51 may be further configured to algebraically add and/or subtract subgroups of biomarkers during the generation of the score.

[00181] The data processing device 50 may further comprise an evaluation module 52 in communication with the scoring module 51. The evaluation module 22 may further be in communication with the biomarker information database module 61. The evaluation module 52 may further be in communication the medical history database module 31. The evaluation module 52 may be configured to determine a probability of the presence of melanoma in the patient based on the patient score as compared to scores of groups of patients diagnosed with melanoma and scores of groups of patients that were not diagnosed with melanoma. The evaluation module 52 may be further configured to determine a probability of the presence of melanoma in the patient based on the patient score and the patient information. The data processing device 50 may further comprise a diagnostic module 53 in communication with the evaluation module 52. The diagnostic module 53 may be configured to determine additional suggested diagnostic procedures based on a patient's probability of melanoma. The data processing device 50 may further comprise a report generation module 54. The report generation module 54 can comprise any device that aggregates the data and process of data processing device 50 into a report. The report produced by report generation module 54 can comprise the score. The report can further comprise the probability of the presence of melanoma. The report can further comprise additional suggested diagnostic procedures. The report can further comprise suggested treatments.

[00182] System 100 further comprises a data processing device 70. Data processing device 70 comprises communication means 71. Communication means 71 is in communication with report generation module 54 and patient/medical provider interface module 10. Communication means 71 is configured to transmit the report generated by report generation module 54 to the patient/medical provider interface module 10. The report can further be transmitted by electronic means to the patient/medical provider interface module 10. Communication means 71 can also transmit the report by printing on a tangible medium such as paper and conveying the report to patient/medical provider interface module 10. Upon receiving the transmitted report, the medical provider 11 can treat the patient 12 according to the information in the report. The medical provider 11 can further diagnose the patient 12 based on the report. The medical provider 11 can further create or modify a treatment plan for the

patient 12 based on the report. The medical provider 11 can further follow the suggested additional diagnostic test from the report and/or follow the suggested treatments in the report.

[00183] Accordingly, the various components, modules, systems, and/or features disclosed herein may be embodied as modules within a system. Such a system may be implemented in software, firmware, hardware, and/or physical infrastructure. Although not always explicitly named herein, a module may be identified (named) based on a function it performs. For example, a module that is configured to calculate something may comprise specific hardware, software, or firmware and be properly referred to as a “calculation module.”

[00184] Embodiments may also be provided as a computer program product including a non-transitory machine-readable medium having stored thereon instructions that may be used to program, or be executed on, a computer (or other electronic device) to perform processes described herein. The machine-readable medium may include, but is not limited to, hard drives, floppy diskettes, optical disks, CD-ROMs, DVD-ROMs, ROMs, RAMs, EPROMs, EEPROMs, magnetic or optical cards, solid-state memory devices, or other types of media/machine-readable media suitable for storing electronic instructions. Moreover, a computer program product may be run, executed, downloaded, and/or otherwise used locally or remotely via a network.

[00185] It should be understood that references to “a data processing device” may refer to the same device or one or more different devices. For example, certain steps of the computer-assisted methods may be performed on a device controlled by a diagnostic service provider and other steps may be performed on a device controlled by a medical practitioner. Likewise, the data processing devices 10, 20, 30, 40, 50, 60, and 70 may be a single device or, for example, the data processing device 50 may be multiple data processing devices.

[00186] In certain embodiments, the computer-implemented method may be configured to identify a patient as having or not having pancreatic cancer. For example, the computer-implemented method may be configured to inform a physician that a particular patient has pancreatic cancer. Alternatively or additionally, the computer-

implemented method may be configured to actually suggest a particular course of treatment based on the answers to/results for various queries.

Probes and Kits

[00187] In some embodiments the invention provides a probe comprising an isolated oligonucleotide capable of selectively hybridizing to at least one of the genes in Table 1, 3 or Panels A through I. The terms “probe” and “oligonucleotide” (also “oligo”), when used in the context of nucleic acids, interchangeably refer to a relatively short nucleic acid fragment or sequence. The invention also provides primers useful in the methods of the invention. “Primers” are probes capable, under the right conditions and with the right companion reagents, of selectively amplifying a target nucleic acid (e.g., a target gene). In the context of nucleic acids, “probe” is used herein to encompass “primer” since primers can generally also serve as probes.

[00188] The probe can generally be of any suitable size/length. In some embodiments the probe has a length from about 8 to 200, 15 to 150, 15 to 100, 15 to 75, 15 to 60, or 20 to 55 bases in length. They can be labeled with detectable markers with any suitable detection marker including but not limited to, radioactive isotopes, fluorophores, biotin, enzymes (e.g., alkaline phosphatase), enzyme substrates, ligands and antibodies, etc. See Jablonski et al., *Nucleic Acids Res.* (1986) 14:6115-6128; Nguyen et al., *Biotechniques* (1992) 13:116-123; Rigby et al., *J. Mol. Biol.* (1977) 113:237-251. Indeed, probes may be modified in any conventional manner for various molecular biological applications. Techniques for producing and using such oligonucleotide probes are conventional in the art.

[00189] Probes according to the invention can be used in the hybridization/amplification/detection techniques discussed above. Thus, some embodiments of the invention comprise probe sets suitable for use in a microarray. In some embodiments the probe sets have a certain proportion of their probes directed to CCGs—e.g., a probe set consisting of 10%, 20%, 30%, 40%, 50%, 55%, 60%, 65%, 70%, 75%, 80%, 85%, 90%, 95%, 96%, 97%, 98%, 99%, or 100% probes specific for CCGs. In some embodiments the probe set comprises probes directed to at least 1, 2, 3, 4, 5, 6, 7, 8, 9, 10, 11, 12, 13, 14, 15, 16, 17, 18, 19, 20, 21, 22, 23, 24, 25, 26, 27, 28, 29, 30, 31, 32, 33, 34, 35, 40, 45, 50, 60, 70, 80, 90, 100, 125,

150, or more, or all, of the genes in Table 1, 3 or Panels A through I, or any of the panels disclosed in Tables WW-ZZ. Such probe sets can be incorporated into high-density arrays comprising 5,000, 10,000, 20,000, 50,000, 100,000, 200,000, 300,000, 400,000, 500,000, 600,000, 700,000, 800,000, 900,000, or 1,000,000 or more different probes.

[00190] In another aspect of the present invention, a kit is provided for practicing the diagnosis of the present invention. The kit may include a carrier for the various components of the kit. The carrier can be a container or support, in the form of, e.g., bag, box, tube, rack, and is optionally compartmentalized. The carrier may define an enclosed confinement for safety purposes during shipment and storage. The kit includes various components useful in determining the status of one or more panels of genes as described herein, and one or more housekeeping gene markers, using the above-discussed detection techniques. For example, the kit may include oligonucleotides specifically hybridizing under high stringency to mRNA or cDNA of the genes in Table 1, 3 or Panels A through I, or any of the panels disclosed in Tables WW-ZZ. Such oligonucleotides can be used as PCR primers in RT-PCR reactions, or hybridization probes. In some embodiments the kit comprises reagents (e.g., probes, primers, and or antibodies) for determining the expression level of a panel of genes, where said panel comprises at least 25%, 30%, 40%, 50%, 60%, 75%, 80%, 90%, 95%, 99%, or 100% CCGs. In some embodiments the kit consists of reagents (e.g., probes, primers, and or antibodies) for determining the expression level of no more than 2500 genes, wherein at least 5, 10, 15, 20, 30, 40, 50, 60, 70, 80, 90, 100, 120, 150, 200, 250, or more of these genes are CCGs.

[00191] The oligonucleotides in the detection kit can be labeled with any suitable detection marker including but not limited to, radioactive isotopes, fluorophores, biotin, enzymes (e.g., alkaline phosphatase), enzyme substrates, ligands and antibodies, etc. See Jablonski et al., *Nucleic Acids Res.*, 14:6115-6128 (1986); Nguyen et al., *Biotechniques*, 13:116-123 (1992); Rigby et al., *J. Mol. Biol.*, 113:237-251 (1977). Alternatively, the oligonucleotides included in the kit are not labeled, and instead, one or more markers are provided in the kit so that users may label the oligonucleotides at the time of use.

[00192] In another embodiment of the invention, the detection kit contains one or more antibodies selectively immunoreactive with one or more proteins encoded by any of the genes in Table 1, 3 or Panels A through I, or any of the panels disclosed in Tables WW-ZZ.

[00193] Various other components useful in the detection techniques may also be included in the detection kit of this invention. Examples of such components include, but are not limited to, Taq polymerase, deoxyribonucleotides, dideoxyribonucleotides, other primers suitable for the amplification of a target DNA sequence, RNase A, and the like. In addition, the detection kit preferably includes instructions on using the kit for practice the diagnosis method of the present invention using human samples.

Examples

Example 1

[00194] In this example we determined whether cell cycle progression genes can differentiate between malignant melanoma and non-malignant nevi. Specifically, this example assesses whether melanoma can be differentiated from benign nevi, as well as dysplastic nevi.

Materials and Methods

[00195] Samples: 31 FFPE skin samples, with 3 x 10 mm slides for each sample, and a 4 mm slide for H&E review between the ages of 10-11 years old were obtained from an academic institution. The samples consisted of 11 benign nevi, 10 dysplastic nevi and 10 melanoma samples. Table 4 lists samples and corresponding clinical details.

Table 4. Skin samples with diagnosis, clinical data, and CCP score.

BLD	Slide ID	Diagnosis	CCP	HK Mean	CCP STdv	Quality	Biopsy date	Sex	Age	Location
01095572-BLD	MG12-23	Compound nevus	0.61	19.81	0.04	Very Good	1/3/2001	F	21	Chest
01095574-BLD	MG12-29	Compound nevus	0.79	19370	0.02	Very Good	1/5/2001	F	31	Neck
01095579-BLD	MG12-27	Compound nevus	1.60	23.02	0.08	Very Good	1/16/2001	M	17	Jaw
01095624-BLD	MG12-30	Compound nevus	0.74	20.22	0.13	Very Good	1/8/2001	F	57	Ear
01095553-BLD	MG12-24	Intradermal nevus	0.67	17.41	0.02	Very Good	1/5/2001	M	56	Neck
01095559-BLD	MG12-33	Intradermal nevus	0.39	19.48	0.04	Very Good	2/2/2001	M	43	Back
01095560-BLD	MG12-25	Intradermal nevus	-0.18	18.04	0.04	Very Good	1/16/2001	F	31	Jaw
01095569-BLD	MG12-32	Intradermal nevus	0.27	19.75	0.08	Very Good	1/5/2001	M	30	Shoulder

01095571-BLD	MG12-28	Intradermal nevus	1.05	19.66	0.02	Very Good	1/2/2001	M	36	Cheek
01095576-BLD	MG12-26	Intradermal nevus	0.42	18.34	0.12	Very Good	1/16/2001	M	17	Chin
01095580-BLD	MG12-31	Intradermal nevus	0.74	20.36	0.05	Very Good	1/18/2001	F	53	Neck
01095556-BLD	MG12-35	Compound dysplastic nevus	1.03	20.23	0.04	Very Good	1/29/2001	F	26	Chest
01095570-BLD	MG12-42	Compound dysplastic nevus	0.23	19.56	0.10	Very Good	2/1/2001	M	52	Thigh
01095577-BLD	MG12-40	Compound dysplastic nevus	0.93	19.21	0.02	Very Good	3/19/2001	M	41	Back
01095620-BLD	MG12-39	Compound dysplastic nevus	1.33	20.48	0.02	Very Good	2/22/2001	F	30	Back
01095622-BLD	MG12-34	Compound dysplastic nevus	0.54	17.07	0.02	Very Good	1/25/2001	M	35	Back
01095626-BLD	MG12-36	Compound dysplastic nevus	0.67	24.95	0.26	Good	2/7/2001	F	32	Abdomen
01095552-BLD	MG12-41	Junctional dysplastic nevus	0.91	20.74	0.16	Very Good	3/5/2001	M	27	Neck
01095554-BLD	MG12-38	Junctional dysplastic nevus	0.70	21.11	0.02	Very Good	2/21/2001	M	45	Chest
01095562-BLD	MG12-37	Junctional dysplastic nevus	1.45	21.86	0.04	Very Good	2/14/2001	F	40	Back
01095578-BLD	MG12-43	Junctional dysplastic nevus	1.28	20.47	0.05	Very Good	1/17/2001	F	69	Thigh
01095621-BLD	MG12-46	Nodular melanoma	NA	30.34	NA	Rejected	11/13/2001	F	9	Back
01095551-BLD	MG12-50	SSM	1.50	21.13	0.01	Very Good	9/26/2001	M	51	Arm
01095555-BLD	MG12-53	SSM	1.28	19.73	0.07	Very Good	7/1/2002	M	61	Back
01095557-BLD	MG12-52	SSM	2.20	21.07	0.06	Very Good	6/24/2001	F	36	Chest
01095558-BLD	MG12-44	SSM	1.67	19.19	0.03	Very Good	1/4/2001	F	68	Arm
01095561-BLD	MG12-51	SSM	1.76	20.20	0.03	Very Good	3/1/2001	M	36	Back
01095573-BLD	MG12-45	SSM	1.67	20.02	0.05	Very Good	3/14/2001	F	36	Knee
01095575-BLD	MG12-49	SSM	2.39	19.54	0.04	Very Good	8/16/2001	F	38	Back
01095623-BLD	MG12-48	SSM	2.12	19.82	0.02	Very Good	7/21/2001	M	38	Shoulder

01095625- BLD	MG12- 47	SSM	2.01	20.46	0.05	Very Good	8/7/2001	M	43	shoulder
------------------	-------------	-----	------	-------	------	--------------	----------	---	----	----------

SSM = superficial spreading melanoma

[00196] Sample Processing, CCP score generation, and analysis: 4 mm slides were stained to make H&E slides and reviewed by a pathologist who circled the lesion (either the nevus or the melanoma). Using the H&E slide, the lesions were dissected and removed from each of the three 10 μ M slides. All three dissected lesions from a single patient were pooled.

[00197] RNA was extracted from samples and RNA expression levels were determined using standard qPCR techniques. Of the 31 samples, 30 were successfully run and generated a CCP score (see Table 4 for data).

[00198] CCP scores of the melanoma samples were compared to the other two groups, benign nevi and dysplastic nevi, as well as to dysplastic nevi alone, using the Student's t-test, to determine if the CCP scores of the groups were different in a statistically significant manner.

Results

[00199] We observed the melanoma samples had different CCP scores than both nevi subgroups combined, in a very statistically significant manner (p-value, 1.4×10^{-6} , see Figure 2). When using this data in a diagnostic model, the melanoma samples could be identified with an AUC of 0.97. On average, melanoma CCP scores were 1.08 higher than nevi CCP scores. See Table 4 for a list of all data. Figure 2 shows the distribution of the CCP scores from all 30 samples with a score, separated by the clinical diagnosis.

[00200] We also observed the melanoma samples had different CCP scores compared to just dysplastic nevi, in a statistically significant manner (p-value, 3.9×10^{-5} , see Figure 2). When using this data in a diagnostic model, the melanoma samples could be identified, compared to just the dysplastic nevi, with an AUC of 0.97. On average, melanoma CCP scores were 0.94 higher than nevi CCP scores.

[00201] Finally, we observed the benign nevi were not statistically different than the dysplastic nevi (p-value, 0.17), indicating that when nevi become dysplastic they are not replicating at a faster rate, and only upon transitioning to a melanoma do the cells begin to

replicate faster. The data indicates that the melanoma samples are replicating at a 2-fold higher rate than nevi.

Discussion

[00202] These data show the measurement of CCP scores can differentiate between malignant melanoma and nonmalignant nevi. More specifically these data show that a CCP score can differentiate between melanoma and dysplastic nevi. While the average difference between the two groups is moderate (~1 CCP unit), precision of the measurements allows for good separation of the two datasets.

Example 2

[00203] In this example we determined whether certain CCP genes differentiated nevi and melanoma more effectively (Table 6). We indeed observed that there were certain CCP genes that had much better AUC values than others, even though all but one gene had an AUC >0.8, which was still quite impressive. We decided to move forward and selected ten CCP genes whose AUC scores were >0.95 (see Table 6). Ten CCP genes were sufficient to produce a robust and reliable CCP score.

Table 6.

CCPGene	Assay	AUC	Correlation with overall CCP Score	Continue to next stage
SKA1	Hs00536843 ml	1.00	0.88	Yes
DTL	Hs00978565 ml	1.00	0.87	Yes
CEP55	Hs00216688 ml	0.99	0.81	Yes
FOXM1	Hs01073586 ml	0.98	0.94	Yes
PLK1	Hs00153444 ml	0.98	0.87	Yes
PBK	Hs00218544 ml	0.97	0.96	Yes
CENPF	Hs00193201 ml	0.97	0.85	Yes
DLGAP5	Hs00207323 ml	0.96	0.95	Yes
MCM10	Hs00960349 ml	0.96	0.84	Yes
RRM2	Hs00357247 gl	0.96	0.96	Yes
ORC6L	Hs00204876 ml	0.95	0.88	
BIRC5	Hs00153353 ml	0.95	0.82	

NUSAP1	Hs01006195 ml	0.95	0.95	
ASF1B	Hs00216780 ml	0.93	0.89	
RAD54L	Hs00269177 ml	0.93	0.84	
CDKN3	Hs00193192 ml	0.93	0.92	
ASPM	Hs00411505 ml	0.93	0.95	
BUB1B	Hs01084828 ml	0.92	0.94	
TKI	Hs01062125 ml	0.92	0.93	
KIF20A	Hs00993573 ml	0.91	0.81	
CDK1	Hs00364293 ml	0.91	0.91	
CDC20	Hs03004916 gl	0.91	0.92	
RAD51	Hs001534L8 ml	0.91	0.91	
CDCA8	Hs0098365S ml	0.91	0.89	
KIF11	Hs00189698 ml	0.90	0.65	
PTTG1	Hs00851754 ul	0.90	0.90	
PRC1	Hs00187740 ml	0.89	0.92	
TOP2A	Hs00172214 ml	0.86	0.77	
KIAA0101	Hs00207134 ml	0.86	0.89	
CENPM	Hs00608780 ml	0.81	0.63	
CDCA3	Hs00229905 ml	0.71	0.65	

AUC indicates differentiation between melanoma and all nevi.

Example 3

[00204] This example assesses a variety of potential biomarkers to determine if their altered expression can differentiate between malignant melanoma and non-malignant nevi.

Materials and Methods

[00205] Samples: Biomarker discovery was performed using two independent datasets. The first dataset consisted of 31 samples (Group 1). See Table 7 for a list of these samples and their clinical details. The second dataset consisted of 53 samples (Group 2). See Table 8 for a list of these samples and their clinical details.

Table 7. Group 1 samples.

Sample ID	Diagnosis	Subtype	Biopsy date	Age	Sex	Location
MG12-50	Melanoma	Superficial Spreading	9/26/2001	51	M	Arm
MG12-41	Nevus	Dysplastic low/ Junctional	3/5/2001	27	M	Neck
MG12-24	Nevus	Intradermal	1/5/2001	56	M	Neck
MG12-38	Nevus	Dysplastic low/ Junctional	2/21/2001	45	M	Chest
MG12-53	Melanoma	Superficial Spreading	7/1/2002	61	M	Chest

MG12-35	Nevus	Dysplastic low/ Compound	1/29/2001	26	F	Chest
MG12-52	Melanoma	Superficial Spreading	6/24/2002	36	F	Chest
MG12-44	Melanoma	Superficial Spreading	1/4/2001	68	F	arm
MG12-33	Nevus	Intradermal	2/2/2001	43	M	back
MG12-25	Nevus	Intradermal	1/16/2001	31	F	jaw
MG12-51	Melanoma	Superficial Spreading	3/1/2002	36	M	Back
MG12-37	Nevus	Dysplastic low/ Junctional	2/14/2001	40	F	Back
MG12-32	Nevus	Intradermal	1/5/2001	30	M	shoulder
MG12-42	Nevus	Dysplastic low/ Compound	2/1/2001	52	M	Thigh
MG12-28	Nevus	Intradermal	1/2/2001	36	M	Cheek
MG12-23	Nevus	Compound	1/3/2001	21	F	Chest
MG12-45	Melanoma	Superficial Spreading	3/14/2001	36	F	Knee
MG12-29	Nevus	Compound	1/5/2001	31	F	Neck
MG12-49	Melanoma	Superficial Spreading	8/16/2001	38	F	Back
MG12-26	Nevus	Intradermal	1/16/2001	17	M	Chin
MG12-40	Nevus	Dysplastic low/ Compound	3/19/2001	41	M	Back
MG12-43	Nevus	Dysplastic low/ Junctional	1/17/2001	69	F	Thigh
MG12-27	Nevus	Compound	1/16/2001	17	M	Jaw
MG12-31	Nevus	Intradermal	1/18/2001	53	F	Neck
MG12-39	Nevus	Dysplastic low/ Compound	2/22/2001	30	F	Back
MG12-46	Melanoma	Nodular	11/13/2001	9	F	Back
MG12-34	Nevus	Dysplastic low/ Compound	1/25/2001	35	M	back
MG12-48	Melanoma	Superficial Spreading	7/21/2001	38	M	Shoulder
MG12-30		Lost sample				
MG12-47	Melanoma	Superficial Spreading	8/7/2001	43	M	Shoulder
MG12-36	Nevus	Dysplastic low/ Compound	2/7/2001	32	F	abdomen

Table 8. Group 2 Samples

qPCR ID	Sample ID	Diagnosis	Subtype	Biopsy Date	Age	Sex	Location
1	P09-3235	Nevus	Intradermal	11/25/2009	44	F	Torso
2	P08-1961	Nevus	Compound	2/8/2008	65	M	Torso
3	P05-363	Melanoma	Nodular	1/11/2005	38	M	Leg
4	P10-2736 F1	Nevus	Intradermal	1/27/2010	34	M	Head
5	CPP-11-33494	Melanoma	Nodular	11/1/2011	69	M	Head
6	CPP-09-27303	Melanoma	Superficial Spreading	10/1/2009	47	F	Torso
7	CPP-10-2397	Nevus	Blue	1/26/2010	51	M	Head
8	P09-35648	Nevus	Dysplastic low	12/18/2009	44	M	Leg
9	CPP-11-07506	Nevus	Dysplastic low	3/1/2011	40	F	Torso
10	P10-1574 A1	Nevus	Intradermal	1/17/2010	335	F	Torso
11	C07-896 E4	Melanoma	Nodular	1/18/2007	59	M	Head
12	P10-494 A1	Nevus	Intradermal	1/6/2010	53	M	Head
13	CPP-09-36545 A9	Melanoma	Nodular		60	M	Torso
14	P10-3676 A11	Melanoma	Superficial Spreading	2/6/2010	79	M	Leg
15	C06-10614	Melanoma	Superficial Spreading	1/11/2006	34	M	Head
16	CPP-10-10782 B1	Nevus	Dysplastic low	4/1/2010	30	M	Torso
17	CPP-10-3651	Nevus	Blue	2/5/2010	39	F	Head

18	CPP-10-10782 A1	Nevus	Dysplastic low	4/1/2010	30	M	Torso
19	CPP-10-04915	Melanoma	Acral	2/1/2010	71	M	Leg
20	CPP-09-8204	Melanoma	Nodular	4/3/2009	60	M	Head
21	P01-6845	Nevus	Compound	10/12/2001	25	F	Arm
22	C07-3665 A2	Melanoma	Lentigo Maligna	7/31/2006	34	M	Head
23	CPC-03-00227	Nevus	Spitz	1/1/2003	74	F	Torso
24	CPC-07-03023	Nevus	Compound	2/1/2007	45	F	arm
25	CPP-10-12821	Melanoma	Acral	5/1/2010	63	F	Leg
26	CPP-10-03836	Nevus	Dysplastic low	2/1/2010	37	M	Torso
27	CPP-01-7511	Nevus	Blue	11/9/2001	25	F	Arm
28	CPC-06-430	Nevus	Intradermal	1/11/2006	40	F	Head
29	CPP-10-1094	Melanoma	Nodular	1/4/2010	54	M	Arm
30	CPP-11-33384	Melanoma	Lentigo Maligna	11/3/2011	67	F	Head
31	CPP-12-23457	Melanoma	Desmoplastic	8/21/2012	48	M	Head
32	CPP-11-13421	Nevus	Dysplastic low	4/29/2011	32	F	Torso
33	CPP-11-15636	Nevus	Compound	5/19/2011	22	M	Torso
34	CPP-10-9267	Nevus	Dysplastic high/ Junctional	3/31/2010	36	M	Torso
35	CPP-10-22878	Melanoma	Superficial Spreading	8/6/2010	67	F	Head
36	CPP-10-9477 A	Nevus	Dysplastic low/ Junctional	4/4/2010	40	M	Torso
37	CPP-10-7786	Nevus	Dysplastic low/ Junctional	3/18/2010	52	M	Torso
38	CPP-10-18433	Nevus	Compound	6/24/2010	48	M	Leg
39	CPP-08-7203	Nevus	Dysplastic low	5/19/2008	38	F	Leg
40	CPP-10-19572	Nevus	Spitz	7/7/2010	29	F	Torso
41	CPP-11-13681	Nevus	Dysplastic low	5/3/2011	48	M	Torso
42	CPP-12-14855	Melanoma	Acral	5/25/2012	71	M	Leg
43	CPP-11-19854	Nevus	Dysplastic low/ Compound	6/27/2011	31	M	Torso
44	CPP-11-24358	Melanoma	Lentigo Maligna	8/9/2011	89	F	Head
45	CPP-10-9477 B	Nevus	Dysplastic low/ Junctional	4/1/2010	40	M	Torso
46	CPP-10-16714	Melanoma	Lentigo Maligna	6/10/2010	58	M	Head
47	CPP-12-17349	Melanoma	Desmoplastic	6/20/2012	62	M	Leg
48	CPP-10-8105	Nevus	Dysplastic low/ Junctional	3/22/2010	48	F	Torso
49	CPP-12-17027	Nevus	Spitz	6/18/2012	25	M	Arm
50	CPP-11-17106	Melanoma	Superficial Spreading	6/2/2011	52	M	Head
51	CPP-12-14808	Melanoma	Desmoplastic	5/24/2012	66	F	Head
52	CPP-11-32490	Melanoma	Superficial Spreading	10/27/2011	58	F	Arm
53	CPP-11-17723	Nevus	Dysplastic low	6/8/2011	36	F	Torso

[00206] RNA extraction: The 31 group 1 samples were anonymized with a qPCRID and a 4 mm H&E slide was reviewed by a pathologist who circled the lesion of interest (either the nevus or the melanoma). The lesions were then macro-dissected and removed from three 10 μ M slides. All three dissected lesions from a single patient

were pooled into a single tube. RNA was extracted from samples, RNA expression levels were determined using standard qPCR techniques, and a standard CCP score was generated.

[00207] RNA from 30 of the samples was then used in the first two rounds of biomarker discovery. RNA was DNased and quantified. RNA with concentrations >40ng/uL were normalized to 40 ng/uL.

[00208] The 53 group 2 samples were anonymized with a qPCR ID, and a H&E slide was reviewed by a pathologist who circled the lesion of interest. The lesions were then macro-dissected from five 4mm slides. All five dissected lesions from a single patient were pooled into a single tube. The RNA from each tube was extracted using standard RNA extraction techniques. RNA was DNased and quantified. All RNA samples with concentrations >40ng/uL were normalized to 40 ng/uL.

[00209] Measurement of gene expression: RNA expression was measured using standard qPCR techniques. Ct values were determined, and the expression of each gene was normalized to the expression of housekeeper genes.

[00210] Biomarkers were assessed in three rounds of testing. Only samples from group 1 were analyzed in rounds 1 and 2 of testing. Samples from groups 1 and 2 were analyzed in round 3 of testing. Data from each round of testing was analyzed separately and aggregated. The housekeeping genes tested for normalization in all three rounds included MRFAP1, PSMA1, RPL13A, and TXNL1. In addition, housekeeping genes SLC25A3, RPS29, RPL8, PSMC1 and RPL4 were included in the first round of testing.

Results

[00211] Table 9 lists all amplicons used in biomarker discovery and lists p-values for separate rounds of analysis, and aggregated analysis as indicated in the round tested column. P-values are Wilcoxon Rank Sum P-values, and p-values and AUC indicate differentiation all melanomas subtypes from all nevi subtypes.

Table 9. All amplicons used during biomarker discovery

Gene	Assay ID	P-Value	AUC	Round
------	----------	---------	-----	-------

				Tested
ARPC2	Hs00194852_m1	4.1E-02	0.76	2
	Hs01031743_m1	1.5E-01	0.60	1, 3
	Hs01031746_g1	8.3E-03	0.81	1
	Hs01031748_m1	8.8E-02	0.62	2, 3
BCL2A1	Hs00187845_m1	8.7E-06	0.80	1, 3
CCL3 (MIP-1 α)	Hs00234142_m1	5.3E-08	0.87	2, 3
	Hs04194942_s1	2.5E-04	0.75	1, 3
FN1	Hs01565276_m1	1.3E-06	0.82	1, 3
IFI6	Hs01564161_g1	3.8E-06	0.81	1, 3
NCOA3	Hs01105241_m1	4.3E-01	0.55	1, 3
	Hs01105267_m1	5.2E-01	0.54	1, 3
PHIP	Hs06611782_m1	1.8E-01	0.66	1
	Hs01059904_m1	1.5E-01	0.60	1, 3
POU5F1	Hs04195369_s1	5.0E-01	0.58	1, 3
	Hs04260367_gH	1.1E-01	0.61	1, 3
RGS1	Hs00175260_m1	5.2E-04	0.94	2
	Hs01023770_g1	4.0E-11	0.94	1, 3
	Hs01023772_m1	1.0E-11	0.95	1, 3
SPP1	Hs00167093_m1	8.3E-09	0.87	2, 3
	Hs00959006_g1	3.3E-02	0.81	2
	Hs00959008_g1	3.3E-09	0.88	2, 3
	Hs00959010_m1	5.3E-09	0.89	1
	Hs00960641_m1	4.0E-01	1.00	1, 3
WNT2	Hs00608222_m1	3.2E-01	0.92	1
	Hs00608224_m1	4.5E-01	0.61	3
	Hs01128652_m1	8.3E-01	0.55	1
WIF1	Hs00183662_m1	5.3E-02	0.63	1, 3
	Hs01548029_m1	7.6E-01	0.54	1
NR4A1	Hs00374226_m1	2.9E-01	0.57	1, 3
	Hs00926542_g1	1.0E-01	0.72	1
SOCS3	Hs00269575_s1	9.3E-09	0.87	1, 3
	Hs01000485_g1	9.4E-08	0.85	2, 3
	Hs02330328_s1	5.4E-03	0.84	1
PRAME	Hs00196132_m1	2.0E-02	0.88	2
	Hs01022299_m1	1.0E+0	0.50	2
	Hs01022301_m1	1.3E-09	0.89	2, 3
	Hs04186846_m1	3.8E-06	0.84	2, 3
KRT15	Hs00267035_m1	1.0E-01	0.71	2
	Hs00951967_g1	1.3E-08	0.89	2, 3
	Hs00951968_gH	1.0E-08	0.89	2, 3
	Hs02558897_s1	8.3E-02	0.74	2
FABP7	Hs00361424_g1	1.2E-05	0.80	2, 3
	Hs00361426_m1	3.5E-02	0.77	2
	Hs00953719_g1	1.7E-03	0.72	2, 3

CFH	Hs00962362_g1	1.4E-03	0.72	2, 3
	Hs00962365_g1	5.0E-01	0.59	2
	Hs00962373_m1	6.3E-03	0.69	2, 3
PTN	Hs00383235_m1	1.5E-02	0.67	2, 3
	Hs01085690_m1	5.5E-02	0.75	2
	Hs01085691_m1	1.4E-03	0.72	2, 3
HEY1	Hs01114111_g1	1.0E-04	0.76	2, 3
	Hs01114112_g1	4.5E-04	0.74	2, 3
	Hs01114113_m1	6.9E-01	0.56	2
GDF15	Hs00171132_m1	5.0E-02	0.64	2, 3
PHACTR1	Hs01116208_m1	9.4E-02	0.72	2
	Hs01116210_m1	2.1E-01	0.59	2, 3
	Hs01116212_m1	4.8E-02	0.76	2
	Hs01116214_m1	2.1E-07	0.86	2, 3
LCP2	Hs00175501_m1	2.2E-07	0.89	3
	Hs01092638_m1	2.4E-06	0.86	3
CXCL9	Hs00171065_m1	4.7E-11	0.97	3
	Hs00970537_m1	3.6E-11	0.97	3
CXCL10	Hs01124251_g1	8.9E-07	0.92	3
	Hs01124252_g1	8.1E-12	0.98	3
CXCL13	Hs00757930_m1	4.0E-10	0.96	3
	Hs99999094_m1	4.5E-09	0.95	3
S100A9	Hs00610058_m1	6.1E-05	0.82	3
SERPINB4	Hs00741313_g1	1.6E-01	0.65	3
CCL19	Hs00171149_m1	8.3E-02	0.64	3
CCL5	Hs00174575_m1	1.5E-10	0.96	3
CD38	Hs01120071_m1	2.2E-09	0.95	3
CXCL12	Hs00171022_m1	3.5E-01	0.58	3
HCLS1	Hs00945386_m1	1.1E-03	0.76	3
HLA-DMA	Hs00185435_m1	3.7E-04	0.78	3
HLA-DPA1	Hs01072899_m1	3.8E-02	0.67	3
HLA-DPB1	Hs00157955_m1	2.9E-01	0.59	3
HLA-DRA	Hs00219575_m1	6.4E-04	0.77	3
HLA-E	Hs03045171_m1	1.1E-01	0.63	3
IGHM	Hs00378435_m1	1.8E-02	0.76	3
IGJ	Ha00950678_g1	5.2E-03	0.73	3
IIGLL5;CKAP2	Hs00382306_m1	1.8E-01	0.64	3
IRF1	Hs00971966_g1	2.0E-08	0.92	3
IRF4	Hs00180031_m1	2.4E-02	0.69	3
ITGB2	Hs01051739_m1	1.7E-05	0.84	3
PECAM1	Hs00169777_m1	1.8E-03	0.75	3
PTPN22	Hs00249262_m1	1.4E-05	0.84	3
PTPRC	Hs00894732_m1	1.5E-04	0.80	3
SELL	Hs01046459_m1	9.0E-09	0.93	3

[00212] Figure 3 A and B shows the distribution of all amplicons tested in all three rounds of biomarker discovery. Samples are differentiated based on diagnosis on the Y-axis. The relative expression (Ct) of each gene (compared to the expression of the housekeeper genes) is graphed on the X axis. 88 amplicons were tested in total; 48 are represented on Figure 3A and 40 on Figure 3B.

[00213] Figure 4A and B shows the distributions of each individual amplicon tested in rounds one and two of biomarker discovery. Samples are differentiated based on their pathological subtype on the Y axis. The relative expression (Ct) of each gene (compared to the expression of the housekeeper genes) is graphed on the X axis. Each amplicon is identified by the gene and the last three digits of the assay ID. 58 amplicons were tested in total; 30 are represented on Figure 4A and 28 on Figure 4B.

Discussion

[00214] These data strongly indicate that expression of specific biomarker genes can be used to differentiate malignant melanoma from non-malignant nevi. Nonetheless, a larger dataset is needed to determine with higher confidence how effective each individual biomarker is in differentiating melanoma, as well as to determine how heavily each biomarker would need to be weighted in a diagnostic model.

[00215] Table 10 lists the best performing assay/amplicon of each biomarkers determined by its *AUC*, P-value, and lack of missing data. P-values are Wilcoxon Rank Sum P-values. P-values and *AUC* indicate differentiation of all melanomas subtypes from all nevi subtypes.

Table 10.

Gene	Assay ID	P-Value	AUC
CXCL10	Hs01124252_g1	8.1E-12	0.98
CXCL9	Hs0171065_m1	4.7E-11	0.97
CXCL13	Hs00757930_m1	4.0E-10	0.96
CCL5	Hs00174575_m1	1.5E-10	0.96
RGS1	Hs01023772_m1	1.0E-11	0.95
CD38	Hs01120071_m1	2.2E-09	0.95
SELL	Hs01046459_m1	9.0E-09	0.93
IRF1	Hs00971966_g1	2.0E-08	0.92
SPP1	Hs00959010_m1	5.3E-09	0.89

PRAME	Hs01022301_m1	1.3E-09	0.89
KRT15	Hs00951967_g1	1.3E-08	0.89
LCP2	Hs00175501_m1	2.2E-07	0.89
CCL3 (MIP-1 α)	Hs00234142_m1	5.3E-08	0.87
PHACTR1	Hs01116217_m1	2.1E-07	0.86
ITGB2	Hs01051739_m1	1.7E-05	0.84
PTPN22	Hs00249262_m1	1.4E-05	0.84
FN1	Hs01565276_m1	1.3E-06	0.82
S100A9	Hs00610058_m1	6.1E-05	0.82
IFI6	Hs01564161_m1	3.8E-06	0.81
BCL2A1	Hs00187845_m1	8.7E-06	0.80
FABP7	Hs00361424_g1	1.2E-05	0.80
PTPRC	Hs00894732_m1	1.5E-04	0.80
HLA-DMA	Hs00185435_m1	3.7E-04	0.78
HLA-DRA	Hs00219575_m1	6.4E-04	0.77
HCLS1	Hs00945386_m1	1.1E-03	0.76
PECAM1	Hs00169777_m1	1.8E-03	0.75
HEY1	Hs01114112_g1	4.5E-04	0.74
IGJ	Ha00950678_g1	5.2E-03	0.73
CFH	Hs00962362_g1	1.4E-03	0.72
PTN	Hs01085691_m1	1.4E-03	0.72

Example 4

[00216] P-values were calculated for distinguishing melanoma from nevi for all combinations of two, three, and four genes from Panel I with data from the same samples used above. Firth's logistic regression was used to assign the best weights to each of the genes in each combination. The p-values were calculated using a likelihood ratio test comparing a model containing all genes in each combination with a reduced model containing no predictor variables. The number of samples with data for all genes in each combination and whether the combination contains CCP genes, other genes, or a mix of CCP and other genes are included in the results.

[00217] Additionally, p-values were calculated for average CCP expression of all combinations of one to ten of the CCP genes in panel C as continuing to the next stage for use in a potential training set. The average of each combination of CCP genes was calculated and a t-test was performed to test for a difference in average expression between melanomas and nevi.

[00218] Table WW contains the results for the combinations of between one and 4 CCP gene averages. Table XX contains the results for all combinations of two

genes. Table YY contains the results for the top 500 combinations of three genes.

Table ZZ contains the results for the top 500 combinations of four genes.

Table WW

n.genes	genes	pval
1	C18orf24	3.23E-08
1	PBK	2.72E-06
1	PLK1	2.16E-07
1	DLGAP5	1.32E-06
1	FOXMI	2.80E-07
1	MCM10	1.57E-06
1	CEP55	2.25E-06
1	RRM2	2.71E-05
1	DTL	2.13E-07
1	CENPF	1.70E-05
2	C18orf24 PBK	1.19E-07
2	C18orf24 PLK1	2.00E-08
2	C18orf24 DLGAP5	4.51E-09
2	C18orf24 FOXMI	4.70E-08
2	C18orf24 MCM10	6.76E-09
2	C18orf24 CEP55	4.70E-09
2	C18orf24 RRM2	3.08E-07
2	C18orf24 DTL	3.42E-09
2	C18orf24 CENPF	2.64E-07
2	PBK PLK1	3.48E-07
2	PBK DLGAP5	3.93E-07
2	PBK FOXMI	3.73E-07
2	PBK MCM10	3.39E-07
2	PBK CEP55	1.09E-07
2	PBK RRM2	1.67E-06
2	PBK DTL	2.68E-07
2	PBK CENPF	5.39E-06
2	PLK1 DLGAP5	1.17E-07
2	PLK1 FOXMI	2.12E-07
2	PLK1 MCM10	1.10E-07
2	PLK1 CEP55	1.02E-07
2	PLK1 RRM2	8.79E-07
2	PLK1 DTL	9.73E-08
2	PLK1 CENPF	1.17E-06
2	DLGAP5 FOXMI	9.55E-08
2	DLGAP5 MCM10	7.54E-08
2	DLGAP5 CEP55	4.09E-07
2	DLGAP5 RRM2	1.61E-06
2	DLGAP5 DTL	1.12E-07
2	DLGAP5 CENPF	1.86E-06
2	FOXMI MCM10	1.24E-07
2	FOXMI CEP55	6.29E-08
2	FOXMI RRM2	3.72E-07
2	FOXMI DTL	3.19E-08
2	FOXMI CENPF	1.22E-06
2	MCM10 CEP55	4.51E-08

2	MCM10 RRM2	7.02E-07
2	MCM10 DTL	1.11E-07
2	MCM10 CENPF	1.06E-06
2	CEP55 RRM2	1.29E-06
2	CEP55 DTL	8.42E-08
2	CEP55 CENPF	1.23E-06
2	RRM2 DTL	1.10E-06
2	RRM2 CENPF	1.24E-05
2	DTL CENPF	1.44E-06
3	C18orf24 PBK PLK1	6.42E-08
3	C18orf24 PBK DLGAP5	3.31E-08
3	C18orf24 PBK FOXM1	8.71E-08
3	C18orf24 PBK MCM10	3.72E-08
3	C18orf24 PBK CEP55	2.45E-08
3	C18orf24 PBK RRM2	2.18E-07
3	C18orf24 PBK DTL	3.29E-08
3	C18orf24 PBK CENPF	5.36E-07
3	C18orf24 PLK1 DLGAP5	1.15E-08
3	C18orf24 PLK1 FOXM1	4.55E-08
3	C18orf24 PLK1 MCM10	1.24E-08
3	C18orf24 PLK1 CEP55	1.12E-08
3	C18orf24 PLK1 RRM2	1.10E-07
3	C18orf24 PLK1 DTL	1.18E-08
3	C18orf24 PLK1 CENPF	1.28E-07
3	C18orf24 DLGAP5 FOXM1	1.38E-08
3	C18orf24 DLGAP5 MCM10	3.59E-09
3	C18orf24 DLGAP5 CEP55	6.49E-09
3	C18orf24 DLGAP5 RRM2	6.24E-08
3	C18orf24 DLGAP5 DTL	3.98E-09
3	C18orf24 DLGAP5 CENPF	1.01E-07
3	C18orf24 FOXM1 MCM10	2.06E-08
3	C18orf24 FOXM1 CEP55	1.68E-08
3	C18orf24 FOXM1 RRM2	9.04E-08
3	C18orf24 FOXM1 DTL	9.34E-09
3	C18orf24 FOXM1 CENPF	2.06E-07
3	C18orf24 MCM10 CEP55	4.69E-09
3	C18orf24 MCM10 RRM2	5.26E-08
3	C18orf24 MCM10 DTL	4.24E-09
3	C18orf24 MCM10 CENPF	7.72E-08
3	C18orf24 CEP55 RRM2	6.49E-08
3	C18orf24 CEP55 DTL	3.18E-09
3	C18orf24 CEP55 CENPF	5.69E-08
3	C18orf24 RRM2 DTL	6.20E-08
3	C18orf24 RRM2 CENPF	7.48E-07
3	C18orf24 DTL CENPF	7.84E-08
3	PBK PLK1 DLGAP5	1.43E-07
3	PBK PLK1 FOXM1	2.22E-07
3	PBK PLK1 MCM10	1.37E-07
3	PBK PLK1 CEP55	9.21E-08
3	PBK PLK1 RRM2	4.62E-07
3	PBK PLK1 DTL	1.54E-07
3	PBK PLK1 CENPF	1.19E-06
3	PBK DLGAP5 FOXM1	1.61E-07

3	PBK DLGAP5 MCM10	1.29E-07
3	PBK DLGAP5 CEP55	9.22E-08
3	PBK DLGAP5 RRM2	4.94E-07
3	PBK DLGAP5 DTL	1.22E-07
3	PBK DLGAP5 CENPF	1.02E-06
3	PBK FOXM1 MCM10	1.67E-07
3	PBK FOXM1 CEP55	1.00E-07
3	PBK FOXM1 RRM2	3.36E-07
3	PBK FOXM1 DTL	1.06E-07
3	PBK FOXM1 CENPF	1.15E-06
3	PBK MCM10 CEP55	5.92E-08
3	PBK MCM10 RRM2	3.66E-07
3	PBK MCM10 DTL	1.10E-07
3	PBK MCM10 CENPF	1.06E-06
3	PBK CEP55 RRM2	2.83E-07
3	PBK CEP55 DTL	5.70E-08
3	PBK CEP55 CENPF	6.18E-07
3	PBK RRM2 DTL	4.40E-07
3	PBK RRM2 CENPF	3.26E-06
3	PBK DTL CENPF	1.13E-06
3	PLK1 DLGAP5 FOXM1	8.52E-08
3	PLK1 DLGAP5 MCM10	4.43E-08
3	PLK1 DLGAP5 CEP55	9.78E-08
3	PLK1 DLGAP5 RRM2	3.26E-07
3	PLK1 DLGAP5 DTL	7.28E-08
3	PLK1 DLGAP5 CENPF	6.07E-07
3	PLK1 FOXM1 MCM10	1.02E-07
3	PLK1 FOXM1 CEP55	8.13E-08
3	PLK1 FOXM1 RRM2	2.37E-07
3	PLK1 FOXM1 DTL	6.80E-08
3	PLK1 FOXM1 CENPF	5.69E-07
3	PLK1 MCM10 CEP55	4.23E-08
3	PLK1 MCM10 RRM2	2.06E-07
3	PLK1 MCM10 DTL	6.45E-08
3	PLK1 MCM10 CENPF	3.81E-07
3	PLK1 CEP55 RRM2	3.20E-07
3	PLK1 CEP55 DTL	5.89E-08
3	PLK1 CEP55 CENPF	3.85E-07
3	PLK1 RRM2 DTL	3.02E-07
3	PLK1 RRM2 CENPF	1.92E-06
3	PLK1 DTL CENPF	4.81E-07
3	DLGAP5 FOXM1 MCM10	5.28E-08
3	DLGAP5 FOXM1 CEP55	5.47E-08
3	DLGAP5 FOXM1 RRM2	1.71E-07
3	DLGAP5 FOXM1 DTL	3.33E-08
3	DLGAP5 FOXM1 CENPF	3.81E-07
3	DLGAP5 MCM10 CEP55	3.16E-08
3	DLGAP5 MCM10 RRM2	1.85E-07
3	DLGAP5 MCM10 DTL	3.39E-08
3	DLGAP5 MCM10 CENPF	2.95E-07
3	DLGAP5 CEP55 RRM2	5.67E-07
3	DLGAP5 CEP55 DTL	9.06E-08
3	DLGAP5 CEP55 CENPF	6.16E-07

3	DLGAP5 RRM2 DTL	3.77E-07
3	DLGAP5 RRM2 CENPF	2.36E-06
3	DLGAP5 DTL CENPF	5.59E-07
3	FOXM1 MCM10 CEP55	4.29E-08
3	FOXM1 MCM10 RRM2	1.31E-07
3	FOXM1 MCM10 DTL	3.20E-08
3	FOXM1 MCM10 CENPF	3.91E-07
3	FOXM1 CEP55 RRM2	1.49E-07
3	FOXM1 CEP55 DTL	2.40E-08
3	FOXM1 CEP55 CENPF	2.83E-07
3	FOXM1 RRM2 DTL	1.14E-07
3	FOXM1 RRM2 CENPF	1.17E-06
3	FOXM1 DTL CENPF	3.00E-07
3	MCM10 CEP55 RRM2	1.25E-07
3	MCM10 CEP55 DTL	2.08E-08
3	MCM10 CEP55 CENPF	1.94E-07
3	MCM10 RRM2 DTL	2.08E-07
3	MCM10 RRM2 CENPF	1.29E-06
3	MCM10 DTL CENPF	3.12E-07
3	CEP55 RRM2 DTL	3.03E-07
3	CEP55 RRM2 CENPF	1.91E-06
3	CEP55 DTL CENPF	3.68E-07
3	RRM2 DTL CENPF	2.18E-06
4	C18orf24 PBK PLK1 DLGAP5	3.34E-08
4	C18orf24 PBK PLK1 FOXM1	7.43E-08
4	C18orf24 PBK PLK1 MCM10	3.44E-08
4	C18orf24 PBK PLK1 CEP55	2.85E-08
4	C18orf24 PBK PLK1 RRM2	1.24E-07
4	C18orf24 PBK PLK1 DTL	3.58E-08
4	C18orf24 PBK PLK1 CENPF	2.47E-07
4	C18orf24 PBK DLGAP5 FOXM1	3.79E-08
4	C18orf24 PBK DLGAP5 MCM10	1.94E-08
4	C18orf24 PBK DLGAP5 CEP55	2.06E-08
4	C18orf24 PBK DLGAP5 RRM2	8.84E-08
4	C18orf24 PBK DLGAP5 DTL	2.07E-08
4	C18orf24 PBK DLGAP5 CENPF	1.83E-07
4	C18orf24 PBK FOXM1 MCM10	4.65E-08
4	C18orf24 PBK FOXM1 CEP55	3.71E-08
4	C18orf24 PBK FOXM1 RRM2	1.12E-07
4	C18orf24 PBK FOXM1 DTL	3.40E-08
4	C18orf24 PBK FOXM1 CENPF	2.99E-07
4	C18orf24 PBK MCM10 CEP55	1.61E-08
4	C18orf24 PBK MCM10 RRM2	7.76E-08
4	C18orf24 PBK MCM10 DTL	1.92E-08
4	C18orf24 PBK MCM10 CENPF	1.85E-07
4	C18orf24 PBK CEP55 RRM2	7.78E-08
4	C18orf24 PBK CEP55 DTL	1.55E-08
4	C18orf24 PBK CEP55 CENPF	1.35E-07
4	C18orf24 PBK RRM2 DTL	8.96E-08
4	C18orf24 PBK RRM2 CENPF	6.27E-07
4	C18orf24 PBK DTL CENPF	1.93E-07
4	C18orf24 PLK1 DLGAP5 FOXM1	2.31E-08
4	C18orf24 PLK1 DLGAP5 MCM10	8.15E-09

4	C18orf24 PLK1 DLGAP5 CEP55	1.21E-08
4	C18orf24 PLK1 DLGAP5 RRM2	5.15E-08
4	C18orf24 PLK1 DLGAP5 DTL	1.01E-08
4	C18orf24 PLK1 DLGAP5 CENPF	8.24E-08
4	C18orf24 PLK1 FOXM1 MCM10	2.72E-08
4	C18orf24 PLK1 FOXM1 CEP55	2.47E-08
4	C18orf24 PLK1 FOXM1 RRM2	7.73E-08
4	C18orf24 PLK1 FOXM1 DTL	1.96E-08
4	C18orf24 PLK1 FOXM1 CENPF	1.43E-07
4	C18orf24 PLK1 MCM10 CEP55	9.51E-09
4	C18orf24 PLK1 MCM10 RRM2	4.38E-08
4	C18orf24 PLK1 MCM10 DTL	9.86E-09
4	C18orf24 PLK1 MCM10 CENPF	6.72E-08
4	C18orf24 PLK1 CEP55 RRM2	5.21E-08
4	C18orf24 PLK1 CEP55 DTL	9.01E-09
4	C18orf24 PLK1 CEP55 CENPF	5.77E-08
4	C18orf24 PLK1 RRM2 DTL	5.41E-08
4	C18orf24 PLK1 RRM2 CENPF	3.11E-07
4	C18orf24 PLK1 DTL CENPF	7.33E-08
4	C18orf24 DLGAP5 FOXM1 MCM10	1.04E-08
4	C18orf24 DLGAP5 FOXM1 CEP55	1.41E-08
4	C18orf24 DLGAP5 FOXM1 RRM2	4.18E-08
4	C18orf24 DLGAP5 FOXM1 DTL	8.19E-09
4	C18orf24 DLGAP5 FOXM1 CENPF	8.90E-08
4	C18orf24 DLGAP5 MCM10 CEP55	5.09E-09
4	C18orf24 DLGAP5 MCM10 RRM2	2.53E-08
4	C18orf24 DLGAP5 MCM10 DTL	3.79E-09
4	C18orf24 DLGAP5 MCM10 CENPF	4.23E-08
4	C18orf24 DLGAP5 CEP55 RRM2	4.01E-08
4	C18orf24 DLGAP5 CEP55 DTL	5.40E-09
4	C18orf24 DLGAP5 CEP55 CENPF	5.34E-08
4	C18orf24 DLGAP5 RRM2 DTL	3.30E-08
4	C18orf24 DLGAP5 RRM2 CENPF	2.57E-07
4	C18orf24 DLGAP5 DTL CENPF	5.41E-08
4	C18orf24 FOXM1 MCM10 CEP55	1.24E-08
4	C18orf24 FOXM1 MCM10 RRM2	3.92E-08
4	C18orf24 FOXM1 MCM10 DTL	8.06E-09
4	C18orf24 FOXM1 MCM10 CENPF	9.12E-08
4	C18orf24 FOXM1 CEP55 RRM2	4.91E-08
4	C18orf24 FOXM1 CEP55 DTL	8.24E-09
4	C18orf24 FOXM1 CEP55 CENPF	7.57E-08
4	C18orf24 FOXM1 RRM2 DTL	3.49E-08
4	C18orf24 FOXM1 RRM2 CENPF	2.98E-07
4	C18orf24 FOXM1 DTL CENPF	7.30E-08
4	C18orf24 MCM10 CEP55 RRM2	2.65E-08
4	C18orf24 MCM10 CEP55 DTL	3.76E-09
4	C18orf24 MCM10 CEP55 CENPF	3.47E-08
4	C18orf24 MCM10 RRM2 DTL	2.74E-08
4	C18orf24 MCM10 RRM2 CENPF	2.03E-07
4	C18orf24 MCM10 DTL CENPF	4.00E-08
4	C18orf24 CEP55 RRM2 DTL	3.00E-08
4	C18orf24 CEP55 RRM2 CENPF	2.15E-07
4	C18orf24 CEP55 DTL CENPF	3.57E-08

4	C18orf24 RRM2 DTL CENPF	2.44E-07
4	PBK PLK1 DLGAP5 FOXM1	1.14E-07
4	PBK PLK1 DLGAP5 MCM10	7.66E-08
4	PBK PLK1 DLGAP5 CEP55	7.68E-08
4	PBK PLK1 DLGAP5 RRM2	2.27E-07
4	PBK PLK1 DLGAP5 DTL	9.18E-08
4	PBK PLK1 DLGAP5 CENPF	4.87E-07
4	PBK PLK1 FOXM1 MCM10	1.25E-07
4	PBK PLK1 FOXM1 CEP55	1.00E-07
4	PBK PLK1 FOXM1 RRM2	2.25E-07
4	PBK PLK1 FOXM1 DTL	1.07E-07
4	PBK PLK1 FOXM1 CENPF	6.01E-07
4	PBK PLK1 MCM10 CEP55	5.77E-08
4	PBK PLK1 MCM10 RRM2	1.86E-07
4	PBK PLK1 MCM10 DTL	8.38E-08
4	PBK PLK1 MCM10 CENPF	4.59E-07
4	PBK PLK1 CEP55 RRM2	1.80E-07
4	PBK PLK1 CEP55 DTL	6.39E-08
4	PBK PLK1 CEP55 CENPF	3.40E-07
4	PBK PLK1 RRM2 DTL	2.40E-07
4	PBK PLK1 RRM2 CENPF	1.14E-06
4	PBK PLK1 DTL CENPF	5.16E-07
4	PBK DLGAP5 FOXM1 MCM10	9.06E-08
4	PBK DLGAP5 FOXM1 CEP55	7.63E-08
4	PBK DLGAP5 FOXM1 RRM2	1.94E-07
4	PBK DLGAP5 FOXM1 DTL	7.27E-08
4	PBK DLGAP5 FOXM1 CENPF	4.29E-07
4	PBK DLGAP5 MCM10 CEP55	5.18E-08
4	PBK DLGAP5 MCM10 RRM2	1.87E-07
4	PBK DLGAP5 MCM10 DTL	6.58E-08
4	PBK DLGAP5 MCM10 CENPF	3.75E-07
4	PBK DLGAP5 CEP55 RRM2	1.76E-07
4	PBK DLGAP5 CEP55 DTL	5.50E-08
4	PBK DLGAP5 CEP55 CENPF	3.43E-07
4	PBK DLGAP5 RRM2 DTL	2.16E-07
4	PBK DLGAP5 RRM2 CENPF	1.03E-06
4	PBK DLGAP5 DTL CENPF	4.40E-07
4	PBK FOXM1 MCM10 CEP55	6.51E-08
4	PBK FOXM1 MCM10 RRM2	1.60E-07
4	PBK FOXM1 MCM10 DTL	6.86E-08
4	PBK FOXM1 MCM10 CENPF	4.74E-07
4	PBK FOXM1 CEP55 RRM2	1.47E-07
4	PBK FOXM1 CEP55 DTL	5.24E-08
4	PBK FOXM1 CEP55 CENPF	3.57E-07
4	PBK FOXM1 RRM2 DTL	1.53E-07
4	PBK FOXM1 RRM2 CENPF	9.03E-07
4	PBK FOXM1 DTL CENPF	4.25E-07
4	PBK MCM10 CEP55 RRM2	1.17E-07
4	PBK MCM10 CEP55 DTL	3.76E-08
4	PBK MCM10 CEP55 CENPF	2.62E-07
4	PBK MCM10 RRM2 DTL	1.76E-07
4	PBK MCM10 RRM2 CENPF	9.20E-07
4	PBK MCM10 DTL CENPF	3.94E-07

4	PBK CEP55 RRM2 DTL	1.42E-07
4	PBK CEP55 RRM2 CENPF	8.19E-07
4	PBK CEP55 DTL CENPF	2.93E-07
4	PBK RRM2 DTL CENPF	1.11E-06
4	PLK1 DLGAP5 FOXM1 MCM10	5.28E-08
4	PLK1 DLGAP5 FOXM1 CEP55	6.35E-08
4	PLK1 DLGAP5 FOXM1 RRM2	1.29E-07
4	PLK1 DLGAP5 FOXM1 DTL	4.89E-08
4	PLK1 DLGAP5 FOXM1 CENPF	2.84E-07
4	PLK1 DLGAP5 MCM10 CEP55	3.45E-08
4	PLK1 DLGAP5 MCM10 RRM2	1.02E-07
4	PLK1 DLGAP5 MCM10 DTL	3.53E-08
4	PLK1 DLGAP5 MCM10 CENPF	1.92E-07
4	PLK1 DLGAP5 CEP55 RRM2	2.17E-07
4	PLK1 DLGAP5 CEP55 DTL	6.29E-08
4	PLK1 DLGAP5 CEP55 CENPF	2.99E-07
4	PLK1 DLGAP5 RRM2 DTL	1.79E-07
4	PLK1 DLGAP5 RRM2 CENPF	8.59E-07
4	PLK1 DLGAP5 DTL CENPF	3.16E-07
4	PLK1 FOXM1 MCM10 CEP55	5.33E-08
4	PLK1 FOXM1 MCM10 RRM2	1.13E-07
4	PLK1 FOXM1 MCM10 DTL	4.70E-08
4	PLK1 FOXM1 MCM10 CENPF	2.71E-07
4	PLK1 FOXM1 CEP55 RRM2	1.32E-07
4	PLK1 FOXM1 CEP55 DTL	4.30E-08
4	PLK1 FOXM1 CEP55 CENPF	2.23E-07
4	PLK1 FOXM1 RRM2 DTL	1.16E-07
4	PLK1 FOXM1 RRM2 CENPF	6.11E-07
4	PLK1 FOXM1 DTL CENPF	2.44E-07
4	PLK1 MCM10 CEP55 RRM2	9.39E-08
4	PLK1 MCM10 CEP55 DTL	3.03E-08
4	PLK1 MCM10 CEP55 CENPF	1.47E-07
4	PLK1 MCM10 RRM2 DTL	1.23E-07
4	PLK1 MCM10 RRM2 CENPF	5.31E-07
4	PLK1 MCM10 DTL CENPF	2.05E-07
4	PLK1 CEP55 RRM2 DTL	1.66E-07
4	PLK1 CEP55 RRM2 CENPF	7.23E-07
4	PLK1 CEP55 DTL CENPF	2.26E-07
4	PLK1 RRM2 DTL CENPF	7.86E-07
4	DLGAP5 FOXM1 MCM10 CEP55	3.54E-08
4	DLGAP5 FOXM1 MCM10 RRM2	8.38E-08
4	DLGAP5 FOXM1 MCM10 DTL	2.63E-08
4	DLGAP5 FOXM1 MCM10 CENPF	1.78E-07
4	DLGAP5 FOXM1 CEP55 RRM2	1.03E-07
4	DLGAP5 FOXM1 CEP55 DTL	2.93E-08
4	DLGAP5 FOXM1 CEP55 CENPF	1.99E-07
4	DLGAP5 FOXM1 RRM2 DTL	8.20E-08
4	DLGAP5 FOXM1 RRM2 CENPF	4.74E-07
4	DLGAP5 FOXM1 DTL CENPF	1.77E-07
4	DLGAP5 MCM10 CEP55 RRM2	8.27E-08
4	DLGAP5 MCM10 CEP55 DTL	2.04E-08
4	DLGAP5 MCM10 CEP55 CENPF	1.36E-07
4	DLGAP5 MCM10 RRM2 DTL	9.42E-08

4	DLGAP5 MCM10 RRM2 CENPF	4.58E-07
4	DLGAP5 MCM10 DTL CENPF	1.49E-07
4	DLGAP5 CEP55 RRM2 DTL	2.18E-07
4	DLGAP5 CEP55 RRM2 CENPF	9.29E-07
4	DLGAP5 CEP55 DTL CENPF	2.76E-07
4	DLGAP5 RRM2 DTL CENPF	8.77E-07
4	FOXM1 MCM10 CEP55 RRM2	7.16E-08
4	FOXM1 MCM10 CEP55 DTL	2.05E-08
4	FOXM1 MCM10 CEP55 CENPF	1.51E-07
4	FOXM1 MCM10 RRM2 DTL	6.53E-08
4	FOXM1 MCM10 RRM2 CENPF	4.06E-07
4	FOXM1 MCM10 DTL CENPF	1.48E-07
4	FOXM1 CEP55 RRM2 DTL	6.90E-08
4	FOXM1 CEP55 RRM2 CENPF	4.43E-07
4	FOXM1 CEP55 DTL CENPF	1.34E-07
4	FOXM1 RRM2 DTL CENPF	4.26E-07
4	MCM10 CEP55 RRM2 DTL	6.63E-08
4	MCM10 CEP55 RRM2 CENPF	3.72E-07
4	MCM10 CEP55 DTL CENPF	1.05E-07
4	MCM10 RRM2 DTL CENPF	4.85E-07
4	CEP55 RRM2 DTL CENPF	7.19E-07

Table XX

type	genes	pval	n
CCP	C18orf24 PBK	2.76E-06	29
CCP	C18orf24 PLK1	3.88E-06	29
CCP	C18orf24 DLGAP5	1.84E-06	29
CCP	C18orf24 FOXM1	1.79E-06	29
CCP	C18orf24 MCM10	4.03E-06	29
CCP	C18orf24 CEP55	6.28E-06	29
CCP	C18orf24 RRM2	4.31E-06	29
CCP	C18orf24 DTL	3.78E-06	29
CCP	C18orf24 CENPF	4.40E-06	29
CCP	PBK PLK1	3.85E-06	29
CCP	PBK DLGAP5	3.79E-05	29
CCP	PBK FOXM1	2.45E-05	29
CCP	PBK MCM10	9.54E-06	29
CCP	PBK CEP55	2.84E-06	29
CCP	PBK RRM2	3.20E-05	29
CCP	PBK DTL	7.93E-06	29
CCP	PBK CENPF	3.10E-06	29
CCP	PLK1 DLGAP5	3.12E-06	30
CCP	PLK1 FOXM1	3.67E-06	29
CCP	PLK1 MCM10	1.94E-05	29
CCP	PLK1 CEP55	5.98E-06	30
CCP	PLK1 RRM2	1.16E-05	30
CCP	PLK1 DTL	5.99E-06	30
CCP	PLK1 CENPF	1.72E-05	30
CCP	DLGAP5 FOXM1	2.45E-05	29
CCP	DLGAP5 MCM10	1.95E-05	29
CCP	DLGAP5 CEP55	0.00013	30
CCP	DLGAP5 RRM2	0.000132	30

CCP	DLGAP5 DTL	3.80E-06	30
CCP	DLGAP5 CENPF	1.04E-05	30
CCP	FOXM1 MCM10	1.28E-05	29
CCP	FOXM1 CEP55	2.57E-06	29
CCP	FOXM1 RRM2	1.88E-05	29
CCP	FOXM1 DTL	4.61E-06	29
CCP	FOXM1 CENPF	2.39E-06	29
CCP	MCM10 CEP55	1.51E-05	29
CCP	MCM10 RRM2	4.52E-05	29
CCP	MCM10 DTL	5.91E-06	29
CCP	MCM10 CENPF	2.54E-05	29
CCP	CEP55 RRM2	7.82E-05	30
CCP	CEP55 DTL	3.90E-06	30
CCP	CEP55 CENPF	2.18E-05	30
CCP	RRM2 DTL	4.43E-06	30
CCP	RRM2 CENPF	2.10E-05	30
CCP	DTL CENPF	7.11E-06	30
Immune/Additional	HEY1 CXCL10	1.54E-10	50
Immune/Additional	HEY1 CCL3	1.22E-09	78
Immune/Additional	HEY1 FABP7	2.58E-07	79
Immune/Additional	HEY1 FN1	1.49E-06	79
Immune/Additional	HEY1 PTN	0.000108	79
Immune/Additional	HEY1 IGJ	2.86E-06	50
Immune/Additional	HEY1 PRAME	6.21E-09	76
Immune/Additional	HEY1 BCL2A1	2.06E-06	78
Immune/Additional	HEY1 IFI6	6.07E-06	73
Immune/Additional	HEY1 CFH	6.34E-05	79
Immune/Additional	HEY1 HLA	1.91E-06	52
Immune/Additional	HEY1 PECAM1	2.94E-05	52
Immune/Additional	HEY1 PTPN22	2.52E-07	52
Immune/Additional	HEY1 RGS1	1.44E-14	79
Immune/Additional	HEY1 IRF1	5.61E-09	52
Immune/Additional	HEY1 CCL5	5.43E-11	52
Immune/Additional	HEY1 CD38	9.00E-11	49
Immune/Additional	HEY1 SELL	1.27E-10	52
Immune/Additional	HEY1 HLA	6.11E-06	52
Immune/Additional	HEY1 S100A9	1.05E-08	52
Immune/Additional	HEY1 ITGB2	4.91E-06	52
Immune/Additional	HEY1 PTPRC	4.07E-07	52
Immune/Additional	HEY1 CXCL13	1.61E-09	48
Immune/Additional	HEY1 PHACTR1	1.05E-06	78
Immune/Additional	HEY1 SPP1	5.19E-10	78
Immune/Additional	HEY1 LCP2	9.82E-09	52
Immune/Additional	HEY1 KRT15	1.05E-11	79
Immune/Additional	HEY1 CXCL9	1.84E-10	52
Immune/Additional	HEY1 HCLS1	2.40E-05	52
Immune/Additional	CXCL10 CCL3	2.51E-10	50
Immune/Additional	CXCL10 FABP7	6.14E-11	50
Immune/Additional	CXCL10 FN1	4.37E-11	50
Immune/Additional	CXCL10 PTN	3.58E-10	50
Immune/Additional	CXCL10 IGJ	2.34E-10	48
Immune/Additional	CXCL10 PRAME	2.26E-10	50
Immune/Additional	CXCL10 BCL2A1	2.33E-10	50

Immune/Additional	CXCL10 IFI6	2.64E-10	47
Immune/Additional	CXCL10 CFH	2.54E-10	50
Immune/Additional	CXCL10 HLA	1.60E-10	50
Immune/Additional	CXCL10 PECAM1	2.46E-10	50
Immune/Additional	CXCL10 PTPN22	2.16E-10	50
Immune/Additional	CXCL10 RGS1	2.49E-11	50
Immune/Additional	CXCL10 IRF1	2.39E-10	50
Immune/Additional	CXCL10 CCL5	2.29E-10	50
Immune/Additional	CXCL10 CD38	4.47E-10	48
Immune/Additional	CXCL10 SELL	1.30E-10	50
Immune/Additional	CXCL10 HLA	2.71E-10	50
Immune/Additional	CXCL10 S100A9	1.39E-10	50
Immune/Additional	CXCL10 ITGB2	3.34E-10	50
Immune/Additional	CXCL10 PTPRC	1.25E-10	50
Immune/Additional	CXCL10 CXCL13	8.57E-10	46
Immune/Additional	CXCL10 PHACTR1	5.53E-11	50
Immune/Additional	CXCL10 SPP1	1.29E-10	49
Immune/Additional	CXCL10 LCP2	3.18E-10	50
Immune/Additional	CXCL10 KRT15	1.94E-12	50
Immune/Additional	CXCL10 CXCL9	1.32E-10	50
Immune/Additional	CXCL10 HCLS1	2.82E-10	50
Immune/Additional	CCL3 FABP7	7.30E-09	78
Immune/Additional	CCL3 FN1	3.23E-10	78
Immune/Additional	CCL3 PTN	5.96E-08	78
Immune/Additional	CCL3 IGJ	5.68E-06	50
Immune/Additional	CCL3 PRAME	1.42E-10	76
Immune/Additional	CCL3 BCL2A1	2.24E-09	78
Immune/Additional	CCL3 IFI6	5.70E-10	73
Immune/Additional	CCL3 CFH	4.01E-09	78
Immune/Additional	CCL3 HLA	4.15E-05	52
Immune/Additional	CCL3 PECAM1	3.80E-05	52
Immune/Additional	CCL3 PTPN22	2.20E-05	52
Immune/Additional	CCL3 RGS1	2.11E-13	78
Immune/Additional	CCL3 IRF1	1.96E-07	52
Immune/Additional	CCL3 CCL5	3.60E-09	52
Immune/Additional	CCL3 CD38	4.84E-09	49
Immune/Additional	CCL3 SELL	2.17E-08	52
Immune/Additional	CCL3 HLA	1.73E-05	52
Immune/Additional	CCL3 S100A9	3.86E-06	52
Immune/Additional	CCL3 ITGB2	4.55E-06	52
Immune/Additional	CCL3 PTPRC	8.63E-05	52
Immune/Additional	CCL3 CXCL13	8.90E-09	48
Immune/Additional	CCL3 PHACTR1	1.33E-09	78
Immune/Additional	CCL3 SPP1	2.68E-11	77
Immune/Additional	CCL3 LCP2	1.00E-06	52
Immune/Additional	CCL3 KRT15	8.96E-14	78
Immune/Additional	CCL3 CXCL9	1.07E-09	52
Immune/Additional	CCL3 HCLS1	6.08E-05	52
Immune/Additional	FABP7 FN1	1.78E-07	79
Immune/Additional	FABP7 PTN	2.27E-05	79
Immune/Additional	FABP7 IGJ	5.08E-05	50
Immune/Additional	FABP7 PRAME	1.28E-09	76
Immune/Additional	FABP7 BCL2A1	8.49E-08	78

Immune/Additional	FABP7 IFI6	1.86E-06	73
Immune/Additional	FABP7 CFH	3.20E-06	79
Immune/Additional	FABP7 HLA	5.35E-05	52
Immune/Additional	FABP7 PECAM1	0.000245	52
Immune/Additional	FABP7 PTPN22	1.22E-05	52
Immune/Additional	FABP7 RGS1	8.23E-14	79
Immune/Additional	FABP7 IRF1	2.27E-07	52
Immune/Additional	FABP7 CCL5	8.87E-10	52
Immune/Additional	FABP7 CD38	1.05E-09	49
Immune/Additional	FABP7 SELL	2.67E-09	52
Immune/Additional	FABP7 HLA	0.00011	52
Immune/Additional	FABP7 S100A9	1.11E-05	52
Immune/Additional	FABP7 ITGB2	3.71E-05	52
Immune/Additional	FABP7 PTPRC	8.11E-05	52
Immune/Additional	FABP7 CXCL13	2.09E-09	48
Immune/Additional	FABP7 PHACTR1	7.46E-08	78
Immune/Additional	FABP7 SPP1	3.72E-10	78
Immune/Additional	FABP7 LCP2	3.95E-07	52
Immune/Additional	FABP7 KRT15	2.19E-11	79
Immune/Additional	FABP7 CXCL9	3.66E-10	52
Immune/Additional	FABP7 HCLS1	0.000618	52
Immune/Additional	FN1 PTN	2.19E-06	79
Immune/Additional	FN1 IGJ	1.24E-05	50
Immune/Additional	FN1 PRAME	8.56E-11	76
Immune/Additional	FN1 BCL2A1	6.94E-10	80
Immune/Additional	FN1 IFI6	1.56E-07	75
Immune/Additional	FN1 CFH	1.53E-07	79
Immune/Additional	FN1 HLA	1.75E-05	52
Immune/Additional	FN1 PECAM1	2.43E-05	52
Immune/Additional	FN1 PTPN22	1.91E-06	52
Immune/Additional	FN1 RGS1	1.86E-14	81
Immune/Additional	FN1 IRF1	3.87E-08	52
Immune/Additional	FN1 CCL5	2.24E-10	52
Immune/Additional	FN1 CD38	1.18E-09	49
Immune/Additional	FN1 SELL	1.60E-09	52
Immune/Additional	FN1 HLA	2.03E-05	52
Immune/Additional	FN1 S100A9	1.57E-08	52
Immune/Additional	FN1 ITGB2	7.52E-06	52
Immune/Additional	FN1 PTPRC	2.23E-06	52
Immune/Additional	FN1 CXCL13	2.70E-10	48
Immune/Additional	FN1 PHACTR1	1.20E-08	78
Immune/Additional	FN1 SPP1	1.19E-10	80
Immune/Additional	FN1 LCP2	1.06E-07	52
Immune/Additional	FN1 KRT15	5.41E-11	79
Immune/Additional	FN1 CXCL9	5.73E-11	52
Immune/Additional	FN1 HCLS1	3.39E-05	52
Immune/Additional	PTN IGJ	0.000612	50
Immune/Additional	PTN PRAME	3.23E-08	76
Immune/Additional	PTN BCL2A1	5.21E-06	78
Immune/Additional	PTN IFI6	3.65E-06	73
Immune/Additional	PTN CFH	0.000585	79
Immune/Additional	PTN HLA	0.000518	52
Immune/Additional	PTN PECAM1	0.001185	52

Immune/Additional	PTN PTPN22	0.000136	52
Immune/Additional	PTN RGS1	6.74E-13	79
Immune/Additional	PTN IRF1	4.83E-07	52
Immune/Additional	PTN CCL5	3.78E-09	52
Immune/Additional	PTN CD38	7.93E-09	49
Immune/Additional	PTN SELL	1.39E-08	52
Immune/Additional	PTN HLA	0.000275	52
Immune/Additional	PTN S100A9	2.00E-05	52
Immune/Additional	PTN ITGB2	8.87E-05	52
Immune/Additional	PTN PTPRC	0.00121	52
Immune/Additional	PTN CXCL13	1.26E-08	48
Immune/Additional	PTN PHACTR1	9.62E-07	78
Immune/Additional	PTN SPP1	2.59E-09	78
Immune/Additional	PTN LCP2	1.54E-06	52
Immune/Additional	PTN KRT15	4.49E-11	79
Immune/Additional	PTN CXCL9	1.22E-09	52
Immune/Additional	PTN HCLS1	0.004588	52
Immune/Additional	IGJ PRAME	7.28E-07	50
Immune/Additional	IGJ BCL2A1	5.28E-06	50
Immune/Additional	IGJ IFI6	8.23E-05	47
Immune/Additional	IGJ CFH	0.000244	50
Immune/Additional	IGJ HLA	0.000484	50
Immune/Additional	IGJ PECAM1	0.000469	50
Immune/Additional	IGJ PTPN22	1.66E-05	50
Immune/Additional	IGJ RGS1	7.60E-09	50
Immune/Additional	IGJ IRF1	8.66E-08	50
Immune/Additional	IGJ CCL5	2.21E-10	50
Immune/Additional	IGJ CD38	4.38E-08	47
Immune/Additional	IGJ SELL	2.63E-08	50
Immune/Additional	IGJ HLA	0.000321	50
Immune/Additional	IGJ S100A9	6.51E-05	50
Immune/Additional	IGJ ITGB2	9.60E-05	50
Immune/Additional	IGJ PTPRC	0.000199	50
Immune/Additional	IGJ CXCL13	2.02E-09	46
Immune/Additional	IGJ PHACTR1	5.37E-06	50
Immune/Additional	IGJ SPP1	2.34E-06	49
Immune/Additional	IGJ LCP2	2.62E-06	50
Immune/Additional	IGJ KRT15	1.27E-10	50
Immune/Additional	IGJ CXCL9	5.41E-11	50
Immune/Additional	IGJ HCLS1	0.001058	50
Immune/Additional	PRAME BCL2A1	1.49E-08	76
Immune/Additional	PRAME IFI6	1.53E-09	71
Immune/Additional	PRAME CFH	2.22E-08	76
Immune/Additional	PRAME HLA	4.16E-07	52
Immune/Additional	PRAME PECAM1	3.62E-07	52
Immune/Additional	PRAME PTPN22	6.26E-08	52
Immune/Additional	PRAME RGS1	1.59E-14	76
Immune/Additional	PRAME IRF1	1.69E-08	52
Immune/Additional	PRAME CCL5	4.98E-10	52
Immune/Additional	PRAME CD38	3.68E-09	49
Immune/Additional	PRAME SELL	2.91E-10	52
Immune/Additional	PRAME HLA	1.01E-07	52
Immune/Additional	PRAME S100A9	4.66E-07	52

Immune/Additional	PRAME ITGB2	4.59E-08	52
Immune/Additional	PRAME PTPRC	6.65E-07	52
Immune/Additional	PRAME CXCL13	6.08E-09	48
Immune/Additional	PRAME PHACTR1	1.41E-09	76
Immune/Additional	PRAME SPP1	2.72E-12	75
Immune/Additional	PRAME LCP2	1.40E-08	52
Immune/Additional	PRAME KRT15	1.24E-13	76
Immune/Additional	PRAME CXCL9	1.41E-10	52
Immune/Additional	PRAME HCLS1	2.34E-07	52
Immune/Additional	BCL2A1 IFI6	2.60E-07	75
Immune/Additional	BCL2A1 CFH	1.70E-06	78
Immune/Additional	BCL2A1 HLA	4.86E-06	52
Immune/Additional	BCL2A1 PECAM1	9.68E-06	52
Immune/Additional	BCL2A1 PTPN22	8.54E-07	52
Immune/Additional	BCL2A1 RGS1	1.44E-15	80
Immune/Additional	BCL2A1 IRF1	8.10E-08	52
Immune/Additional	BCL2A1 CCL5	1.04E-09	52
Immune/Additional	BCL2A1 CD38	2.63E-09	49
Immune/Additional	BCL2A1 SELL	6.78E-10	52
Immune/Additional	BCL2A1 HLA	7.02E-06	52
Immune/Additional	BCL2A1 S100A9	1.46E-06	52
Immune/Additional	BCL2A1 ITGB2	5.56E-06	52
Immune/Additional	BCL2A1 PTPRC	9.48E-06	52
Immune/Additional	BCL2A1 CXCL13	8.21E-09	48
Immune/Additional	BCL2A1 PHACTR1	1.47E-07	78
Immune/Additional	BCL2A1 SPP1	5.11E-11	79
Immune/Additional	BCL2A1 LCP2	1.96E-07	52
Immune/Additional	BCL2A1 KRT15	1.03E-10	78
Immune/Additional	BCL2A1 CXCL9	7.62E-10	52
Immune/Additional	BCL2A1 HCLS1	2.07E-05	52
Immune/Additional	IFI6 CFH	3.68E-06	73
Immune/Additional	IFI6 HLA	7.56E-05	48
Immune/Additional	IFI6 PECAM1	5.43E-05	48
Immune/Additional	IFI6 PTPN22	2.22E-06	48
Immune/Additional	IFI6 RGS1	2.29E-14	75
Immune/Additional	IFI6 IRF1	1.67E-07	48
Immune/Additional	IFI6 CCL5	1.41E-10	48
Immune/Additional	IFI6 CD38	8.58E-09	47
Immune/Additional	IFI6 SELL	5.75E-09	48
Immune/Additional	IFI6 HLA	0.000195	48
Immune/Additional	IFI6 S100A9	8.00E-07	48
Immune/Additional	IFI6 ITGB2	0.00015	48
Immune/Additional	IFI6 PTPRC	2.48E-06	48
Immune/Additional	IFI6 CXCL13	5.65E-10	44
Immune/Additional	IFI6 PHACTR1	6.48E-07	73
Immune/Additional	IFI6 SPP1	4.87E-11	74
Immune/Additional	IFI6 LCP2	1.34E-06	48
Immune/Additional	IFI6 KRT15	4.94E-10	73
Immune/Additional	IFI6 CXCL9	4.76E-11	48
Immune/Additional	IFI6 HCLS1	0.00025	48
Immune/Additional	CFH HLA	8.66E-06	52
Immune/Additional	CFH PECAM1	7.69E-05	52
Immune/Additional	CFH PTPN22	9.54E-06	52

Immune/Additional	CFH RGS1	1.04E-13	79
Immune/Additional	CFH IRF1	5.53E-08	52
Immune/Additional	CFH CCL5	2.63E-10	52
Immune/Additional	CFH CD38	3.05E-09	49
Immune/Additional	CFH SELL	6.80E-11	52
Immune/Additional	CFH HLA	2.71E-05	52
Immune/Additional	CFH S100A9	4.14E-05	52
Immune/Additional	CFH ITGB2	8.68E-06	52
Immune/Additional	CFH PTPRC	4.04E-05	52
Immune/Additional	CFH CXCL13	3.56E-09	48
Immune/Additional	CFH PHACTR1	6.52E-07	78
Immune/Additional	CFH SPP1	3.73E-10	78
Immune/Additional	CFH LCP2	2.72E-07	52
Immune/Additional	CFH KRT15	2.57E-11	79
Immune/Additional	CFH CXCL9	1.90E-10	52
Immune/Additional	CFH HCLS1	0.000201	52
Immune/Additional	HLA PECAM1	0.00018	52
Immune/Additional	HLA PTPN22	0.000137	52
Immune/Additional	HLA RGS1	1.18E-08	52
Immune/Additional	HLA IRF1	5.15E-07	52
Immune/Additional	HLA CCL5	1.15E-09	52
Immune/Additional	HLA CD38	4.54E-08	49
Immune/Additional	HLA SELL	2.06E-08	52
Immune/Additional	HLA HLA	0.000606	52
Immune/Additional	HLA S100A9	5.76E-06	52
Immune/Additional	HLA ITGB2	0.000104	52
Immune/Additional	HLA PTPRC	0.000677	52
Immune/Additional	HLA CXCL13	1.20E-08	48
Immune/Additional	HLA PHACTR1	4.78E-07	52
Immune/Additional	HLA SPP1	2.02E-06	51
Immune/Additional	HLA LCP2	2.60E-06	52
Immune/Additional	HLA KRT15	1.30E-10	52
Immune/Additional	HLA CXCL9	6.15E-10	52
Immune/Additional	HLA HCLS1	0.000831	52
Immune/Additional	PECAM1 PTPN22	5.46E-05	52
Immune/Additional	PECAM1 RGS1	2.18E-09	52
Immune/Additional	PECAM1 IRF1	3.88E-07	52
Immune/Additional	PECAM1 CCL5	3.68E-09	52
Immune/Additional	PECAM1 CD38	6.53E-09	49
Immune/Additional	PECAM1 SELL	2.58E-08	52
Immune/Additional	PECAM1 HLA	0.000172	52
Immune/Additional	PECAM1 S100A9	1.05E-05	52
Immune/Additional	PECAM1 ITGB2	0.000148	52
Immune/Additional	PECAM1 PTPRC	0.000492	52
Immune/Additional	PECAM1 CXCL13	3.31E-09	48
Immune/Additional	PECAM1 PHACTR1	1.99E-05	52
Immune/Additional	PECAM1 SPP1	4.86E-06	51
Immune/Additional	PECAM1 LCP2	2.21E-06	52
Immune/Additional	PECAM1 KRT15	2.02E-10	52
Immune/Additional	PECAM1 CXCL9	1.00E-09	52
Immune/Additional	PECAM1 HCLS1	0.00209	52
Immune/Additional	PTPN22 RGS1	9.07E-09	52
Immune/Additional	PTPN22 IRF1	4.83E-07	52

Immune/Additional	PTPN22 CCL5	4.80E-10	52
Immune/Additional	PTPN22 CD38	3.32E-08	49
Immune/Additional	PTPN22 SELL	3.20E-08	52
Immune/Additional	PTPN22 HLA	7.86E-05	52
Immune/Additional	PTPN22 S100A9	4.52E-06	52
Immune/Additional	PTPN22 ITGB2	1.27E-05	52
Immune/Additional	PTPN22 PTPRC	0.000269	52
Immune/Additional	PTPN22 CXCL13	1.22E-08	48
Immune/Additional	PTPN22 PHACTR1	9.01E-08	52
Immune/Additional	PTPN22 SPP1	1.15E-07	51
Immune/Additional	PTPN22 LCP2	2.41E-06	52
Immune/Additional	PTPN22 KRT15	1.39E-11	52
Immune/Additional	PTPN22 CXCL9	1.05E-09	52
Immune/Additional	PTPN22 HCLS1	0.000267	52
Immune/Additional	RGS1 IRF1	3.00E-09	52
Immune/Additional	RGS1 CCL5	5.00E-10	52
Immune/Additional	RGS1 CD38	8.59E-10	49
Immune/Additional	RGS1 SELL	7.08E-10	52
Immune/Additional	RGS1 HLA	1.24E-08	52
Immune/Additional	RGS1 S100A9	8.85E-10	52
Immune/Additional	RGS1 ITGB2	2.49E-09	52
Immune/Additional	RGS1 PTPRC	9.02E-09	52
Immune/Additional	RGS1 CXCL13	9.90E-10	48
Immune/Additional	RGS1 PHACTR1	4.53E-15	78
Immune/Additional	RGS1 SPP1	7.14E-16	80
Immune/Additional	RGS1 LCP2	1.81E-09	52
Immune/Additional	RGS1 KRT15	9.63E-17	79
Immune/Additional	RGS1 CXCL9	1.28E-10	52
Immune/Additional	RGS1 HCLS1	7.83E-09	52
Immune/Additional	IRF1 CCL5	2.15E-09	52
Immune/Additional	IRF1 CD38	1.45E-08	49
Immune/Additional	IRF1 SELL	1.31E-08	52
Immune/Additional	IRF1 HLA	5.22E-07	52
Immune/Additional	IRF1 S100A9	5.05E-08	52
Immune/Additional	IRF1 ITGB2	5.80E-07	52
Immune/Additional	IRF1 PTPRC	4.43E-07	52
Immune/Additional	IRF1 CXCL13	5.13E-09	48
Immune/Additional	IRF1 PHACTR1	1.09E-08	52
Immune/Additional	IRF1 SPP1	1.90E-08	51
Immune/Additional	IRF1 LCP2	2.48E-07	52
Immune/Additional	IRF1 KRT15	1.40E-12	52
Immune/Additional	IRF1 CXCL9	1.16E-09	52
Immune/Additional	IRF1 HCLS1	2.76E-07	52
Immune/Additional	CCL5 CD38	1.06E-09	49
Immune/Additional	CCL5 SELL	1.69E-09	52
Immune/Additional	CCL5 HLA	3.02E-09	52
Immune/Additional	CCL5 S100A9	1.40E-09	52
Immune/Additional	CCL5 ITGB2	2.93E-09	52
Immune/Additional	CCL5 PTPRC	3.10E-13	52
Immune/Additional	CCL5 CXCL13	2.12E-09	48
Immune/Additional	CCL5 PHACTR1	1.49E-10	52
Immune/Additional	CCL5 SPP1	3.63E-10	51
Immune/Additional	CCL5 LCP2	2.51E-09	52

Immune/Additional	CCL5 KRT15	1.41E-12	52
Immune/Additional	CCL5 CXCL9	6.43E-10	52
Immune/Additional	CCL5 HCLS1	1.36E-09	52
Immune/Additional	CD38 SELL	6.31E-09	49
Immune/Additional	CD38 HLA	3.70E-08	49
Immune/Additional	CD38 S100A9	1.02E-08	49
Immune/Additional	CD38 ITGB2	1.99E-08	49
Immune/Additional	CD38 PTPRC	5.17E-08	49
Immune/Additional	CD38 CXCL13	3.25E-09	46
Immune/Additional	CD38 PHACTR1	4.58E-10	49
Immune/Additional	CD38 SPP1	1.43E-09	48
Immune/Additional	CD38 LCP2	3.38E-08	49
Immune/Additional	CD38 KRT15	1.17E-11	49
Immune/Additional	CD38 CXCL9	2.23E-10	49
Immune/Additional	CD38 HCLS1	4.45E-08	49
Immune/Additional	SELL HLA	2.63E-08	52
Immune/Additional	SELL S100A9	1.25E-08	52
Immune/Additional	SELL ITGB2	3.37E-08	52
Immune/Additional	SELL PTPRC	1.01E-08	52
Immune/Additional	SELL CXCL13	2.54E-09	48
Immune/Additional	SELL PHACTR1	8.28E-12	52
Immune/Additional	SELL SPP1	1.07E-09	51
Immune/Additional	SELL LCP2	1.86E-08	52
Immune/Additional	SELL KRT15	1.15E-12	52
Immune/Additional	SELL CXCL9	1.03E-09	52
Immune/Additional	SELL HCLS1	9.23E-09	52
Immune/Additional	HLA S100A9	6.82E-07	52
Immune/Additional	HLA ITGB2	0.000111	52
Immune/Additional	HLA PTPRC	0.000408	52
Immune/Additional	HLA CXCL13	5.87E-09	48
Immune/Additional	HLA PHACTR1	3.24E-06	52
Immune/Additional	HLA SPP1	2.32E-06	51
Immune/Additional	HLA LCP2	2.63E-06	52
Immune/Additional	HLA KRT15	1.04E-09	52
Immune/Additional	HLA CXCL9	1.24E-09	52
Immune/Additional	HLA HCLS1	0.000741	52
Immune/Additional	S100A9 ITGB2	6.11E-07	52
Immune/Additional	S100A9 PTPRC	2.82E-05	52
Immune/Additional	S100A9 CXCL13	1.20E-08	48
Immune/Additional	S100A9 PHACTR1	7.76E-08	52
Immune/Additional	S100A9 SPP1	1.35E-09	51
Immune/Additional	S100A9 LCP2	6.68E-08	52
Immune/Additional	S100A9 KRT15	1.39E-11	52
Immune/Additional	S100A9 CXCL9	3.73E-10	52
Immune/Additional	S100A9 HCLS1	2.40E-05	52
Immune/Additional	ITGB2 PTPRC	5.57E-05	52
Immune/Additional	ITGB2 CXCL13	3.27E-09	48
Immune/Additional	ITGB2 PHACTR1	1.34E-06	52
Immune/Additional	ITGB2 SPP1	1.83E-06	51
Immune/Additional	ITGB2 LCP2	1.74E-06	52
Immune/Additional	ITGB2 KRT15	1.83E-10	52
Immune/Additional	ITGB2 CXCL9	1.27E-09	52
Immune/Additional	ITGB2 HCLS1	0.000143	52

Immune/Additional	PTPRC CXCL13	1.28E-08	48
Immune/Additional	PTPRC PHACTR1	9.30E-07	52
Immune/Additional	PTPRC SPP1	1.52E-06	51
Immune/Additional	PTPRC LCP2	1.72E-06	52
Immune/Additional	PTPRC KRT15	1.38E-11	52
Immune/Additional	PTPRC CXCL9	1.30E-10	52
Immune/Additional	PTPRC HCLS1	0.001982	52
Immune/Additional	CXCL13 PHACTR1	1.04E-09	48
Immune/Additional	CXCL13 SPP1	1.24E-09	47
Immune/Additional	CXCL13 LCP2	2.17E-09	48
Immune/Additional	CXCL13 KRT15	4.98E-11	48
Immune/Additional	CXCL13 CXCL9	1.44E-09	48
Immune/Additional	CXCL13 HCLS1	8.81E-09	48
Immune/Additional	PHACTR1 SPP1	1.08E-10	77
Immune/Additional	PHACTR1 LCP2	5.75E-08	52
Immune/Additional	PHACTR1 KRT15	1.82E-11	78
Immune/Additional	PHACTR1 CXCL9	2.74E-11	52
Immune/Additional	PHACTR1 HCLS1	1.34E-05	52
Immune/Additional	SPP1 LCP2	8.37E-08	51
Immune/Additional	SPP1 KRT15	8.66E-13	78
Immune/Additional	SPP1 CXCL9	1.60E-10	51
Immune/Additional	SPP1 HCLS1	5.76E-06	51
Immune/Additional	LCP2 KRT15	1.70E-11	52
Immune/Additional	LCP2 CXCL9	1.13E-09	52
Immune/Additional	LCP2 HCLS1	2.91E-06	52
Immune/Additional	KRT15 CXCL9	6.42E-13	52
Immune/Additional	KRT15 HCLS1	2.51E-10	52
Immune/Additional	CXCL9 HCLS1	5.62E-10	52
CCP/Immune/Additional	C18orf24 HEY1	5.85E-05	26
CCP/Immune/Additional	C18orf24 CCL3	3.94E-05	26
CCP/Immune/Additional	C18orf24 FABP7	1.80E-05	26
CCP/Immune/Additional	C18orf24 FN1	5.36E-06	28
CCP/Immune/Additional	C18orf24 PTN	5.99E-05	26
CCP/Immune/Additional	C18orf24 PRAME	3.08E-05	24
CCP/Immune/Additional	C18orf24 BCL2A1	8.35E-06	28
CCP/Immune/Additional	C18orf24 IFI6	8.84E-06	27
CCP/Immune/Additional	C18orf24 CFH	4.86E-05	26
CCP/Immune/Additional	C18orf24 RGS1	3.63E-06	28
CCP/Immune/Additional	C18orf24 PHACTR1	4.73E-05	26
CCP/Immune/Additional	C18orf24 SPP1	4.43E-06	28
CCP/Immune/Additional	C18orf24 KRT15	3.32E-05	26
CCP/Immune/Additional	PBK HEY1	0.000325	26
CCP/Immune/Additional	PBK CCL3	0.00014	26
CCP/Immune/Additional	PBK FABP7	0.000157	26
CCP/Immune/Additional	PBK FN1	3.72E-05	28
CCP/Immune/Additional	PBK PTN	0.000215	26
CCP/Immune/Additional	PBK PRAME	0.000425	24
CCP/Immune/Additional	PBK BCL2A1	5.82E-05	28
CCP/Immune/Additional	PBK IFI6	6.75E-05	27
CCP/Immune/Additional	PBK CFH	0.000292	26
CCP/Immune/Additional	PBK RGS1	9.29E-06	28
CCP/Immune/Additional	PBK PHACTR1	0.000384	26
CCP/Immune/Additional	PBK SPP1	7.27E-06	28

CCP/Immune/Additional	PBK KRT15	9.68E-05	26
CCP/Immune/Additional	PLK1 HEY1	5.62E-05	27
CCP/Immune/Additional	PLK1 CCL3	0.000102	26
CCP/Immune/Additional	PLK1 FABP7	5.48E-05	27
CCP/Immune/Additional	PLK1 FN1	2.02E-05	29
CCP/Immune/Additional	PLK1 PTN	4.72E-05	27
CCP/Immune/Additional	PLK1 PRAME	9.46E-05	24
CCP/Immune/Additional	PLK1 BCL2A1	1.04E-05	28
CCP/Immune/Additional	PLK1 IFI6	2.14E-05	27
CCP/Immune/Additional	PLK1 CFH	0.000128	27
CCP/Immune/Additional	PLK1 RGS1	8.92E-06	29
CCP/Immune/Additional	PLK1 PHACTR1	0.000164	26
CCP/Immune/Additional	PLK1 SPP1	1.30E-05	29
CCP/Immune/Additional	PLK1 KRT15	2.78E-05	27
CCP/Immune/Additional	DLGAP5 HEY1	0.00312	27
CCP/Immune/Additional	DLGAP5 CCL3	9.72E-05	26
CCP/Immune/Additional	DLGAP5 FABP7	0.001317	27
CCP/Immune/Additional	DLGAP5 FN1	0.000619	29
CCP/Immune/Additional	DLGAP5 PTN	0.003429	27
CCP/Immune/Additional	DLGAP5 PRAME	0.000944	24
CCP/Immune/Additional	DLGAP5 BCL2A1	8.89E-05	28
CCP/Immune/Additional	DLGAP5 IFI6	0.000124	27
CCP/Immune/Additional	DLGAP5 CFH	0.003343	27
CCP/Immune/Additional	DLGAP5 RGS1	2.08E-05	29
CCP/Immune/Additional	DLGAP5 PHACTR1	0.001083	26
CCP/Immune/Additional	DLGAP5 SPP1	1.65E-05	29
CCP/Immune/Additional	DLGAP5 KRT15	0.000588	27
CCP/Immune/Additional	FOXM1 HEY1	0.00017	26
CCP/Immune/Additional	FOXM1 CCL3	5.45E-05	26
CCP/Immune/Additional	FOXM1 FABP7	9.52E-05	26
CCP/Immune/Additional	FOXM1 FN1	2.60E-05	28
CCP/Immune/Additional	FOXM1 PTN	0.000135	26
CCP/Immune/Additional	FOXM1 PRAME	0.000248	24
CCP/Immune/Additional	FOXM1 BCL2A1	2.31E-05	28
CCP/Immune/Additional	FOXM1 IFI6	2.42E-05	27
CCP/Immune/Additional	FOXM1 CFH	0.000167	26
CCP/Immune/Additional	FOXM1 RGS1	5.89E-06	28
CCP/Immune/Additional	FOXM1 PHACTR1	0.00015	26
CCP/Immune/Additional	FOXM1 SPP1	1.11E-05	28
CCP/Immune/Additional	FOXM1 KRT15	6.62E-05	26
CCP/Immune/Additional	MCM10 HEY1	0.000797	26
CCP/Immune/Additional	MCM10 CCL3	6.76E-05	26
CCP/Immune/Additional	MCM10 FABP7	0.000278	26
CCP/Immune/Additional	MCM10 FN1	0.000123	28
CCP/Immune/Additional	MCM10 PTN	0.000778	26
CCP/Immune/Additional	MCM10 PRAME	0.000394	24
CCP/Immune/Additional	MCM10 BCL2A1	4.19E-05	28
CCP/Immune/Additional	MCM10 IFI6	2.26E-05	27
CCP/Immune/Additional	MCM10 CFH	0.000605	26
CCP/Immune/Additional	MCM10 RGS1	1.91E-05	28
CCP/Immune/Additional	MCM10 PHACTR1	0.000376	26
CCP/Immune/Additional	MCM10 SPP1	2.95E-05	28
CCP/Immune/Additional	MCM10 KRT15	0.000253	26

CCP/Immune/Additional	CEP55 HEY1	0.006628	27
CCP/Immune/Additional	CEP55 CCL3	7.18E-05	26
CCP/Immune/Additional	CEP55 FABP7	0.001276	27
CCP/Immune/Additional	CEP55 FN1	0.001029	29
CCP/Immune/Additional	CEP55 PTN	0.006228	27
CCP/Immune/Additional	CEP55 PRAME	6.91E-05	24
CCP/Immune/Additional	CEP55 BCL2A1	1.67E-05	28
CCP/Immune/Additional	CEP55 IFI6	1.61E-05	27
CCP/Immune/Additional	CEP55 CFH	0.004256	27
CCP/Immune/Additional	CEP55 RGS1	6.16E-05	29
CCP/Immune/Additional	CEP55 PHACTR1	8.03E-05	26
CCP/Immune/Additional	CEP55 SPP1	2.23E-05	29
CCP/Immune/Additional	CEP55 KRT15	0.00161	27
CCP/Immune/Additional	RRM2 HEY1	0.002325	27
CCP/Immune/Additional	RRM2 CCL3	0.000657	26
CCP/Immune/Additional	RRM2 FABP7	0.000572	27
CCP/Immune/Additional	RRM2 FN1	0.000235	29
CCP/Immune/Additional	RRM2 PTN	0.001985	27
CCP/Immune/Additional	RRM2 PRAME	0.001068	24
CCP/Immune/Additional	RRM2 BCL2A1	9.16E-05	28
CCP/Immune/Additional	RRM2 IFI6	5.58E-05	27
CCP/Immune/Additional	RRM2 CFH	0.001764	27
CCP/Immune/Additional	RRM2 RGS1	2.32E-05	29
CCP/Immune/Additional	RRM2 PHACTR1	0.001505	26
CCP/Immune/Additional	RRM2 SPP1	1.44E-05	29
CCP/Immune/Additional	RRM2 KRT15	7.47E-05	27
CCP/Immune/Additional	DTL HEY1	3.43E-05	27
CCP/Immune/Additional	DTL CCL3	4.30E-05	26
CCP/Immune/Additional	DTL FABP7	4.43E-05	27
CCP/Immune/Additional	DTL FN1	6.55E-06	29
CCP/Immune/Additional	DTL PTN	3.14E-05	27
CCP/Immune/Additional	DTL PRAME	8.49E-05	24
CCP/Immune/Additional	DTL BCL2A1	7.58E-06	28
CCP/Immune/Additional	DTL IFI6	1.61E-05	27
CCP/Immune/Additional	DTL CFH	3.93E-05	27
CCP/Immune/Additional	DTL RGS1	6.10E-06	29
CCP/Immune/Additional	DTL PHACTR1	7.43E-05	26
CCP/Immune/Additional	DTL SPP1	9.41E-06	29
CCP/Immune/Additional	DTL KRT15	1.93E-05	27
CCP/Immune/Additional	CENPF HEY1	0.000139	27
CCP/Immune/Additional	CENPF CCL3	0.000159	26
CCP/Immune/Additional	CENPF FABP7	5.14E-05	27
CCP/Immune/Additional	CENPF FN1	3.21E-05	29
CCP/Immune/Additional	CENPF PTN	0.000175	27
CCP/Immune/Additional	CENPF PRAME	6.06E-05	24
CCP/Immune/Additional	CENPF BCL2A1	1.62E-05	28
CCP/Immune/Additional	CENPF IFI6	3.12E-05	27
CCP/Immune/Additional	CENPF CFH	0.000172	27
CCP/Immune/Additional	CENPF RGS1	7.57E-06	29
CCP/Immune/Additional	CENPF PHACTR1	0.000169	26
CCP/Immune/Additional	CENPF SPP1	1.05E-05	29
CCP/Immune/Additional	CENPF KRT15	2.96E-05	27

Table YY

type	genes	pval	n
Immune/Additional	PRAME RGS1 KRT15	6.57E-16	76
Immune/Additional	RGS1 SPP1 KRT15	9.50E-16	78
Immune/Additional	CCL3 RGS1 KRT15	1.02E-15	78
Immune/Additional	RGS1 PHACTR1 KRT15	1.02E-15	78
Immune/Additional	HEY1 RGS1 KRT15	1.05E-15	79
Immune/Additional	PTN RGS1 KRT15	1.18E-15	79
Immune/Additional	FABP7 RGS1 KRT15	1.20E-15	79
Immune/Additional	CFH RGS1 KRT15	1.23E-15	79
Immune/Additional	FN1 RGS1 KRT15	1.38E-15	79
Immune/Additional	BCL2A1 RGS1 KRT15	1.45E-15	78
Immune/Additional	FN1 BCL2A1 RGS1	2.89E-15	80
Immune/Additional	FN1 RGS1 SPP1	4.93E-15	80
Immune/Additional	BCL2A1 RGS1 SPP1	5.11E-15	79
Immune/Additional	IFI6 RGS1 KRT15	5.70E-15	73
Immune/Additional	IFI6 RGS1 SPP1	1.11E-14	74
Immune/Additional	RGS1 PHACTR1 SPP1	1.23E-14	77
Immune/Additional	FN1 RGS1 PHACTR1	1.88E-14	78
Immune/Additional	CCL3 PRAME KRT15	1.94E-14	76
Immune/Additional	BCL2A1 IFI6 RGS1	2.12E-14	75
Immune/Additional	HEY1 RGS1 SPP1	2.13E-14	78
Immune/Additional	PRAME RGS1 PHACTR1	2.67E-14	76
Immune/Additional	HEY1 RGS1 PHACTR1	3.15E-14	78
Immune/Additional	BCL2A1 RGS1 PHACTR1	3.25E-14	78
Immune/Additional	FABP7 RGS1 PHACTR1	3.40E-14	78
Immune/Additional	HEY1 FABP7 RGS1	3.41E-14	79
Immune/Additional	PRAME RGS1 SPP1	3.64E-14	75
Immune/Additional	CFH RGS1 SPP1	3.74E-14	78
Immune/Additional	HEY1 BCL2A1 RGS1	3.86E-14	78
Immune/Additional	PTN RGS1 PHACTR1	3.95E-14	78
Immune/Additional	HEY1 PRAME RGS1	4.02E-14	76
Immune/Additional	PTN RGS1 SPP1	4.11E-14	78
Immune/Additional	FN1 PRAME RGS1	4.64E-14	76
Immune/Additional	CFH RGS1 PHACTR1	4.94E-14	78
Immune/Additional	FABP7 RGS1 SPP1	5.15E-14	78
Immune/Additional	PRAME SPP1 KRT15	5.41E-14	75
Immune/Additional	CCL3 RGS1 PHACTR1	5.56E-14	78
Immune/Additional	CCL3 RGS1 SPP1	6.03E-14	77
Immune/Additional	HEY1 CCL3 RGS1	6.22E-14	78
Immune/Additional	FABP7 BCL2A1 RGS1	7.77E-14	78
Immune/Additional	PTN BCL2A1 RGS1	8.10E-14	78
Immune/Additional	PRAME BCL2A1 RGS1	9.11E-14	76
Immune/Additional	PTN PRAME RGS1	9.99E-14	76
Immune/Additional	BCL2A1 CFH RGS1	1.07E-13	78
Immune/Additional	PRAME IFI6 RGS1	1.10E-13	71
Immune/Additional	CCL3 BCL2A1 RGS1	1.12E-13	78
Immune/Additional	FN1 IFI6 RGS1	1.18E-13	75
Immune/Additional	FABP7 PRAME RGS1	1.22E-13	76
Immune/Additional	HEY1 FN1 RGS1	1.31E-13	79
Immune/Additional	HEY1 PTN RGS1	1.34E-13	79
Immune/Additional	IFI6 RGS1 PHACTR1	1.49E-13	73
Immune/Additional	HEY1 IFI6 RGS1	1.65E-13	73

Immune/Additional	HEY1 CFH RGS1	1.86E-13	79
Immune/Additional	CCL3 PRAME RGS1	1.91E-13	76
Immune/Additional	PRAME CFH RGS1	1.97E-13	76
Immune/Additional	FABP7 FN1 RGS1	2.40E-13	79
Immune/Additional	CCL3 FN1 RGS1	2.50E-13	78
Immune/Additional	FABP7 PRAME KRT15	2.70E-13	76
Immune/Additional	PRAME PHACTR1 KRT15	2.94E-13	76
Immune/Additional	FN1 CFH RGS1	2.99E-13	79
Immune/Additional	FABP7 CFH RGS1	3.62E-13	79
Immune/Additional	CCL3 SPP1 KRT15	3.97E-13	77
Immune/Additional	PRAME CFH KRT15	4.09E-13	76
Immune/Additional	HEY1 PRAME KRT15	4.25E-13	76
Immune/Additional	FABP7 IFI6 RGS1	4.97E-13	73
Immune/Additional	FN1 PRAME KRT15	5.45E-13	76
Immune/Additional	IFI6 CFH RGS1	5.48E-13	73
Immune/Additional	FABP7 PTN RGS1	5.52E-13	79
Immune/Additional	HEY1 CCL3 KRT15	5.81E-13	78
Immune/Additional	PTN CFH RGS1	5.84E-13	79
Immune/Additional	CCL3 FN1 KRT15	6.03E-13	78
Immune/Additional	CCL3 CFH RGS1	6.37E-13	78
Immune/Additional	CCL3 FABP7 RGS1	6.69E-13	78
Immune/Additional	CCL3 PTN KRT15	7.34E-13	78
Immune/Additional	CCL3 CFH KRT15	7.78E-13	78
Immune/Additional	PTN PRAME KRT15	8.20E-13	76
Immune/Additional	CCL3 PHACTR1 KRT15	8.53E-13	78
Immune/Additional	CCL3 FABP7 KRT15	9.58E-13	78
Immune/Additional	CCL3 IFI6 RGS1	9.78E-13	73
Immune/Additional	CCL3 BCL2A1 KRT15	9.85E-13	78
Immune/Additional	PRAME BCL2A1 KRT15	1.25E-12	76
Immune/Additional	CFH SPP1 KRT15	1.35E-12	78
Immune/Additional	FN1 PTN RGS1	1.55E-12	79
Immune/Additional	PTN IFI6 RGS1	1.70E-12	73
Immune/Additional	HEY1 SPP1 KRT15	1.86E-12	78
Immune/Additional	CCL3 PTN RGS1	2.20E-12	78
Immune/Additional	CCL3 IFI6 KRT15	2.24E-12	73
Immune/Additional	PRAME IFI6 KRT15	2.87E-12	71
Immune/Additional	RGS1 CCL5 PTPRC	3.53E-12	52
Immune/Additional	CCL3 PRAME SPP1	3.65E-12	75
Immune/Additional	BCL2A1 CCL5 PTPRC	3.67E-12	52
Immune/Additional	PTPN22 CCL5 PTPRC	3.92E-12	52
Immune/Additional	PHACTR1 SPP1 KRT15	4.11E-12	77
Immune/Additional	PRAME CCL5 PTPRC	4.36E-12	52
Immune/Additional	CCL5 PTPRC PHACTR1	4.48E-12	52
Immune/Additional	FABP7 CCL5 PTPRC	4.71E-12	52
Immune/Additional	CCL5 S100A9 KRT15	4.88E-12	52
Immune/Additional	HEY1 CCL5 PTPRC	4.91E-12	52
Immune/Additional	CCL5 PTPRC KRT15	4.92E-12	52
Immune/Additional	PRAME IFI6 SPP1	4.93E-12	70
Immune/Additional	PRAME SELL KRT15	4.93E-12	52
Immune/Additional	CCL5 HLA PTPRC	5.28E-12	52
Immune/Additional	CCL3 CCL5 PTPRC	5.34E-12	52
Immune/Additional	CCL5 S100A9 PTPRC	5.46E-12	52
Immune/Additional	PTN SPP1 KRT15	5.53E-12	78

Immune/Additional	PTN KRT15 CXCL9	5.57E-12	52
Immune/Additional	FABP7 SPP1 KRT15	5.61E-12	78
Immune/Additional	CCL5 PTPRC LCP2	5.87E-12	52
Immune/Additional	CCL5 SELL KRT15	5.98E-12	52
Immune/Additional	CCL5 SELL PTPRC	6.10E-12	52
Immune/Additional	IRF1 CCL5 PTPRC	6.13E-12	52
Immune/Additional	S100A9 PTPRC KRT15	6.37E-12	52
Immune/Additional	SELL S100A9 KRT15	6.38E-12	52
Immune/Additional	S100A9 LCP2 KRT15	6.50E-12	52
Immune/Additional	PTN CCL5 PTPRC	6.54E-12	52
Immune/Additional	HLA CCL5 PTPRC	6.65E-12	52
Immune/Additional	PRAME PHACTR1 SPP1	6.68E-12	75
Immune/Additional	FN1 CCL5 PTPRC	6.74E-12	52
Immune/Additional	CFH CCL5 PTPRC	6.79E-12	52
Immune/Additional	FN1 SPP1 KRT15	6.83E-12	78
Immune/Additional	RGS1 SELL KRT15	6.83E-12	52
Immune/Additional	PECAM1 CCL5 PTPRC	6.86E-12	52
Immune/Additional	BCL2A1 SPP1 KRT15	6.88E-12	77
Immune/Additional	S100A9 KRT15 CXCL9	6.94E-12	52
Immune/Additional	RGS1 KRT15 CXCL9	7.07E-12	52
Immune/Additional	PRAME KRT15 CXCL9	7.25E-12	52
Immune/Additional	CCL5 PTPRC HCLS1	7.35E-12	52
Immune/Additional	SELL ITGB2 KRT15	7.68E-12	52
Immune/Additional	SELL KRT15 CXCL9	7.73E-12	52
Immune/Additional	PECAM1 S100A9 KRT15	7.83E-12	52
Immune/Additional	CCL3 KRT15 CXCL9	7.90E-12	52
Immune/Additional	CCL5 PTPRC CXCL9	7.97E-12	52
Immune/Additional	LCP2 KRT15 CXCL9	8.01E-12	52
Immune/Additional	PECAM1 KRT15 CXCL9	8.05E-12	52
Immune/Additional	S100A9 KRT15 HCLS1	8.43E-12	52
Immune/Additional	CCL5 ITGB2 PTPRC	8.51E-12	52
Immune/Additional	PHACTR1 KRT15 CXCL9	8.70E-12	52
Immune/Additional	FABP7 PRAME SPP1	8.72E-12	75
Immune/Additional	IRF1 S100A9 KRT15	8.92E-12	52
Immune/Additional	FN1 PRAME SPP1	8.99E-12	75
Immune/Additional	SELL PHACTR1 HCLS1	9.11E-12	52
Immune/Additional	HLA KRT15 CXCL9	9.25E-12	52
Immune/Additional	HLA KRT15 CXCL9	9.70E-12	52
Immune/Additional	PRAME IRF1 KRT15	1.03E-11	52
Immune/Additional	ITGB2 KRT15 CXCL9	1.03E-11	52
Immune/Additional	FABP7 KRT15 CXCL9	1.05E-11	52
Immune/Additional	IRF1 KRT15 CXCL9	1.05E-11	52
Immune/Additional	KRT15 CXCL9 HCLS1	1.05E-11	52
Immune/Additional	HEY1 KRT15 CXCL9	1.06E-11	52
Immune/Additional	CCL3 IRF1 KRT15	1.09E-11	52
Immune/Additional	CCL5 PTPRC SPP1	1.10E-11	51
Immune/Additional	SELL KRT15 HCLS1	1.10E-11	52
Immune/Additional	PRAME CCL5 KRT15	1.12E-11	52
Immune/Additional	CCL5 PHACTR1 KRT15	1.12E-11	52
Immune/Additional	BCL2A1 KRT15 CXCL9	1.14E-11	52
Immune/Additional	PTPN22 S100A9 KRT15	1.17E-11	52
Immune/Additional	CFH SELL KRT15	1.20E-11	52
Immune/Additional	CCL3 CCL5 KRT15	1.24E-11	52

Immune/Additional	PTPN22 KRT15 CXCL9	1.24E-11	52
Immune/Additional	RGS1 CCL5 KRT15	1.24E-11	52
Immune/Additional	PTPRC KRT15 CXCL9	1.26E-11	52
Immune/Additional	IRF1 HLA KRT15	1.27E-11	52
Immune/Additional	SELL PTPRC KRT15	1.30E-11	52
Immune/Additional	S100A9 ITGB2 KRT15	1.31E-11	52
Immune/Additional	CCL5 KRT15 CXCL9	1.32E-11	52
Immune/Additional	PRAME PTPRC KRT15	1.33E-11	52
Immune/Additional	IRF1 ITGB2 KRT15	1.35E-11	52
Immune/Additional	IGJ PHACTR1 CXCL9	1.36E-11	50
Immune/Additional	PECAM1 CCL5 KRT15	1.36E-11	52
Immune/Additional	SELL PHACTR1 KRT15	1.41E-11	52
Immune/Additional	CCL5 HLA KRT15	1.42E-11	52
Immune/Additional	FN1 KRT15 CXCL9	1.45E-11	52
Immune/Additional	PTPN22 SELL KRT15	1.48E-11	52
Immune/Additional	IRF1 CCL5 KRT15	1.48E-11	52
Immune/Additional	IRF1 KRT15 HCLS1	1.49E-11	52
Immune/Additional	IGJ CCL5 PTPRC	1.50E-11	50
Immune/Additional	BCL2A1 SELL KRT15	1.50E-11	52
Immune/Additional	HLA S100A9 KRT15	1.51E-11	52
Immune/Additional	HLA SELL KRT15	1.53E-11	52
Immune/Additional	BCL2A1 CCL5 KRT15	1.57E-11	52
Immune/Additional	CCL5 LCP2 KRT15	1.57E-11	52
Immune/Additional	IGJ KRT15 CXCL9	1.59E-11	50
Immune/Additional	PRAME PTPN22 KRT15	1.62E-11	52
Immune/Additional	RGS1 S100A9 KRT15	1.62E-11	52
Immune/Additional	IRF1 SELL KRT15	1.63E-11	52
Immune/Additional	CCL3 SELL KRT15	1.65E-11	52
Immune/Additional	HEY1 CCL5 KRT15	1.66E-11	52
Immune/Additional	SELL HLA KRT15	1.66E-11	52
Immune/Additional	SELL LCP2 KRT15	1.70E-11	52
Immune/Additional	CFH KRT15 CXCL9	1.71E-11	52
Immune/Additional	IGJ CCL5 KRT15	1.75E-11	50
Immune/Additional	PRAME KRT15 HCLS1	1.77E-11	52
Immune/Additional	CFH IRF1 KRT15	1.79E-11	52
Immune/Additional	CXCL10 RGS1 KRT15	1.83E-11	50
Immune/Additional	PRAME LCP2 KRT15	1.85E-11	52
Immune/Additional	FN1 SELL KRT15	1.87E-11	52
Immune/Additional	HLA IRF1 KRT15	1.87E-11	52
Immune/Additional	PRAME PECAM1 KRT15	1.92E-11	52
Immune/Additional	IRF1 LCP2 KRT15	1.93E-11	52
Immune/Additional	CD38 KRT15 CXCL9	1.94E-11	49
Immune/Additional	HEY1 PRAME SPP1	1.95E-11	75
Immune/Additional	SPP1 KRT15 CXCL9	1.97E-11	51
Immune/Additional	FABP7 SELL KRT15	1.98E-11	52
Immune/Additional	HLA S100A9 KRT15	1.98E-11	52
Immune/Additional	SELL ITGB2 PHACTR1	1.99E-11	52
Immune/Additional	PTN CCL5 KRT15	2.00E-11	52
Immune/Additional	HEY1 FABP7 KRT15	2.02E-11	79
Immune/Additional	FABP7 IRF1 KRT15	2.02E-11	52
Immune/Additional	PTN SELL KRT15	2.02E-11	52
Immune/Additional	HEY1 RGS1 SELL	2.04E-11	52
Immune/Additional	IGJ PRAME CXCL9	2.04E-11	50

Immune/Additional	IRF1 PTPRC KRT15	2.04E-11	52
Immune/Additional	CFH SELL PHACTR1	2.05E-11	52
Immune/Additional	IRF1 PHACTR1 KRT15	2.10E-11	52
Immune/Additional	HLA CCL5 KRT15	2.12E-11	52
Immune/Additional	PTN IRF1 KRT15	2.16E-11	52
Immune/Additional	PRAME BCL2A1 SPP1	2.16E-11	75
Immune/Additional	PECAM1 SELL KRT15	2.19E-11	52
Immune/Additional	CCL5 KRT15 HCLS1	2.21E-11	52
Immune/Additional	HEY1 SELL KRT15	2.22E-11	52
Immune/Additional	CXCL10 SELL KRT15	2.24E-11	50
Immune/Additional	CCL5 ITGB2 KRT15	2.27E-11	52
Immune/Additional	CXCL10 IRF1 KRT15	2.28E-11	50
Immune/Additional	CXCL10 S100A9 KRT15	2.30E-11	50
Immune/Additional	FN1 CCL5 KRT15	2.33E-11	52
Immune/Additional	PTPN22 CCL5 KRT15	2.33E-11	52
Immune/Additional	RGS1 IRF1 KRT15	2.35E-11	52
Immune/Additional	CXCL10 CCL5 PTPRC	2.45E-11	50
Immune/Additional	FABP7 CCL5 KRT15	2.45E-11	52
Immune/Additional	PTN PRAME SPP1	2.45E-11	75
Immune/Additional	CCL5 CD38 PTPRC	2.45E-11	49
Immune/Additional	CCL5 CD38 KRT15	2.51E-11	49
Immune/Additional	SELL SPP1 KRT15	2.53E-11	51
Immune/Additional	BCL2A1 IRF1 KRT15	2.56E-11	52
Immune/Additional	IRF1 CD38 KRT15	2.57E-11	49
Immune/Additional	CXCL10 PRAME KRT15	2.68E-11	50
Immune/Additional	CXCL10 PHACTR1 KRT15	2.71E-11	50
Immune/Additional	CCL3 IFI6 SPP1	2.73E-11	72
Immune/Additional	PRAME S100A9 KRT15	2.74E-11	52
Immune/Additional	FN1 CXCL9 HCLS1	2.76E-11	52
Immune/Additional	IFI6 KRT15 CXCL9	2.78E-11	48
Immune/Additional	HEY1 IRF1 KRT15	2.79E-11	52
Immune/Additional	HEY1 S100A9 KRT15	2.79E-11	52
Immune/Additional	HEY1 CXCL10 KRT15	2.80E-11	50
Immune/Additional	CXCL10 FABP7 KRT15	2.80E-11	50
Immune/Additional	CFH CCL5 KRT15	2.82E-11	52
Immune/Additional	CXCL10 KRT15 CXCL9	2.87E-11	50
Immune/Additional	CXCL10 HLA KRT15	2.88E-11	50
Immune/Additional	CXCL10 RGS1 PTPRC	2.90E-11	50
Immune/Additional	RGS1 LCP2 KRT15	2.93E-11	52
Immune/Additional	PECAM1 IRF1 KRT15	2.95E-11	52
Immune/Additional	CXCL10 BCL2A1 KRT15	2.96E-11	50
Immune/Additional	PTPN22 IRF1 KRT15	2.96E-11	52
Immune/Additional	CXCL10 HLA KRT15	2.97E-11	50
Immune/Additional	PRAME CFH SPP1	3.01E-11	75
Immune/Additional	CXCL10 PTPRC KRT15	3.03E-11	50
Immune/Additional	FN1 IRF1 KRT15	3.06E-11	52
Immune/Additional	CCL5 SPP1 KRT15	3.07E-11	51
Immune/Additional	RGS1 PTPRC KRT15	3.15E-11	52
Immune/Additional	CXCL10 PTPN22 KRT15	3.16E-11	50
Immune/Additional	CXCL10 ITGB2 KRT15	3.16E-11	50
Immune/Additional	CD38 SELL KRT15	3.22E-11	49
Immune/Additional	HEY1 CFH KRT15	3.24E-11	79
Immune/Additional	IRF1 SPP1 KRT15	3.29E-11	51

Immune/Additional	PECAM1 SELL PHACTR1	3.33E-11	52
Immune/Additional	RGS1 CD38 KRT15	3.33E-11	49
Immune/Additional	CXCL10 CCL3 KRT15	3.36E-11	50
Immune/Additional	CXCL10 PTN KRT15	3.43E-11	50
Immune/Additional	CXCL10 CCL5 KRT15	3.43E-11	50
Immune/Additional	HEY1 RGS1 LCP2	3.44E-11	52
Immune/Additional	CXCL10 LCP2 KRT15	3.46E-11	50
Immune/Additional	CCL3 S100A9 KRT15	3.49E-11	52
Immune/Additional	IFI6 PHACTR1 CXCL9	3.53E-11	48
Immune/Additional	CXCL10 KRT15 HCLS1	3.55E-11	50
Immune/Additional	SELL CXCL13 KRT15	3.61E-11	48
Immune/Additional	S100A9 SPP1 KRT15	3.66E-11	51
Immune/Additional	CCL3 FN1 PRAME	3.67E-11	76
Immune/Additional	PRAME ITGB2 KRT15	3.72E-11	52
Immune/Additional	PRAME IFI6 CXCL9	3.77E-11	48
Immune/Additional	HEY1 RGS1 S100A9	3.82E-11	52
Immune/Additional	HEY1 SELL PHACTR1	3.85E-11	52
Immune/Additional	HEY1 PHACTR1 KRT15	3.85E-11	78
Immune/Additional	CXCL10 CFH KRT15	3.96E-11	50
Immune/Additional	CCL5 PTPRC CXCL13	4.05E-11	48
Immune/Additional	PTPN22 RGS1 KRT15	4.09E-11	52
Immune/Additional	CXCL13 LCP2 KRT15	4.09E-11	48
Immune/Additional	CXCL10 FN1 KRT15	4.10E-11	50
Immune/Additional	CXCL10 SPP1 KRT15	4.23E-11	49
Immune/Additional	FN1 BCL2A1 SPP1	4.23E-11	79
Immune/Additional	PECAM1 CD38 KRT15	4.24E-11	49
Immune/Additional	CCL3 PHACTR1 SPP1	4.27E-11	77
Immune/Additional	CXCL10 PECAM1 KRT15	4.33E-11	50
Immune/Additional	RGS1 SELL PHACTR1	4.37E-11	52
Immune/Additional	IGJ CCL5 PHACTR1	4.43E-11	50
Immune/Additional	CXCL10 CD38 KRT15	4.49E-11	48
Immune/Additional	HEY1 RGS1 CD38	4.51E-11	49
Immune/Additional	PRAME HLA KRT15	4.57E-11	52
Immune/Additional	CCL3 PRAME IFI6	4.61E-11	71
Immune/Additional	CCL5 SELL PHACTR1	4.81E-11	52
Immune/Additional	IGJ SELL KRT15	4.84E-11	50
Immune/Additional	FN1 HLA CXCL9	4.87E-11	52
Immune/Additional	CXCL10 RGS1 PHACTR1	4.95E-11	50
Immune/Additional	SELL PHACTR1 CXCL9	4.95E-11	52
Immune/Additional	CD38 ITGB2 KRT15	4.98E-11	49
Immune/Additional	CCL5 CXCL13 KRT15	5.03E-11	48
Immune/Additional	CXCL13 KRT15 CXCL9	5.06E-11	48
Immune/Additional	PRAME SELL PHACTR1	5.08E-11	52
Immune/Additional	RGS1 ITGB2 KRT15	5.14E-11	52
Immune/Additional	CXCL10 RGS1 IRF1	5.15E-11	50
Immune/Additional	SELL PHACTR1 LCP2	5.22E-11	52
Immune/Additional	CCL3 FN1 SPP1	5.30E-11	77
Immune/Additional	IFI6 SPP1 KRT15	5.31E-11	72
Immune/Additional	RGS1 KRT15 HCLS1	5.32E-11	52
Immune/Additional	HEY1 IGJ CCL5	5.33E-11	50
Immune/Additional	SELL S100A9 PHACTR1	5.34E-11	52
Immune/Additional	ITGB2 CXCL13 KRT15	5.37E-11	48
Immune/Additional	CXCL10 HLA RGS1	5.43E-11	50

Immune/Additional	HEY1 IFI6 SELL	5.47E-11	48
Immune/Additional	CD38 LCP2 KRT15	5.53E-11	49
Immune/Additional	FN1 CD38 KRT15	5.56E-11	49
Immune/Additional	IFI6 CCL5 PTPRC	5.67E-11	48
Immune/Additional	IGJ IRF1 KRT15	5.68E-11	50
Immune/Additional	FABP7 CD38 KRT15	5.75E-11	49
Immune/Additional	HLA CD38 KRT15	6.00E-11	49
Immune/Additional	SELL PTPRC PHACTR1	6.02E-11	52
Immune/Additional	CD38 PTPRC KRT15	6.03E-11	49
Immune/Additional	HEY1 IFI6 CCL5	6.08E-11	48
Immune/Additional	CD38 PHACTR1 CXCL9	6.09E-11	49
Immune/Additional	HEY1 FN1 KRT15	6.28E-11	79
Immune/Additional	IFI6 CCL5 KRT15	6.32E-11	48
Immune/Additional	HEY1 RGS1 CCL5	6.36E-11	52
Immune/Additional	FABP7 S100A9 KRT15	6.45E-11	52
Immune/Additional	FN1 PHACTR1 KRT15	6.46E-11	78
Immune/Additional	CCL3 CD38 KRT15	6.61E-11	49
Immune/Additional	PECAM1 RGS1 KRT15	6.70E-11	52
Immune/Additional	PTN S100A9 KRT15	6.72E-11	52
Immune/Additional	HEY1 CXCL10 RGS1	6.74E-11	50
Immune/Additional	CCL3 CFH SPP1	6.74E-11	77
Immune/Additional	CCL3 SELL PHACTR1	6.86E-11	52
Immune/Additional	CD38 HLA KRT15	6.89E-11	49
Immune/Additional	IRF1 CXCL13 KRT15	6.91E-11	48
Immune/Additional	CFH PHACTR1 KRT15	6.93E-11	78
Immune/Additional	CXCL10 PTPRC CXCL9	6.96E-11	50
Immune/Additional	IRF1 SELL PHACTR1	6.99E-11	52
Immune/Additional	HLA RGS1 KRT15	7.02E-11	52
Immune/Additional	PTPRC CXCL13 KRT15	7.04E-11	48
Immune/Additional	CCL3 IFI6 CXCL9	7.06E-11	48
Immune/Additional	PTPN22 CD38 KRT15	7.08E-11	49
Immune/Additional	PTN CD38 KRT15	7.13E-11	49
Immune/Additional	FABP7 CFH KRT15	7.14E-11	79
Immune/Additional	HEY1 PTN KRT15	7.16E-11	79
Immune/Additional	IGJ LCP2 KRT15	7.17E-11	50
Immune/Additional	FN1 PHACTR1 CXCL9	7.19E-11	52
Immune/Additional	FN1 IFI6 CXCL9	7.20E-11	48
Immune/Additional	PTPRC PHACTR1 KRT15	7.23E-11	52
Immune/Additional	CFH RGS1 SELL	7.26E-11	52
Immune/Additional	CD38 KRT15 HCLS1	7.26E-11	49
Immune/Additional	CXCL13 KRT15 HCLS1	7.32E-11	48
Immune/Additional	S100A9 PHACTR1 KRT15	7.48E-11	52
Immune/Additional	FN1 S100A9 SPP1	7.49E-11	51
Immune/Additional	FN1 HLA CCL5	7.51E-11	52
Immune/Additional	FN1 CFH SELL	7.72E-11	52
Immune/Additional	HLA LCP2 KRT15	7.75E-11	52
Immune/Additional	CXCL10 SELL PHACTR1	7.84E-11	50
Immune/Additional	FN1 CFH CXCL9	7.87E-11	52
Immune/Additional	RGS1 S100A9 PHACTR1	7.92E-11	52
Immune/Additional	PECAM1 CXCL13 KRT15	8.25E-11	48
Immune/Additional	IFI6 CFH SELL	8.32E-11	48
Immune/Additional	FABP7 IGJ CXCL9	8.34E-11	50
Immune/Additional	FN1 S100A9 KRT15	8.35E-11	52

Immune/Additional	CXCL10 PTPN22 RGS1	8.42E-11	50
Immune/Additional	IGJ PTPRC KRT15	8.51E-11	50
Immune/Additional	IGJ RGS1 CXCL9	8.59E-11	50
Immune/Additional	PRAME PTPRC CXCL9	8.59E-11	52
Immune/Additional	PTN PHACTR1 CXCL9	8.62E-11	52
Immune/Additional	RGS1 HLA KRT15	8.76E-11	52
Immune/Additional	IFI6 SELL KRT15	8.77E-11	48
Immune/Additional	FABP7 FN1 KRT15	8.88E-11	79
Immune/Additional	FN1 BCL2A1 KRT15	8.91E-11	78
Immune/Additional	FN1 SELL PHACTR1	8.91E-11	52
Immune/Additional	BCL2A1 SELL PHACTR1	8.91E-11	52
Immune/Additional	PTPRC PHACTR1 CXCL9	8.92E-11	52
Immune/Additional	IFI6 IRF1 KRT15	9.11E-11	48
Immune/Additional	FABP7 PHACTR1 KRT15	9.12E-11	78
Immune/Additional	FABP7 BCL2A1 KRT15	9.23E-11	78
Immune/Additional	FN1 CFH KRT15	9.28E-11	79
Immune/Additional	RGS1 PHACTR1 CXCL9	9.60E-11	52
Immune/Additional	PHACTR1 LCP2 KRT15	9.62E-11	52
Immune/Additional	CFH CD38 KRT15	9.70E-11	49
Immune/Additional	PTPN22 PHACTR1 KRT15	9.76E-11	52
Immune/Additional	IFI6 CD38 KRT15	9.78E-11	47
Immune/Additional	CCL3 BCL2A1 SPP1	9.79E-11	77
Immune/Additional	HLA SELL PHACTR1	9.92E-11	52
Immune/Additional	HEY1 BCL2A1 KRT15	1.01E-10	78
Immune/Additional	PTN PHACTR1 KRT15	1.01E-10	78
Immune/Additional	FN1 PTPN22 CCL5	1.02E-10	52
Immune/Additional	HEY1 RGS1 CXCL9	1.03E-10	52
Immune/Additional	FN1 CXCL13 KRT15	1.03E-10	48
Immune/Additional	CXCL10 RGS1 HLA	1.04E-10	50
Immune/Additional	HLA PTPRC KRT15	1.04E-10	52
Immune/Additional	CXCL10 FN1 RGS1	1.05E-10	50
Immune/Additional	BCL2A1 S100A9 KRT15	1.05E-10	52
Immune/Additional	SELL HLA PHACTR1	1.05E-10	52
Immune/Additional	CD38 PHACTR1 KRT15	1.06E-10	49
Immune/Additional	PTPN22 HLA KRT15	1.07E-10	52
Immune/Additional	PTPN22 CXCL13 KRT15	1.07E-10	48
Immune/Additional	PTPRC LCP2 KRT15	1.07E-10	52
Immune/Additional	HEY1 CFH SELL	1.08E-10	52
Immune/Additional	HLA CXCL13 KRT15	1.08E-10	48
Immune/Additional	HEY1 CCL3 SPP1	1.09E-10	77
Immune/Additional	CXCL10 IGJ RGS1	1.10E-10	48
Immune/Additional	PRAME HLA KRT15	1.10E-10	52
Immune/Additional	CXCL10 IGJ KRT15	1.11E-10	48
Immune/Additional	IGJ RGS1 KRT15	1.11E-10	50
Immune/Additional	PTPN22 SELL PHACTR1	1.12E-10	52
Immune/Additional	HEY1 CCL5 CD38	1.13E-10	49
Immune/Additional	BCL2A1 IFI6 SPP1	1.13E-10	74
Immune/Additional	SELL PHACTR1 SPP1	1.13E-10	51
Immune/Additional	PRAME CD38 KRT15	1.14E-10	49
Immune/Additional	S100A9 PHACTR1 CXCL9	1.14E-10	52
Immune/Additional	RGS1 PTPRC CXCL9	1.15E-10	52
Immune/Additional	PTPN22 LCP2 KRT15	1.16E-10	52
Immune/Additional	FN1 IGJ CXCL9	1.17E-10	50

Immune/Additional	FN1 PTPRC CXCL9	1.19E-10	52
Immune/Additional	PTN SELL PHACTR1	1.19E-10	52
Immune/Additional	IFI6 CCL5 HLA	1.19E-10	48
Immune/Additional	CD38 SPP1 KRT15	1.21E-10	48
Immune/Additional	IFI6 CCL5 PHACTR1	1.22E-10	48
Immune/Additional	FN1 S100A9 CXCL9	1.24E-10	52
Immune/Additional	HEY1 RGS1 IRF1	1.25E-10	52
Immune/Additional	CCL3 FN1 CFH	1.26E-10	78
Immune/Additional	CXCL10 RGS1 CCL5	1.28E-10	50
Immune/Additional	S100A9 PTPRC CXCL9	1.28E-10	52
Immune/Additional	HEY1 RGS1 PTPRC	1.30E-10	52
Immune/Additional	CXCL10 CXCL13 KRT15	1.30E-10	46
Immune/Additional	FN1 PRAME CXCL9	1.30E-10	52
Immune/Additional	CD38 PTPRC CXCL9	1.31E-10	49
Immune/Additional	FABP7 CXCL13 KRT15	1.32E-10	48
Immune/Additional	IGJ CFH CXCL9	1.33E-10	50
Immune/Additional	CCL3 FABP7 SPP1	1.34E-10	77
Immune/Additional	RGS1 CXCL13 KRT15	1.36E-10	48
Immune/Additional	CD38 S100A9 KRT15	1.37E-10	49
Immune/Additional	HEY1 RGS1 ITGB2	1.40E-10	52
Immune/Additional	HEY1 CD38 CXCL9	1.40E-10	49
Immune/Additional	FABP7 SELL PHACTR1	1.40E-10	52
Immune/Additional	CXCL10 IFI6 KRT15	1.41E-10	47
Immune/Additional	HEY1 CD38 SELL	1.43E-10	49
Immune/Additional	BCL2A1 PHACTR1 KRT15	1.43E-10	78
Immune/Additional	IFI6 CCL5 CXCL9	1.44E-10	48
Immune/Additional	IFI6 S100A9 CXCL9	1.45E-10	48
Immune/Additional	FABP7 FN1 PRAME	1.48E-10	76
Immune/Additional	BCL2A1 CFH KRT15	1.48E-10	78
Immune/Additional	CXCL10 RGS1 HCLS1	1.54E-10	50
Immune/Additional	FABP7 PTN KRT15	1.54E-10	79
Immune/Additional	HLA CXCL13 KRT15	1.54E-10	48
Immune/Additional	ITGB2 PTPRC KRT15	1.54E-10	52
Immune/Additional	CXCL10 CFH RGS1	1.55E-10	50
Immune/Additional	IFI6 SELL PHACTR1	1.55E-10	48
Immune/Additional	PTN CFH KRT15	1.57E-10	79
Immune/Additional	BCL2A1 PTPRC KRT15	1.57E-10	52
Immune/Additional	CFH RGS1 CXCL9	1.58E-10	52
Immune/Additional	PTPN22 SPP1 KRT15	1.58E-10	51
Immune/Additional	HEY1 RGS1 HLA	1.60E-10	52
Immune/Additional	CFH LCP2 KRT15	1.60E-10	52
Immune/Additional	PTPN22 ITGB2 KRT15	1.60E-10	52
Immune/Additional	CFH CCL5 SELL	1.61E-10	52
Immune/Additional	S100A9 SPP1 CXCL9	1.61E-10	51
Immune/Additional	HEY1 PECAM1 RGS1	1.62E-10	52
Immune/Additional	CCL3 PTPRC KRT15	1.62E-10	52
Immune/Additional	IGJ CCL5 CXCL9	1.63E-10	50
Immune/Additional	BCL2A1 CD38 KRT15	1.63E-10	49
Immune/Additional	PTN PTPRC KRT15	1.64E-10	52
Immune/Additional	IFI6 PECAM1 CXCL9	1.64E-10	48
Immune/Additional	PTPN22 PTPRC KRT15	1.64E-10	52
Immune/Additional	HEY1 PTPN22 RGS1	1.66E-10	52
Immune/Additional	CXCL10 FN1 HLA	1.68E-10	50

Immune/Additional	CFH RGS1 CCL5	1.68E-10	52
Immune/Additional	CCL3 FN1 BCL2A1	1.69E-10	78
Immune/Additional	PHACTR1 SPP1 CXCL9	1.69E-10	51
Immune/Additional	CXCL10 SELL PTPRC	1.70E-10	50
Immune/Additional	CCL3 PTN SPP1	1.70E-10	77
Immune/Additional	CCL3 PTPN22 KRT15	1.70E-10	52
Immune/Additional	CXCL10 HLA SELL	1.71E-10	50
Immune/Additional	BCL2A1 PTPN22 KRT15	1.73E-10	52
Immune/Additional	PRAME RGS1 SELL	1.74E-10	52
Immune/Additional	PTPN22 KRT15 HCLS1	1.76E-10	52
Immune/Additional	HEY1 RGS1 HCLS1	1.77E-10	52
Immune/Additional	HEY1 CD38 KRT15	1.77E-10	49
Immune/Additional	IGJ PRAME CCL5	1.77E-10	50
Immune/Additional	HEY1 CCL3 CD38	1.78E-10	49
Immune/Additional	IGJ SELL PHACTR1	1.79E-10	50
Immune/Additional	HEY1 IFI6 CXCL9	1.80E-10	48
Immune/Additional	PTN PTPN22 KRT15	1.80E-10	52
Immune/Additional	PTN LCP2 KRT15	1.81E-10	52
Immune/Additional	FN1 PTN KRT15	1.82E-10	79
Immune/Additional	CXCL10 FABP7 RGS1	1.83E-10	50
Immune/Additional	PTPRC KRT15 HCLS1	1.83E-10	52
Immune/Additional	HEY1 FN1 CCL5	1.84E-10	52
Immune/Additional	HEY1 IGJ RGS1	1.84E-10	50
Immune/Additional	CXCL10 PHACTR1 CXCL9	1.86E-10	50
Immune/Additional	FN1 CFH CCL5	1.88E-10	52

Table ZZ

type	genes	pval	n
Immune/Additional	PTN PRAME RGS1 KRT15	3.64E-15	76
Immune/Additional	FABP7 PTN RGS1 KRT15	5.29E-15	79
Immune/Additional	HEY1 PRAME RGS1 KRT15	5.52E-15	76
Immune/Additional	PTN CFH RGS1 KRT15	5.99E-15	79
Immune/Additional	PRAME RGS1 PHACTR1 KRT15	6.10E-15	76
Immune/Additional	CCL3 PRAME RGS1 KRT15	6.66E-15	76
Immune/Additional	HEY1 RGS1 PHACTR1 KRT15	7.41E-15	78
Immune/Additional	PTN RGS1 SPP1 KRT15	7.42E-15	78
Immune/Additional	HEY1 CCL3 RGS1 KRT15	7.48E-15	78
Immune/Additional	CCL3 PTN RGS1 KRT15	7.64E-15	78
Immune/Additional	PRAME CFH RGS1 KRT15	8.15E-15	76
Immune/Additional	PRAME BCL2A1 RGS1 KRT15	8.23E-15	76
Immune/Additional	FN1 PRAME RGS1 KRT15	8.34E-15	76
Immune/Additional	FABP7 PRAME RGS1 KRT15	8.36E-15	76
Immune/Additional	PTN RGS1 PHACTR1 KRT15	8.79E-15	78
Immune/Additional	HEY1 BCL2A1 RGS1 KRT15	8.98E-15	78
Immune/Additional	HEY1 PTN RGS1 KRT15	9.18E-15	79
Immune/Additional	CFH RGS1 PHACTR1 KRT15	1.01E-14	78
Immune/Additional	HEY1 FN1 RGS1 KRT15	1.02E-14	79
Immune/Additional	HEY1 RGS1 SPP1 KRT15	1.02E-14	78
Immune/Additional	CFH RGS1 SPP1 KRT15	1.03E-14	78
Immune/Additional	FN1 RGS1 SPP1 KRT15	1.05E-14	78
Immune/Additional	CCL3 RGS1 PHACTR1 KRT15	1.07E-14	78
Immune/Additional	PRAME RGS1 SPP1 KRT15	1.08E-14	75
Immune/Additional	RGS1 PHACTR1 SPP1 KRT15	1.08E-14	77

Immune/Additional	CCL3 RGS1 SPP1 KRT15	1.09E-14	77
Immune/Additional	HEY1 FABP7 RGS1 KRT15	1.11E-14	79
Immune/Additional	CCL3 FN1 RGS1 KRT15	1.11E-14	78
Immune/Additional	FABP7 RGS1 PHACTR1 KRT15	1.12E-14	78
Immune/Additional	CCL3 CFH RGS1 KRT15	1.14E-14	78
Immune/Additional	PTN BCL2A1 RGS1 KRT15	1.15E-14	78
Immune/Additional	FN1 RGS1 PHACTR1 KRT15	1.18E-14	78
Immune/Additional	HEY1 CFH RGS1 KRT15	1.20E-14	79
Immune/Additional	CCL3 FABP7 RGS1 KRT15	1.22E-14	78
Immune/Additional	FABP7 RGS1 SPP1 KRT15	1.26E-14	78
Immune/Additional	FABP7 FN1 RGS1 KRT15	1.27E-14	79
Immune/Additional	FN1 PTN RGS1 KRT15	1.27E-14	79
Immune/Additional	BCL2A1 RGS1 PHACTR1 KRT15	1.29E-14	78
Immune/Additional	BCL2A1 RGS1 SPP1 KRT15	1.33E-14	77
Immune/Additional	CCL3 BCL2A1 RGS1 KRT15	1.36E-14	78
Immune/Additional	FABP7 CFH RGS1 KRT15	1.37E-14	79
Immune/Additional	FN1 CFH RGS1 KRT15	1.39E-14	79
Immune/Additional	BCL2A1 CFH RGS1 KRT15	1.45E-14	78
Immune/Additional	FN1 BCL2A1 RGS1 KRT15	1.50E-14	78
Immune/Additional	FABP7 BCL2A1 RGS1 KRT15	1.55E-14	78
Immune/Additional	FN1 BCL2A1 RGS1 SPP1	1.81E-14	79
Immune/Additional	PRAME IFI6 RGS1 KRT15	2.42E-14	71
Immune/Additional	HEY1 FABP7 PTN RGS1	3.09E-14	79
Immune/Additional	CCL3 IFI6 RGS1 KRT15	5.86E-14	73
Immune/Additional	IFI6 RGS1 SPP1 KRT15	5.95E-14	72
Immune/Additional	FABP7 IFI6 RGS1 KRT15	6.01E-14	73
Immune/Additional	HEY1 IFI6 RGS1 KRT15	6.44E-14	73
Immune/Additional	PTN IFI6 RGS1 KRT15	6.54E-14	73
Immune/Additional	PTN RGS1 PHACTR1 SPP1	6.54E-14	77
Immune/Additional	FN1 IFI6 RGS1 KRT15	6.58E-14	73
Immune/Additional	IFI6 RGS1 PHACTR1 KRT15	6.61E-14	73
Immune/Additional	IFI6 CFH RGS1 KRT15	6.90E-14	73
Immune/Additional	FN1 RGS1 PHACTR1 SPP1	7.42E-14	77
Immune/Additional	BCL2A1 IFI6 RGS1 SPP1	7.76E-14	74
Immune/Additional	BCL2A1 IFI6 RGS1 KRT15	8.11E-14	73
Immune/Additional	FN1 BCL2A1 IFI6 RGS1	8.15E-14	75
Immune/Additional	FABP7 PTN RGS1 PHACTR1	8.77E-14	78
Immune/Additional	PTN CFH RGS1 SPP1	8.97E-14	78
Immune/Additional	PTN PRAME RGS1 PHACTR1	9.33E-14	76
Immune/Additional	CCL3 PTN PRAME KRT15	9.68E-14	76
Immune/Additional	FN1 IFI6 RGS1 SPP1	9.75E-14	74
Immune/Additional	FN1 PTN BCL2A1 RGS1	9.82E-14	78
Immune/Additional	FN1 BCL2A1 RGS1 PHACTR1	1.01E-13	78
Immune/Additional	HEY1 PTN RGS1 SPP1	1.10E-13	78
Immune/Additional	FABP7 FN1 RGS1 PHACTR1	1.14E-13	78
Immune/Additional	CCL3 PRAME BCL2A1 KRT15	1.15E-13	76
Immune/Additional	FABP7 RGS1 PHACTR1 SPP1	1.15E-13	77
Immune/Additional	HEY1 RGS1 PHACTR1 SPP1	1.17E-13	77
Immune/Additional	CCL3 RGS1 PHACTR1 SPP1	1.17E-13	77
Immune/Additional	FN1 PRAME RGS1 PHACTR1	1.26E-13	76
Immune/Additional	FN1 PTN RGS1 PHACTR1	1.29E-13	78
Immune/Additional	CCL3 PRAME SPP1 KRT15	1.30E-13	75
Immune/Additional	BCL2A1 RGS1 PHACTR1 SPP1	1.32E-13	77

Immune/Additional	CFH RGS1 PHACTR1 SPP1	1.35E-13	77
Immune/Additional	FABP7 FN1 BCL2A1 RGS1	1.38E-13	78
Immune/Additional	HEY1 PTN PRAME RGS1	1.43E-13	76
Immune/Additional	HEY1 FN1 BCL2A1 RGS1	1.47E-13	78
Immune/Additional	HEY1 FABP7 RGS1 PHACTR1	1.49E-13	78
Immune/Additional	PTN PRAME RGS1 SPP1	1.50E-13	75
Immune/Additional	HEY1 FABP7 RGS1 SPP1	1.53E-13	78
Immune/Additional	HEY1 BCL2A1 RGS1 SPP1	1.55E-13	77
Immune/Additional	HEY1 CCL3 PRAME KRT15	1.56E-13	76
Immune/Additional	PRAME RGS1 PHACTR1 SPP1	1.56E-13	75
Immune/Additional	HEY1 FN1 RGS1 PHACTR1	1.62E-13	78
Immune/Additional	FN1 CFH RGS1 PHACTR1	1.67E-13	78
Immune/Additional	HEY1 CCL3 RGS1 SPP1	1.69E-13	77
Immune/Additional	FABP7 PTN RGS1 SPP1	1.71E-13	78
Immune/Additional	FN1 PRAME RGS1 SPP1	1.71E-13	75
Immune/Additional	CCL3 PRAME PHACTR1 KRT15	1.72E-13	76
Immune/Additional	PTN BCL2A1 RGS1 SPP1	1.75E-13	77
Immune/Additional	PTN CFH RGS1 PHACTR1	1.76E-13	78
Immune/Additional	HEY1 FN1 RGS1 SPP1	1.77E-13	78
Immune/Additional	FABP7 PTN PRAME RGS1	1.77E-13	76
Immune/Additional	CCL3 FN1 BCL2A1 RGS1	1.78E-13	78
Immune/Additional	PTN BCL2A1 RGS1 PHACTR1	1.78E-13	78
Immune/Additional	HEY1 PTN RGS1 PHACTR1	1.81E-13	78
Immune/Additional	HEY1 PTN BCL2A1 RGS1	1.82E-13	78
Immune/Additional	CCL3 FN1 RGS1 PHACTR1	1.82E-13	78
Immune/Additional	FN1 BCL2A1 CFH RGS1	1.87E-13	78
Immune/Additional	CCL3 FABP7 PRAME KRT15	1.90E-13	76
Immune/Additional	CCL3 FN1 PRAME KRT15	1.95E-13	76
Immune/Additional	FN1 CFH RGS1 SPP1	1.97E-13	78
Immune/Additional	HEY1 PRAME RGS1 SPP1	2.00E-13	75
Immune/Additional	HEY1 CCL3 FABP7 RGS1	2.02E-13	78
Immune/Additional	HEY1 FABP7 BCL2A1 RGS1	2.05E-13	78
Immune/Additional	CCL3 FN1 RGS1 SPP1	2.11E-13	77
Immune/Additional	HEY1 FN1 PRAME RGS1	2.17E-13	76
Immune/Additional	CCL3 PRAME RGS1 PHACTR1	2.17E-13	76
Immune/Additional	HEY1 PRAME RGS1 PHACTR1	2.18E-13	76
Immune/Additional	HEY1 CFH RGS1 SPP1	2.26E-13	78
Immune/Additional	FABP7 PTN BCL2A1 RGS1	2.26E-13	78
Immune/Additional	FABP7 PRAME RGS1 PHACTR1	2.27E-13	76
Immune/Additional	FN1 PTN RGS1 SPP1	2.28E-13	78
Immune/Additional	HEY1 BCL2A1 RGS1 PHACTR1	2.31E-13	78
Immune/Additional	FN1 PTN PRAME RGS1	2.31E-13	76
Immune/Additional	CCL3 PRAME CFH KRT15	2.38E-13	76
Immune/Additional	FN1 PRAME BCL2A1 RGS1	2.40E-13	76
Immune/Additional	HEY1 FABP7 PRAME RGS1	2.46E-13	76
Immune/Additional	FABP7 BCL2A1 RGS1 PHACTR1	2.54E-13	78
Immune/Additional	HEY1 FABP7 FN1 RGS1	2.55E-13	79
Immune/Additional	FABP7 FN1 RGS1 SPP1	2.63E-13	78
Immune/Additional	PRAME BCL2A1 RGS1 PHACTR1	2.68E-13	76
Immune/Additional	PRAME PHACTR1 SPP1 KRT15	2.74E-13	75
Immune/Additional	BCL2A1 CFH RGS1 SPP1	2.86E-13	77
Immune/Additional	HEY1 CCL3 PTN RGS1	2.89E-13	78
Immune/Additional	CCL3 FABP7 RGS1 PHACTR1	2.90E-13	78

Immune/Additional	HEY1 CCL3 FN1 RGS1	2.95E-13	78
Immune/Additional	CCL3 BCL2A1 RGS1 PHACTR1	2.99E-13	78
Immune/Additional	FABP7 BCL2A1 RGS1 SPP1	3.04E-13	77
Immune/Additional	CCL3 BCL2A1 RGS1 SPP1	3.07E-13	77
Immune/Additional	FABP7 CFH RGS1 PHACTR1	3.09E-13	78
Immune/Additional	FABP7 CFH RGS1 SPP1	3.11E-13	78
Immune/Additional	FABP7 FN1 PRAME RGS1	3.12E-13	76
Immune/Additional	PRAME CFH RGS1 PHACTR1	3.13E-13	76
Immune/Additional	HEY1 CCL3 RGS1 PHACTR1	3.17E-13	78
Immune/Additional	BCL2A1 CFH RGS1 PHACTR1	3.21E-13	78
Immune/Additional	CCL3 PTN RGS1 SPP1	3.23E-13	77
Immune/Additional	FABP7 PTN CFH RGS1	3.26E-13	79
Immune/Additional	FABP7 PRAME RGS1 SPP1	3.27E-13	75
Immune/Additional	CCL3 PRAME RGS1 SPP1	3.37E-13	75
Immune/Additional	FABP7 PRAME SPP1 KRT15	3.45E-13	75
Immune/Additional	PTN BCL2A1 CFH RGS1	3.48E-13	78
Immune/Additional	PRAME BCL2A1 RGS1 SPP1	3.48E-13	75
Immune/Additional	HEY1 CFH RGS1 PHACTR1	3.49E-13	78
Immune/Additional	PRAME CFH SPP1 KRT15	3.56E-13	75
Immune/Additional	HEY1 CCL3 BCL2A1 RGS1	3.57E-13	78
Immune/Additional	CCL3 PTN RGS1 PHACTR1	3.58E-13	78
Immune/Additional	PRAME BCL2A1 SPP1 KRT15	3.62E-13	75
Immune/Additional	HEY1 PRAME BCL2A1 RGS1	3.64E-13	76
Immune/Additional	HEY1 FABP7 CFH RGS1	3.75E-13	79
Immune/Additional	CCL3 CFH RGS1 SPP1	3.77E-13	77
Immune/Additional	PTN PRAME BCL2A1 RGS1	3.78E-13	76
Immune/Additional	PRAME IFI6 RGS1 SPP1	3.81E-13	70
Immune/Additional	IFI6 RGS1 PHACTR1 SPP1	3.89E-13	72
Immune/Additional	HEY1 CCL3 PRAME RGS1	4.17E-13	76
Immune/Additional	PRAME CFH RGS1 SPP1	4.32E-13	75
Immune/Additional	CCL3 FN1 PRAME RGS1	4.39E-13	76
Immune/Additional	PTN PRAME CFH RGS1	4.39E-13	76
Immune/Additional	HEY1 PRAME SPP1 KRT15	4.41E-13	75
Immune/Additional	FN1 PRAME CFH RGS1	4.42E-13	76
Immune/Additional	HEY1 IFI6 RGS1 SPP1	4.44E-13	72
Immune/Additional	HEY1 BCL2A1 CFH RGS1	4.53E-13	78
Immune/Additional	HEY1 PRAME CFH RGS1	4.67E-13	76
Immune/Additional	CCL3 CFH RGS1 PHACTR1	4.76E-13	78
Immune/Additional	PTN PRAME SPP1 KRT15	4.92E-13	75
Immune/Additional	CCL3 FABP7 RGS1 SPP1	5.06E-13	77
Immune/Additional	IFI6 CFH RGS1 SPP1	5.56E-13	72
Immune/Additional	PRAME IFI6 RGS1 PHACTR1	5.61E-13	71
Immune/Additional	FN1 PRAME SPP1 KRT15	5.68E-13	75
Immune/Additional	CCL3 PRAME IFI6 KRT15	5.91E-13	71
Immune/Additional	HEY1 FABP7 IFI6 RGS1	5.92E-13	73
Immune/Additional	PTN IFI6 RGS1 SPP1	6.17E-13	72
Immune/Additional	CCL3 IFI6 RGS1 SPP1	6.22E-13	72
Immune/Additional	CCL3 PTN BCL2A1 RGS1	6.42E-13	78
Immune/Additional	FABP7 IFI6 RGS1 SPP1	6.57E-13	72
Immune/Additional	FABP7 PRAME BCL2A1 RGS1	6.62E-13	76
Immune/Additional	CCL3 FABP7 BCL2A1 RGS1	6.78E-13	78
Immune/Additional	CCL3 FN1 CFH RGS1	6.93E-13	78
Immune/Additional	HEY1 CCL3 CFH RGS1	6.98E-13	78

Immune/Additional	HEY1 PRAME IFI6 RGS1	7.06E-13	71
Immune/Additional	FABP7 BCL2A1 CFH RGS1	7.06E-13	78
Immune/Additional	PRAME BCL2A1 IFI6 RGS1	7.69E-13	71
Immune/Additional	FN1 PRAME IFI6 RGS1	7.95E-13	71
Immune/Additional	CCL3 PRAME BCL2A1 RGS1	8.06E-13	76
Immune/Additional	BCL2A1 IFI6 RGS1 PHACTR1	8.07E-13	73
Immune/Additional	FABP7 IFI6 RGS1 PHACTR1	8.22E-13	73
Immune/Additional	CCL3 FABP7 FN1 RGS1	8.25E-13	78
Immune/Additional	FABP7 FN1 CFH RGS1	8.35E-13	79
Immune/Additional	FN1 IFI6 RGS1 PHACTR1	8.44E-13	73
Immune/Additional	HEY1 BCL2A1 IFI6 RGS1	8.46E-13	73
Immune/Additional	FABP7 BCL2A1 IFI6 RGS1	8.64E-13	73
Immune/Additional	CCL3 PTN PRAME RGS1	8.71E-13	76
Immune/Additional	PTN PRAME IFI6 RGS1	8.71E-13	71
Immune/Additional	FABP7 PRAME IFI6 RGS1	8.83E-13	71
Immune/Additional	HEY1 PTN CFH RGS1	9.30E-13	79
Immune/Additional	CCL3 BCL2A1 CFH RGS1	9.50E-13	78
Immune/Additional	CCL3 FABP7 PRAME RGS1	9.60E-13	76
Immune/Additional	HEY1 FN1 PTN RGS1	9.82E-13	79
Immune/Additional	PRAME BCL2A1 CFH RGS1	9.87E-13	76
Immune/Additional	CCL3 PRAME IFI6 RGS1	1.00E-12	71
Immune/Additional	HEY1 IFI6 RGS1 PHACTR1	1.02E-12	73
Immune/Additional	HEY1 CCL3 IFI6 RGS1	1.03E-12	73
Immune/Additional	CCL3 BCL2A1 IFI6 RGS1	1.09E-12	73
Immune/Additional	HEY1 FN1 IFI6 RGS1	1.15E-12	73
Immune/Additional	HEY1 FABP7 PRAME KRT15	1.16E-12	76
Immune/Additional	FABP7 FN1 PTN RGS1	1.20E-12	79
Immune/Additional	PRAME IFI6 CFH RGS1	1.22E-12	71
Immune/Additional	HEY1 FN1 CFH RGS1	1.25E-12	79
Immune/Additional	FABP7 PRAME CFH RGS1	1.27E-12	76
Immune/Additional	PTN BCL2A1 IFI6 RGS1	1.30E-12	73
Immune/Additional	CCL3 IFI6 RGS1 PHACTR1	1.31E-12	73
Immune/Additional	PRAME IFI6 SPP1 KRT15	1.32E-12	70
Immune/Additional	FN1 PTN CFH RGS1	1.39E-12	79
Immune/Additional	BCL2A1 IFI6 CFH RGS1	1.42E-12	73
Immune/Additional	IFI6 CFH RGS1 PHACTR1	1.42E-12	73
Immune/Additional	HEY1 PRAME CFH KRT15	1.52E-12	76
Immune/Additional	FABP7 PRAME PHACTR1 KRT15	1.55E-12	76
Immune/Additional	PRAME BCL2A1 PHACTR1 KRT15	1.55E-12	76
Immune/Additional	HEY1 PRAME BCL2A1 KRT15	1.57E-12	76
Immune/Additional	PTN IFI6 RGS1 PHACTR1	1.57E-12	73
Immune/Additional	PRAME CFH PHACTR1 KRT15	1.57E-12	76
Immune/Additional	FN1 PRAME PHACTR1 KRT15	1.61E-12	76
Immune/Additional	HEY1 PTN IFI6 RGS1	1.69E-12	73
Immune/Additional	CCL3 PRAME CFH RGS1	1.76E-12	76
Immune/Additional	CCL3 PTN CFH RGS1	1.87E-12	78
Immune/Additional	HEY1 PRAME PHACTR1 KRT15	1.90E-12	76
Immune/Additional	FABP7 FN1 PRAME KRT15	1.94E-12	76
Immune/Additional	CCL3 FN1 PTN RGS1	2.00E-12	78
Immune/Additional	FABP7 PRAME BCL2A1 KRT15	2.01E-12	76
Immune/Additional	FABP7 FN1 IFI6 RGS1	2.07E-12	73
Immune/Additional	HEY1 IFI6 CFH RGS1	2.08E-12	73
Immune/Additional	CCL3 CFH SPP1 KRT15	2.20E-12	77

Immune/Additional	PTN PRAME PHACTR1 KRT15	2.29E-12	76
Immune/Additional	FABP7 PRAME CFH KRT15	2.32E-12	76
Immune/Additional	CCL3 PTN CFH KRT15	2.36E-12	78
Immune/Additional	CCL3 PTN SPP1 KRT15	2.37E-12	77
Immune/Additional	FN1 IFI6 CFH RGS1	2.53E-12	73
Immune/Additional	FN1 PRAME CFH KRT15	2.58E-12	76
Immune/Additional	PRAME BCL2A1 CFH KRT15	2.62E-12	76
Immune/Additional	FABP7 PTN PRAME KRT15	2.65E-12	76
Immune/Additional	CCL3 FABP7 CFH RGS1	2.67E-12	78
Immune/Additional	FABP7 IFI6 CFH RGS1	2.74E-12	73
Immune/Additional	CCL3 PHACTR1 SPP1 KRT15	2.88E-12	77
Immune/Additional	HEY1 CCL3 PTN KRT15	2.90E-12	78
Immune/Additional	HEY1 FN1 PRAME KRT15	2.99E-12	76
Immune/Additional	HEY1 CCL3 SPP1 KRT15	3.02E-12	77
Immune/Additional	CCL3 FN1 SPP1 KRT15	3.09E-12	77
Immune/Additional	CCL3 FABP7 PTN RGS1	3.11E-12	78
Immune/Additional	CCL3 FN1 PTN KRT15	3.15E-12	78
Immune/Additional	HEY1 PTN PRAME KRT15	3.27E-12	76
Immune/Additional	CCL3 FABP7 SPP1 KRT15	3.35E-12	77
Immune/Additional	CCL3 BCL2A1 SPP1 KRT15	3.35E-12	77
Immune/Additional	PTN PRAME CFH KRT15	3.39E-12	76
Immune/Additional	CCL3 IFI6 CFH RGS1	3.71E-12	73
Immune/Additional	CCL3 FABP7 IFI6 RGS1	3.77E-12	73
Immune/Additional	HEY1 CCL3 PHACTR1 KRT15	3.86E-12	78
Immune/Additional	CCL3 FN1 IFI6 RGS1	3.87E-12	73
Immune/Additional	PTN IFI6 CFH RGS1	4.18E-12	73
Immune/Additional	HEY1 CCL3 CFH KRT15	4.23E-12	78
Immune/Additional	CCL3 FN1 CFH KRT15	4.32E-12	78
Immune/Additional	FABP7 PTN IFI6 RGS1	4.32E-12	73
Immune/Additional	FN1 PTN PRAME KRT15	4.34E-12	76
Immune/Additional	HEY1 CCL3 BCL2A1 KRT15	4.37E-12	78
Immune/Additional	HEY1 CCL3 FN1 KRT15	4.41E-12	78
Immune/Additional	CCL3 FN1 PHACTR1 KRT15	4.43E-12	78
Immune/Additional	FN1 PRAME BCL2A1 KRT15	4.45E-12	76
Immune/Additional	HEY1 CCL3 FABP7 KRT15	4.85E-12	78
Immune/Additional	CCL3 FABP7 FN1 KRT15	4.90E-12	78
Immune/Additional	CCL3 FN1 BCL2A1 KRT15	5.05E-12	78
Immune/Additional	CCL3 PTN PHACTR1 KRT15	5.16E-12	78
Immune/Additional	CCL3 CFH PHACTR1 KRT15	5.46E-12	78
Immune/Additional	PTN PRAME BCL2A1 KRT15	5.86E-12	76
Immune/Additional	CCL3 FABP7 CFH KRT15	5.95E-12	78
Immune/Additional	CCL3 PTN BCL2A1 KRT15	6.02E-12	78
Immune/Additional	CCL3 FABP7 PTN KRT15	6.09E-12	78
Immune/Additional	CCL3 BCL2A1 CFH KRT15	6.33E-12	78
Immune/Additional	CCL3 PRAME IFI6 SPP1	6.43E-12	70
Immune/Additional	CCL3 FABP7 PHACTR1 KRT15	7.08E-12	78
Immune/Additional	HEY1 CFH SPP1 KRT15	7.22E-12	78
Immune/Additional	FN1 PTN IFI6 RGS1	7.22E-12	73
Immune/Additional	CCL3 BCL2A1 PHACTR1 KRT15	7.24E-12	78
Immune/Additional	CCL3 FABP7 BCL2A1 KRT15	8.01E-12	78
Immune/Additional	PTN CFH SPP1 KRT15	8.62E-12	78
Immune/Additional	CCL3 PTN IFI6 RGS1	9.08E-12	73
Immune/Additional	CCL3 IFI6 SPP1 KRT15	9.33E-12	72

Immune/Additional	HEY1 CCL3 IFI6 KRT15	1.02E-11	73
Immune/Additional	CFH PHACTR1 SPP1 KRT15	1.02E-11	77
Immune/Additional	FABP7 CFH SPP1 KRT15	1.06E-11	78
Immune/Additional	HEY1 FABP7 SPP1 KRT15	1.23E-11	78
Immune/Additional	FN1 CFH SPP1 KRT15	1.24E-11	78
Immune/Additional	CCL3 FN1 PRAME SPP1	1.29E-11	75
Immune/Additional	CCL3 FN1 IFI6 KRT15	1.30E-11	73
Immune/Additional	HEY1 PRAME IFI6 KRT15	1.35E-11	71
Immune/Additional	CCL3 PTN PRAME SPP1	1.37E-11	75
Immune/Additional	PRAME IFI6 PHACTR1 KRT15	1.41E-11	71
Immune/Additional	HEY1 PHACTR1 SPP1 KRT15	1.42E-11	77
Immune/Additional	FABP7 PRAME IFI6 KRT15	1.43E-11	71
Immune/Additional	BCL2A1 CFH SPP1 KRT15	1.44E-11	77
Immune/Additional	CCL3 IFI6 PHACTR1 KRT15	1.51E-11	73
Immune/Additional	CCL3 PRAME PHACTR1 SPP1	1.54E-11	75
Immune/Additional	HEY1 PTN SPP1 KRT15	1.59E-11	78
Immune/Additional	HEY1 FN1 SPP1 KRT15	1.61E-11	78
Immune/Additional	PRAME BCL2A1 IFI6 KRT15	1.62E-11	71
Immune/Additional	PRAME IFI6 CFH KRT15	1.63E-11	71
Immune/Additional	CCL3 PTN IFI6 KRT15	1.67E-11	73
Immune/Additional	CCL3 FABP7 IFI6 KRT15	1.73E-11	73
Immune/Additional	CCL3 BCL2A1 IFI6 KRT15	1.82E-11	73
Immune/Additional	PTN PRAME IFI6 KRT15	1.84E-11	71
Immune/Additional	HEY1 BCL2A1 SPP1 KRT15	1.91E-11	77
Immune/Additional	FN1 PRAME IFI6 KRT15	1.91E-11	71
Immune/Additional	CCL3 IFI6 CFH KRT15	2.09E-11	73
Immune/Additional	CCL3 FABP7 PRAME SPP1	2.24E-11	75
Immune/Additional	HEY1 CCL3 PRAME SPP1	2.63E-11	75
Immune/Additional	FABP7 PRAME PHACTR1 SPP1	2.75E-11	75
Immune/Additional	FABP7 PTN PRAME SPP1	2.77E-11	75
Immune/Additional	FN1 PRAME PHACTR1 SPP1	2.80E-11	75
Immune/Additional	BCL2A1 PHACTR1 SPP1 KRT15	2.80E-11	77
Immune/Additional	FABP7 FN1 PRAME SPP1	2.83E-11	75
Immune/Additional	FN1 PHACTR1 SPP1 KRT15	2.84E-11	77
Immune/Additional	PTN PHACTR1 SPP1 KRT15	2.85E-11	77
Immune/Additional	CCL3 PRAME BCL2A1 SPP1	2.86E-11	75
Immune/Additional	FABP7 PHACTR1 SPP1 KRT15	3.01E-11	77
Immune/Additional	FABP7 PRAME IFI6 SPP1	3.29E-11	70
Immune/Additional	SELL HLA ITGB2 KRT15	3.45E-11	52
Immune/Additional	FABP7 BCL2A1 SPP1 KRT15	3.50E-11	77
Immune/Additional	RGS1 SELL ITGB2 KRT15	3.57E-11	52
Immune/Additional	BCL2A1 CCL5 S100A9 KRT15	3.63E-11	52
Immune/Additional	IRF1 SELL ITGB2 KRT15	3.66E-11	52
Immune/Additional	CCL3 PRAME CFH SPP1	3.69E-11	75
Immune/Additional	PRAME BCL2A1 IFI6 SPP1	3.69E-11	70
Immune/Additional	RGS1 SELL KRT15 HCLS1	3.69E-11	52
Immune/Additional	BCL2A1 RGS1 CCL5 PTPRC	3.73E-11	52
Immune/Additional	RGS1 CCL5 PTPRC PHACTR1	3.73E-11	52
Immune/Additional	FN1 PRAME IFI6 SPP1	3.74E-11	70
Immune/Additional	PRAME RGS1 CCL5 PTPRC	3.75E-11	52
Immune/Additional	BCL2A1 CCL5 PTPRC PHACTR1	3.81E-11	52
Immune/Additional	BCL2A1 CCL5 PTPRC KRT15	3.81E-11	52
Immune/Additional	FABP7 FN1 SPP1 KRT15	3.88E-11	78

Immune/Additional	CCL5 SELL PTPRC PHACTR1	3.88E-11	52
Immune/Additional	FN1 BCL2A1 SPP1 KRT15	3.91E-11	77
Immune/Additional	CCL3 RGS1 CCL5 PTPRC	3.94E-11	52
Immune/Additional	HLA CCL5 SELL KRT15	3.98E-11	52
Immune/Additional	PRAME IFI6 PHACTR1 SPP1	4.02E-11	70
Immune/Additional	FN1 PTN SPP1 KRT15	4.06E-11	78
Immune/Additional	FABP7 CCL5 S100A9 PTPRC	4.07E-11	52
Immune/Additional	FABP7 PTN SPP1 KRT15	4.13E-11	78
Immune/Additional	PTPN22 CCL5 PTPRC PHACTR1	4.16E-11	52
Immune/Additional	CCL5 SELL PTPRC KRT15	4.18E-11	52
Immune/Additional	PTN PRAME IFI6 SPP1	4.25E-11	70
Immune/Additional	PTN PRAME PHACTR1 SPP1	4.31E-11	75
Immune/Additional	RGS1 CCL5 PTPRC KRT15	4.31E-11	52
Immune/Additional	FABP7 BCL2A1 CCL5 PTPRC	4.34E-11	52
Immune/Additional	PTN BCL2A1 SPP1 KRT15	4.35E-11	77
Immune/Additional	RGS1 CCL5 PTPRC LCP2	4.36E-11	52
Immune/Additional	HEY1 RGS1 CCL5 PTPRC	4.37E-11	52
Immune/Additional	HLA RGS1 CCL5 PTPRC	4.37E-11	52
Immune/Additional	IRF1 CCL5 SELL PTPRC	4.39E-11	52
Immune/Additional	FABP7 CCL5 PTPRC PHACTR1	4.45E-11	52
Immune/Additional	CCL5 PTPRC LCP2 HCLS1	4.50E-11	52
Immune/Additional	HEY1 CCL5 S100A9 KRT15	4.52E-11	52
Immune/Additional	CCL5 S100A9 LCP2 KRT15	4.52E-11	52
Immune/Additional	FABP7 CCL5 S100A9 KRT15	4.55E-11	52
Immune/Additional	RGS1 CCL5 HLA PTPRC	4.56E-11	52
Immune/Additional	SELL S100A9 PHACTR1 KRT15	4.56E-11	52
Immune/Additional	FABP7 RGS1 CCL5 PTPRC	4.57E-11	52
Immune/Additional	HEY1 FABP7 PRAME SPP1	4.61E-11	75
Immune/Additional	PRAME RGS1 SELL KRT15	4.61E-11	52
Immune/Additional	CCL3 BCL2A1 CCL5 PTPRC	4.63E-11	52
Immune/Additional	CCL5 SELL S100A9 KRT15	4.65E-11	52
Immune/Additional	PRAME PTPN22 CCL5 PTPRC	4.67E-11	52
Immune/Additional	BCL2A1 CCL5 S100A9 PTPRC	4.67E-11	52
Immune/Additional	PTPN22 CCL5 PTPRC LCP2	4.68E-11	52
Immune/Additional	PRAME CCL5 PTPRC PHACTR1	4.70E-11	52
Immune/Additional	CCL5 SELL ITGB2 KRT15	4.71E-11	52
Immune/Additional	HEY1 PRAME IFI6 SPP1	4.72E-11	70
Immune/Additional	BCL2A1 CCL5 HLA PTPRC	4.73E-11	52
Immune/Additional	IRF1 CCL5 S100A9 KRT15	4.74E-11	52
Immune/Additional	HEY1 PTPN22 CCL5 PTPRC	4.75E-11	52
Immune/Additional	PRAME CCL5 S100A9 KRT15	4.75E-11	52
Immune/Additional	PTPN22 CCL5 PTPRC KRT15	4.75E-11	52
Immune/Additional	RGS1 SELL S100A9 KRT15	4.77E-11	52
Immune/Additional	PTN RGS1 CCL5 PTPRC	4.81E-11	52
Immune/Additional	CCL5 SELL PTPRC LCP2	4.82E-11	52
Immune/Additional	HEY1 BCL2A1 CCL5 PTPRC	4.84E-11	52
Immune/Additional	RGS1 CCL5 S100A9 PTPRC	4.84E-11	52
Immune/Additional	CCL3 CCL5 S100A9 KRT15	4.85E-11	52
Immune/Additional	CCL5 HLA S100A9 KRT15	4.87E-11	52
Immune/Additional	BCL2A1 PTPN22 CCL5 PTPRC	4.89E-11	52
Immune/Additional	PTPN22 RGS1 CCL5 PTPRC	4.89E-11	52
Immune/Additional	CCL5 PTPRC LCP2 CXCL9	4.91E-11	52
Immune/Additional	HEY1 CCL5 PTPRC KRT15	4.93E-11	52

Immune/Additional	PRAME CCL5 PTPRC KRT15	4.93E-11	52
Immune/Additional	RGS1 CCL5 SELL PTPRC	4.94E-11	52
Immune/Additional	PTPN22 CCL5 HLA PTPRC	4.95E-11	52
Immune/Additional	PRAME BCL2A1 SELL KRT15	4.96E-11	52
Immune/Additional	BCL2A1 HLA CCL5 PTPRC	4.98E-11	52
Immune/Additional	FABP7 CCL5 PTPRC LCP2	5.02E-11	52
Immune/Additional	CCL5 SELL KRT15 HCLS1	5.06E-11	52
Immune/Additional	CCL3 CCL5 SELL KRT15	5.07E-11	52
Immune/Additional	PRAME BCL2A1 PHACTR1 SPP1	5.07E-11	75
Immune/Additional	RGS1 IRF1 CCL5 PTPRC	5.07E-11	52
Immune/Additional	CCL3 PTPN22 CCL5 PTPRC	5.09E-11	52
Immune/Additional	PRAME IFI6 CFH SPP1	5.11E-11	70
Immune/Additional	RGS1 SELL LCP2 KRT15	5.11E-11	52
Immune/Additional	CCL5 S100A9 PTPRC LCP2	5.12E-11	52
Immune/Additional	BCL2A1 CCL5 PTPRC LCP2	5.13E-11	52
Immune/Additional	CCL5 SELL LCP2 KRT15	5.14E-11	52
Immune/Additional	CCL3 CCL5 PTPRC PHACTR1	5.18E-11	52
Immune/Additional	CCL3 FABP7 CCL5 PTPRC	5.20E-11	52
Immune/Additional	CCL5 PTPRC PHACTR1 LCP2	5.20E-11	52
Immune/Additional	CCL5 PTPRC PHACTR1 KRT15	5.21E-11	52
Immune/Additional	PRAME BCL2A1 CCL5 PTPRC	5.24E-11	52
Immune/Additional	CCL5 S100A9 PHACTR1 KRT15	5.25E-11	52
Immune/Additional	HLA CCL5 S100A9 KRT15	5.26E-11	52
Immune/Additional	FN1 PRAME BCL2A1 SPP1	5.29E-11	75
Immune/Additional	PRAME CCL5 HLA PTPRC	5.29E-11	52
Immune/Additional	FABP7 PRAME CCL5 PTPRC	5.31E-11	52
Immune/Additional	PRAME IRF1 SELL KRT15	5.31E-11	52
Immune/Additional	CCL5 S100A9 KRT15 CXCL9	5.31E-11	52
Immune/Additional	CCL5 S100A9 PTPRC PHACTR1	5.34E-11	52
Immune/Additional	PTN PRAME KRT15 CXCL9	5.37E-11	52
Immune/Additional	FABP7 PTN CCL5 PTPRC	5.38E-11	52
Immune/Additional	IRF1 SELL S100A9 KRT15	5.38E-11	52
Immune/Additional	FABP7 PTPN22 CCL5 PTPRC	5.40E-11	52
Immune/Additional	CCL5 HLA PTPRC PHACTR1	5.40E-11	52
Immune/Additional	CFH CCL5 S100A9 KRT15	5.42E-11	52
Immune/Additional	FABP7 CCL5 SELL PTPRC	5.44E-11	52
Immune/Additional	PECAM1 RGS1 CCL5 PTPRC	5.44E-11	52
Immune/Additional	CCL5 S100A9 PTPRC KRT15	5.45E-11	52
Immune/Additional	FABP7 PRAME SELL KRT15	5.47E-11	52
Immune/Additional	HLA SELL KRT15 CXCL9	5.48E-11	52
Immune/Additional	PTPN22 IRF1 CCL5 PTPRC	5.50E-11	52
Immune/Additional	CCL5 HLA S100A9 PTPRC	5.50E-11	52
Immune/Additional	PTPN22 CCL5 S100A9 PTPRC	5.51E-11	52
Immune/Additional	IRF1 CCL5 PTPRC LCP2	5.53E-11	52
Immune/Additional	PRAME CCL5 S100A9 PTPRC	5.55E-11	52
Immune/Additional	PRAME SELL HLA KRT15	5.56E-11	52
Immune/Additional	CCL5 PTPRC LCP2 KRT15	5.56E-11	52
Immune/Additional	CCL3 PRAME CCL5 PTPRC	5.61E-11	52
Immune/Additional	RGS1 SELL KRT15 CXCL9	5.61E-11	52
Immune/Additional	PRAME SELL PTPRC KRT15	5.62E-11	52
Immune/Additional	BCL2A1 IRF1 CCL5 PTPRC	5.62E-11	52
Immune/Additional	RGS1 CCL5 PTPRC CXCL9	5.63E-11	52
Immune/Additional	S100A9 PTPRC LCP2 KRT15	5.63E-11	52

Immune/Additional	PTN RGS1 KRT15 CXCL9	5.65E-11	52
Immune/Additional	SELL HLA S100A9 KRT15	5.65E-11	52
Immune/Additional	SELL ITGB2 PHACTR1 KRT15	5.65E-11	52
Immune/Additional	CCL5 S100A9 KRT15 HCLS1	5.66E-11	52
Immune/Additional	PTN PRAME SELL KRT15	5.68E-11	52
Immune/Additional	FABP7 S100A9 PTPRC KRT15	5.70E-11	52
Immune/Additional	HEY1 CCL5 PTPRC PHACTR1	5.71E-11	52
Immune/Additional	CCL3 RGS1 SELL KRT15	5.71E-11	52
Immune/Additional	FN1 RGS1 CCL5 PTPRC	5.71E-11	52
Immune/Additional	CFH RGS1 CCL5 PTPRC	5.74E-11	52
Immune/Additional	CCL3 CCL5 S100A9 PTPRC	5.75E-11	52
Immune/Additional	HEY1 FABP7 CCL5 PTPRC	5.76E-11	52
Immune/Additional	HEY1 PRAME PHACTR1 SPP1	5.77E-11	75
Immune/Additional	HLA PHACTR1 KRT15 CXCL9	5.77E-11	52
Immune/Additional	HLA PTPN22 CCL5 PTPRC	5.79E-11	52
Immune/Additional	SELL S100A9 PTPRC KRT15	5.80E-11	52
Immune/Additional	CFH PTPN22 CCL5 PTPRC	5.82E-11	52
Immune/Additional	CCL5 HLA PTPRC KRT15	5.82E-11	52
Immune/Additional	FABP7 SELL S100A9 KRT15	5.84E-11	52
Immune/Additional	PRAME CCL5 SELL PTPRC	5.84E-11	52
Immune/Additional	IRF1 CCL5 SELL KRT15	5.84E-11	52
Immune/Additional	PRAME SELL PHACTR1 KRT15	5.85E-11	52
Immune/Additional	PRAME CCL5 PTPRC LCP2	5.86E-11	52
Immune/Additional	RGS1 CCL5 PTPRC HCLS1	5.87E-11	52
Immune/Additional	CCL3 PRAME SELL KRT15	5.88E-11	52
Immune/Additional	PTN BCL2A1 CCL5 PTPRC	5.88E-11	52
Immune/Additional	FABP7 CCL5 HLA PTPRC	5.90E-11	52
Immune/Additional	PTN PTPN22 CCL5 PTPRC	5.90E-11	52
Immune/Additional	PRAME SELL KRT15 CXCL9	5.90E-11	52
Immune/Additional	PECAM1 SELL S100A9 KRT15	5.90E-11	52
Immune/Additional	HEY1 CCL5 PTPRC LCP2	5.92E-11	52
Immune/Additional	CCL3 S100A9 PTPRC KRT15	5.94E-11	52
Immune/Additional	HEY1 PRAME CCL5 PTPRC	5.96E-11	52
Immune/Additional	RGS1 CCL5 S100A9 KRT15	5.96E-11	52
Immune/Additional	BCL2A1 PECAM1 CCL5 PTPRC	6.00E-11	52
Immune/Additional	HEY1 PRAME SELL KRT15	6.02E-11	52
Immune/Additional	PTN CCL5 S100A9 KRT15	6.02E-11	52
Immune/Additional	PTPN22 CCL5 SELL PTPRC	6.02E-11	52
Immune/Additional	S100A9 PTPRC PHACTR1 KRT15	6.05E-11	52
Immune/Additional	BCL2A1 CCL5 SELL KRT15	6.06E-11	52
Immune/Additional	CCL5 S100A9 ITGB2 KRT15	6.06E-11	52
Immune/Additional	CCL5 HLA PTPRC LCP2	6.07E-11	52
Immune/Additional	HLA RGS1 SELL KRT15	6.08E-11	52
Immune/Additional	PRAME HLA SELL KRT15	6.09E-11	52
Immune/Additional	PRAME LCP2 KRT15 CXCL9	6.11E-11	52
Immune/Additional	HEY1 CCL3 CCL5 PTPRC	6.14E-11	52
Immune/Additional	IRF1 CCL5 PTPRC PHACTR1	6.15E-11	52
Immune/Additional	HEY1 CCL5 S100A9 PTPRC	6.16E-11	52
Immune/Additional	S100A9 PTPRC KRT15 CXCL9	6.16E-11	52
Immune/Additional	PRAME CCL5 SELL KRT15	6.18E-11	52
Immune/Additional	RGS1 CCL5 SELL KRT15	6.19E-11	52

Example 5

[00219] In this example we determined a model for differentiating melanoma samples from nevus samples based on a computed score.

Methods

[00220] Approximately 600 skin lesions were acquired from two separate sites (coded “Munich” and “Provitro”), with relatively equal numbers from both locations. Each site provided both malignant and benign samples, with all major histological subtypes represented. The diagnosis for each case was confirmed, using a second dermatopathologist who was blinded to the diagnosis of the first dermatopathologist. If there was discordance, a third dermatopathologist adjudicated the diagnosis.

[00221] An H&E stained slide from each case was then reviewed by a pathologist, and the lesion of interest identified for each case. The corresponding tissue was macrodissected from 5 unstained slides (4 mm thickness) and pooled into a single tube. The RNA was then extracted from the tissue, the RNA was DNAsed using DNase I and cDNA synthesized. We then pre-amplified all genes of interest including 7 housekeeper normalization genes) in one multiplex reaction. Finally, quantitative PCR was used to measure the expression of each gene. The expression values were calculated by determining the CT (Crossing Threshold) of each gene. Each sample was run in triplicate by splitting each sample into 3 aliquots after the cDNA synthesis.

[00222] The three measurements of each gene were then averaged and normalized by the averaged expression of all seven housekeeper genes. Each gene was studied to determine if its expression could differentiate between malignant melanoma and benign nevi samples; if genes were effective at this, they were further analyzed to see which genes had correlating data (an indication that these genes measure the same biological pathway). Genes with correlating data were grouped together in sets, with the average expression of the set used to differentiate melanoma and nevi.

Results

[00223] We acquired ~600 samples from two German sites (labeled Munich and Provitro [Berlin]). Each site contributed roughly even numbers of malignant and

benign samples, with all major histologic subtypes represented in the samples from each site. We first identified the lesion of interest in each sample and then extracted the RNA from each sample and measured the RNA expression level of the potential signature genes and 7 housekeeper normalization genes (Table 11).

Table 11- List of potential signature genes tested and housekeeper genes used for normalization.

Gene	Function	Gene	Function
PTN	Potential Signature	CD38	Potential Signature
CFH	Potential Signature	RGS1	Potential Signature
IGJ	Potential Signature	DLGAP5	Potential Signature
HEY1	Potential Signature	MCM10	Potential Signature
PECAM1	Potential Signature	RRM2	Potential Signature
HCLS1	Potential Signature	CCL5	Potential Signature
HLA-DRA	Potential Signature	CXCL13	Potential Signature
HLA-DMA	Potential Signature	CXCL9	Potential Signature
BCL2A1	Potential Signature	CENPF	Potential Signature
FABP7	Potential Signature	PBK	Potential Signature
PTPRC	Potential Signature	CXCL10	Potential Signature
IFI6	Potential Signature	FOXM1	Potential Signature
S100A9	Potential Signature	PLK1	Potential Signature
FN1	Potential Signature	CEP55	Potential Signature
ITGB2	Potential Signature	DTL	Potential Signature
PTPN22	Potential Signature	SKA1	Potential Signature
PHACTR1	Potential Signature	CCL5	Potential Signature
CCL3	Potential Signature	CLTC	Housekeeper
PRAME	Potential Signature	MRFAP1	Housekeeper
KRT15	Potential Signature	PPP2CA	Housekeeper
SPP1	Potential Signature	PSMA1	Housekeeper
LCP2	Potential Signature	RPL13A	Housekeeper
IRF1	Potential Signature	RPL8	Housekeeper
SELL	Potential Signature	TXNL1	Housekeeper

[00224] The ability of each gene was then analyzed to determine if its expression was effective in differentiating the malignant melanoma and benign nevi samples. We determined that PRAME was a very effective biomarker (Figure 5). Furthermore, we also found that a large number of immune genes were also able to strongly differentiate melanoma and nevi. We further investigated 8 of these immune genes and found that their data was highly correlated, as the expression of each individual immune gene had a linear relationship with the average of all 8 immune

genes (Figure 6). This may indicate that they are measuring the same biological process, and they were thus grouped together into an “immune” set. The averaged expression of all 8 immune genes was calculated and then used when analyzing the dataset. Finally, we also noted that the cell cycle gene S100A9 also was able to differentiate many melanoma and nevi samples.

[00225] We next created a combined diagnostic model, using these three sets of biomarkers (PRAME, the immune genes, and S100A9). When the expression of each biomarker was graphed against the other, we did not see a high correlation, indicating that each biomarker is likely measuring a different biological process and has independent value (see Figure 7). We ran the data through a logistic regression model, to best determine how each biomarker could be weighted in the model, to maximize the model’s ability to differentiate melanoma and nevi. The most effective model was found with the following weightings for the expression of each biomarker set: $(0.525 \times \text{PRAME}) + (0.677 \times \text{Immune}) + (0.357 \times \text{S100A9})$. The model then takes the data from each patient and generates a score, which can be used to differentiate melanoma and nevi (see Figure 8). This current dataset was then used to generate a ROC curve (see Figure 9), which had an AUC of ~ 0.96 .

Example 6

[00226] In this example we determined a diagnostic model for differentiating between malignant melanoma and non-malignant nevi and then further refined the diagnostic model.

Methods

[00227] Patient samples were acquired and prepared as described above in Example 5. Likewise, RNA extraction, preparation, and quantification of gene expression were also carried out in the same fashion as described above in Example 5. The same list of potential signature genes and the same housekeeper genes were assayed as in Example 5 (Table 11). Like Example 5, the measured expression of each gene was averaged and normalized by the averaged expression of all seven housekeeper genes. Each gene was analyzed to determine if its expression could differentiate between malignant melanoma samples and benign nevi samples. Genes that were effective at

differentiating between malignant melanoma samples and benign nevi samples were further analyzed to determine which genes had correlating data. Correlating data indicated that the genes measured the same biological pathway. Genes with correlating data were grouped together in sets, with the average expression of the set used to differentiate melanoma and nevi.

Results

Building the diagnostic model

[00228] As described in Example 5, each gene was analyzed to determine if its expression was effective in differentiating the malignant melanoma samples from the benign nevi samples. In this analysis, we used forward selection to choose predictors for inclusion in a diagnostic model that would differentiate melanoma and nevi samples. As in Example 5, we selected PRAME, S100A9, and an immune component score as the predictors to differentiate the malignant melanoma samples from the benign nevi samples. The immune component score was made up of eight immune genes (CXCL9, CCL5, CXCL10, IRF1, PTPN22, PTPRC, LCP2, AND CD38) that all had highly correlated data (Figure 6). These eight immune genes were grouped and their values averaged to create an immune component score. As in Example 5, we also determined that these three predictors (PRAME, S100A9, or the immune component) had expression patterns only moderately correlated with each other (Figure 7), indicating that each predictor largely provides independent information when distinguishing melanoma and nevi samples.

[00229] We next created a combined diagnostic model using PRAME, S100A9, and the immune component score. The combined diagnostic model that we created was a linear model based on the gene expression data from the three predictors (PRAME, S100A9 and the immune component). In generating the linear model, we used generalized logistic regression to calculate the best weightings for each of the three predictors that would most effectively differentiate the melanoma and nevi samples in this dataset. The calculated best weightings were as follows: 1.149 for PRAME, 0.922 for S100A9, and 0.698 for the immune component score. Using these best weightings, the gene expression data for the three predictors was then used to generate a score that could be used to help differentiate between benign nevi samples and melanoma

samples. The gene expression data for each predictor was multiplied by the respective best weighting and then the three weighted values were combined. This combined value, as shown here, represented a score that could be used to help differentiate between benign nevi samples and melanoma samples:

$$\text{Score} = (1.149 \times \text{PRAME}) + (0.922 \times \text{S100A9}) + (0.698 \times \text{Immune component})$$

[00230] We then generated and plotted scores for all 544 samples (Figure 10). In the plotted scores we observed a bi-modal distribution. Nearly all samples with a score greater than zero were melanoma (dark gray bars), while nearly all nevi samples (light gray bars) had a score less than zero. Using this data, a ROC curve was generated that had an AUC of ~ 0.95 and an associated p-value of 2.0×10^{-63} (Figure 11). From this ROC curve we selected a cutoff point to differentiate between melanoma samples and nevi samples. In selecting the cutoff point we sought to maximize the sensitivity of the model, while maintaining the highest possible specificity. We selected a cutoff point with a sensitivity of 0.89 and a specificity of 0.93. We then adjusted the calculation of the score so that the selected cutoff point would be at a value of zero. Thus the adjusted score calculation was:

$$\text{Adjusted score} = (1.149 \times \text{PRAME}) + (0.922 \times \text{S100A9}) + (0.698 \times \text{Immune component}) - 0.334$$

Refining the diagnostic model

[00231] To improve the robustness and precision of the assay, we wanted to determine additional measurements for the PRAME and S100A9 predictors. We tested additional amplicons corresponding to PRAME and S100A9. We sought to determine if any other amplicons produced a reliable and correlated signal for these genes. We tested four additional PRAME amplicons.

[00232] We also tested amplicons that corresponded to six other genes that we determined would have expression that was highly correlated to S100A9: S100A7, S100A8, S100A10, S100A12, S100A14 and PI3.

[00233] We determined that one PRAME amplicon had low failure rates and had values highly correlated with the PRAME amplicon previously used in the model. We

averaged its measurement with the other PRAME measurement to provide a PRAME component.

[00234] We chose four other potential genes which produced data with low failure rates and were highly correlated with the S100A9 amplicon selected in the training set. These four genes, S100A7, S100A8, S100A12, and PI3 were averaged with S100A9 to yield a single S100-related component, or S100 score.

[00235] Thus, we were able to create a refined signature for the three predictors, PRAME, S100-related component, and the immune component. The refined signature included additional measurements for the PRAME and S100-related predictors determined above. The refined signature included a total of 15 amplicons that measured 14 signature genes comprising two measurements of the PRAME gene, one measurement each of S100 related genes S100A9, S100A7, S100A8, S100A12, and PI3, and measurements of eight highly correlated immune genes (CXCL9, CCL5, CXCL10, IRF1, PTPN22, PTPRC, LCP2, AND CD38)(Table 12). Along with these 15 signature amplicons, we also included amplicons corresponding to nine different housekeeper genes for normalization, for a total of 24 amplicons in our refined signature (Table 12).

Table 12- Signature and housekeeper genes comprising the refined signature.

Gene	Amplicons	Component
PRAME	2	PRAME
S100A7	1	S100-related
S100A8	1	
S100A9	1	
S100A12	1	
PI3	1	
CCL5	1	Immune
CD38	1	
CXCL10	1	
CXCL9	1	
IRF1	1	
LCP2	1	
PTPRC	1	
SELL	1	
CLTC	1	Housekeeper
MRFAP1	1	
PPP2CA	1	
PSMA1	1	
RPL13A	1	
RPL8	1	
RPS29	1	
SLC25A3	1	
TXNL1	1	

[00236] Lastly, we performed a concordance study to verify that the changes to the multiplex PCR reaction would not alter the data generated from the 10 signature amplicons retained from the initial signature. The qPCR assay relies on the fact that all the measured genes are pre-amplified in a single multiplex PCR reaction. Since the refined signature differed from the initial signature, it was important to ascertain that the different amplicon set of the refined signature did not alter the multiplex PCR reaction and consequently alter the data generated from the 10 amplicons retained from the initial signature set. Therefore, we retested RNA expression in 74 RNA samples from the initial training set using the refined signature. The scores of the retested RNA samples demonstrated an extremely high correlation (correlation coefficient of 0.99) when compared to the scores generated from the training set. Thus, the refined signature did not alter the data generated from any of the amplicons of the refined

signature. Accordingly, the refined signature produced a refined, adjusted score calculation of:

$$\text{Refined, adjusted score} = (1.223 \times \text{PRAME component}) + (1.023 \times \text{S100 component}) + (0.704 \times \text{Immune component}) + 0.267$$

Example 7

[00237] In this example we clinically validated a diagnostic model for differentiating between malignant melanoma and non-malignant nevi.

Methods

[00238] A validation cohort was generated by acquiring more than 400 skin lesions from four separate sites: Cleveland Clinic, Moffit Cancer Center, Northwestern University and the University of Utah (Table 13).

Table 13 - Sources of samples for the clinical validation cohort.

Institution	Diagnosis		Total
	<i>Benign</i>	<i>Malignant</i>	
Cleveland Clinic	62	65	127
Moffit Cancer Center	80	57	137
Northwestern University	26	46	72
University of Utah	58	43	101
Total	226	211	437

Only samples that produced analyzable results were included.

[00239] Each site provided both malignant and benign samples, with all major histological subtypes represented. The diagnosis for each case was confirmed, using a second dermatopathologist who was blinded to the diagnosis of the first dermatopathologist. If there was discordance in the diagnoses, a third dermatopathologist adjudicated the diagnosis. The melanoma subtypes included superficial spreading melanoma, nodular melanoma, lentigo maligna melanoma, desmoplastic melanoma, and subtypes classified as a not otherwise specified (Table 14).

Table 14 - Clinical information for melanoma samples used in the clinical validation.

	SSM	Nod	Acral	LMM	Desm	NOS	Overall
Total Number	105	38	9	31	5	23	211

SSM = Superficial Spreading Melanoma, Nod = Nodular melanoma, LMM = Lentigo Maligna Melanoma, Desm = Desmoplastic, NOS = Not Otherwise Specified subtype

Only samples that produced analyzable results were included.

[00240] The nevi subtypes included blue nevi, compound nevi, junctional nevi, dermal nevi, deep penetrating nevi, dysplastic nevi, and subtypes classified as a not otherwise specified (Table 15).

Table 15 - Clinical information for nevi samples used in the clinical validation.

	<i>Blue</i>	<i>Comp</i>	<i>Junc</i>	<i>Spitz</i>	<i>Derm</i>	<i>Deep Pen</i>	<i>NOS</i>	<i>Overall</i>	<i>Dyspl*</i>
Total Number	22	101	20	7	41	7	28	226	70

Comp = Compound, Junc = Junctional, Derm = Dermal, Deep Pen = Deep Penetrating, NOS = Not Otherwise Specified subtype, Dyspl = Dysplastic.

*Dysplastic nevi were scored as an attribute of a subtype, not as a specific subtype.

[00241] The patient samples were prepared as described above in Example 5. RNA extraction, RNA preparation, and quantification of gene expression were also carried out as described above in Example 5. The same list of potential signature genes and the same housekeeper genes were assayed as in Example 5 (Table 11). Likewise, as in Example 5, the measured expression of each gene was averaged and normalized by the averaged expression of all seven housekeeper genes. Then, a refined, adjusted score was generated for each patient sample using the refined, adjusted score calculation of:

$$\text{Refined, adjusted score} = (1.223 \times \text{PRAME component}) + (1.023 \times \text{S100 component}) + (0.704 \times \text{Immune component}) + 0.267$$

Results

[00242] The refined, adjusted scores were plotted for each patient sample (Figure 12). The plotted refined, adjusted scores resulted in a bimodal distribution similar to that seen in Figure 10 of Example 6. Nearly all melanoma samples had scores

greater than zero (Figure 12, upper panel) and nearly all nevi samples had scores less than zero (Figure 12, lower panel). This data was then used to generate a validation ROC curve that had an AUC of ~ 0.96 with a sensitivity of 0.9 and a specificity of 0.91 (Figure 13). The p-value associated with the validation ROC curve was 3.7×10^{-63} . The validation ROC curve was then compared to the ROC curve generated in Example 6 (Figure 11) to determine if the diagnostic model had been validated. The validation ROC curve had an AUC of ~ 0.96 , a sensitivity of 0.9, and a specificity of 0.91 compared to the ROC curve of Example 6 which had an AUC of ~ 0.95 , a sensitivity of 0.89, and a specificity of 0.93. The close agreement of the validation ROC curve and the ROC curve of Example 6 indicated that the validation cohort validated the diagnostic model of Example 6.

[00243] Next, the performance of the diagnostic model was analyzed within individual histological subtypes for those subtypes with 30 or more samples (Table 16).

Table 16 - Assay performance within individual subtypes in the clinical validation.

<i>Subtype</i>	<i>Correct call</i>	<i>Incorrect call</i>	<i>Sensitivity</i>	<i>Specificity</i>
Compound Nevus	95	6		94%
Dermal Nevus	40	1		98%
<i>All Nevi</i>	206	20		91%
Superficial Spread Melanoma	90	15	86%	
Nodular Melanoma	37	1	97%	
Lentigo Maligna Melanoma	28	3	90%	
<i>All Melanomas</i>	189	22	90%	

Only subtypes groups with ≥ 30 samples were reported.

[00244] There were two benign subtypes, compound and dermal, with more than 30 samples. The scoring of compound and dermal subtypes resulted in specificities of 94% and 98%, respectively, with an overall specificity of 91% for all nevi. There were three malignant subtypes, superficial spreading melanoma, nodular melanoma, and lentigo maligna melanoma with more than 30 samples. The scoring of superficial spreading melanoma, nodular melanoma, and lentigo maligna melanoma resulted in sensitivities of 86%, 97%, and 90%, respectively, with an overall sensitivity of 90% for all melanomas.

Example 8

[00245] In this example we developed a different approach to interpreting the diagnostic score by designating an indeterminate zone. Samples with scores falling between -2.0 and -0.1 were classified as indeterminate and are neither consistent with benign nevus nor consistent with malignant melanoma. Samples with scores between -16.7 and -2.1 were classified as consistent with benign nevus. Samples with scores between 0 and 11.1 were classified as consistent with malignant melanoma.

[00246] The refined, adjusted scores were plotted for each patient sample (Figure 14). The scoring of samples as either consistent with benign nevus, indeterminate, or consistent with malignant melanoma resulted in a sensitivity of 94% and a specificity of 90% after indeterminate samples were removed from analysis. 9% of samples scored as indeterminate (5% of the total melanomas and 13% of the total nevi samples tested) (Figure 14).

[00247] The Cancer Genome Atlas (TCGA) collected SNP array data on 384 melanoma tumors. Three-hundred-fifty-six were of sufficient quality for analysis. Allelic imbalance status was calculated for each SNP across the whole genome excluding the sex chromosomes. Figure 15 shows the percent of melanoma samples in the TCGA cohort with allelic imbalance for each chromosomal position. Eighty-two percent of samples had allelic imbalance of CDKN2A alone. The genes or regions in Table 17 had allelic imbalance in at least 50% of the samples:

Table 17 – Genes or Regions with Allelic Imbalance in at Least 50% of Samples

<i>Region</i>	<i>Chromosome</i>	<i>Start Position</i>	<i>End Position</i>
Tel1q	1	171656124	END
Near Tel5q	5	137789519	158830819
6q	6	65332657	END
Around CDKN2A	9	START	END
10q	10	START	END
Tel11q	11	82562486	END

[00248] These 6 regions were then evaluated as a group. Allelic imbalance of any of the 6 regions identified 350 of the 356 melanomas. As a result, the expected sensitivity of this panel is 98%.

[00249] RNAseq data was also collected on 382 patients' lesions. We approximated the refined, adjusted score computed according to the equation in example 7 using the RNAseq data. Seventeen of the 382 samples with RNAseq data (4.4%) have scores less than 0. Of the 354 samples that had both RNAseq expression and SNP data available, 13 have scores less than 0. Of these, only 1 did not have allelic imbalance by the 6-region panel. Thus, the expected sensitivity of the combination of the allelic imbalance panel and the refined, adjusted score is greater than 99%.

[00250] All publications and patent applications mentioned in the specification are indicative of the level of those skilled in the art to which this invention pertains. All publications and patent applications are herein incorporated by reference to the same extent as if each individual publication or patent application was specifically and individually indicated to be incorporated by reference. The mere mentioning of the publications and patent applications does not necessarily constitute an admission that they are prior art to the instant application.

[00251] Although the foregoing invention has been described in some detail by way of illustration and example for purposes of clarity of understanding, it will be obvious that certain changes and modifications may be practiced within the scope of the appended claims. The following embodiments further describe and define the inventions disclosed herein.

Embodiment 1. A method of diagnosing melanoma in a patient comprising:

- a) obtaining a sample from a patient suspected of suffering from melanoma;
- b) measuring in said sample, the expression of one or more genes selected from the genes listed in table 1;
- c) comparing the measured expression levels of the one or more genes selected from table 1 to the expression levels of the same one or more genes measured in a sample from an individual not suffering from melanoma; and
- d) detecting a difference in the expression levels of the one or more genes selected from table 1 in the patient suspected of suffering from melanoma.

Embodiment 2. A method of diagnosing melanoma in a patient comprising:

- a) obtaining a sample from a patient suspected of suffering from melanoma;

- b) measuring the expression of one or more genes selected from the genes listed in table 3;
- c) comparing the measured expression levels of the one or more genes selected from table 3 to the expression levels of the same one or more genes measured in a sample from an individual not suffering from melanoma; and
- d) detecting a difference in the expression levels of the one or more genes selected from table 3 in the patient suspected of suffering from melanoma.

Embodiment 3. A method of diagnosing melanoma in a patient comprising:

- a) obtaining a sample from a patient suspected of suffering from melanoma;
- b) measuring the expression of one or more genes selected from the genes listed in tables 1 and 3;
- c) comparing the measured expression levels of the one or more genes selected from tables 1 and 3 to the expression levels of the same one or more genes measured in a sample from an individual not suffering from melanoma; and
- d) detecting a difference in the expression levels of the one or more genes selected from tables 1 and 3 in the patient suspected of suffering from melanoma.

Embodiment 4. A method of diagnosing melanoma in a patient comprising:

- a) obtaining a sample from a patient suspected of suffering from melanoma;
- b) measuring the expression of one or more genes selected from the genes listed in table 1; and
- c) comparing the measured expression levels of the one or more genes selected from table 1 to a reference value,

wherein a diagnosis of melanoma is made if the measured gene expression differs from the reference value.

Embodiment 5. A method of diagnosing melanoma in a patient comprising:

- a) obtaining a sample from a patient suspected of suffering from melanoma;
- b) measuring the expression of one or more genes selected from the genes listed in table 3; and
- c) comparing the measured expression levels of the one or more genes selected from table 3 to a reference value,

wherein a diagnosis of melanoma is made if the measured gene expression differs from the reference value.

Embodiment 6. A method of diagnosing melanoma in a patient comprising:

- a) obtaining a sample from a patient suspected of suffering from melanoma;
- b) measuring the expression of one or more genes selected from the genes listed in tables 1 and 3; and

c) comparing the measured expression levels of the one or more genes selected from tables 1 and 3 to a reference value,
wherein a diagnosis of melanoma is made if the measured gene expression differs from the reference value.

Embodiment 7. A method of detecting a melanoma in a patient comprising:

- a) obtaining a sample from a patient;
- b) measuring the expression of one or more genes selected from the genes listed in table 1; and
- c) comparing the measured expression levels of the one or more genes to the expression levels of the same genes in one or more samples taken from one or more individuals without melanoma,

wherein melanoma is detected if the measured gene expression level in the sample taken from the patient differs from the gene expression level measured in the sample taken from the one or more individuals without melanoma.

Embodiment 8. A method of detecting a melanoma in a patient comprising:

- a) obtaining a sample from a patient;
- b) measuring the expression of one or more genes selected from the genes listed in table 3; and
- c) comparing the measured expression levels of the one or more genes to the expression levels of the same genes in one or more samples taken from one or more individuals without melanoma,

wherein melanoma is detected if the measured gene expression level in the sample taken from the patient differs from the gene expression level measured in the sample taken from the one or more individuals without melanoma.

Embodiment 9. A method of detecting melanoma in a patient comprising:

- a) obtaining a sample from a patient;
- b) measuring the expression of one or more genes selected from the genes listed in tables 1 and 3; and
- c) comparing the measured expression levels of the one or more genes to the expression levels of the same genes in one or more samples taken from one or more individuals without melanoma,

wherein melanoma is detected if the measured gene expression level in the sample taken from the patient differs from the gene expression level measured in the sample taken from the one or more individuals without melanoma.

Embodiment 10. A method of treating melanoma comprising:

- a) obtaining a sample from a patient suspected of having melanoma;
- b) measuring the expression of one or more genes selected from the genes listed in table 1;
- c) determining a difference between the expression of the one or more genes in the sample and the expression of the one or more genes in one or more reference samples; and
- d) altering the treatment of the patient based on the difference.

Embodiment 11. A method of treating melanoma comprising:

- a) obtaining a sample from a patient suspected of having melanoma;
- b) measuring the expression of one or more genes selected from the genes listed in tables 3;
- c) determining a difference between the expression of the one or more genes in the sample and the expression of the one or more genes in one or more reference samples; and
- d) altering the treatment of the patient based on the difference.

Embodiment 12. A method of treating melanoma comprising:

- a) obtaining a sample from a patient suspected of having melanoma;
- b) measuring the expression of one or more genes selected from the genes listed in tables 1 and 3;
- c) determining a difference between the expression of the one or more genes in the sample and the expression of the one or more genes in one or more reference samples; and
- d) altering the treatment of the patient based on the difference.

Embodiment 13. A method of screening patients for melanoma comprising:

- a) obtaining a sample from a patient;
- b) measuring the expression of one or more genes selected from the genes listed in table 1;
- c) comparing the measured expression of the one or more genes to the expression of the same genes in a reference sample; and
- d) classifying the patient as having a malignant melanoma, benign nevi or a dysplastic nevi.

Embodiment 14. A method of screening patients for melanoma comprising:

- a) obtaining a sample from a patient;
- b) measuring the expression of one or more genes selected from the genes listed in table 3;

- c) comparing the measured expression of the one or more genes to the expression of the same genes in a reference sample; and
- d) classifying the patient as having a malignant melanoma, benign nevi or a dysplastic nevi.

Embodiment 15. A method of screening patients for melanoma comprising:

- a) obtaining a sample from a patient;
- b) measuring the expression of one or more genes selected from the genes listed in tables 1 and 3;
- c) comparing the measured expression of the one or more genes to the expression of the same genes in a reference sample; and
- d) classifying the patient as having a malignant melanoma, benign nevi or a dysplastic nevi.

Embodiment 16. A method of detecting abnormal levels of gene expression in a skin lesion comprising:

- a) obtaining a skin lesion sample from a patient;
- b) measuring in said skin lesion the expression of one or more genes selected from the genes listed in table 1; and
- c) comparing the measured expression of the at least one more genes to the expression levels of the same genes in a nevus sample taken from one or more individuals without melanoma.

Embodiment 17. A method of detecting abnormal levels of gene expression in a skin lesion comprising:

- a) obtaining a skin lesion sample from a patient;
- b) measuring in said skin lesion the expression of one or more genes selected from the genes listed in table 3; and
- c) comparing the measured expression of the at least one more genes to the expression levels of the same genes in a nevus sample taken from one or more individuals without melanoma.

Embodiment 18. A method of detecting abnormal levels of gene expression in a skin lesion comprising:

- a) obtaining a skin lesion sample from a patient;
- b) measuring in said skin lesion the expression of one or more genes selected from the genes listed in tables 1 and 3; and
- c) comparing the measured expression of the at least one more genes to the expression levels of the same genes in a nevus sample taken from one or more individuals without melanoma.

- Embodiment 19. The method of embodiments 1-18 wherein the expression level of the one or more genes is measured by detecting RNA in said samples.
- Embodiment 20. The method of embodiments 1-19 wherein the expression level of the one or more genes is measured by PCR.
- Embodiment 21. The method of embodiments 1-20 wherein the expression level of the one or more genes is measured by qPCR.
- Embodiment 22. The method of embodiments 1-21 wherein the expression level of the one or more genes is determined by normalizing the expression to one or more housekeeping genes.
- Embodiment 23. The method of embodiment 22 wherein said housekeeping genes comprise at least one of MRFAP1, PSMA1, RPL13A, TXNL1, SLC25A3, RPS29, RPL8, PSMC1, and RPL4.
- Embodiment 24. The method of embodiments 1-23 wherein the expression level of the one or more genes is measured by hybridization.
- Embodiment 25. The method of embodiments 1-24 wherein the sample is a skin lesion.
- Embodiment 26. The method of embodiments 1-25 wherein the sample is a malignant melanoma.
- Embodiment 27. The method of embodiments 1-26 where in the sample is a benign nevus.
- Embodiment 28. The method of embodiments 1-27 wherein the sample is a dysplastic nevus.
- Embodiment 29. The method of embodiments 1-28 wherein the one or more genes comprise any two gene panel selected from Table XX.
- Embodiment 30. The method of embodiments 1-29 wherein the one or more genes comprise any three gene panel selected from Table YY.
- Embodiment 31. The method of embodiments 1-30 wherein the one or more genes comprise any four gene panel selected from Table ZZ.

Embodiment 32. The method of embodiment 1, 3-4, 6-7, 9-10, 12-13, 15-16, or 18-31, wherein the one or more genes comprise any gene panel selected from Table WW.

Embodiment 33. The method of embodiment 1-28, wherein the one or more genes comprise at least one cell cycle gene, at least one immune gene, and at least one additional gene.

Embodiment 34. The method of embodiment 1-28, wherein the one or more genes comprise at least one immune gene, and at least one additional gene.

Embodiment 35. The method of embodiment 34, wherein the at least one immune gene comprises Panel F, and the at least one additional gene comprises PRAME and S100A9.

Embodiment 36. A method of diagnosing and/or treating melanoma in a patient comprising:

- a) obtaining a sample of a patient;
- b) measuring an expression level of PRAME in the sample of the patient;
- c) comparing the expression level of PRAME in the sample of the patient to an expression level of PRAME measured in a sample of an individual not suffering from melanoma; and
- d) detecting a difference in the expression level of PRAME in the patient,

wherein a difference in the expression level of PRAME in the patient indicates a diagnosis of melanoma in the patient.

Embodiment 37. A method of diagnosing and/or treating melanoma in a patient comprising:

- a) obtaining a sample of a patient;
- b) measuring an expression level of S100A9 in the sample of the patient;
- c) comparing the expression level of S100A9 in the sample of the patient to an expression level of S100A9 measured in a sample of an individual not suffering from melanoma; and
- d) detecting a difference in the expression level of S100A9 in the patient,

wherein a difference in the expression level of S100A9 in the patient indicates a diagnosis of melanoma in the patient.

Embodiment 38. A method of diagnosing and/or treating melanoma in a patient comprising:

- a) obtaining a sample of a patient;
- b) measuring expression levels of a panel of immune genes in the sample of the patient, wherein the panel of immune genes comprises CCL5, CD38, CXCL10, CXCL9, IRF1, LCP2, PTPN22, PTPRC, or combinations thereof;
- c) comparing the expression levels of the panel of immune genes in the sample of the patient to expression levels of the panel of immune genes measured in a sample of an individual not suffering from melanoma; and
- d) detecting a difference in the expression levels of the panel of immune genes in the patient,

wherein a difference in the expression levels of the panel of immune genes in the patient indicates a diagnosis of melanoma in the patient.

Embodiment 39. A method of diagnosing and/or treating melanoma in a patient comprising:

- a) obtaining a sample of a patient;
- b) measuring expression levels of a panel of genes in the sample of the patient, wherein the panel of genes comprises PRAME, S100A9, S100A7, S100A8, S100A12, S100A10, S100A14, PI3, CCL5, CD38, CXCL10, CXCL9, IRF1, LCP2, PTPN22, or PTPRC, or combinations thereof;
- c) comparing the expression levels of the panel of genes in the sample of the patient to expression levels of the panel of genes measured in a sample of an individual not suffering from melanoma; and
- d) detecting a difference in the expression levels of the panel genes in the patient,

wherein a difference in the expression levels of the panel of genes in the patient indicates a diagnosis of melanoma in the patient.

Embodiment 40. A method of diagnosing and/or treating melanoma in a patient comprising:

- a) obtaining a sample of a patient;
- b) measuring expression levels of a panel of genes in the sample of the patient, wherein the panel of genes comprises S100A9, S100A7, S100A8, S100A12, S100A10, S100A14, or PI3, or combinations thereof;
- c) comparing the expression levels of the panel of genes in the sample of the patient to expression levels of the panel of genes measured in a sample of an individual not suffering from melanoma; and
- d) detecting a difference in the expression levels of the panel of genes in the patient,

wherein a difference in the expression levels of the panel of genes in the patient indicates a diagnosis of melanoma in the patient.

Embodiment 41. The method of embodiments 36 to 40 further comprising comparing the expression levels of the panel of genes by normalizing with a panel of housekeeper genes.

Embodiment 42. The method of embodiment 41 wherein the panel of housekeeper genes comprises CLTC, MRFAP1, PPP2CA, PSMA1, RPL13A, RPL8, RPS29, SLC25A3, or TXNL1, or combinations thereof.

Embodiment 43. The method of embodiments 36 to 42 wherein detecting a difference further comprises calculating a score based on the sum of the expression levels of each gene within the gene panel, wherein the score is indicative of a difference in expression levels of the panel of genes of the patient.

Embodiment 44. The method of embodiment 43 wherein calculating the score further comprises weighting the values of the expression levels of each gene with the gene panel.

Embodiment 45. The method of embodiment 44 wherein calculating the score further comprises substituting an individual expression level of a gene with an average expression level of a group of related genes.

Embodiment 46. The method of embodiment 1-3 wherein the detection of a difference in the expression levels is recorded in a report.

Embodiment 47. The method of embodiment 46 wherein the report is communicated to the patient's medical provider.

Embodiment 48. The method of embodiment 47 wherein the medical provider treats the patient based on the report.

Embodiment 49. The method of embodiment 3-6 wherein diagnosis of melanoma is recorded in a report.

Embodiment 50. The method of embodiment 49 wherein the report is communicated to the patient's medical provider.

Embodiment 51. The method of embodiment 50 wherein the medical provider treats the patient based on the report.

Embodiment 52. The method of embodiment 7-9 wherein the detection of melanoma is recorded in a report.

Embodiment 53. The method of embodiment 52 wherein the report is communicated to the patient's medical provider.

Embodiment 54. The method of embodiment 53 wherein the medical provider treats the patient based on the report.

Embodiment 55. The method of embodiment 13-15 wherein the classification of the patient as having a malignant melanoma is recorded in a report.

Embodiment 56. The method of embodiment 55 wherein the report is communicated to the patient's medical provider.

Embodiment 57. The method of embodiment 56 wherein the medical provider treats the patient based on the report.

Embodiment 58. The method of embodiment 16-35 wherein the comparison of the measured expression is recorded in a report.

Embodiment 59. The method of embodiment 58 wherein the report is communicated to the patient's medical provider.

Embodiment 60. The method of embodiment 59 wherein the medical provider treats the patient based on the report.

Embodiment 61. The method of embodiment 36-42 wherein the diagnosis of melanoma is recorded in a report.

Embodiment 62. The method of embodiment 61 wherein the report is communicated to the patient's medical provider.

Embodiment 63. The method of embodiment 62 wherein the medical provider treats the patient based on the report.

Embodiment 64. The method of embodiment 43-45 wherein the diagnosis of melanoma and/or the score is recorded in a report.

Embodiment 65. The method of embodiment 64 wherein the report is communicated to the patient's medical provider.

Embodiment 66. The method of embodiment 65 wherein the medical provider treats the patient based on the report.

Embodiment 67. A kit for detecting melanoma in a patient, the kit comprising reagents useful, sufficient, or necessary for determining the level of at least three biomarkers in any one of Tables 1 or 3, or Panels A through I, or any of the panels disclosed in Tables WW-ZZ.

Embodiment 68. The kit of embodiment 67 wherein the reagents comprise oligonucleotide probes specifically hybridizing under high stringency to mRNA or cDNA of at least three biomarkers in any one of Tables 1 or 3, or Panels A through I, or any of the panels disclosed in Tables WW-ZZ.

Embodiment 69. The kit of embodiment 68 wherein the oligonucleotide probes are labeled with a detection marker.

Embodiment 70. A system for diagnosing or treating melanoma in a patient comprising:

- a patient information database comprising patient information comprising gene expression levels of a panel of biomarkers;
- a biomarker information database comprising biomarker information comprising threshold level information for each biomarker of the panel of biomarkers; and

- a scoring module configured to compare biomarker information and patient information to generate a score representing the comparison between the biomarker information and the patient information, wherein the score is useful in diagnosing or treating melanoma.

Embodiment 71. The system of embodiment 70 wherein the scoring module is further configured to normalize, average, and apply weighting to subgroups of biomarkers during generation of the score.

Embodiment 72. The system of embodiment 71 wherein the scoring module is further configured to algebraically add and/or subtract subgroups of biomarkers during generation of the score.

Embodiment 73. The system of embodiment 70 further comprising an evaluation module configured to determine a probability of the presence of melanoma in the patient based on the patient score as compared to scores of groups of patients diagnosed with melanoma and scores of groups of patients that were not diagnosed with melanoma.

Embodiment 74. The system of embodiment 73 further comprising a medical history database module configured to be in communication with the evaluation module to further include a medical history of the patient in the determination of the probability of the presence of melanoma.

Embodiment 75. The system of embodiment 70 further comprising a diagnostic module configured to determine additional suggested diagnostic procedures based on a patient's probability of melanoma.

Embodiment 76. The system of embodiment 70 further comprising a report generation module configured to generate a report of the score.

Embodiment 77. The system of embodiment 76 wherein the report is transmitted to the patient and/or a medical provider.

Embodiment 78. The system of embodiment 70 further comprising a communication means to transmit the score to the patient and/or a medical provider.

Embodiment 79. The system of embodiment 70 further comprising a sample analyzer module configured to determine gene expression levels of the panel of biomarkers.

Embodiment 80. The system of embodiment 79 wherein the sample analyzer module communicates the gene expression levels to the patient information database.

Embodiment 81. A computer readable medium including contents that are configured to cause a computing system to sort data by performing a method comprising:

comparing gene expression levels of a panel of biomarkers in a patient with gene expression levels of a panel of biomarkers from either a control group diagnosed with melanoma or a control group not diagnosed with melanoma; and

generating a score representing the comparison between the gene expression levels of the patient and the gene expression levels in the control groups,

wherein the score is indicative of a diagnosis of melanoma.

Embodiment 82. The computer readable medium of embodiment 81 further configured to cause a computing system to sort data by performing a method comprising:

normalizing, averaging, and applying weighting to subgroups of biomarkers during generation of the score.

Embodiment 83. The computer readable medium of embodiment 82 further configured to cause a computing system to sort data by performing a method comprising:

algebraically adding and/or subtracting subgroups of biomarkers during generation of the score.

Embodiment 84. The computer readable medium of embodiment 81 further configured to cause a computing system to sort data by performing a method comprising:

determining a probability of the presence of melanoma in the patient based on comparing the score with scores of control groups

diagnosed with melanoma and scores of control groups not diagnosed with melanoma.

Embodiment 85. A method comprising:

animating execution of a code module configured to display a score representing a comparison between gene expression levels of a panel of biomarkers in a patient and gene expression levels in control groups with melanoma and in control groups without melanoma;
initiating execution of the code module; and
presenting a graphical visual depiction of the score.

Embodiment 86. The method of embodiment 85 wherein the score represents the probability that the patient has melanoma.

Embodiment 87. A method of diagnosing melanoma in an individual comprising:

- (1) assaying DNA from a tissue sample to determine the presence of allelic imbalance (AI) at one or more specified genomic locations; and
- (2) diagnosing the individual as suffering from melanoma.

Embodiment 88. The method of embodiment 87, wherein the tissue sample is a skin lesion.

Embodiment 89. The method of embodiment 87, wherein DNA is assayed by sequencing.

Embodiment 90. The method of embodiment 89, wherein AI is determined by comparing SNPs.

Embodiment 91. The method of embodiment 90, wherein SNPs are analyzed at six specified genomic locations.

Embodiment 92. The method of embodiment 90 wherein, the genomic locations for SNP analysis to determine AI are selected from those in Table 17.

Embodiment 93. A method of diagnosing melanoma in an individual comprising:

- (1) assaying DNA from a tissue sample to determine the presence of loss of heterozygosity (LOH) at one or more specified genomic locations; and
- (2) diagnosing the individual as suffering from melanoma.

Embodiment 94. The method of embodiment 93, wherein the tissue sample is a skin lesion.

Embodiment 95. The method of embodiment 93, wherein DNA is assayed by sequencing.

Embodiment 96. The method of embodiment 95, wherein LOH is determined by comparing SNPs.

Embodiment 97. The method of embodiment 96, wherein SNPs are analyzed at six specified genomic locations.

Embodiment 98. The method of embodiment 96 wherein, the genomic locations for SNP analysis to determine LOH are selected from those in Table 17.

Embodiment 99. A method of treating melanoma in an individual comprising:

- (1) assaying DNA from a tissue sample to determine the presence of allelic imbalance (AI) at one or more specified genomic locations; and
- (2) treating the individual as suffering from melanoma based at least in part on the presence of AI.

Embodiment 100. The method of embodiment 99, wherein the tissue sample is a skin lesion.

Embodiment 101. The method of embodiment 99, wherein DNA is assayed by sequencing.

Embodiment 102. The method of embodiment 101, wherein AI is determined by comparing SNPs.

Embodiment 103. The method of embodiment 102, wherein SNPs are analyzed at six specified genomic locations.

Embodiment 104. The method of embodiment 102 wherein, the genomic locations for SNP analysis to determine AI are selected from those in Table 17.

Embodiment 105. A method treating melanoma in a patient comprising:

- a) obtaining a sample of a patient;
- b) measuring expression levels of a panel of immune genes in the sample of the patient, wherein the panel of immune genes comprises any three genes from ;
- c) comparing the expression levels of the panel of immune genes in the sample of the patient to expression levels of the panel of immune genes measured in a sample of an individual not suffering from melanoma;
- d) assaying DNA from a tissue sample to determine the presence or absence of allelic imbalance (AI) at one or more specified genomic locations; and
- e) detecting a difference in the expression levels of the panel of immune genes in the patient and or detecting AI,

wherein a difference in the expression levels of the panel of immune genes in the patient or the presence of AI or both indicates a diagnosis of melanoma in the patient.

CLAIMS

What is claimed is:

1. A method of diagnosing melanoma in an individual comprising:
 - (1) assaying DNA from a tissue sample to determine the presence of allelic imbalance (AI) at one or more specified genomic locations; and
 - (2) diagnosing the individual as suffering from melanoma.
2. The method of embodiment 1, wherein the tissue sample is a skin lesion.
3. The method of embodiment 1, wherein DNA is assayed by sequencing.
4. The method of embodiment 3, wherein AI is determined by comparing SNPs.
5. The method of embodiment 4, wherein SNPs are analyzed at six specified genomic locations.
6. The method of embodiment 4 wherein, the genomic locations for SNP analysis to determine AI are selected from those in Table 17.
7. A method of diagnosing melanoma in an individual comprising:
 - (1) assaying DNA from a tissue sample to determine the presence of loss of heterozygosity (LOH) at one or more specified genomic locations; and
 - (2) diagnosing the individual as suffering from melanoma.
8. The method of embodiment 7, wherein the tissue sample is a skin lesion.
9. The method of embodiment 7, wherein DNA is assayed by sequencing.
10. The method of embodiment 9, wherein LOH is determined by comparing SNPs.
11. The method of embodiment 10, wherein SNPs are analyzed at six specified genomic locations.
12. The method of embodiment 10 wherein, the genomic locations for SNP analysis to determine LOH are selected from those in Table 17.

13. A method of treating melanoma in an individual comprising:
- (1) assaying DNA from a tissue sample to determine the presence of allelic imbalance (AI) at one or more specified genomic locations; and
 - (2) treating the individual as suffering from melanoma based at least in part on the presence of AI.
14. The method of embodiment 13, wherein the tissue sample is a skin lesion.
15. The method of embodiment 13, wherein DNA is assayed by sequencing.
16. The method of embodiment 15, wherein AI is determined by comparing SNPs.
17. The method of embodiment 16, wherein SNPs are analyzed at six specified genomic locations.
18. The method of embodiment 16 wherein, the genomic locations for SNP analysis to determine AI are selected from those in Table 17.
19. A method treating melanoma in a patient comprising:
- a) obtaining a sample of a patient;
 - b) measuring expression levels of a panel of immune genes in the sample of the patient, wherein the panel of immune genes comprises any three genes from ;
 - c) comparing the expression levels of the panel of immune genes in the sample of the patient to expression levels of the panel of immune genes measured in a sample of an individual not suffering from melanoma;
 - d) assaying DNA from a tissue sample to determine the presence or absence of allelic imbalance (AI) at one or more specified genomic locations; and
 - e) detecting a difference in the expression levels of the panel of immune genes in the patient and or detecting AI,

wherein a difference in the expression levels of the panel of immune genes in the patient or the presence of AI or both indicates a diagnosis of melanoma in the patient. A method of diagnosing melanoma in an individual comprising:

- (1) assaying DNA from a tissue sample to determine the presence of allelic imbalance (AI) at one or more specified genomic locations; and
- (2) diagnosing the individual as suffering from melanoma.

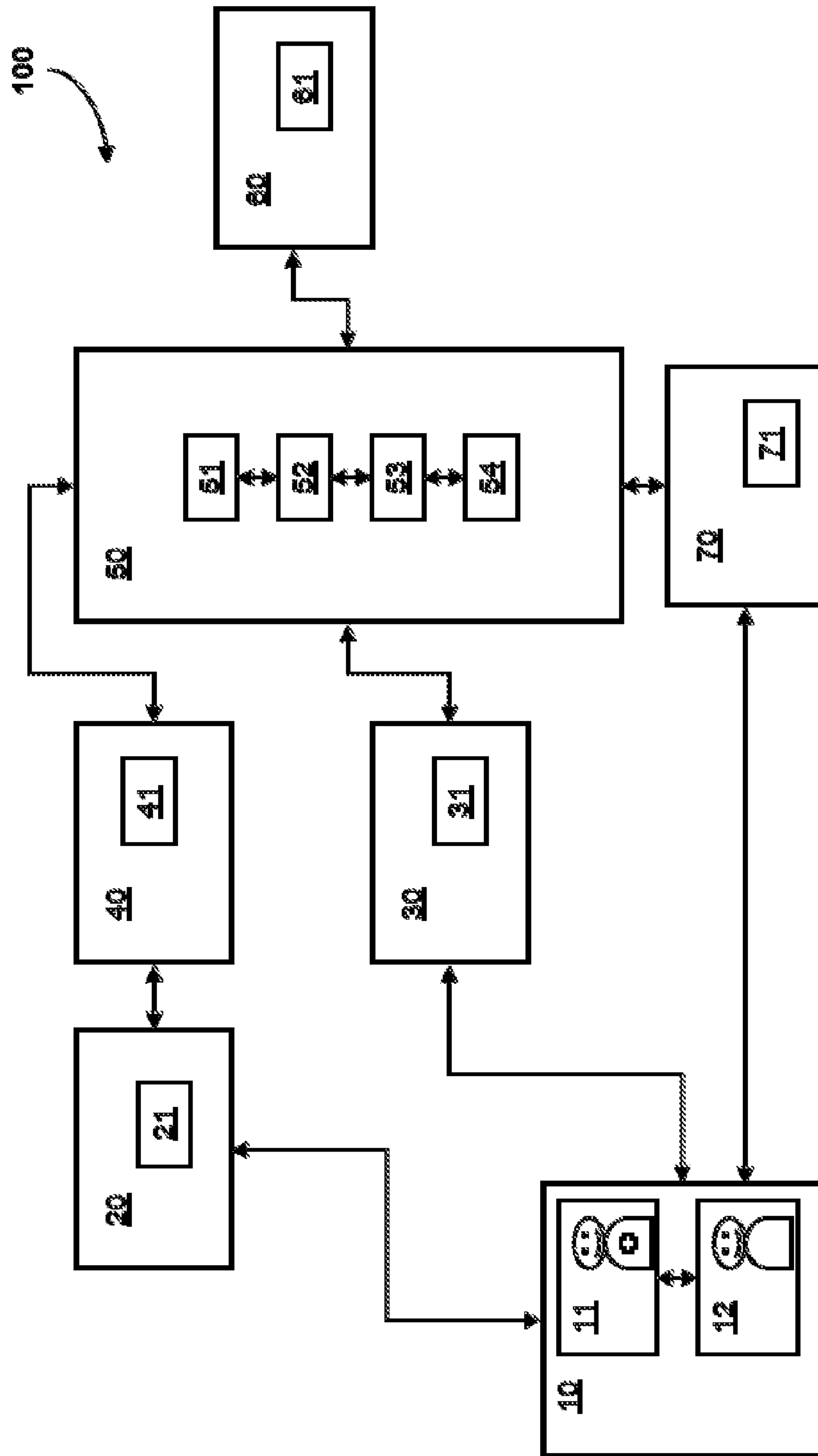
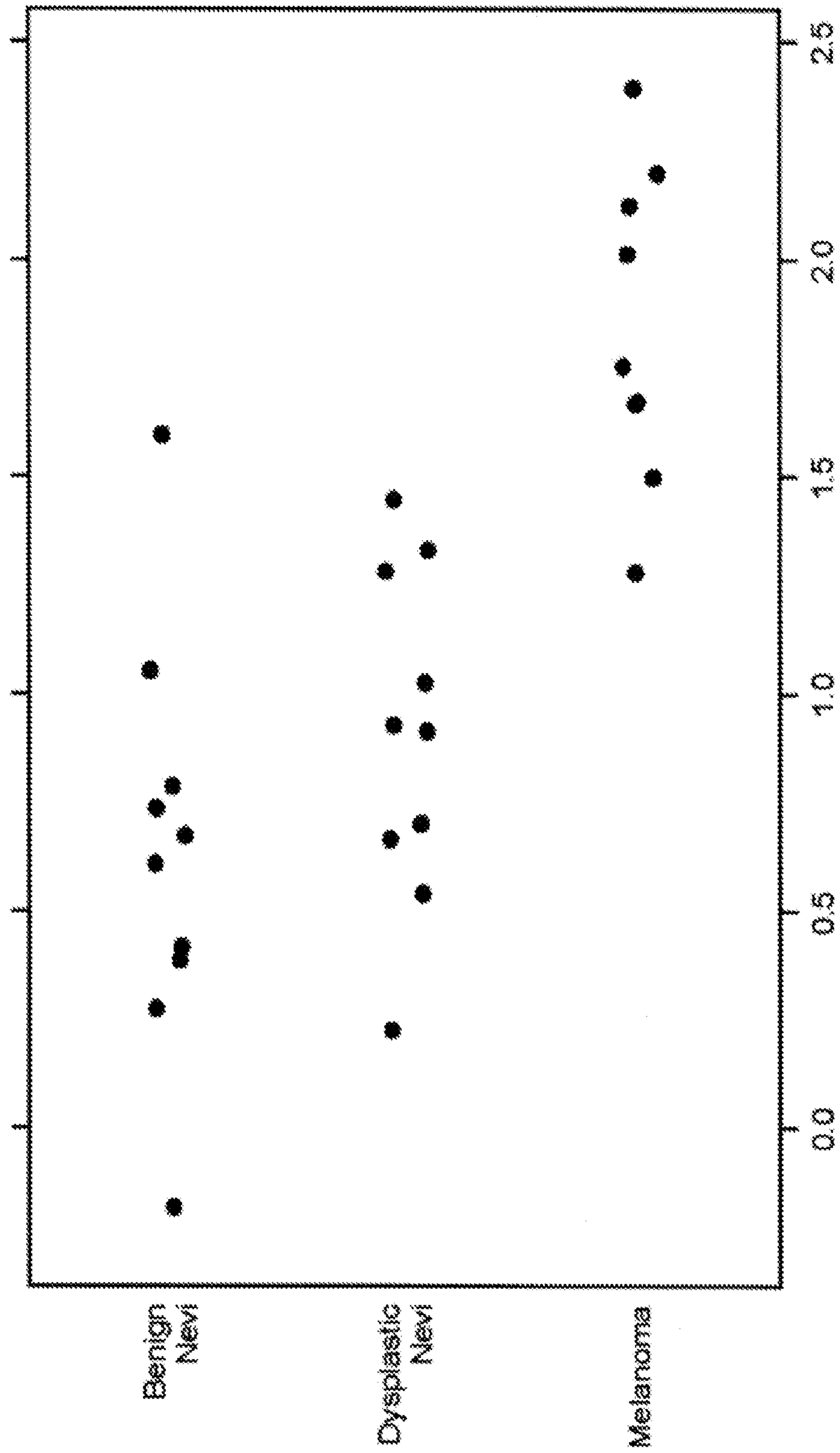
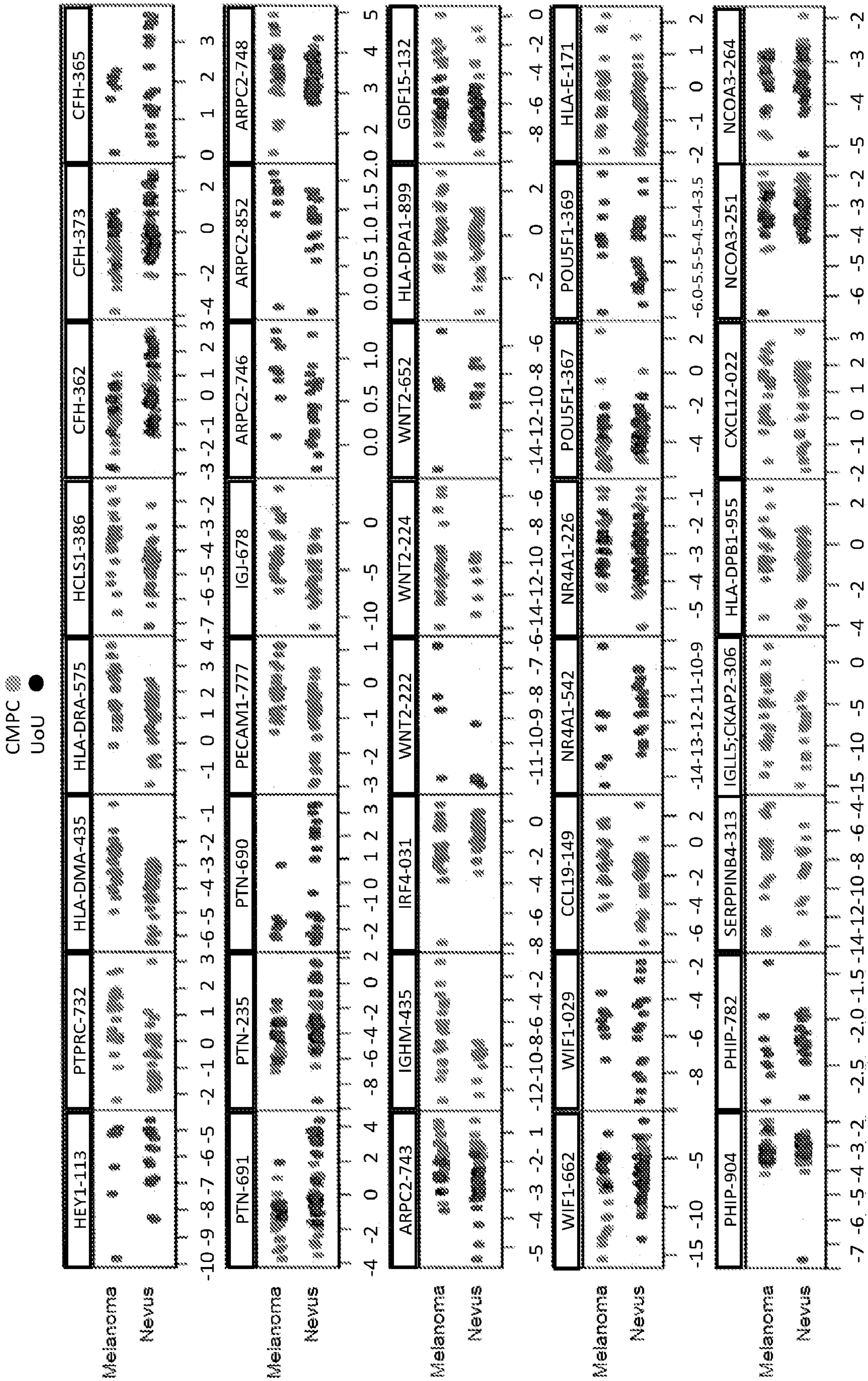

Figure 1



CCP Score
Figure 2



Expression (ΔCt)

Figure 3B

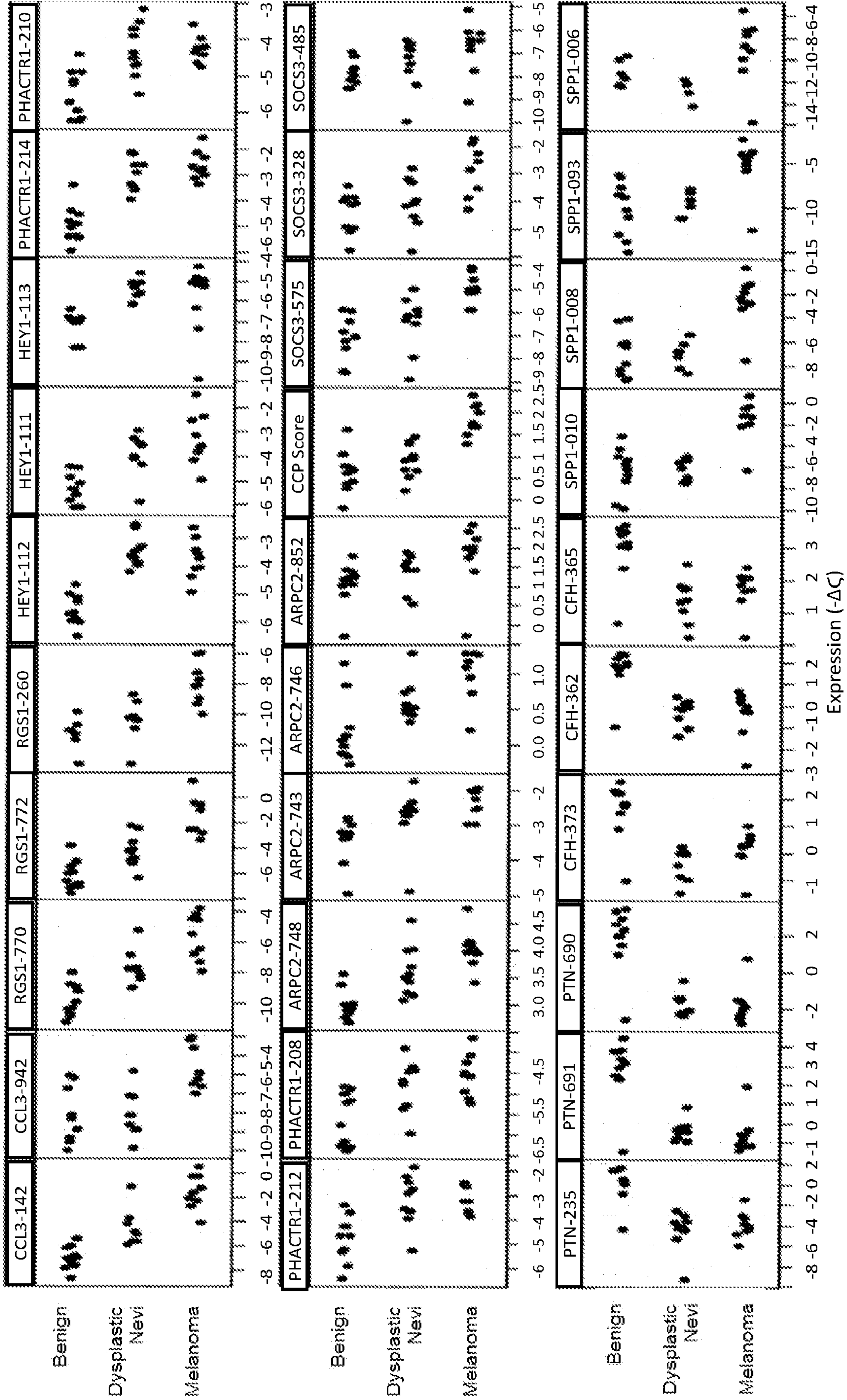
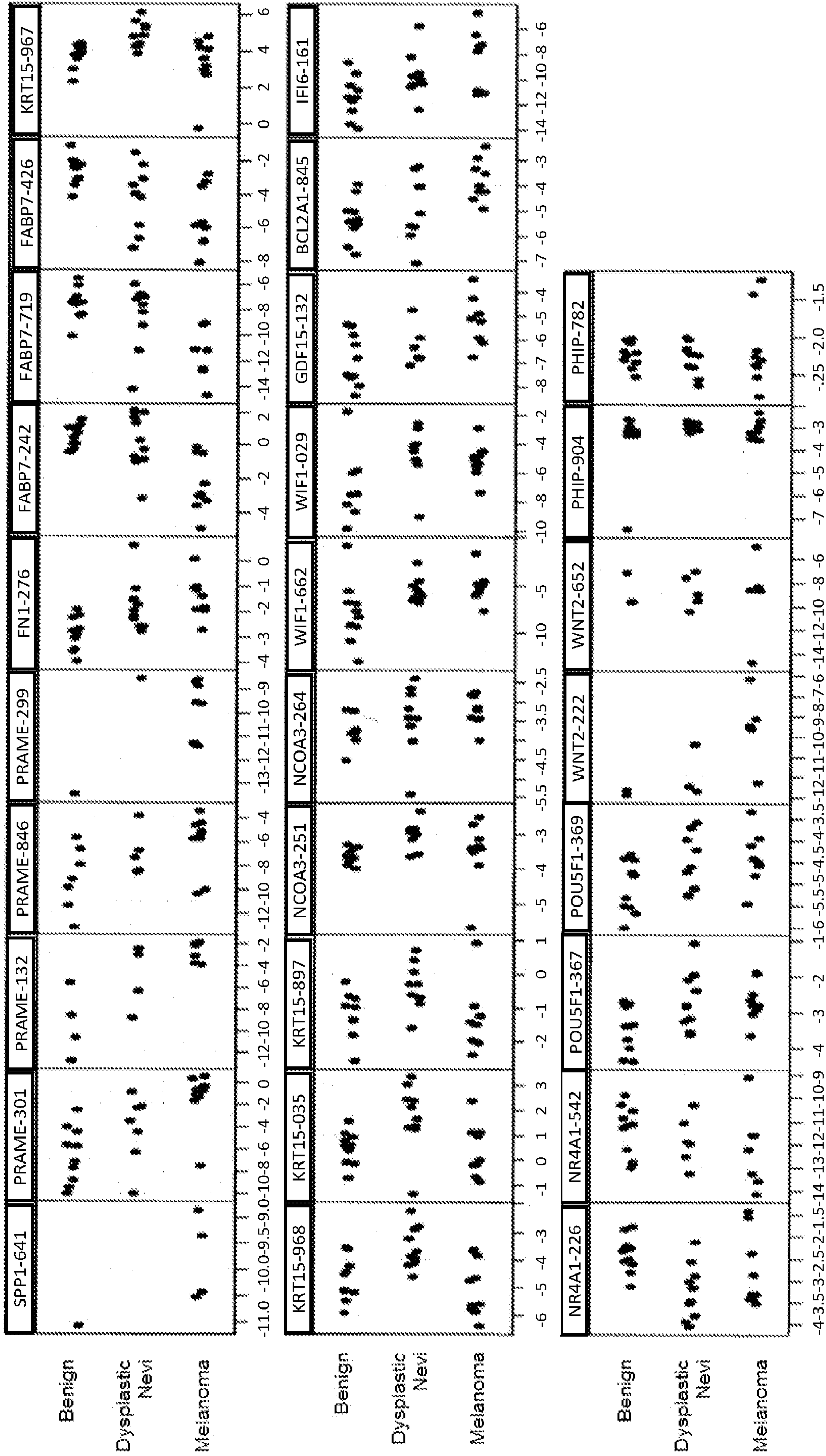
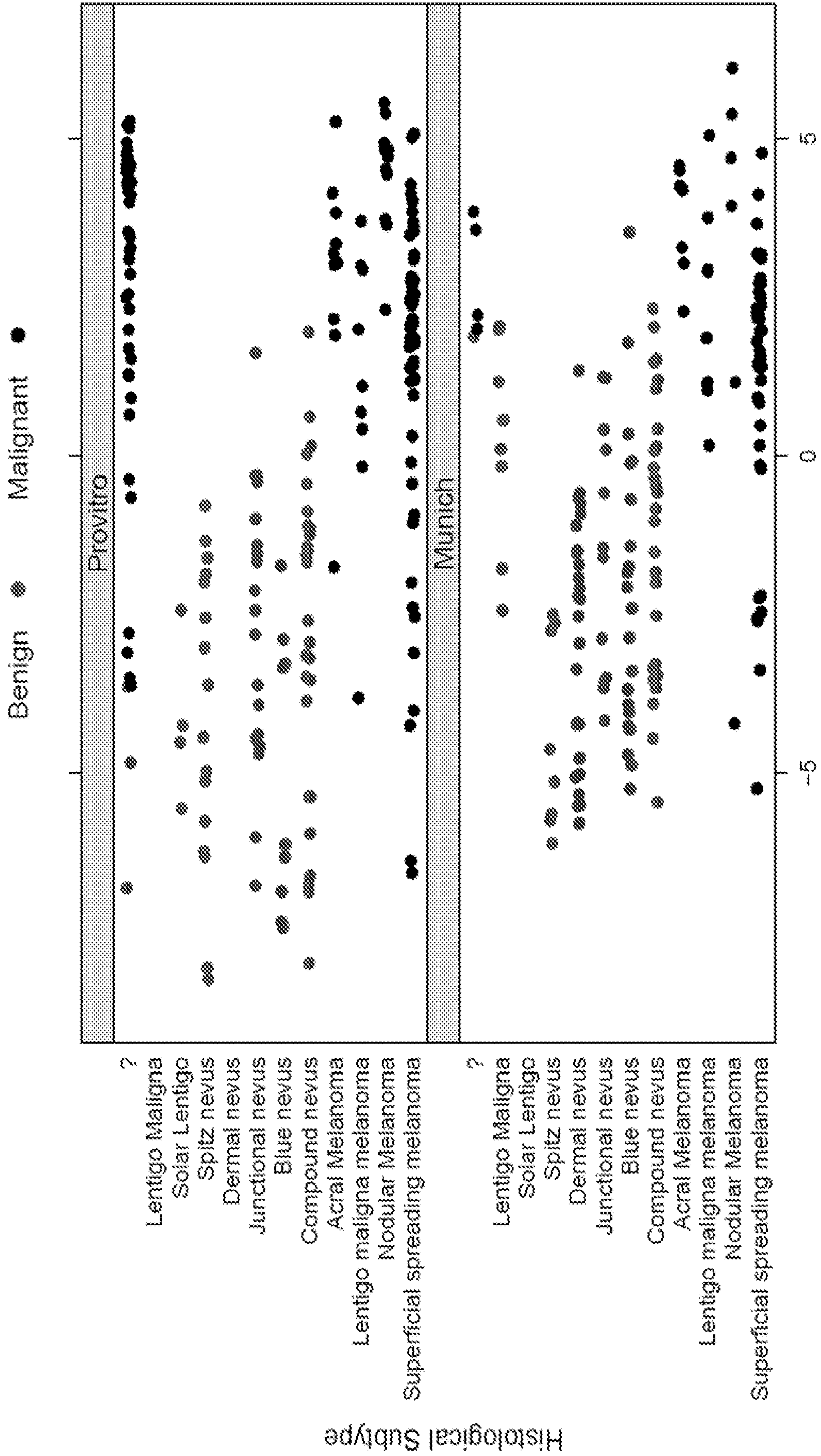

Figure 4A



Expression (-ΔCt)

Figure 4B



PRAME Expression (-ΔΔCt)

Figure 5

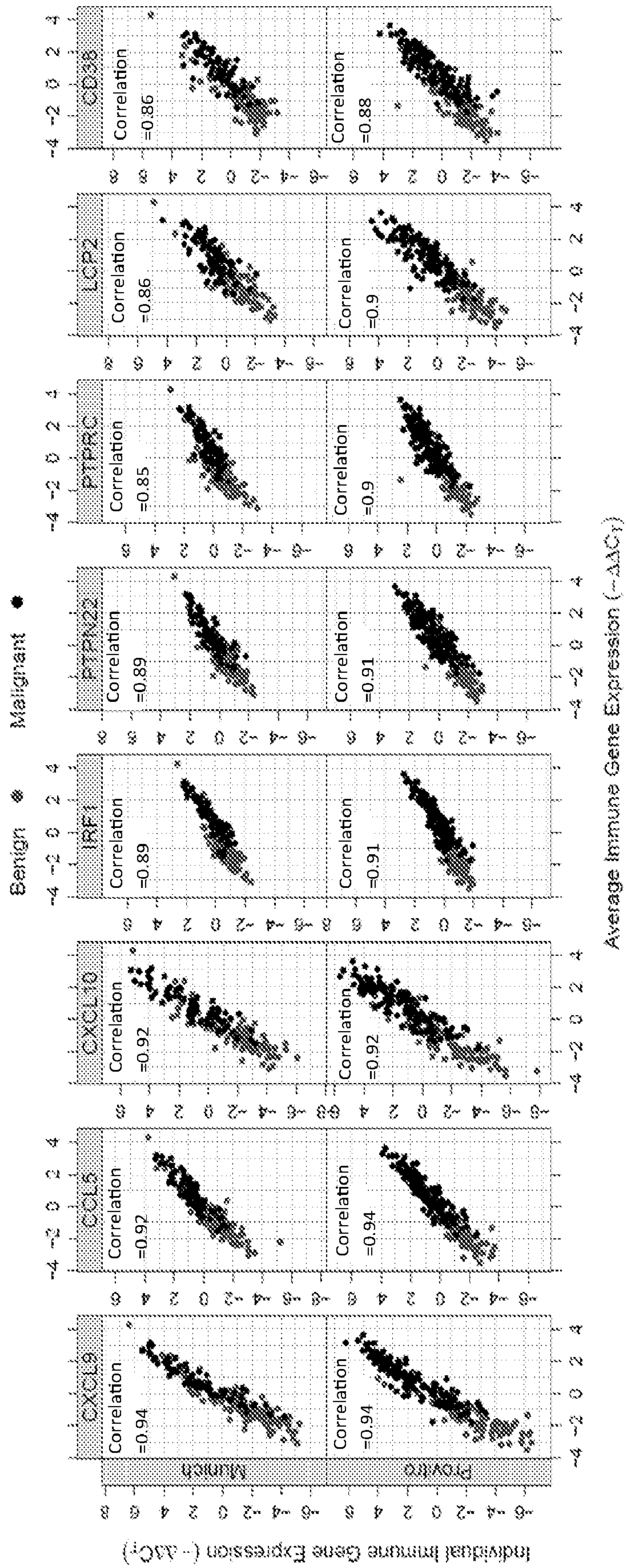

Figure 6

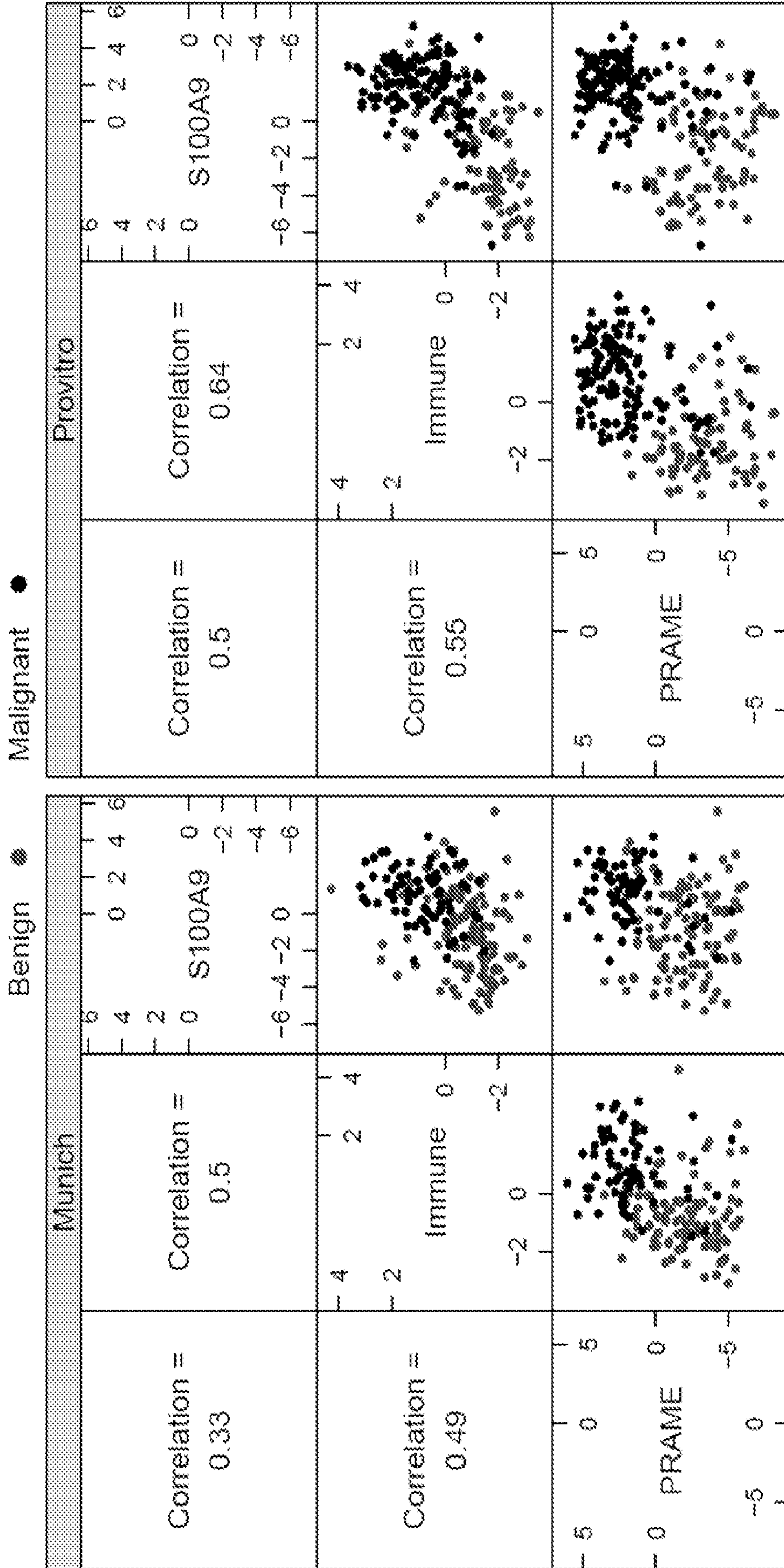

Figure 7

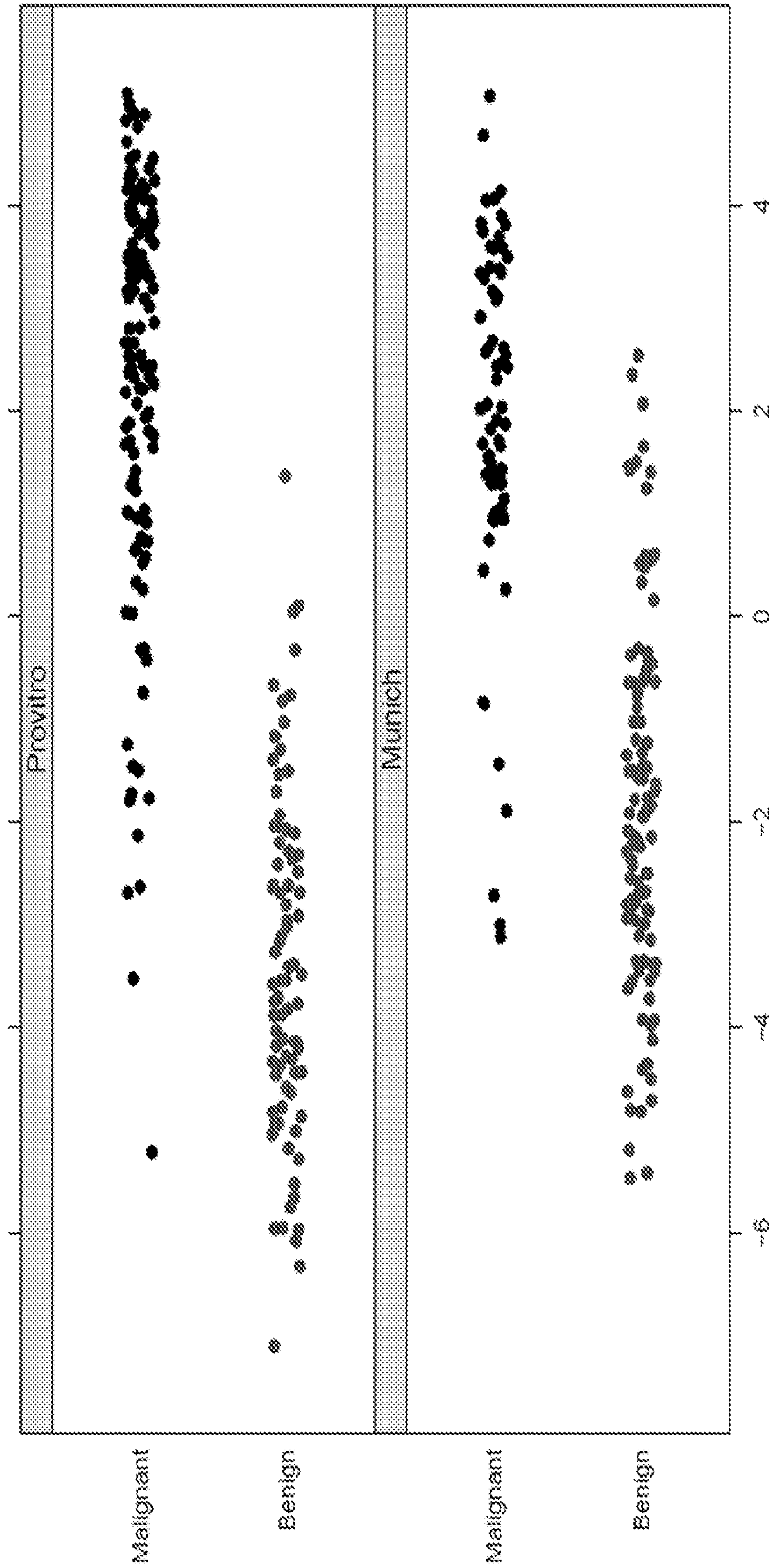

Figure 8

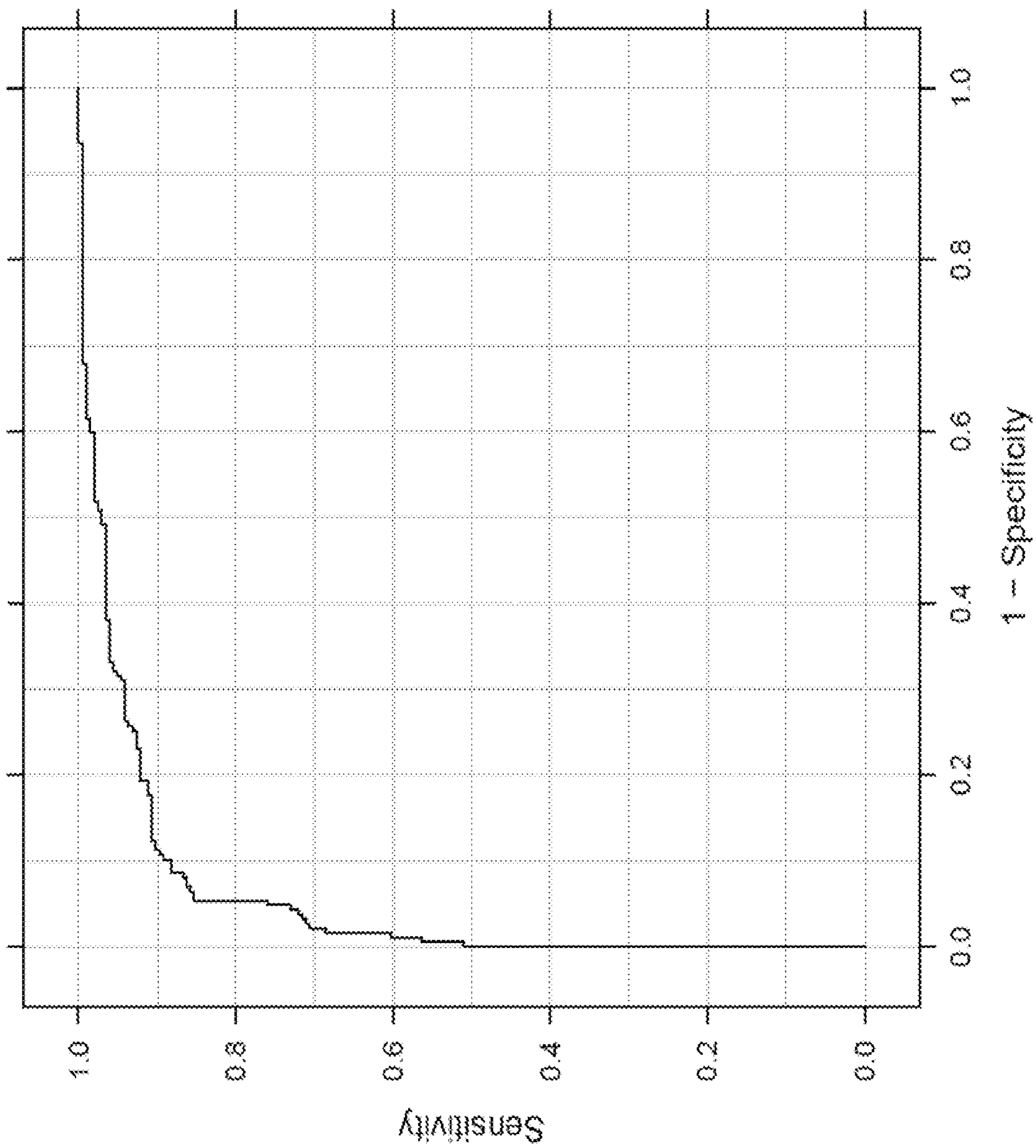

Figure 9

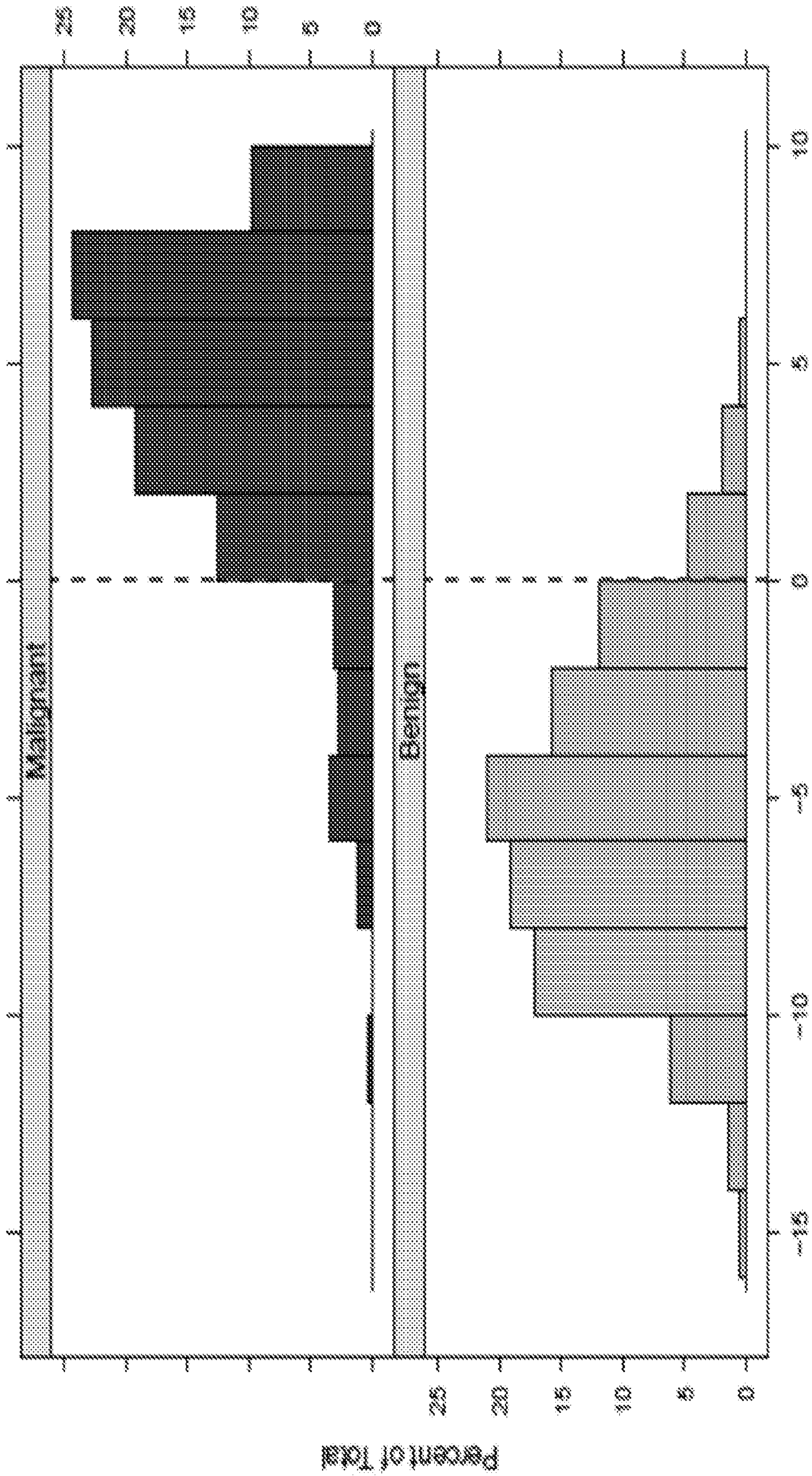

Figure 10

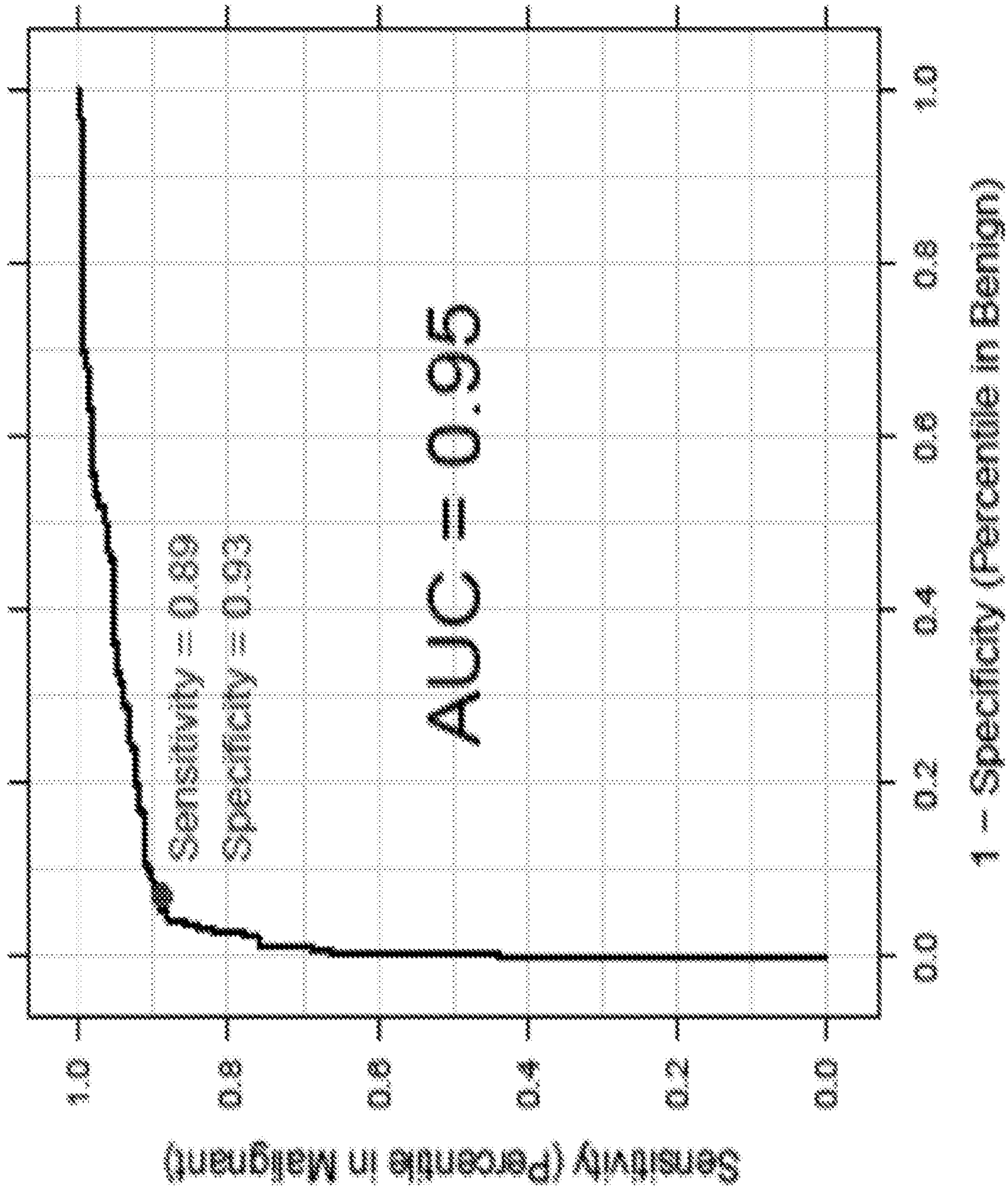

Figure 11

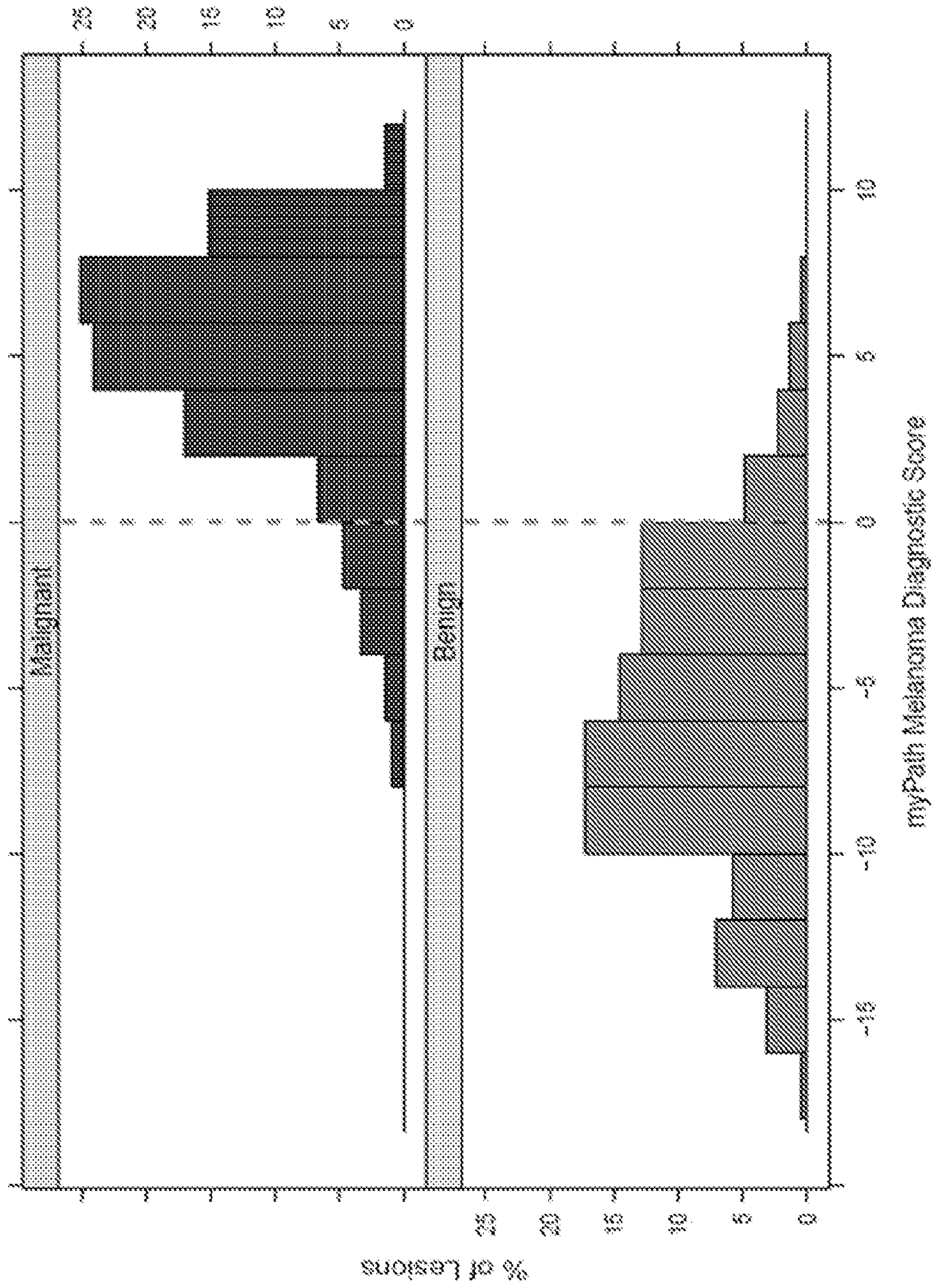

Figure 12

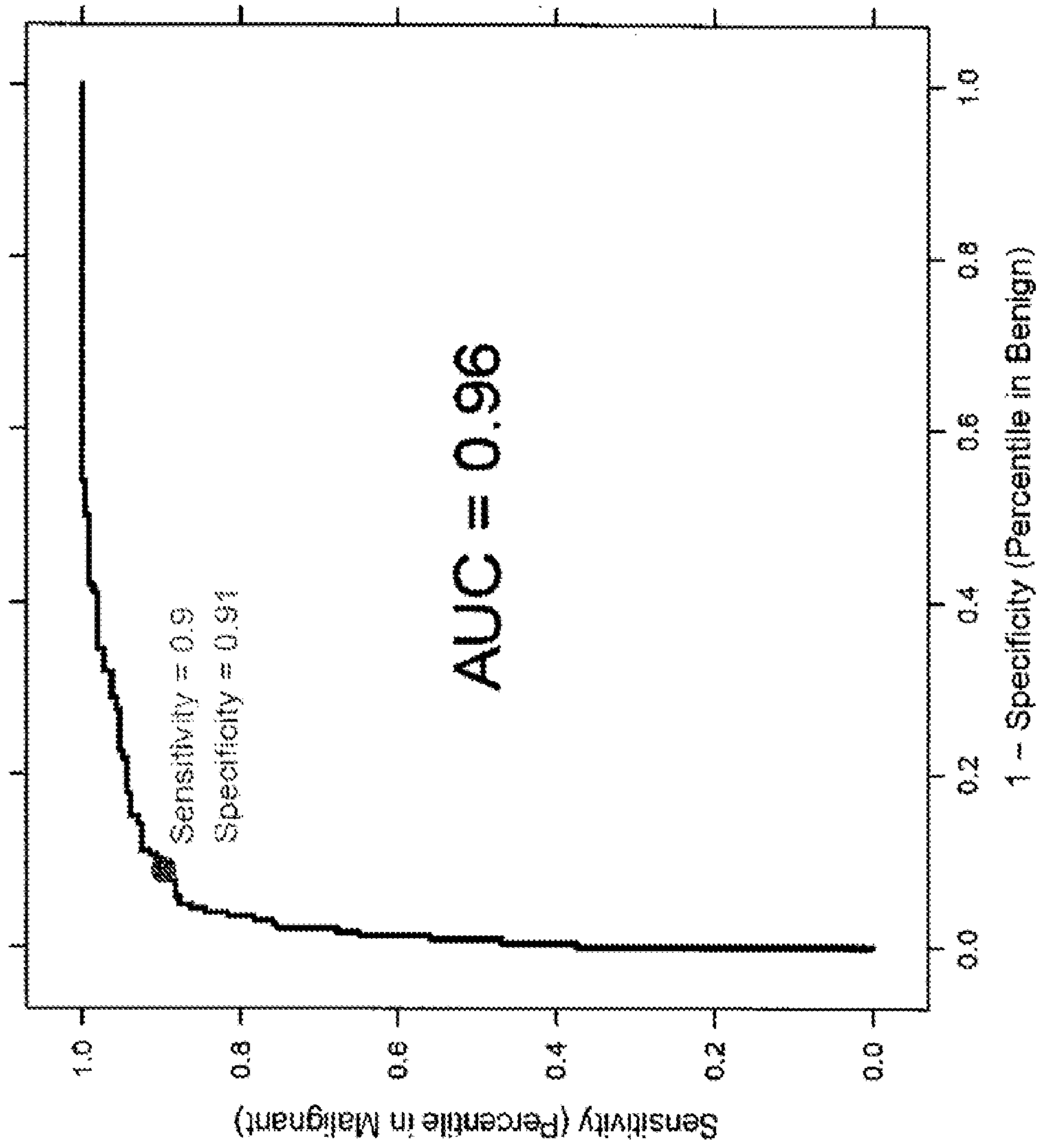

Figure 13

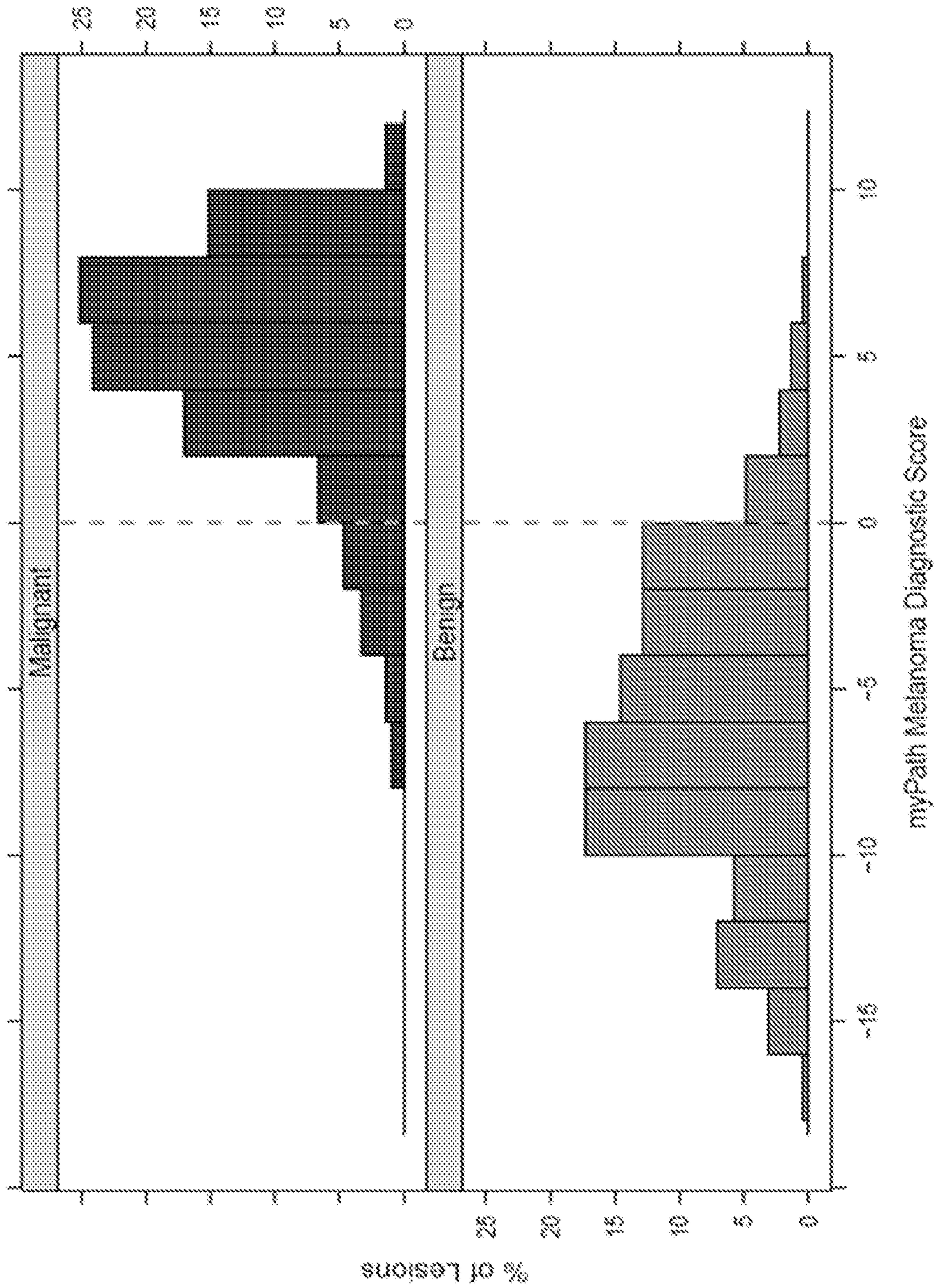

Figure 14

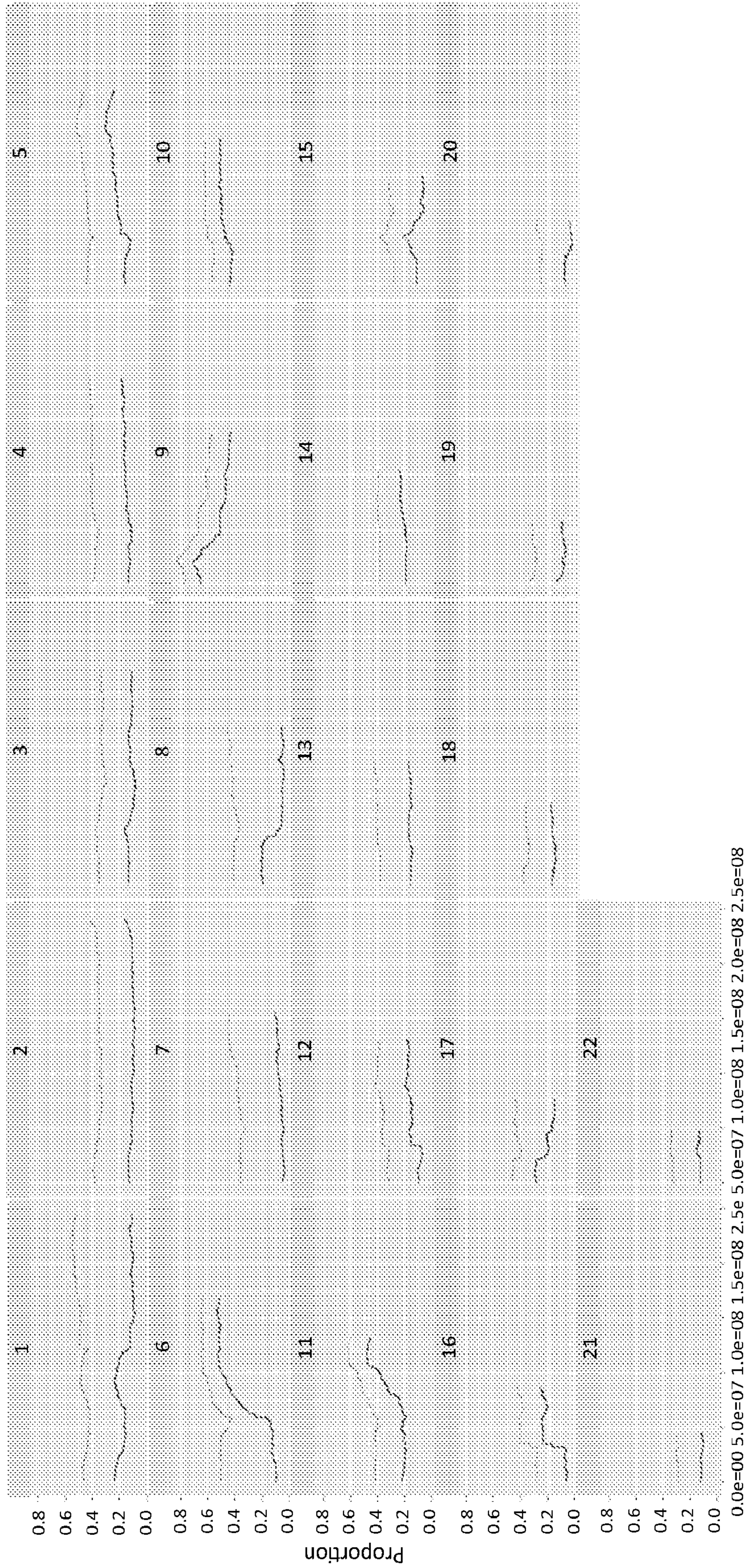

Figure 15