



(72) Inamoto, Tomoyuki, JP

(72) Fujimura, Hidetaka, JP

(72) Nagata, Yasuhiro, JP

(73) SANKYO COMPANY LIMITED, JP

(51) Int.Cl.⁵ G01N 27/30

(30) 1989/08/30 (223614/1989) JP

(54) **METHODE ET DISPOSITIF POUR REMETTRE SOUS TENSION
L'ELECTRODE D'UN BIOSENSEUR**

(54) **METHOD AND APPARATUS FOR REVIVING AN ELECTRODE
OF A BIOSENSOR**

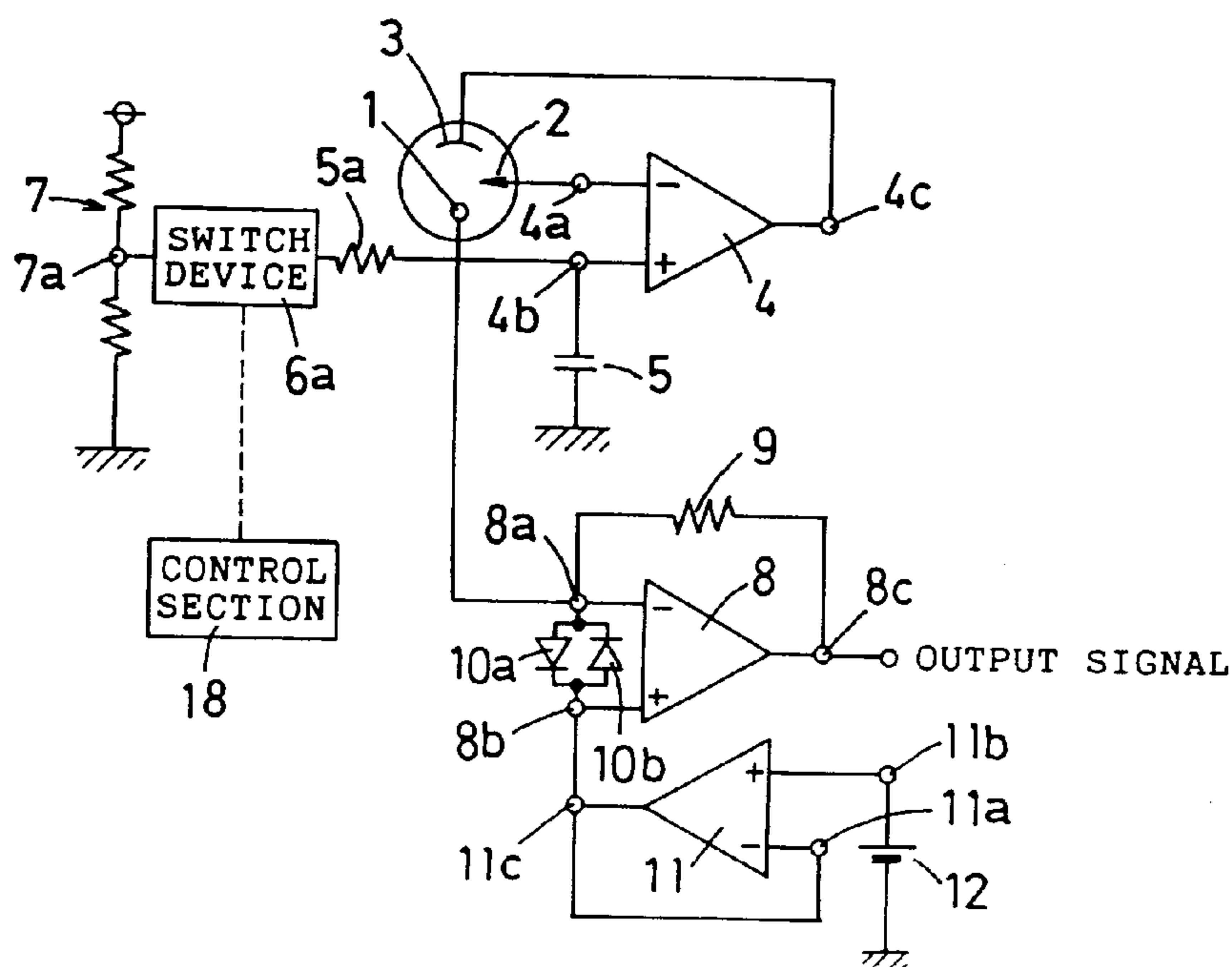

(57) When a bias is applied between a working electrode and a counter electrode or a reference electrode, the bias is gradually increased in its absolute value according to a predetermined time constant, Thus, damage to the membrane or membranes fixed on a surface of an electrode unit is reduced.

2024234

Abstract of the Disclosure

When a bias is applied between a working electrode and a
counter electrode or a reference electrode, the bias is
5 gradually increased in its absolute value according to a
predetermined time constant. Thus, damage to the
membrane or membranes fixed on a surface of an electrode
unit is reduced.

10

15

20

25

2024234

Method and Apparatus for Reviving An Electrode of A
Biosensor

Background of the Invention

5

The present invention relates to methods and apparatus for reviving an electrode of a biosensor, and more particularly to methods and apparatus for reviving an electrode of a biosensor by supplying a bias having a different polarity from the measurement bias polarity to the electrode before a measuring operation is started.

10
15
It is known that a physiologically active substance is capable of selectively detecting a very complicated organic compound, protein or the like with high sensitivity. With attention directed to this characteristic, research has been made in various biosensors.

20
25
A typical biosensor having an electrode unit and a physiologically active substance fixed thereon is proposed. The biosensor is used for detecting the existence of an object substance, the relative or active quantity of the object substance and the like based on an electrical signal output from the electrode unit corresponding to the biological reaction of the object

2024234

substance, under the condition that a predetermined forward bias is applied to the electrode unit. For example, the electrode unit has a working electrode made of platinum and a counter electrode made of silver. An enzyme-immobilized membrane is fixed onto the electrode unit. When the object substance is to be measured, hydrogen peroxide is generated through an enzyme reaction of the object substance. Then the generated hydrogen peroxide reaches the surface of the electrode unit through a hydrogen peroxide penetration membrane. The electrode unit outputs an electrical signal corresponding to the quantity of hydrogen peroxide that reaches it. The existence of the object substance, the relative or active quantity of the object substance and the like are detected based on the electrical signal. Concretely, the working electrode has a forward bias of 0.6 volts applied with respect to the counter electrode.

In the biosensor described above, an interfering layer such as an oxidized layer and the like which interferes with electrical signals is generated on the working electrode, and the activity of the working electrode is lowered as the object substance measuring operation is continued with the forward bias being applied to the electrode unit. It is proposed that a reverse bias is accordingly applied to the electrode

2024234

unit (the working electrode has a reverse bias of about -
0.6 volts applied with respect to the counter electrode,
corresponding to the concrete example) after one or more
measuring is performed, within the time period in which
5 the measurment is not performed, so as to remove the
interfering layer. Then the activity of the working
electrode is revived. The level of the output signal
from the electrode unit is raised to the original level.

(Refer to Japanese Patent Laid Open Sho 60-155959).

10 Lowered measuring sensitivity is recovered by
applying the predetermined reverse bias voltage to the
electrode unit within the time period in which the
measurment is not performed, as is described above, then
measuring with high sensitivity can be performed again.

15 In the reviving apparatus described above,
reverse bias for reviving is applied between the working
electrode and the counter electrode (refer to fig.
6(A)) every predetermined time (for example, every one
hour) and just before starting of measurement. When the
20 reverse bias for reviving is applied between the working
electrode and the counter electrode, a large current
flows in thin membranes fixed on a surface of an
electrode unit (refer to fig. 6(B)). Thin membranes,
especially a selective penetration membrane being
25 positioned close to the electrode unit, are gradually

2024234

destroyed, thereby the penetration quantity of substances generated by the reaction or substances consumed by the reaction increases. For example, when the biosensor is used to measure concentration of glucose, the hydrogen peroxide selective penetration membrane, made of a cellulose acetate membrane is destroyed, thereby the quantity of penetrating hydrogen peroxide increases. As a result, there is a disadvantage that an electrical signal provided from the electrode unit increases depending on number of times a reviving operation occurs. Another disadvantage is that the life of the membrane or membranes is shortened by up to about one month. The life is a time period until a penetration ratio of the hydrogen peroxide selective penetration membrane increases by 10 %.

Summary of the Invention

It is an object of the present invention to suppress the degree of damage to the membrane or membranes fixed on a surface of an electrode unit.

This present invention first applies a predetermined reverse bias to a working electrode for a predetermined time period, then, applies a predetermined

2024234

forward measurement bias to the working electrode for a predetermined time period, at least one of the reverse bias and the forward measurement bias being a bias voltage which gradually increases in absolute value up to a predetermined value.

It is preferred that the predetermined reverse bias is a reverse bias which is gradually increased until its absolute value reaches a predetermined value, and the forward measurement bias is a forward bias which is gradually increased until its absolute value reaches a predetermined value.

It is also preferred that an increasing ratio of the forward measurement bias is equal to an increasing ratio of the reverse bias.

It is further preferred that an increasing ratio of the forward measurement bias is greater than an increasing ratio of the reverse bias.

This present invention comprises;

reviving voltage applying means for applying a reviving voltage to a working electrode;

measurement voltage applying means for applying a measurement voltage to the working electrode;

time constant means for controlling at least one of the voltages applied by the voltage applying means according to a predetermined time constant.

2024234

It is preferred that the time constant means controls the reviving voltage applied by the reviving voltage applying means and the measurement voltage applied by the measurement voltage applying means according to a predetermined time constant.

It is also preferred that the time constant means applies the same time constants to both voltages applied by both voltage applying means.

It is further preferred that the time constant means applies a longer time constant to the measurement voltage applied by the measurement voltage applying means than the time constant applied to the reviving voltage applied by the reviving voltage applying means.

In this reviving method and apparatus, when an interfering layer on the working electrode which interferes with the turning on of electricity is reduced and activity of the working electrode is revived by applying the reverse bias to the working electrode, a reverse bias with gradually increasing absolute value is applied to the working electrode (refer to fig. 1(A)) instead of a reverse bias having a constant predetermined value as applied from the beginning of reviving. A current undershoot is remarkably suppressed, accordingly (refer to fig. 1(B)).

2024234

As a result, destruction of the membrane or membranes fixed to the surface of the electrode unit is remarkably suppressed, thereby to increase the level of an electrical output signal output from the electrode unit, depending on an increase in the number of times a
5 reviving operation has occurred, is remarkably suppressed. Also, the life of the membrane or membranes is remarkably lengthened.

A current overshoot is also suppressed
10 remarkably by applying a forward measurement bias with gradually increasing absolute value. As a result, destruction of the membrane or membranes fixed to the surface of the electrode unit is further remarkably suppressed.

15 More specifically, the inventors recognized that a large current flowing at the instant of applying a reverse bias for reviving caused the membrane or membranes to be destroyed. The inventors considered the cause of such a large amount of current, and found the
20 cause is that the charging current into an electric double layer increases following sudden changing of the bias. Taking this knowledge into consideration, when the bias is gradually changed instead of suddenly changing it, a large amount of current is securely
25 prevented from flowing, and the damage to the membrane

2024234

or membranes is remarkably suppressed. In other words, the life of the membrane or membranes is remarkably lengthened.

5 These and other objectives, features and advantages of the present invention will be more readily understood upon consideration of the present invention, taken in conjunction with the accompanying drawings.

Brief Description of the Drawings

10

Figures 1(A) and 1(B) are diagrams schematically showing variations of bias voltage and current when the electrode unit is revived;

15

Figure 2 is an electronic circuit diagram of an electrode reviving apparatus in accordance with a first embodiment of the present invention;

Figure 3 is a vertical sectional view of the center portion of an electrode unit;

20

Figures 4 is a diagram showing actual variations of current when the electrode unit is revived;

Figure 5 is an electronic circuit diagram of an electrode reviving apparatus in accordance with a second embodiment of the present invention;

25

Figures 6(A) and 6(B) are diagrams showing variations of bias voltage and current when the

2024234

electrode unit is revived in conventional manner.

Detailed Description of the Preferred Embodiments

5 Fig. 2 is an electronic circuit diagram of an electrode reviving apparatus in accordance with a first embodiment of the present invention.

10 The apparatus revives an electrode unit having three electrodes, such as a working electrode 1 made of platinum, a reference electrode 2 and a counter electrode 3, both made of silver.

15 The reference electrode 2 and the counter electrode 3 are connected to an inverting input terminal 4a and an output terminal 4c of an operational amplifier 4, respectively. A condenser 5, provided as a biasing source, is connected between a non-inverting input terminal 4b of the operational amplifier 4 and ground. A connecting point of the condenser 5 and the operational amplifier 4 is connected to a high voltage tap 7a of a voltage divider 7 having resistances, through a resistance 5a and a switch device 6a. That is, a time constant circuit is provided by the resistance 5a and the condenser 5. An inverting input terminal 8a of a current/voltage converting operational amplifier 8 for providing measurement signals is

20

25

- 10 -

connected to the working electrode 1. A current/voltage converting resistance 9 is connected between an output terminal 8c and the inverting input terminal 8a of the current/voltage converting operational amplifier 8.

5 Diodes 10a and 10b are connected in parallel and in reverse polarity with respect to one another between the inverting input terminal 8a and a non-inverting input terminal 8b of the current/voltage converting operational amplifier 8. A DC power source 12 for
10 measuring is connected to a non-inverting input terminal 11b of a buffer amplifier 11. An output terminal 11c of the buffer amplifier 11 is connected directly to an inverting input terminal 11a of the buffer amplifier 11.

The output terminal 11c of the buffer amplifier 11 is
15 connected to the non-inverting input terminal 8b of the current/voltage converting operational amplifier 8. The DC power source 12 is used for applying a forward bias of 0.75 volts to the working electrode 1. The high voltage tap 7a is used for applying a bias of -1 volt to
20 the working electrode 1. A control section 18 is used to control the operation of the switch device 6a.

Fig. 3 is a vertical sectional view of the center portion of an electrode unit to which the reviving apparatus is applied.

25 The working electrode 1 is provided at a

2024234

predetermined position in an electrode unit body 13.
The ring shaped reference electrode 2 and the ring
shaped counter electrode 3, both electrodes 2 and 3
surrounding the periphery of the working electrode 1,
5 are provided in the electrode unit body 13 in this
order. The electrode unit body 13 has a convex surface
on the side on which the working electrode 1, the
reference electrode 2 and the counter electrode 3 are
provided. A hydrogen peroxide selective penetration
10 membrane 14 made of cellulose acetate and the like, a
glucose oxidase immobilized membrane (hereinafter
referred to as a GOD immobilized membrane) 15 and a
diffusion-limiting membrane 16 made of polyvinyl acetate
and the like are provided in this order to fit the
15 convex surface of the electrode unit body 13. Terminals
17 for providing output signals are provided in the
electrode unit body 13, and the terminals 17 are
connected to the working electrode 1, the reference
electrode 2 and the counter electrode 3, respectively.

20 The operation of the sensor for measuring
glucose concentrations having the arrangement described
above is as follows.

When measuring of glucose concentration is
carried out, the non-inverting input terminal 4b of the
25 operational amplifier 4 is connected to the high voltage

- 12 -

tap 7a of the voltage divider 7 by operating the switch device 6a through the resistance 5a. When the non-inverting input terminal 4b is connected to the high voltage tap 7a through the resistance 5a, the high voltage tap 7a is to apply a reverse bias of -1 volt between the working electrode 1 and the reference electrode 2. The actual voltage applied between the working electrode 1 and the reference electrode 2 is determined based on the voltage between the terminals of the condenser 5, thereby the reverse bias gradually increases by a time constant which is determined by the resistance 5a and the condenser 5, as is illustrated in fig. 1(A), region R1. The time constant has a greater value, for example 0.5 seconds, than a time constant, usually 0.001-0.1 seconds, of a CR circuit (e.g. exponentially) which time constant is used for removing noise. In this condition, a current undershoot is scarcely recognized as is illustrated in fig. 1(B), region R1. Also, the activity of the electrode unit is sufficiently revived because the current has a sufficient value to reduce interfering substances on the surface of the electrode unit.

After the reverse biasing operation is performed for a predetermined time period, the switch device 6a is operated to turn off. The DC power source 12 is to apply a forward bias of 0.75 volts between the working

2024234

electrode 1 and the reference electrode 2. The actual voltage applied between the working electrode 1 and the reference electrode 2 gradually increases as is illustrated in fig. 1(A), region R2, because the voltage
5 between the terminals of the condenser 5 gradually decreases according to the predetermined time constant. In this condition, a current overshoot is remarkably suppressed as is illustrated in fig. 1(B), region R2. Furthermore, the quantity of generated hydrogen,
10 hydrogen ions and the like is lessened because a current undershoot is scarcely recognized, thereby a time period for consuming generated hydrogen, hydrogen ions and the like before it is possible to perform measuring with predetermined accuracy, is shortened. Also, accuracy of
15 the measurement is improved because destruction of the membrane or membranes is remarkably reduced. Furthermore, the life of the membrane or membranes is extended up to about one year while the life of the membrane or membranes applied in a conventional reviving
20 apparatus is about one month.

Fig. 4 is a diagram showing variations of currents, one current corresponding to the time constant of 0 seconds and another current corresponding to the time constant of 0.5 seconds. A broken line corresponds
25 to the time constant of 0 seconds, and shows an

2024234

undershoot of -78.9 micro amperes and an overshoot of
66.0 micro amperes. A solid line corresponds to the
time constant of 0.5 seconds, and shows an undershoot of
-48.0 micro amperes and an overshoot of 36.3 micro
5 amperes. As is apparent from the drawing, the
undershoot and overshoot are remarkably suppressed. In
both cases, after the undershoot has occurred, first the
current decreases in absolute value, then the current
increases in absolute value. This variation of current
10 may be caused in that the first undershoot is caused by
flowing charging current, then the charging current
decreases, thereafter, the surface of the electrode unit
is completely charged and has a potential for generating
hydrogen, thereby the current again increases in
15 absolute value.

After reviving is finished, a signal
corresponding to the concentration of glucose is output
as follows by dropping an object solution onto the
electrode unit.

20 The dropped object solution is guided to the GOD
immobilized membrane 15 with limited penetration by the
glucose to some degree, by the diffusion-limiting
membrane 16. Then, the following reaction takes place:

25

- 15 -

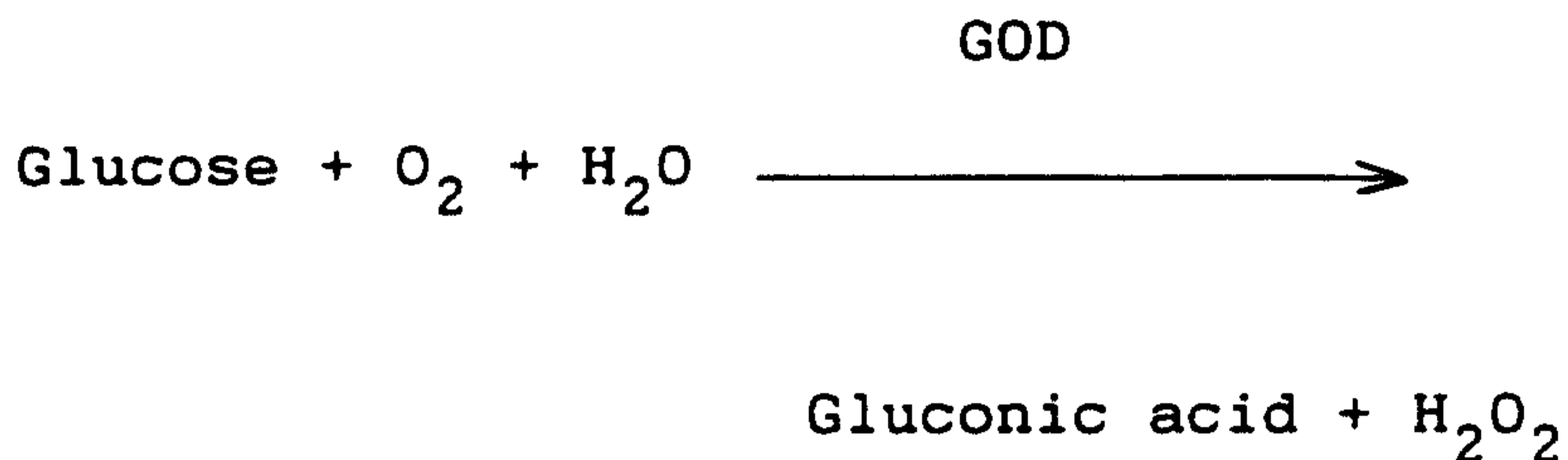

5 Hydrogen peroxide, the quantity of which corresponds to
concentration of existing glucose, is accordingly
generated. The generated hydrogen peroxide is guided to
the surface of the working electrode which is revived to
have sufficient activity, through the hydrogen peroxide
10 selective penetration membrane 14. The forward bias is
kept applied to the working electrode 1. An oxidation
reaction is carried out on the surface of the working
electrode 1 and current corresponding to the amount of
hydrogen peroxide flows in through the working electrode
15 1. The current is applied to the inverting input
terminal 8a of the current/voltage converting
operational amplifier 8, then a voltage signal is output
from the output terminal 8c of the current/voltage
converting operational amplifier 8. The voltage signal
20 is generated by adding an offset voltage caused by the
forward bias and a voltage signal being proportional to
the current.

Thereafter, only the voltage signal proportional
to the current is extracted, then the extracted voltage
25

2024234

signal is differentiated to obtain a first-order differential value, then a peak value of the first-order differential value is detected. Finally, a glucose concentration detection signal with high accuracy is
5 obtained by performing the necessary operations.

Second Embodiment

Fig. 5 is an electronic circuit diagram of an
10 electrode reviving apparatus in accordance with a second embodiment of the present invention.

Different points from the first embodiment are as follows,

(1) an electrode unit having two electrodes,
15 one is the working electrode 1 made of platinum while another, the counter electrode 3 made of silver, is used for being revived, and

(2) the counter electrode 3 is directly
connected to the switch device 6a by omitting the
20 operational amplifier 4.

In this embodiment, undershoot and overshoot are remarkably reduced when the electrode unit is revived. Also, a time period between removal of interfering substances to when it is possible to start actual
25 measuring can be shortened. Furthermore, the accuracy

2024234

of measurement is improved and the life of the membrane or membranes are lengthened because the destruction of the membrane or membranes are remarkably suppressed.

5 This invention is not limited to the foregoing embodiments. Preferably, the voltage for reviving is changed. Preferably, the time period for applying the voltage is changed corresponding to the voltage value. Preferably, the reviving method and apparatus are applied to an apparatus for measuring concentrations of
10 substances other than glucose. Preferably, a programmable power source for varying output voltage, the source being controlled by a microcomputer, is employed instead of the time constant circuit comprising the resistance 5a and the condenser 5.

15 The terms and expressions which have been employed here are used as terms of description and not of limitations, and there is no intention, in the use of such terms and expressions of excluding equivalents of the features shown and described, or portions thereof,
20 it being recognized that various modifications are possible within the scope of the invention as claimed.

- 18 -

What is claimed is:

1. A method for reviving an electrode unit of a biosensor device which includes a working electrode and a counter electrode, and which measures a concentration of an object substance based upon an electrical signal generated between the working electrode and the counter electrode when a predetermined forward measurement bias voltage is applied to the working electrode on which a physiologically active substance is placed, the electrical signal being generated based upon a biological reaction of the object substance, said method comprising the steps of;

(1) applying a predetermined reverse bias voltage to the working electrode for a predetermined time period; and

(2) applying a predetermined forward measurement bias voltage to the working electrode;

wherein at least one of the bias voltages is a bias voltage which increases in absolute value exponentially according to a time constant to reach a predetermined value.

2. A method as set forth in claim 1, wherein the predetermined reverse bias voltage is a reverse bias voltage which is increased exponentially according to a time constant until its absolute value reaches a predetermined value, and the predetermined forward measurement bias voltage is a forward bias voltage which is increased

- 19 -

exponentially according to a time constant until its absolute value reaches a predetermined value.

3. A method as set forth in claim 2, wherein a rate of increase in absolute value of the forward measurement bias voltage is equal to a rate of increase in absolute value of the reverse bias voltage.

5

4. A method as set forth in claim 2, wherein a rate increase in absolute value of the forward measurement bias voltage is greater than a rate of increase in absolute value of the reverse bias voltage.

10

5. An apparatus for reviving an electrode unit of a biosensor which includes a working electrode and a counter electrode, and which measures a concentration of an object substance based upon an electrical signal generated between said working electrode and said counter electrode when a predetermined forward measurement bias is applied to said working electrode on which a physiologically active substance is placed, said electrical signal being generated based upon a biological reaction of said object substance, said apparatus comprising;

15

20

reviving voltage applying means for applying a reviving voltage to said working electrode;

measurement voltage applying means for applying a measurement voltage to said working electrode; and

25

time constant means for controlling at least one voltage applied by one of said voltage applying means

according to a predetermined time constant.

6. An apparatus as set forth in claim 5,
wherein said time constant means controls the reviving
voltage applied by said reviving voltage applying means
5 according to a first predetermined time constant, and
controls the measurement voltage applied by said
measurement voltage applying means according to a second
predetermined time constant.

7. An apparatus as set forth in claim 6,
10 wherein said first and second time constants are the
same.

8. An apparatus as set forth in claim 6,
wherein said second time constant is greater than said
first time constant.

15

20

25

Fig.1(A) VOLTAGE 0.75V

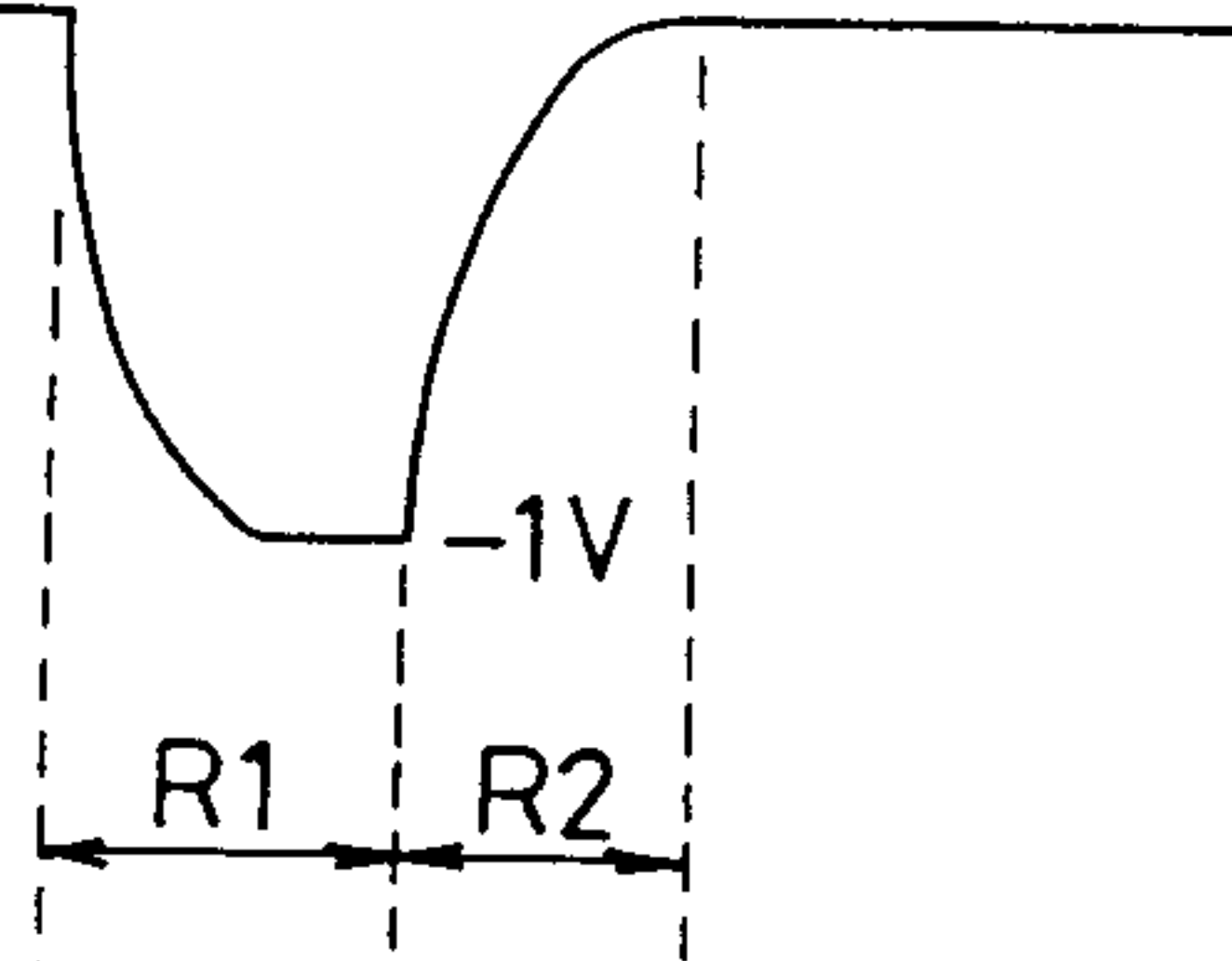

Fig.1(B) CURRENT 0 A

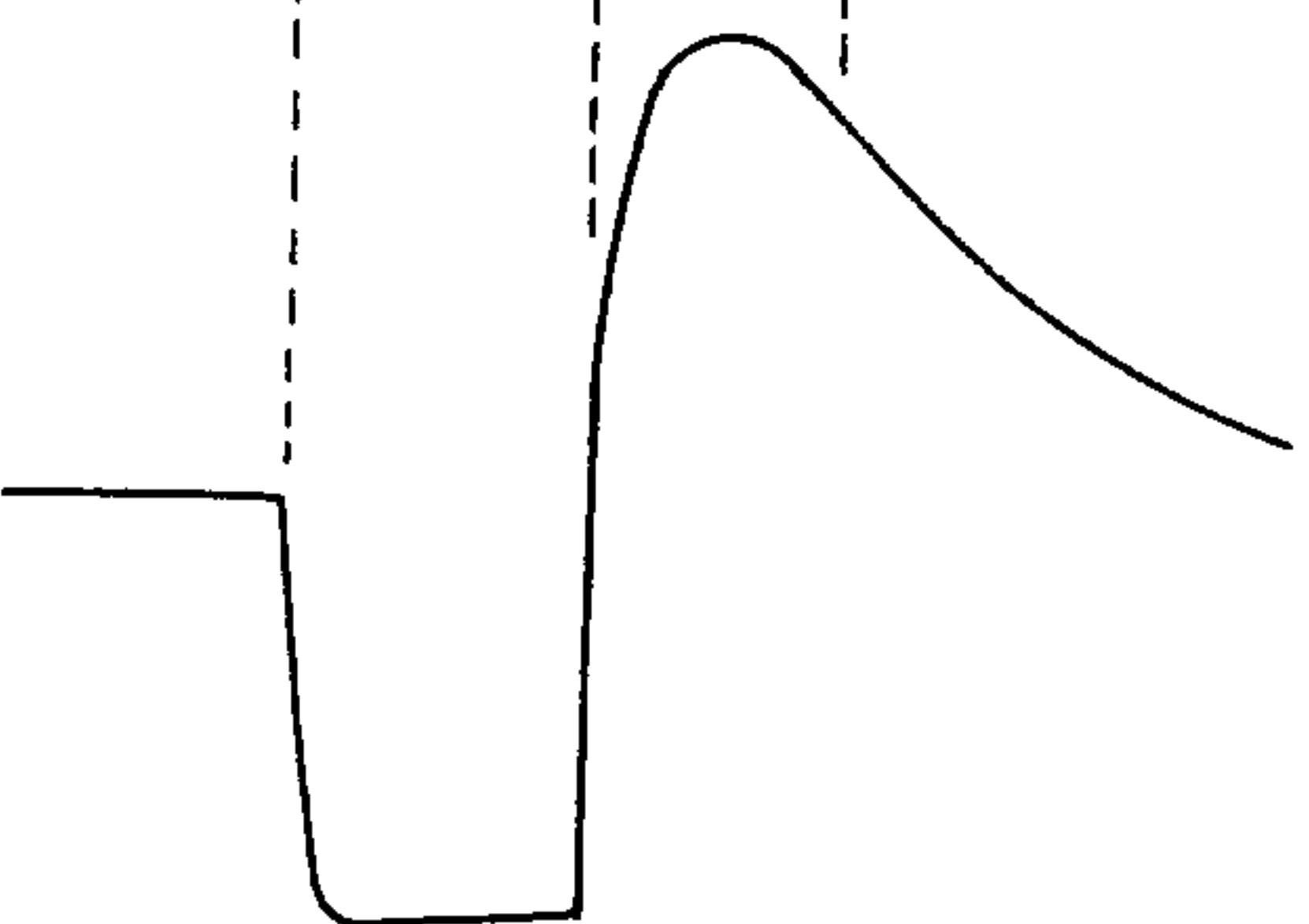

Fig.2

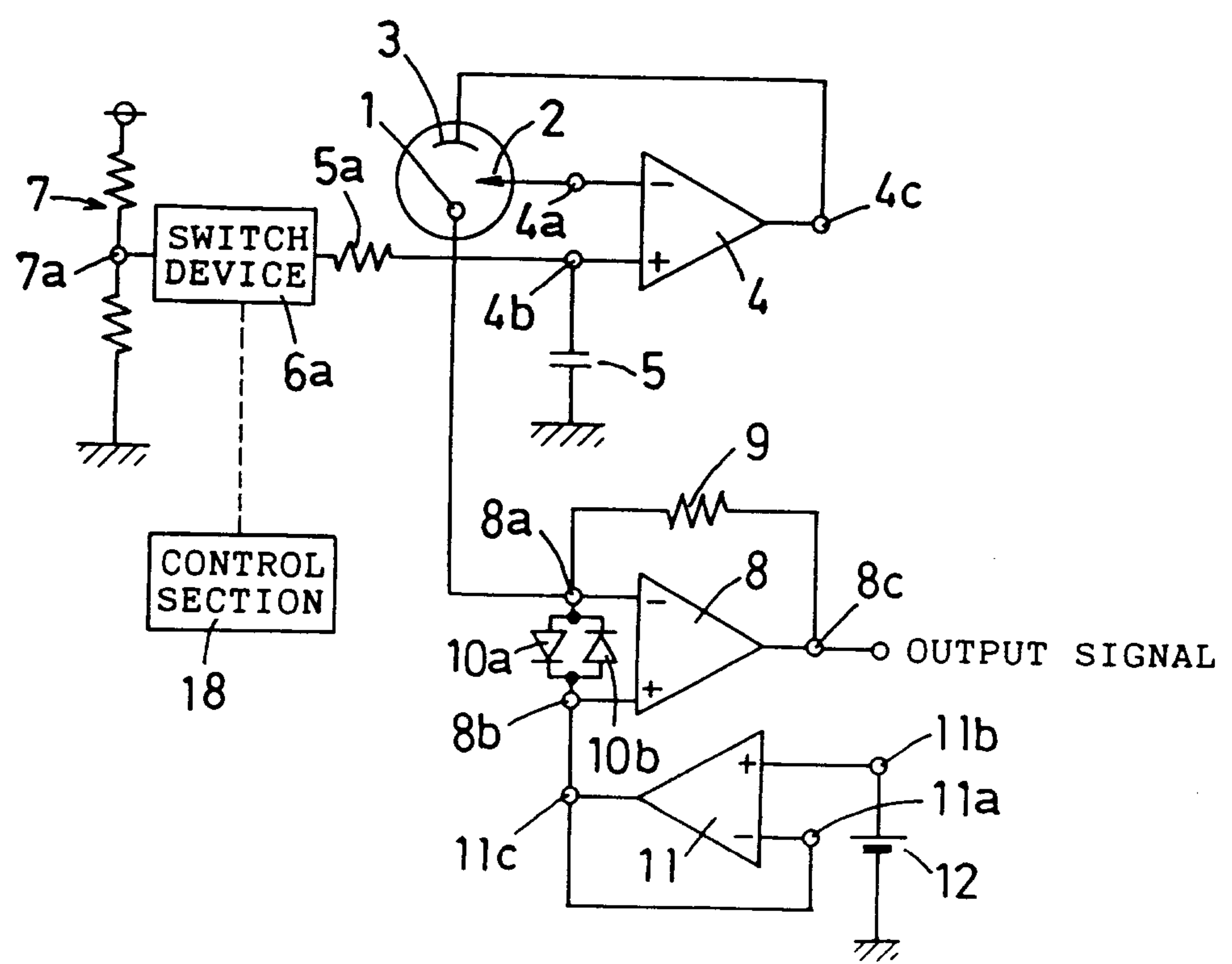
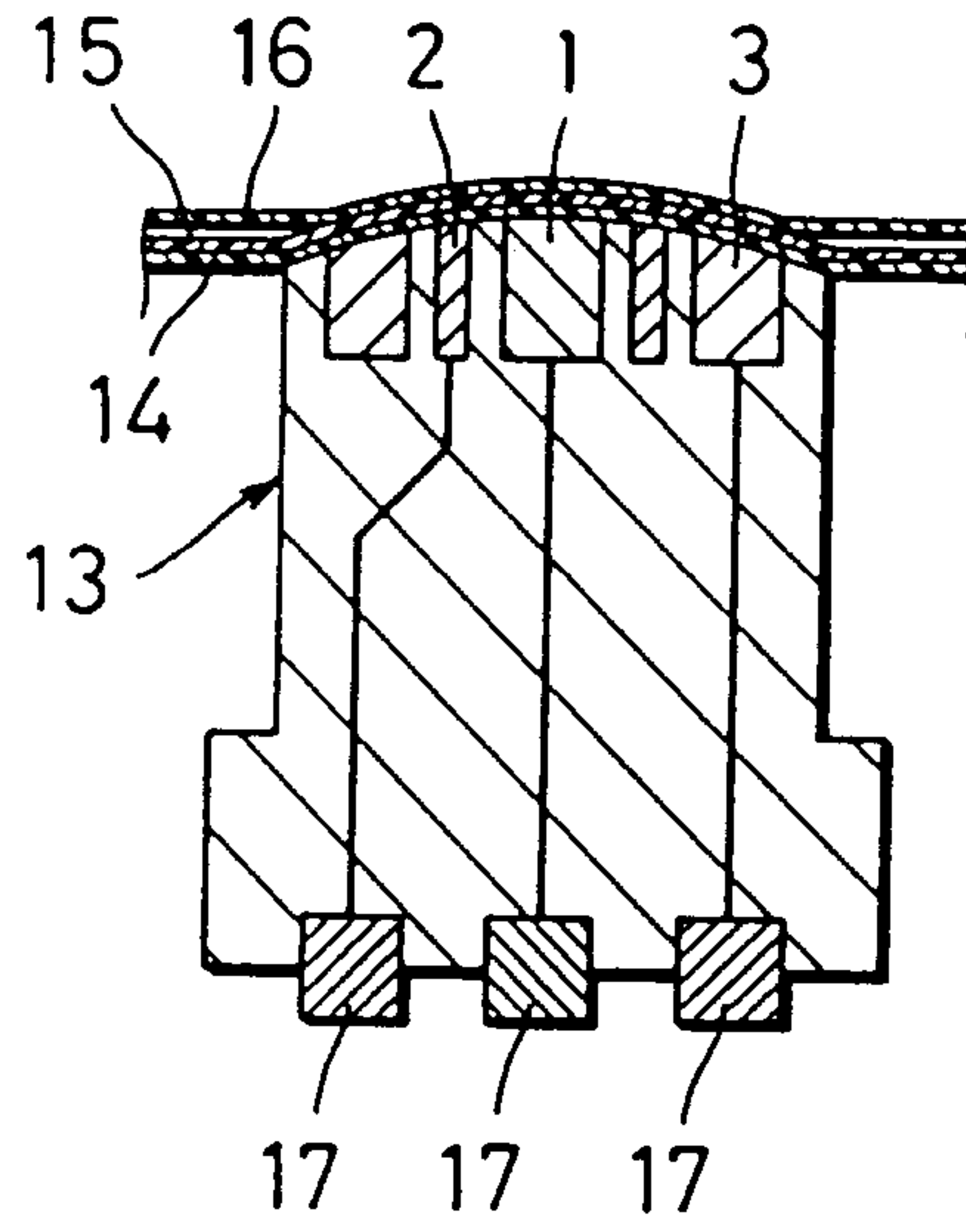
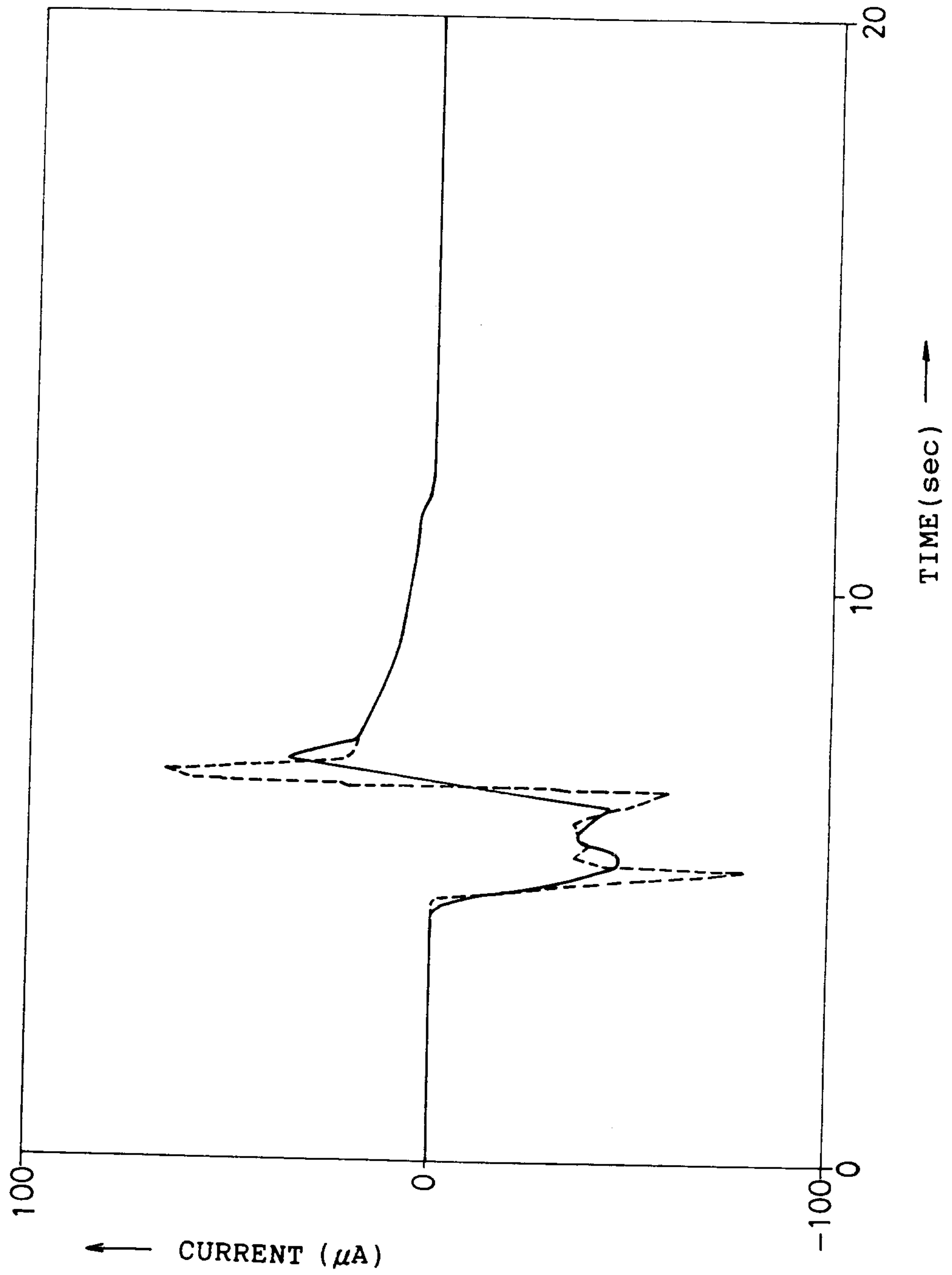

Fig. 3



2024234

Fig. 4



By: Rogers, Bereskin & Parr

Fig.5

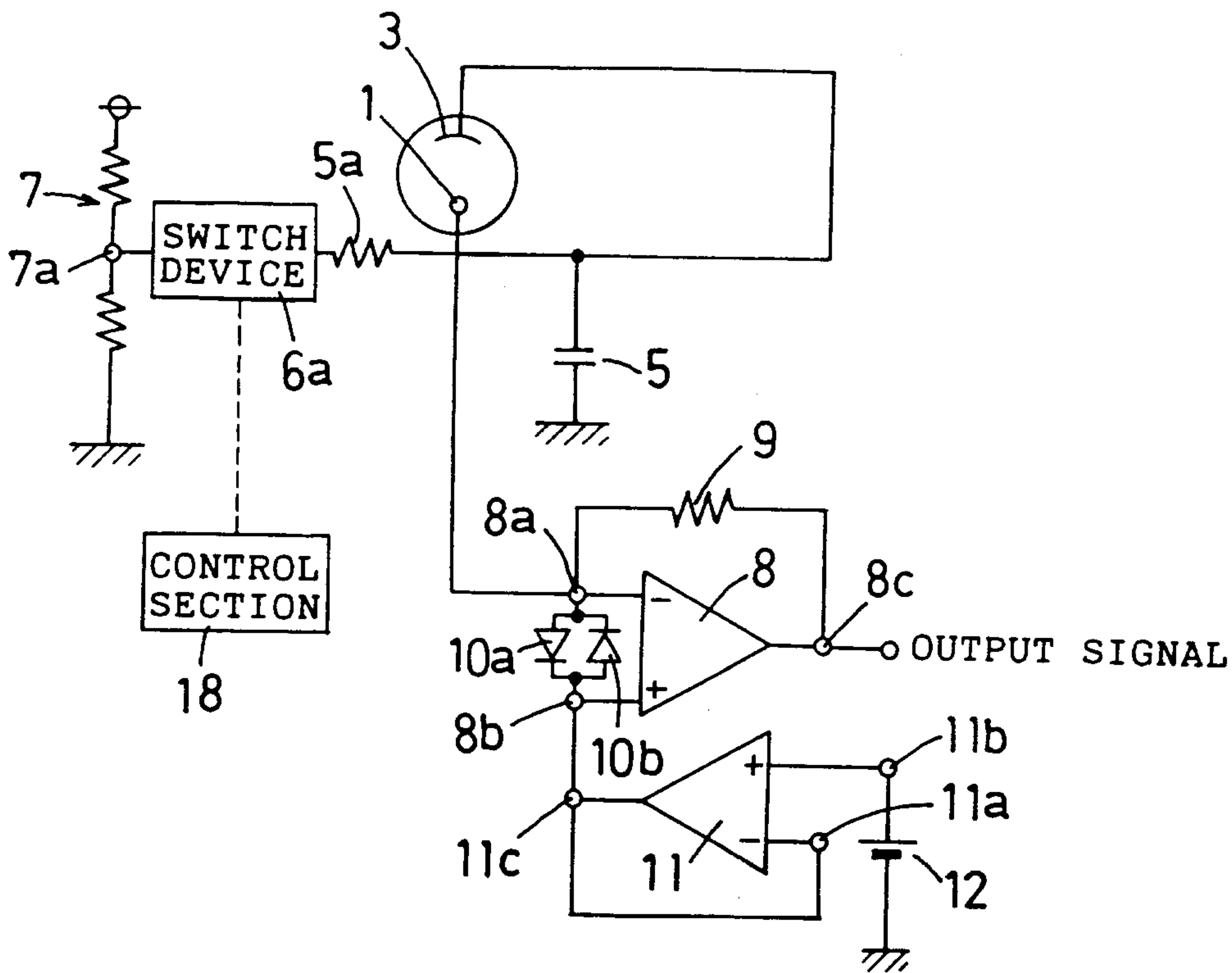

Fig.6(A) VOLTAGE 0.75V

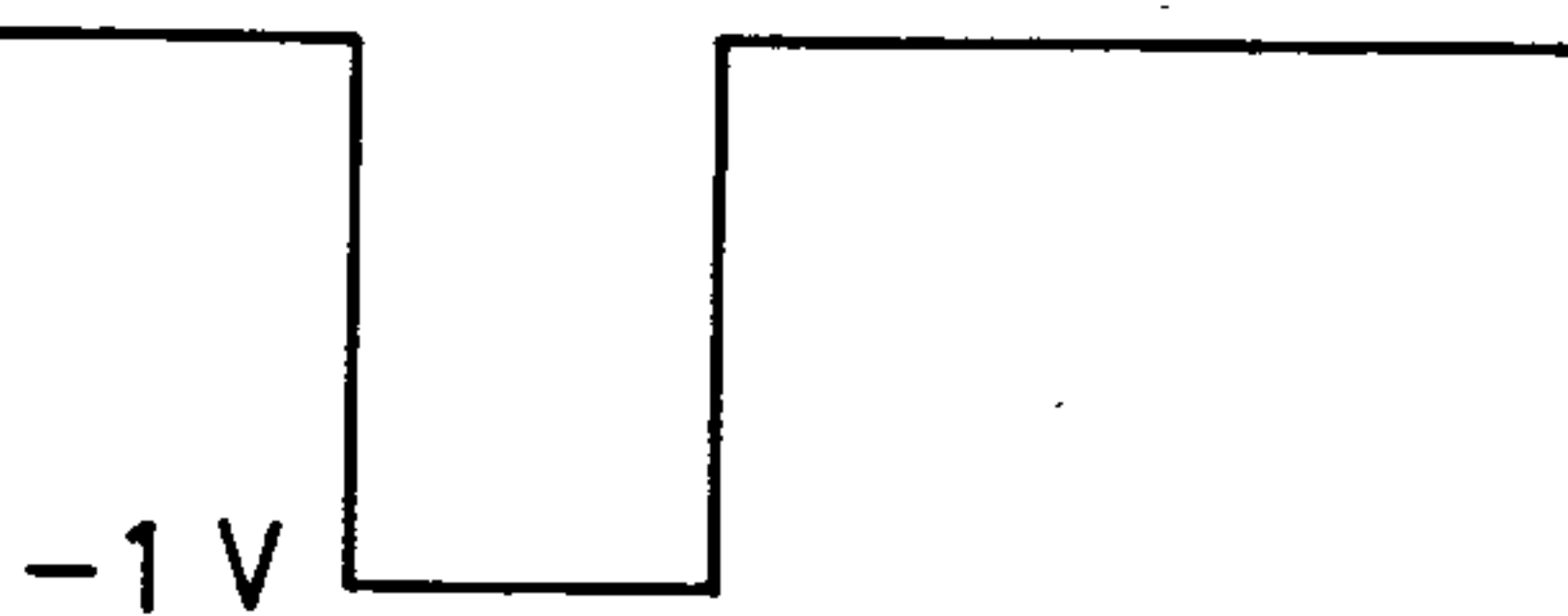

Fig.6(B) CURRENT 0 A

