



US00D792649S

(12) **United States Design Patent**  
**Dubin et al.**

(10) **Patent No.:** **US D792,649 S**  
(45) **Date of Patent:** **\*\* Jul. 18, 2017**

- (54) **RAZOR HANDLE**
- (71) Applicant: **Dollar Shave Club, Inc.**, Marina Del Rey, CA (US)
- (72) Inventors: **Michael Dubin**, Marina Del Rey, CA (US); **Javier Hall**, Marina Del Rey, CA (US)
- (73) Assignee: **Dollar Shave Club, Inc.**, Marina Del Rey, CA (US)
- (\*\*) Term: **15 Years**
- (21) Appl. No.: **29/578,030**
- (22) Filed: **Sep. 16, 2016**

- D260,944 S 9/1981 Gray
- D261,564 S 10/1981 Poisson
- D262,239 S 12/1981 Gray
- D266,960 S 11/1982 Gray et al.
- D267,438 S 12/1982 Jacobson
- D269,724 S 7/1983 Chase et al.
- D269,915 S 7/1983 Iten et al.
- D270,195 S 8/1983 Gray
- D270,196 S 8/1983 Gray et al.
- D270,197 S 8/1983 Gray
- D270,382 S 8/1983 Poisson

(Continued)

*Primary Examiner* — Jennifer Rivard  
(74) *Attorney, Agent, or Firm* — DLA Piper LLP (US)

(57) **CLAIM**

We claim the ornamental design for a razor handle, as shown and described.

**Related U.S. Application Data**

- (63) Continuation of application No. 29/544,420, filed on Nov. 3, 2015, now Pat. No. Des. 779,122.
- (51) **LOC (10) Cl.** ..... **28-03**
- (52) **U.S. Cl.**  
USPC ..... **D28/48**
- (58) **Field of Classification Search**  
USPC ..... D28/46-48  
CPC ..... B26B 21/52-21/528; B26B 21/14-21/38;  
B26B 21/00; B26B 21/08  
See application file for complete search history.

**DESCRIPTION**

FIG. 1 is a front perspective of a razor handle according to an embodiment of our new design;  
 FIG. 2 is a bottom perspective of a razor handle according to an embodiment of our new design;  
 FIG. 3 is a front elevational view of a razor handle according to an embodiment of our new design;  
 FIG. 4 is a rear elevational view of a razor handle according to an embodiment of our new design;  
 FIG. 5 is a left elevational view of a razor handle according to an embodiment of our new design;  
 FIG. 6 is a right elevational view of a razor handle according to an embodiment of our new design;  
 FIG. 7 is a top plan view of a razor handle according to an embodiment of our new design; and,  
 FIG. 8 is a bottom plan view of a razor handle according to an embodiment of our new design.  
 The broken lines showing a button, cartridge, handle end, and docking features in the figures are for illustrative purposes only and form no part of the claimed design.

(56) **References Cited**

**U.S. PATENT DOCUMENTS**

- D242,661 S 12/1976 Gray
- D245,460 S 8/1977 Poisson
- D255,160 S 5/1980 Gray
- D255,164 S 5/1980 Byrne
- D255,165 S 5/1980 Byrne
- D256,059 S 7/1980 Poisson
- D257,793 S 1/1981 Gray
- D259,065 S 4/1981 Byrne
- D260,191 S 8/1981 Chase et al.

**1 Claim, 8 Drawing Sheets**

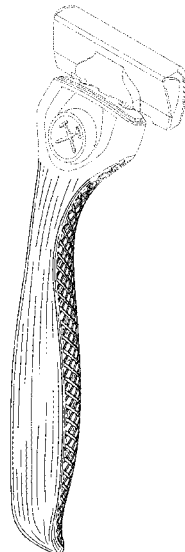

(56)

References Cited

U.S. PATENT DOCUMENTS

D270,384 S	8/1983	Gray	D475,484 S	6/2003	Wonderley
D271,625 S	11/1983	Gray	D476,113 S	6/2003	Wonderley
D271,813 S	12/1983	Gray	D476,772 S	7/2003	Wonderley
D277,987 S	3/1985	Jacobson et al.	D478,687 S	8/2003	Provost
D293,036 S	12/1987	Iten et al.	D482,131 S	11/2003	Fine et al.
D305,265 S	12/1989	Motta et al.	D483,526 S	12/2003	Efthimiadis et al.
D305,805 S	1/1990	Gray	D491,311 S	6/2004	Follo
D308,427 S	6/1990	Gyllerstrom	D491,690 S	6/2004	Yamashita
D309,355 S	7/1990	Shurtleff	D495,826 S	9/2004	Ham et al.
D309,958 S	8/1990	Iten et al.	D495,828 S	9/2004	Ham et al.
D321,953 S	11/1991	Gray	D499,210 S	11/2004	Shepperson et al.
D325,653 S	4/1992	Tilley et al.	D500,170 S	12/2004	Jung
D327,139 S	6/1992	Tilley et al.	D500,171 S	12/2004	Lee
D327,550 S	6/1992	Chen et al.	D500,173 S	12/2004	Wakayama
D335,722 S	5/1993	Gray	D500,174 S	12/2004	Gray
D345,232 S	3/1994	Gray	D500,390 S	12/2004	Gray
D345,441 S	3/1994	Gray	D500,888 S	1/2005	Gray
D345,821 S	4/1994	Wonderley	D506,035 S	6/2005	Dombrowski et al.
D354,586 S	1/1995	Grange	D509,321 S	9/2005	Gray
D355,049 S	1/1995	Yasui	D510,643 S	10/2005	Gray
D363,141 S	10/1995	Burout et al.	D511,024 S	10/2005	Dombrowski et al.
D366,728 S	1/1996	Ryu	D511,223 S	11/2005	Miyazaki et al.
D370,305 S	5/1996	Wonderley	D513,442 S	1/2006	Miyazaki et al.
D370,741 S	6/1996	Wonderley	D515,740 S	2/2006	Provost et al.
D377,238 S	1/1997	Byrne	D516,244 S	2/2006	Efthimiadis et al.
D378,623 S	3/1997	Wonderley	D524,984 S	7/2006	Ramm et al.
D380,866 S	7/1997	Wonderley	D526,090 S	8/2006	Bartschi et al.
D386,821 S	11/1997	Shurtleff et al.	D533,964 S	12/2006	Ham
D389,272 S	1/1998	Ryu	D534,313 S	12/2006	Provost et al.
D389,955 S	1/1998	Wonderley	D534,314 S	12/2006	Lee
D392,416 S	3/1998	Wonderley	D534,316 S	12/2006	Bozikis et al.
D392,417 S	3/1998	Gray	D534,685 S	1/2007	Ciccone et al.
D392,418 S	3/1998	Gray	D534,686 S	1/2007	Provost et al.
D393,330 S	4/1998	Gray	D534,687 S	1/2007	Dombrowski et al.
D396,129 S	7/1998	Gray	D535,056 S	1/2007	Wonderley et al.
D397,512 S	8/1998	Gray	D536,133 S	1/2007	Bozikis et al.
D397,829 S	9/1998	Gray	D536,485 S	2/2007	Wonderley et al.
D397,830 S	9/1998	Gray	D536,829 S	2/2007	Dombrowski et al.
D398,718 S	9/1998	Gray	D536,830 S	2/2007	Ramm et al.
D402,403 S	12/1998	Motta et al.	D537,203 S	2/2007	Provost et al.
D403,113 S	12/1998	Kohring et al.	D537,204 S	2/2007	Ramm et al.
D403,114 S	12/1998	Shurtleff	D540,985 S	4/2007	Rhoad et al.
D404,527 S	1/1999	Gray	D541,474 S	4/2007	Psimadas et al.
D406,393 S	3/1999	Gray	D541,476 S	4/2007	Rhoad et al.
D407,850 S	4/1999	Shurtleff	D541,477 S	4/2007	Rhoad et al.
D407,851 S	4/1999	Shurtleff	D542,470 S	5/2007	Bunnell et al.
D408,101 S	4/1999	Shurtleff	D542,471 S	5/2007	Bunnell et al.
D414,298 S	9/1999	Pennella et al.	D542,472 S	5/2007	Sakurai
D414,898 S	10/1999	Grange	D547,904 S	7/2007	Wonderley et al.
D415,316 S	10/1999	Prochaska	D550,401 S	9/2007	Rhoad et al.
D415,317 S	10/1999	Aiston	D555,834 S	11/2007	Rhoad et al.
D416,108 S	11/1999	Shurtleff et al.	D555,958 S	11/2007	Takeshita
D416,109 S	11/1999	Wonderley	D558,398 S	12/2007	Park
D419,265 S	1/2000	Gray	D559,455 S *	1/2008	Padain ..... D28/88
D422,117 S	3/2000	Motta	D560,031 S	1/2008	Fischer et al.
D425,250 S	5/2000	Gray	D560,033 S	1/2008	Rhoad et al.
D425,251 S	5/2000	Gray	D560,851 S	1/2008	Rhoad et al.
D428,203 S	7/2000	Zwonitzer et al.	D563,045 S	2/2008	Provost et al.
D429,543 S	8/2000	Garland et al.	D563,046 S	2/2008	Provost et al.
D435,144 S	12/2000	Chenvainu et al.	D563,047 S	2/2008	Ramm et al.
D435,315 S	12/2000	Coffin et al.	D565,245 S	3/2008	Wonderley
D435,316 S	12/2000	Chenvainu et al.	D566,896 S	4/2008	Jung
D438,342 S	2/2001	Gray	D566,897 S	4/2008	Lee
D439,015 S	3/2001	Wonderley	D568,000 S	4/2008	Wonderley et al.
D441,910 S	5/2001	Prochaska	D568,535 S	5/2008	Rhoad et al.
D444,267 S	6/2001	Gray	D568,536 S	5/2008	Rhoad et al.
D445,958 S	7/2001	Dansreau et al.	D568,538 S	5/2008	Rhoad et al.
D446,884 S	8/2001	Kohring et al.	D569,038 S	5/2008	Rhoad
D452,348 S	12/2001	Wonderley	D569,039 S	5/2008	Rhoad
D457,684 S	5/2002	Wonderley	D569,040 S	5/2008	Micinilio et al.
D458,410 S	6/2002	Shepperson	D569,551 S	5/2008	Micinilio et al.
D458,709 S	6/2002	Wonderley	D571,955 S	6/2008	Wonderley et al.
D464,172 S	10/2002	Shepperson	D575,903 S	8/2008	Wakayama
D466,649 S	12/2002	Wonderley et al.	D581,593 S	11/2008	Rhoad
D467,388 S	12/2002	Prochaska et al.	D581,594 S	11/2008	Micinilio et al.
			D581,595 S	11/2008	Micinilio et al.
			D587,403 S	2/2009	Wonderley
			D587,846 S	3/2009	Wonderley et al.
			D587,847 S	3/2009	Sakurai

(56)

## References Cited

## U.S. PATENT DOCUMENTS

D588,308 S	3/2009	Wonderley	D644,790 S	9/2011	Lukan et al.
D589,209 S	3/2009	Jung	D645,205 S	9/2011	Lukan et al.
D589,210 S	3/2009	Wonderley et al.	D646,436 S	10/2011	Furuta
D590,996 S	4/2009	Nakasuka	D650,527 S	12/2011	Andersen et al.
D593,711 S	6/2009	Yamamoto	D650,528 S	12/2011	Andersen et al.
D598,606 S	8/2009	Watson	D650,943 S	12/2011	Micinilio
D598,999 S	8/2009	Hidalgo	D650,946 S	12/2011	Andersen et al.
D599,955 S	9/2009	Provost	D651,345 S	12/2011	Micinilio
D602,634 S	10/2009	Cataudella et al.	D655,042 S	2/2012	Watson et al.
D602,635 S	10/2009	Watson	D655,861 S	3/2012	Watson
D603,097 S	10/2009	Cataudella	D656,676 S	3/2012	Cavazos Jimenez et al.
D603,098 S	10/2009	Cataudella	D656,677 S	3/2012	Cavazos Jimenez et al.
D603,556 S	11/2009	Rhoad	D657,092 S	4/2012	Watson et al.
D603,557 S	11/2009	Rhoad	D659,285 S	5/2012	Lukan et al.
D603,558 S	11/2009	Micinilio	D659,286 S	5/2012	Lukan et al.
D603,559 S	11/2009	Micinilio	D659,287 S	5/2012	Psimadas et al.
D603,560 S	11/2009	Micinilio	D661,020 S	5/2012	Wain et al.
D604,012 S	11/2009	Jung	D661,425 S	6/2012	Cataudella et al.
D604,456 S	11/2009	Jung	D661,427 S	6/2012	Christie et al.
D604,906 S	11/2009	Stowers et al.	D662,663 S	6/2012	Haba
D605,815 S	12/2009	Furuta	D662,664 S	6/2012	Hasegawa
D607,150 S	12/2009	Furuta	D662,665 S	6/2012	Christie
D611,654 S	3/2010	Nakasuka	D662,666 S	6/2012	Christie et al.
D612,102 S	3/2010	Kling et al.	D663,071 S	7/2012	Watson
D612,991 S	3/2010	Cataudella	D663,480 S	7/2012	Watson et al.
D614,352 S	4/2010	Haba	D663,481 S	7/2012	Christie et al.
D614,353 S	4/2010	Christie et al.	D664,712 S	7/2012	Christie et al.
D614,354 S	4/2010	Christie et al.	D664,713 S	7/2012	Christie et al.
D614,809 S	4/2010	Bae	D664,714 S	7/2012	Christie et al.
D614,810 S	4/2010	Rhoad	D664,715 S	7/2012	Wain et al.
D614,811 S	4/2010	Rhoad	D665,129 S	8/2012	Wilby
D615,245 S	5/2010	Lukan	D668,816 S	10/2012	Psimadas et al.
D615,246 S	5/2010	Rhoad	D668,817 S	10/2012	Psimadas et al.
D615,247 S	5/2010	Lukan	D669,219 S	10/2012	Otsuka
D615,248 S	5/2010	Rhoad	D669,220 S	10/2012	Otsuka
D615,704 S	5/2010	Wonderley et al.	D669,221 S	10/2012	Otsuka
D615,705 S	5/2010	Ramm	D670,028 S	10/2012	Watson et al.
D615,706 S	5/2010	Lukan	D670,029 S	10/2012	Hasegawa
D615,707 S	5/2010	Lukan	D671,684 S	11/2012	Wilby et al.
D615,708 S	5/2010	Lukan	D673,730 S	1/2013	Watson et al.
D616,607 S	5/2010	Ramm et al.	D674,137 S	1/2013	Wilby et al.
D617,950 S	6/2010	Christie et al.	D674,138 S	1/2013	Watson et al.
D618,851 S	6/2010	Christie et al.	D674,139 S	1/2013	Watson et al.
D618,852 S	6/2010	Christie et al.	D674,140 S	1/2013	Watson et al.
D618,853 S	6/2010	Christie et al.	D674,141 S	1/2013	Watson et al.
D619,302 S	7/2010	Ramm	D674,142 S	1/2013	Watson et al.
D619,764 S	7/2010	Rhoad	D674,545 S	1/2013	Barrow et al.
D619,765 S	7/2010	Rhoad	D674,546 S	1/2013	Barrow et al.
D620,197 S	7/2010	Micinilio	D674,547 S	1/2013	Barrow et al.
D621,095 S	8/2010	Cataudella	D674,548 S	1/2013	Barrow et al.
D622,905 S	8/2010	Wain	D674,549 S	1/2013	Barrow et al.
D624,243 S	9/2010	Rhoad	D674,551 S	1/2013	Barrow et al.
D624,699 S	9/2010	Micinilio	D674,552 S	1/2013	Barrow et al.
D624,700 S	9/2010	Jung	D674,553 S	1/2013	Barrow et al.
D624,701 S	9/2010	Jung	D679,054 S	3/2013	Christie et al.
D625,468 S	10/2010	Rhoad	D686,368 S	7/2013	Christie et al.
D625,882 S	10/2010	Wonderley et al.	D694,469 S	11/2013	Floyd et al.
D627,929 S	11/2010	Haba	D694,470 S	11/2013	Floyd et al.
D632,433 S	2/2011	Nakasuka	D694,471 S	11/2013	Floyd et al.
D633,252 S	2/2011	Wonderley	D695,457 S	12/2013	Watson
D634,894 S	3/2011	Cataudella	D695,458 S	12/2013	Ramm
D635,302 S	3/2011	Psimadas et al.	D699,000 S	2/2014	Bae
D635,716 S	4/2011	Rhoad	D699,394 S	2/2014	Woon
D635,718 S	4/2011	White, Jr. et al.	D699,395 S	2/2014	Bae
D636,533 S	4/2011	Andersen et al.	D699,396 S	2/2014	Hasegawa
D636,937 S	4/2011	Furuta	D703,377 S	4/2014	Christie et al.
D636,938 S	4/2011	White, Jr. et al.	D704,887 S	5/2014	Wilby et al.
D638,580 S	5/2011	Adams et al.	D708,786 S	7/2014	Micinilio
D640,004 S	6/2011	Wonderley et al.	D714,492 S	9/2014	Cataudella et al.
D640,414 S	6/2011	Wonderley et al.	D724,269 S	3/2015	Szczepanowski et al.
D640,416 S	6/2011	Watson	D724,270 S	3/2015	Sims et al.
D640,830 S	6/2011	Watson et al.	D725,824 S	3/2015	Sims et al.
D640,831 S	6/2011	Watson	D728,857 S	5/2015	Nish
D641,104 S	7/2011	Watson et al.	D729,452 S	5/2015	Griffin et al.
D644,789 S	9/2011	Lukan et al.	D729,453 S	5/2015	Provost et al.
			D729,454 S	5/2015	Provost et al.
			D729,545 S	5/2015	Blumenthal
			D730,577 S	5/2015	Mahony et al.
			D730,579 S	5/2015	Han

(56)

**References Cited**

U.S. PATENT DOCUMENTS

D731,119	S	6/2015	Daniel et al.	
D731,120	S	6/2015	Otsuka	
D731,709	S	6/2015	Provost et al.	
D736,466	S	8/2015	Cataudella et al.	
D738,041	S	9/2015	Ochiai	
D739,604	S	9/2015	Christie et al.	
D739,605	S	9/2015	Christie et al.	
D739,980	S	9/2015	Psimadas et al.	
D745,215	S	12/2015	Go	
D749,264	S	2/2016	Leatherman et al.	
D749,266	S	2/2016	Go	
D749,267	S	2/2016	Leatherman	
D749,784	S	2/2016	Go	
D750,324	S	2/2016	Bae	
D768,929	S *	10/2016	Go .....	D28/48
D773,734	S *	12/2016	Li .....	D28/48
2006/0218804	A1 *	10/2006	Noble .....	B26B 21/526 30/440
2006/0260131	A1 *	11/2006	Follo .....	B26B 21/225 30/50
2013/0081291	A1 *	4/2013	Wain .....	B26B 21/225 30/531

\* cited by examiner

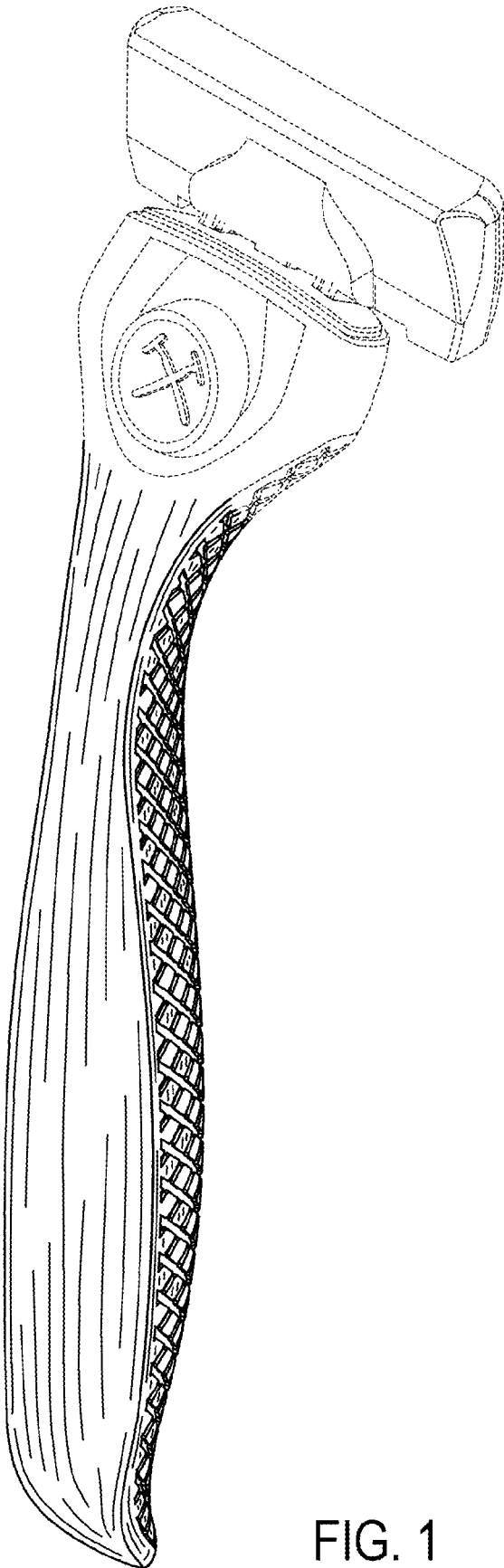

FIG. 1

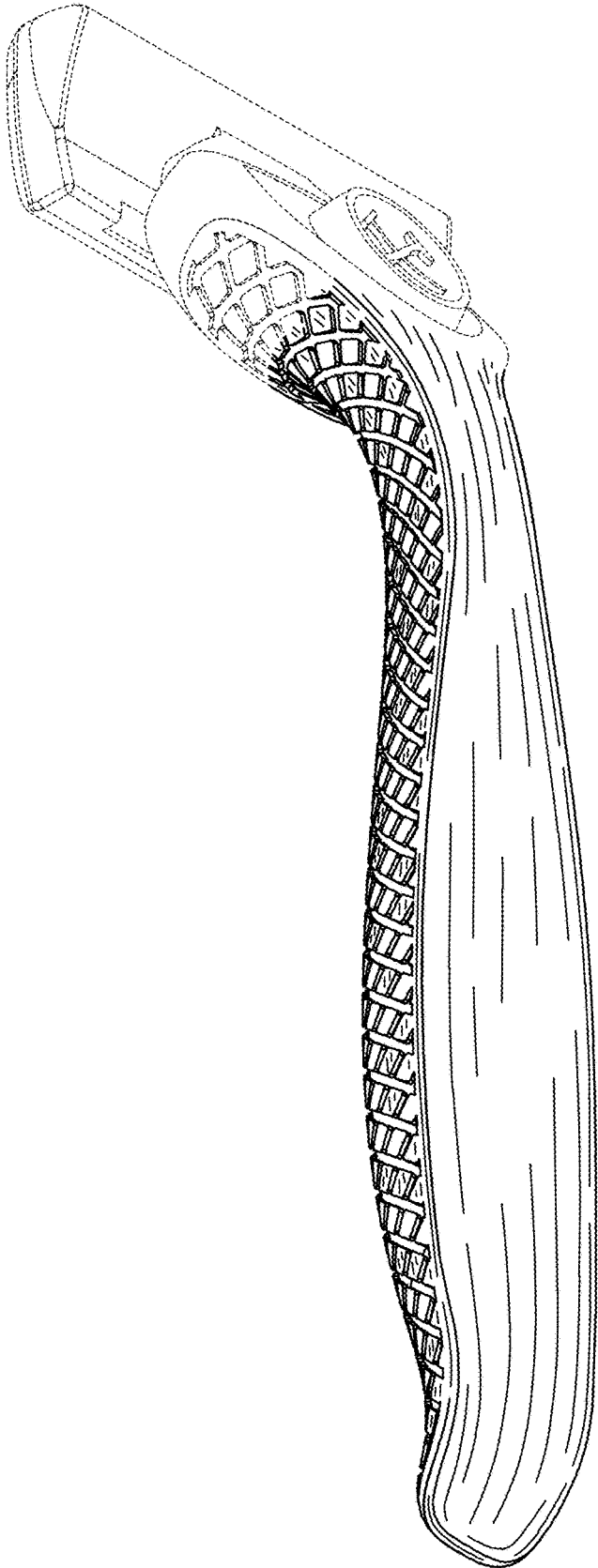

FIG. 2

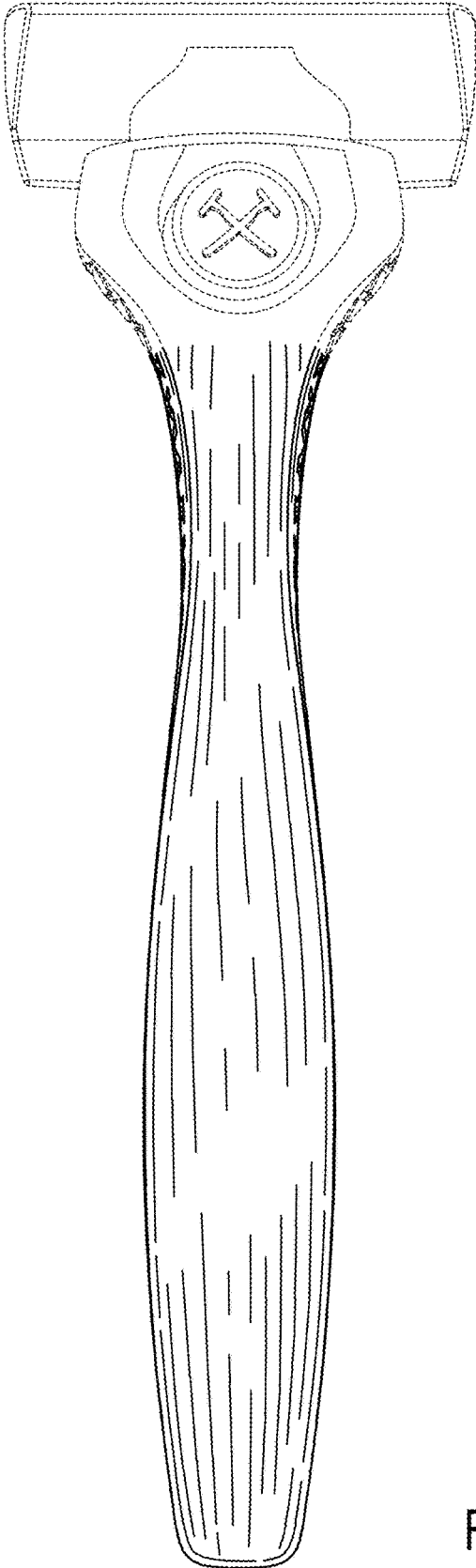

FIG. 3

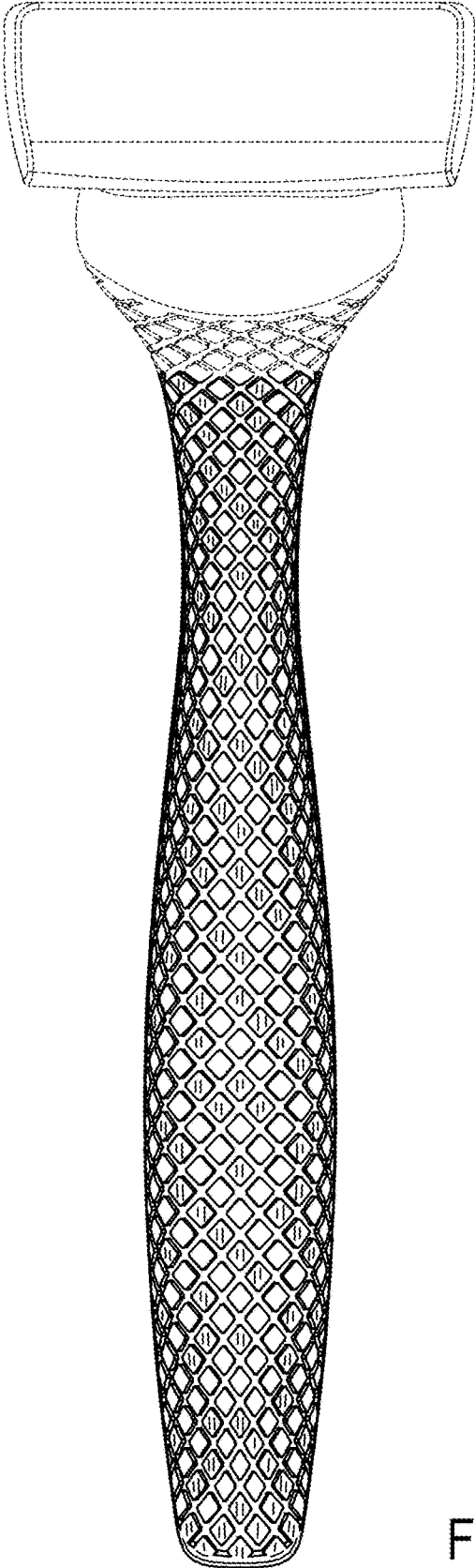

FIG. 4



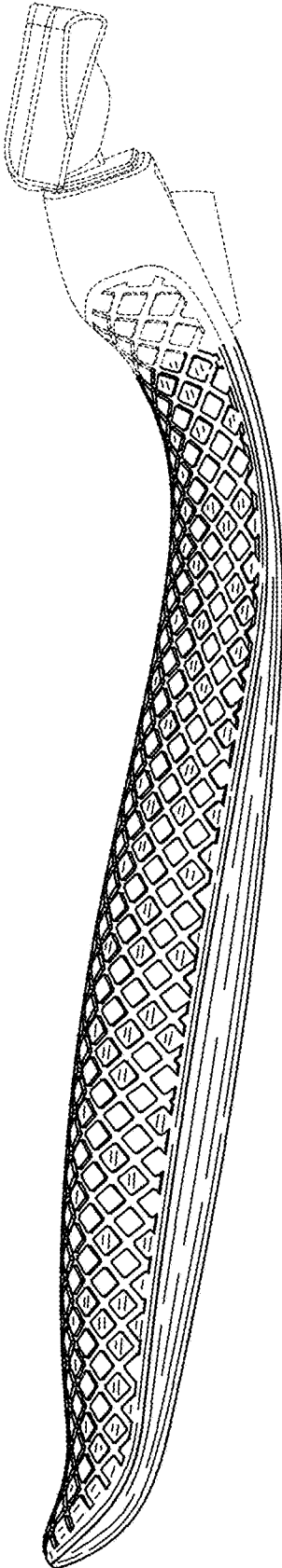

FIG. 5

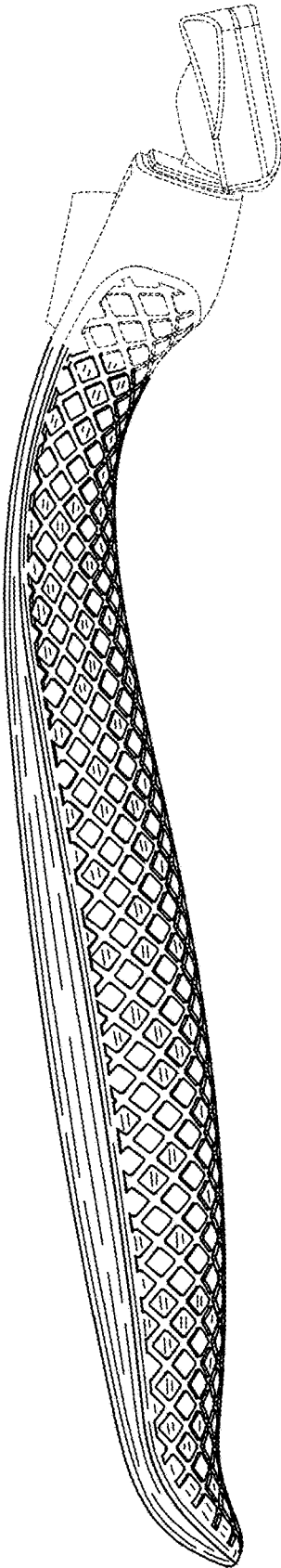

FIG. 6

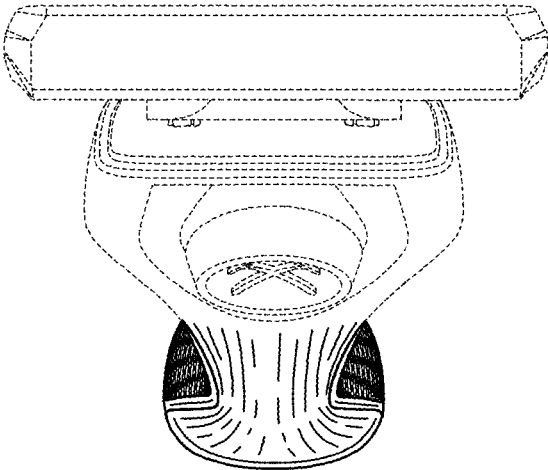

FIG. 7

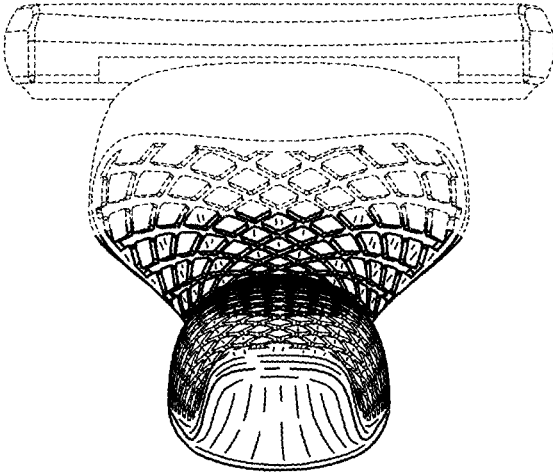

FIG. 8