

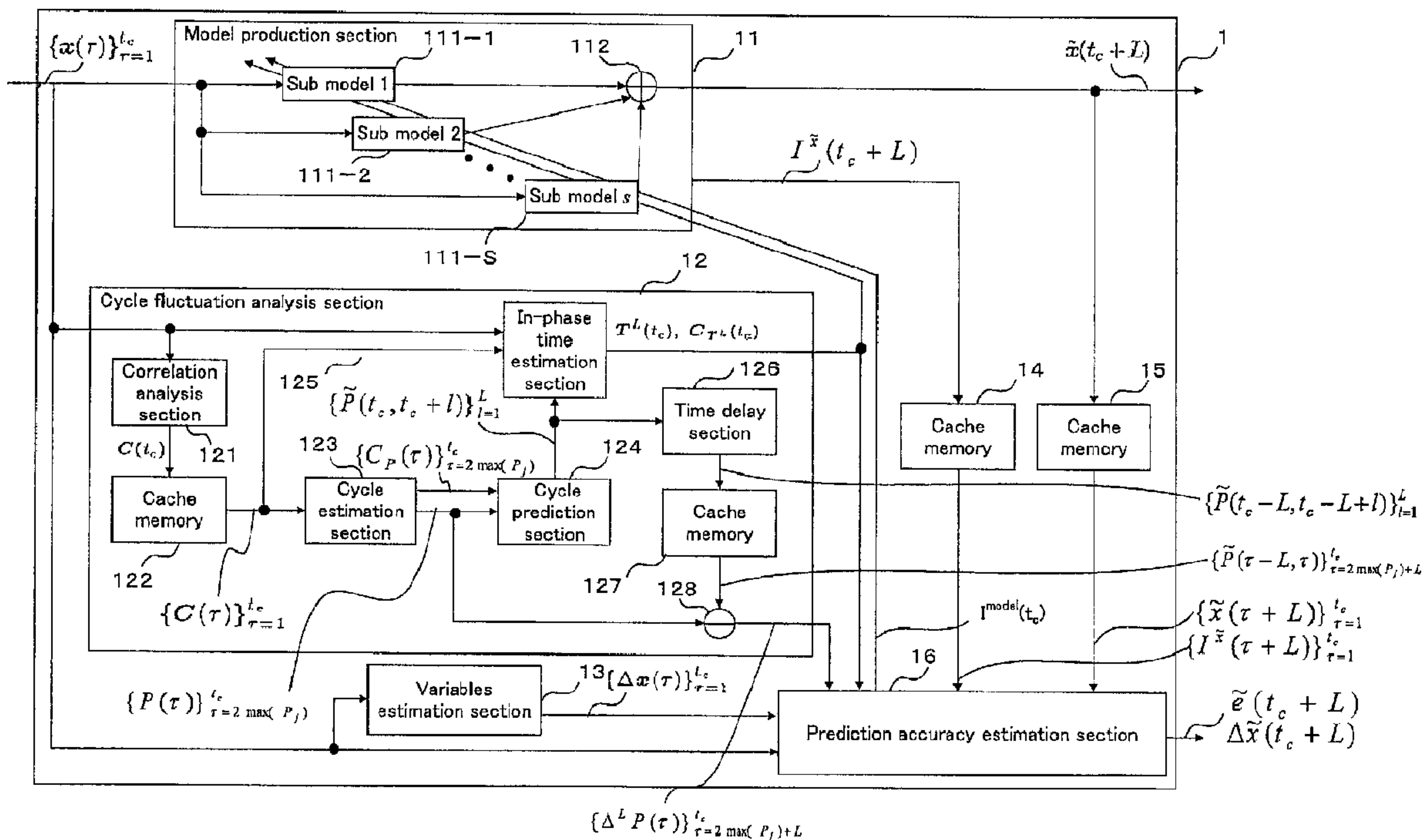

(86) **Date de dépôt PCT/PCT Filing Date:** 2009/11/19
 (87) **Date publication PCT/PCT Publication Date:** 2010/05/27
 (45) **Date de délivrance/Issue Date:** 2017/04/25
 (85) **Entrée phase nationale/National Entry:** 2011/05/17
 (86) **N° demande PCT/PCT Application No.:** JP 2009/069992
 (87) **N° publication PCT/PCT Publication No.:** 2010/058863
 (30) **Priorité/Priority:** 2008/11/21 (JP2008-298634)

(51) **Cl.Int./Int.Cl. A61N 5/10** (2006.01),
G06F 17/10 (2006.01), **G06F 17/15** (2006.01)
 (72) **Inventeurs/Inventors:**
 TAKAI, YOSHIHIRO, JP;
 HOMMA, NORIYASU, JP;
 SAKAI, MASAO, JP
 (73) **Propriétaire/Owner:**
 TOHOKU UNIVERSITY, JP
 (74) **Agent:** FETHERSTONHAUGH & CO.

(54) **Titre : DISPOSITIF DE TRAITEMENT DE SIGNAL, PROCÉDE DE TRAITEMENT DE SIGNAL, PROGRAMME DE TRAITEMENT DE SIGNAL, SUPPORT D'ENREGISTREMENT LISIBLE PAR ORDINATEUR SUR LEQUEL EST ENREGISTRE UN PROGRAMME DE TRAITEMENT DE SIGNAL, ET DISPOSITIF DE RADIOTHERAPIE**
 (54) **Title: SIGNAL PROCESSING APPARATUS, SIGNAL PROCESSING METHOD, SIGNAL PROCESSING PROGRAM, COMPUTER-READABLE RECORDING MEDIUM STORING SIGNAL PROCESSING PROGRAM, AND RADIOTHERAPY APPARATUS**



(57) **Abrégé/Abstract:**

A certain component of an input time series signal (hereinafter referred to as input) is assumed as a cycle time-variable time series signal and correlation analysis between part of the input and the input is carried out, and cycle fluctuation of the input and reliability of the cycle fluctuation are estimated using a result of the correlation analysis and a cycle of the input after predetermined time passes is predicted using the cycle fluctuation and the reliability. In-phase time information whose phase is same as that of the input after the predetermined time and which is time of the input and the reliability of the information are calculated using a result of the correlation analysis and the predicted cycle, and model design information for predicting a value of the input after the predetermined time and accuracy of prediction by the model design information are estimated using the input, time series

(57) Abrégé(suite)/Abstract(continued):

information of a variation of the input per unit time, in-phase time information and reliability of the information. A prediction model for predicting a value of the input after the predetermined time is produced using the input, in-phase time information and reliability of the information, and model design information, and the value of the input after the predetermined time is predicted and outputted using the prediction model.

ABSTRACT

A certain component of an input time series signal (hereinafter referred to as input) is assumed as a cycle time-variable time series signal and correlation analysis between part of the input and the input is carried out, and cycle fluctuation of the input and reliability of the cycle fluctuation are estimated using a result of the correlation analysis and a cycle of the input after predetermined time passes is predicted using the cycle fluctuation and the reliability. In-phase time information whose phase is same as that of the input after the predetermined time and which is time of the input and the reliability of the information are calculated using a result of the correlation analysis and the predicted cycle, and model design information for predicting a value of the input after the predetermined time and accuracy of prediction by the model design information are estimated using the input, time series information of a variation of the input per unit time, in-phase time information and reliability of the information. A prediction model for predicting a value of the input after the predetermined time is produced using the input, in-phase time information and reliability of the information, and model design information, and the value of the input after the predetermined time is predicted and outputted using the prediction model.

WO 2010/058863 A1 

(AT, BE, BG, CH, CY, CZ, DE, DK, EE, ES, FI, FR, GB, GR, HR, HU, IE, IS, IT, LT, LU, LV, MC, MK, MT, NL, NO, PL, PT, RO, SE, SI, SK, SM, TR), OAPI (BF, BJ, CF, CG, CI, CM, GA, GN, GQ, GW, ML, MR, NE, SN, TD, TG).

添付公開書類:

— 国際調査報告 (条約第 21 条(3))

入力時系列信号 (以下、入力という) の或る成分を周期時変の時系列信号と仮定し、前記入力の一部と前記入力との相関解析を行ない、前記相関解析の結果を用いて、該入力の周期変動及びその信頼度を推定し、これらを用いて該入力の所定時間後までの周期を予測し、前記相関解析の結果と該予測周期とを用いて、該入力の該所定時間後の位相と同位相となる該入力の時刻である同位相時刻情報及びその信頼度とを算出し、該入力と、該入力の単位時間当たりの変化量の時系列情報と、該同位相時刻情報及びその信頼度とを用いて、該入力の該所定時間後の値を予測するモデル設計情報と、該モデル設計情報による予測の精度とを推定し、該入力と、該同位相時刻情報及びその信頼度と、該モデル設計情報とを用いて、該入力の該所定時間後の値を予測する予測モデルを作成し、該予測モデルを用いて該入力の該所定時間後の値を予測して出力する。

DESCRIPTION

SIGNAL PROCESSING APPARATUS, SIGNAL PROCESSING METHOD,
SIGNAL PROCESSING PROGRAM, COMPUTER-READABLE RECORDING
5 MEDIUM STORING SIGNAL PROCESSING PROGRAM, AND RADIO THERAPY
APPARATUS

Technical Field

[0001] The present invention relates to a signal
10 processing apparatus, a signal processing method, and a
signal processing program, a computer-readable recording
medium storing the signal processing program, and a
radiotherapy apparatus. The radiotherapy apparatus
includes, for example, a radiotherapy apparatus for
15 accurately irradiating a radiation upon a position of an
affected area of a patient.

Background Art

[0002] A radiotherapy apparatus for irradiating a
20 radiation (for example, an ion beam such as a proton beam
or a heavy particle beam or an X-ray or the like) upon
an affected area (for example, a tumor or the like) of
a patient to perform medical treatment is known.

In the case where a radiation is irradiated upon
25 an affected area of a patient by the radiotherapy apparatus,
for example, the position or the shape of the affected
area is sometimes fluctuated by breath of the patient.

A method is available wherein, taking the foregoing into consideration, in order to irradiate a radiation upon an affected area organization while suppressing an influence of the radiation on a normal organization of the patient, the radiation is intermittently irradiated only in the case where an affected area organization is moved to an irradiation position of the radiation.

[0003] However, since the time of medical treatment is prolonged by such a method as just described, a heavy burden is imposed on the patient. Further, where the sum total of the energy amount of an irradiated radiation is equal, generally since the effect of medical treatment increases as the irradiation time decreases, the method described above has the possibility that a biological effect (medical treatment effect) may decrease.

Therefore, a method is known that, by predicting the movement of the affected area position, the irradiation position of a radiation is moved to follow up the affected area position to irradiate a radiation.

[0004] It is to be noted that, as an existing technique relating to a radiotherapy apparatus, a method of controlling the irradiation timing for radiosopic image capture and a startup timing of a medical treatment radiation to acquire a radiosopic image in which a subtle shading difference is secured, another method of predicting the most likely certain affected area position at a point of time of medical treatment radiation

irradiation based on time series data to accurately and securely irradiate a radiation upon the affected area, and a further method of comparing an acquired radioscopic image of an irradiation target with a reference image
5 regarding a specific evaluation factor to carry out irradiation control with high reliability for an irradiation target and so forth are known.

Prior Art Document

10 Patent Document

[0005] Patent Document 1: Japanese Laid-Open Patent Publication No. 2006-51199

Disclosure of the Invention

15 Subject to Be Solved by the Invention

[0006] In the conventional method described above, for example, prediction is carried out by simply applying an autoregressive model to an input time series signal obtained from an observation signal of an affected area
20 position used as an input. Such prediction as just described is used, for example, when the affected area position after a very short period of time (for example, approximately 0.15 seconds) is predicted.

Further, in the method described above, in order
25 to move the irradiation position of a radiation to follow up the affected area position, for example, the shape and the size of a passage window of a collimator for forming

an irradiation range of a radiation are controlled.

[0007] However, there is the possibility that, if the
time required for control of a collimator becomes long,
then the shape and the size of the collimator cannot be
5 controlled to the desired shape and size within a period
of prediction time assumed for an autoregressive model,
and as a result, irradiation following up the movement
of an affected area position cannot be implemented.

The present invention has been made in view of such
10 a subject as described above, and it is an object of the
present invention to accurately predict an input time
series signal of an affected area position over a longer
period of time.

[0008] It is to be noted that, in addition to the object
15 described above, also it can be positioned as an object
to achieve such effects as are provided by the constitutions
of embodiments hereinafter described but are not provided
by the conventional techniques.

20 Means for Solving the Subject

[0009] For example, the following measures are used.

(1) A signal processing apparatus comprising a
cycle fluctuation analysis section adapted to assume a
certain component of an input time series signal as a time
25 series signal whose cycle varies with respect to time to
carry out a correlation analysis between part of the input
time series signal and the input time series signal,

estimate a cycle fluctuation of the input time series signal
and reliability of the cycle fluctuation using a result
of the correlation analysis, predict a cycle of the input
time series signal after predetermined time using the cycle
5 fluctuation and the reliability of the cycle fluctuation
and calculate, using the result of the correlation analysis
and the predicted cycle, in-phase time information which
represents time of the input time series signal whose phase
becomes same as a phase of the input time series signal
10 after the predetermined time and the reliability of the
in-phase time information, a prediction accuracy
estimation section adapted to estimate model design
information for predicting a value of the input time series
signal after the predetermined time and accuracy of the
15 prediction of the value of the input time series signal
after the predetermined time based on the model design
information using the input time series signal, the time
series information of a variation per unit time of the
input time series signal and the in-phase time information
20 and reliability of the in-phase time information
calculated by the cycle fluctuation analysis section, and
a model production section adapted to produce, using the
input time series signal, the in-phase time information
and the reliability of the in-phase time information
25 calculated by the cycle fluctuation analysis section and
the model design information estimated by the prediction
accuracy estimation section, a prediction model for

predicting the value of the input time series signal after the predetermined time and predict and output the value of the input time series signal after the predetermined time using the prediction model, can be used.

5 [0010] (2) Here, the prediction accuracy estimation section may estimate the model design information using information outputted from the model production section regarding a calculation process of the value of the input time series signal after the predetermined time.

10 (3) The cycle fluctuation analysis section may include a correlation analysis section for carrying out a correlation analysis between part of the input time series signal and the input time series signal, a cycle estimation section for estimating the cycle fluctuation and the
15 reliability of the cycle fluctuation using a result of the analysis by the correlation analysis section, a cycle prediction section for predicting a cycle of the input time series signal after the predetermined time using the cycle fluctuation and the reliability of the cycle
20 fluctuation estimated by the cycle estimation section, and an in-phase time estimation section for estimating the in-phase time information and reliability of the in-phase time information using a result of the correlation analysis by the correlation analysis section and the cycle
25 predicted by the cycle prediction section.

[0011] (4) Further, the model production section may produce the prediction model using a plurality of sub models

whose structures or characteristics are different from each other.

(5) The plurality of sub models may include at least one of a SARIMA (Seasonal Auto-Regressive Integrated Moving Average) model, a seasonal adjustment index smoothing method model, a non-linear ARIMA (Auto-Regressive Integrated Moving Average) model and a soft computing model such as a neural network, fuzzy or the like.

[0012] (6) Further, the model production section may change the sub models using the accuracy of the prediction of the value of the input time series signal after the predetermined time estimated by the prediction accuracy estimation section.

(7) Meanwhile, a signal processing method comprising assuming a certain component of an input time series signal as a time series signal whose cycle varies with respect to time to carry out a correlation analysis between part of the input time series signal and the input time series signal, estimating a cycle fluctuation of the input time series signal and reliability of the cycle fluctuation using a result of the correlation analysis, predicting a cycle of the input time series signal after predetermined time using the cycle fluctuation and the reliability of the cycle fluctuation and calculating, using the result of the correlation analysis and the predicted cycle, in-phase time information which

represents time of the input time series signal whose phase becomes same as a phase of the input time series signal after the predetermined time and the reliability of the in-phase time information, estimating model design information for predicting a value of the input time series signal after the predetermined time and accuracy of the prediction of the value of the input time series signal after the predetermined time based on the model design information using the input time series signal, the time series information of a variation per unit time of the input time series signal and the calculated in-phase time information and reliability of the in-phase time information, and producing, using the input time series signal, the calculated in-phase time information and reliability of the in-phase time information and the estimated model design information, a prediction model for predicting the value of the input time series signal after the predetermined time and predicting and outputting the value of the input time series signal after the predetermined time using the prediction model can be used.

[0013] (8) Further, a radiotherapy apparatus for irradiating a radiation on an affected area of a patient, comprising a radiation generation section adapted to generate the radiation, a collimator section adapted to form an irradiation range of the radiation generated from the radiation generation section into a desired shape, a measurement section adapted to measure a position of

the affected area, the signal processing apparatus described above adapted to estimate prediction of a position of the affected area after predetermined time and accuracy information of the prediction position using
5 an input time series signal regarding the position of the affected area measured by the measurement section, and a driving controlling section adapted to calculate, using the position of the affected area after the predetermined time and the accuracy information predicted by the signal
10 processing apparatus, an irradiation position and an irradiation range of the radiation and control and drive the collimator section based on a result of the calculation can be used.

[0014] (9) Meanwhile, the radiotherapy apparatus
15 described above may further comprise a timing controlling section adapted to control a generation timing of the radiation by the radiation generation section using the position of the affected area after the predetermined time and the accuracy information predicted by the signal
20 processing apparatus.

(10) Further, a radiotherapy apparatus for irradiating a radiation on an affected area of a patient can be used, comprising a radiation generation section adapted to generate the radiation, a measurement section
25 adapted to measure a position of the affected area, the signal processing apparatus described above adapted to estimate prediction of a position of the affected area

after predetermined time and accuracy information of the predicted position using an input time series signal regarding the position of the affected area measured by the measurement section, and a controlling section adapted to control an irradiation timing of the radiation by the radiation generation section using the position of the affected area after the predetermined time and the accuracy information predicted by the signal processing apparatus.

[0015] (11) Further, a signal processing program for causing, in a signal processing apparatus for predicting a value of an input time series signal after predetermined time, a computer to implement a prediction function can be used, the signal processing program causing a computer to implement a cycle fluctuation analysis function for assuming a certain component of an input time series signal as a time series signal whose cycle varies with respect to time to carry out a correlation analysis between part of the input time series signal and the input time series signal, estimating a cycle fluctuation of the input time series signal and reliability of the cycle fluctuation using a result of the correlation analysis, predicting a cycle of the input time series signal after predetermined time using the cycle fluctuation and the reliability of the cycle fluctuation and calculating, using the result of the correlation analysis and the predicted cycle, in-phase time information which represents time of the input time series signal whose phase becomes same as a

phase of the input time series signal after the predetermined time and the reliability of the in-phase time information, a prediction accuracy estimation function for estimating model design information for predicting a value of the input time series signal after the predetermined time and accuracy of the prediction of the value of the input time series signal after the predetermined time based on the model design information using the input time series signal, the time series information of a variation per unit time of the input time series signal and the in-phase time information and reliability of the in-phase time information calculated by the cycle fluctuation analysis function, and a model production function for producing, using the input time series signal, the in-phase time information and the reliability of the in-phase time information calculated by the cycle fluctuation analysis function and the model design information estimated by the prediction accuracy estimation function, a prediction model for predicting the value of the input time series signal after the predetermined time and predicting and outputting the value of the input time series signal after the predetermined time using the prediction model, can be used.

[0016] (12) Furthermore, a computer-readable recording medium storing a signal processing program for causing, in a signal processing apparatus for predicting a value of an input time series signal after predetermined

time, a computer to implement a prediction function is recorded can be used, the signal processing program causing the computer to implement a cycle fluctuation analysis function for assuming a certain component of an input time series signal as a time series signal whose cycle varies with respect to time to carry out a correlation analysis between part of the input time series signal and the input time series signal, estimating a cycle fluctuation of the input time series signal and reliability of the cycle fluctuation using a result of the correlation analysis, predicting a cycle of the input time series signal after predetermined time using the cycle fluctuation and the reliability of the cycle fluctuation and calculating, using the result of the correlation analysis and the predicted cycle, in-phase time information which represents time of the input time series signal whose phase becomes same as a phase of the input time series signal after the predetermined time and the reliability of the in-phase time information, a prediction accuracy estimation function for estimating model design information for predicting a value of the input time series signal after the predetermined time and accuracy of the prediction of the value of the input time series signal after the predetermined time based on the model design information using the input time series signal, the time series information of a variation per unit time of the input time series signal and the in-phase time information

31918-1

and reliability of the in-phase time information calculated by the cycle fluctuation analysis function, and a model production function for producing, using the input time series signal, the in-phase time information and the reliability of the in-phase
5 time information calculated by the cycle fluctuation analysis function and the model design information estimated by the prediction accuracy estimation function, a prediction model for predicting the value of the input time series signal after the predetermined time and predicting and outputting the value of
10 the input time series signal after the predetermined time using the prediction model, can be used.

[0016a] According to one aspect of the present invention, there is provided a radiotherapy apparatus for irradiating a radiation on an affected area of a patient, the radiotherapy
15 apparatus comprising: a radiation generation section adapted to generate the radiation; a measurement section adapted to measure a position of the affected area; and a signal processing apparatus, comprising: a cycle fluctuation analysis section adapted to assume an input time series signal, which
20 represents values at respective time points until a first time point, as a time series signal whose cycle length, which is a length of a cycle, varies with respect to time to carry out a correlation analysis between part of the input time series signal and the input time series signal, calculate multiple
25 cycle lengths, which are respectively at different time points, as a cycle length fluctuation of the input time series signal and reliability of the cycle length fluctuation using a result of the correlation analysis, predict a cycle length of the time series signal until a second time point after the first time
30 point using the cycle length fluctuation and the reliability of the cycle length fluctuation and calculate, using the result of

31918-1

the correlation analysis and the predicted cycle length, in-phase time information, which represents a time point before the second time point in the input time series signal, and reliability of the in-phase time information, a phase at the time point in the input time series signal becoming same as a phase at the second time point in the time series signal; a prediction accuracy estimation section adapted to estimate model design information for predicting a value of the time series signal at the second time point and accuracy of the prediction of the value of the time series signal at the second time point using the input time series signal, the time series information of a variation per unit time of the value and the in-phase time information and the reliability of the in-phase time information calculated by said cycle fluctuation analysis section, the accuracy being based on the estimated model design information; and a model production section adapted to produce, using the input time series signal, the in-phase time information and the reliability of the in-phase time information calculated by said cycle fluctuation analysis section and the model design information estimated by said prediction accuracy estimation section, a prediction model for predicting the value of the time series signal at the second time point and predict and output the value of the time series signal at the second time point using the prediction model, wherein said signal processing apparatus is adapted to predict a position of the affected area at the second time point and estimate accuracy information of the prediction position using, as the input time series signal, a time series signal regarding the position of the affected area measured by said measurement section, and the radiotherapy apparatus comprises a controlling section adapted to control an irradiation of the generated

31918-1

radiation from said radiation generation section using the position, which is predicted by said signal processing apparatus, of the affected area at the second time point.

[0016b] According to yet another aspect of the present invention, there is provided a non-transitory computer-readable recording medium storing a signal processing program for causing, in a radio radiotherapy apparatus for irradiating a radiation on an affected area of a patient comprising a radiation generation section for generating the radiation, a measurement section for measuring a position of the affected area, and a signal processing apparatus for predicting a value of a time series signal at a second time point after a first time point, a computer to implement a prediction function that is stored, the signal processing program causing the computer to implement: a cycle fluctuation analysis function for assuming an input time series signal, which represents values at respective time points until the first time point, as the time series signal whose cycle length, which is a length of a cycle, varies with respect to time to carry out a correlation analysis between part of the input time series signal and the input time series signal, calculating multiple cycle lengths, which are respectively at different time points, as a cycle length fluctuation of the input time series signal and reliability of the cycle length fluctuation using a result of the correlation analysis, predicting a cycle length of the time series signal until the second time point using the cycle length fluctuation and the reliability of the cycle length fluctuation and calculating, using the result of the correlation analysis and the predicted cycle length, in-phase time information, which represents a time point before the second time point in the input time series signal, and

31918-1

reliability of the in-phase time information, a phase at the time point in the input time series signal becoming same as a phase at the second time point in the time series signal; a prediction accuracy estimation function for estimating model design information for predicting a value of the time series signal at the second time point and accuracy of the prediction of the value of the time series signal at the second time point using the input time series signal, the time series information of a variation per unit time of the value and the in-phase time information and the reliability of the in-phase time information calculated by said cycle fluctuation analysis function, the accuracy being based on the estimated model design information; and a model production function for producing, using the input time series signal, the in-phase time information and the reliability of the in-phase time information calculated by said cycle fluctuation analysis function and the model design information estimated by said prediction accuracy estimation function, a prediction model for predicting the value of the time series signal at the second time point and predicting and outputting the value of the time series signal at the second time point using the prediction model, wherein said signal processing apparatus is adapted to predict a position of the affected area at the second time point and estimate accuracy information of the prediction position using, as the input time series signal, a time series signal regarding the position of the affected area measured by said measurement section, and the radiotherapy apparatus comprises a controlling section adapted to control an irradiation of the generated radiation from said radiation generation section using the position, which is predicted by

31918-1

said signal processing apparatus, of the affected area at the second time point.

Effect of the Invention

[0017] With the present invention, information of an input
5 time series signal in the future can be predicted accurately and
for a medium and long term. Further, in the radiotherapy, accurate
and continuous irradiation on an affected area can be achieved.

Brief Description of the Drawings

[0018] [FIG. 1] FIG. 1 is a view showing an outline of a
10 radiotherapy apparatus.

[FIG. 2] FIG. 2 is a functional block diagram of the
radiotherapy apparatus shown in FIG. 1.

[FIG. 3] FIG. 3(A) is a view showing an appearance of
an MLC 210 and FIG. 3(B) is a view showing an example

of a configuration of the MLC 210.

[FIG. 4] FIG. 4 is a view showing an example of a configuration of an OBI 220.

[FIG. 5] FIG. 5 is a view showing an example of a
5 configuration of a control section 1.

[FIG. 6] FIGS. 6(A) to 6(C) are views showing an example of operation of a cycle fluctuation analysis section 12.

[FIG. 7] FIGS. 7(A) to 7(D) are views showing an
10 example of operation of a correlation analysis section 121.

[FIG. 8] FIGS. 8(A) to 8(C) are views showing an example of operation of a cycle estimation section 123.

[FIG. 9] FIG. 9 is a view showing an example of
15 operation of a cycle prediction section 124.

[FIG. 10] FIGS. 10(A) to 10(D) are views showing an example of operation of an in-phase time estimation section 125.

[FIG. 11] FIGS. 11(A) and 11(B) are views showing
20 an example of operation of a model production section 11.

[FIG. 12] FIGS. 12(A) and 12(B) are views showing an example of operation of a prediction accuracy estimation section 16.

[FIG. 13] FIG. 13 is a view showing a
25 three-dimensional plot of a predetermined observation position of an affected area 260.

[FIG. 14] FIG. 14 is a view showing axial components

of the three-dimensional plot shown in FIG. 13.

[FIG. 15] FIG. 15 is a view showing actual measurement values of a target time series on sub models regarding the axial components shown in FIG. 14 and
5 prediction values for the actual measurement values.

[FIG. 16] FIG. 16(A) is a view showing actual measurement values and prediction values of the axial components shown in FIG. 14 and FIGS. 16(B) and 16(C) are views showing prediction accuracy estimation information
10 by the prediction accuracy estimation section 16.

[FIG. 17] FIG. 17 is a view showing actual measurement values of the signal components regarding the axial components shown in FIG. 14 and the prediction values by a conventional method.

15 [FIG. 18] FIG. 18 is a view showing a comparison result between a prediction method of the present example and the conventional prediction method.

[FIG. 19] FIG. 19 is a flow chart illustrating an example of a prediction method of the present example.

20 [FIG. 20] FIG. 20 is a flow chart illustrating another example of the prediction method of the present example.

[FIG. 21] FIG. 21 is a flow chart illustrating a further example of the prediction method of the present
25 example.

[FIG. 22] FIG. 22 is a flow chart illustrating a still further example of the prediction method of the

present example.

[FIG. 23] FIG. 23 is a flow chart illustrating a yet further example of the prediction method of the present example.

5 [FIG. 24] FIG. 24 is a flow chart illustrating a yet further example of the prediction method of the present example.

[FIG. 25] FIG. 25 is a flow chart illustrating a yet further example of the prediction method of the present
10 example.

[FIG. 26] FIG. 26 is a flow chart illustrating a yet further example of the prediction method of the present example.

[FIG. 27] FIG. 27 is a flow chart illustrating a
15 yet further example of the prediction method of the present example.

[FIG. 28] FIG. 28 is a flow chart illustrating a yet further example of the prediction method of the present example.

20 [FIG. 29] FIG. 29 is a view illustrating a seasonal component of a fixed cycle.

[FIG. 30] FIG. 30 is a view illustrating a seasonal component whose cycle fluctuates.

[FIG. 31] FIG. 31 is a view showing an example of
25 a comparison result between the prediction method of the present example and the conventional prediction method.

Mode for Carrying out the Disclosure

[0019] In the following, an embodiment is described with reference to the drawings. However, the embodiment hereinafter described is illustrative to the end, and there
5 is no intention to eliminate various modifications and applications of the technique not specified by the embodiment hereinafter described. In particular, the present embodiment can be carried out by various variations by combination of different embodiments without departing
10 from the scope of the present example.

[0020] [1] First Embodiment

(1.1) Apparatus Outline

An outline of a radiotherapy apparatus is shown in FIG. 1. The radiotherapy apparatus shown in FIG. 1
15 includes, for example, a control section 1, a klystron 100, a cooling apparatus 110, a waveguide 120, a vacuum pump 130, electrons gun 140, an accelerating tube 150, a bending magnet 160, a target 170 and a smoothing filter (scattering filter) 180. Further, the radiotherapy
20 apparatus shown in FIG. 1 includes, for example, a dosimeter 190, an irradiation field formation section (JAW) 200, an MLC (Multi Leaf Collimator) 210, an OBI (On-Board Imager) 220, a bed 230, an EPID (Electronic Portal Imaging Device) 240 and a pulse modulator 250.

25 [0021] In the present embodiment, for example, the control section 1 predicts position information of an affected area 260 after predetermined time from position

information (a position, a shape, a size and so forth) of the affected portion 260 measured by the OBI 220. Then, the control section 1 drives and controls, for example, the MLC 210 based on a result of the prediction to implement
5 radiation irradiation in response to the position, shape, size and so forth of the affected area 260 after the predetermined time.

[0022] To this end, the radiotherapy apparatus shown in FIG. 1 includes functional blocks illustrated in FIG.
10 2.

Here, the pulse modulator 250 is a voltage generator for generating a pulse voltage. The pulse modulator 250 in the present embodiment generates a predetermined pulse voltage taking, for example, an input of a trigger pulse
15 from a trigger pulse generator (not shown) as an opportunity.

The klystron 100 is an electronic tube for utilizing an interaction between electron beam and a high frequency wave to amplify the high frequency wave to output a microwave
20 having high power. The klystron 100 of the present example generates electron beam, for example, in response to the pulse voltage received from the pulse modulator 250 and carries out speed modulation for the electron beam and then outputs the electron beam from a gap so that microwave
25 pulse power to be used as energy for accelerating electrons in the accelerating tube 150 is outputted.

[0023] The cooling apparatus 110 includes a function

for cooling the klystron 100. As a cooling method, for example, a method is available in which a cavity is provided between an armor section which covers a main body section of the klystron 100 and the main body section and cooling
5 water is supplied to the cavity to carry out cooling.

The waveguide 120 transmits microwave pulse power outputted from the klystron 100 to the accelerating tube 150. For example, while a hollow waveguide can be used for the waveguide 120, also a coaxial cable for which a
10 dielectric such as Teflon (registered trademark) is used can be used.

[0024] The vacuum pump 130 is a pump for exhausting gas from the inside of a container to form a vacuum state. In the present example, for example, the vacuum state is
15 formed in the proximity of electron beam emitting portion of the electron gun 140, in an internal space of the accelerating tube 150 and in the proximity of the bending magnet 160. By maintaining the portions just described in the vacuum state, loss of microwave pulse power outputted
20 from the klystron 100 and energy loss of an electron beam emitted from the electron gun 140 can be reduced. It is to be noted that, for example, while a dry pump whose degree of erosion to the inside of the accelerating tube 150 or the like is low can be used for the vacuum pump 130, also
25 a wet pump for which oil is used can be used.

[0025] The electron gun 140 extracts free electrons from a predetermined metal material or the like to emit

an electron beam. For example, electrons in a solid body are discharged into a space by high heat or a high electric field and the discharged electrons are accelerated by applying an electric field thereto, and the electron beam
5 is converged into a beam by an electron lens and then the converged beam is irradiated. For example, while an electric field emission type electron gun for extracting electrons to a space by a quantum-mechanical tunnel effect can be used for the electron gun 140, also a thermoelectric
10 emission type electron gun for carrying out electron emission by thermal energy or the like can be used.

[0026] The accelerating tube 150 amplifies the energy of the electron beam emitted from the electron gun 140 using the microwave pulse power outputted from the klystron
15 100 and transmitted thereto through the waveguide 120. The electron beam is accelerated by the microwave pulse power and is emitted from the accelerating tube 150.

The bending magnet 160 generates a magnetic field in a predetermined direction to correct the orbit of the
20 electron beam emitted from the accelerating tube 150. The bending magnet 160 of the present example exemplarily uses three bending magnets 160 to correct the orbit of the electron beam, for example, in order to irradiate the electron beam upon the target 170. It is to be noted that
25 the number of the bending magnets 160 is not limited to that of the example shown in FIG. 1.

[0027] The target 170 is a material for irradiating

a radiation by being irradiated by an electron beam.

For example, tungsten (Tg) can be used for the target 170. It is to be noted that a different material may be used if it is a material capable of generating a radiation
5 when it is irradiated by an accelerated electron beam.

In particular, the pulse modulator 250, klystron 100, cooling apparatus 110, waveguide 120, vacuum pump 130, electron gun 140, accelerating tube 150, bending magnet 160 and target 170 function as an example of a
10 radiation generation section for generating a radiation.

[0028] The smoothing filter 180 is a filter for attenuating and smoothing the dose distribution of a radiation irradiated from the target 170. For example, the smoothing filter 180 of the present example attenuates
15 the dose level of the radiation irradiated from the target 170 in accordance with the wavelength to control the dose level of the radiation to a predetermined level (for example, a dose level capable of being irradiated on a human body).

The dosimeter 190 measures the dose level of the
20 radiation. For example, by the dosimeter 190 of the present example, it can be measured and confirmed whether or not the dose level of the radiation after passing through the smoothing filter 180 is attenuated to a predetermined level. Where the dose level of the radiation is not
25 attenuated to the predetermined level, the dose level can be adjusted, for example, by controlling the microwave pulse power in the klystron 100 or the like.

[0029] The JAW 200 is an irradiation field formation member formed from a material for blocking a radiation. The JAW 200 is configured, for example, from a plurality of plate-like members, and, by determining the position
5 of the plate members, part of the radiation irradiated from the target 170 is passed while the other part of the radiation is blocked so that an irradiation field of the radiation is formed roughly. For example, the irradiation field of the radiation can be adjusted such that the
10 radiation falls within a range within which it can be inputted to the MLC 210 positioned at the following stage to the JAW 200.

[0030] The MLC (collimator section) 210 forms the irradiation range of the radiation irradiated from the
15 target 170 into a desired shape. For example, the MLC 210 in the present embodiment can vary the irradiation range of the radiation after passing through the JAW 200 in response to the position of the affected area 260 after the predetermined time predicted by the control section
20 1 and prediction accuracy information.

An example of an appearance and a configuration of the MLC 210 is shown in FIGS. 3(A) and 3(B).

[0031] As illustrated in FIG. 3(A), the MLC 210 is configured including, for example, a plurality of pairs
25 of plate-like members (leaves) which block a radiation. By displacing the leaves in a leftward and rightward direction in the plane of the figure independently of each

other, the leaves cooperate with each other to form the radiation irradiation field [central blank portion in FIG. 3(A)] in a desired shape. The radiation passing through the JAW 200 passes through the MLC 210 in the figure-plane
5 leftward and rightward direction so that the radiation can be irradiated on the affected area 260 within a range conforming to the shape of a radiation irradiation field 304.

[0032] Here, as illustrated in FIG. 3(B), the MLC 210
10 includes a plurality of leaves 303, driving sections 302-1 and 302-2 and a driving controlling section 301.

Each of the leaves 303 is a plate-like member capable of blocking a radiation. In the present example, for example, two leaves 303 opposed to each other are paired
15 with each other, and a plurality of leaf pairs are formed. The leaves 303 are driven independently of each other by the driving sections 302-1 and 302-2. It is to be noted that the number of the leaves 303 is not limited to that of the illustrated example.

[0033] The driving sections 302-1 and 302-2 displace
20 the leaves 303 independently of each other. For example, the driving sections 302-1 and 302-2 drive the leaves 303 by means of a motor provided individually for the leaves 303 so that the leaves 303 are displaced along a leaf moving
25 direction in FIG. 3(B). In the example shown in FIG. 3(B), the leaves 303 on the right side of the plane of the figure are driven by the driving section 302-1 and the leaves

303 on the left side of the plane of the figure are driven by the driving section 302-2. Further, for example, the leaves 303 can be displaced also in an interlocking relationship with each other by the driving sections 302-1 and 302-2. For example, using displacement of a leaf 303 as a trigger, the leaves 303 around the leaf may be displaced in an interlocking relationship with each other.

[0034] The driving controlling section 301 controls the driving sections 302-1 and 302-2 to determine individual positions of the leaves 303. Positioning control is carried out for the leaves 303 independently of each other to individual desired positions so that a radiation irradiation field 304 having a desired shape is formed.

For example, based on a result of the prediction (the prediction position of the affected area 260 after the predetermined time and the prediction accuracy information) by the control section 1, the driving controlling section 301 of the present example controls the driving sections 302-1 and 302-2 to determine the positions of the leaves 303. Consequently, since the radiation irradiation field 304 having a desired shape can be formed in response to the position, shape and size of the affected area 260 after the predetermined time predicted by the control section 1, radiation irradiation suitable for the prediction position, shape, size and so forth of the affected area 260 can be implemented.

[0035] The OBI (measurement section) 220 measures the position of the affected area 260. For example, an X-ray can be irradiated on a measurement target so that position information regarding a position, a shape, a size and so
5 forth of the measurement target can be outputted.

The OBI 220 of the present example calculates observation values (actual measurement values) of a position, a shape, a size and so forth of the affected area 260, for example, based on plural pieces of position
10 information obtained by irradiating an X-ray from various angles on the affected area 260 of a patient. The position information regarding the position, shape, size and so forth of the affected area 260 actually measured by the OBI 220 is inputted to the control section 1 and is used
15 for a prediction process hereinafter described.

[0036] Here, an example of a configuration of the OBI 220 is shown in FIG. 4. As shown in FIG. 4, the OBI 220 includes, for example, an X-ray irradiation section 305 and a sensor panel 306.

20 The X-ray irradiation section 305 irradiates an X-ray on the affected area 260 of a patient on the bed 230. It is to be noted that the X-ray is a kind of a radiation and is an electromagnetic wave whose wavelength is approximately 1 pm to 10 nm.

25 [0037] The sensor panel 306 includes a sensor for detecting an X-ray at the surface thereof and outputs a position coordinate of the irradiated X-ray. For example,

the sensor panel 306 in the present embodiment receives the X-ray after passing through the affected area 260 in an imaging region (Imaging Area) and calculates and outputs a two-dimensional coordinate of the reception position.

5 The X-ray irradiation section 305 and the sensor panel 306 are configured such that they can integrally rotate around the center provided by a rotational axis in FIG. 4, and the sensor panel 306 in the present embodiment calculates a three-dimensional coordinate $P(X, Y, Z)$ of
10 the affected area 260, for example, based on a two-dimensional coordinate $P1(x1, y1)$ of the affected area 260 calculated at a position (position at which an X-ray irradiation axis and the rotational axis form an angle of $+45^\circ$) indicated by reference character A in FIG. 4 and
15 a two-dimensional coordinate $P2(x2, y2)$ of the affected area 260 calculated at a position (position at which the X-ray irradiation axis and the rotational axis form an angle of -45°) denoted by reference character B in FIG. 4.

[0038] For example, where the distance from an
20 irradiation point of the X-ray irradiation section 305 to the affected area 260 is represented as an SAD (source-axis distance) and the distance from the X-ray irradiation point of the X-ray irradiation section 305 to the surface of the sensor panel 306 is represented as
25 an SDD (source-detector distance), the position coordinate $P(X, Y, Z)$ of the affected area 260 is represented by the following expression (1).

[0039]

[Expression 1]

$$\left. \begin{aligned} X &= x_1 y_2 * SAD / (SDD * y_1 + x_1 y_2) \\ Y &= y_1 x_2 * SAD / (SDD * y_2 + y_1 y_2) \\ Z &= y_1 y_2 * SAD / (SDD * y_1 + x_1 y_2) \end{aligned} \right\} \dots (1)$$

[0040] The three-dimensional coordinate P(X, Y, Z)
 5 of the affected area 260 calculated by the expression (1)
 given described is inputted, for example, as an actual
 measurement value (input signal) which indicates the
 present position of the affected area 260 to the control
 section 1, and the control section 1 can predict the
 10 three-dimensional coordinate of the affected area 260
 after the predetermined time using time series information
 of the actual measurement value.

The bed 230 is an equipment for supporting a patient
 so that the affected area 260 is placed at a position and
 15 a height suitable for radiation irradiation. To this end,
 the bed 230 in the present embodiment is configured, for
 example, from a supporting section whose position and
 height can be adjusted, and a mat section.

[0041] The EPID 240 visualizes the position, shape
 20 and size of the affected area 260. For example, the
 position and the height of the bed 230 or the like are
 determined by the operator based on the visualized shape
 and so forth of the affected area 260.

The control section 1 carries out prediction of a

position coordinate of the affected area 260 after the predetermined time and supposition of the prediction accuracy information using time series information of the position coordinate $P(X, Y, Z)$ of the affected area 260
5 obtained by the OBI 220. Further, various controls are carried out using a result of the prediction and the prediction accuracy information. For example, the control section 1 of the present example controls the MLC 210 using the prediction result and the prediction accuracy
10 information to form the radiation irradiation field 304 into a shape corresponding to the position, prediction accuracy information, size, shape and so forth of the affected area 260 after the predetermined time. Consequently, since prediction control for the MLC 210
15 can be carried out before time required for physical driving (positioning) control of the MLC 210, radiation irradiation can be carried out following up the position of the affected area 260.

[0042] In particular, the control section 1 of the
20 present example functions as an example of a signal processing apparatus for predicting the position of the affected area 260 after the predetermined time and the prediction accuracy information using the time series information of the position of the affected area 260
25 measured by the OBI 220. Further, the control section 1 functions as an example of a driving controlling section for calculating an irradiation position and an irradiation

range of a radiation using the predicted position of the affected area 260 after the predetermined time and the accuracy information of the prediction position and driving and controlling the MLC 210 based on a result of
5 the calculation.

[0043] Further, the control section 1 may carry out not only the driving control of the MLC 210 but also control of the irradiation timing of a radiation using the predicted position of the affected area 260 after the predetermined
10 time and the prediction accuracy information. For example, the control section 1 may control the emission timing of an electron beam from the electron gun 140 thereby to control the generation timing of the radiation, or may control the microwave power amount to be outputted from the klystron
15 100 thereby to control the generation timing of the radiation in the target 170.

[0044] In particular, the control section 1 of the present example functions as an example of a timing controlling section for controlling the generation timing
20 of the radiation using the position of the affected area 260 after the predetermined time and the accuracy information of the prediction position predicted by the method described above.

It is to be noted that the control section 1 may
25 carry out only one of the driving control and the timing control. For example, where the control section 1 carries out only the timing control, since the irradiation position

of the radiation is fixed and the radiation is irradiated aiming at a timing at which the affected area 260 moves to the irradiation position based on the prediction result described above, an effect similar to that in the example 5 described above is obtained. Further, since the MLC 210 may not be provided, the apparatus can be simplified and the cost of the apparatus can be decreased.

[0045] An example of a configuration of and a prediction method by the control section 1 are described 10 below.

(1.2) Control Section 1

The control section 1 receives an arbitrary time series signal whose principal component is cycle time-variable season dynamics (periodically repeated time 15 series signal) as an input and outputs a prediction value after predetermined time passes and information (prediction accuracy information) regarding the prediction accuracy.

[0046] The control section 1 illustrated in FIG. 5 20 includes a model production section 11, a cycle fluctuation analysis section 12, a variables estimation section 13, a cache memory 14, another cache memory 15 and a prediction accuracy estimation section 16.

Here, the input to the control section 1 is a time 25 series signal

[0047]

$$\{\mathbf{x}(\tau)\}_{\tau=1}^{t_c}$$

corresponding to a variation of the position of the affected area 260 after the observation starting time to current time t_c . Here,

5 [0048]

[Expression 2]

$$\mathbf{x}(\tau) = [x_1(\tau)x_2(\tau) \cdots x_{\text{Dim}}(\tau)]$$

is satisfied, and

$$x_j(\tau)$$

10 is the position of the affected area in a j th ($j = 1$ to Dim) dimension direction at time τ , and Dim is a dimension number of the position information.

On the other hand, outputs of the control section 1 are a prediction value

15 [0049]

[Expression 3]

$$\mathbf{x}(t_c + L)$$

of the position

20
$$\tilde{\mathbf{x}}(t_c + L) = [\tilde{x}_1(t_c + L) \tilde{x}_2(t_c + L) \cdots \tilde{x}_{\text{Dim}}(t_c + L)]$$

of the affected area 260 at prediction target time ($t_c + L$) where an arbitrary prediction period is represented

by L , an estimation value

[0050]

[Expression 4]

$$\tilde{e}(t_c + L) = [\tilde{e}_1(t_c + L) \tilde{e}_2(t_c + L) \cdots \tilde{e}_{D_{im}}(t_c + L)]$$

5 of an error which is accuracy information of the prediction value, and an estimation value

[0051]

[Expression 5]

$$\Delta \tilde{x}(t_c + L) = [\Delta \tilde{x}_1(t_c + L) \Delta \tilde{x}_2(t_c + L) \cdots \Delta \tilde{x}_{D_{im}}(t_c + L)]$$

10 of a position fluctuation amount per unit time.

[0052] (1.3) Model Production Section 11

The model production section 11 produces a prediction model using the time series signal described above which is an input to the control section 1, in-phase time information which has a phase same as that of the prediction target time and which is part of an output of the cycle fluctuation analysis section 12, reliability of the in-phase time information, and model design information which is part of an output of the prediction accuracy estimation section 16, and outputs a prediction value of the input time series signal after the predetermined time passes and detailed information of the procedure in which the prediction value is calculated using the produced prediction model. It is to be noted that the model production section 11 may produce a plurality of sub models in which kinds of filters and models or parameter values are different from each other with an influence of the

cycle time variation into consideration and synthesize the sub models to produce the prediction model. Further, the model production section 11 may produce the prediction model using a plurality of sub models produced in advance.

5 [0053] The model production section 11 illustrated in FIGS. 5 and 11(A) includes sub models 111-1 to 111-S (S is a total number of the sub models) and a synthesis processing section 112.

The model production section 11 of the present
10 example receives, as inputs thereto, the input time series signal

$$\{x(\tau)\}_{\tau=1}^{t_c}$$

to the control section 1, time

$$x(t_c + L)$$

15 [0054]

[Expression 6]

$$T^L(t_c) = [T_1^L(t_c) T_2^L(t_c) \cdots T_{D_{im}}^L(t_c)]$$

[0055]

[Expression 7]

20 $T_j^L(t_c) = [T_j^L(t_c, 1) T_j^L(t_c, 2) \cdots T_j^L(t_c, M_T)]^T$

of the input time series signal whose phase is same as that of a signal of the prediction target time ($t_c + L$), which is part of the output of the cycle fluctuation analysis

section 12, and the reliability

[0056]

[Expression 8]

$$C_{TL}(t_c) = \left[C_{t_1^L}(t_c) C_{t_2^L}(t_c) \cdots C_{t_{D_{im}}^L}(t_c) \right]$$

5 [0057]

[Expression 9]

$$C_{T_j^L}(t_c) = \left[C_{T_j^L}(t_c, 1) C_{T_j^L}(t_c, 2) \cdots C_{T_j^L}(t_c, M_T) \right]^T$$

of the time and model design information

[0058]

10 [Expression 10]

$$I^{\text{model}}(t_c) = \left[I^{\text{model}}(t_c, 1) I^{\text{model}}(t_c, 2) \cdots I^{\text{model}}(t_c, S) \right]$$

which is part of the output of the prediction accuracy estimation section 16, and outputs a prediction value

[0059]

15 [Expression 11]

$$\tilde{\mathbf{x}}(t_c + L) = \left[\tilde{x}_1(t_c + L) \tilde{x}_2(t_c + L) \cdots \tilde{x}_{D_{im}}(t_c + L) \right]$$

[0060]

[Expression 12]

$$\tilde{x}_j(t_c + L) = F_{t_c, j}^{\text{com}}(\tilde{x}_j(t_c + L, 1), \tilde{x}_j(t_c + L, 2), \cdots, \tilde{x}_j(t_c + L, S))$$

20 of the prediction target time ($t_c + L$) and detailed information

[0061]

[Expression 13]

$$I^{\tilde{x}}(t_c + L) = [I^{\tilde{x}}(t_c + L, 1) \quad I^{\tilde{x}}(t_c + L, 2) \quad \dots \quad I^{\tilde{x}}(t_c + L, S)]$$

[0062]

[Expression 14]

$$I^{\tilde{x}}(t_c + L, s) = [I_1^{\tilde{x}}(t_c + L, s) \quad I_2^{\tilde{x}}(t_c + L, s) \quad \dots \quad I_{\text{Dim}}^{\tilde{x}}(t_c + L, s)]$$

5 [0063]

[Expression 15]

$$I_j^{\tilde{x}}(t_c + L, s) = [I_j^{\tilde{x}}(t_c + L, s, 1) \quad I_j^{\tilde{x}}(t_c + L, s, 2) \quad \dots \quad]$$

of the procedure of the prediction value calculation.

Here,

$$10 \quad \tilde{x}_j(t_c + L, s)$$

is an output value in the j th dimension direction of a sub model s ($s = 1, 2, \dots, S$). Further, a function

$$F_{t_c, j}^{\text{COM}}(\cdot)$$

15 corresponds to an addition and multiplication process by the synthesis processing section 112 and is determined using model design information

$$I^{\text{model}}(t_c, s)$$

and the prediction value at the prediction target time ($t_c + L$) is calculated as a synthesis of outputs of the
20 sub models 111-1 to 111-S. Here,

$$I^{\text{model}}(t_c, s)$$

is model design information of the sub model s , and

$$I_j^{\tilde{x}}(t_c + L, s)$$

is information (calculation procedure information) of the
5 output calculation procedure of an output

$$\tilde{x}_j(t_c + L, s)$$

of the sub model s and part of design information of a
function

$$F_{t_c, j}^{\text{com}}(\cdot)$$

10 Further,

$$I_j^{\tilde{x}}(t_c + L, s, i), i = 1, 2, \dots$$

which is a factor of the function is information of a model
parameter or particular information of the output
calculation procedure or the function design.

15 In particular, the model production section 11 of
the present example functions as an example of a model
production section adapted to produce, using the input
time series signal, the in-phase time information and the
reliability of the in-phase time information calculated
20 by the cycle fluctuation analysis section 12 and the model
design information estimated by the prediction accuracy
estimation section 16, a prediction model for predicting

the value of the input time series signal after the predetermined time and predict and output the value of the input time series signal after the predetermined time using the prediction model.

5 [0064] Also it is possible for the model production section 11 to produce a plurality of sub models whose kinds of filters and models and parameter values are different from each other and a model of a synthesis of the sub models using an arbitrary time series signal which is an input
10 to the control section 1 and whose principal component is cycle time-variable season dynamics, in-phase time information whose phase is same as that at the prediction target time which is part of the output of the cycle fluctuation analysis section 12 and reliability
15 information of the in-phase time information, and model design information which is part of the output of the prediction accuracy estimation section 16, and output the prediction value of the input time series signal after the predetermined time and detailed information of the
20 calculation procedure of the prediction value.

[0065] Further, the model production section 11 in the present embodiment can change the design of the sub models and the model of the synthesis of the sub models using the prediction accuracy information estimated by
25 the prediction accuracy estimation section 16.

[0066] (1.3.1) Sub Models 111-1 to 111-S

The sub models 111-1 to 111-S are produced using

model design information (information of a kind of a filter and a model or parameters of the filter and model) and are models for predicting a value of the input time series signal (or a specific component of the input time series
5 signal) after the predetermined time. The number of the sub models is determined based on the total number of combinations of kinds of filters and models and kinds of parameters of the filters and models.

[0067] Where, in the design of the sub models 111-1
10 to 111-S, the cycle of season dynamics of a time series signal after a filter process varies with respect to time (time-variable), a problem that a prediction error increases from a cause of the cycle time variation is avoided using the in-phase time information in the input time series
15 signal whose phase is same as that at the prediction target time which is an input from the cycle fluctuation analysis section 12 and the reliability information of the in-phase time information.

For the kind of the filter used for each sub model,
20 for example, at least one of a moving average filter, a difference filter, a band-pass filter and a Kalman filter can be used.

[0068] For the sub models 111-1 to 111-S, for example,
at least one of an SARIMA (Seasonal Auto-Regressive
25 Integrated Moving Average) model, a seasonal adjustment exponential smoothing model, a non-linear type ARIMA (Auto-Regressive Integrated Moving Average) model and a

soft computing model such as a neural network, a fuzzy or the like and so forth can be used.

[0069] Further, for the design of a model, for example, a design algorithm of the Yule Walker method, the Burg method, a least-square method and a gradient method, an arbitrary design parameter, an evaluation function and an evaluation algorithm of the AIC (Akaike information criterion) or a maximum likelihood procedure can be used.

The sub model s (111-1 to 111-S) illustrated in FIG. 11(B) is an example for implementing a scheme for effectively modeling cycle time-variable season dynamics and another scheme for directly predicting the prediction target time ($t_c + L$) using a SARIMA model as a kind of the model and further using time information

15 $\mathbf{T}^L(t_c)$

in the input time series signal whose phase is same as that of the signal of the prediction target time ($t_c + L$). Here, an output where the input time series signal

$\{\mathbf{x}(\tau)\}_{\tau=1}^{t_c}$

20 is used as an input is calculated by the following expression.

[0070]

[Expression 16]

$$\tilde{x}(t_c + L, s) = [\tilde{x}_1(t_c + L, s) \quad \tilde{x}_2(t_c + L, s) \quad \dots \quad \tilde{x}_{D_{\text{ima}}}(t_c + L, s)]$$

$$\phi_j^p(t_c) \Phi_j^{M_T} (t_c, T_j^L(t_c)) (1-B)^d x_j(t_c + L, s) = \theta_j^q(t_c) e_j(t_c + L)$$

$$\phi_j^p(t_c) = 1 - \phi_{j,1}(t_c)B^L - \phi_{j,2}(t_c)B^{2L} - \dots - \phi_{j,p}(t_c)B^{pL}$$

$$\theta_j^q(t_c) = 1 - \theta_{j,1}(t_c)B^L - \theta_{j,2}(t_c)B^{2L} - \dots - \theta_{j,q}(t_c)B^{qL}$$

$$\Phi_j^{M_T}(t_c, T) = 1 - \Phi_{j,1}(t_c)B^{t_c+L-i(1)} - \Phi_{j,2}(t_c)B^{t_c+L-i(2)} - \dots - \Phi_{j,M_T}(t_c)B^{t_c+L-i(M_T)}$$

$$T = [t(1) \ t(2) \ \dots \ t(M_T)]$$

$$\{x_j(\tau, s)\}_{\tau=1}^{t_c} = F_s^{\text{div}} \left(\{x_j(\tau)\}_{\tau=1}^{t_c}, T_j^{\text{model}}(t_c, s) \right)$$

... (2)

Here, a derivation method of the expression (2) given just above is described.

5 The expression (2) given above is an expression of a time series model for describing time series data whose cycle of a seasonal component fluctuates.

Further, in order to facilitate understandings of the derivation method of the expression (2) given above,
 10 description of a definition of some terms and models of AR (Auto-Regression: auto regression), MA (Moving Average: moving average), ARMA (Auto-Regression Moving Average: auto regression moving average), ARIMA (Auto-Regression Integrated Moving Average: auto regression integrated
 15 moving average) and SARIMA is carried out.

First, the time series model signifies a relational expression which describes a regulation of a behavior of time series data. Further, a steady process signifies a probability process in which a probability distribution
 20 does not vary. Further, a steady time series signifies

time series data produced by the steady process and has a characteristic that the average value and the variance do not vary within any interval of the time series. It is to be noted that a design method for AR and ARMA models
 5 with respect to the steady time series has been established.

Further, a trend component signifies a component which varies the average value of the time series continuously for long time. Further, a seasonal component signifies a component which periodically varies the
 10 average value of the time series and a non-steady time series signifies a time series other than the steady time series. As the non-steady time series, for example, a time series with which the trend component or the seasonal component is mixed is available.

15 First, the AR model is described.

The AR model represents values of a steady time series $z(t)$ ($t = 0, 1, 2, \dots$) as a linear equation of time series data in the past with respect to the steady time series like the following expression (3).

$$20 \quad z(t) = \varphi_1 z(t-1) + \varphi_2 z(t-2) + \dots + \varphi_p z(t-p) + e(t) \dots (3)$$

Here, p is an order of the model, φ_i ($i = 1, 2, \dots, p$) is a model coefficient, and $e(t)$ is a model error at time t .

25 If the terms other than $e(t)$ are moved from the left side of the expression (3) to the right side, then the following expression (4) is obtained.

$$z(t) - \phi_1 z(t-1) - \phi_2 z(t-2) - \dots - \phi_p z(t-p) = e(t) \dots (4)$$

Further, if, as a delay operator B , for example, B which satisfies the following expression (5)

$$5 \quad B^d z(t) = z(t-d) \dots (5)$$

is used to describe the expression (4) given above, then the following expressions (6) and (7) are obtained.

$$\phi^p z(t) = e(t) \dots (6)$$

$$\phi^p \equiv (1 - \phi_1 B - \phi_2 B^2 - \dots - \phi_p B^p) \dots (7)$$

10 Now, the MA model is described.

The MA model represents values of the steady time series $z(t)$ as a linear equation of time series data $e(t)$ of noise generated till then like the following expression (8).

$$15 \quad z(t) = e(t) - \theta_1 e(t-1) - \theta_2 e(t-2) - \dots - \theta_q e(t-q) \dots (8)$$

Here, q is an order of the model and θ_j ($j = 1, 2, \dots, q$) is a model coefficient.

If the expression (8) given above is represented using the delay operator B , then the following expressions (9) and (10) are obtained.

$$z(t) = \theta^q e(t) \dots (9)$$

$$\theta^q \equiv (1 - \theta_1 B - \theta_2 B^2 - \dots - \theta_q B^q) \dots (10)$$

Further, the ARMA model is described.

25 The ARMA model represents values of the steady time series $z(t)$ as a linear equation between time series data in the past with respect to the steady time series and

time series data $e(t)$ of noise generated till then by like the following expression (11).

$$z(t) = \varphi_1 z(t-1) + \varphi_2 z(t-2) + \dots + \varphi_p z(t-p) + e(t) - \theta_1 e(t-1) - \theta_2 e(t-2) - \dots - \theta_q e(t-q) \dots (11)$$

Here, if the terms other than terms relating to noise are moved from the left side of the expression (11) given above to the right side, then the following expression (12) is obtained.

$$z(t) - \varphi_1 z(t-1) - \varphi_2 z(t-2) - \dots - \varphi_p z(t-p) = e(t) - \theta_1 e(t-1) - \theta_2 e(t-2) - \dots - \theta_q e(t-q) \dots (12)$$

Further, if the expression (12) given just above is represented using delay operators B , φ^p and θ^q , then the following expression (13) is obtained.

$$\varphi^p z(t) = \theta^q e(t) \dots (13)$$

Now, the ARIMA model is described.

The ARIMA model is a model for describing values of a non-steady time series $y(t)$ ($t = 1, 2, \dots$) including a trend component.

The trend component involved in the non-steady time series $y(t)$ can be removed by calculating a difference from time series data of a delay 1 by a predetermined number d of times (≥ 1). In particular, a residual $z(t)$ at this time is represented by the following expression (14).

$$z(t) = (1-B)^d y(t) \dots (14)$$

Here, since the time series of the residual $z(t)$ where the difference is suitably calculated is a steady

time series, it can be modeled by the ARMA model. In particular, the following expression (15) is satisfied.

$$\varphi^p z(t) = \theta^q e(t) \dots (15)$$

Accordingly, the ARIMA model is represented by the following expression (16) obtained by substituting the expression (14) into the expression (15) given above.

$$\varphi^p (1-B)^d y(t) = \theta^q e(t) \dots (16)$$

Now, the SARIMA model is described.

The SARIMA model is a model for describing values of a non-steady time series $x(t)$ ($t = 1, 2, \dots$) including a trend component and a seasonal component. It is to be noted that, in the following description, a case in which the cycle c of the seasonal component is $c \gg 1$ is considered.

The trend component involved in the non-steady time series $x(t)$ can be removed by calculating a difference from the time series data of the delay 1 by d (≥ 1) times as described in the description of the ARIMA model. A residual $w(t)$ at this time is represented by the following expression (17).

$$w(t) = (1-B)^d x(t) \dots (17)$$

Further, the seasonal component involved in the non-steady time series $x(t)$ after the trend component thereof is removed can be removed by any one of methods [1] to [3] described below.

As the method [1], for example, by calculating the difference from the time series data of a delay c by D (≥ 0) times, a residual $v(t)$ at this time is represented

by the following expression (18).

$$v(t) = (1 - B^c)^D w(t) \dots (18)$$

Further, as the method [2], for example, an AR model is produced from the time series data (in particular, time series data sampled at a time distance c) in which only in-phase data are extracted, and a difference of the AR model is calculated. In particular, a residual $v(t)$ at this time is represented by the following expressions (19) and (20).

$$v(t) = \Phi^P w(t) \dots (19)$$

$$\Phi^P \equiv (1 - \phi_1 B^c - \phi_2 B^{2c} - \dots - \phi_P B^{Pc}) \dots (20)$$

Further, as the method [3], for example, a method which uses both of the methods [1] and [2] described above is available. In particular, a residual $v(t)$ at this time is represented by the following expression (21).

$$v(t) = \Phi^P (1 - B^c)^D w(t) \dots (21)$$

Here, since the residual time series $v(t)$ from which the seasonal component is removed is a steady time series, it can be modeled with the ARMA model. In particular, the following expression (22) is satisfied using the $v(t)$.

$$\Phi^P v(t) = \theta^q e(t) \dots (22)$$

Accordingly, the SARIMA model is represented by the following expression (23) by substituting the expressions (17) and (21) into the expression (22) given above.

$$\Phi^P \Phi^P (1 - B^c)^D (1 - B)^d x(t) = \theta^q e(t) \dots (23)$$

Now, taking the foregoing into consideration, the expression (2) given above is described.

As described hereinabove, it is assumed that, in an ordinary SARIMA model, the cycle c of a seasonal component is always fixed.

This signifies that, in a time series of a seasonal component, a portion of the same phase appears after every cycle c as illustrated in FIG. 29. In the SARIMA model described hereinabove, the seasonal component is removed by the expressions (18) through (21).

Meanwhile, since the cycle of a seasonal component of an input time series signal such as the tumor position which is determined as a prediction target by the prediction process of the present example varies as illustrated in FIG. 30, different from the example illustrated in FIG. 29, a portion of the same phase does not necessarily appear after every cycle c .

Consequently, from an input time series signal such as the tumor position, it is impossible to remove a seasonal component involved in the input time series signal using the expressions (18) through (21) given hereinabove.

Therefore, in the present embodiment, the expressions (18) through (21) given hereinabove are improved so that they function appropriately for a non-steady time series in which the cycle of a seasonal component fluctuates. This is the expression (2) given hereinabove.

As an improved point described above, for example, the value of D of the expression (18) is determined to

be zero so that the processing of the expression (18) is not carried out.

Further, time series data formed by extracting data of the same phase to be used for the processing of the expressions (19) and (20) are produced not by sampling by the cycle c as in an ordinary SARIMA model but using in-phase time information calculated by the cycle fluctuation analysis section 12.

It is to be noted that, in order to carry out effective time series prediction using the expression (2) given hereinabove, it is demanded to appropriately design the values of the model coefficients φ , θ , Φ and the model orders p , q , d .

In the present example, as the design method of the model coefficients φ , θ , Φ , such methods as, for example, the Yule Walker method, the Burg method, a least-square method and a gradient method as described hereinabove, and as the design method for the model orders p , q , d , such methods as, for example, the ACI and a maximum likelihood method can be used.

[0071] It is to be noted that, as described hereinabove, B is an operator for delaying the time parameter. For example, by using the operator B to act on the variable x having a time parameter t from the front, the relationship of

[0072]

[Expression 17]

$$B^d x(t) = x(t - d)$$

is satisfied. Further,

$$F_s^{\text{div}}(\cdot)$$

is a function for calculating, from the input time series
5 signal

$$\{x_j(\tau)\}_{\tau=1}^{t_c}$$

to the control section 1 and the mode design information

$$I_j^{\text{model}}(t_c, s)$$

the time series signal

$$10 \quad \{x_j(\tau, s)\}_{\tau=1}^{t_c}$$

after the filter process which is made a target by the
sub model s. Here,

$$M_T$$

is an arbitrary constant. Further, the model orders p,
15 q, d and the model parameters

[0073]

[Expression 18]

$$\phi_{j,i} \quad i = 1, 2, \dots, p$$

$$\theta_{j,k} \quad k = 1, 2, \dots, q$$

$$\Phi_{j,l} \quad l = 1, 2, \dots, M_T$$

are determined using the reliability information of

$$T_j^L(t_c)$$

the model design information

$$5 \quad C_{t_j^L}(t_c)$$

and an evaluation algorithm of the AIC or the most likelihood method.

For example, in the case where, for certain constants,

$$10 \quad M_m, \delta C_T$$

[0074] a condition of

[Expression 19]

$$\left\| \left\{ m \mid m = 1, 2, \dots, M_t \wedge C_{T_j^L}(t_c, m) > \delta C_T \right\} \right\| \leq M_m$$

is satisfied, it is decided that the seasonal dynamics
 15 of the input time series signal are not suitable for prediction, and

[0075]

[Expression 20]

$$\begin{cases} \tilde{x}_j(t_c + L, s) & = \tilde{x}_j(t_c + L - 1, s) \\ I_j^{\tilde{x}}(t_c + L, s, 1) & = 0 \end{cases}$$

is outputted and the model production process is ended.

Here,

$$I_j^{\tilde{x}}(t_c + L, s, 1)$$

is factor information of information

5 $I_j^{\tilde{x}}(t_c + L, s)$

of the output calculation procedure, and the value thereof is zero (corresponding to absence of updating of the output value).

On the other hand, if the condition described
10 hereinabove is not satisfied, then the design algorithm for the model parameter is set as

[0076]

[Expression 21]

$$\Phi_i(t_c) = C_{T_j^{TL}}(t_c, m) / C_{\sum_j^{TL}}(t_c), \quad m = 1, 2, \dots, M_T$$

15 $C_{\sum_j^{TL}}(t_c) \equiv \sum_{m=1}^{M_T} C_{T_j^{TL}}(t_c, m)$

Further, an output

$$\tilde{x}_j(t_c + L, s)$$

where the model orders p, q, d are determined by the AIC or the maximum likelihood method is calculated, and the
20 factor information of the output calculation procedure is set to

[0077]

[Expression 22]

$$I_j^{\tilde{x}}(t_c + L, s, 1) = 1$$

5 which corresponds to presence of updating of the output value. In the present example, where $p = 0$ and $d = 0$, the output of the sub model s is

[0078]

[Expression 23]

$$\tilde{x}_j(t_c + L, s) = \sum_{m=1}^{M_T} C_{T_j^L}(t_c, m) \cdot x_j(T_j^L(t_c, m), s) / C_{T_j^L}(t_c)$$

10 It is to be noted here that, where

$$T_j^L(t_c, m)$$

is a real number, a function

$$R(\cdot)$$

15 for rounding up an input and outputting the rounded input is used to determine

$$x_j(T_j^L(t_c, m), s)$$

by linear approximation of

$$x_j(R(T_j^L(t_c, m) - 0.5), s)$$

and

$$x_j(R(T_j^L(t_c, m) + 0.5), s)$$

In particular, by using the model design information (the type of the filter or the model and information of parameters of them), the sub models 111-1 to 111-S function
 5 as an example of a prediction model for predicting the value of the input time series signal (or a particular portion of the same) after the predetermined time elapses.

Further, the sub models 111-1 to 111-S may have different structures or characteristics.

10 [0079] (1.3.2) Synthesis Processing Section 112

The synthesis processing section 112 carries out addition-multiplication processes of outputs of the sub models 111-1 to 111-S to calculate a prediction value of prediction target time ($t_c + L$) of the input time series
 15 signal to the control section 1. The synthesis processing section 112 illustrated in FIGS. 5 and 11(A) uses the outputs
 [0080]

[Expression 24]

$$\tilde{x}_j(t_c + L, s), \quad s = 1, 2, \dots, S$$

20 of all sub models 111-1 to 111-S to calculate a prediction value of the input time series signal to the control section 1 at the prediction target time ($t_c + L$) in accordance with the following expression.

[0081]

25 [Expression 25]

$$\tilde{x}_j(t_c + L) = F_{t_c, j}^{\text{com}}(\tilde{x}_j(t_c + L, 1), \tilde{x}_j(t_c + L, 2), \dots, \tilde{x}_j(t_c + L, S))$$

Here, particular specifications of the function

$$F_{t_c, j}^{\text{com}}(\cdot)$$

can be determined arbitrarily while taking the model design

5 information

$$I^{\text{model}}(t_c)$$

into consideration as occasion demands.

(1.4) Cycle Fluctuation Analysis Section 12

The cycle fluctuation analysis section 12 analyzes
 10 and calculates information effective to prevent a problem
 that the prediction accuracy of the control section 1
 deteriorates by a cause of a cycle fluctuation of the input
 time series signal.

The cycle fluctuation analysis section 12
 15 illustrated in FIGS. 5 and 6(A) includes a correlation
 analysis section 121, a cache memory 122, a cycle estimation
 section 123, a cycle prediction section 124, an in-phase
 time estimation section 125, a time delay section 126,
 another cache memory 127, and a difference processing
 20 section 128.

[0082]

The cycle fluctuation analysis section 12 of the
 present example receives the time series signal

$$\{x(\tau)\}_{\tau=1}^{t_c}$$

as an input and calculates the time

[0083]

[Expression 26]

$$\mathbf{T}^L(t_c) = \left[T_1^L(t_c) T_2^L(t_c) \cdots T_{D_{im}}^L(t_c) \right]$$

5 [0084]

[Expression 27]

$$T_j^L(t_c) = \left[T_j^L(t_c, 1) T_j^L(t_c, 2) \cdots T_j^L(t_c, M_T) \right]^T$$

of the position of the input time series signal at which
it becomes in phase with the signal of the prediction target

10 time $(t_c + L)$, and the reliability

[0085]

[Expression 28]

$$\mathbf{C}_{TL}(t_c) = \left[C_{t_1^L}(t_c) C_{t_2^L}(t_c) \cdots C_{t_{D_{im}}^L}(t_c) \right]$$

[0086]

15 [Expression 29]

$$C_{T_j^L}(t_c) = \left[C_{T_j^L}(t_c, 1) C_{T_j^L}(t_c, 2) \cdots C_{T_j^L}(t_c, M_T) \right]^T$$

of the time of the position of the input time series signal,
as well as the prediction accuracy information

[Expression 30]

$$\left\{ \Delta^L P(\tau) \right\}_{\tau=2 \max(P_j)+L}^{t_c}$$

20

[Expression 31]

$$\Delta^L P(\tau) = [\Delta^L P_1(\tau) \Delta^L P_2(\tau) \dots \Delta^L P_{D_{im}}(\tau)]$$

of the cycle. Here,

$$T_j^L(t_c, m)$$

is the m th highest value from among the time values of
 5 the positions of the input time series which becomes in
 phase with the seasonal dynamic of the prediction target
 time $(t_c + L)$ and has such a relationship as illustrated
 in FIG. 6(B). Further,

$$C_{T_j^L}(t_c, m)$$

10 is the reliability of

$$T_j^L(t_c, m)$$

and

$$M_T$$

is an arbitrary positive constant. Further,

$$15 \quad \Delta^L P_j(\tau)$$

is accuracy information of the prediction value

$$P_j(\tau)$$

in the case where the cycle (estimated value)

$$\{x_j(t)\}_{t=1}^{\tau-L}$$

at time τ is predicted using information of the time series signal

$$\tilde{P}_j(\tau)$$

till time $(\tau - L)$, and has such a relationship as illustrated
5 in FIG. 6(C).

In particular, the cycle fluctuation analysis section 12 of the present example functions as an example of a cycle fluctuation analysis section adapted to assume a certain component of an input time series signal as a
10 time series signal whose cycle varies with respect to time to carry out a correlation analysis between part of the input time series signal and the input time series signal, estimate a cycle fluctuation of the input time series signal and reliability of the cycle fluctuation using a result
15 of the correlation analysis, predict a cycle of the input time series signal after predetermined time using the cycle fluctuation and the reliability of the cycle fluctuation and calculate, using the result of the correlation analysis and the predicted cycle, in-phase time information which
20 represents time of the input time series signal whose phase becomes same as a phase of the input time series signal after the predetermined time and the reliability of the in-phase time information.

[0087] In short, the cycle fluctuation analysis
25 section 12 can calculate information effective to prevent the problem that the prediction accuracy, after

predetermined time passes, of the input time series signal to the control section 1 whose principal component is cycle time-variable seasonal dynamics, deteriorates by a cause of a cycle fluctuation of the input time series signal.

5 [0088] (1.4.1) Correlation Analysis Section 121

The correlation analysis section 121 calculates a correlation analysis result necessary to estimate or predict a cycle fluctuation of the input time series signal by a correlation analysis of the input time series signal.

10 [0089] The correlation analysis section 121 illustrated in FIGS. 5 and 7(A) receives the time series signal

$$\{x(\tau)\}_{\tau=1}^{t_c}$$

as an input thereto and outputs a result

15 [Expression 32]

$$C(t_c) = [C_1(t_c) C_2(t_c) \cdots C_{D_{im}}(t_c)]$$

[Expression 33]

$$C_j(t_c) = [C_j(t_c, 0) C_j(t_c, 1) \cdots C_j(t_c, t_c - \max(P_j))]$$

of the correlation analysis. Here,

20 $\max(P_j)$

is an estimated value of a maximum value of the cycle fluctuation which is estimated to possibly appear with ordinary seasonal dynamics of the input time series signal.

Further, the value of

$$C_j(t_c, k)$$

is calculated in accordance with

[0090]

5 [Expression 34]

$$C_j(t_c, k) = \begin{cases} 0 & \dots \text{ if } t_c < 2\max(P_j) \\ \frac{\sum_{\ell=1}^{\max(P_j)} (y_j(t_c, 0, \ell) - \bar{y}_j(t_c, 0))(y_j(t_c, k, \ell) - \bar{y}_j(t_c, k))}{\sqrt{\sum_{\ell=1}^{\max(P_j)} (y_j(t_c, 0, \ell) - \bar{y}_j(t_c, 0))^2} \sqrt{\sum_{\ell=1}^{\max(P_j)} (y_j(t_c, k, \ell) - \bar{y}_j(t_c, k))^2}} & \dots \text{ otherwise} \end{cases}$$

$$y_j(t_c, k, \ell) \equiv x_j(t_c - \max(P_j) + \ell - k)$$

$$\bar{y}_j(t_c, k) \equiv \frac{1}{\max(P_j)} \sum_{\ell=1}^{\max(P_j)} x(t_c, k, \ell)$$

and this value is a correlation function of the time series

10 signal

$$\{x(\tau)\}_{\tau=t_c - \max(P_j) + 1}^{t_c}$$

of thick broken line portions of FIGS. 7(B) and 7(C) and the time series signal

$$\{x(\tau)\}_{\tau=t_c - \max(P_j) - k + 1}^{t_c - k}$$

15 of a solid line portion of FIG. 7(C), and varies, in the case where seasonal dynamic are involved in the input time series signal, as illustrated in FIG. 7(D) by varying the value of k .

In particular, the correlation analysis section 121

functions as an example of a correlation analysis section for carrying out a correlation analysis between part of the input time series signal and the input time series signal. For example, the correlation analysis section 121
 5 can calculate a correlation analysis result to be used for estimation or prediction of a cycle fluctuation of the input time series signal by a correlation analysis for the input time series signal and output the correlation analysis result to the cache memory 122.

10 [0091]

(1.4.2) Cache Memory 122

The cache memory 122 is a memory for storing a correlation analysis result

$$C(t_c)$$

15 which is an output of the correlation analysis section 121 and outputs an arbitrary piece of information from among pieces of information stored for a fixed period in the past.

The cache memory 122 illustrated in FIG. 5 outputs
 20 a time series

$$\{C(\tau)\}_{\tau=1}^{t_c}$$

of all information stored therein after time $\tau = 1$ till current time t_c .

[0092]

25 (1.4.3) Cycle Estimation Section 123

The cycle estimation section 123 calculates, using time series information of a correlation analysis result of the input time series signal, time series information of an estimated value of the fluctuation of the cycle of the input time series signal and time series information of the reliability of the estimated value.

[0093]

The cycle estimation section 123 illustrated in FIGS. 5 and 8(A) receives, as an input thereto, time series information

$$\{C(\tau)\}_{\tau=1}^{t_c}$$

of a correlation analysis result which is an output of the cache memory 122 and outputs time series information

$$\{P(\tau)\}_{\tau=2}^{t_c} \max(P_j)$$

[Expression 35]

$$P(\tau) = [P_1(\tau) \ P_2(\tau) \ \cdots \ P_{D_{im}}(\tau)]$$

of the estimated value of the cycle of the input time series signal to the control section 1 and time series information

$$\{C_P(\tau)\}_{\tau=2}^{t_c} \max(P_j)$$

[Expression 36]

$$C_P(\tau) = [C_{P_1}(\tau) \ C_{P_2}(\tau) \ \cdots \ C_{P_{D_{im}}}(\tau)]$$

of the reliability of the time series information of the

estimated value. Here, the period

$$P_j(\tau)$$

of the phase (corresponding to an asterisk in FIG. 8(B)) at time τ in the j th dimension direction of the input time series signal corresponds to the length of the seasonal dynamics component of the time series signal

$$\{x_j(\tau)\}_{\tau=1}^{t_c}$$

corresponding to the latest one period after time τ , and

$$C_{P_j}(\tau)$$

is reliability of the value and is calculated, as

illustrated in FIG. 8(B), as a weighted average of a value determined within the range from $t_s = \tau$ to $t_s = \tau + \max(P_j)$, from the correlation analysis result

$$\{C_j(\tau)\}_{\tau=1}^{t_c}$$

with regard to the time series signal in the j th dimension direction, in accordance with the following expressions.

[0094]

[Expression 37]

$$P_j(\tau) = \begin{cases} 0 & \text{if } \sum_{t_s=\tau}^{N(\tau, \max(P))} C_{K_j^{[u1]}}(t_s) = 0 \\ \frac{\sum_{t_s=\tau}^{N(\tau, \max(P))} C_{K_j^{[u1]}}(t_s) \cdot K_j^{[u1]}(t_s)}{\sum_{t_s=\tau}^{N(\tau, \max(P))} C_{K_j^{[u1]}}(t_s)} & \text{otherwise} \end{cases}$$

[Expression 38]

$$C_{P_j}(\tau) = \frac{\sum_{t_s=\tau}^{N(\tau, \max(P))} C_{K_j^{[u1]}}(t_s)}{N(\tau, \max(P)) - \tau + 1}$$

[Expression 39]

$$N(\tau, \max(P)) = \begin{cases} \tau + \max(P) & \text{if } \tau + \max(P) < t_c \\ t_c & \text{otherwise} \end{cases}$$

[Expression 40]

$$K_j^{[u1]}(t) = \begin{cases} 0 & \text{if there is no upper peak} \\ \arg_k \text{Get_}[1]\text{st_Upper_Peak}(C_j(t, k)) & \text{otherwise} \end{cases}$$

5

[Expression 41]

$$C_{K_j^{[u1]}}(t) = \begin{cases} 0 & \text{if there is no upper peak} \\ C_j(t, K_j^{[u1]}(t)) & \text{otherwise} \end{cases}$$

Here,

$\arg_k \text{Get_}[1]\text{st_Upper_Peak}(C_j(t, k))$ is a

10 function which outputs, in the case where k is gradually changed from 0 to

$\max(P_j)$

the value of k at which the value of

$C_j(t, k)$

15 exhibits a convex peak first (refer to FIG. 8(C)).

In particular, the cycle estimation section 123 of the present example functions as an example of a cycle

estimation section for estimating the cycle fluctuation of the input time series signal and the reliability of the cycle fluctuation using a result of the analysis by the correlation analysis section 121. For example, the
 5 cycle estimation section 123 can calculate, from time series information of the correlation analysis result of the input timer series signal which is an output of the cache memory 122, time series information of the estimated value of the fluctuation of the cycle of the input time
 10 series signal and time series information of the reliability of the estimated value.

[0095]

(1.4.4) Cycle Prediction Section 124

The cycle prediction section 124 predicts a cycle
 15 from time $(t_c + 1)$ to prediction target time $(t_c + L)$ using time series information of the estimated value of the fluctuation of the cycle of the input time series signal till current time t_c and time series information of the accuracy of the estimated value.

20 The cycle prediction section 124 illustrated in FIGS. 5 and 9 receives, as inputs thereto, time series information

$$\{P(\tau)\}_{\tau=2}^{t_c} \max(P_j)$$

of the estimated value of the fluctuation of the cycle of the input time series signal which is an output of the
 25 cycle estimation section 123 till current time t_c and the time series information

$$\{C_P(\tau)\}_{\tau=2}^{t_c} \max(P_j)$$

of the reliability of the time series information of the estimated value,

$$\{P(t_c + \ell)\}_{\ell=1}^L$$

5 and outputs the predicted time series information

$$\{\tilde{P}(t_c, t_c + \ell)\}_{\ell=1}^L$$

[0096]

[Expression 42]

$$\tilde{P}(t_c, t_c + \ell) = [\tilde{P}_1(t_c, t_c + \ell) \tilde{P}_2(t_c, t_c + \ell) \cdots \tilde{P}_{D_{im}}(t_c, t_c + \ell)]$$

10 at current time t_c . Here,

$$\tilde{P}_j(t_c, t_c + \ell)$$

is a prediction value of the period

$$P_j(t_c + \ell)$$

of the signal in the j th dimension direction at time (t_c
 15 + 1) as predicted at time t_c . This value is calculated, using, for example, data

$$\{P(\tau)\}_{\tau=2}^{t_c} \max(P_j)$$

[0097]

whose reliability is higher than an arbitrary constant

$$\delta_{CP_j}$$

that is, appropriate data, from among the data of the estimated value

[Expression 43]

$$5 \quad P_j(\tau_c), \tau_c \in \left\{ \tau \mid (2 \max(P_j) \leq \tau \leq t_c) \wedge (C_{P_j}(\tau) > \delta_{CP_j}) \wedge (\min(P_j) \leq P_j(\tau) \leq \max(P_j)) \right\}$$

of the cycle which is an input to the cycle prediction section 124, from such an autoregressive model as given by the following expression.

[0098]

10 [Expression 44]

$$\tilde{P}_j(t_c, t_c + \ell) = \bar{P}_j + \sum_{i=0}^{M_P} \phi_{j,i}^{\ell} (P_j(t_c - i\ell) - \bar{P}_j) \quad \dots \quad \ell = 1, 2, \dots, L$$

Here,

$$\min(P_j)$$

is an estimated value of a minimum value of the cycle fluctuation which may possibly appear in ordinary dynamic
15 of the time series signal

$$\{x_j(\tau)\}_{\tau=1}^{t_c}$$

Further,

$$M_P$$

20 and

[0099]

$$\phi_{j,i}^{\ell}, i = 0, 1, 2, \dots, M_P$$

are a dimension number and an autoregressive coefficient of the model, and can be determined, for example, from a model design algorithm such as the Yule Walker method, the Burg method, a least-square method and a gradient method, and a model evaluation algorithm such as the AIC or the most likelihood method.

In particular, the cycle prediction section 124 functions as an example of a cycle prediction section for predicting a cycle of the input time series signal after the predetermined time using the cycle fluctuation and the reliability of the cycle fluctuation estimated by the cycle estimation section 124. For example, the cycle prediction section 124 can predict the cycle from time $(t_c + 1)$ to prediction target time $(t_c + L)$ by producing a prediction model based on a model production algorithm such as the Yule Walker method, the Burg method, a least-square method and a gradient method, and a model evaluation algorithm such as the AIC or the most likelihood method using the time series information of the estimated value of the fluctuation of the cycle of the input time series signal till current time t_c and the time series signal of the reliability of the estimated value which are outputs of the cycle estimation section 123, and carrying out prediction using the prediction model.

[0100]

(1.4.5) In-Phase Time Estimation Section 125

The in-phase time estimation section 125 outputs in-phase time information of the phase of an input time series signal having a phase same as that at the prediction target time and the reliability information of the in-phase time information, which are information effective to prevent the problem that the prediction accuracy of the model production section 11 deteriorates by a cause of a cycle fluctuation of the input time series signal using the input time series signal to the control section 1, time series information of the correlation analysis result of the input time series signal, and the time series information of the prediction result of the period of the input time series signal till the prediction target time.

[0101]

The in-phase time estimation section 125 illustrated in FIGS. 5 and 10 (A) receives, as inputs thereto, the input time series signal

$$\{x(\tau)\}_{\tau=1}^{t_c}$$

the time series information

$$\{C(\tau)\}_{\tau=1}^{t_c}$$

of the correlation analysis result which is an output of the cache memory 122 and the time series information

$$\{\tilde{P}(t_c, t_c + \ell)\}_{\ell=1}^L$$

of the prediction result of the cycle of the input time series signal till the prediction target time, and outputs the time

[0102]

5 [Expression 45]

$$\mathbf{T}^L(t_c) = \left[T_1^L(t_c) T_2^L(t_c) \cdots T_{D_{im}}^L(t_c) \right]$$

[0103]

[Expression 46]

$$T_j^L(t_c) = \left[T_j^L(t_c, 1) T_j^L(t_c, 2) \cdots T_j^L(t_c, M_T) \right]^T$$

10 of the phase of the input time series signal of a phase same as that of the prediction target time, and the reliability

[0104]

[Expression 47]

15
$$C_{T^L}(t_c) = \left[C_{t_1^L}(t_c) C_{t_2^L}(t_c) \cdots C_{t_{D_{im}}^L}(t_c) \right]$$

[0105]

[Expression 48]

$$C_{T_j^L}(t_c) = \left[C_{T_j^L}(t_c, 1) C_{T_j^L}(t_c, 2) \cdots C_{T_j^L}(t_c, M_T) \right]^T$$

of the time of the phase of the input time series signal.

20 Here,

$$T_j^L(t_c, m)$$

is the mth highest value from among the time values of

the time series signal

$$\{x_j(\tau)\}_{\tau=1}^{t_c}$$

of a phase same as that of the prediction value of the phase of the seasonal dynamics at the prediction target
 5 time $(t_c + L)$, and has such a relationship as illustrated in FIG. 6(B). Further,

$$C_{T_j^L}(t_c, m)$$

is the reliability of

$$T_j^L(t_c, m)$$

10 and

$$M_T$$

is an arbitrary positive constant. A calculation method of

$$T_j^L(t_c, m)$$

15 and

$$C_{T_j^L}(t_c, m)$$

is described below.

[0106]

First, with regard to an arbitrary constant

$$\delta_{K_j^{[u1]}}$$

it is verified whether or not a condition of

[0107]

[Expression 49]

$$\left(K_j^{[u1]}(t_c) \leq \min(P_j) \right) \vee \left(\max(P_j) \leq K_j^{[u1]}(t_c) \right) \vee \left(C_{K_j^{[u1]}}(t_c) < \delta_{K_j^{[u1]}} \right)$$

5 is satisfied. If the condition is satisfied, then it is decided that the latest seasonal dynamics are not suitable for prediction, and

[0108]

[Expression 50]

$$\begin{cases} T_j^L(t_c, k) = 0 \\ C_{T_j^L}(t_c, k) = 0 \end{cases} \quad k = 1, 2, \dots, M_T$$

10

[0109]

is set, and then the processing of the in-phase time estimation section 125 is ended.

On the other hand, in the case where the condition
 15 described hereinabove is not satisfied, since the time value which is lower than the current time value t_c and is nearest to t_c (the leftmost star mark surrounded by a rectangle in FIG. 10(B)) from among the time values of the phase of the input time series signal (star mark in
 20 FIGS. 10(B)) having a phase same as that the phase (rightmost asterisk in FIG. 10(B)) of the prediction target time (t_c

+ L) has such a relationship as illustrated in FIG. 10(B), it is calculated in accordance with the following expression.

[0110]

5 [Expression 51]

$$T_j^L(t_c, 1) = t_1(M_l)$$

[Expression 52]

$$t_1(i) = t_1(i-1) - R(\bar{P}_j(t_c, t_1(i-1)))$$

[Expression 53]

10 $t_1(0) \equiv t_c + L$

[0111] Here,

$R(\cdot)$

is a function for rounding an input and outputting the rounded input, and

15 M_l

is a minimum value of i which satisfies

[0112]

[Expression 54]

$$t_1(i) < t_c, i \in \{1, 2, \dots\}$$

20 Further, the reliability of

$$T_j^L(t_c, 1)$$

is given by

[Expression 55]

$$C_{t_j^L}(t_c, 1) = 1$$

5 Further,

$$T_j^L(t_c, m)$$

(time of the first and second asterisks from the left in FIG. 10(D)) at $m = 2, 3, \dots, MT$ and the reliability

$$C_{T_j^L}(t_c, m)$$

10 of the value are calculated as weighted averages of the values determined within an appropriate range of t_s in accordance with the following expressions.

[0113]

[Expression 56]

$$15 \quad T_j^L(t_c, m) = \begin{cases} 0 & \text{if } \sum_{t_s=T_j^L(t_c,1)}^{t_c} C_{t_j^L}(t_c, m, t_s) = 0 \\ \frac{\sum_{t_s=T_j^L(t_c,1)}^{t_c} C_{t_j^L}(t_c, m, t_s) \cdot T_j^L(t_c, m, t_s)}{\sum_{t_s=T_j^L(t_c,1)}^{t_c} C_{t_j^L}(t_c, m, t_s)} & \text{otherwise} \end{cases}$$

$$C_{t_j^L}(t_c, m) = \frac{1}{t_c - T_j^L(t_c, 1) + 1} \sum_{t_s=T_j^L(t_c,1)}^{t_c} C_{t_j^L}(t_c, m, t_s)$$

$$T_j^L(t_c, m, t_s) = T_j^L(t_c, 1) - s_j(t_s, m - 1)$$

$$C_{T_j^L}(t_c, m, t_s) = C_{s_j}(t_s, m - 1)$$

$$s_j(t_s, n) = \begin{cases} 0 & \text{if there is no } n \text{ th upper peak} \\ \arg_k \text{Get_}[n]\text{th_Upper_Peak}(C_j(t_s, k)) & \text{otherwise} \end{cases}$$

$$C_{s_j}(t_s, n) = \begin{cases} 0 & \text{if there is no } n \text{ th upper peak} \\ C_j(t_s, s_j(t_s, n)) & \text{otherwise} \end{cases}$$

Here,

$$\arg_k \text{Get_}[n]\text{th_Upper_Peak}(C_j(t_s, k))$$

5 is a function which outputs, where k is gradually changed from 0 to

$$\max(P_j)$$

as illustrated in FIG. 10(C), a value of k of a convex peak formed by the n th value of

10 $C_j(t_s, k)$

In particular, the in-phase time estimation section 125 of the present example functions as an example of an in-phase time estimation section for estimating the in-phase time information and reliability of the in-phase time information using a result of the correlation analysis by the correlation analysis section 121 and the cycle predicted by the cycle prediction section 124. For example, the in-phase time estimation section 125 can estimate in-phase time information of the input time series signal of a phase same as that at the prediction target time and the reliability information of the in-phase time information, which are information effective to prevent

the problem that the prediction accuracy of the control section 1 deteriorates using the input time series signal to the control section 1, the time series signal of the correlation analysis result of the input time series signal which is an output of the cache memory 122 and the time series information of the prediction result of the cycle of the input time series signal, which is an output of the cycle prediction section 124, till the prediction target time.

10 [0114] (1.4.6) Time Delay Section 126

The time delay section 126 outputs information whose time is delayed by an arbitrary period with respect to arbitrary input information having a time parameter.

The time delay section 126 illustrated in FIG. 5 receives, as an input thereto, prediction information

$$\left\{ \bar{P}(t_c, t_c + \ell) \right\}_{\ell=1}^L$$

of the cycle from time $(t_c + 1)$ to prediction target time $(t_c + L)$ which is an output of the cycle prediction section 124 and outputs

20 $\left\{ \bar{P}(t_c - L, t_c - L + \ell) \right\}_{\ell=1}^L$

whose time parameter is delayed by L.

[0115] (1.4.7) Cache Memory 127

The cache memory 127 is a memory which stores time series information

$$\left\{ \bar{P}(t_c - L, t_c - L + \ell) \right\}_{\ell=1}^L$$

of the prediction value of the cycle which is an output
of the time delay section 126 and outputs an arbitrary
one of pieces of information stored for a fixed period
5 of time in the past.

The cache memory 127 illustrated in FIG. 5 outputs
time series information

$$\left\{ \tilde{P}(\tau - L, \tau) \right\}_{\tau=2 \max(P_j)+L}^{t_c}$$

of the prediction result whose cycle prediction period
10 is L from within the information cached in the past.

[0116] (1.4.8) Difference Processing Section 128

The difference processing section 128 illustrated
in FIG. 5 carries out a difference process for

$$\left\{ P(\tau) \right\}_{\tau=2 \max(P_j)}^{t_c}$$

15 which is part of an output of the cycle estimation section
123 and

$$\left\{ \tilde{P}(\tau - L, \tau) \right\}_{\tau=2 \max(P_j)+L}^{t_c}$$

which is an output of the cache memory 127, and outputs
time series information

20 [0117]

[Expression 57]

$$\{\Delta^L P(\tau)\}_{\tau=2\max(P_i)+L}^{t_c} \equiv \left\{ \|\tilde{P}(\tau-L, \tau) - P(\tau)\| \right\}_{\tau=2\max(P_i)+L}^{t_c}$$

of a prediction error (accuracy) of the output of the cache memory 127.

In particular, the difference processing section 5 128 of the present example can estimate accuracy information of the predicted cycle using a cycle fluctuation estimated by the cycle estimation section 123 and a cycle predicted by the cycle prediction section 124.

[0118] (1.5) Variables Estimation Section 13

10 The variables estimation section 13 estimates variable quantities of arbitrary input information having a time parameter per unit time and outputs the variation quantities.

[0119] The variables estimation section 13 shown in 15 FIG. 5 receives, as an input thereto, an input time series signal

$$\{x(\tau)\}_{\tau=1}^{t_c}$$

to the control section 1 and outputs time series information of the variation per unit time estimated in accordance 20 with the following expressions.

$$\{\Delta x(\tau)\}_{\tau=1}^{t_c}$$

[0120]

[Expression 58]

$$\Delta x(\tau) = [\Delta x_1(\tau) \quad \Delta x_2(\tau) \quad \cdots \quad \Delta x_{D_{im}}(\tau)]$$

[0121]

[Expression 59]

$$\Delta x_j(\tau) = \|x_j(\tau + 1) - x_j(\tau - 1)\|/2$$

5 [0122] (1.6) Cache Memory 14

The cache memory 14 is a memory for storing information

$$I\tilde{x}(t_c + L)$$

of an output calculation procedure which is an output of
10 the model production section 11, and outputs an arbitrary
one of pieces of information stored therein for a fixed
period of time in the past.

The cache memory 14 illustrated in FIG. 5 outputs
a time series

$$15 \left\{ I\tilde{x}(\tau + L) \right\}_{\tau=1}^{t_c}$$

of all information stored therein after time τ till current
time t_c .

[0123] (1.7) Cache Memory 15

The cache memory 15 is a memory for storing a
20 prediction value

$$\tilde{x}(t_c + L)$$

of the prediction target time ($t_c + L$) of the input time series signal to the control section 1 which is an output of the model production section 11, and outputs an arbitrary one of pieces of information stored for a fixed period
 5 of time in the past.

The cache memory 15 illustrated in FIG. 5 outputs a time series

$$\{\tilde{x}(\tau + L)\}_{\tau=1}^{t_c}$$

of all information stored therein after time $\tau = 1$ to current
 10 time t_c .

[0124] (1.8) Prediction Accuracy Estimation Section
 16

The prediction accuracy estimation section 16 evaluates error transition and the effectiveness
 15 (contribution to the prediction) of the sub models 111-1 to 111-S in the prediction in the past and estimates the variation per unit time at the prediction target time of the input time series signal using an input time series signal to the control section 1, time series information
 20 of the variation per unit time of the input time series signal which is an output signal of the variables estimation section 13, time series information of the prediction value at the prediction target time of the input time series signal, which is an output of the model production section
 25 11, and the calculation procedure of the prediction value, in-phase time information of a phase same as that at the

prediction target time of an input time series signal,
which is an output of the cycle fluctuation analysis section
12, and reliability information of the in-phase time
information, and time series information of the prediction
5 accuracy of the cycle fluctuation till the prediction
target time. Then, the prediction accuracy estimation
section 16 outputs the accuracy information of the
prediction value at the prediction target time of the input
time series signal and model design information for the
10 sub models 111-1 to 111-S and the synthesis processing
section 112 for optimum prediction at the target prediction
time.

[0125] An idea of the prediction accuracy estimation
section 16 which estimates accuracy information of the
15 prediction value of the input time series signal at the
prediction target time and model information for optimum
prediction at the target prediction time is described
below.

Generally, where the variation of a time series
20 signal per unit time is great, the prediction accuracy
is low, but where the variation is small, the prediction
accuracy is high. Further, from the difference of the
variation, also a type of a model and a parameter for model
design which are suitable for prediction are difference.
25 In particular, to estimate a variation per unit time of
a time series signal at prediction target time can make
significant information for estimating the prediction

accuracy at the prediction target time and selecting a type of a model or a parameter for model design. Therefore, in the present example, time series information of the variation per unit time of an input time series signal which is an output of the variables estimation section 5 13 is used to estimate the variation per unit time of the time series signal at the prediction target time.

[0126]

Further, generally in the case where a principal 10 component of an input time series signal is seasonal dynamics, there is a fixed correlation between the prediction accuracy at the prediction target time and the prediction accuracy at time of the phase in the past same as the phase at the prediction target time. Therefore, 15 the prediction accuracy estimation section 16 calculates a weighted average error in the case where various design parameters are used for the sub models 111-1 to 111-S and the synthesis processing section 112 from information of the input time series signal, prediction value of the input 20 time series signal at the in-phase time, time series information of the calculation process of the prediction value and variation per unit time of the time series signal at the prediction target time estimated formerly, for example, in the case where the reliability of the in-phase 25 time corresponding to the time at which the phase is same as that at the prediction target time of the input time series signal. Then, the prediction accuracy estimation

section 16 uses information of the evaluation of the same and the variation per unit time of the time series signal at the prediction target time predicted formerly to estimate optimum model design information. Further, the prediction accuracy estimation section 16 determines a result of arbitrary correction carried out when necessary for the weighted average error corresponding to the optimum model design information as an estimated value of the accuracy information of the prediction value.

10 [0127] The prediction accuracy estimation section 16 illustrated in FIGS. 5 and 12 (A) receives, as inputs thereto, an input time series signal

$$\{x(\tau)\}_{\tau=1}^{t_c}$$

time series information

15 $\{\Delta x(\tau)\}_{\tau=1}^{t_c}$

of the variation per unit time of an input time series signal which is an output of the variables estimation section 13, a time series signal

$$\{\tilde{x}(\tau + L)\}_{\tau=1}^{t_c}$$

20 of the prediction value for an input time series signal till now, which is an output of the model production section 11, and time series information

$$\left\{ \mathbf{I}^{\tilde{\mathbf{x}}}(\tau + L) \right\}_{\tau=1}^{t_c}$$

of the calculation procedure of the time series information of the prediction value, in-phase time information

$$\mathbf{T}^L(t_c)$$

- 5 at the prediction target time of an input time series signal which is an output of the cycle fluctuation analysis section 12 and reliability information

$$C_{TL}(t_c)$$

- of the in-phase time information, and time series
10 information

$$\left\{ \Delta^L P(\tau) \right\}_{\tau=2 \max(P_j)+L}^{t_c}$$

of the prediction accuracy of the cycle fluctuation till the prediction target time, and outputs an estimated value [0128]

- 15 [Expression 60]

$$\tilde{\mathbf{e}}(t_c + L) = [\tilde{e}_1(t_c + L) \tilde{e}_2(t_c + L) \cdots \tilde{e}_{D_{im}}(t_c + L)]$$

of the prediction error which is accuracy information of the prediction value at the prediction target time of the input time series signal, an estimated value

- 20 [0129]

[Expression 61]

$$\Delta \tilde{\mathbf{x}}(t_c + L) = [\Delta \tilde{x}_1(t_c + L) \Delta \tilde{x}_2(t_c + L) \cdots \Delta \tilde{x}_{D_{im}}(t_c + L)]$$

of the variation per unit time of the time series signal,
and model design information

$$\mathbf{I}^{\text{model}}(t_c)$$

of the submodels 111-1 to 111-S and the synthesis processing
5 section 112 for optimum prediction at the prediction target
time.

For example, first, an error at the prediction target
time of the input time series signal and an estimated value
of the variation per unit time of the input time series
10 signal with regard to a u th candidate

[0130]

$$\mathbf{I}_{\text{cand}}^{\text{model}}(u), \quad u = 1, 2, \dots, U$$

from among U different kinds of model design information
candidates prepared arbitrarily are defined in the
15 following manner.

[0131]

[Expression 62]

$$\tilde{e}_j^{\text{cand}}(t_c + L, u) = F_j^e \left(\mathbf{I}_{\text{cand}}^{\text{model}}(u), \text{ALL_Input}(t_c) \right)$$

[Expression 63]

$$\Delta \tilde{x}_j^{\text{cand}}(t_c + L, u) = F_j^{\Delta \tilde{x}} \left(\mathbf{I}_{\text{cand}}^{\text{model}}(u), \text{ALL_Input}(t_c) \right)$$

20

Here,

$$F_j^e(\cdot)$$

and

$$F_j^{\Delta \tilde{x}}(\cdot)$$

are functions which rely upon the sub models 111-1 to 111-S and the synthesis processing section 112, respectively,

5 and an argument

[0132]

[Expression 64]

$$\text{ALL.Input}(t_c) = \left\{ \left\{ \mathbf{x}(\tau) \right\}_{\tau=1}^{t_c}, \left\{ \Delta \mathbf{x}(\tau) \right\}_{\tau=1}^{t_c}, \left\{ \tilde{\mathbf{x}}(\tau + L) \right\}_{\tau=1}^{t_c}, \right. \\ \left. \left\{ I^{\tilde{\mathbf{x}}}(\tau + L) \right\}_{\tau=1}^{t_c}, T^L(t_c), C_{T^L}(t_c), \left\{ \Delta^L P(\tau) \right\}_{\tau=2}^{t_c} \right\}_{\tau=2}^{\max(P_j)+L}$$

of the functions is all input information to the cache
10 memory 15.

Then, a number

[0133]

[Expression 65]

$$u^c = \arg_u \min \left(\left\| \tilde{\mathbf{e}}^{\text{cand}}(t_c + L, u) \right\| \right)$$

15 of a candidate which exhibits a minimum prediction error from among all candidates is selected. However,

[0134]

[Expression 66]

$$\tilde{\mathbf{e}}^{\text{cand}}(t_c + L, u) = \left[\tilde{e}_1^{\text{cand}}(t_c + L, u) \quad \tilde{e}_2^{\text{cand}}(t_c + L, u) \quad \dots \quad \tilde{e}_{\text{Dim}}^{\text{cand}}(t_c + L, u) \right]$$

20 From this number of the selected candidate, model design information is determined as given by

[0135]

[Expression 67]

$$I^{\text{model}}(t_c) = I_{\text{cand}}^{\text{model}}(u^c)$$

and also the error at the prediction target time and the estimated value of the variation per unit time of the time series signal are determined in the following manner.

5 [0136]

[Expression 68]

$$\tilde{e}_j(t_c + L) = c_e \cdot \tilde{e}_j^{\text{cand}}(t_c + L, u^c)$$

[Expression 69]

$$\Delta \tilde{x}_j(t_c + L) = c_{\Delta \tilde{x}_j} \cdot \Delta \tilde{x}_j^{\text{cand}}(t_c + L, u^c)$$

10 Here,

$$c_e$$

and

$$c_{\Delta \tilde{x}_j}$$

are individually arbitrary constants.

15 Further, in order to indicate a more particular example, it is assumed that the number S of the sub models 111-1 to 111-S is 1. In this instance, an error at the prediction target time and an estimated value of the variation per unit time of the time series signal may be
20 determined, for example, using a weighted average amount of the actually measured value in the proximity of the time at which the input time series has a phase same as

that at the prediction target time of the input time series signal, as given by the following expressions.

[0137]

[Expression 70]

$$\bar{e}_j(t_c + L) = \begin{cases} \max(e_j) & \dots \text{if } v_j(t_c) = 0 \\ \sum_{m=1}^M \sum_{d \in S_{\Delta L P_j}(T_j^L(t_c, m))} C_{\Delta L P_j}(d) \\ \times \prod_{k=1}^{Dim} I_k^{\tilde{x}}(T_k^L(t_c, m) + d + L, 1, 1) \\ \times F^{e_j}(T_j^L(t_c, m) + d) C_{T_j^L}(t_c, m) \\ \times e_j(T_j^L(t_c, m) + d) / v_j(t_c) & \dots \text{otherwise} \end{cases}$$

5

[Expression 71]

$$\Delta \tilde{x}_j(t_c + L) = \begin{cases} \max(\Delta x_j) & \dots \text{if } v_j(t_c) = 0 \\ \sum_{m=1}^M \sum_{d \in S_{\Delta L P_j}(T_j^L(t_c, m))} C_{\Delta L P_j}(d) \\ \times \prod_{k=1}^{Dim} I_k^{\tilde{x}}(T_k^L(t_c, m) + d + L, 1, 1) \\ \times F^{e_j}(T_j^L(t_c, m) + d) C_{T_j^L}(t_c, m) \\ \times \Delta x_j^L(T_j^L(t_c, m) + d) / v_j(t_c) & \dots \text{otherwise} \end{cases}$$

[Expression 72]

$$v_j(t_c) \equiv \sum_{m=1}^{M_T} \sum_{d \in S_{\Delta L P_j}(T_j^L(t_c, m))} C_{\Delta L P_j}(d) \\ \times \prod_{k=1}^{Dim} I_k^{\tilde{x}}(T_k^L(t_c, m) + d + L, 1, 1) \\ \times F^{e_j}(T_j^L(t_c, m) + d) C_{T_j^L}(t_c, m)$$

10

[Expression 73]

$$F^{e_j}(\tau) = \begin{cases} 0 & \dots \text{ if } \|e_j(\tau)\| > \max(e_j) \\ 1 & \dots \text{ otherwise} \end{cases}$$

[Expression 74]

$$e_j(\tau) \equiv \|x_j(\tau) - \hat{x}_j(\tau)\| \quad \tau = L+1, L+2, \dots, t_c$$

Here,

$$\max(e_j)$$

5

and

$$\max(\Delta x_j)$$

are estimated values of the error which may appear in ordinary prediction for the input time series signal and a maximum value of the variation per unit time of the time series signal. Further, a function

10

$$C_{\Delta L P_j}(d)$$

15

illustrated in FIG. 12(B) is a arbitrary weight function which takes an influence of the error of the cycle prediction at the prediction target time into consideration, and an argument d of the function is determined as given by the following expression.

[0138]

[Expression 75]

$$d \in S_{\Delta^L P_j}(t) = \{x \in \mathbf{Z} \mid x \leq \|R(\|\Delta^L P_j(t)\|)\|\}$$

Here

\mathbf{Z}

is a set of integers, and

$R(\cdot)$

5

is a function which rounds an input and outputs the rounded input.

Meanwhile, as another particular example, an error at the prediction target time and an estimated value of the variation per unit time of the time series signal may be calculated, using a weighted average amount of the actually measured value in the proximity of time in the past which is a neighboring point with the position of the prediction target time from within a locus of the input time series signal, as given by the following expressions.

15

[0139]

[Expression 76]

$$\tilde{e}_j(t_c + L) = \begin{cases} \max(e_j) & \dots \text{if } w_j(t_c) = 0 \\ \sum_{i \in AL(t_c, \delta_e)} \sum_{d \in S_{\Delta^L P_j}(i)} C_{\Delta^L P_j}(d) \\ \times \prod_{k=1}^{Dim} I_k^{\tilde{x}}(i+d, 1, 1) F^{e_j}(i+d) \\ \times e_j(i+d)/w_j(t_c) & \dots \text{otherwise} \end{cases}$$

[Expression 77]

$$\Delta \bar{x}_j(t_c | L) = \begin{cases} \max(\Delta x_j) & \dots \text{if } w_j(t_c) = 0 \\ \sum_{i \in A_L(t_c, \delta_e)} \sum_{d \in S_{\Delta L P_j}(i)} C_{\Delta L P_j}(d) \\ \times \prod_{k=1}^{D_{im}} I_k^{\bar{x}}(i+d, 1, 1) F^{e_j}(i+d) \\ \times \Delta x_j^L(i+d) / w_j(t_c) & \dots \text{otherwise} \end{cases}$$

[Expression 78]

$$w_j(t_c) \equiv \sum_{i \in A} \sum_{d \in S_{\Delta L P_j}(i)} C_{\Delta L P_j}(d) \prod_{k=1}^{D_{im}} I_k^{\bar{x}}(i+d, 1, 1) F^{e_j}(i+d)$$

5 [Expression 79]

$$A_L(t_c, \delta_e) = \{\tau \mid \tau = 1, 2, \dots, t_c, \wedge \|\mathbf{x}(\tau) - \bar{\mathbf{x}}(t_c + L)\| < \delta_e\}$$

Here,

δ_e

is an arbitrary positive constant.

10 It is to be noted that, in the case where the number S of the sub models 111-1 to 111-S is 1 and particulars of the model are decided uniquely as in the particular examples described above,

[Expression 80]

15 $I^{\text{model}}(t_c) = \emptyset$

may be applied.

In particular, the prediction accuracy estimation

section 16 of the present example functions as a prediction accuracy estimation section adapted to estimate model design information for predicting a value of the input time series signal after the predetermined time and
5 accuracy of the prediction of the value of the input time series signal after the predetermined time based on the model design information using the input time series signal, the time series information of a variation per unit time of the input time series signal and the in-phase time
10 information and reliability of the in-phase time information calculated by the cycle fluctuation analysis section 12.

[0140] Further, the prediction accuracy estimation section 16 of the present example can estimate accuracy
15 information of the prediction value of the input time series signal at the prediction target time and model design information of the sub models 111-1 to 111-S and the synthesis processing section 112 for optimum prediction of the target prediction time by evaluating the
20 effectiveness of the error transition and the sub models 111-1 to 111-S in the prediction in the past using the input time series signal to the control section 1, the time series information of the variation per unit time of an input time series signal which is an output of the
25 variables estimation section 13, the time series information of the prediction value at the prediction target time of an input time series signal which is an

output of the model production section 11 and the calculation procedure of the prediction value, and the time series information of the in-phase time information of the same phase as the phase at the prediction target
5 time of an input time series signal which is an output signal of the cycle fluctuation analysis section 12 and the reliability information of the in-phase time information and the prediction accuracy of the cycle fluctuation till the prediction target time, and by
10 estimating the variation per unit time of the input time series at the prediction target time.

[0141] Further, the prediction accuracy estimation section 16 can estimate the model design information using information regarding the calculation procedure of the
15 value of the input time series signal after the predetermined time, which is outputted from the model production section 11.

Further, the prediction accuracy estimation section 16 can estimate prediction accuracy information in the
20 case where the value of the input time series signal after the predetermined time is predicted using the prediction mode described hereinabove.

(1.9) Example of Flow of the Present Control

Here, an example of a flow of the control described
25 above is described with reference to flow charts illustrated in FIGS. 19 to 28.

First, as illustrated in FIG. 19, after the control

described above is started (step S1), the control section 1 determines initial parameters to be used for prediction of an input time series signal after the predetermined time (step S2). The initial parameters include, for
 5 example, $t_c = 1$ as the current time,

$$I^{\text{model}}(1)$$

as the model design information, and L , T_E and M_t as constants. Here, T_E represents the prediction target time.

Then, if, for example, as time series data of the
 10 tumor position, an input time series signal

$$\{x(\tau)\}_{\tau=1}^{t_c}$$

is inputted to the control section 1 (step S3), then the control section 1 switches over processing thereof to the cycle fluctuation analysis section 12 (step S4).

15 After the processing is switched over to the cycle fluctuation analysis section 12 at step S4, the cycle fluctuation analysis section 12 starts processing thereof as illustrated in FIG. 20 (step S12).

Then, if the input time series signal

$$20 \quad \{x(\tau)\}_{\tau=1}^{t_c}$$

is inputted, for example, as time series data of the tumor position from the control section 1 (step S13), then the cycle fluctuation analysis section 12 successively switches over the processing to the correlation analysis

section 121, cycle estimation section 123, cycle prediction section 124, in-phase time estimation section 125 and time delay section 126 (steps S14 to S18), and then the processing by the cycle fluctuation analysis section 12 is ended (step S19).

When the processing is switched over to the correlation analysis section 121 at step S14, the correlation analysis section 121 starts processing thereof as illustrated in FIG. 21 (step S20).

Then, if the input time series signal

$$\{x(\tau)\}_{\tau=1}^{t_c}$$

is inputted, for example, as time series data of the tumor position from the control section 1 (step S21), then the correlation analysis section 121 calculates and outputs

a result

$$C(t_c)$$

of a correlation analysis between part of the input time series signal and the input time series signal (step S22).

Further, the correlation analysis section 121 outputs the time series data

$$\{C(\tau)\}_{\tau=1}^{t_c}$$

of the result of the correlation analysis stored in the cache memory 122 (step S23), and then the processing by the correlation analysis section 121 is ended (step S24).

Then, if the processing is changed over to the cycle estimation section 123 at step S15, then the cycle estimation section 123 starts processing thereof as illustrated in FIG. 22 (step S25).

5 Then, if the time series data

$$\{C(\tau)\}_{\tau=1}^{t_c}$$

for example, of the result of the correlation analysis is inputted from the correlation analysis section 121 (step S26), then the cycle estimation section 123 calculates
10 and outputs time series data

$$\{P(\tau)\}_{\tau=2}^{t_c} \max(P_j)$$

of the estimated value of the cycle of a seasonal component involved in the input time series signal and time series data

15
$$\{C_P(\tau)\}_{\tau=2}^{t_c} \max(P_j)$$

of the reliability value of the time series data of the estimated value (step S27), and then the processing by the cycle estimation section 123 is ended (step S28).

20 Then, if the processing is switched over to the cycle prediction section 124 at step S16, then the cycle prediction section 124 starts processing thereof as illustrated in FIG. 23 (step S29).

Then, if the time series data

$$\{P(\tau)\}_{\tau=2}^{t_c} \max(P_j)$$

of the estimated value of the cycle of the seasonal component involved in the input time series signal described hereinabove and the time series data

$$5 \quad \{C_P(\tau)\}_{\tau=2}^{t_c} \max(P_j)$$

of the reliability value of the time series data of the estimated value are inputted from the cycle estimation section 123 (step S30), then the cycle prediction section 124 calculates and outputs time series data

$$10 \quad \{\tilde{P}(t_c, t_c + \ell)\}_{\ell=1}^L$$

obtained by prediction of the cycle of the seasonal component involved in the input time series signal till the prediction target time ($t_c + L$) (step S31), and then the processing by the cycle prediction section 124 is ended (step S32).

Then, when the processing is switched over to the in-phase time estimation section 125 at step S17, the in-phase time estimation section 125 starts processing thereof as illustrated in FIG. 24 (step S33).

20 Then, when the in-phase time estimation section 125 receives, as an input thereto, the input time series signal

$$\{x(\tau)\}_{\tau=1}^{t_c}$$

for example, as time series data of the tumor position,

from the control section 1 (step S34) and further receives,
as another input thereto, the time series data

$$\{C(\tau)\}_{\tau=1}^{t_c}$$

of the result of the correlation analysis from the
5 correlation analysis section 121 (step S35) and besides
receives, as a further input thereto, the time series data

$$\{\tilde{P}(t_c, t_c + \ell)\}_{\ell=1}^L$$

of the cycle prediction result from the cycle prediction
section 124 (step S36), the in-phase time estimation
10 section 125 calculates and outputs time at which the phase
is same as that of the seasonal component involved in the
input time series signal (for example, the tumor position
at the prediction target time or the like)

$$x(t_c + L)$$

15 at the prediction target time

$$T^L(t_c)$$

and the reliability

$$C_{TL}(t_c)$$

of the time of the same phase (step S37), and the processing
20 by the in-phase time estimation section 125 is ended (step
S38). It is to be noted that, for example, M_t values of
the time at which the phase is same as that of the seasonal

component involved in the input time series signal

$$x(t_c + L)$$

at the prediction target time may be calculated in order, for example, from the newest one.

5 Then, when the processing is switched over to the cycle fluctuation analysis section 12 at step S18, the time delay section 126 starts processing thereof as illustrated in FIG. 25 (step S39).

Then, if the time series data

$$10 \quad \left\{ \tilde{P}(t_c, t_c + \ell) \right\}_{\ell=1}^L$$

of the cycle prediction result is inputted from the cycle prediction section 124 (step S40), then the time delay section 126 calculates and outputs

$$\left\{ \tilde{P}(t_c, t_c + \ell) \right\}_{\ell=1}^L$$

15 in which the time parameters of the input time series

$$\left\{ \bar{P}(t_c - L, t_c - L + \ell) \right\}_{\ell=1}^L$$

are delayed by L (step S41), and the processing by the time delay section 126 is ended (step S42).

20 After the processing by the cycle fluctuation analysis section 12 comes to an end, referring back to FIG. 19, the control section 1 switches over the processing to the variables estimation section 13 (step S5).

After the processing is switched over to the

variables estimation section 13 at step S5, the variables estimation section 13 starts processing thereof as illustrated in FIG. 26 (step S43).

Then, if the input time series signal

$$5 \quad \{x(\tau)\}_{\tau=1}^{t_c}$$

is inputted, for example, as the time series data of the tumor position, from the control section 1 (step S44), then the variables estimation section 13 calculates and outputs time series data

$$10 \quad \{\Delta x(\tau)\}_{\tau=1}^{t_c}$$

of the variation per unit time of the input time series signal (step S45), and then the processing by the variables estimation section 13 is ended (step S46).

After the processing by the variables estimation section 13 comes to an end, referring back to FIG. 19, the control section 1 switches over the processing to the model production section 11 (step S6).

After the processing is switched over to the model production section 11 at step S6, the model production section 11 starts processing thereof as illustrated in FIG. 27 (step S47).

Then, if the model production section 11 receives, as an input thereto, the input time series signal

$$\{x(\tau)\}_{\tau=1}^{t_c}$$

for example, as time series data of the tumor position,
from the control section 1 (step S48) and receives, as
inputs thereto, the time

$$T^L(t_c)$$

5 at which the phase is same as that of the seasonal component
involved in the input time series signal (for example,
the tumor position at the prediction target time and so
forth)

$$x(t_c + L)$$

10 at the prediction target time and the reliability

$$C_{TL}(t_c)$$

of the time from the in-phase time estimation section 125
(step S49) and besides receives, as an input thereto, the
model design information

15 $I^{\text{model}}(t_c)$

from the control section 1 (step S6), then the model
production section 11 designs the sub models 111-1 to 111-S
based on the model design information

$$I^{\text{model}}(t_c)$$

20 and uses the other input information

$$\{x(\tau)\}_{\tau=1}^{t_c}$$

$$T^L(t_c)$$

and

$$C_{TL}(t_c)$$

to calculate the prediction time series signal (for example,
5 the predicted tumor position and so forth)

$$\tilde{x}(t_c + L)$$

of the input time series signal after the predetermined
time and outputs the calculated prediction time series
signal, and then outputs

$$10 \quad T^{\tilde{x}}(t_c + L)$$

as detailed information regarding the calculation
procedure (step S51), whereafter the processing by the
model production section 11 is ended (step S52).

After the processing by the model production section
15 11 comes to an end, referring back to FIG. 19, the control
section 1 switches over the processing to the prediction
accuracy estimation section 16 (step S7).

After the processing is switched over to the
prediction accuracy estimation section 16 at step S7, the
20 prediction accuracy estimation section 16 starts
processing thereof as illustrated in FIG. 28 (step S53).

Then, if the prediction accuracy estimation section
16 receives, as an input thereto, the input time series

signal

$$\{\mathbf{x}(\tau)\}_{\tau=1}^{t_c}$$

for example, as the time series data of the tumor position,
from the control section 1 (step S54), receives, as inputs
5 thereto, the time series data

$$\{\Delta\mathbf{x}(\tau)\}_{\tau=1}^{t_c}$$

of the variation per unit time of the input time series
signal from the variables estimation section 13 (step S55),
receives, as inputs thereto, time

10 $T^L(t_c)$

and the reliability

$$C_{TL}(t_c)$$

of the time at which the phase is same as that of the seasonal
component involved in the input time series signal (for
15 example, the tumor position at the prediction target time
and so forth)

$$\mathbf{x}(t_c + L)$$

at the prediction target from the in-phase time estimation
section 125 (step S56) and receives, as inputs thereto,
20 the time series data

$$\{\tilde{\mathbf{x}}(\tau + L)\}_{\tau=1}^{t_c}$$

of the prediction result carried out in the past and detailed information

$$\left\{ I^{\tilde{x}}(\tau + L) \right\}_{\tau=1}^{t_c}$$

regarding the calculation procedure of the prediction from
 5 the model production section 11 through the cache memory
 14 and the cache memory 15 (steps S57 and S58), then the
 prediction accuracy estimation section 16 determines and
 outputs model design information

$$I^{\text{model}}(t_c)$$

10 optimum for prediction using the input information
 mentioned hereinabove and calculates and outputs the
 prediction value

$$\bar{e}(t_c + L)$$

of the error of the predicted tumor position

$$15 \quad \tilde{x}(t_c + L)$$

and the prediction value

$$\Delta \tilde{x}(t_c + L)$$

of the variation per unit time at the predicted tumor
 position

$$20 \quad \tilde{x}(t_c + L)$$

(step S59), and then the processing by the prediction

accuracy estimation section 16 is ended (step S60).

After the processing by the prediction accuracy estimation section 16 comes to an end, referring back to FIG. 19, the control section 1 outputs the prediction value

5 $\tilde{x}(t_c + L)$

of the tumor position, the prediction value (prediction value of the tumor speed)

$$\Delta\tilde{x}(t_c + L)$$

10 of the variation per unit time at the predicted tumor position

$$\tilde{x}(t_c + L)$$

and the prediction value

$$\tilde{e}(t_c + L)$$

of the error of the predicted tumor position (step S8).

15 Then, the control section 1 increments the preset time t_c to update the time (step S9) and decides whether or not the updated time is smaller than prediction end time T_E (step S10).

20 Here, in the case where the control section 1 decides that the updated time is smaller than the prediction end time T_E (Yes route at step S10), the processes at steps S3 to S9 in FIG. 19 are repeated.

On the other hand, if the control section 1 decides

that the updated time is greater than the prediction end time T_E (No route at step S10), then the prediction process is ended (step S11).

[0142] (1.10) Experiment Example

5 The effectiveness of the prediction function by the control section 1 described above is described based on an example of an experiment in which a time series signal of the observation position of an actual affected area 260 is used.

10 [0143] FIG. 13 is a view of the time series signal of an observation position of a certain affected area 260 plotted on a three-dimensional space. Further, if components of the time series signal for individual three-dimensional directions are represented as a graph,
15 then such a time series signal as illustrated in FIG. 14 is obtained. Here, the scale of the axis of ordinate is millimeter (mm) and the scale of the axis of abscissa is 0.33 seconds/step. From FIG. 13, it can be seen that a principal component of the input time series signal is
20 seasonal dynamics whose behavior is monotonous and stable. It is to be noted that it is found by a correlation analysis that the cycle of the input time series signal is time-variable.

[0144] In the present example, a trend component was
25 separated by calculating a moving average of the input time series signal in the length of the cycle, and the residual time series signal was separated into a seasonal

component and other stationary components by calculating a difference of the value delayed by time of the length of the cycle from the residual time series signal. A result when a value of a time series signal of each component
5 as a time series signal after filter processing used as an object of the sub models 111-1 to 111-S ($S = 3$) later by 30 steps [$L = 30$ (approximately one second)] is illustrated in FIG. 15, and a result when an input time series signal is predicted as a synthesis of the outputs
10 is illustrated in FIG. 16(A). Here, a blue line corresponds to an actually measured value and a red line corresponds to a result of the prediction, and x_j^T , x_j^P , x_j^A , $j = 1, 2, 3$ in FIG. 15 represent sub time series corresponding to a trend component, a seasonal component
15 and a stationary component of j th directional direction data, respectively. For comparison, also a result when the input time series signal was predicted using a conventional general SARIMA mode is shown in FIG. 17. Here, a green line corresponds to a result of prediction with
20 an ARMA model. It is to be noted that, in the figures, the axis of abscissa is restricted to an interval of 2000 steps through 4000 steps so that it can be visually observed well.

[0145] From the result of FIG. 15, it can be recognized
25 that the accuracy of the prediction for the seasonal component is good in comparison with the prediction accuracy for the trend component and the stationary

component. In the present example, the prediction accuracy estimation section 16 detects this situation by evaluation of actual results of prediction in the past, and sets the prediction model of the trend component as
5 a zero-order hold model and produces model design information wherein the ratio of the result of the prediction of the seasonal component to the entire prediction result is increased while the ratio of the prediction result of the stationary component to the entire
10 prediction result is decreased. From the result shown in FIG. 16(A), it can be recognized that the accuracy of the prediction result of the input time series signal obtained by synthesizing all components is better than that according to the conventional general SARIMA model shown
15 in FIG. 17.

[0146] The error at the prediction target time estimated by the prediction accuracy estimation section 16 and the time series information of the variation per unit time of the time series signal are shown in FIGS.
20 16(B) and 16(C), respectively. Here, a blue line corresponds to an actually measured value, and a red line corresponds to an estimated value. From those results, it can be recognized that the estimation result by the prediction accuracy estimation section of the present
25 example has a high correlation with the actually measured value.

Further, a variation of the average prediction error

where the length L of the prediction period is varied is shown in FIG. 18. The axis of abscissa of FIG. 8 indicates the prediction interval (L), and the axis of ordinate indicates the average value of the prediction error. It is to be noted that a result denoted by "Zero-order hold" in the figure represents an error in the case where the latest data of the input time series signal is used as it is as a prediction value. As shown in FIG. 18, it can be recognized that, for mid-range prediction more than 5 steps (0.167 seconds), the prediction method of the present example is effective.

[0147] In this manner, since the control section 1 of the present embodiment can carry out long term (approximately one second) prediction of the movement of the affected area 260 and estimation of prediction accuracy information of the same, for example, prior to time required for irradiation range formation control of the MLC 210, the MLC 210 can be driven and controlled. As a result, continuous radiation irradiation following up the movement of the affected area 260 can be implemented.

Incidentally, it can be recognized that a specific variation of the dynamics appears in the proximity of the 3700th step of the input time series signal. In the present example, since the prediction accuracy estimation section 16 carries out collation and analysis of result information (error and variation of the time series signal per unit time) of prediction in the past corresponding to the latest

prediction, such a specific variation of the dynamics can be detected from the fact that the error and the estimated value of the variation of the time series signal per unit time exhibit assumed maximum values (the outputs at the
5 relevant portions of FIGS. 16(B) and 16(C) are saturated). In particular, in the case where the specific variation of the dynamics continues for a long period and radiation irradiation by accurate prediction and follow-up of the movement of the affected area 260 are difficult, it is
10 possible to stop the irradiation of the radiation based on the detection information thereby to prevent irradiation upon normal cells other than those of the affected area 260.

[0148] From the results described above, it can be
15 recognized that the method of the present example that "an arbitrary time series signal whose principal component is cycle time-variable seasonal dynamics is used to synthesize a plurality of sub models taking an influence of the cycle time variation into consideration and based
20 on information of a prediction result in the past to carry out prediction and estimate the accuracy of the prediction" is effective.

Further, also it is possible for the cycle fluctuation analysis section 12 of the present example
25 to carry out processes in the case where a plurality of values are set arbitrarily for

[Expression 81]

$$C_j(t_c, k) = \begin{cases} 0 & \dots \text{ if } t_g < 2 \max(P_j) \\ \frac{\sum_{\ell=1}^{\max(P_j)} (y_j(t_c, 0, \ell) - \bar{y}_j(t_c, 0))(y_j(t_c, k, \ell) - \bar{y}_j(t_c, k))}{\sqrt{\sum_{\ell=1}^{\max(P_j)} (y_j(t_c, 0, \ell) - \bar{y}_j(t_c, 0))^2} \sqrt{\sum_{\ell=1}^{\max(P_j)} (y_j(t_c, k, \ell) - \bar{y}_j(t_c, k))^2}} & \dots \text{ otherwise} \end{cases}$$

$$y_j(t_c, k, \ell) \equiv x_j(t_c - \max(P_j) + \ell - k)$$

$$\bar{y}_j(t_c, k) \equiv \frac{1}{\max(P_j)} \sum_{\ell=1}^{\max(P_j)} x(t_c, k, \ell)$$

5 and

$$\max(P_j)$$

in the process

$\bar{y}_j(t_c, k)$ of the correlation analysis section 121

simultaneously and in parallel.

10 This signifies that the correlation analysis section 121 sets a plurality of calculation expressions or data ranges arbitrarily for correlation analysis and calculates

$$T^L(t_c),$$

$$C_{TL}^L(t_c)$$

15 and

[Expression 57]

$$\{\Delta^L P(\tau)\}_{\tau=2 \max(P_j)+L}^{t_c} \equiv \left\{ \|\tilde{P}(\tau-L, \tau) - P(\tau)\| \right\}_{\tau=2 \max(P_j)+L}^{t_c}$$

of the individual settings simultaneously and in parallel.

Further, the prediction accuracy estimation section
16 can use

$$T^L(t_c),$$

5 $C_{TL}(t_c)$

and

[Expression 57]

$$\{\Delta^L P(\tau)\}_{\tau=2 \max(P_j)+L}^{t_c} \equiv \left\{ \|\tilde{P}(\tau-L, \tau) - P(\tau)\| \right\}_{\tau=2 \max(P_j)+L}^{t_c}$$

calculated simultaneously and in parallel by the cycle
10 fluctuation analysis section 12 to estimate more various
model design information

$$I^{\text{model}}(t_c)$$

In this instance, for example, the model production
section 11 can produce a variety of sub models 111-1 to
15 111-S which are different from each other not only in the
type or the parameter value of the filters and the models
but also in combination with the values of

$$\max(P_j)$$

and

20 $\bar{y}_j(t_c, k)$

Here, if the prediction method of the present example
before the improvement described above wherein a plurality

of values are set for

$$\max(P_j)$$

and

$$\bar{y}_j(t_c, k)$$

5 to diversify the sub models is applied is referred to as
 "prediction method (1) of the present example" and the
 prediction method of the present example after the
 improvement described above is applied is referred to as
 "prediction method (2) of the present example", then the
 10 relationship between the prediction interval length and
 the prediction error is such as shown in FIG. 31. As shown
 in FIG. 31, it can be recognized that the prediction method
 (1) of the present example is effective in comparison with
 a seasonal adjustment index soothing method or a prediction
 15 method based on a SARIMA model which are examples of a
 conventional prediction method, and further, the
 prediction method (2) of the present example is more
 effective than the prediction method (1) of the present
 example.

20 [0149] [2] Others

It is to be noted that the functions as the control
 section 1 described hereinabove may be implemented by a
 computer (including a CPU, an information processing
 apparatus, and various terminals) executing a
 25 predetermined application program (signal processing
 program).

[0150] In particular, the program described above is a signal processing program for causing, in the control section 1 for predicting a value of an input time series signal after predetermined time, a computer to implement
5 the above-described prediction function, the signal processing program causing the computer to implement a cycle fluctuation analysis function for assuming a certain component of an input time series signal as a time series signal whose cycle varies with respect to time to carry
10 out a correlation analysis between part of the input time series signal and the input time series signal, estimating a cycle fluctuation of the input time series signal and reliability of the cycle fluctuation using a result of the correlation analysis, predicting a cycle of the input
15 time series signal after predetermined time using the cycle fluctuation and the reliability of the cycle fluctuation and calculating, using the result of the correlation analysis and the predicted cycle, in-phase time information which represents time of the input time series
20 signal whose phase becomes same as a phase of the input time series signal after the predetermined time and the reliability of the in-phase time information, a prediction accuracy estimation function for estimating model design information for predicting a value of the input time series
25 signal after the predetermined time and accuracy of the prediction of the value of the input time series signal after the predetermined time based on the model design

information using the input time series signal, the time series information of a variation per unit time of the input time series signal and the in-phase time information and reliability of the in-phase time information

5 calculated by the cycle fluctuation analysis function, and a model production function for producing, using the input time series signal, the in-phase time information and the reliability of the in-phase time information calculated by the cycle fluctuation analysis function and

10 the model design information estimated by the prediction accuracy estimation function, a prediction model for predicting the value of the input time series signal after the predetermined time and predicting and outputting the value of the input time series signal after the

15 predetermined time using the prediction model.

[0151] Further, the program described above can be provided in a form in which it is recorded on or in a computer-readable recording medium such as, for example, a flexible disk, a CD (CD-ROM, CD-R, CD-RW or the like)

20 or a DVD (DVD-ROM, DVD-RAM, DVD-R, DVD-RW, DVD+R, DVD+RW or the like). In this instance, a computer can read the signal processing program from the recording medium, transfer and store the signal processing program to and into an internal storage device or an external storage

25 device and then use the signal processing program. Or, the program may be recorded on a storage device (recording medium) such as, for example, a magnetic disk, an optical

disk or a magneto-optical disk such that it is provided from the storage device to a computer through a communication line.

[0152] Here, the computer is a concept including
5 hardware and an OS (operating system) and signifies hardware which operates under the control of the OS. Further, in such a case that an OS is unnecessary and hardware can be operated solely by an application program, the hardware itself corresponds to a computer. The
10 hardware includes at least a microprocessor such as a CPU and means for reading a computer program recorded in or on a recording medium.

[0153] An application program as the signal processing program described above includes program codes
15 for causing such a computer as described above to implement the functions as the control section 1. Further, some of the functions may be implemented not by an application program but by an OS.

It is to be noted that also it is possible to utilize,
20 as the recording medium as the present embodiment, various computer-readable media such as an IC card, a ROM cartridge, a magnetic tape, a punched card, an internal storage device of a computer (a memory such as a RAM or a ROM), an external storage device, a printed matter on which codes such as
25 bar codes are printed and so forth in addition to a flexible disk, a CD, a DVD, a magnetic disk, an optical disk and a magneto-optical disk described hereinabove.

[0154] Further, the configurations and the processes of the radiotherapy apparatus and the control section 1 described hereinabove may be selectively used as occasion demands or may be combined suitably.

5 For example, while, in the examples described hereinabove, the prediction accuracy estimation section 16 uses information regarding a calculation process of a value of an input time series signal after predetermined time, which is outputted from the model production section
10 11, to set model design information, also it is possible to omit this estimation process.

Further, while, in the examples described hereinabove, an input time series signal is separated into a trend component, a seasonal component and a stationary
15 component and a prediction model is applied to each of them to carry out prediction of the input time series signal, one of the components may be selectively separated from an input time series signal and used for the prediction process.

20 [0155] For example, similar effects to those described hereinabove can be obtained even if only a seasonal component which has a periodicity stronger than the other signal components involved in an input time series signal is separated to apply a predetermined prediction
25 model.

Also it is possible to apply the signal processing method of the present example, for example, to a system

which predicts the height of a wave or a position fluctuation arising from the beat of the heart. For example, by predicting a position fluctuation arising from the beat of the heart by the signal processing method described
5 hereinabove, it is possible to implement a system which issues a warning with regard to by what degree the beat of the heart is displaced from that in a normal state (such as arrhythmia).

[0156] Furthermore, also it is possible to apply the
10 signal processing method of the present example to power demand forecast, prediction of the communication amount of the Internet or the server load and so forth.

Industrial Applicability

[0157] As described in detail above, according to the
15 present invention, an input time series signal at an affected area position can be predicted accurately and for a longer period of time in comparison with that in an alternative case in which an autoregressive model is applied simply to an input time series signal obtained
20 using an observation signal of an affected area position to carry out prediction as in the prior art. Accordingly, it is possible to implement radiation irradiation which follows up a movement of the affected area position and the present invention is considered very useful in the
25 field of the radiation irradiation.

Description of Reference Characters

[0158] 1 control section

11 model production section
12 cycle fluctuation analysis section
13 variables estimation section
14 cache memory
5 15 cache memory
16 prediction accuracy estimation section
100 klystron
110 cooling apparatus
111-1 sub model 1
10 111-2 sub model 2
111-S sub model S
120 waveguide
121 correlation analysis section
122 cache memory
15 123 cycle estimation section
124 cycle prediction section
125 in-phase time estimation section
126 time delay section
127 cache memory
20 128 difference processing section
130 vacuum pump
140 electron gun
150 accelerating tube
160 bending magnet
25 170 target
180 flattening filter (scattering foil)
190 dosimeter

200 JAW (irradiation field formation section)
210 MLC (multi leaf collimator)
220 OBI
230 bed
5 240 EPID
250 pulse modulator
301 driving controlling section
302-1, 302-2 driving section
303 leaf
10 304 radiation irradiation field
305 X-ray irradiation section
306 sensor panel

31918-1

CLAIMS:

1. A radiotherapy apparatus for irradiating a radiation on an affected area of a patient, the radiotherapy apparatus comprising:

5 a radiation generation section adapted to generate the radiation;

a measurement section adapted to measure a position of the affected area; and

a signal processing apparatus, comprising:

10 a cycle fluctuation analysis section adapted to assume an input time series signal, which represents values at respective time points until a first time point, as a time series signal whose cycle length, which is a length of a cycle, varies with respect to time to carry out a correlation analysis
 15 between part of the input time series signal and the input time series signal, calculate multiple cycle lengths, which are respectively at different time points, as a cycle length fluctuation of the input time series signal and reliability of the cycle length fluctuation using a result of the correlation
 20 analysis, predict a cycle length of the time series signal until a second time point after the first time point using the cycle length fluctuation and the reliability of the cycle length fluctuation and calculate, using the result of the correlation analysis and the predicted cycle length, in-phase time
 25 information, which represents a time point before the second time point in the input time series signal, and reliability of the in-phase time information, a phase at the time point in the

31918-1

input time series signal becoming same as a phase at the second time point in the time series signal;

a prediction accuracy estimation section adapted to estimate model design information for predicting a value of the time series signal at the second time point and accuracy of the prediction of the value of the time series signal at the second time point using the input time series signal, the time series information of a variation per unit time of the value and the in-phase time information and the reliability of the in-phase time information calculated by said cycle fluctuation analysis section, the accuracy being based on the estimated model design information; and

a model production section adapted to produce, using the input time series signal, the in-phase time information and the reliability of the in-phase time information calculated by said cycle fluctuation analysis section and the model design information estimated by said prediction accuracy estimation section, a prediction model for predicting the value of the time series signal at the second time point and predict and output the value of the time series signal at the second time point using the prediction model, wherein

said signal processing apparatus is adapted to predict a position of the affected area at the second time point and estimate accuracy information of the prediction position using, as the input time series signal, a time series signal regarding the position of the affected area measured by said measurement section, and

the radiotherapy apparatus comprises a controlling section adapted to control an irradiation of the generated

31918-1

radiation from said radiation generation section using the position, which is predicted by said signal processing apparatus, of the affected area at the second time point.

2. The radiotherapy apparatus according to claim 1,
5 wherein said prediction accuracy estimation section estimates the model design information using information outputted from said model production section regarding a calculation process of the value of the time series signal at the second time point.

3. The radiotherapy apparatus according to claim 1 or
10 claim 2, wherein said cycle fluctuation analysis section includes:

a correlation analysis section for carrying out a correlation analysis between part of the input time series signal and the input time series signal;

15 a cycle estimation section for estimating the cycle length fluctuation and the reliability of the cycle length fluctuation using a result of the analysis by said correlation analysis section;

20 a cycle prediction section for predicting the cycle length of the time series signal until the second time point after the first time point using the cycle length fluctuation and the reliability of the cycle length fluctuation estimated by said cycle estimation section; and

25 an in-phase time estimation section for estimating the in-phase time information and the reliability of the in-phase time information using a result of the correlation analysis by said correlation analysis section and the cycle length predicted by said cycle prediction section.

31918-1

4. The radiotherapy apparatus according to any one of claims 1 to 3, wherein said model production section produces the prediction model using a plurality of sub models whose structures or characteristics are different from each other.

5 5. The radiotherapy apparatus according to claim 4, wherein said plurality of sub models includes at least one of a SARIMA (Seasonal Auto-Regressive Integrated Moving Average) model, a seasonal adjustment index smoothing method model, a non-linear ARIMA (Auto-Regressive Integrated Moving Average)
10 model and a soft computing model.

6. The radiotherapy apparatus according to claim 4 or claim 5, wherein said model production section changes the sub models using the accuracy of the prediction of the value of the time series signal at the second time point estimated by said
15 prediction accuracy estimation section.

7. The radiotherapy apparatus according to any one of claims 1 to 6, wherein said controlling section comprises:

a collimator section adapted to form an irradiation range of the radiation generated from said radiation generation
20 section into a desired shape;

a driving controlling section adapted to calculate, using the position, which is predicted by said signal processing apparatus, of the affected area at the second time point and the accuracy information estimated by said signal processing
25 apparatus, an irradiation position and an irradiation range of the radiation and control and drive said collimator section based on a result of the calculation.

31918-1

8. The radiotherapy apparatus according to claim 7, wherein said controlling section comprises:

5 a timing controlling section adapted to control a generation timing of the radiation by said radiation generation section using the position of the affected area at the second time point and the accuracy information estimated by said signal processing apparatus.

9. The radiotherapy apparatus according to any one of claims 1 to 6, wherein said controlling section adapted to control an irradiation timing of the radiation by said radiation generation section using the position, which is predicted by said signal processing apparatus, of the affected area at the second time point and the accuracy information estimated by said signal processing apparatus.

10. The radiotherapy apparatus according to claim 7 or claim 8, wherein the driving controlling section controls and drives said collimator section in such a manner that the irradiation position follows up the position of the affected area.

11. The radiotherapy apparatus according to claim 7 or claim 8, wherein the driving controlling section controls at least one of said radiation generation section and said collimator section in such a manner that the radiation is not irradiated on the patient in the case that a variation of the input time series signal per unit time is equal to or larger than a predetermined threshold value.

12. The radiotherapy apparatus according to claim 9, wherein the controlling section controls said radiation

31918-1

generation section in such a manner that the radiation is not irradiated on the patient in the case that a variation of the input time series signal per unit time is equal to or larger than a predetermined threshold value.

5 13. A non-transitory computer-readable recording medium storing a signal processing program for causing, in a radio radiotherapy apparatus for irradiating a radiation on an affected area of a patient comprising a radiation generation section for generating the radiation, a measurement section for
10 measuring a position of the affected area, and a signal processing apparatus for predicting a value of a time series signal at a second time point after a first time point, a computer to implement a prediction function that is stored, the signal processing program causing the computer to implement:

15 a cycle fluctuation analysis function for assuming an input time series signal, which represents values at respective time points until the first time point, as the time series signal whose cycle length, which is a length of a cycle, varies with respect to time to carry out a correlation analysis between
20 part of the input time series signal and the input time series signal, calculating multiple cycle lengths, which are respectively at different time points, as a cycle length fluctuation of the input time series signal and reliability of the cycle length fluctuation using a result of the correlation
25 analysis, predicting a cycle length of the time series signal until the second time point using the cycle length fluctuation and the reliability of the cycle length fluctuation and calculating, using the result of the correlation analysis and the predicted cycle length, in-phase time information, which
30 represents a time point before the second time point in the

31918-1

input time series signal, and reliability of the in-phase time information, a phase at the time point in the input time series signal becoming same as a phase at the second time point in the time series signal;

5 a prediction accuracy estimation function for estimating model design information for predicting a value of the time series signal at the second time point and accuracy of the prediction of the value of the time series signal at the second time point using the input time series signal, the time
10 series information of a variation per unit time of the value and the in-phase time information and the reliability of the in-phase time information calculated by said cycle fluctuation analysis function, the accuracy being based on the estimated model design information; and

15 a model production function for producing, using the input time series signal, the in-phase time information and the reliability of the in-phase time information calculated by said cycle fluctuation analysis function and the model design
20 information estimated by said prediction accuracy estimation function, a prediction model for predicting the value of the time series signal at the second time point and predicting and outputting the value of the time series signal at the second time point using the prediction model, wherein

25 said signal processing apparatus is adapted to predict a position of the affected area at the second time point and estimate accuracy information of the prediction position using, as the input time series signal, a time series signal regarding the position of the affected area measured by said measurement section, and

31918-1

the radiotherapy apparatus comprises a controlling section adapted to control an irradiation of the generated radiation from said radiation generation section using the position, which is predicted by said signal processing apparatus, of the affected area at the second time point.

1/31
FIG. 1

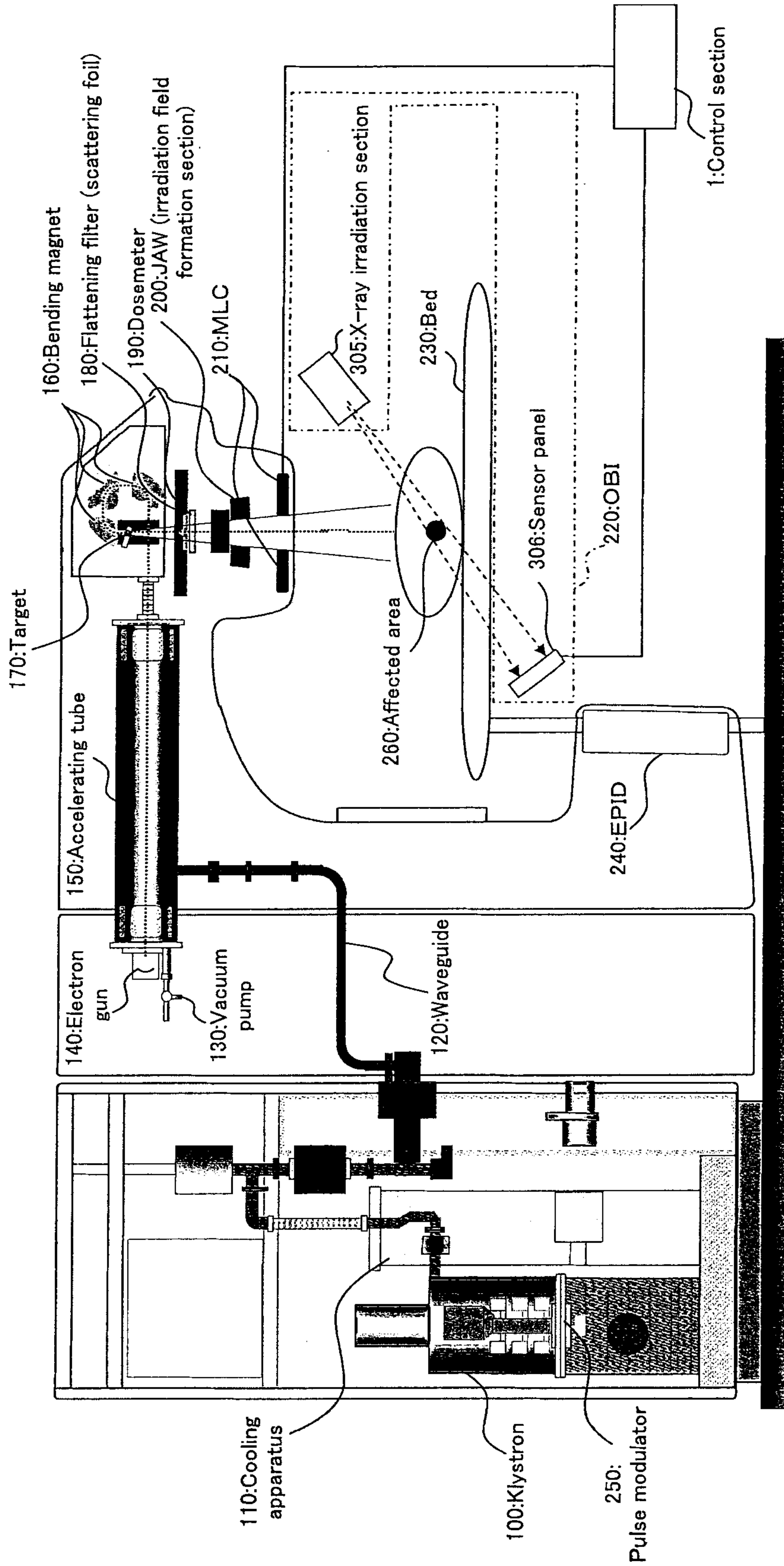

2/31
FIG. 2

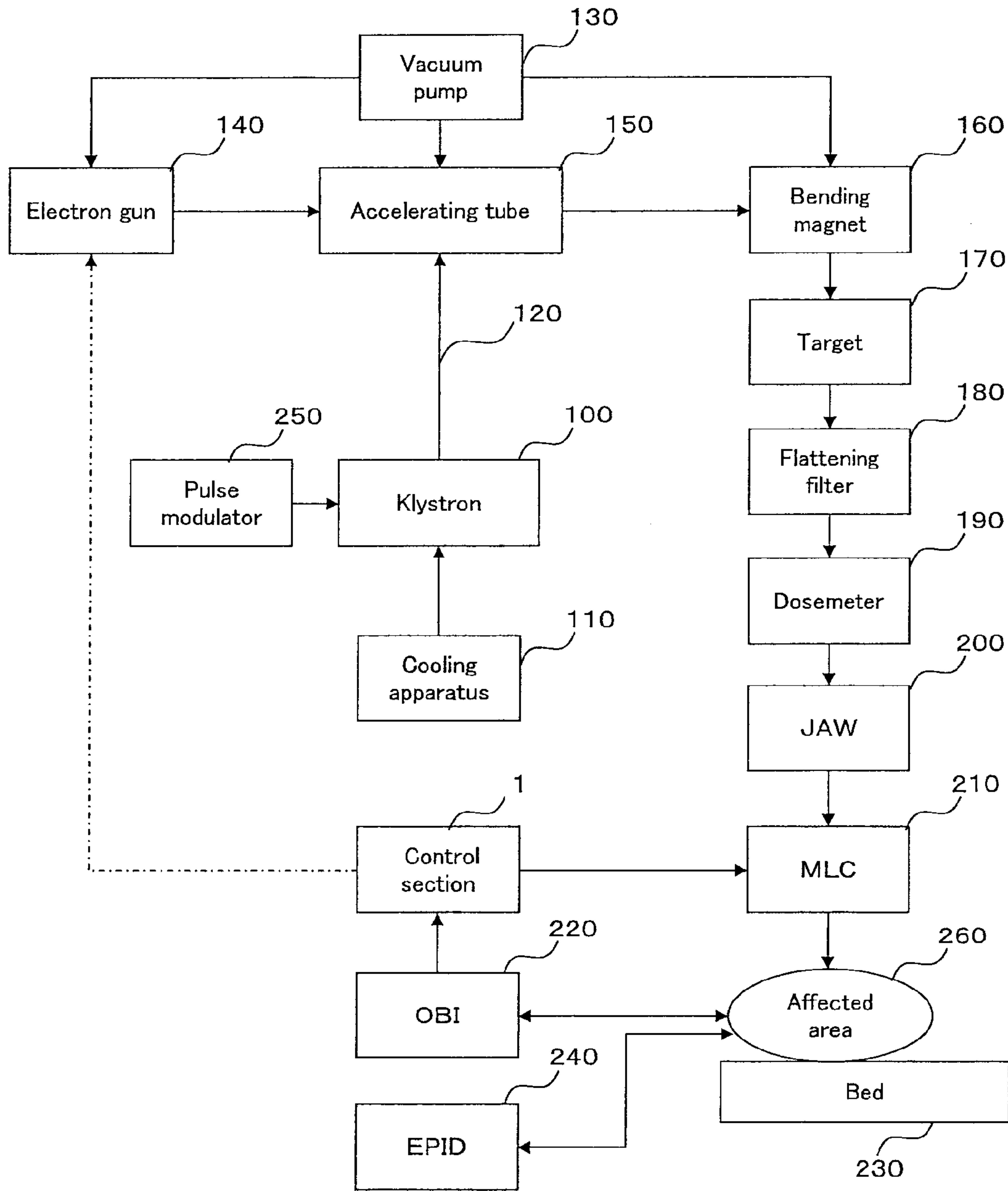

3/31
FIG. 3

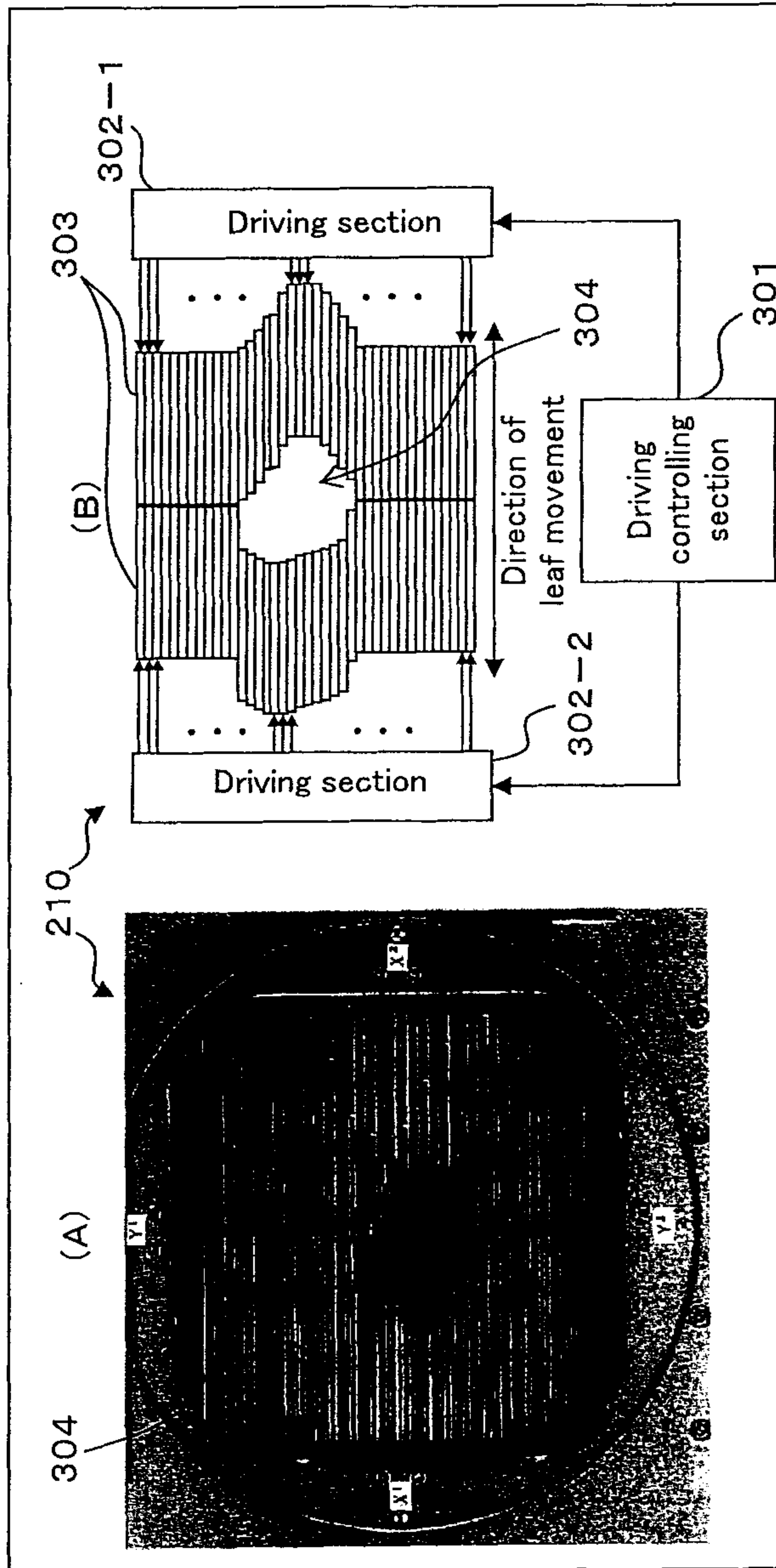

4/31
FIG. 4

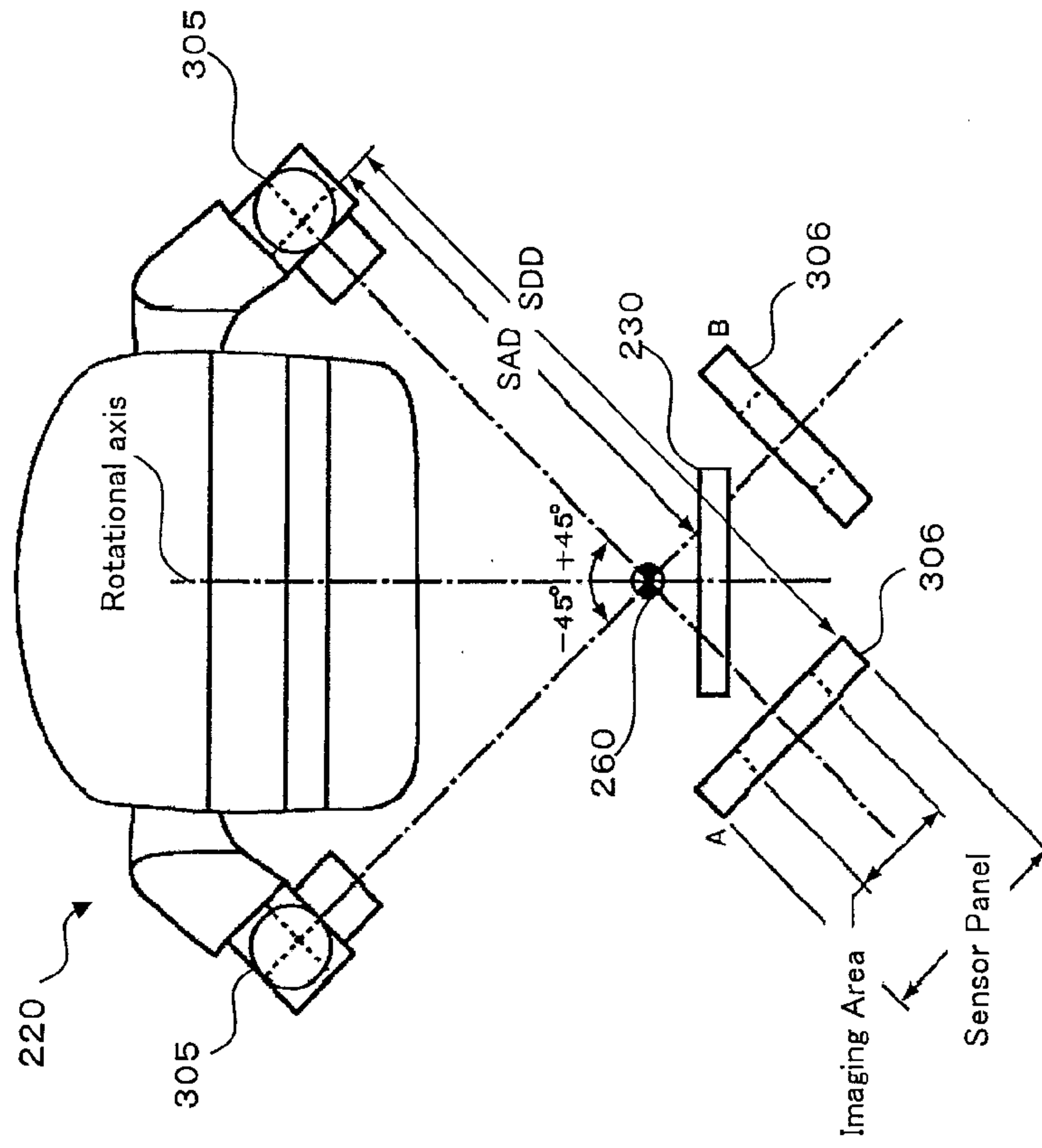

5/31
FIG. 5

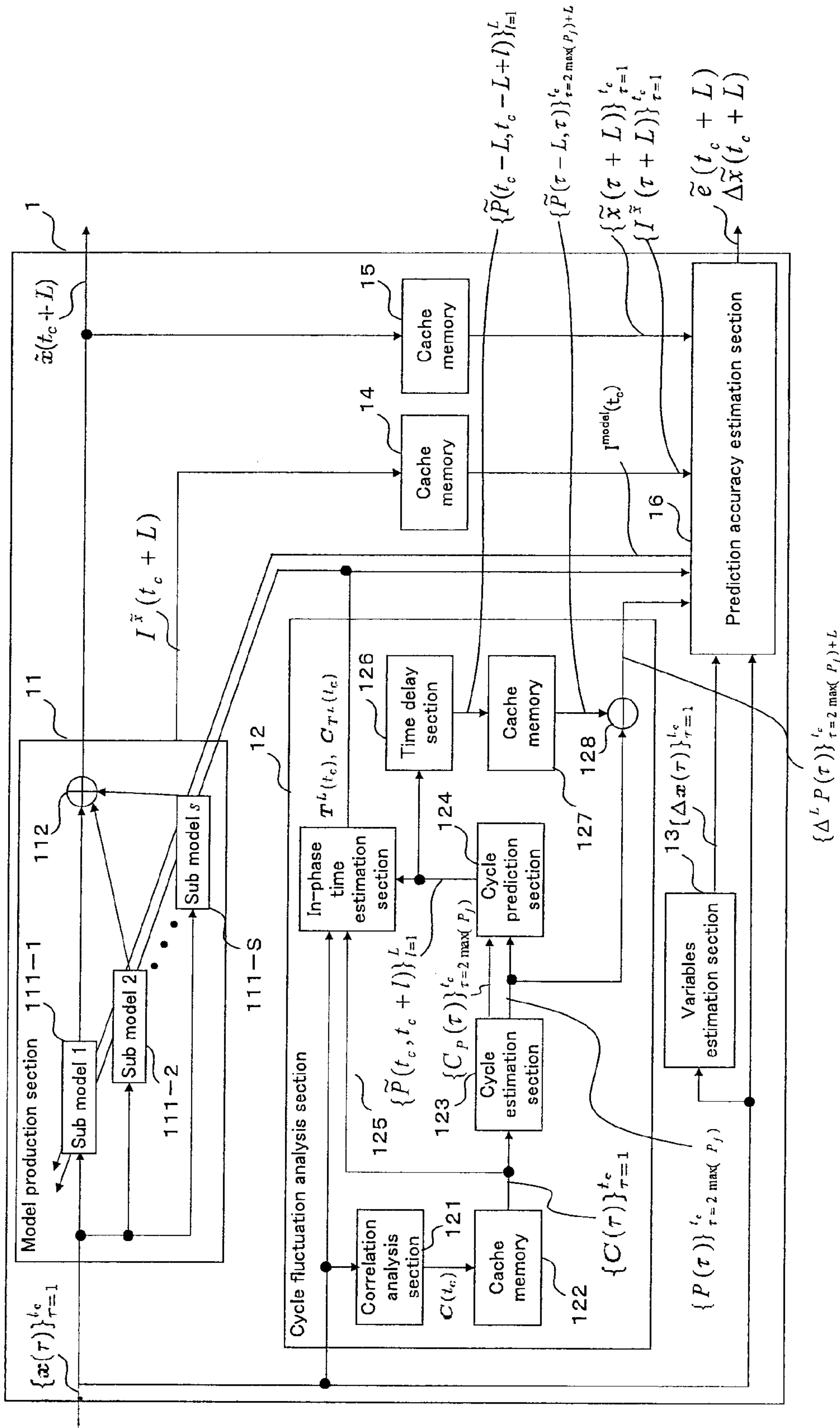

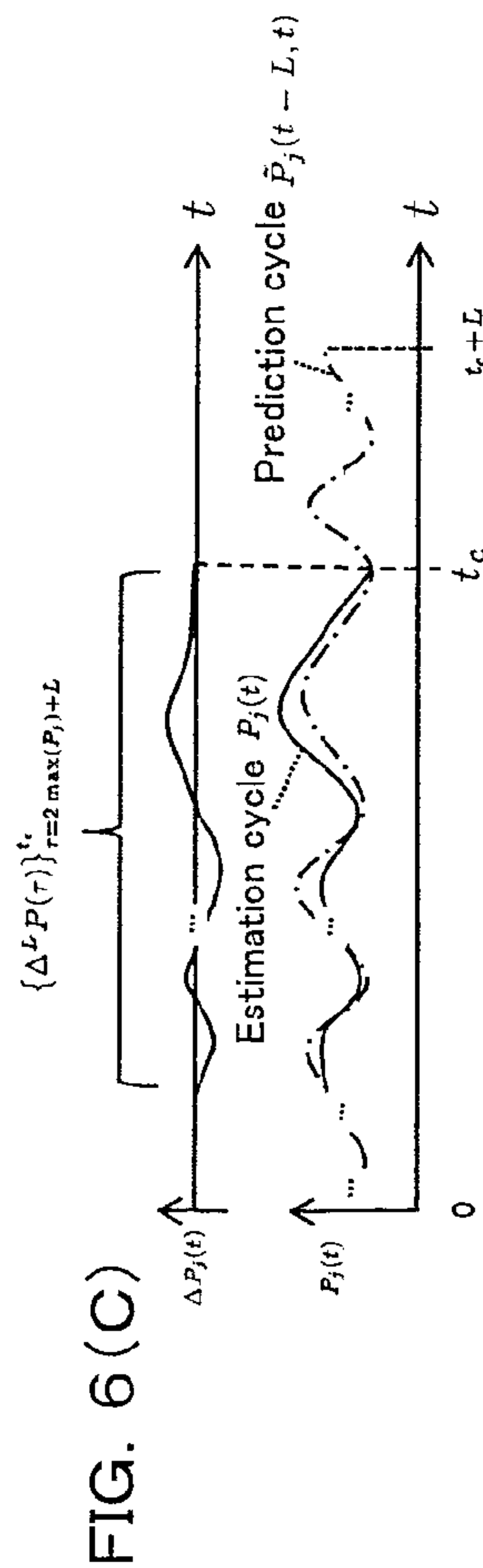
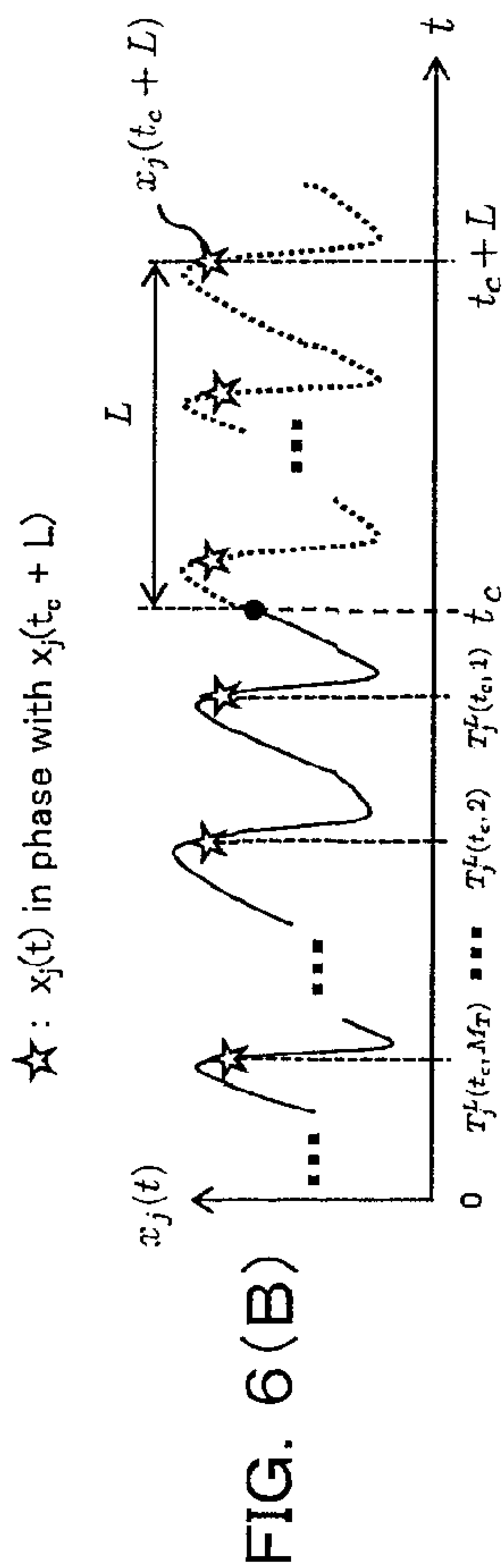
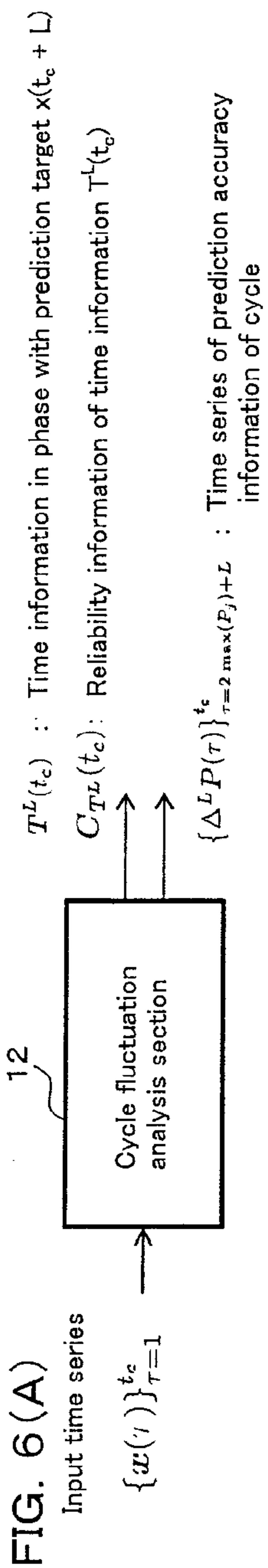

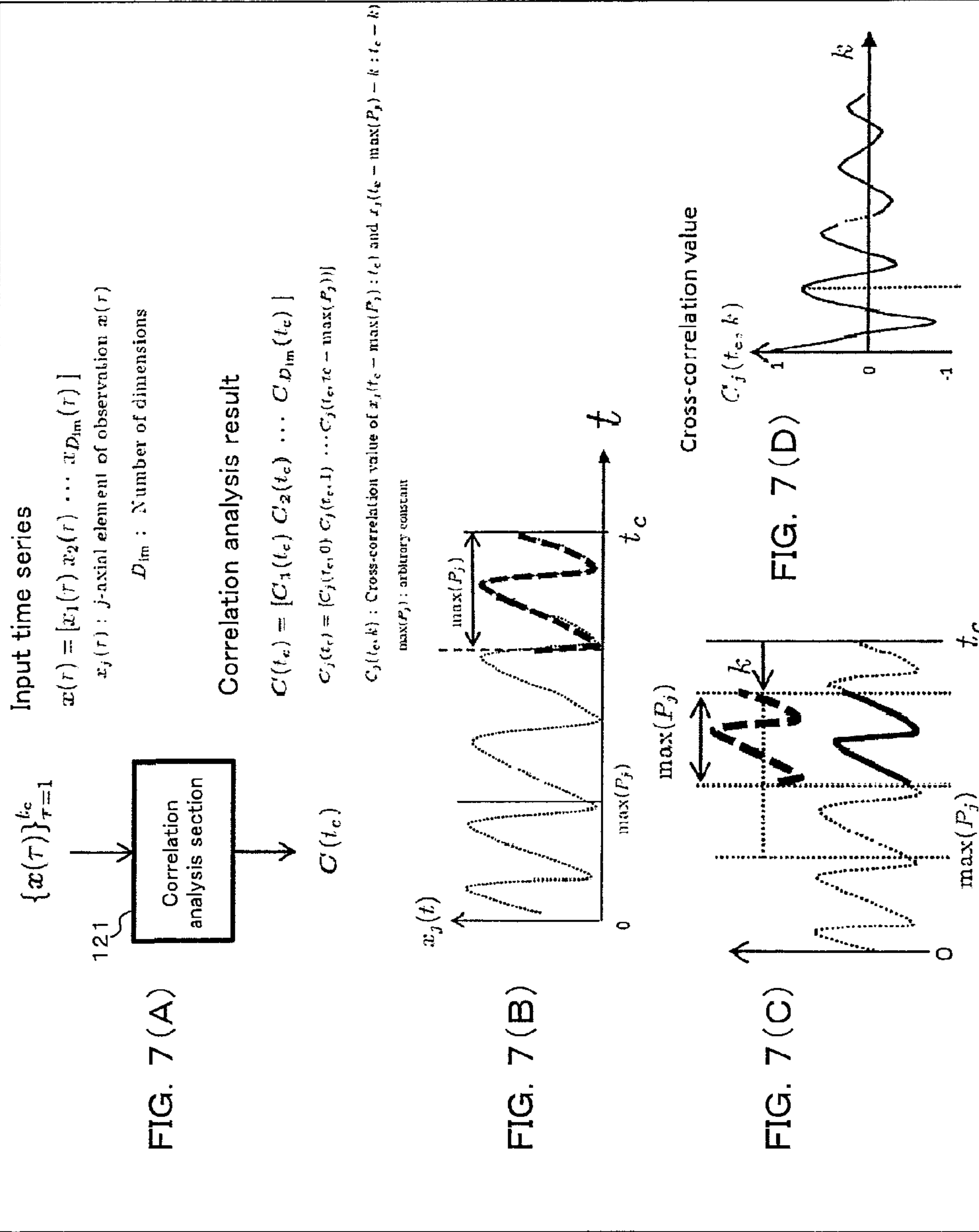

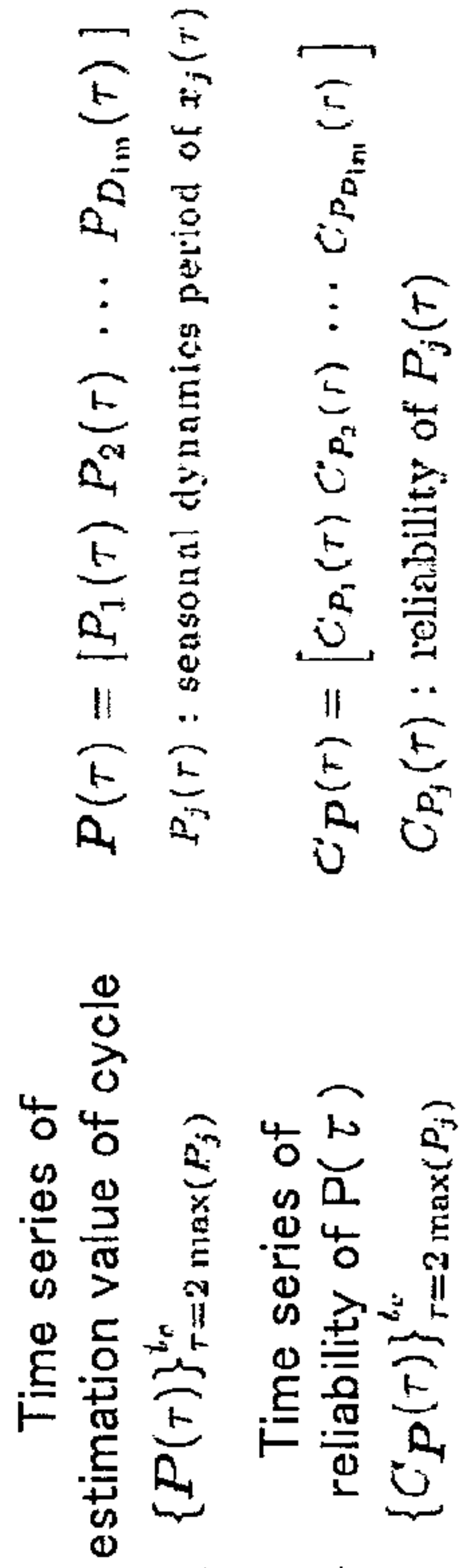

$$P(\tau) = [P_1(\tau) P_2(\tau) \dots P_{D_{im}}(\tau)]$$

$P_j(\tau)$: seasonal dynamics period of $x_j(\tau)$

$$CP(\tau) = [C_{P_1}(\tau) C_{P_2}(\tau) \dots C_{P_{D_{im}}}(\tau)]$$

$C_{P_j}(\tau)$: reliability of $P_j(\tau)$

FIG. 8(A)

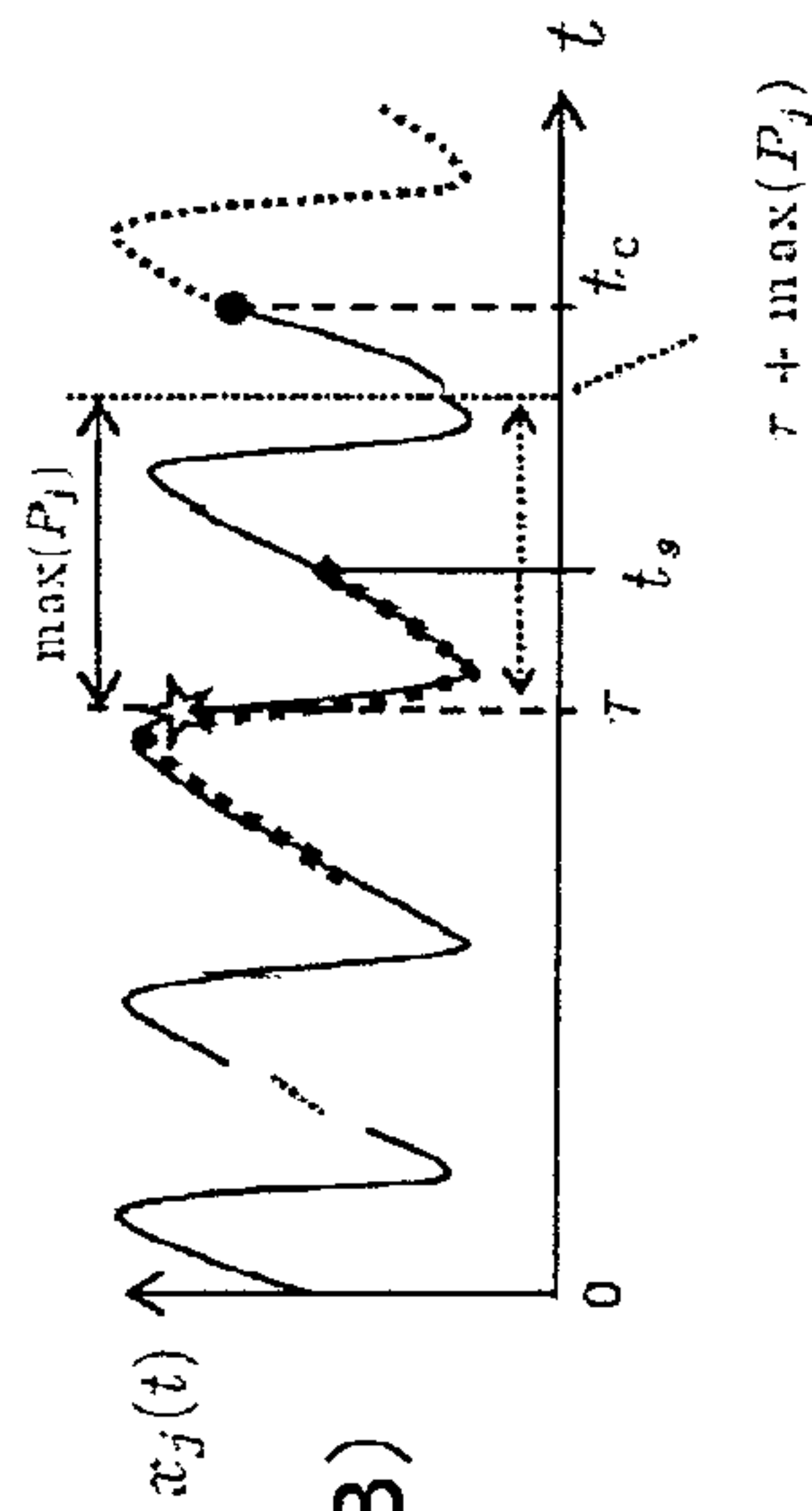

FIG. 8(B)

Cross-correlation value

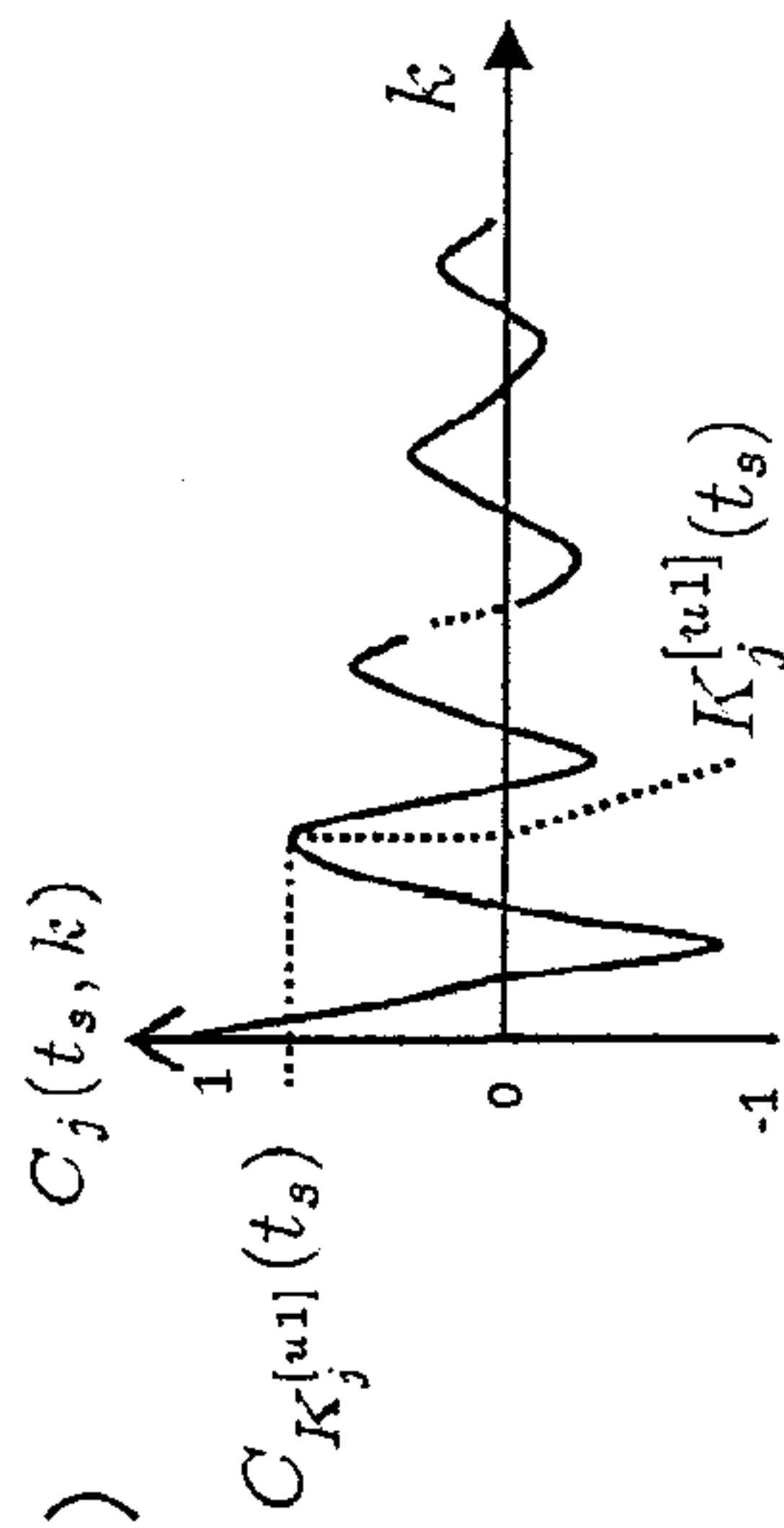

FIG. 8(C)

9/31
FIG. 9

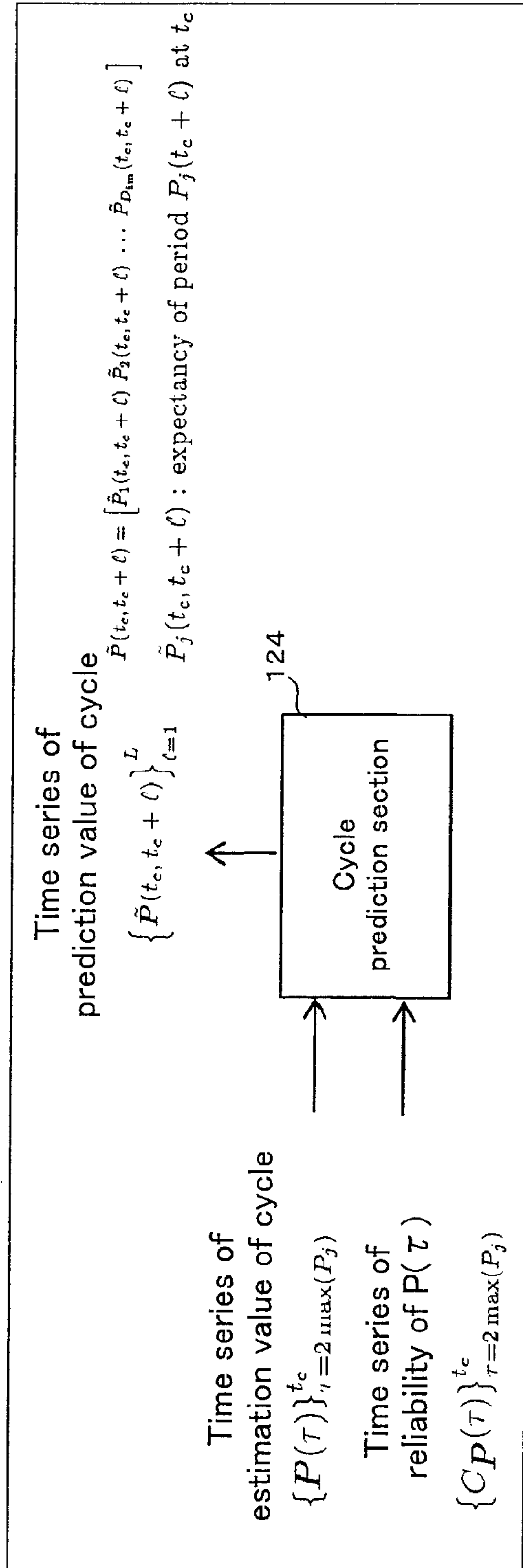

FIG. 10(A)

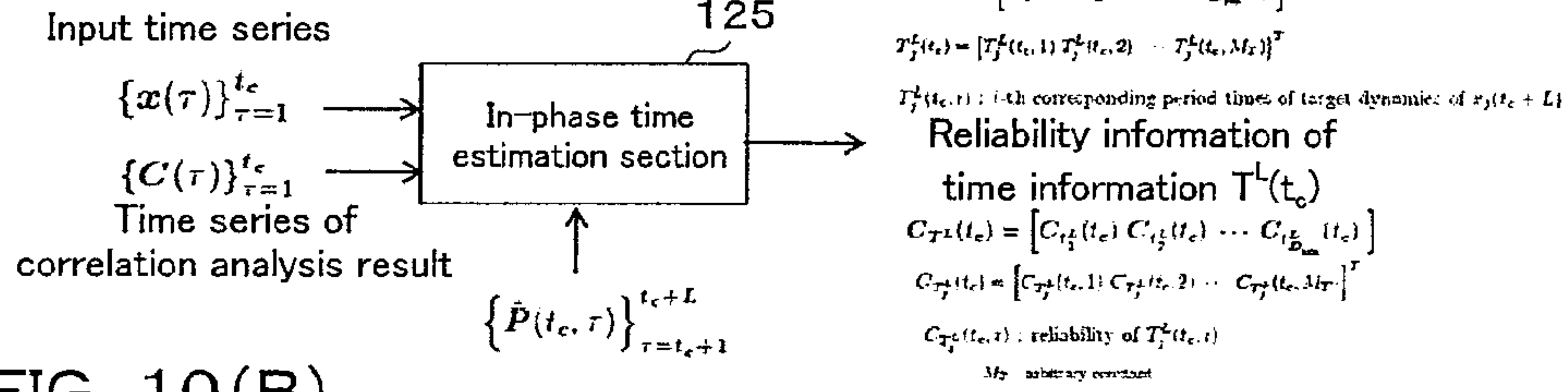

FIG. 10(B)

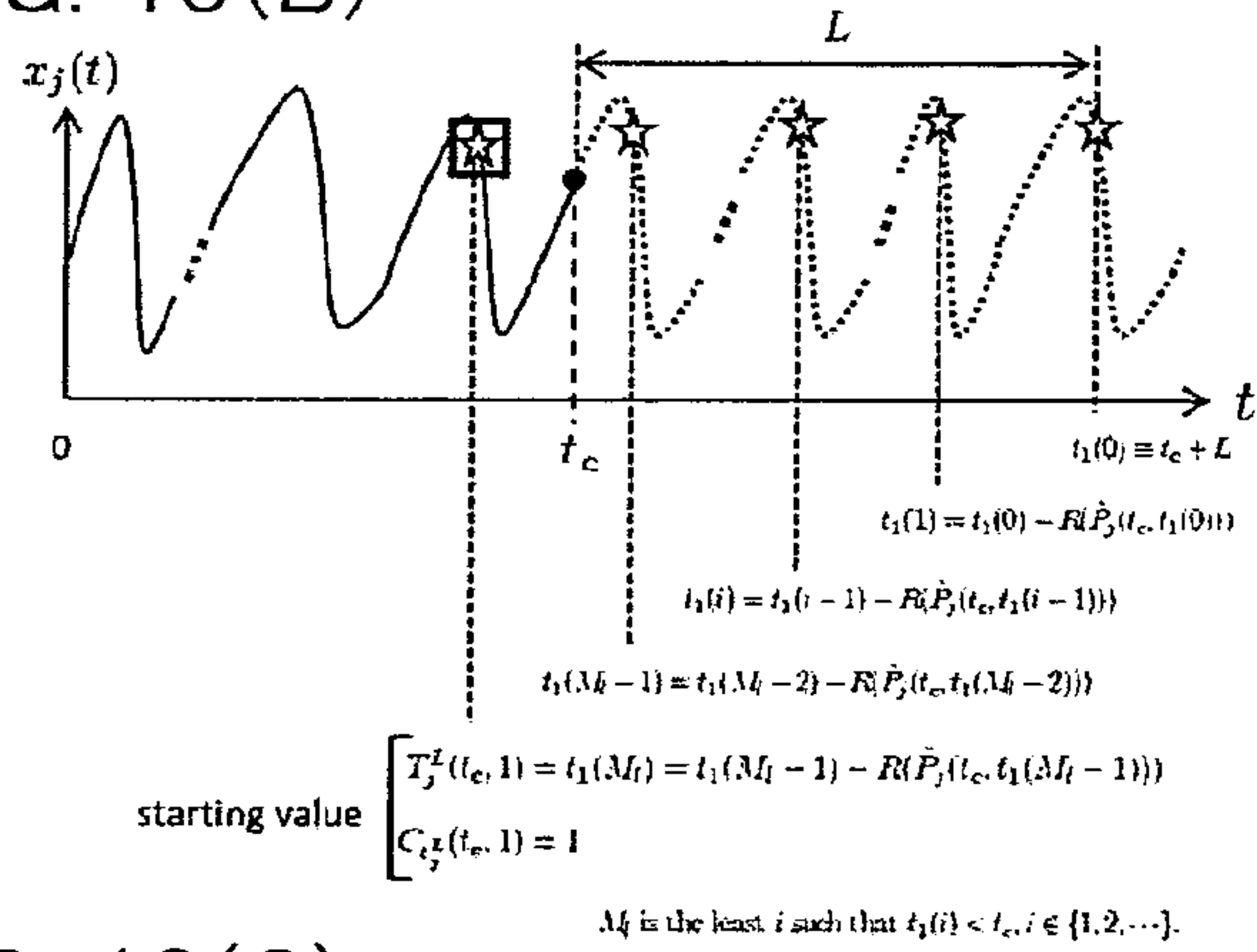

FIG. 10(C)

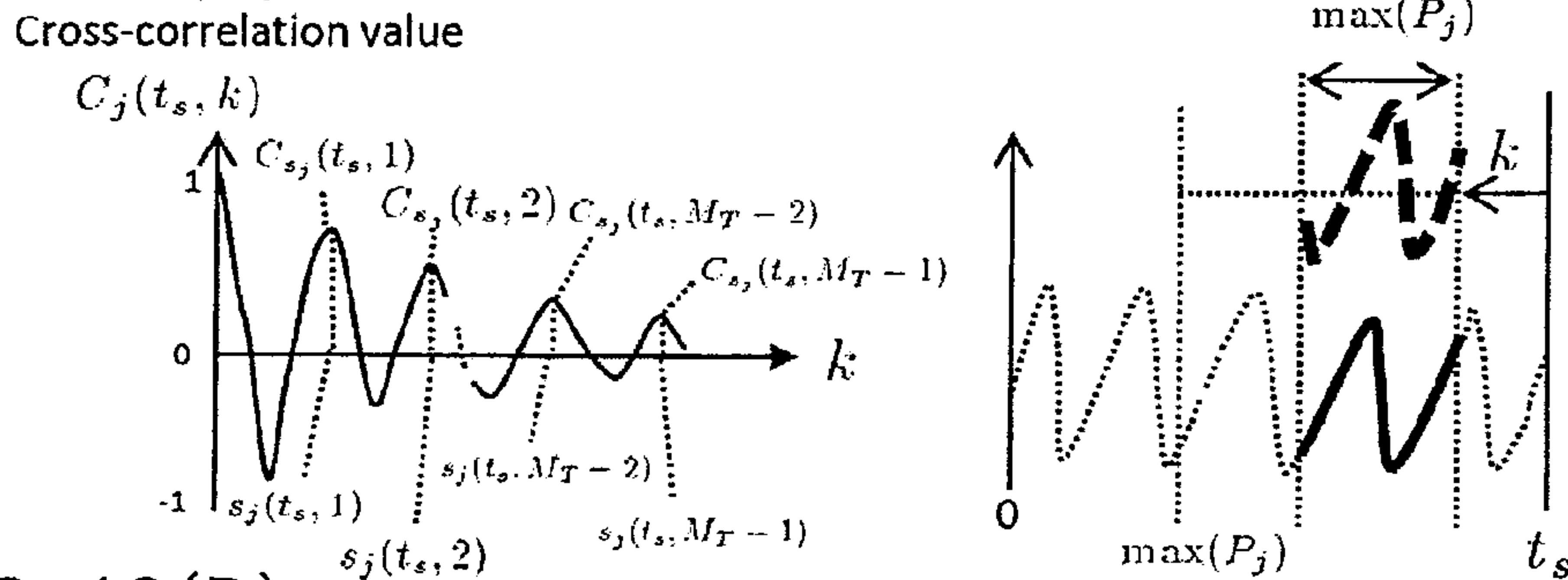
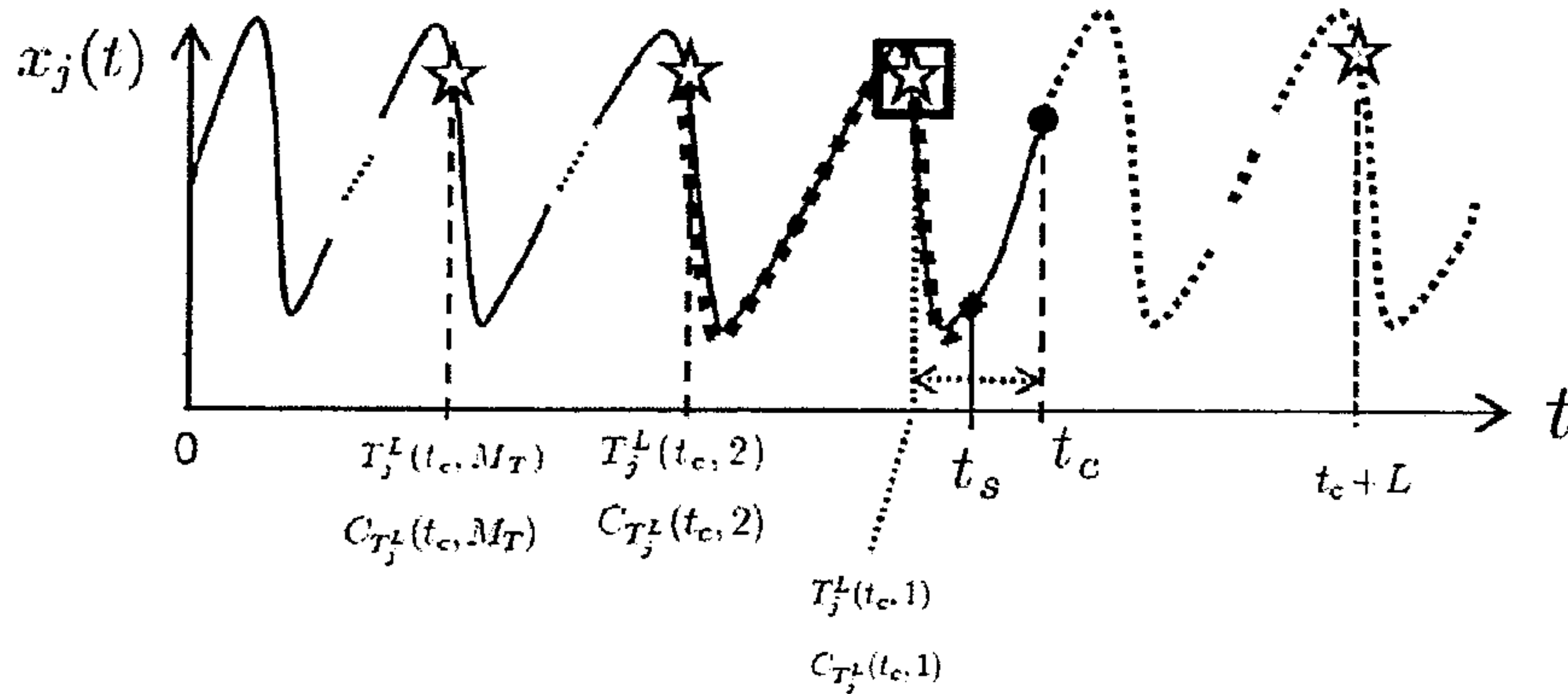
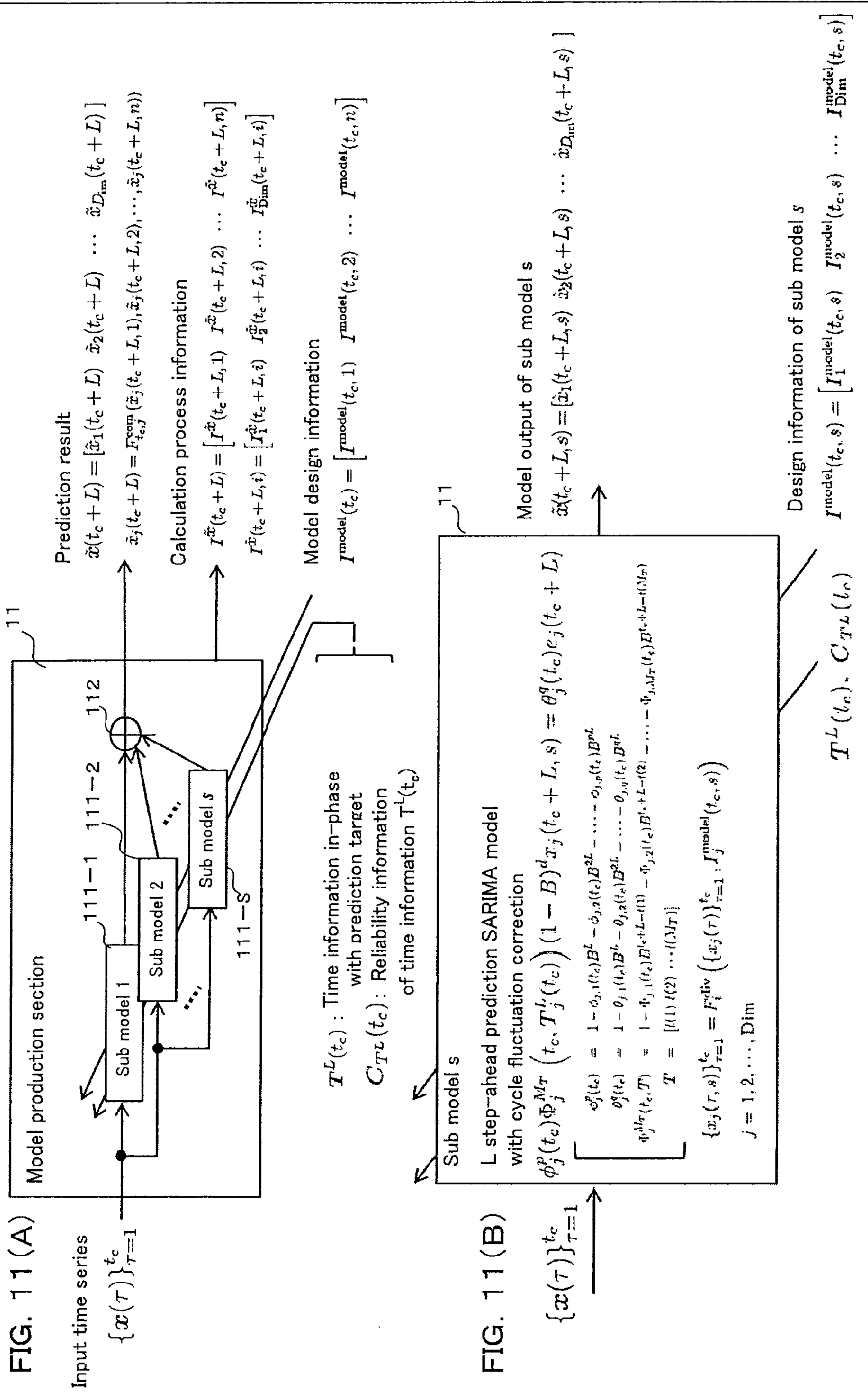
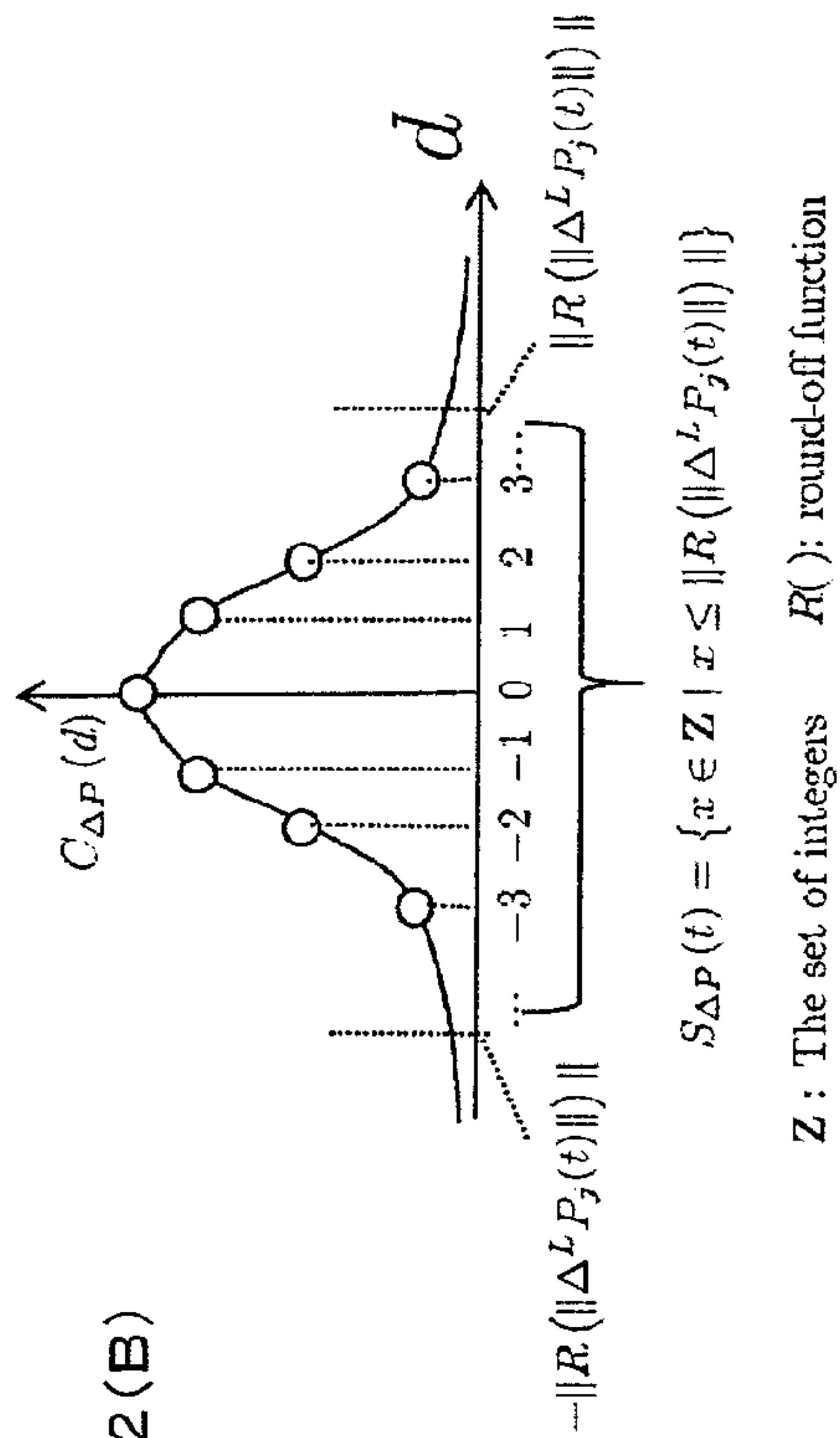
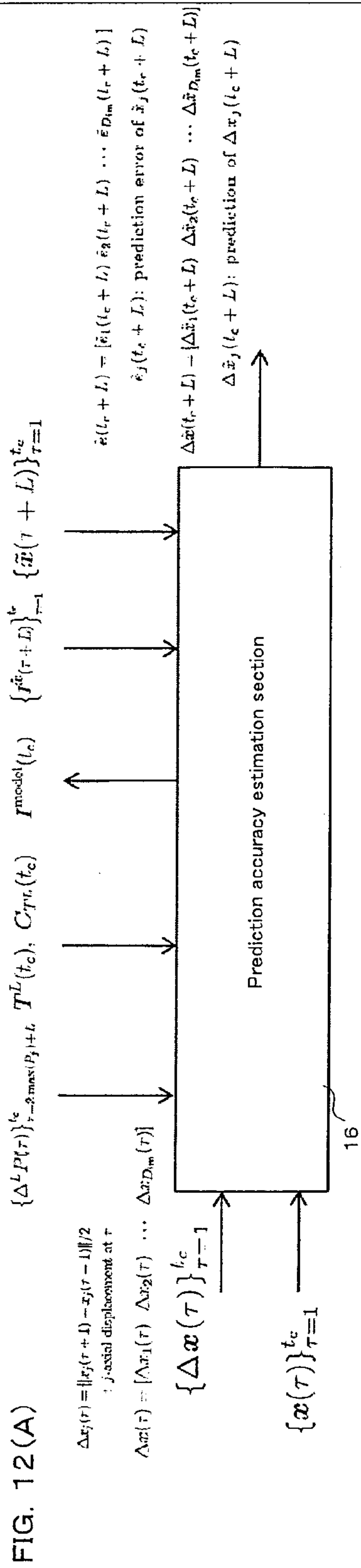

FIG. 10(D)







13/31
FIG. 13

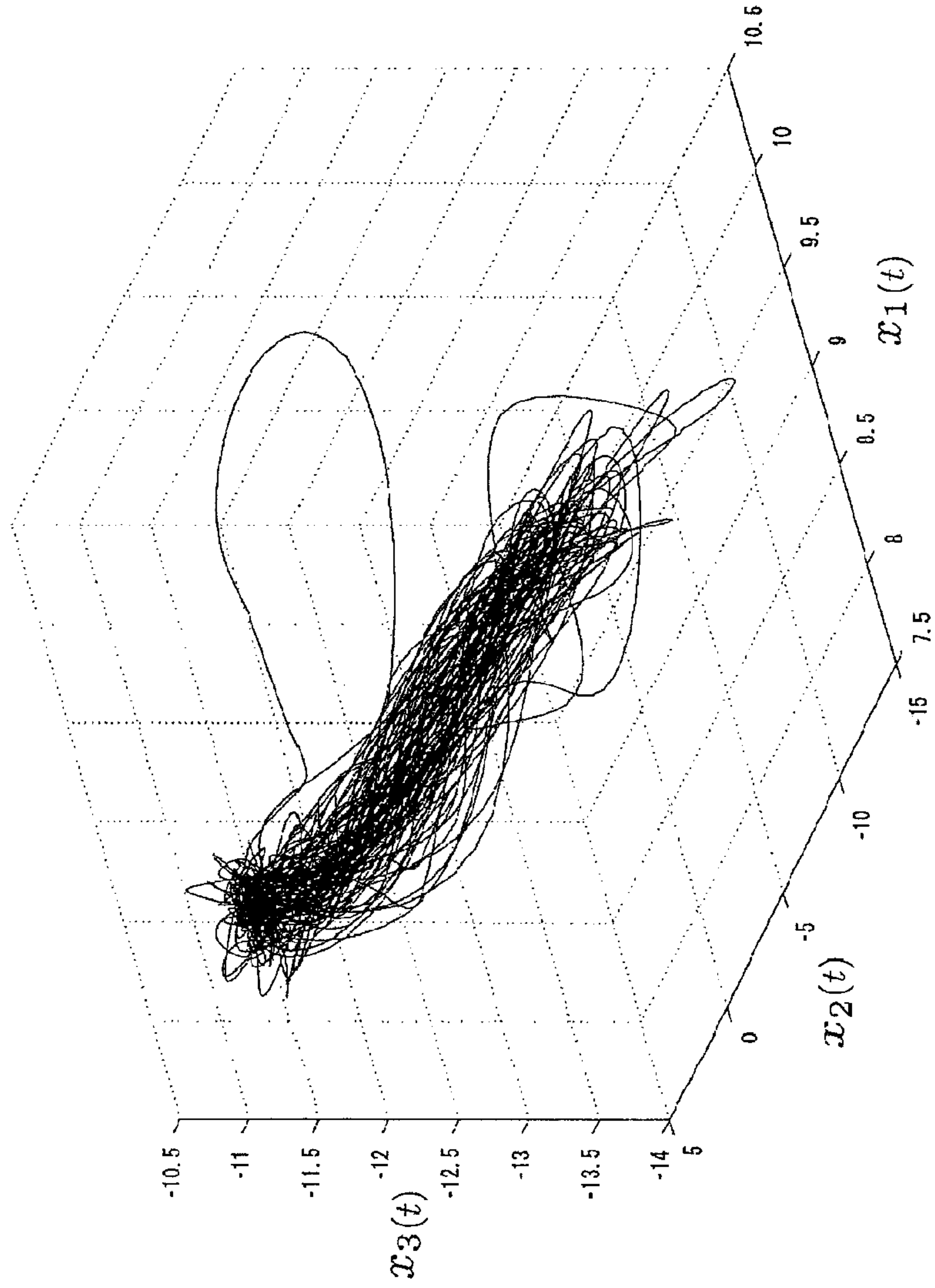

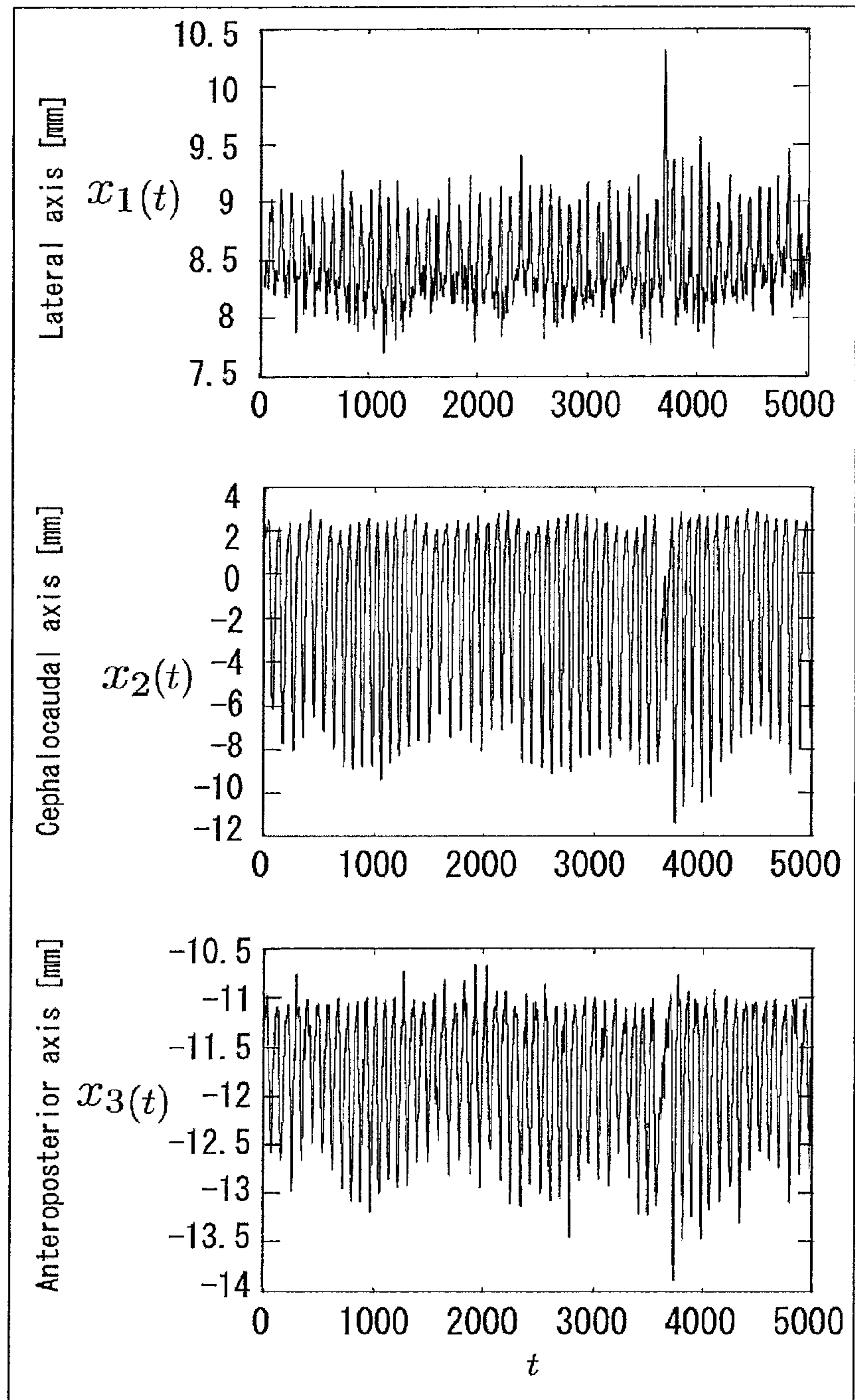
14/31
FIG. 14

15/31
FIG. 15

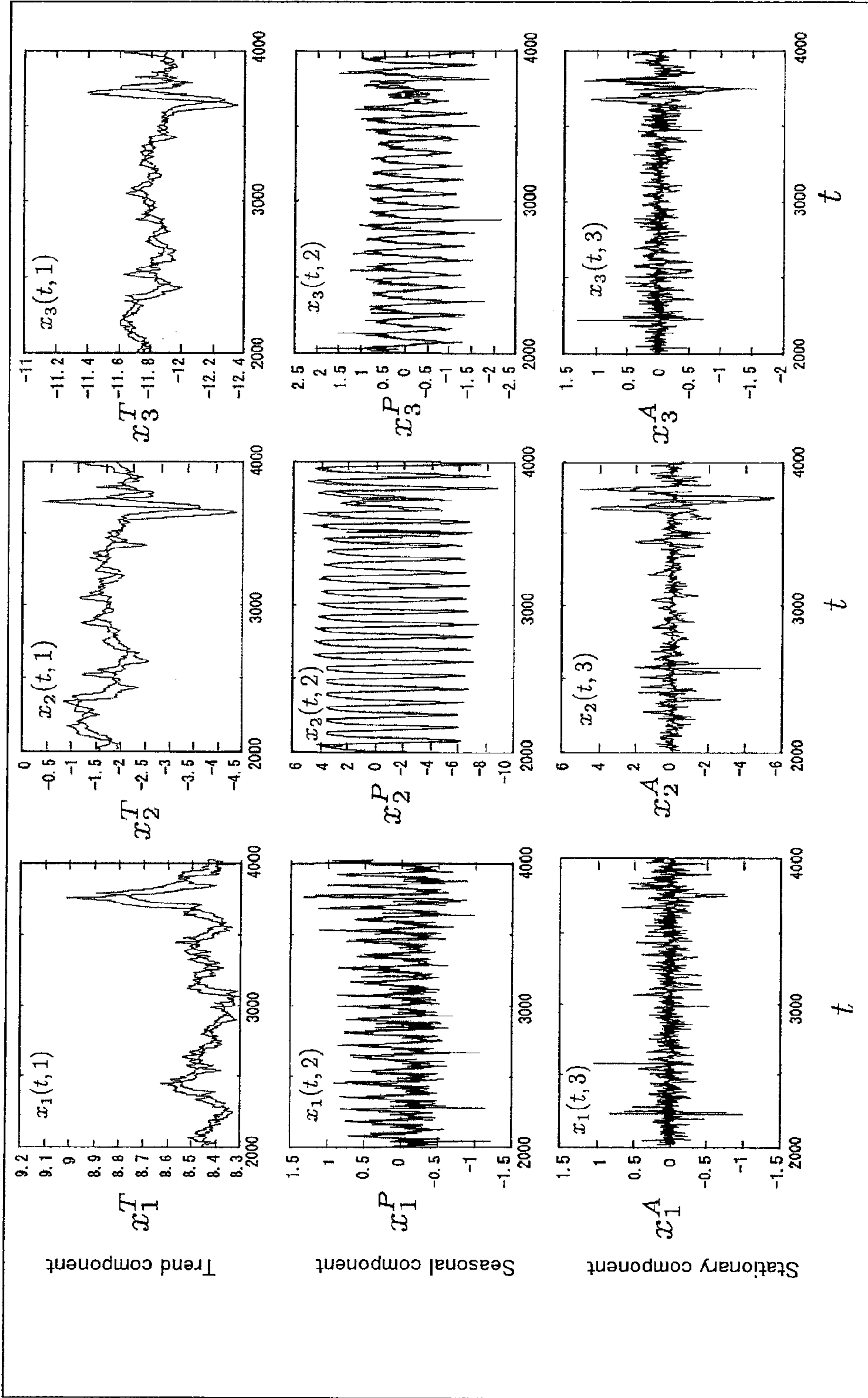

16/31
FIG. 16

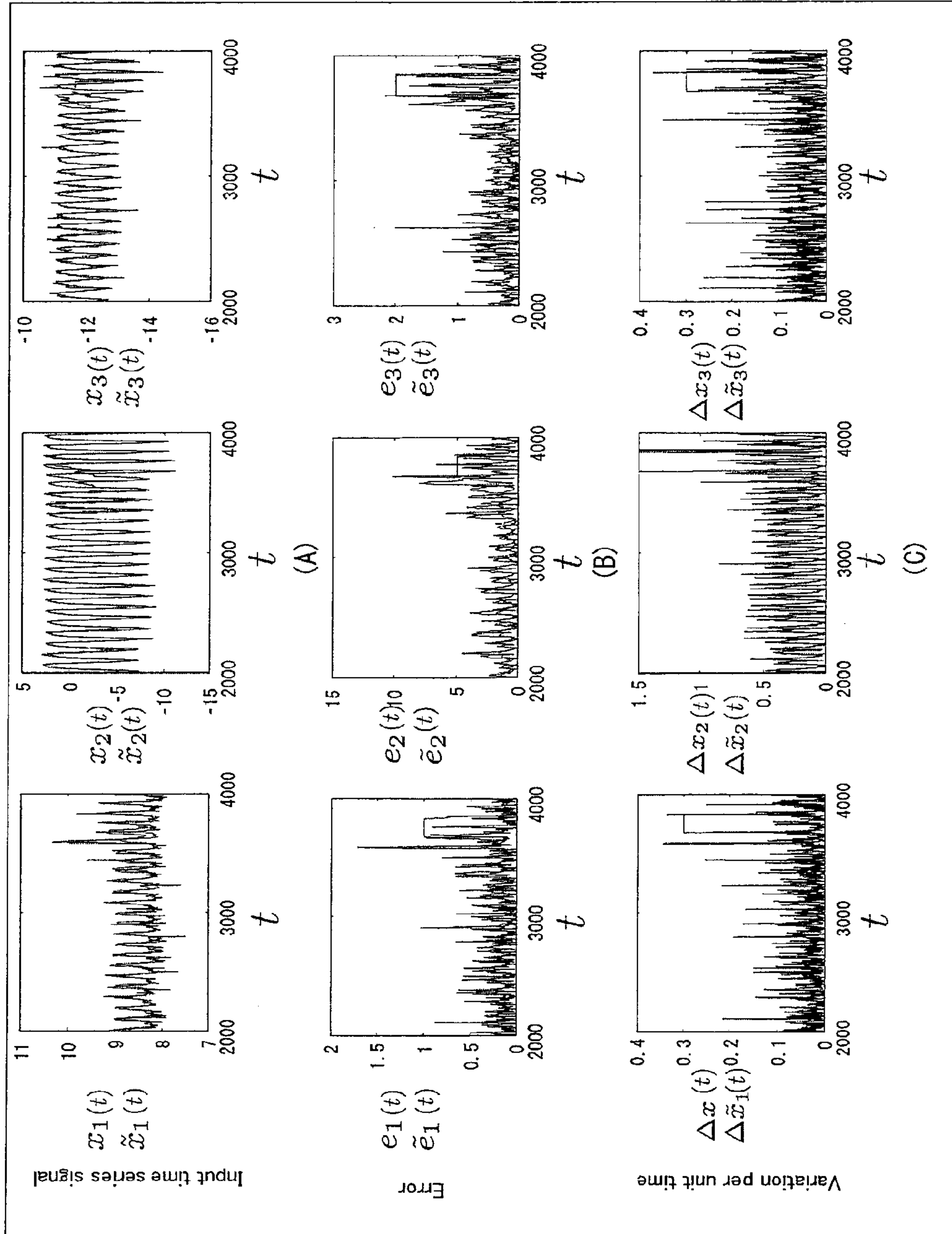

17/31
FIG. 17

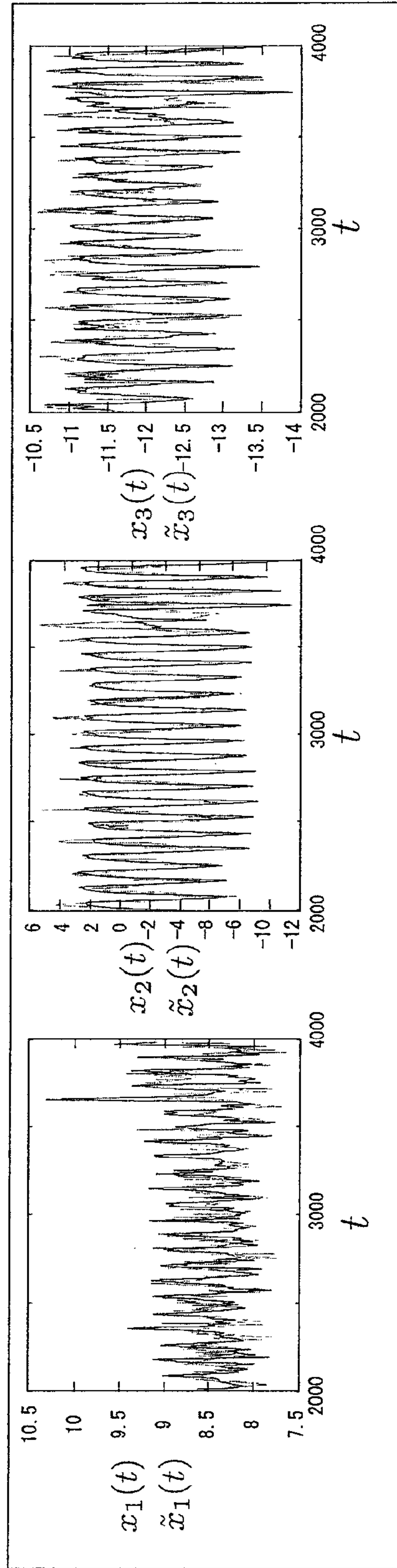

18/31
FIG. 18

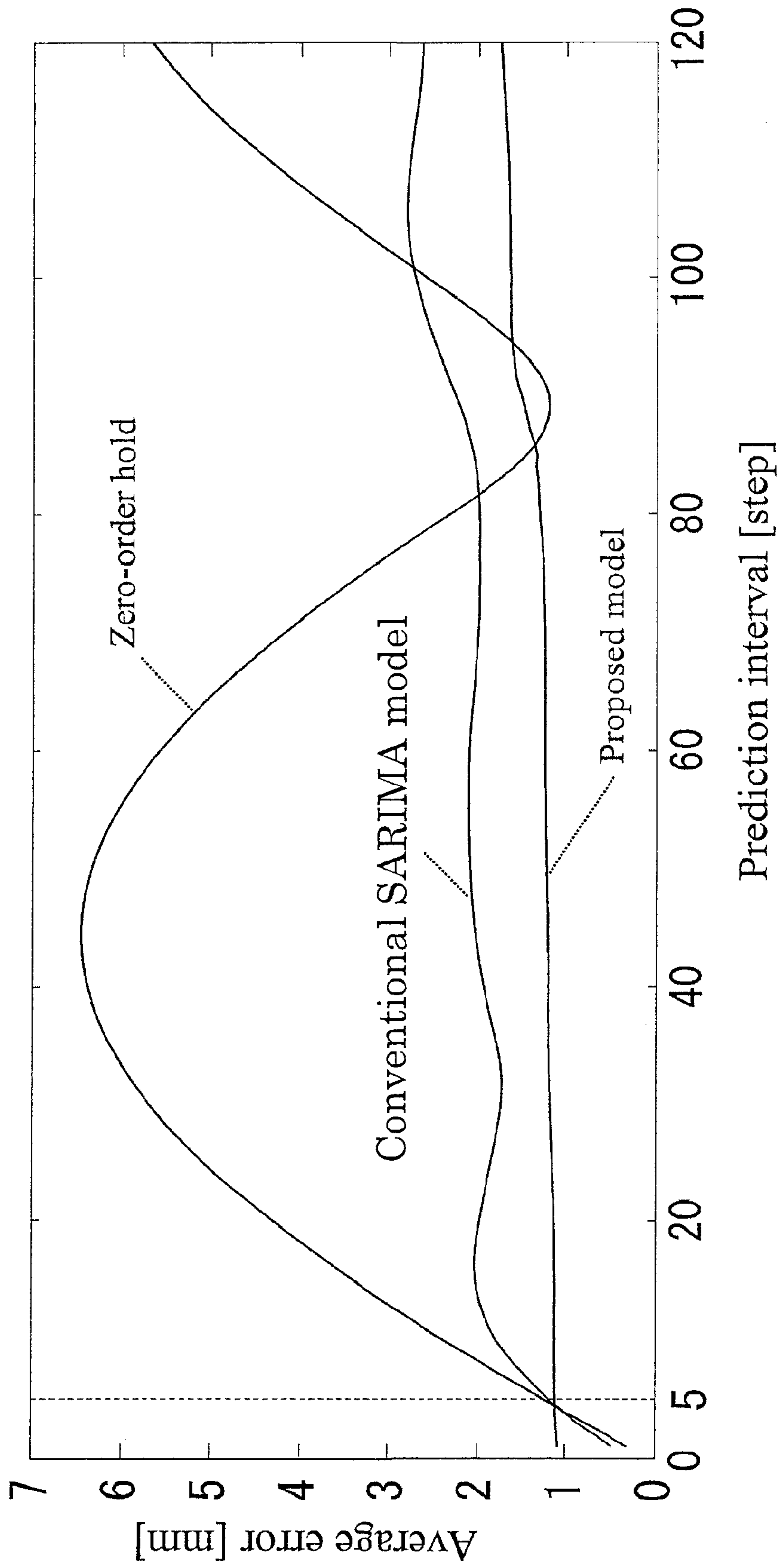

19/31
FIG. 19

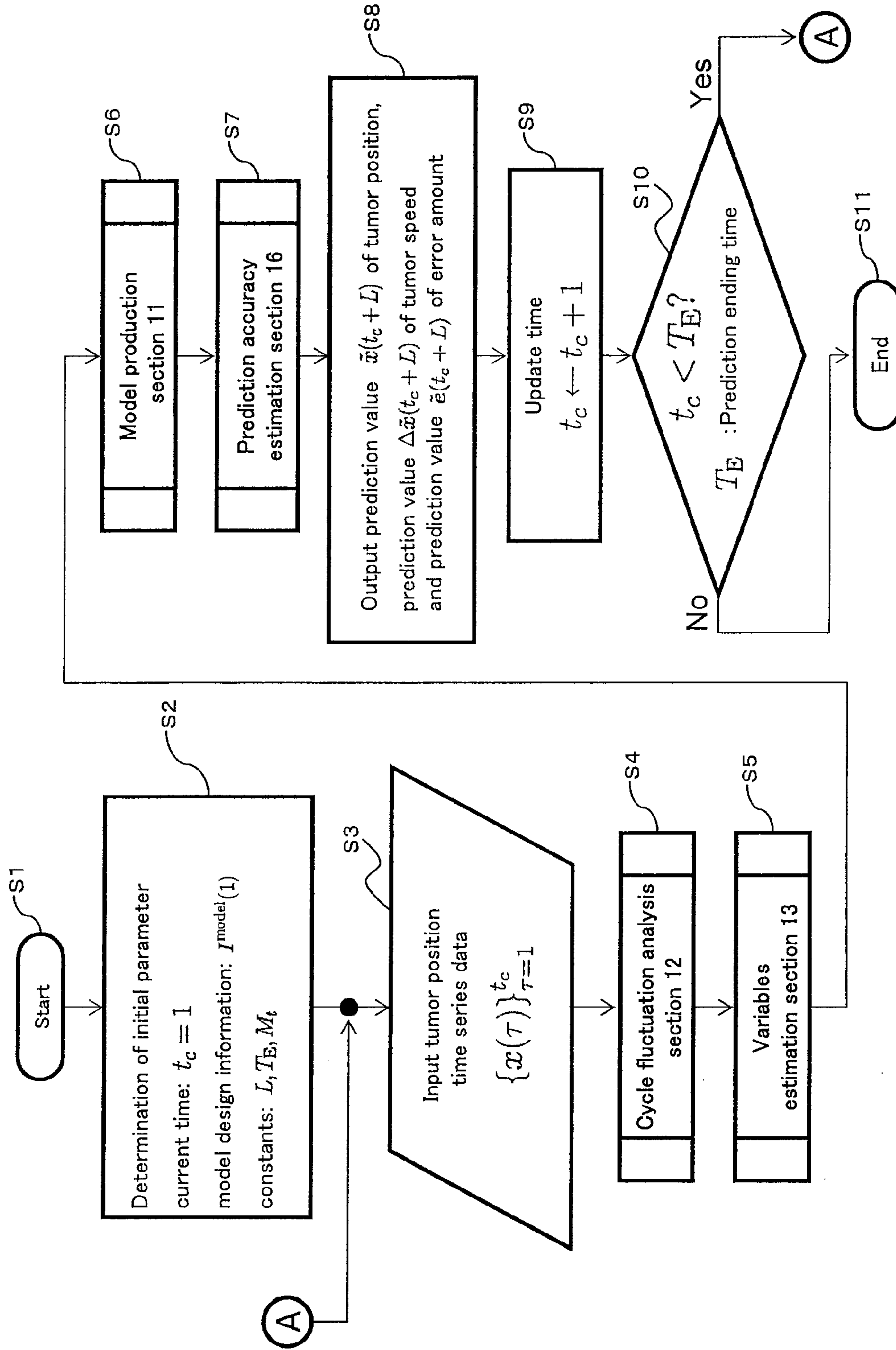

20/31
FIG. 20

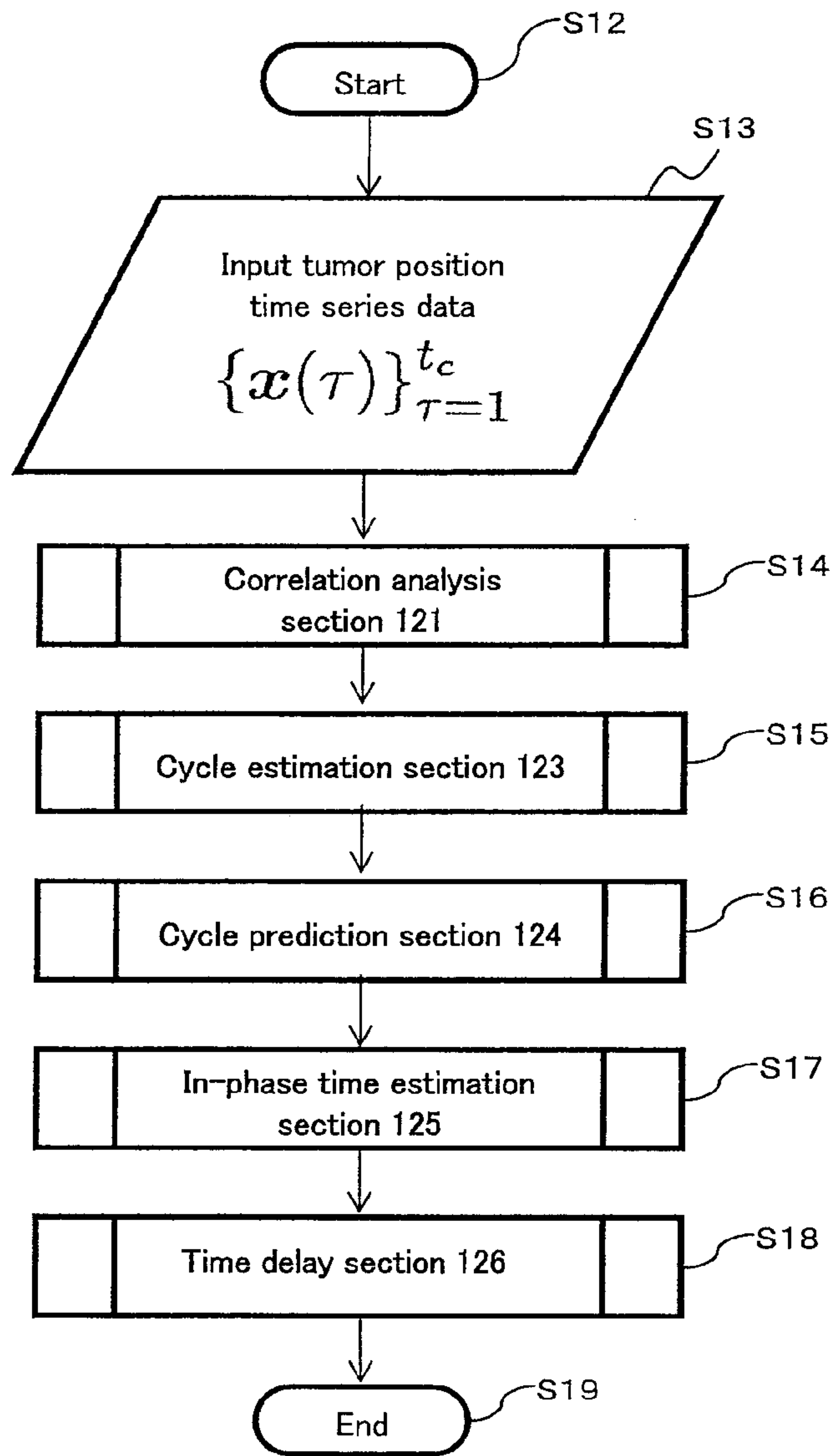

21/31
FIG. 21

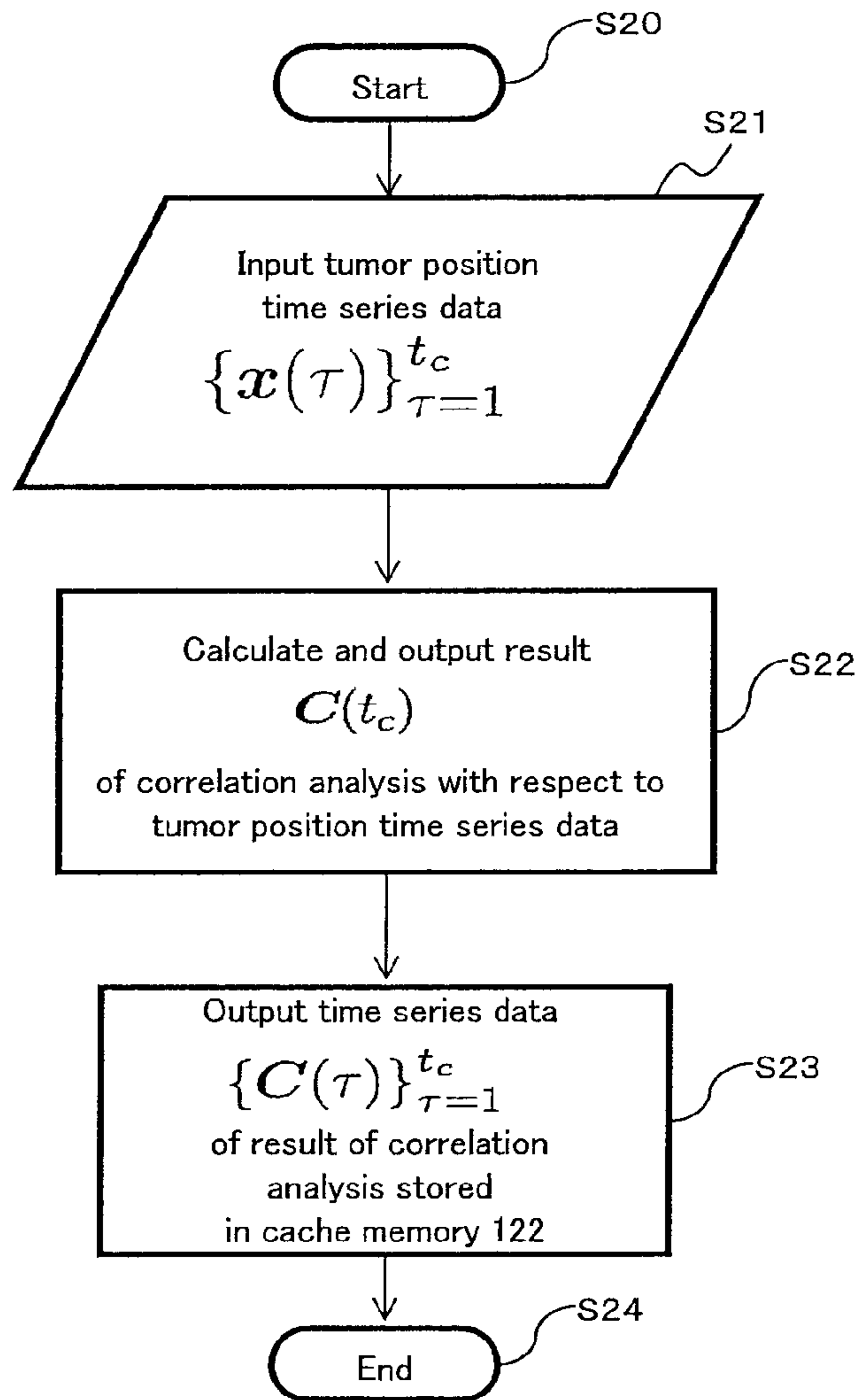

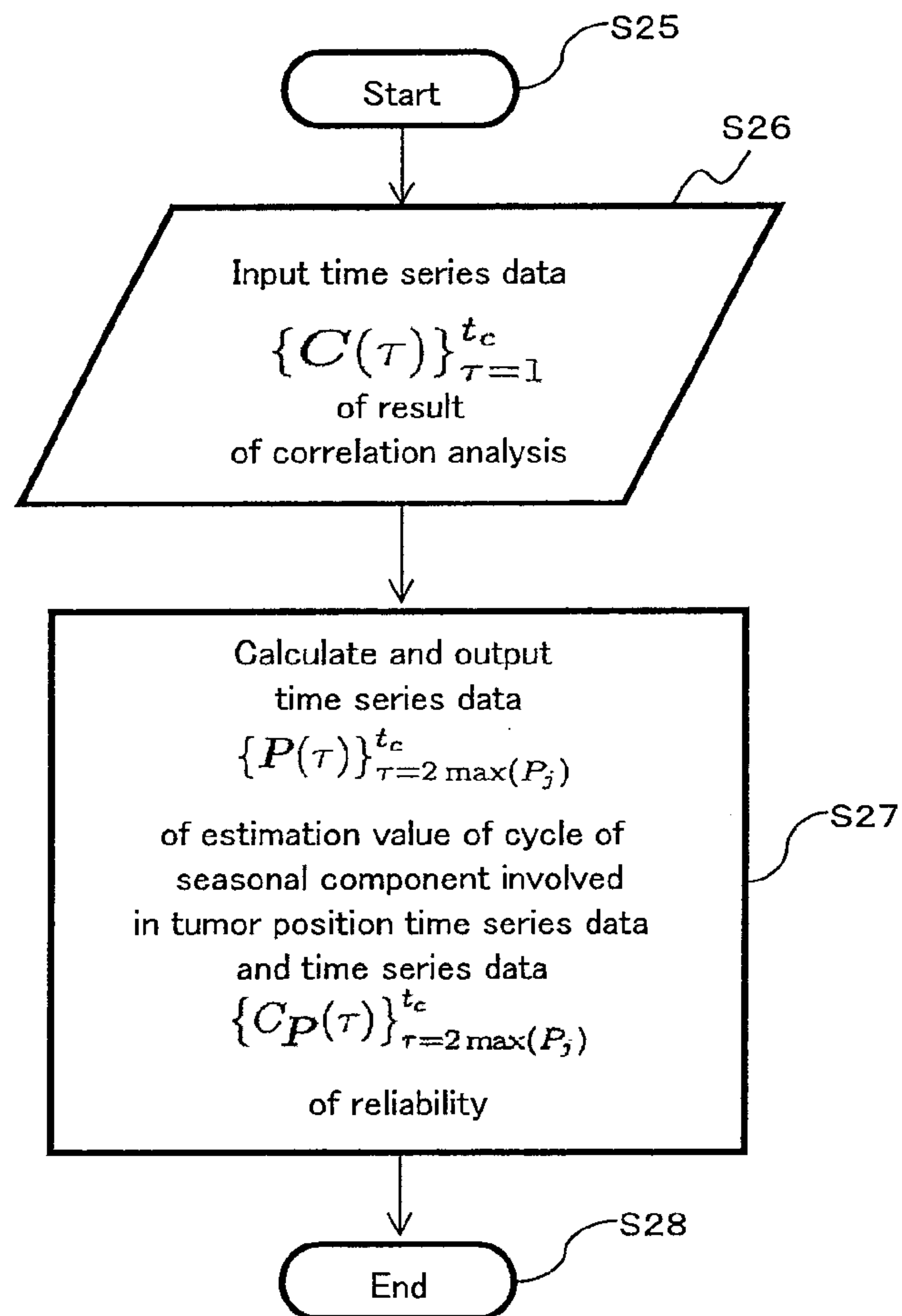
22/31
FIG. 22

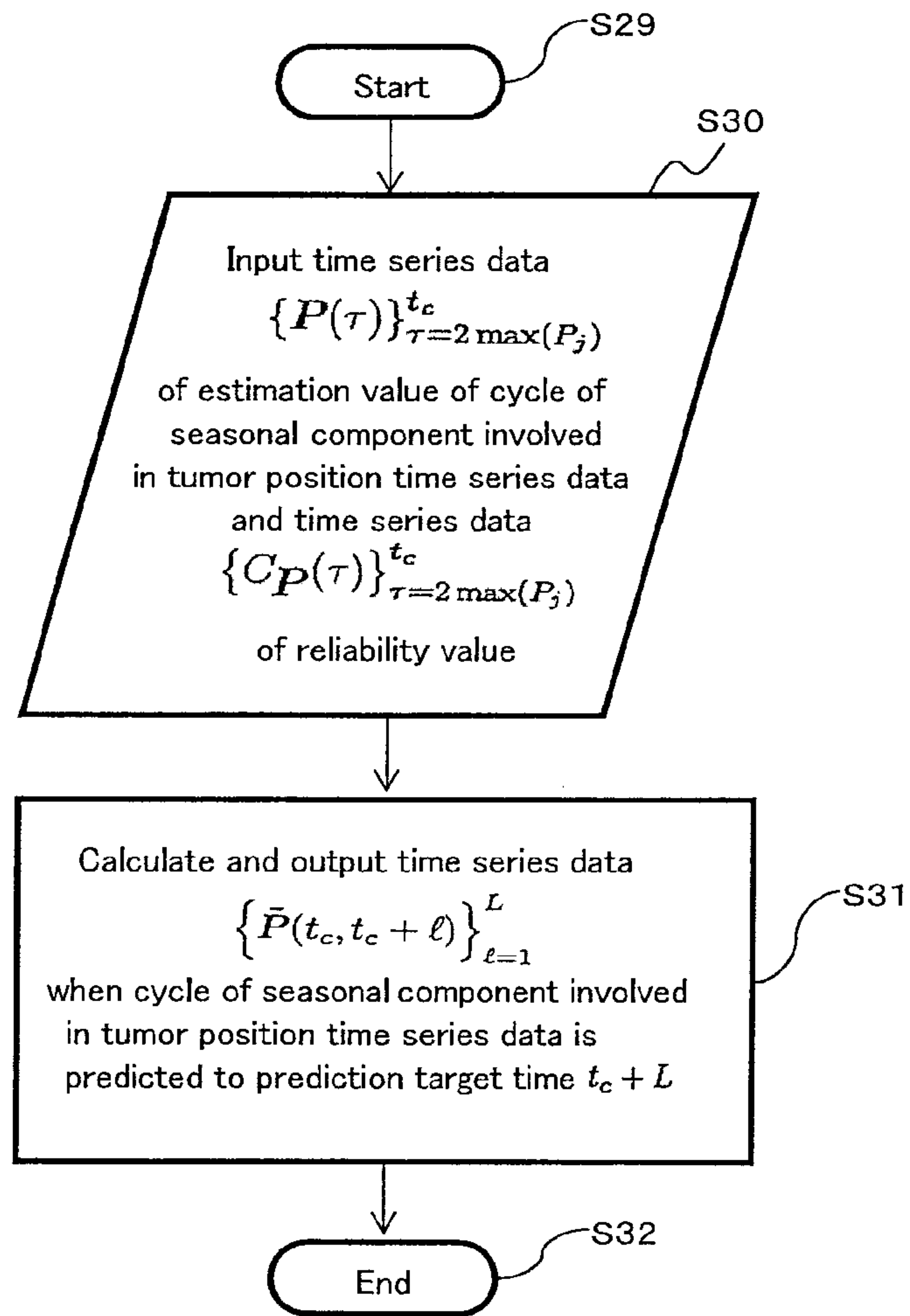
23/31
FIG. 23

24/31
FIG. 24

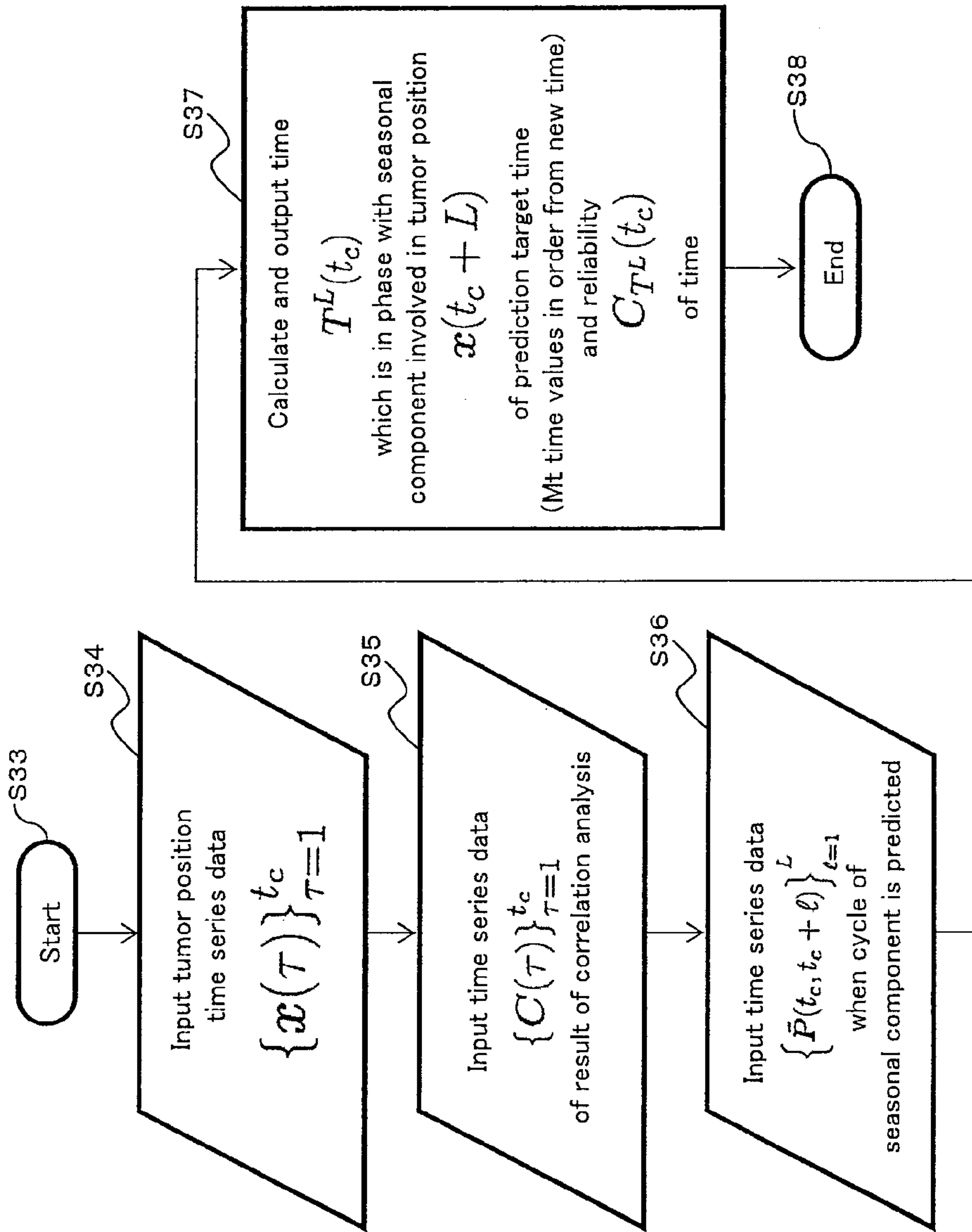

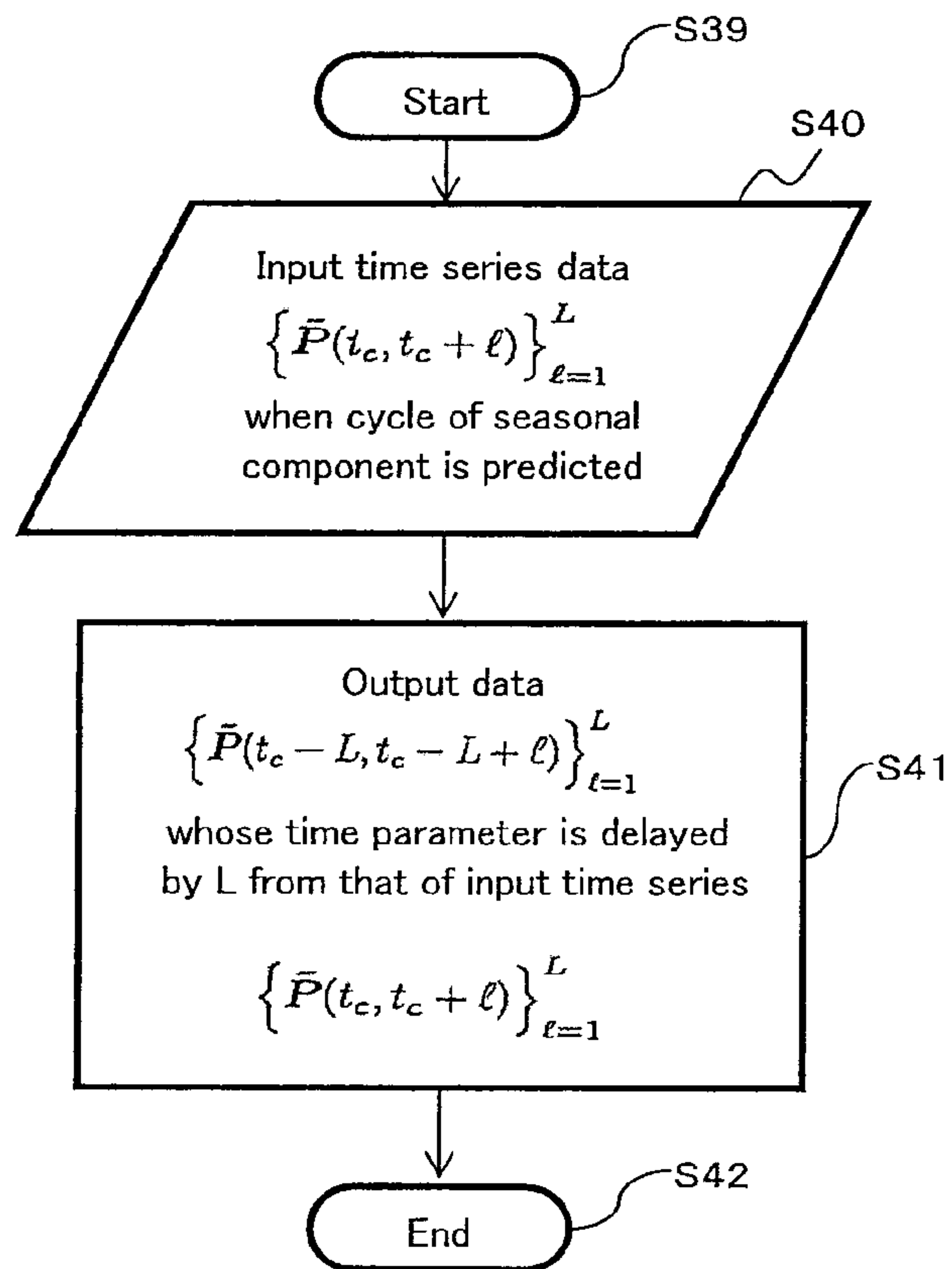
25/31
FIG. 25

26/31
FIG. 26

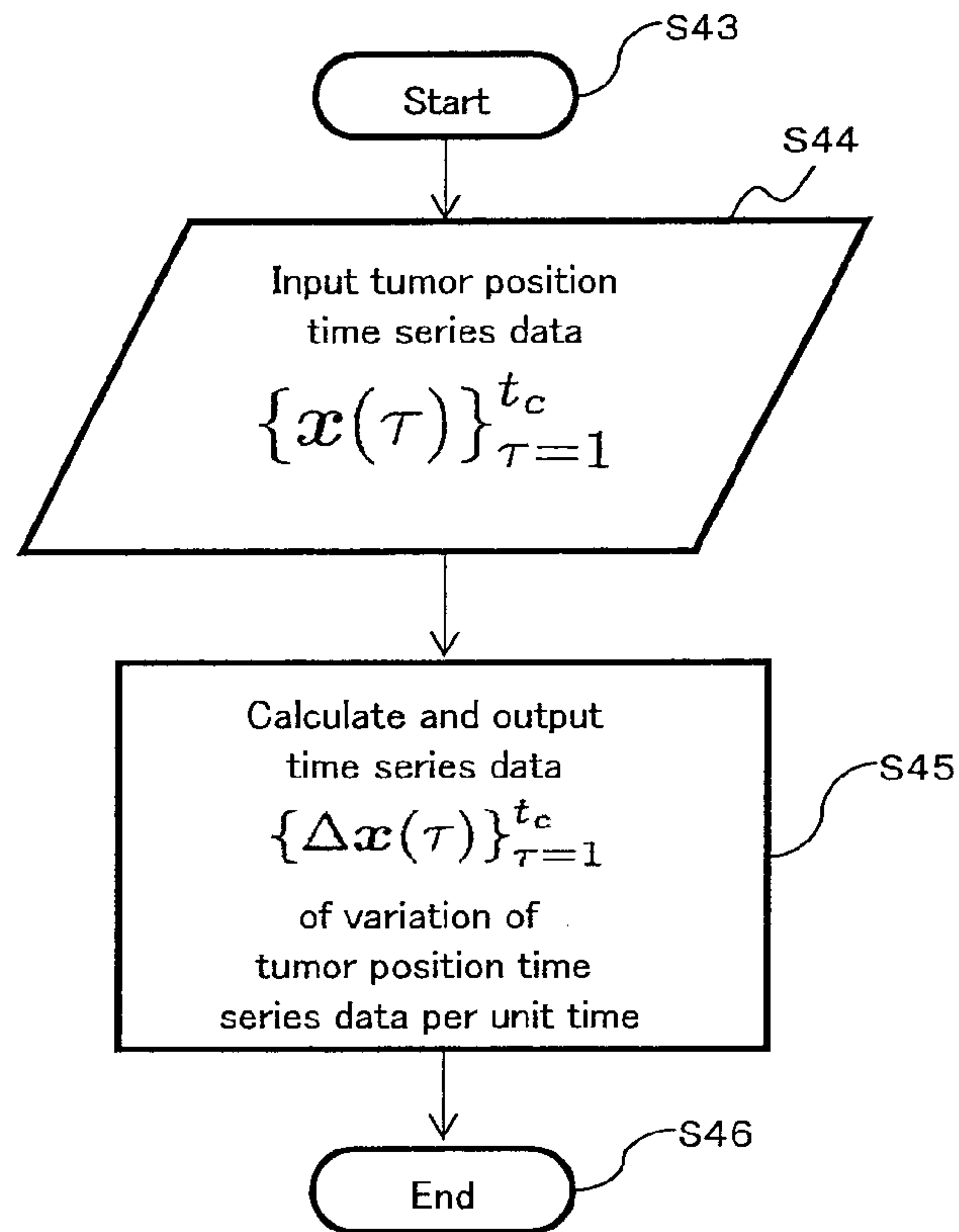

27/31
FIG. 27

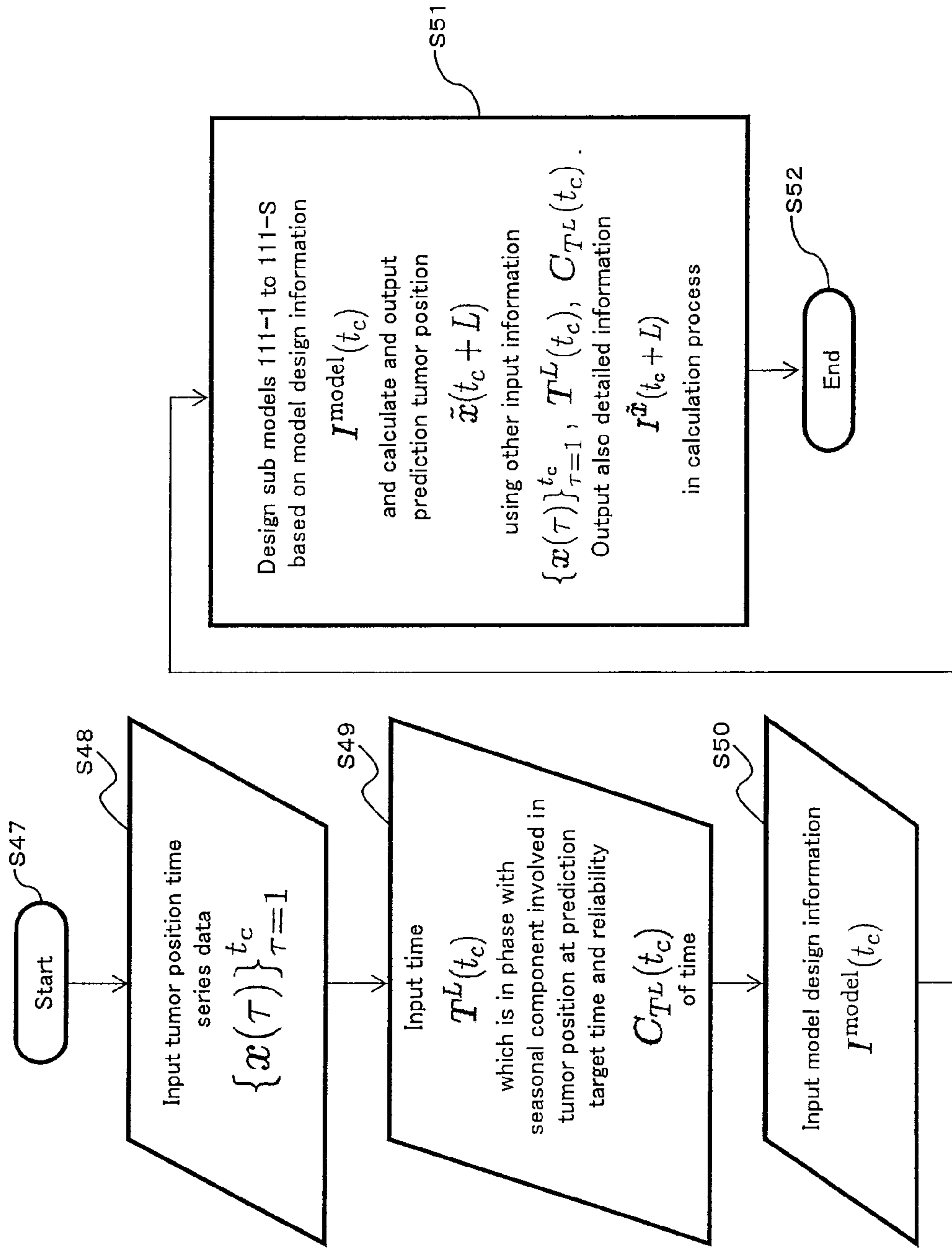

28/31
FIG. 28

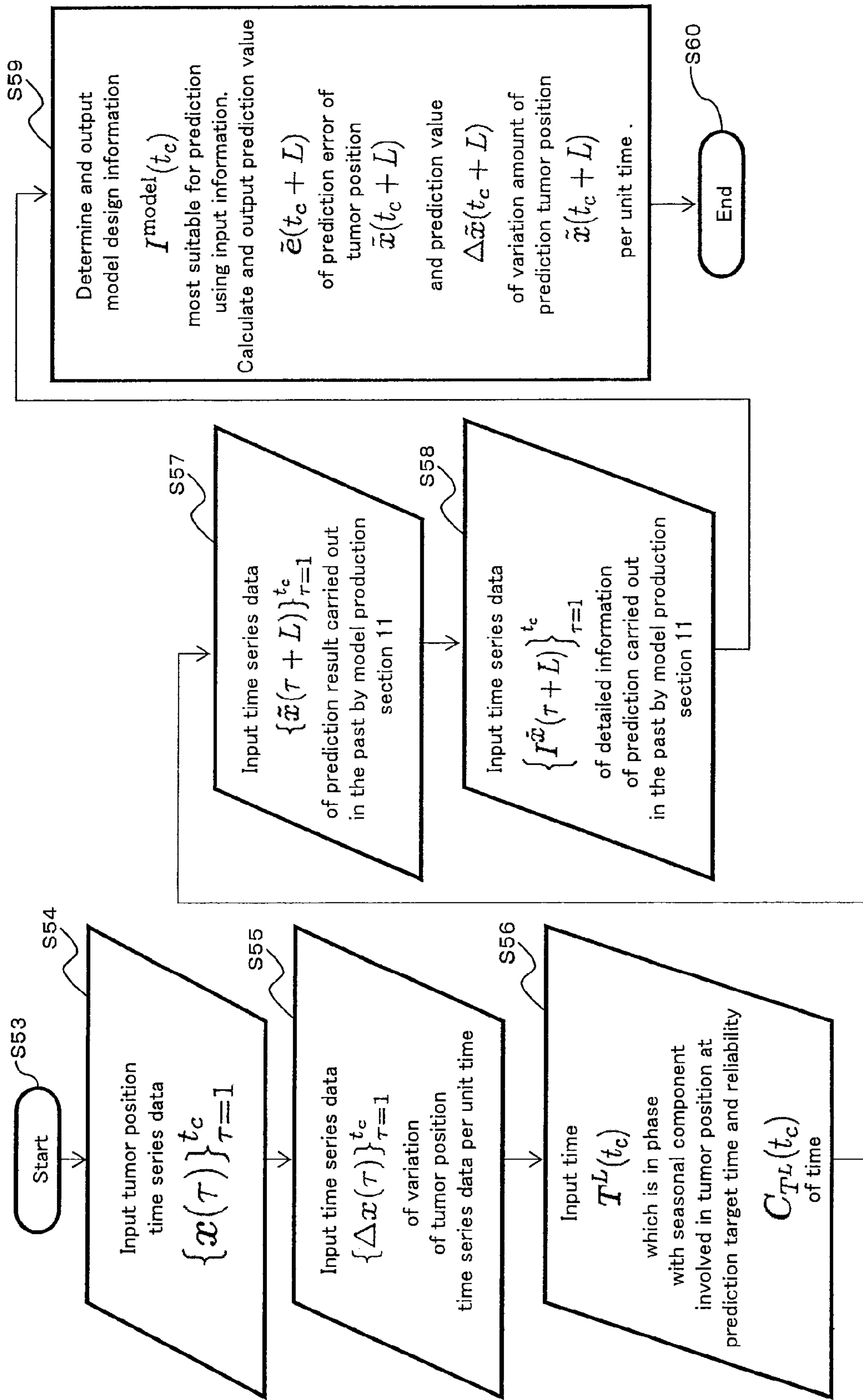

29/31
FIG. 29

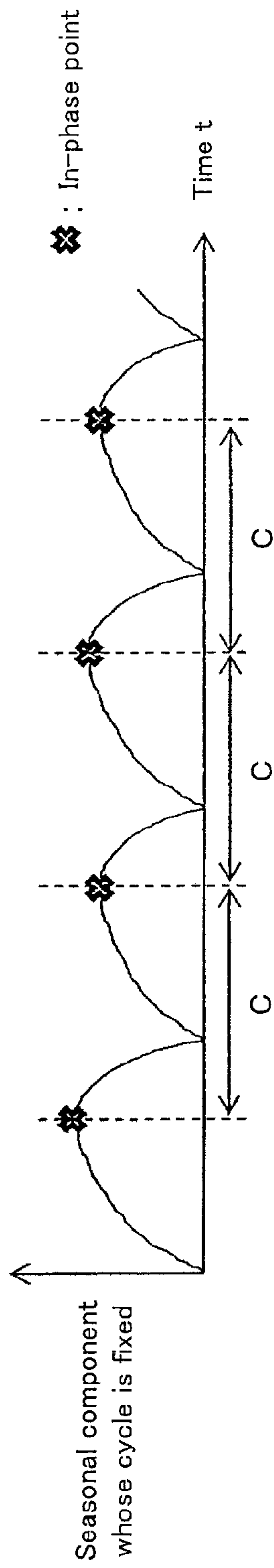

30/31
FIG. 30

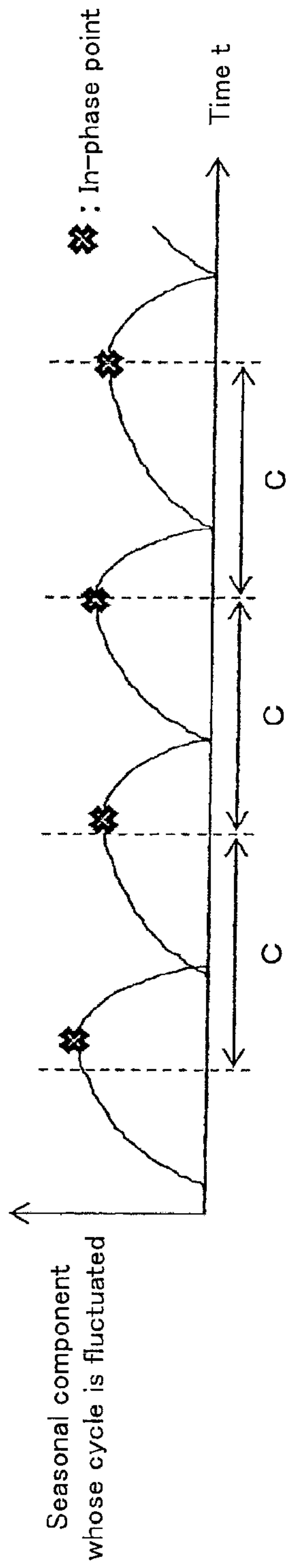

31/31
 FIG. 31

