

(12) **United States Design Patent** (10) **Patent No.:** **US D872,734 S**
Pillalamarri et al. (45) **Date of Patent:** **** Jan. 14, 2020**

(54) **DISPLAY SCREEN WITH A GRAPHICAL USER INTERFACE**

(71) Applicant: **INSULET CORPORATION**, Acton, MA (US)

(72) Inventors: **Sandhya Pillalamarri**, Methuen, MA (US); **Jorge Borges**, Billerica, MA (US); **Susan Mercer**, Waltham, MA (US)

(73) Assignee: **Insulet Corporation**, Acton, MA (US)

(**) Term: **15 Years**

D741,871 S * 10/2015 Chung G06F 3/04817 D14/485
D748,664 S * 2/2016 Noack D14/486
D752,607 S * 3/2016 Zhang D14/485
D754,181 S * 4/2016 Dong D14/487
D760,272 S * 6/2016 Li D14/487
D762,702 S * 8/2016 Hoang D14/487
D764,507 S * 8/2016 Gansca D14/486
D766,264 S * 9/2016 Kahn D14/485
D768,188 S * 10/2016 Li D14/488
D779,523 S * 2/2017 Jensen D14/486
D779,526 S * 2/2017 Volovik D14/486
D781,302 S * 3/2017 Baguley D14/485
D784,395 S * 4/2017 Laing D14/487

(Continued)

Primary Examiner — Daniel J Domino

(21) Appl. No.: **29/597,104**

(22) Filed: **Mar. 14, 2017**

(51) **LOC (12) Cl.** **14-04**

(52) **U.S. Cl.**
USPC **D14/485**

(58) **Field of Classification Search**
USPC D14/485–495
CPC G06F 3/048; G06F 3/0481; G06F 3/0482; G06F 3/04842; G06F 3/04847; G06F 3/0485; G06F 1/1692; G06F 2203/04806
See application file for complete search history.

(57) **CLAIM**

The ornamental design for a display screen with a graphical user interface, as shown and described.

DESCRIPTION

FIG. 1 is a front view of a display screen with a graphical user interface showing our new design; FIG. 2 is a front view of a second embodiment thereof; FIG. 3 is a front view of a third embodiment thereof; FIG. 4 is a front view of a fourth embodiment thereof; FIG. 5 is a front view of a fifth embodiment thereof; FIG. 6 is a front view of a sixth embodiment thereof; FIG. 7 is a front view of a seventh embodiment thereof; FIG. 8 is a front view of an eighth embodiment thereof; FIG. 9 is a front view of a ninth embodiment thereof; FIG. 10 is a front view of a tenth embodiment thereof; FIG. 11 is a front view of an eleventh embodiment thereof; FIG. 12 is a front view of a twelfth embodiment thereof; and, FIG. 13 is a front view of a thirteenth embodiment thereof. The broken line showing of display screens, text and graphical elements form no part of the claimed design.

1 Claim, 13 Drawing Sheets

(56) **References Cited**

U.S. PATENT DOCUMENTS

6,768,425 B2 * 7/2004 Flaherty A61B 5/14532 128/920
D674,400 S * 1/2013 Fong D14/486
D677,675 S * 3/2013 Rampson D14/485
D688,681 S * 8/2013 Talbot D14/486
D703,690 S * 4/2014 MacCubbin D14/488
D713,854 S * 9/2014 Cojuangco D14/486
D714,335 S * 9/2014 Cojuangco D14/486
D733,740 S * 7/2015 Lee D14/487

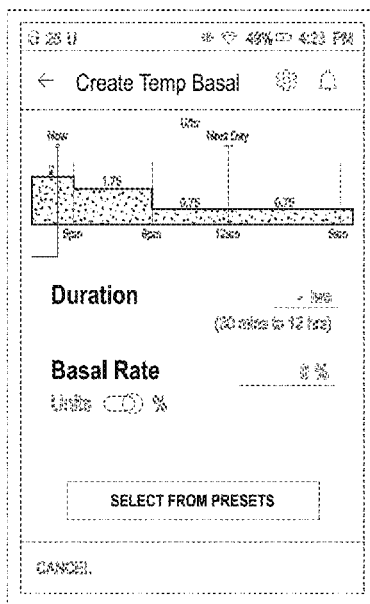

(56)

References Cited

U.S. PATENT DOCUMENTS

D791,813 S *	7/2017	Kisielius	D14/486	D835,631 S *	12/2018	Yepez	D14/485
D795,272 S *	8/2017	Laing	D14/485	D835,663 S *	12/2018	Ho	D14/487
D802,011 S *	11/2017	Friedman	D14/488	D837,240 S *	1/2019	Van Tricht	D14/486
D807,389 S *	1/2018	Miller	D14/487	D839,284 S *	1/2019	Pillalamarri	D14/485
D807,911 S *	1/2018	Zhou	D14/487	D840,420 S *	2/2019	Chalker	D14/485
D810,122 S *	2/2018	McClellan	D14/488	D840,421 S *	2/2019	Chalker	D14/485
D816,092 S *	4/2018	Mazur	D14/485	D841,023 S *	2/2019	Millett	D14/485
D816,698 S *	5/2018	Oldenburger	D14/486	D844,652 S *	4/2019	Edman	D14/486
D817,977 S *	5/2018	Kato	D14/485	D845,991 S *	4/2019	Kessler	D14/488
D822,692 S *	7/2018	Loychik	D14/486	D847,154 S *	4/2019	Cheney	D14/485
D824,933 S *	8/2018	Harris	D14/486	D847,169 S *	4/2019	Sombreiraireiro	D14/486
D826,239 S *	8/2018	Duriseti	D14/485	D847,852 S *	5/2019	Sapre	D14/488
D826,956 S *	8/2018	Pillalamarri	D14/485	D848,460 S *	5/2019	Wiese	D14/486
D829,229 S *	9/2018	Durkan	D14/486	D849,767 S *	5/2019	Mok	D14/486
D830,407 S *	10/2018	Kisielius	D14/487	D851,666 S *	6/2019	Lu	D14/486
D831,034 S *	10/2018	Hoang	D14/485	D853,416 S *	7/2019	Ryan	D14/486
D833,461 S *	11/2018	Dieken	D14/485	D853,426 S *	7/2019	Alexander	D14/486
D834,061 S *	11/2018	Wall	D14/489	D853,427 S *	7/2019	Alexander	D14/486
D834,610 S *	11/2018	Kim	D14/488	D854,559 S *	7/2019	Dudey	D14/486
D835,116 S *	12/2018	Taylor	D14/485	2014/0078263 A1 *	3/2014	Kim	G06T 7/285 348/47
				2017/0214584 A1 *	7/2017	Kanojia	H04L 67/145

* cited by examiner

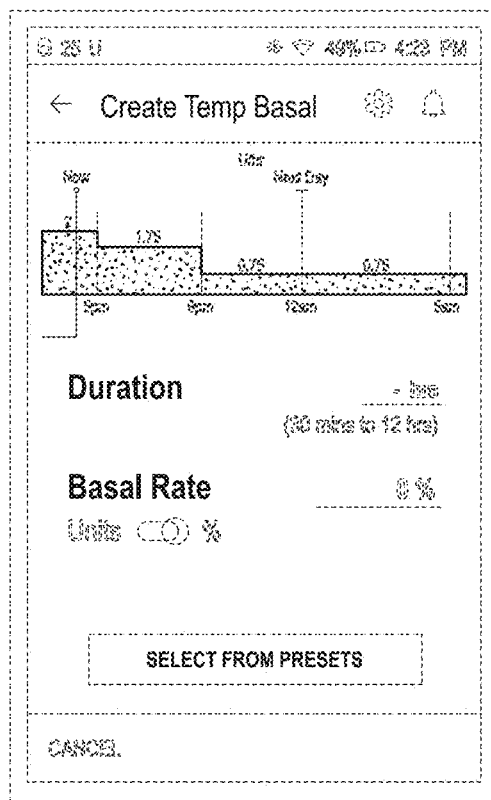

FIG. 1

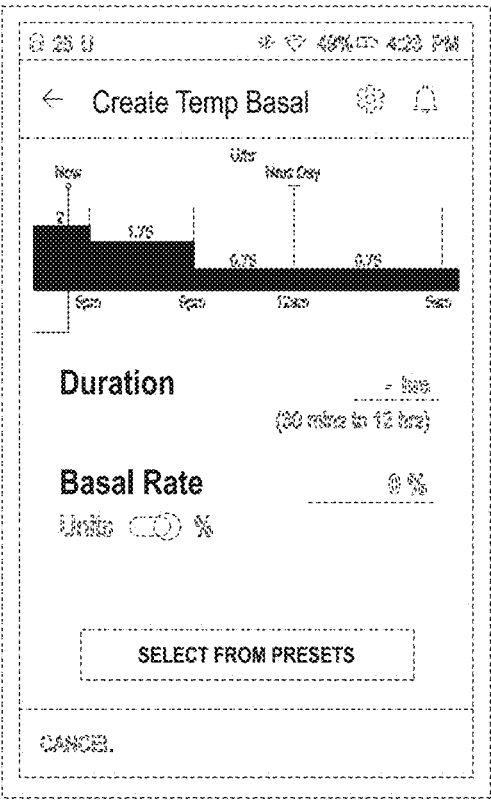

FIG. 2

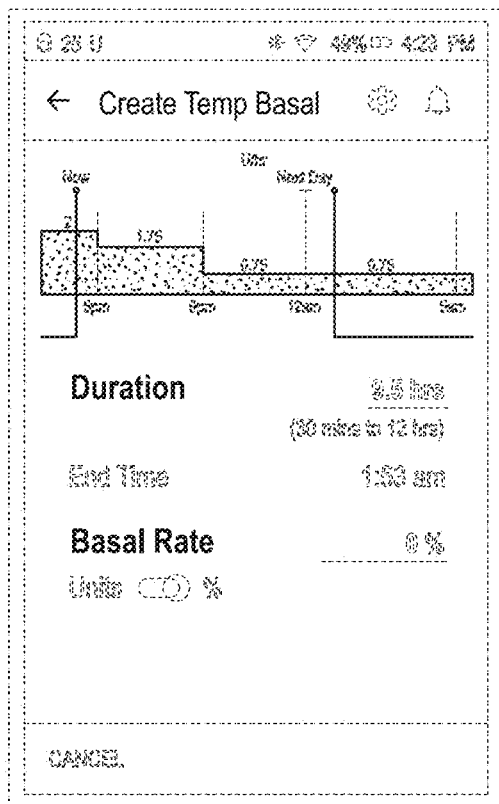

FIG. 3

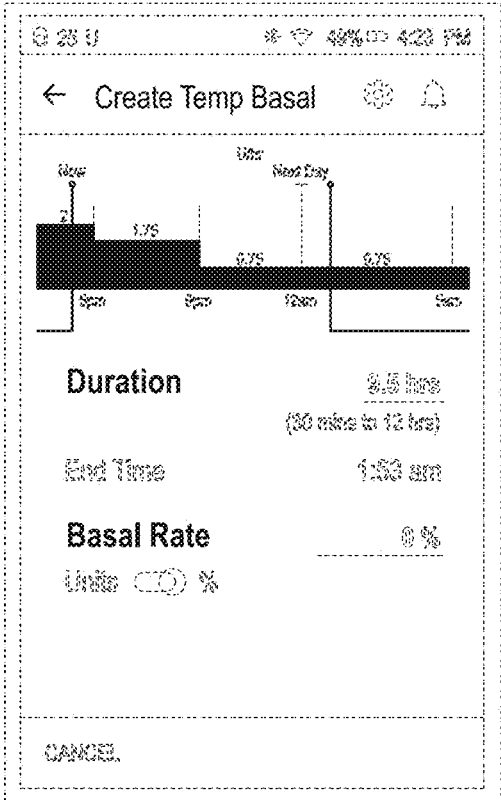

FIG. 4

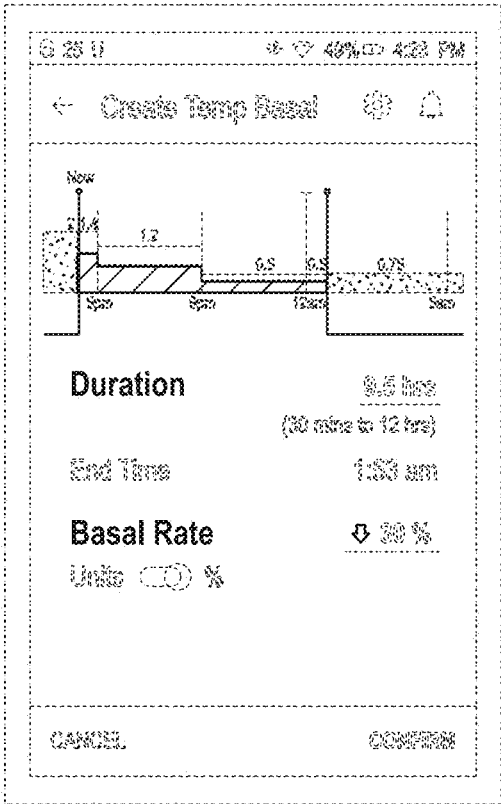

FIG. 5

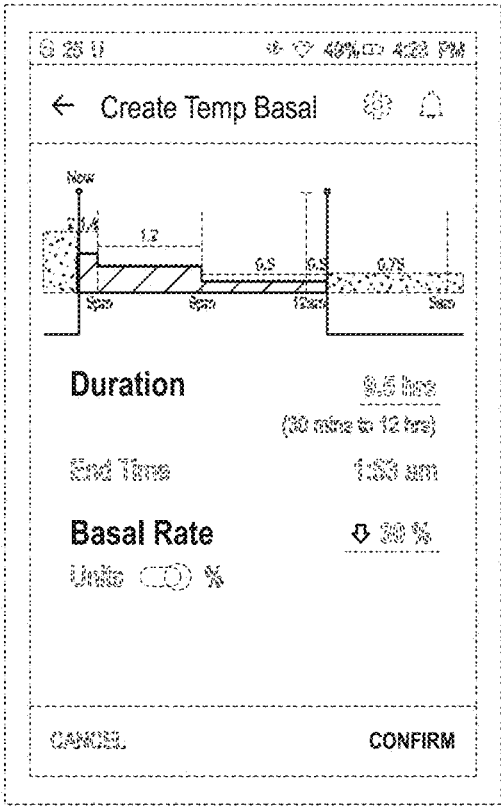

FIG. 6

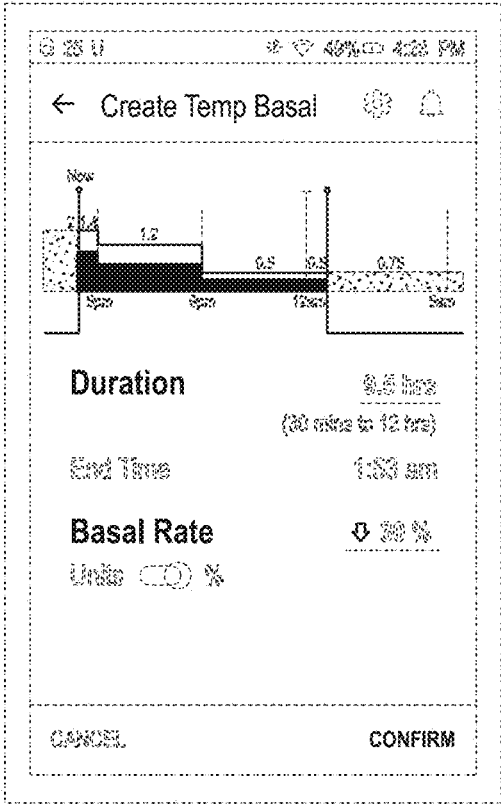

FIG. 7

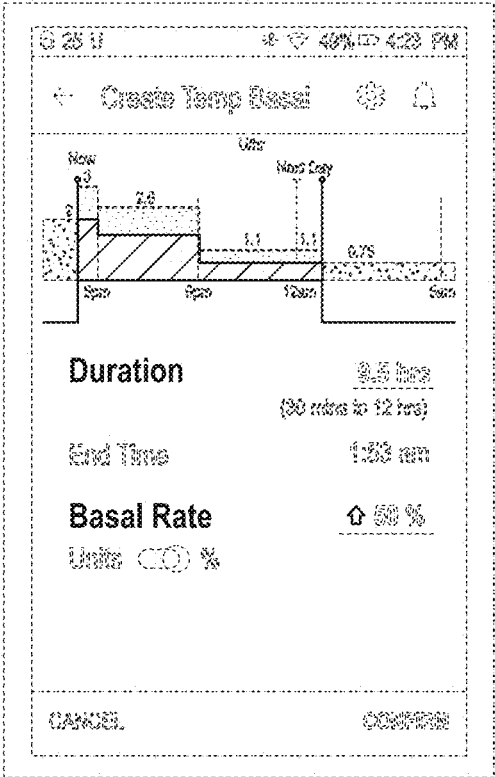

FIG. 8

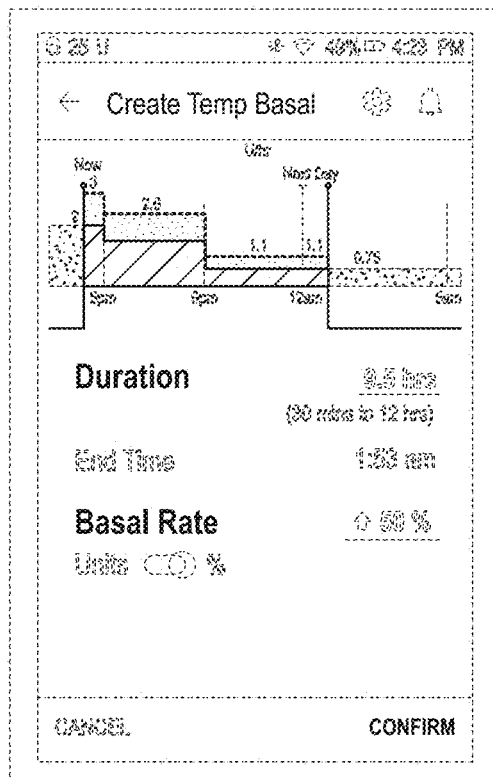

FIG. 9

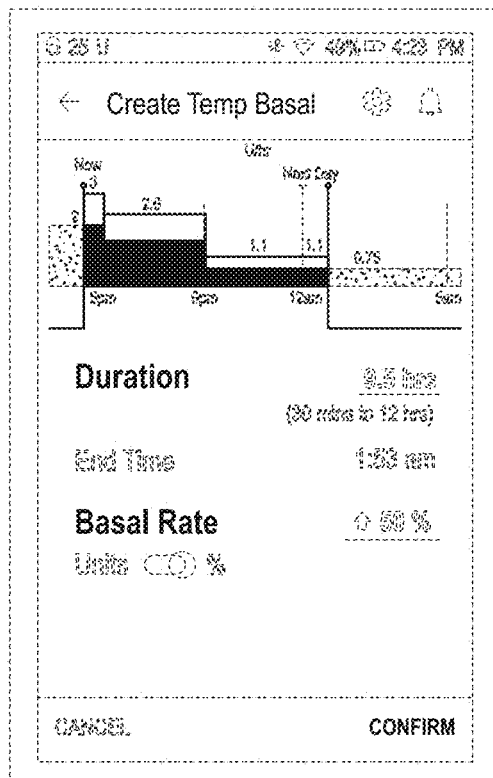

FIG. 10

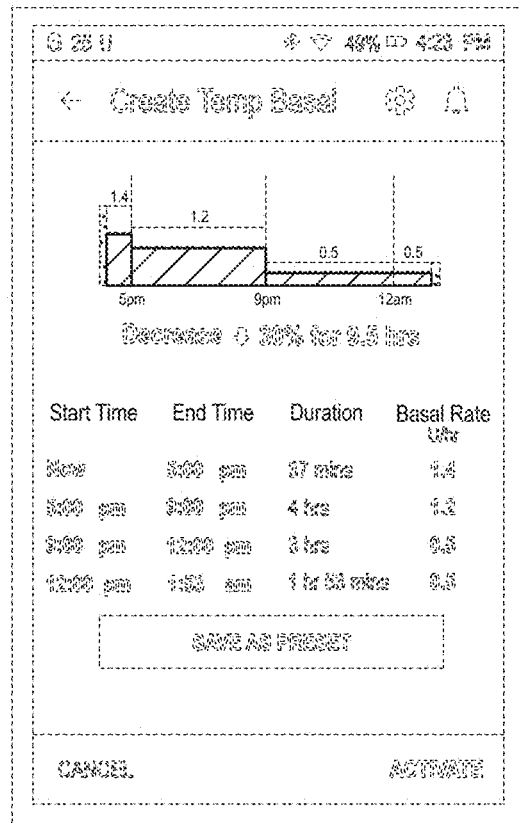

FIG. 11

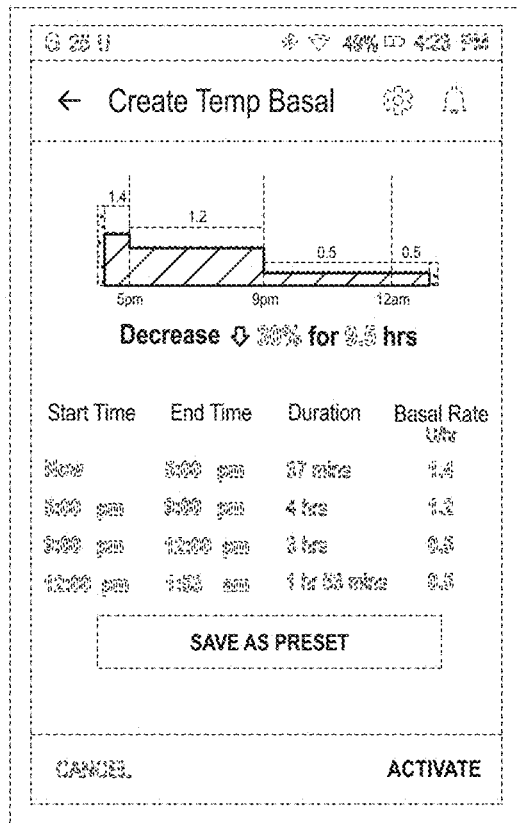

FIG. 12

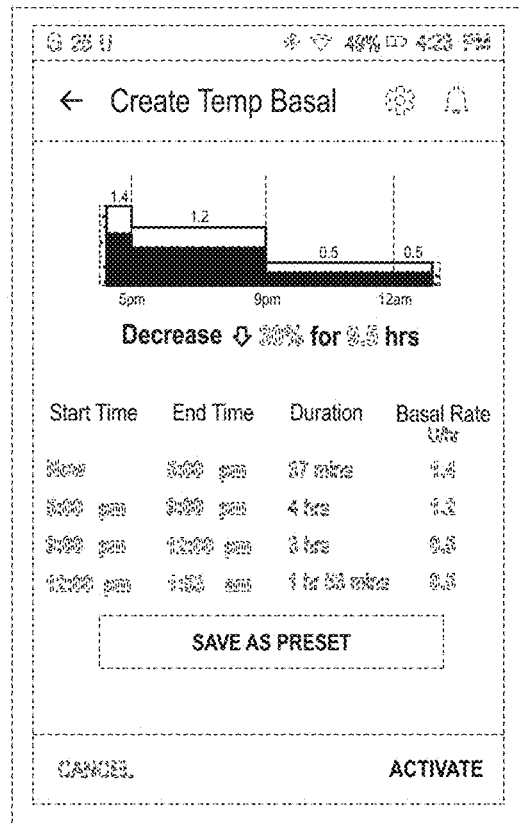

FIG. 13