



(12) **United States Design Patent**  
**Deng**

(10) **Patent No.:** **US D952,610 S**  
(45) **Date of Patent:** **\*\* May 24, 2022**

(54) **EARPHONES WITH CHARGING CASE**

**FOREIGN PATENT DOCUMENTS**

(71) Applicant: **SHENZHEN XIWXI TECHNOLOGY CO., LTD**, Shenzhen (CN)

CA 193607 \* 2/2022  
GB 6138818 \* 5/2021

(Continued)

*Primary Examiner* — Paula Allen Greene

(72) Inventor: **Xiuhong Deng**, Shaoyang (CN)

(57) **CLAIM**

(73) Assignee: **SHENZHEN XIWXI TECHNOLOGY CO., LTD**, Shenzhen (CN)

The ornamental design for earphones with charging case, as shown and described.

**DESCRIPTION**

(\*\*) Term: **15 Years**

FIG. 1 is a perspective view of earphones of earphones with charging case, shown separately for ease of illustration; FIG. 2 is another perspective view thereof; FIG. 3 is a front elevational view thereof; FIG. 4 is a rear elevational view thereof; FIG. 5 is a left elevational view thereof; FIG. 6 is a right side elevational view thereof; FIG. 7 is a top plan view thereof; FIG. 8 is a bottom plan view thereof; FIG. 9 is a perspective view of the charging case of the earphones with charging case, shown separately for ease of illustration and in an open configuration; FIG. 10 is another perspective view thereof; FIG. 11 is a front elevational view thereof; FIG. 12 is a rear elevational view thereof; FIG. 13 is a left side elevational view thereof; FIG. 14 is a right side elevational view thereof; FIG. 15 is a top plan view thereof; FIG. 16 is a bottom plan view thereof; FIG. 17 is a perspective view of the earphones with charging case where the earphones are received in the charging case; and, FIG. 18 is a perspective view of the charging case of the earphones with charging case, shown separately for ease of illustration and in a closed configuration. The broken lines in the drawings depict portions of the earphones with charging case that form no part of the claimed design.

(21) Appl. No.: **29/766,401**

(22) Filed: **Jan. 15, 2021**

(51) **LOC (13) Cl.** ..... **14-01**

(52) **U.S. Cl.**  
USPC ..... **D14/223**; D3/274

(58) **Field of Classification Search**  
USPC ..... D14/223, 205, 224; D13/108; D3/201, D3/294, 274; D9/420, 424, 529, 521; D28/76, 66, 78; 206/702, 268; 220/4.22; D24/174; 128/864-866; 381/380, 381, 381/322, 328; 320/110; 455/90.3, 575.1, 455/569.1  
CPC ..... H04R 1/10; H04R 25/00; H04R 25/02; H04R 1/1066; H04R 1/1016; H04R 5/033;

(Continued)

(56) **References Cited**

**U.S. PATENT DOCUMENTS**

1,833,305 A \* 11/1931 Rathbun ..... E05D 1/04 220/829  
2,271,630 A \* 2/1942 Dahlgren ..... B65D 43/165 220/283

(Continued)

**1 Claim, 18 Drawing Sheets**

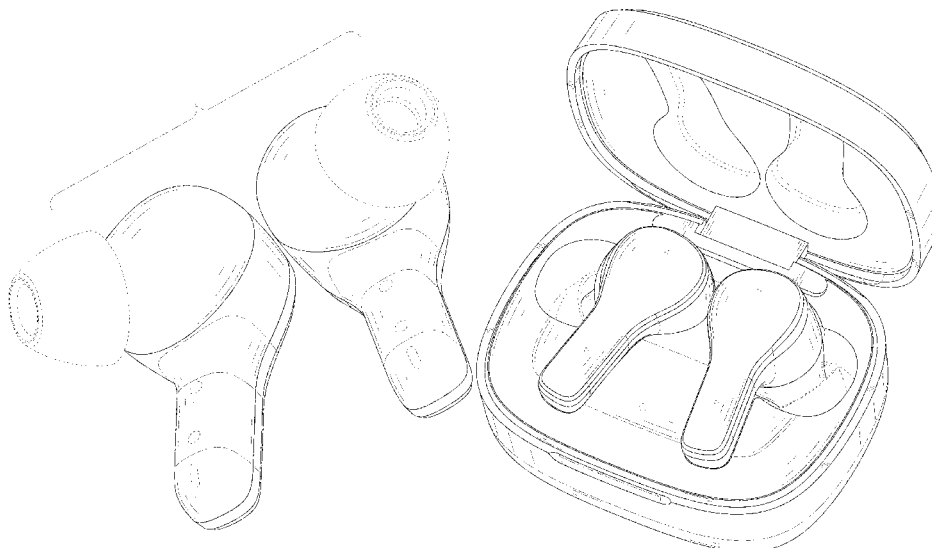

(58) **Field of Classification Search**  
 CPC ..... H04R 5/0335; B65D 5/00; B65D 43/02;  
 B65D 25/10  
 See application file for complete search history.

(56) **References Cited**

U.S. PATENT DOCUMENTS

2,319,346 A \* 5/1943 Rathbun ..... A47F 7/03  
 220/829  
 3,355,088 A \* 11/1967 Young ..... A45C 13/005  
 220/829  
 3,416,655 A \* 12/1968 Shiffman ..... A45C 11/16  
 220/829  
 3,477,091 A \* 11/1969 Gordon ..... E05D 1/02  
 220/829  
 3,894,654 A \* 7/1975 Frankenberg ..... B65D 43/165  
 16/385  
 D259,596 S \* 6/1981 Gray ..... D3/205  
 D273,051 S \* 3/1984 Runyon ..... D9/423  
 4,454,889 A \* 6/1984 Contreras, Sr. .... A45D 40/22  
 220/829  
 D365,483 S \* 12/1995 Van Dyk ..... D6/536  
 5,782,371 A \* 7/1998 Baerenwald ..... B65D 43/168  
 220/4.24  
 D479,016 S \* 8/2003 Sgariboldi ..... D28/78  
 D531,025 S \* 10/2006 Tanner ..... D9/426  
 D630,505 S \* 1/2011 Westemeyer ..... D9/426  
 D646,159 S \* 10/2011 Bellamah ..... D9/424  
 8,117,807 B2 \* 2/2012 Bellamah ..... B65D 15/24  
 220/4.27  
 D665,253 S \* 8/2012 Bellamah ..... D9/424  
 D674,688 S \* 1/2013 Loftin ..... D9/428  
 D690,588 S \* 10/2013 Pipes ..... D9/424  
 D694,102 S \* 11/2013 Bellamah ..... D9/424  
 8,910,781 B2 \* 12/2014 Pipes ..... B65B 7/28  
 220/780  
 D740,018 S \* 10/2015 Zhang ..... D3/265  
 9,445,631 B1 \* 9/2016 Patel ..... A24F 23/00  
 D772,572 S \* 11/2016 Palmborg ..... D3/294  
 D778,156 S \* 2/2017 Follett ..... D9/432  
 D838,480 S \* 1/2019 Son ..... D3/294  
 D846,264 S \* 4/2019 Wu ..... D3/201  
 D865,720 S \* 11/2019 Deng ..... D14/223  
 D869,445 S \* 12/2019 Hu ..... D14/223  
 D870,451 S \* 12/2019 Birger ..... D14/223  
 D872,711 S \* 1/2020 Hu ..... D14/223  
 D873,217 S \* 1/2020 Zhang ..... D3/294  
 D878,048 S \* 3/2020 Wang ..... D3/294  
 D881,810 S \* 4/2020 Zhang ..... D13/108

D882,259 S \* 4/2020 Liu ..... D3/269  
 D882,262 S \* 4/2020 Zhang ..... D3/294  
 D883,260 S \* 5/2020 Hu ..... D14/223  
 D886,454 S \* 6/2020 Williamson ..... D3/294  
 D886,455 S \* 6/2020 Williamson ..... D3/294  
 D887,396 S \* 6/2020 Wang ..... D14/223  
 D889,436 S \* 7/2020 Zhang ..... D14/206  
 D890,138 S \* 7/2020 Peng ..... D14/223  
 D890,725 S \* 7/2020 Liu ..... D14/223  
 D893,462 S \* 8/2020 Liu ..... D14/223  
 10,750,268 B2 \* 8/2020 Dang ..... H04R 1/1025  
 D895,579 S \* 9/2020 Yang ..... D14/223  
 D895,582 S \* 9/2020 Wu ..... D14/223  
 D896,206 S \* 9/2020 Xu ..... D14/223  
 D896,207 S \* 9/2020 He ..... D14/223  
 D897,998 S \* 10/2020 Ma ..... D14/223  
 D904,764 S \* 12/2020 Koneru ..... D3/294  
 D905,018 S \* 12/2020 Zhu ..... D14/223  
 D908,084 S \* 1/2021 He ..... D3/294  
 D910,600 S \* 2/2021 Zhang ..... D14/223  
 D910,601 S \* 2/2021 Hu ..... D14/223  
 D913,223 S \* 3/2021 Li ..... D3/294  
 D914,652 S \* 3/2021 Chen ..... D14/223  
 D916,683 S \* 4/2021 Yao ..... D14/223  
 D916,684 S \* 4/2021 Fang ..... D14/223  
 D921,615 S \* 6/2021 Wu ..... D14/223  
 D924,209 S \* 7/2021 Wu ..... D14/223  
 D925,498 S \* 7/2021 Lin ..... D14/223  
 D925,852 S \* 7/2021 XiangZe ..... D32/55  
 D931,838 S \* 9/2021 Deng ..... D14/223  
 D932,472 S \* 10/2021 Wang ..... D14/223  
 D934,839 S \* 11/2021 Zhong ..... D14/223  
 D940,073 S \* 1/2022 Yu ..... D3/294  
 D941,580 S \* 1/2022 Liu ..... D3/274  
 D943,553 S \* 2/2022 Zhang ..... D14/223  
 D943,554 S \* 2/2022 Zhang ..... D14/223  
 D946,513 S \* 3/2022 Lin ..... D14/223  
 2003/0230514 A1 \* 12/2003 Baker ..... B65D 51/245  
 206/39  
 2011/0186579 A1 \* 8/2011 Bailey ..... B65D 25/54  
 220/795  
 2014/0197054 A1 \* 7/2014 Pipes ..... A24F 23/00  
 206/265  
 2020/0084532 A1 \* 3/2020 Lo ..... H02J 7/0044  
 2020/0252715 A1 \* 8/2020 Zhou ..... H04R 1/1041

FOREIGN PATENT DOCUMENTS

GB 6188746 \* 1/2022  
 JP D1660248 \* 5/2020

\* cited by examiner

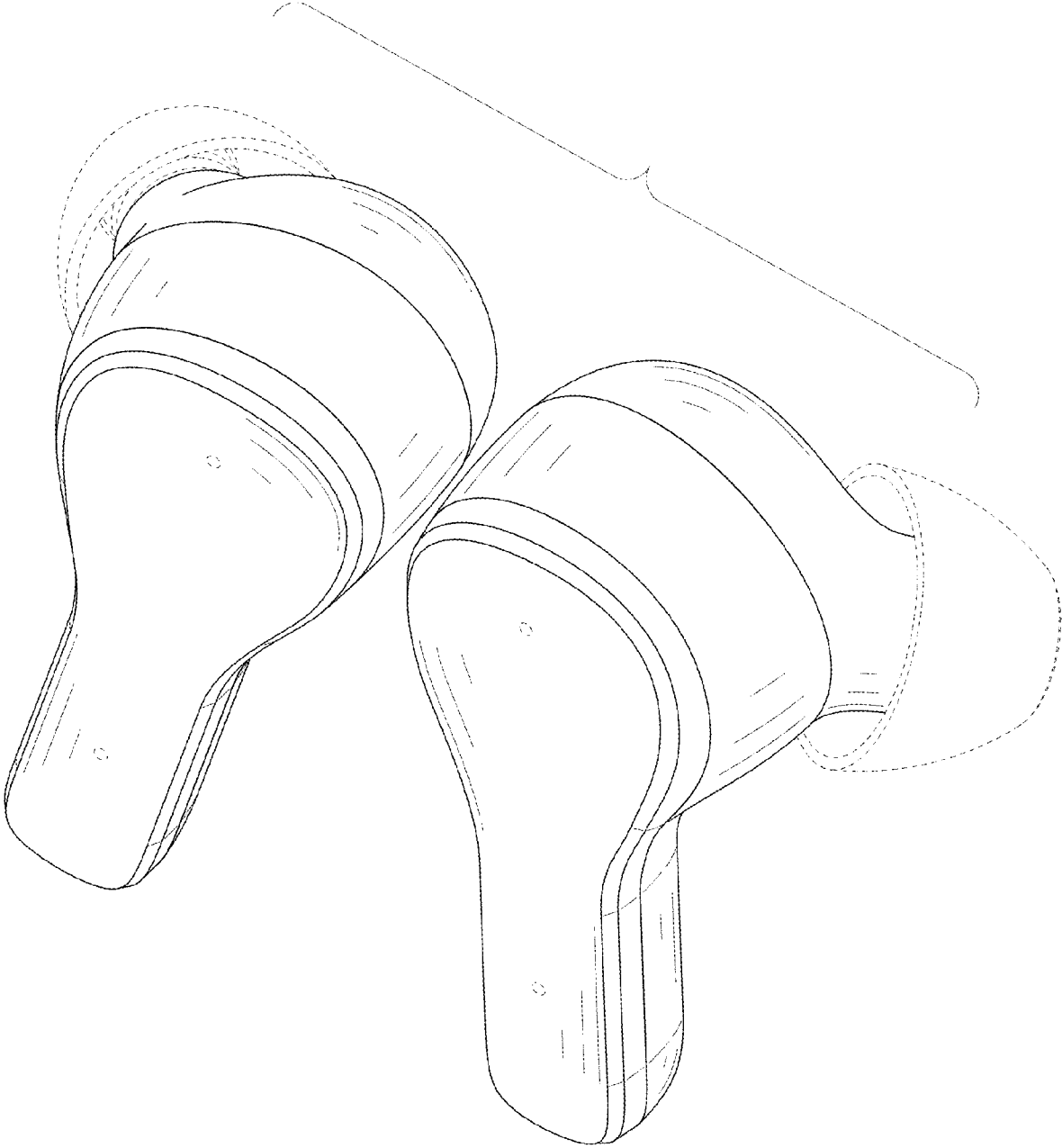

FIG. 1

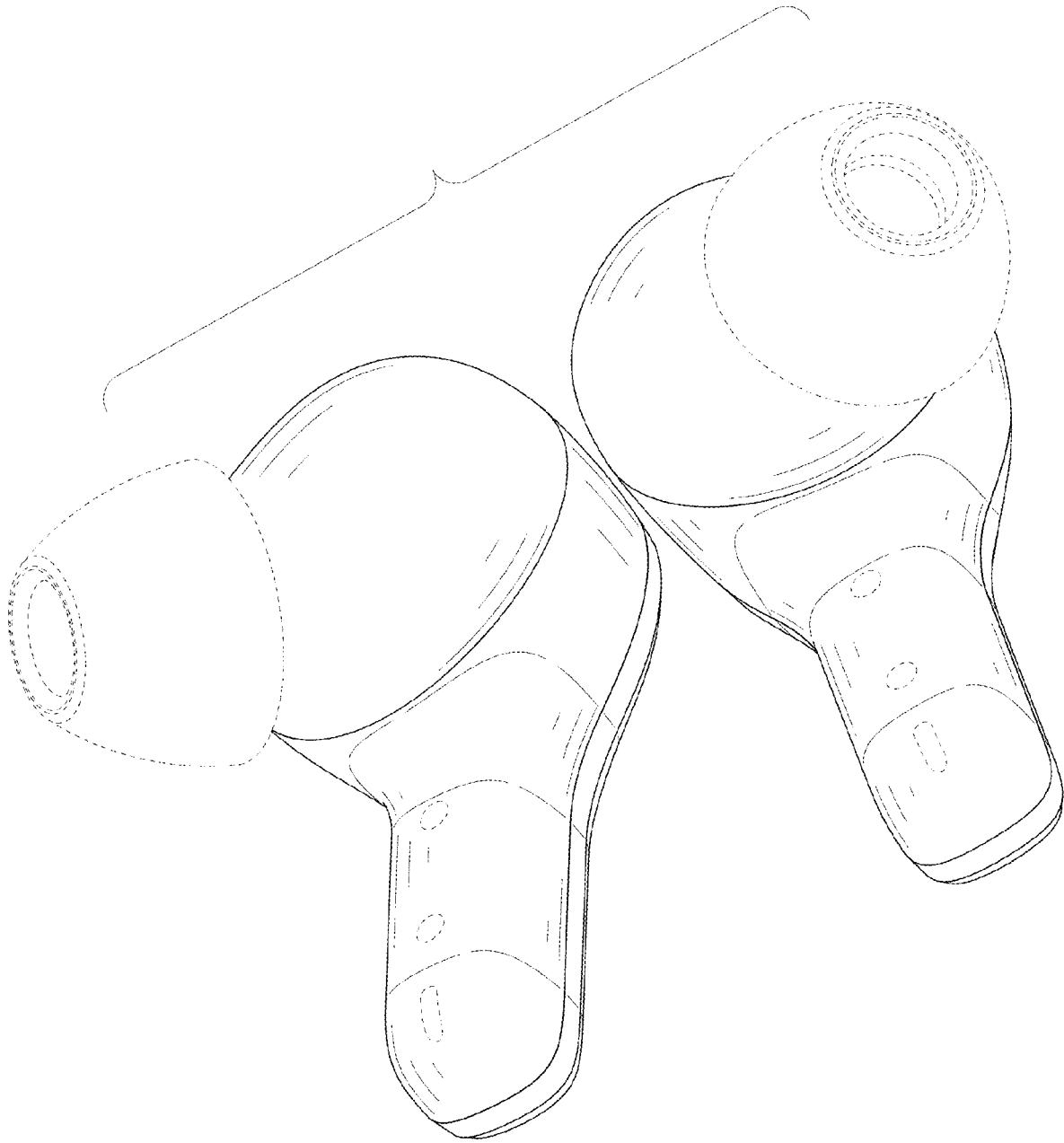

FIG. 2

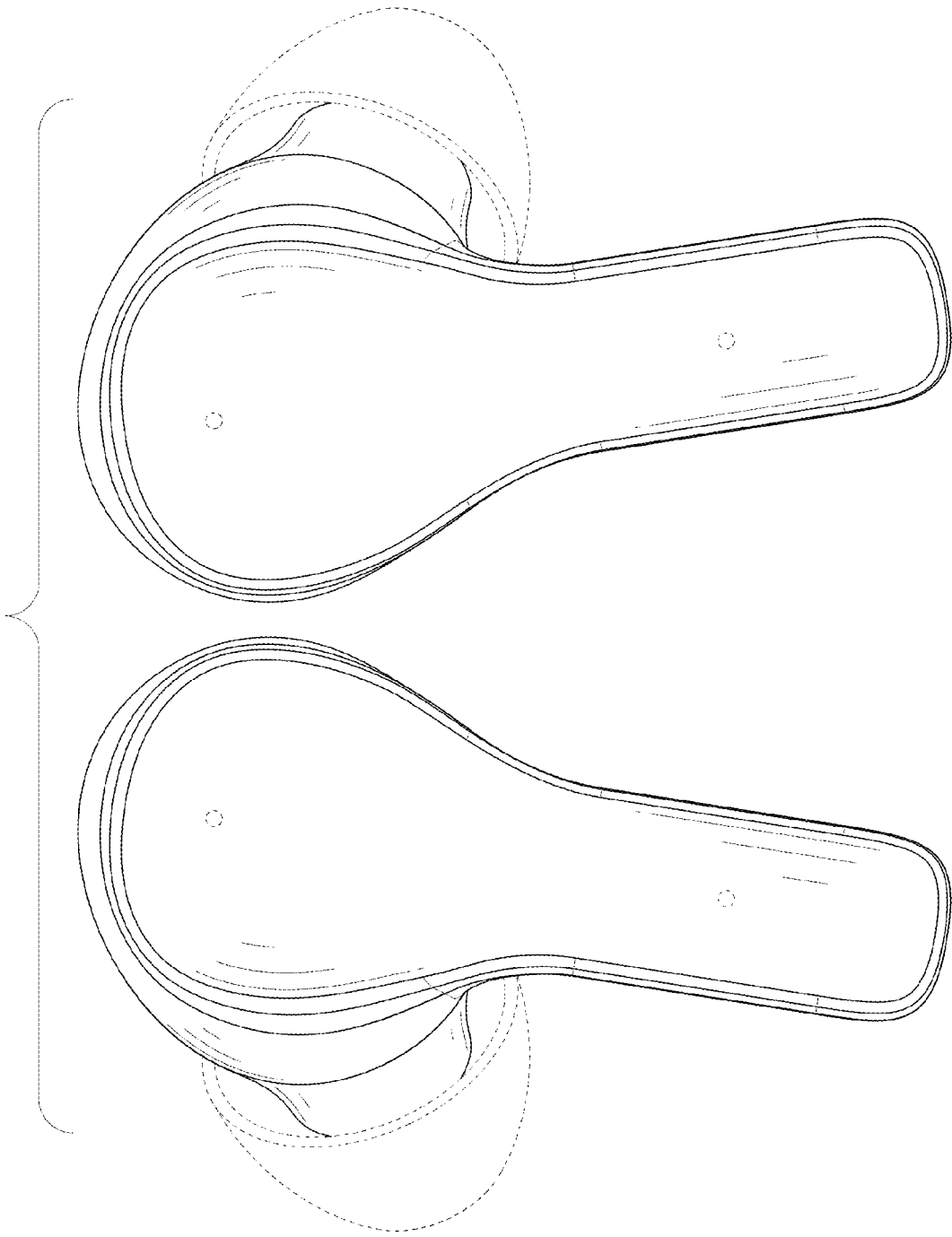

FIG. 3

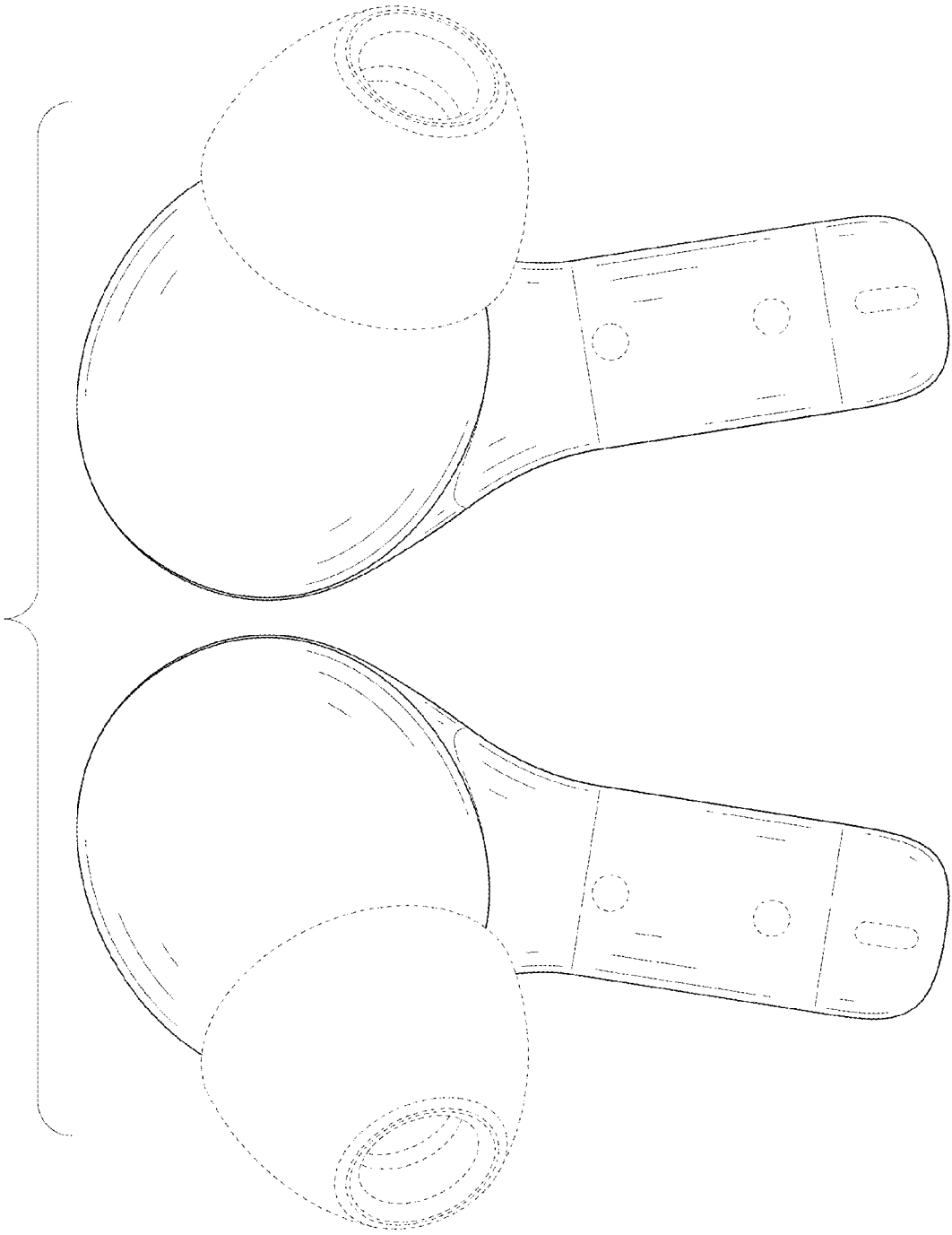

FIG. 4

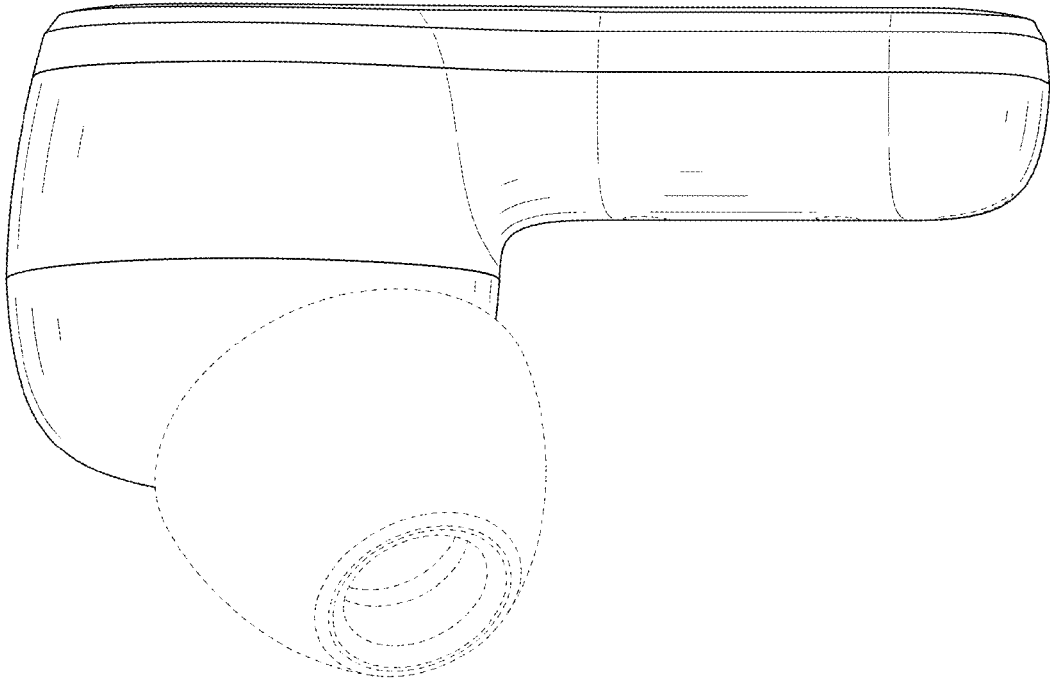

FIG. 5

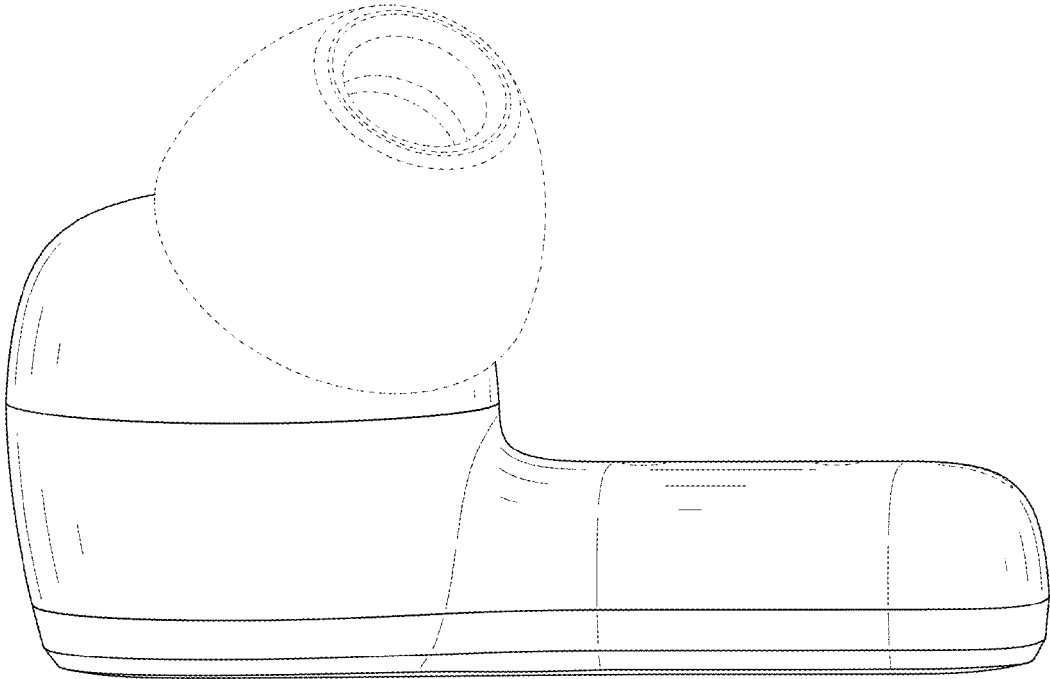

FIG. 6



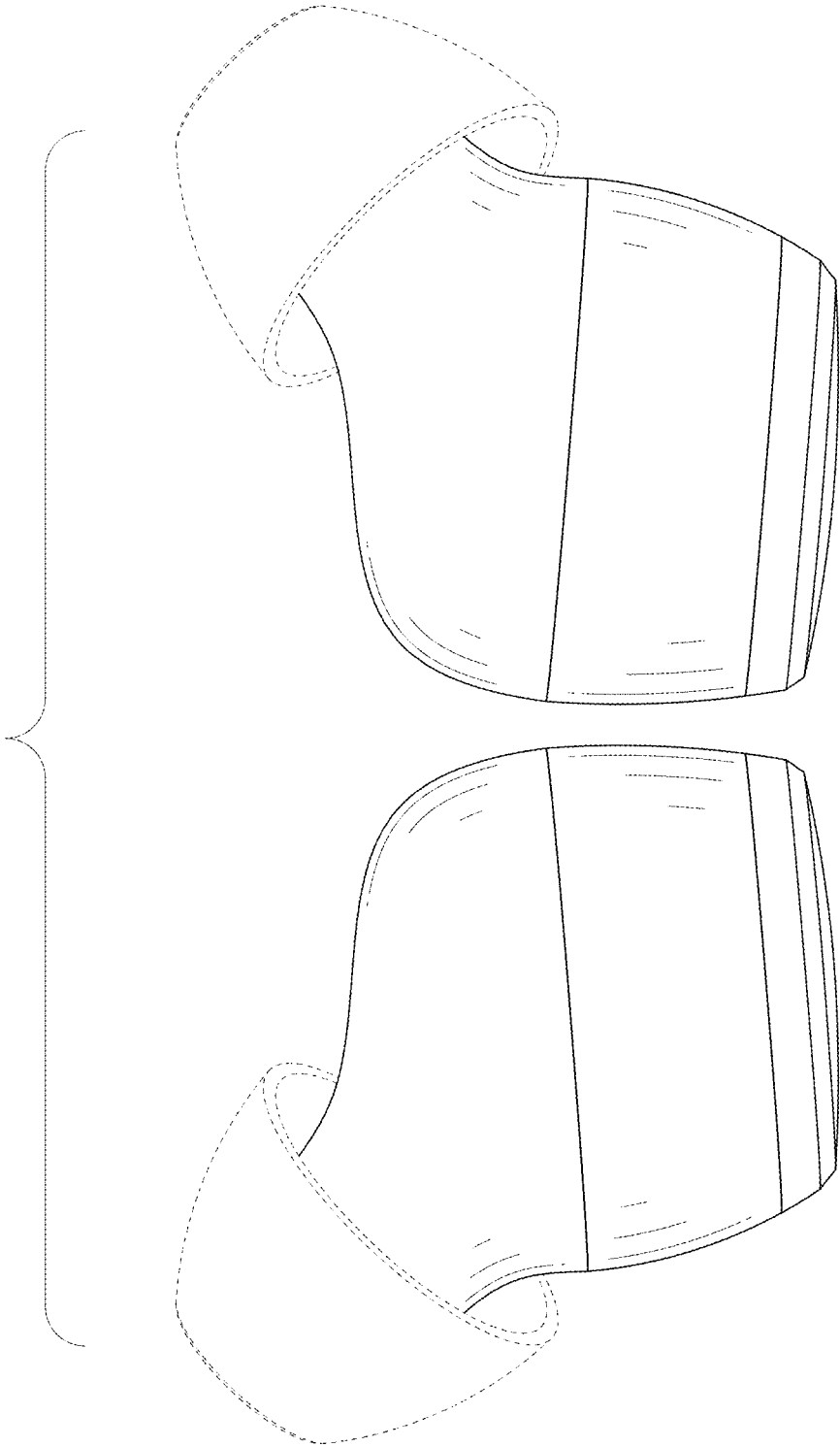

FIG. 7

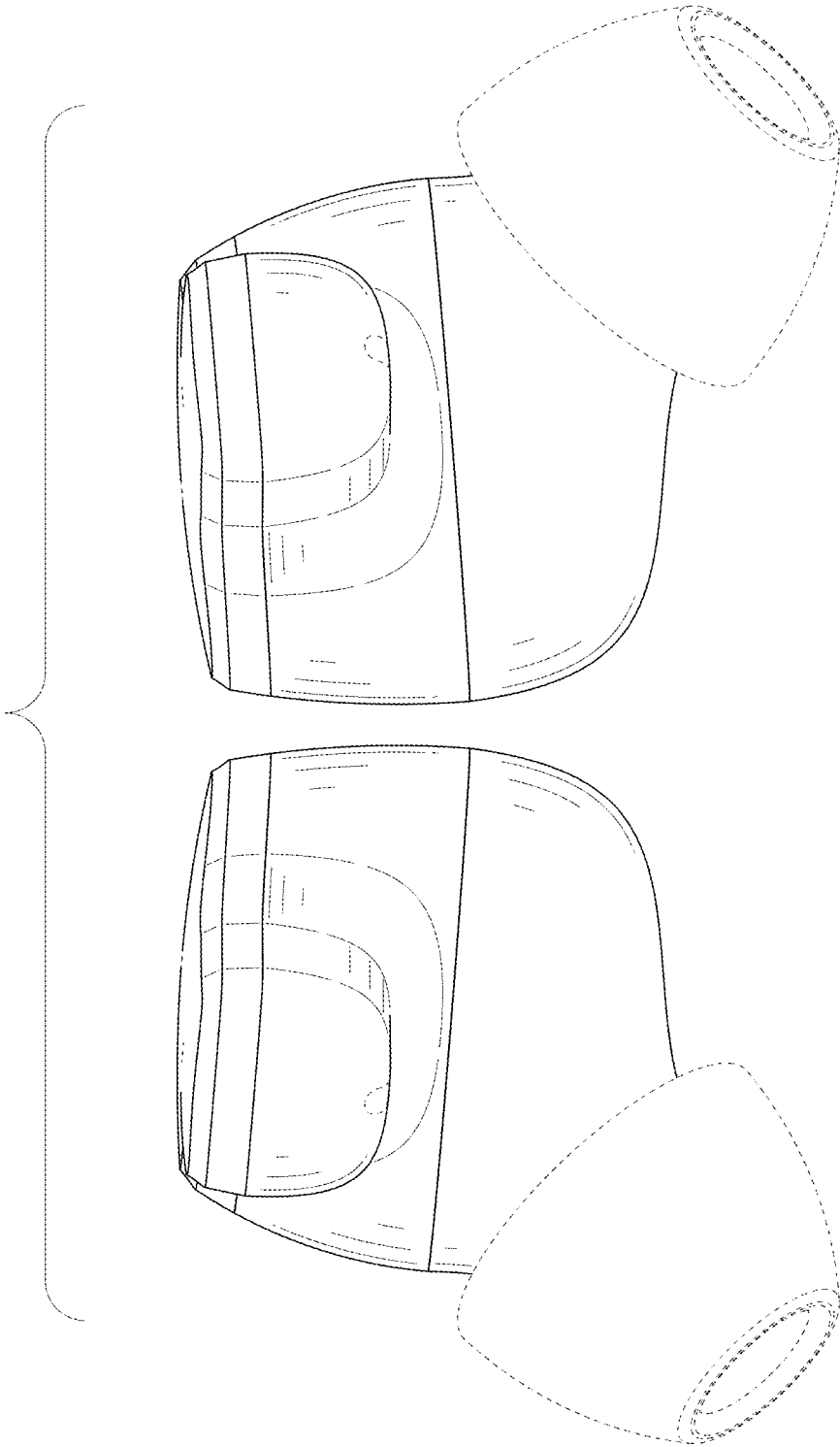

FIG. 8

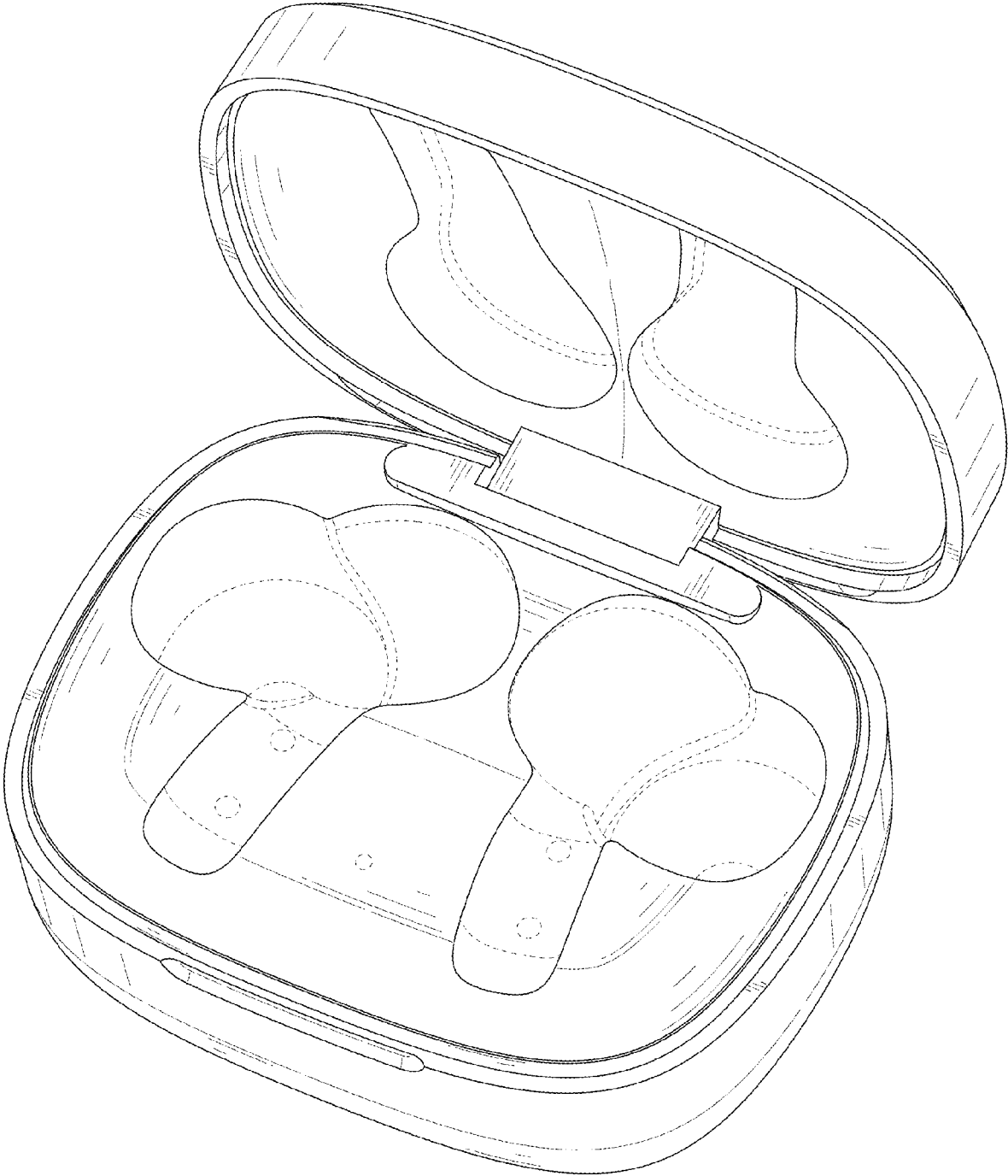

FIG. 9

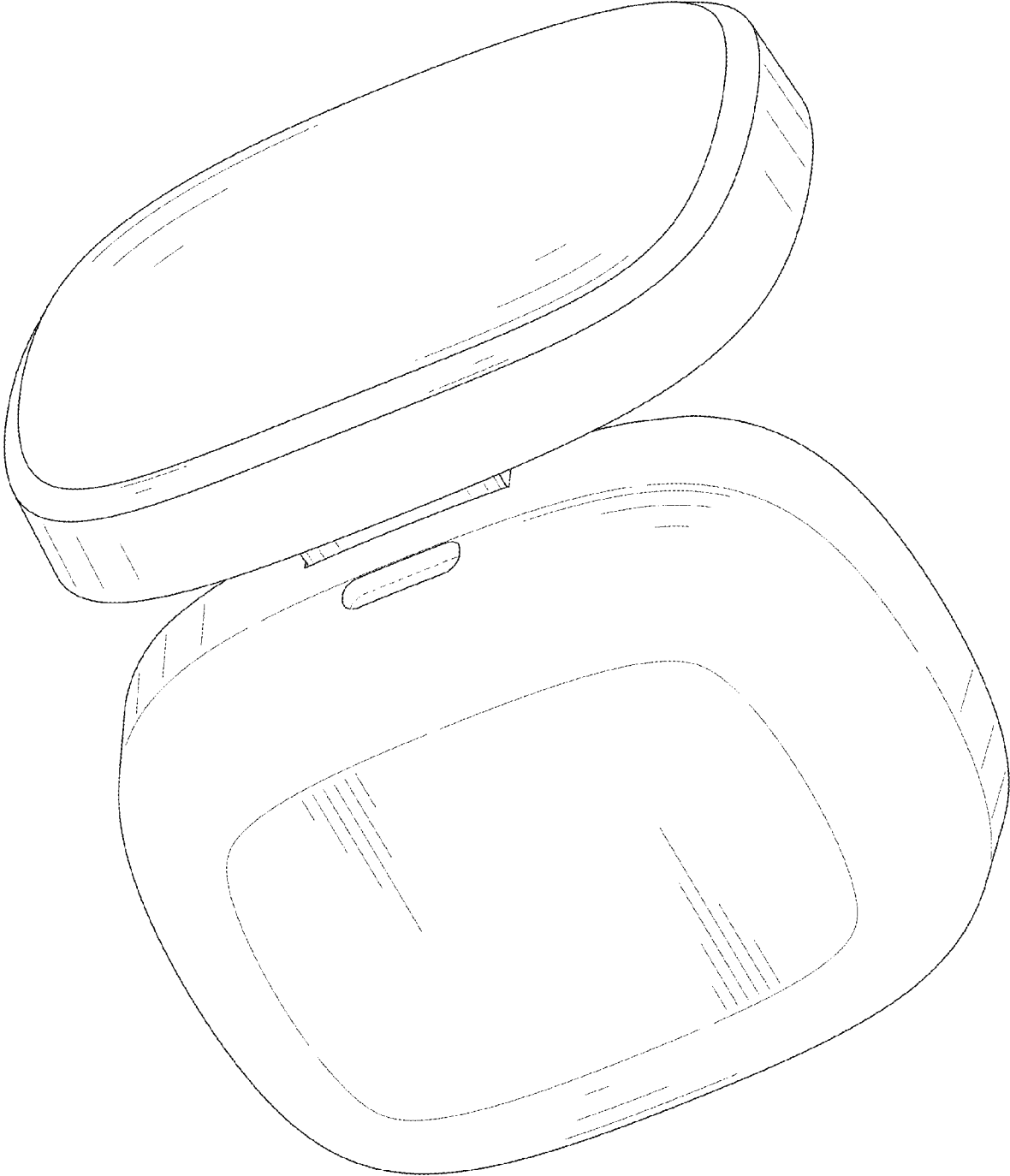

FIG. 10

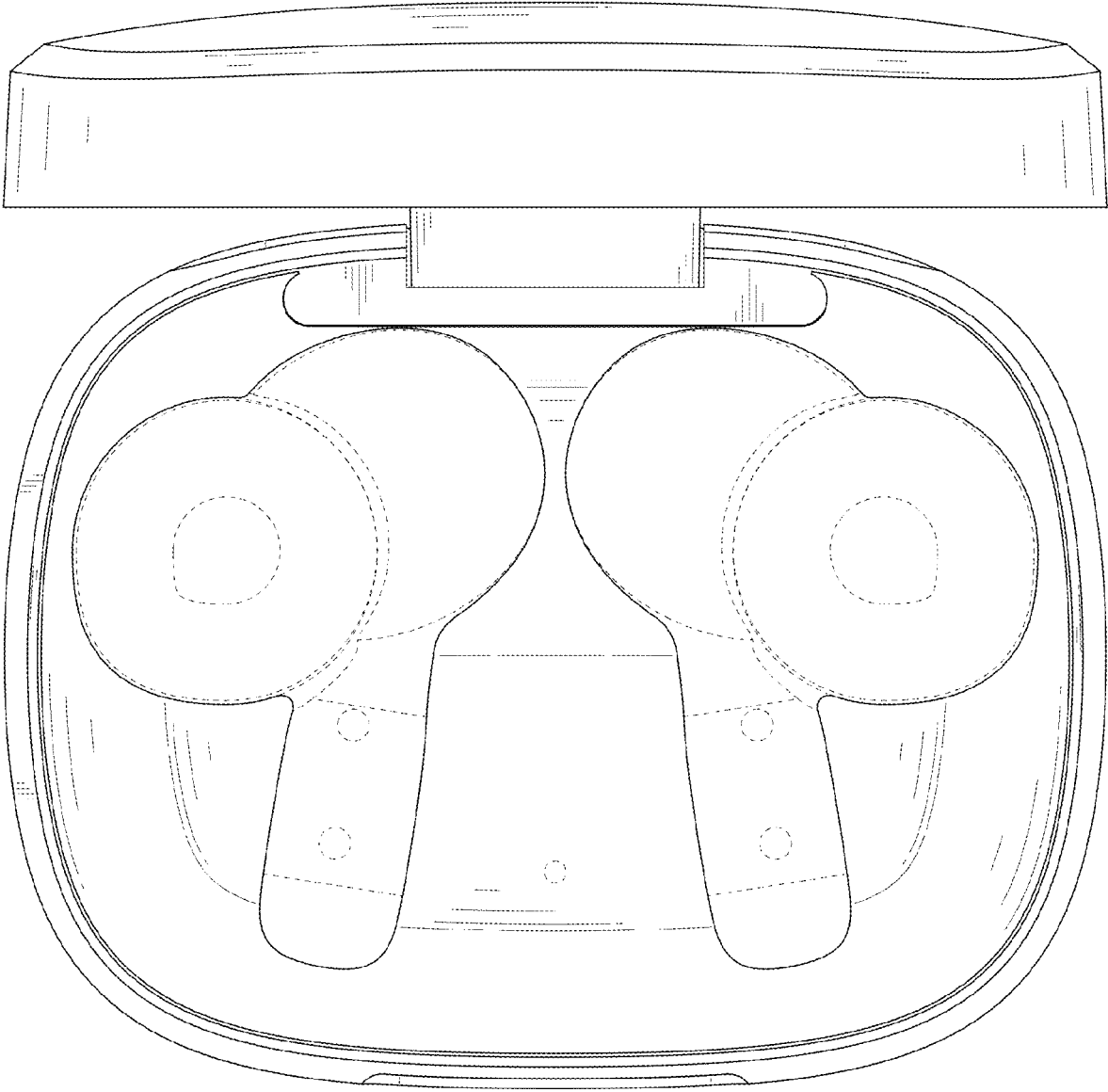

FIG. 11

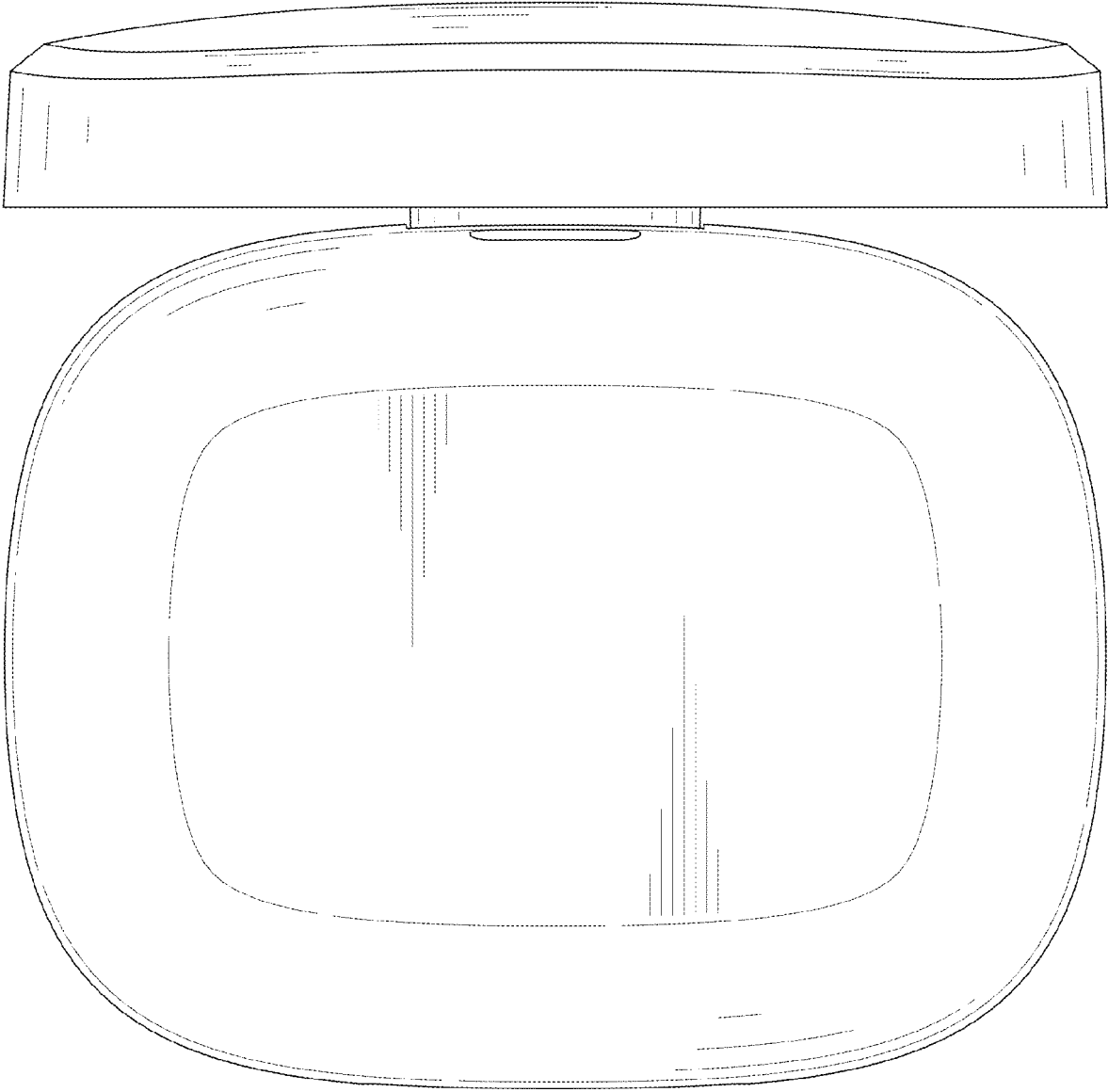

FIG. 12

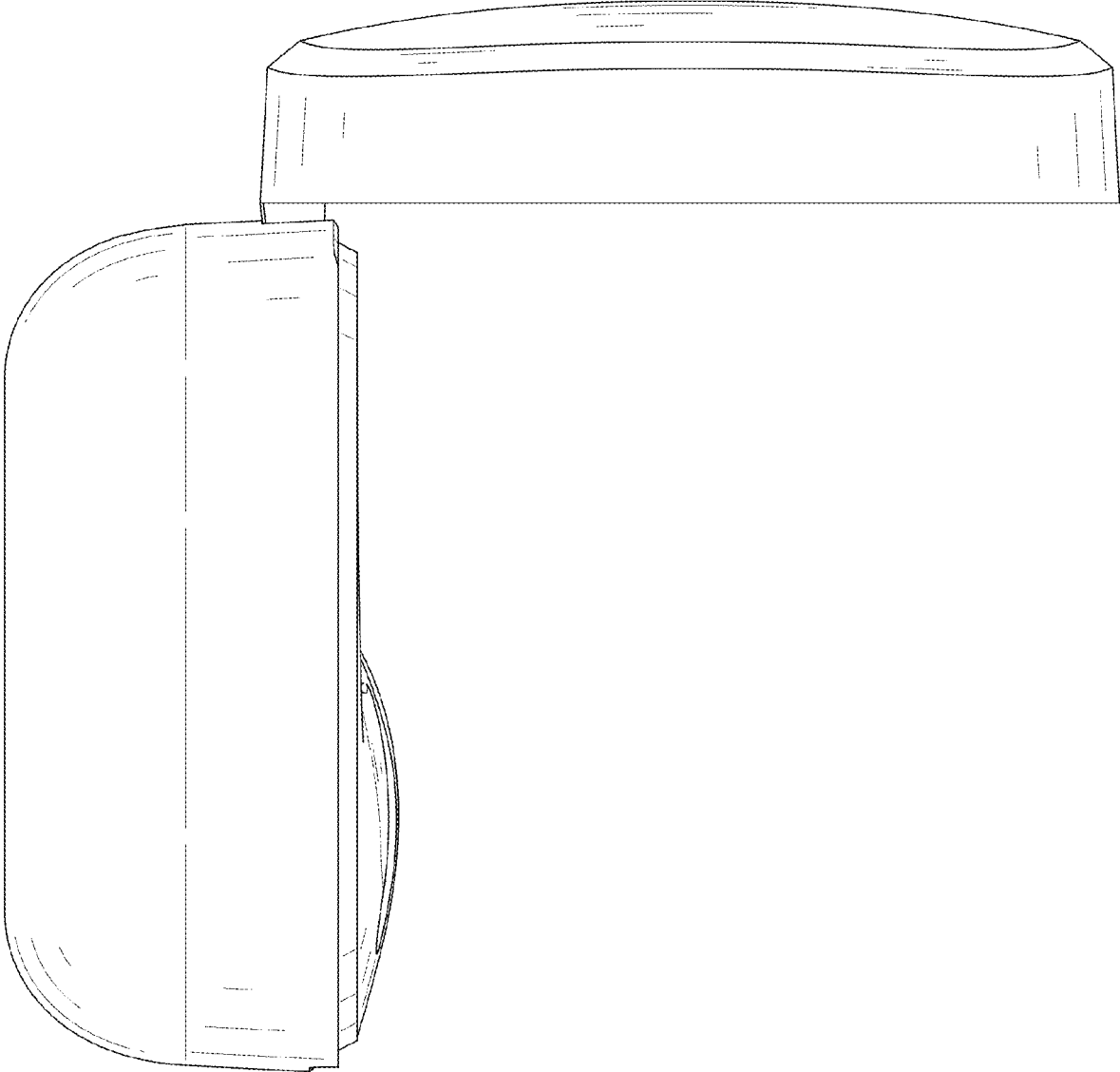

FIG. 13

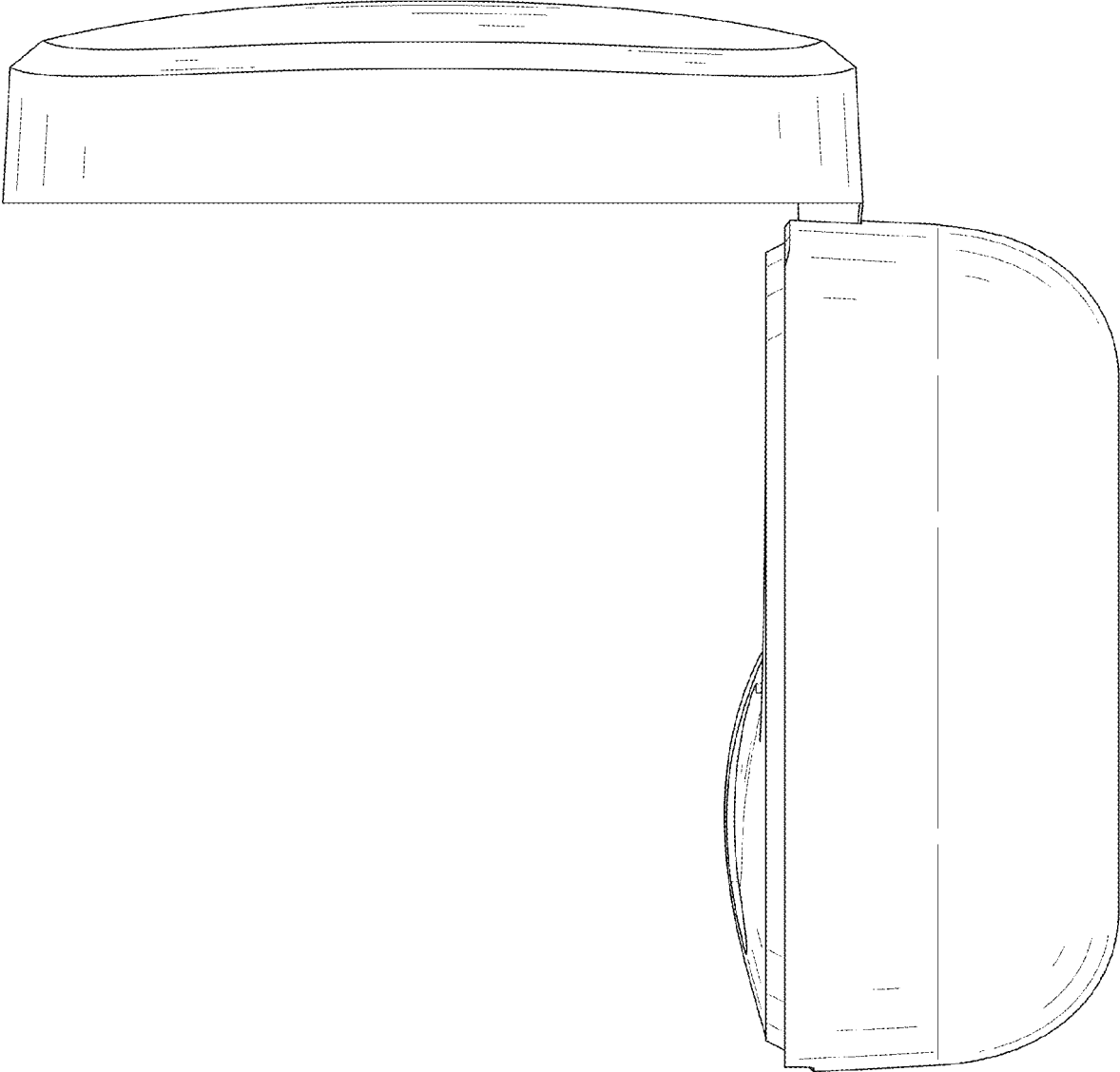

FIG. 14



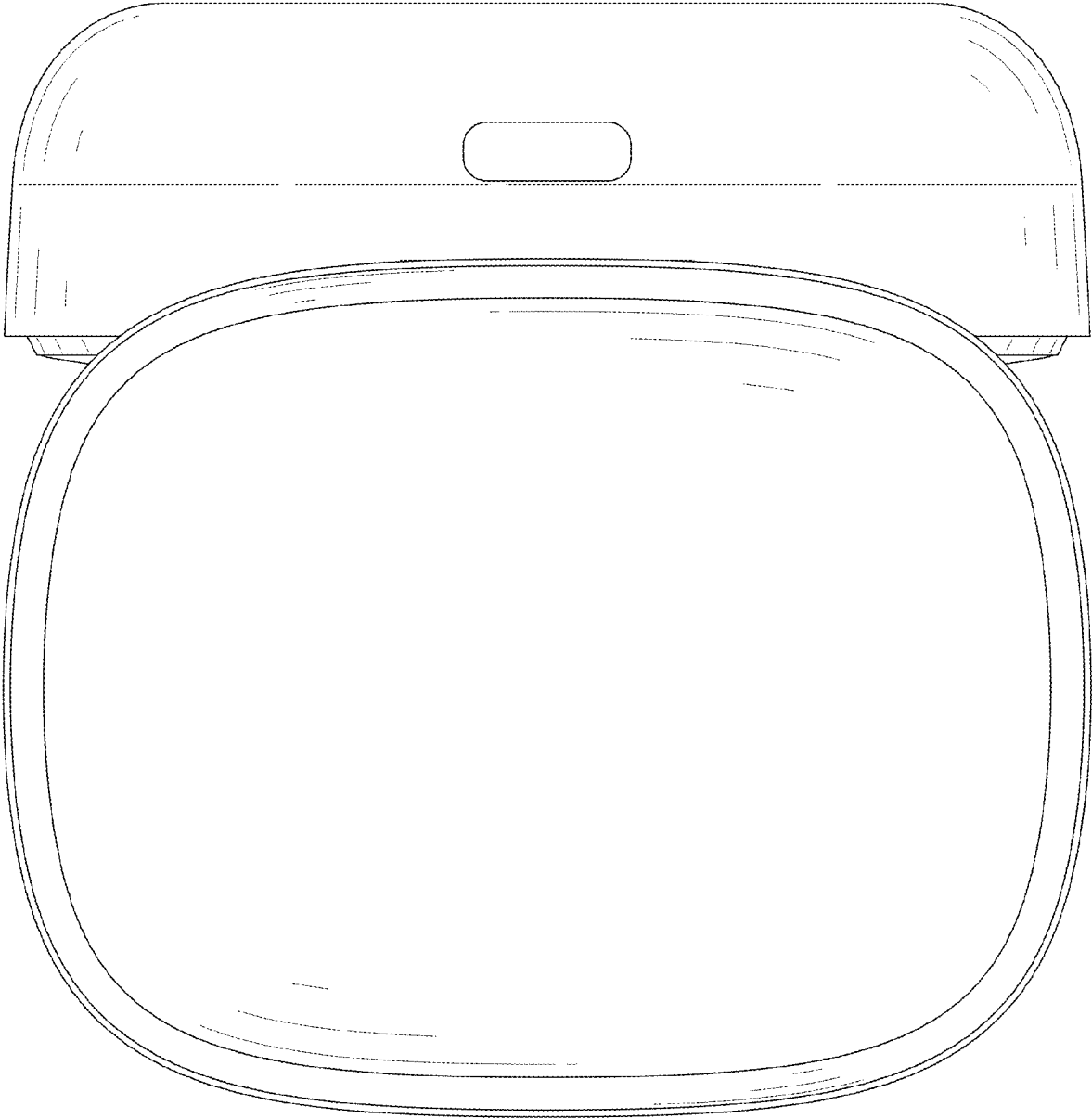

FIG. 15

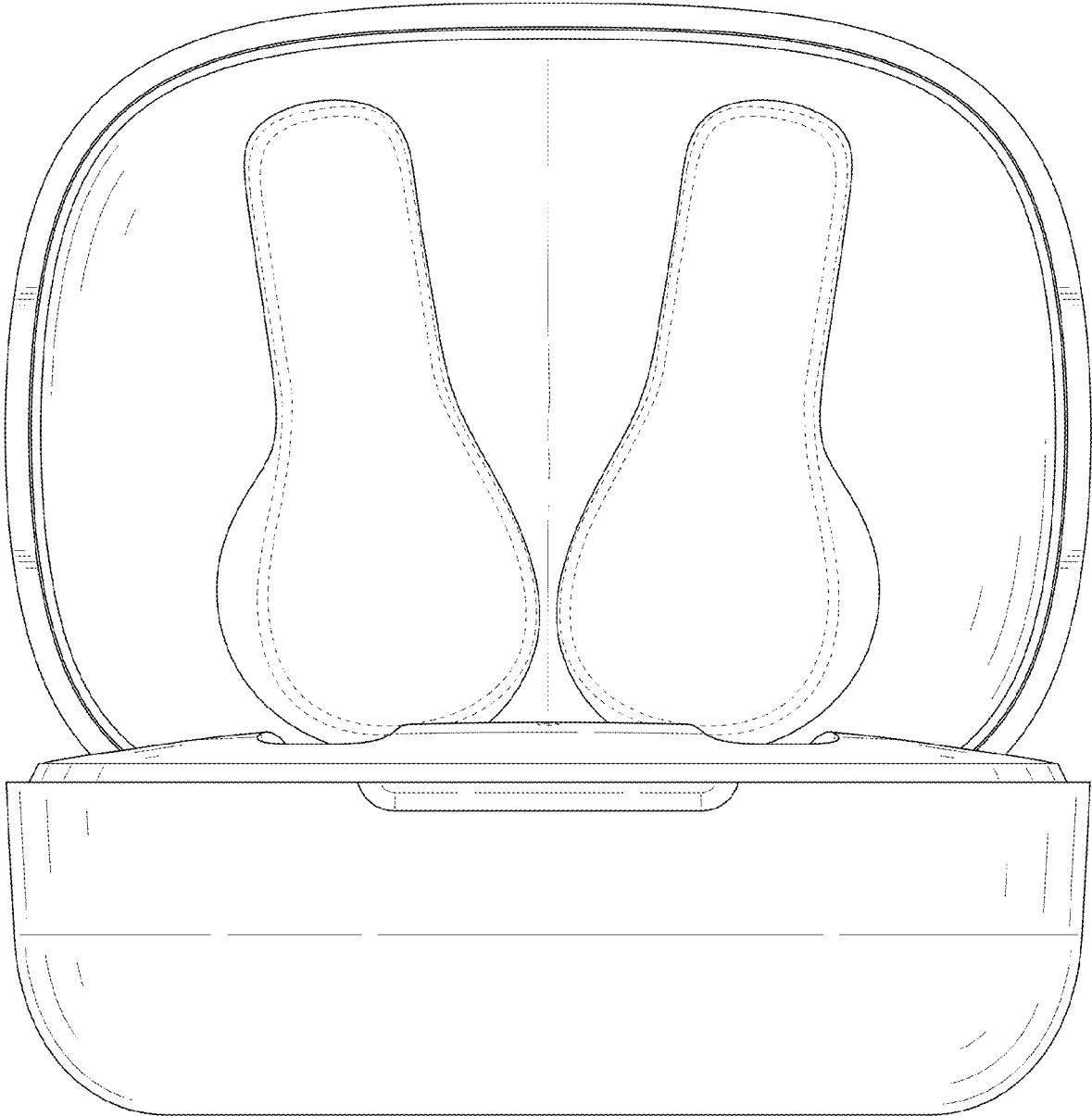

FIG. 16



FIG. 17

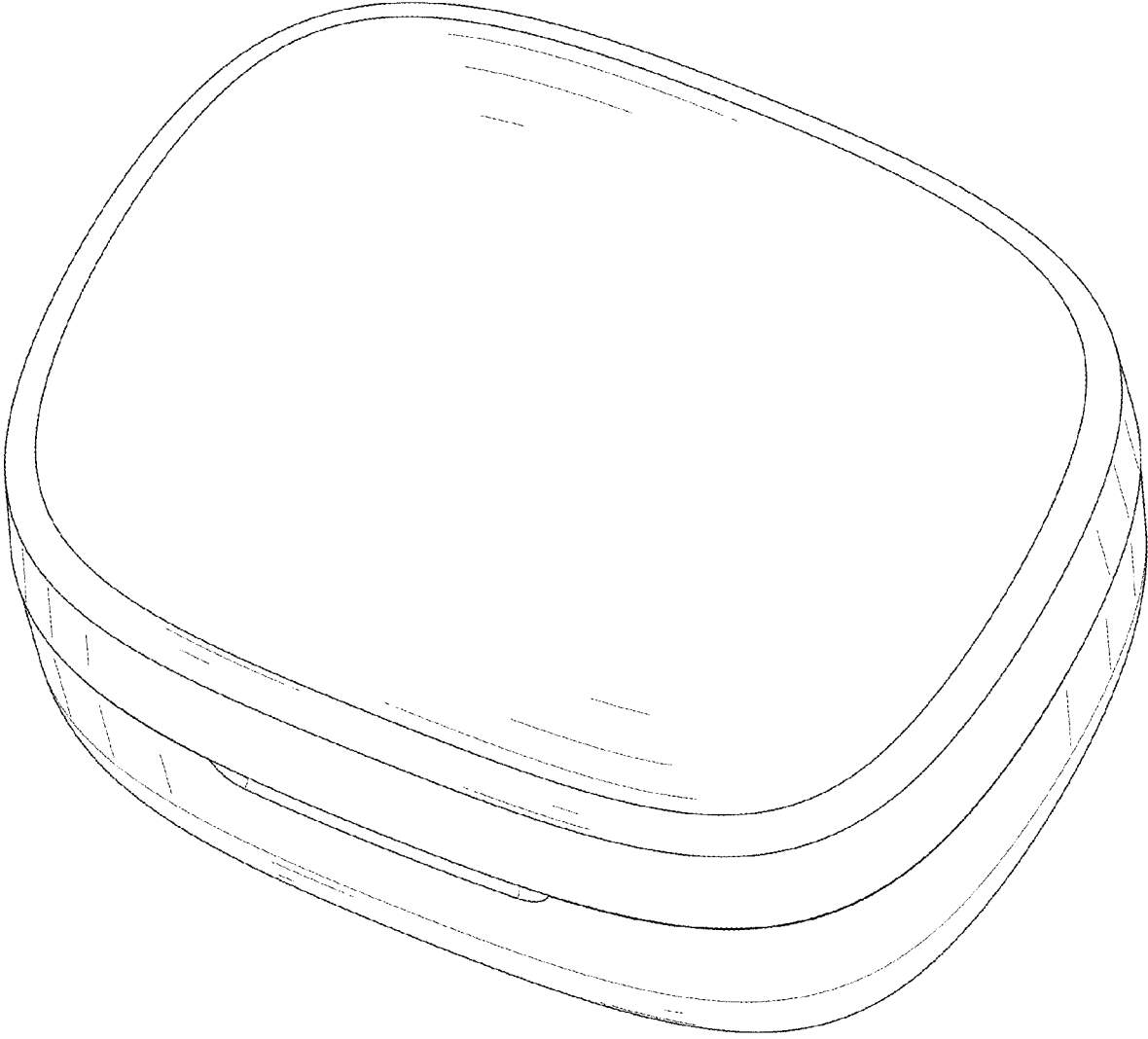

FIG. 18