

(19) World Intellectual Property Organization
International Bureau



(43) International Publication Date
20 November 2003 (20.11.2003)

PCT

(10) International Publication Number
WO 03/094798 A1

- (51) International Patent Classification: **A61F 2/06**
 - (21) International Application Number: PCT/US03/14167
 - (22) International Filing Date: 6 May 2003 (06.05.2003)
 - (25) Filing Language: English
 - (26) Publication Language: English
 - (30) Priority Data:
60/379,593 8 May 2002 (08.05.2002) US
60/378,346 8 May 2002 (08.05.2002) US
 - (71) Applicant (for all designated States except US): **ABBOTT LABORATORIES** [US/US]; D-377 AP6A-1, 100 Abbott Park Road, Abbott Park, IL 60064-6008 (US).
 - (72) Inventors; and
 - (75) Inventors/Applicants (for US only): **LOWE, David, L.** [US/US]; 820 Freemont Street, Apt #4, Menlo Park, CA 94025 (US). **ELI, Erik** [US/US]; 678 Bellflower Avenue, Apt. #22, Sunnyvale, CA 94086 (US). **PAPPAS, Jeff, M.** [US/US]; 2817 Ruth Ct, Santa Clara, CA 95051 (US). **HUANG, Howard, H.** [US/US]; 2803 Toyon Drive, Santa Clara, CA 95051 (US). **CLIFFORD, Anton, G.** [IE/US]; 492 Calderon Avenue, Mountain View, CA 94041 (US). **KANG, Kevin** [US/US]; 6058 Rainbow Drive, San Jose, CA 95129 (US).
 - (74) Agents: **WARK, Allen, A.** et al.; D-377 AP6A-1, 100 Abbott Park Road, Abbott Park, IL 60064-6008 (US).
 - (81) Designated States (national): AE, AG, AL, AM, AT, AU, AZ, BA, BB, BG, BR, BY, BZ, CA, CH, CN, CO, CR, CU, CZ, DE, DK, DM, DZ, EC, EE, ES, FI, GB, GD, GE, GH, GM, HR, HU, ID, IL, IN, IS, JP, KE, KG, KP, KR, KZ, LC, LK, LR, LS, LT, LU, LV, MA, MD, MG, MK, MN, MW, MX, MZ, NI, NO, NZ, OM, PH, PL, PT, RO, RU, SC, SD, SE, SG, SK, SL, TJ, TM, TN, TR, TT, TZ, UA, UG, US, UZ, VC, VN, YU, ZA, ZM, ZW.
 - (84) Designated States (regional): ARIPO patent (GH, GM, KE, LS, MW, MZ, SD, SL, SZ, TZ, UG, ZM, ZW), Eurasian patent (AM, AZ, BY, KG, KZ, MD, RU, TJ, TM), European patent (AT, BE, BG, CH, CY, CZ, DE, DK, EE, ES, FI, FR, GB, GR, HU, IE, IT, LU, MC, NL, PT, RO, SE, SI, SK, TR), OAPI patent (BF, BJ, CF, CG, CI, CM, GA, GN, GQ, GW, ML, MR, NE, SN, TD, TG).
- Published:**
 — with international search report
 — before the expiration of the time limit for amending the claims and to be republished in the event of receipt of amendments

[Continued on next page]

(54) Title: ENDOPROSTHESIS HAVING FOOT EXTENSIONS

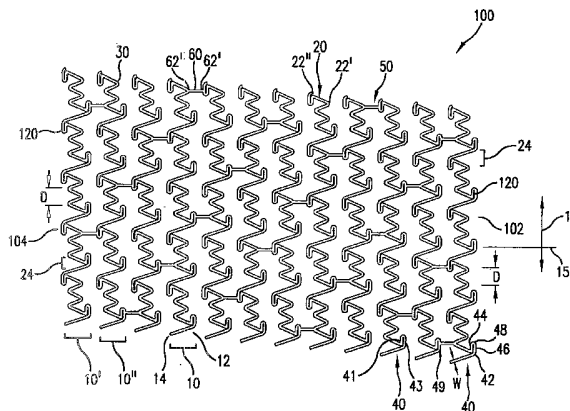

(57) **Abstract:** Endoprosthesis, such as a stent, includes at least one annular element defined by a first set of strut members interconnected to define apices proximate opposite sides of the annular element (20). The annular element (20) further includes a foot extension (40) extending between at least one pair of circumferentially-adjacent strut members (20). The foot extension has first (41) and second (43) foot portions extending circumferentially from corresponding ends of the circumferentially-adjacent strut members, and are contoured to provide at least two areas of flexure. The first and second foot portions are joined at a toe portion (48) of the foot extension, and define a circumferentially-directed apex between the pair of circumferentially-adjacent strut members. Preferably, at least one or more additional annular elements, each defined by interconnected strut members, are provided. The annular elements are generally expandable between a delivery configuration and a deployed configuration. The annular elements are longitudinally aligned and connected at connection locations. Preferably, each connection location includes a foot extension, such as by an overlapping pattern between the longitudinally-adjacent annular elements or by a connector extending therebetween.



WO 03/094798 A1



For two-letter codes and other abbreviations, refer to the "Guidance Notes on Codes and Abbreviations" appearing at the beginning of each regular issue of the PCT Gazette.

ENDOPROSTHESIS HAVING FOOT EXTENSIONS

RELATED APPLICATIONS

This application claims the benefit of US patent provisional application
5 Serial No. 60/378,346 filed May 8, 2002, and of US patent application Serial No.
60/379,593 filed May 8, 2002; each of which is expressly incorporated by reference
herein.

FIELD OF THE INVENTION

10 The present invention relates to an endoprosthesis for delivery and
deployment within a body vessel of a human or animal. More particularly, the invention
relates to a stent including at least one annular element having one or more foot
extensions for improved performance characteristics.

BACKGROUND OF THE INVENTION

15 Stents, grafts and a variety of other endoprostheses are well known and
used in interventional procedures, such as for treating aneurysms, for lining or repairing
vessel walls, for filtering or controlling fluid flow, and for expanding or scaffolding
occluded or collapsed vessels. Such endoprostheses can be delivered and used in
20 virtually any accessible body lumen of a human or animal, and can be deployed by any of
a variety of recognized means. One recognized indication of endoprostheses, such as
stents, is for the treatment of atherosclerotic stenosis in blood vessels. For example, after
a patient undergoes a percutaneous transluminal coronary angioplasty or similar
interventional procedure, an endoprosthesis, such as a stent, is often deployed at the
25 treatment site to improve the results of the medical procedure and to reduce the
likelihood of restenosis. The endoprosthesis is configured to scaffold or support the
treated blood vessel; if desired, the endoprosthesis can also be loaded with beneficial
agent so as to act as a delivery platform to reduce restenosis or the like.

The endoprosthesis is typically delivered by a catheter delivery system to
30 a desired location or deployment site inside a body lumen of a vessel or other tubular
organ. To facilitate such delivery, the endoprosthesis must be capable of having a
particularly small cross profile to access deployment sites within small diameter vessels.

Additionally, the intended deployment site may be difficult to access by a physician and often involves traversing the delivery system through the tortuous pathway of the anatomy. It therefore is desirable to provide the endoprosthesis with a sufficient degree of longitudinal flexibility during delivery to allow advancement through the anatomy to
5 the deployed site.

Once deployed, the endoprosthesis should be capable of satisfying a variety of performance characteristics. The endoprosthesis should have sufficient rigidity or outer bias when deployed to perform its intended function, such as opening a lumen or supporting a vessel wall. Similarly, the endoprosthesis should have suitable flexibility
10 along its length when deployed so as not to kink or straighten when deployed in a curved vessel. It also may be desirable to vary the rigidity or flexibility of the endoprosthesis along its length, depending upon the intended use. Additionally, it may be desirable for the endoprosthesis to provide substantially uniform or otherwise controlled coverage,
15 e.g., as determined by the ratio of the outer surface of the endoprosthesis to the total surface of the vessel wall along a given length. For example, increased coverage may be desired for increased scaffolding, whereas decreased coverage may be desired for side access to branch vessels. Control of the cross profile and length of the endoprosthesis upon deployment also is desirable, at least for certain indications.

Numerous designs and constructions of various endoprosthesis
20 embodiments have been developed to address one or more of the performance characteristics summarized above. For example, a variety of stent designs are disclosed in the following patents: U.S. Patent No. 4,580,568 to Gianturco; U.S. Patent No. 5,102,417 to Palmaz; U.S. Patent No. 5,104,404 to Wolff; U.S. Patent No. 5,133,732 to Wiktor; U.S. Patent No. 5,292,331 to Boneau; U.S. Patent No. 5,514,154 to Lau et al.;
25 U.S. Patent No. 5,569,295 to Lam; U.S. Patent No. 5,707,386 to Schnepf-Pesch et al.; U.S. Patent 5,733,303 to Israel et al.; U.S. Patent No. 5,755,771 to Penn et al.; U.S. Patent No. 5,776,161 to Globerman; U.S. Patent No. 5,895,406 to Gray et al.; U.S. Patent No. 6,033,434 to Borghi; U.S. Patent No. 6,099,561 to Alt; U.S. Patent No. 6,106,548 to Roubin et al.; U.S. Patent No. 6,113,627 to Jang; U.S. Patent No. 6,132,460 to
30 Thompson; and U.S. Patent No. 6,331,189 to Wolinsky; each of which is incorporated herein by reference.

Although the various designs for endoprostheses that have been developed to date may address one or more of the desired performance characteristics, there a remains need

for a more versatile design for an endoprosthesis that allows improvement of one or more performance characteristics without sacrificing the remaining characteristics.

SUMMARY OF THE INVENTION

5 The purpose and advantages of the present invention will be set forth in and are apparent from the description that follows, as well as will be learned by practice of the invention. Additional advantages of the invention will be realized and attained by the methods and devices particularly pointed out in the written description and claims hereof, as well as from the appended drawings.

10 To achieve these and other advantages in accordance with the purpose of the invention, as embodied herein and broadly described, the invention includes an endoprosthesis for delivery and deployment in a body lumen. The endoprosthesis includes at least one annular element defined by a first set of interconnected strut members, wherein each strut member has a first end and a second end. Preferably, the
15 first end of selected circumferentially-adjacent strut members are interconnected to define apices proximate a first longitudinal side of the first annular element and the second end of selected circumferentially-adjacent strut members are interconnected to define apices proximate a second longitudinal side of the first annular element. The annular element further includes a foot extension extending between a pair of
20 circumferentially-adjacent strut members. The foot extension has a first foot portion extending circumferentially from the first end of one of the circumferentially-adjacent strut members of the pair and a second foot portion extending circumferentially from the first end of the other of the circumferentially-adjacent strut members. The first and second foot portions are joined at a toe portion of the foot extension, and generally define
25 an apex between the pair of circumferentially-adjacent strut members.

 Preferably, the endoprosthesis of the invention further includes a second annular element defined by a second set of interconnected strut members, wherein each strut member of the second annular element also has a first end and a second end. Circumferentially-adjacent strut members are interconnected to define apices on opposite
30 sides of the second annular element. The first annular element and the second annular element are aligned longitudinally adjacent to each other along a longitudinal axis and connected to each other at at least one connection location. The second annular element also can include a foot extension. Additional annular elements also can be provided.

The annular elements are generally expandable between a delivery configuration and a deployed configuration. Each annular element can be defined as a continuous closed ring, or as a coiled sheet or the like. Preferably, each strut member is a straight member, aligned to be substantially parallel with the longitudinal axis of the endoprosthesis when in the delivery configuration. Selected strut members can have a uniform width or can have varied width, such as a continuous taper or increased midsection width between the opposite ends of the strut member. The apices on either side of each annular element that are not defined by a foot extension can have a V-shape, an arcuate shape, or another shape as desired.

10 The foot extension is contoured to provide at least two areas of flexure, and extends circumferentially at an angle relative to the longitudinal axis of the annular element. The foot extension can include straight portions, curved portions or combinations thereof to define an ankle portion, a toe portion, a base portion and a heel portion. The base portion can be a straight member, or contoured as a V-shape or the like. In a preferred embodiment, the foot extension has an average width greater than 15 that of the remaining strut members of the annular element. With the foot extension located between longitudinally-adjacent annular elements, the base portion of the foot extension generally faces the longitudinally-adjacent annular element.

 Preferably, the connection location between the longitudinally-adjacent 20 annular elements includes the foot extension. By providing the connection location at the base portion of the foot extension, the apices proximate a side of the first annular element generally can be arranged circumferentially out of alignment, or less than 180 degrees out of phase, with the apices proximate a facing side of the second annular element. The connection location can be defined by an overlapping pattern between the longitudinally- 25 adjacent annular elements, such as the base of a foot extension on one annular element and a corresponding apex on the other annular element. Alternatively, the connection location can include a connector extending between the annular elements. The connector can be a straight member or a shaped member, with opposites ends circumferentially either in or out of alignment, as desired. In a preferred embodiment, the connector has an 30 L-shape, with one leg longer than the other leg. In a preferred embodiment, a plurality of connection locations are provided between the adjacent annular elements, with a foot extension provided at some or all of the connection locations. The plurality of foot

extensions can all extend in the same circumferential direction, or can be arranged to extend in opposing circumferential directions.

A radiopaque material preferably is incorporated in at least a portion of the endoprosthesis. For example, at least one of the annular elements can comprise radiopaque material. Alternatively, radiopaque markers can be attached to at least one of the annular elements, or the annular elements can be formed of radiopaque material. As another example, at least one of the annular elements can be formed with a first layer of base material and a second layer of radiopaque material.

It is to be understood that both the foregoing general description and the following detailed description are exemplary and are intended to provide further explanation of the invention claimed.

The accompanying drawings, which are incorporated in and constitute part of this specification, are included to illustrate and provide further understanding of the device of the invention. Together with the description, the drawings serve to explain the principles of the invention.

BRIEF DESCRIPTION OF THE DRAWINGS

Fig. 1 shows a representative embodiment, in planar format, of an endoprosthesis in accordance with the invention.

Figs. 2a through 2e show detail views, in planar format, of various exemplary foot extensions in accordance with the present invention.

Figs. 3 through 10 show alternative representative embodiments of the present invention in planar format, each of an endoprosthesis having annular elements connected at a plurality of connection locations by connectors.

Figs. 11 through 13 show detail views of various connector alternatives.

Figs. 14a through 14e show detail views, in planar format, of various alternative connector relationships between adjacent annular elements.

Figs. 15 through 25 show alternative representative embodiments of the present invention in planar format, each of an endoprosthesis having annular elements connected at a plurality of connection locations without connectors.

Figs. 26 and 27a through 27d are detail views, in planar format, showing various embodiments of overlapping patterns of adjacent annular elements defining connection locations.

Fig. 28 shows a representative embodiment, in planar format, of an endoprosthesis configured to have varied characteristics along its length.

5 Figs. 29a through 29f respectively show a preferred embodiment of a self-expanding stent in accordance with the present invention, (a) in planar format, (b) in a front-half side view as cut and polished from a tube, (c) in a front-half side view of a delivery configuration, (d) in a front-half side view of a deployed configuration, (e) in a perspective view of a deployed configuration, and (f) in a side view as deployed in a curved vessel.

10 Figs. 30a through 30f respectively show a preferred embodiment of a balloon expandable stent in accordance with the present invention, (a) in planar format, (b) in a front-half side view as cut and polished from a tube, (c) in a front-half side view of a delivery configuration, (d) in a front-half side view of a deployed configuration, (e) in a perspective view of a deployed configuration, and (f) in a side view as deployed in a curved vessel.

15

DETAILED DESCRIPTION OF THE PREFERRED EMBODIMENTS

In accordance with the present invention, an endoprosthesis is provided for delivery within a body lumen of a human or animal. The endoprosthesis can include, but is not limited to, stents, grafts, valves, occlusive devices, trocars, aneurysm treatment
20 devices, or the like. The endoprosthesis of the present invention can be configured for a variety of intraluminal applications, including vascular, coronary, biliary, esophageal, urological, gastrointestinal or the like.

Generally, the endoprosthesis of the present invention includes a first set of interconnected strut members defining a first annular element, wherein each strut
25 member of the first annular element include a first end and a second end. The endoprosthesis also includes a foot extension extending between a pair of circumferentially-adjacent strut members. As described further below, the foot extension has a first foot portion extending circumferentially from the first end of one of the circumferentially-adjacent strut members and a second foot portion extending
30 circumferentially from the first end of the other of the circumferentially-adjacent strut members. The first and second foot portions are joined at a toe portion of the foot extension.

Preferably, and as embodied herein, the endoprosthesis further includes at least a second set of interconnected strut members defining a second annular element. The endoprosthesis can include additional annular elements defined by interconnected strut members as desired or needed. Each annular element generally defines a structure extending circumferentially about a longitudinal axis. The cross profile of each annular element preferably is at least arcuate, and more preferably either circular or spiral, although alternative cross profiles, such as rectilinear or the like, can be used if desired.

The first annular element is aligned longitudinally adjacent to the second annular element along the longitudinal axis, and connected to each other at at least one connection location. Preferably, the first and second annular elements generally define a tubular structure. For example, each annular element can define a continuous closed ring such that the longitudinally-aligned annular elements form a closed tubular structure having a central longitudinal axis. Alternatively, each annular element can define an open ring such that a rolled sheet or open tubular type structure is defined by the annular elements. Furthermore, each annular element can define a 360 degree turn of a helical pattern, such that the end of one annular element can be joined with the corresponding end of a longitudinally-adjacent annular element to define a continuous helical pattern along the length of the endoprosthesis.

Each strut member of the annular elements includes a first end and a second end. The strut members of each annular element are disposed circumferentially adjacent to each other, and interconnected so as to define an expandable structure. For example, and with reference to the closed tubular structure above, circumferentially-adjacent strut members of each annular element can be interconnected, either directly or indirectly, in an end-to-end format to define a continuous ring having a generally circular cross profile. By altering the angle or distance defined between circumferentially-adjacent strut members, the tubular structure can be radially expanded between a delivery configuration and a deployed configuration. As discussed in detail below, the expandable structure can be expanded by the application of an external force, such as by a balloon, or by a change in delivery conditions, such as an increase in temperature or the removal of a restraint, so as to allow the structure to self expand.

With reference to Fig. 1, for purpose of illustration and not limitation, a representative embodiment of an endoprosthesis 100 of the present invention in a deployed configuration is depicted in a planar format for clarity. As shown in Fig. 1, the

endoprosthesis includes a plurality of annular elements 10 aligned longitudinally adjacent to each other along a longitudinal axis 15. Although only one annular element need be provided in accordance with the invention, it is preferable that the endoprosthesis includes a plurality of annular element 10, depicted herein for purpose of illustration by
5 at least a first annular element 10' and a second annular element 10".

Each annular element includes a set of interconnected strut members 20, which are disposed circumferentially about longitudinal axis 15. Each strut member has a first end 22' and a second end 22", referenced generally as end 22. The first end 22' of selected circumferentially-adjacent strut members 20 are interconnected to define apices
10 30 proximate a first longitudinal side 12 of each annular element 10, and the second end 22" of selected circumferentially-adjacent strut members 20 are interconnected to define apices 30 proximate a second longitudinal side 14 of the annular element. In this manner, each annular element 10 can be expanded to a deployed configuration as shown in Fig. 1 by altering or "opening" the angle defined between circumferentially-adjacent
15 strut members 20. It also is recognized in the embodiment of Fig. 1 that circumferentially-adjacent apices 30 on each side 12, 14 of the annular element 10 are spaced apart by a circumferential distance D, such that each annular element is expanded by increasing the distance D between circumferentially-adjacent apices 30. At any given condition between the delivery configuration and the deployed configuration, the
20 distance D can be balanced or constant from one set of circumferentially-adjacent apices to the next, or can be varied if desired.

As shown in Fig. 1, certain apices 30 on each side of the annular element 10 can be defined by interconnecting corresponding ends 22 of circumferentially-adjacent strut members directly together to form a zig-zag pattern of alternating V-shapes
25 when deployed. Alternatively, an apex member can be provided between the corresponding ends of adjacent strut members to form a contoured apex, such as by using a straight apex member to form a flat apex as disclosed in US Patent No. 6,113,627 to Jang, or a curved apex member to form an arcuate apex as disclosed in US Patent No. 5,514,154 to Lau.

30 In the representative embodiment of Fig. 1, the strut members 20 of each annular element 10 are interconnected with adjacent strut members 20 to form a continuous closed ring, such as depicted more clearly in Figs. 29e and 30e. As previously noted, however, each annular element can define an open ring to form a rolled

sheet or open tubular type structure as described further with regard to Fig. 3, or can define adjacent turns of a continuous helical pattern as described with regard to Fig. 25, for purpose of illustration.

5 Fig. 1 also depicts each strut member 20 of the annular element 10 as a straight member. Preferably, when in the delivery configuration, the straight strut members 20 are generally aligned parallel with the longitudinal axis 15, as well as with each other, as shown for example in Figs. 29c and 30c. Although not shown, alternative strut member shapes can be used in addition to or in lieu of the straight strut members, such as L or V-shaped strut members or the like as is known in the art. Also, the number
10 of strut members included in each annular element will depend upon the size and desired characteristics of the endoprosthesis. For example, a greater number of strut members and interconnecting apices can be provided for increased coverage of the vessel wall by the endoprosthesis or increased cross profile of the endoprosthesis in the deployed configuration.

15 Similarly, the radial bias or rigidity of each annular element can be controlled or varied by altering the shape or size of the strut members. For example, radial bias or rigidity of an annular element, when deployed, generally can be increased by decreasing the length or by modifying the cross sectional profile of selected strut members of the annular element. It therefore is possible to provide an endoprosthesis in
20 accordance with the present invention having varied radial bias or rigidity along its length by providing one annular element with a radial bias or rigidity that is different from the radial bias or rigidity of another annular element as shown in Figs. 12b and 28 and described further below. In a similar manner, it is possible to provide an endoprosthesis having a tapered or flare shape formed of adjacent annular elements
25 having different cross profiles when in the deployed configuration but similar or uniform radial bias or rigidity along its length.

Further in accordance with the present invention, and as previously noted, at least one annular element includes a foot extension extending between at least one pair of circumferentially-adjacent strut members. The foot extension can thus define an apex
30 between the pair of circumferentially-adjacent strut members of the annular element. The foot extension includes a first foot portion extending circumferentially from an end of one of the adjacent strut members and a second foot portion extending circumferentially from a corresponding end of the other of the circumferentially-adjacent

strut members. In combination, the first and second foot portions generally define an ankle portion, a toe portion, a base portion and a heel portion of the foot extension, which in combination define a generally circumferentially-directed apex.

5 With reference to the exemplary embodiment of Fig. 1, for illustration and not limitation, foot extension 40 extends between a pair 24 of adjacent strut members 20 of each annular element 10. As depicted for purpose of illustration, the foot extension 40 includes a first portion 41 extending circumferentially from an end 22 of one of the adjacent strut members 20, and a second portion 43 extending circumferentially from the corresponding end 22 of the other of the adjacent strut members 20. The juncture of the
10 first and second foot portions 41, 43 defines a circumferentially-extending toe portion 48 of the foot extension 40. Similarly, and for purpose of discussion and not limitation, Fig. 1 shows that an ankle portion 44 is defined proximate the juncture of the first foot portion 41 with one of the circumferentially-adjacent strut members 20, and that a heel portion 42 is defined proximate the juncture of the second foot portion 43 with the other of the circumferentially-adjacent strut members 20. The toe portion 48 extends in a first
15 circumferential direction a distance greater than the heel portion 42 of the foot extension 40 extends in an opposite circumferential direction. In the embodiment of Fig. 1, the entirety of the foot extension 40 extends in the circumferential direction of the toe portion 48. Furthermore, at least one of the first and second foot portions 41, 43 defines a base
20 portion 46 at or proximate to the corresponding side 12 or 14 of the annular element 10. Defined generally within the boundary of the first and second portions 41, 43 is an open foot region 49 (see also, Fig. 2a).

A variety of configurations can be used for the foot extension in accordance with the present invention. For purpose of illustration and comparison with
25 the foot extension of Fig. 1, exemplary embodiments of various alternative foot extension configurations are depicted in Figs. 2a through 2e.

For example, the foot extension of the invention generally extends from the pair of circumferentially-adjacent strut members circumferentially at an angle relative to a line parallel to the longitudinal axis of the annular element. Fig. 1 shows a foot
30 extension generally extending circumferentially at an angle of about 90 degrees relative to the longitudinal axis 15. However, the foot extension can be configured to extend circumferentially at an angle of less than 90 degrees relative to the longitudinal axis, as shown for example in Fig. 2a.

Additionally, Fig. 1 shows a foot extension 40, wherein the first foot portion 41 and the second foot portion 43 are generally parallel, straight elongate portions joined by curved portions. Particularly, the base portion 46 is defined by a generally straight portion and each of the toe portion 48, the ankle portion 44 and the heel portion 42 is defined by a curved portion. Each portion of the foot extension 40, as well as each of the circumferentially-adjacent strut members 20, has a substantially uniform width W and thickness in the embodiment of Fig. 1. In this manner, the circumferentially-adjacent strut members 20 will be substantially parallel to the longitudinal axis 15 and to each other, and region 49 will be substantially closed when in the delivery configuration. As depicted in Fig. 1, the foot extension 40 will thus generally define at least two areas of flexure between the pair of circumferentially-adjacent strut members 20; that is, one at the heel portion 42 and one at the ankle portion 44. An additional, or alternative, area of flexure can be defined at the toe portion 48 if desired to facilitate further expansion between the pair of circumferentially-adjacent strut members 20, such as to define a three point hinge configuration.

Fig. 2a depicts a preferred embodiment of a foot extension similar to that of Fig. 1. As previously noted, however, the foot extension 40 of this embodiment extends circumferentially at an angle α less than 90 degrees relative to the longitudinal axis 15. Additionally, the first and second foot portions 41, 43 are generally parallel but spaced apart to define a relatively more open region 30 than that of the foot extension of Fig. 1. To control expansion of the annular element, the width of the foot extension and circumferentially-adjacent strut members can be varied accordingly. For example, and as previously noted, circumferentially-adjacent apices along each side of the annular element 10 are spaced apart by a circumferential distance D , wherein the distance D generally increases as the annular element is expanded. It is often desirable to balance an annular element so as to expand uniformly, wherein the distance D increases a similar amount and at a similar rate between each pair of circumferentially-adjacent apices. Due to the increased flexure facilitated by the foot extension similar of Fig. 1, the distance D_f between the circumferentially-adjacent apices located at the end of the pair 24 of circumferentially-adjacent strut members 20 opposite the foot extension 40 can increase to an extent or at a rate greater than the distance D_a between other circumferentially-adjacent apices of the annular element. By providing the first and second foot portions

41, 43 of the foot extension with an average width greater than the average width of the circumferentially-adjacent strut members 20, as shown in Fig. 2a, the expansion between the circumferentially-adjacent apices 30 can be controlled or even balanced if desired. For example, and as shown in Fig. 2a, the first and second foot portions 41, 43 can be provided with a substantially constant width. Alternatively the first foot portion 41 can be provided with a width W1 different than that W2 of the second foot portion 43.

As previously noted with regard to the exemplary embodiment of Fig. 1, the circumferentially-adjacent strut members 20 and the different portions of the foot extension 40 can be provided with a substantially uniform width and thickness throughout. If the foot extension is provided with an increased width, it may be desirable or necessary to distribute stress or eliminate stress concentrations in the pair of circumferentially-adjacent strut members 20. As embodied in Fig. 2a, at least one or both strut member 20 of the pair 24 of circumferentially-adjacent strut members can be provided with a varied width. For example, and as shown in Fig. 2a, each strut member of the pair 24 of circumferentially-adjacent strut members can be tapered from a first width W' substantially similar to or even greater than that of the foot extension at the first end 22' of the strut member to a second width W'' substantially similar to or even greater than that of the adjacent strut member 20 connected at the second end 22''.

To further control expansion of the annular element, selected apices along the same longitudinal side 12, 14 of the annular element 10 as the foot extension also can be modified. For example, an apex 30 can be relaxed by reducing its width to facilitate greater expansion, or stiffened by increasing its width to facilitate less expansion. As shown in Fig. 2a, the width of selected apices 30_{rw} are reduced to relax the apex 30 and thus control, such as balance, expansion of the annular element as needed or desired.

Furthermore, selected apices on the same side of the annular element as the foot extension can be configured to accommodate additional features. For example, and in accordance with another aspect of the present invention, it is desirable to enhance retention of a balloon expandable endoprosthesis on a balloon delivery system. As shown in Fig. 2a, the foot extension 40 extends in a first circumferential direction, and a circumferentially-adjacent apex 30_a is located proximate the foot extension 40 in the first circumferential direction. When in the delivery configuration, this circumferentially-adjacent apex 30_a is longitudinally aligned with, and preferably can substantially contact, the toe portion 48 of the foot extension so as to define a gap G between the

circumferentially-adjacent strut members 20. Balloon material of the delivery system thus can be captured within this gap G, during crimping or through known heat treatment techniques, to enhance stent retention on a balloon. Additionally, or alternatively, a gap can be defined within an enlarged region 49 of the foot extension 40 for similar stent retention purposes if desired.

Fig. 2b depicts yet another foot extension configuration in accordance with the invention. The first foot portion 41 of the foot extension 40 is generally angled relative to the second foot portion 43, rather than aligned in parallel as shown in Fig. 1. Additionally, the second foot portion 43 is generally V-shaped to define a base portion 46 extending substantially perpendicular to the longitudinal axis, but with a more angular heel portion 42 than that of Fig. 1. In this manner, the first and second foot portions define an enlarged open region 49 relative to that of Fig. 1. As with Fig. 2a, the embodiment of Fig. 2b includes a foot extension 40 having an increased average width and tapered circumferentially-adjacent strut members, as well as a longitudinally-aligned apex 30a circumferentially adjacent to the toe portion 48 of the foot extension 40 for enhanced retention on a balloon delivery system.

Fig. 2c depicts an alternative preferred embodiment of the foot extension of the present invention. The foot extension 40 of this embodiment is provided with a generally rectilinear configuration, including a first foot portion 41 extending from the ankle portion 44 to the toe portion 48 of the foot extension, and a second foot portion 43 extending from the heel portion 42 to the toe portion 48. Particularly, the second foot portion defines a contoured base portion 46, such as a generally V-shape including a first portion 46' and a second portion 46". In this manner, the foot extension can be configured to provide an additional area of flexure for expansion of the annular element if desired, as well as to define a connection location for longitudinally-adjacent annular elements as described further below.

As with the embodiments of Figs. 2a and 2b, the first and second foot portions 41, 43 of Fig. 2c are provided with an increased width to stiffen the apex defined by the foot extension 40, and thus control, and more preferably, balance expansion of the annular element 10. For example, in one preferred embodiment, the width W1 of the first foot portion 41 and the width W2' of the first portion 46' of the V-shaped base portion are equal to each other, but different than the width W2" of the second portion 46" of the V-shaped base portion. Unlike the embodiment of Figs. 2a and 2b, which are particularly

advantageous in combination with a balloon delivery system, the embodiment of Fig. 2c does not include a longitudinally-aligned apex circumferentially adjacent the toe portion of the foot extension. Rather, and as recognized from Fig. 2c, at least the apex 30a located circumferentially proximate the toe portion 48 of the foot extension 40 is positioned longitudinally so as to mate with the foot extension when in the delivery configuration. For example, and as shown in Fig. 2c, this can be accomplished by providing at least one of the strut members 20 of the pair 24 of circumferentially-adjacent strut members with a length greater than the length of the remaining strut members of the annular element. The mating configuration between the foot extension 40 and the circumferentially adjacent apex 30a facilitates a reduced cross profile of the annular element 10 when in the delivery configuration. This embodiment is particularly advantageous for an endoprosthesis to be delivered within extremely small vessels, such as certain coronary or neurovascular vessels, or for an endoprosthesis that can be contained within a sheath during delivery, such as a self-expanding stent.

Fig. 2d is an enlarged detail view of a more rounded version of a foot extension similar to that of Fig. 2c, which is depicted with dashed lines for purpose of comparison. Particularly, Fig. 2d demonstrates the use of more rounded contours to shift or eliminate stress concentrations that may occur during expansion.

Fig. 2e depicts another alternative embodiment of a foot extension the present invention, which incorporates the mating configuration of the foot extension and the circumferentially adjacent apex as described with regard to Fig. 2c. Unlike the embodiment of Fig. 2c, however, the strut members 20 connected to the circumferentially adjacent apex 30a are provided with a length less than that of the remaining strut members so as to accommodate the desired mating relationship between the apex 30a and the foot extension 40. Furthermore, Fig. 2e shows that at least the circumferentially adjacent apex 30a is relaxed, such as by providing a reduced width, to open at a greater angle and thus compensate for the decrease of the distance D that would otherwise result during expansion due to the reduced length of the corresponding strut members 20. As previously described, expansion of the annular element 10 thus can be controlled, and more preferably, balanced. The strut members 20 having a reduced length and the circumferentially-adjacent apex 30a also can be provided with a reduced width if desired as shown in Fig. 2e.

Additional variations of the foot extension are also contemplated. For example, the heel portion of the foot extension can extend in a circumferential direction opposite from the toe, but preferably by a distance less than the distance over which the toe extends in the first direction.

5 Any suitable number of foot extensions can be provided on an annular element in accordance with the present invention. A single foot extension can be provided on an annular element if desired. As shown in the embodiment of Fig. 1, however, it is preferable to define a plurality of apices of an annular element with foot extensions 40, wherein each foot extension extends between a pair 24 of
10 circumferentially-adjacent strut members. The foot extensions can be provided on both longitudinal sides 12, 14 of the annular element 10 as shown in Fig. 1, or only on a single side of an annular element as shown in Fig. 8. Additionally, and as further shown in Fig. 8, it is possible to combine an annular element having one or more foot extensions with another annular element having no foot extension if desired. The plurality of foot
15 extensions, if provided, can all extend in the same circumferential direction, or in opposite circumferential directions if desired. For example, and as shown in Fig. 1, the foot extensions on one longitudinal side of each annular element can extend in one direction circumferentially 17, whereas the foot extensions on the other side of the annular element extend in the opposite circumferential direction. In other embodiments,
20 such as Fig. 6, all foot extensions 40 can extend in the same circumferential direction, either clockwise or counterclockwise when viewed from one end of the endoprosthesis, regardless of the longitudinal side 12, 14 of the annular elements 10 on which the foot extensions 40 are disposed.

When a plurality of foot extensions are provided on an annular element,
25 the foot extensions can be evenly spaced along the corresponding side of the annular element as shown in Fig. 1, or can be spaced in a staggered fashion as shown in Fig. 4. The number of apices that are not defined by a foot extension along the corresponding side of the annular element, and thus disposed between foot extensions, will depend upon the total number of apices desired for the annular element and the total number of such
30 apices to be defined by a foot extension.

Further in accordance with the present invention, and as previously noted when a plurality of annular elements is provided, the first annular element and the second annular element are connected to each other at a connection location. A single

connection location can be provided between two adjacent annular elements, or a plurality of connection locations can be provided as preferred. Furthermore, and as described below, the connection location can include one or more connectors extending between adjacent annular elements, or the connection location can be defined by an overlapping geometric pattern of two adjacent annular elements.

5 Preferably, the connection location includes a foot extension. As previously noted, each foot extension defines at least two areas of flexure. Such areas of flexure generally are located in the ankle, toe or heel portions of the foot extension. As such, the foot extension can facilitate greater longitudinal flexibility when included at the connection location between two adjacent annular elements. The multiple areas of flexure of the foot extension can also compensate for foreshortening when disposed at the connection location. As the annular element is expanded, the foot extension can be configured to open in a manner to adjust or compensate for some or all of the change that occurs in the longitudinal dimension of the annular element. That is, the foot extension can be configured to have a first longitudinal dimension when in the delivery configuration, and to straighten or retract, as deemed necessary, so as to have a second longitudinal dimension when in the deployed configuration. The difference between the first longitudinal dimension and the second longitudinal dimension of the foot extension preferably is substantially equivalent to the corresponding change in the longitudinal dimension of the annular element. Similarly, the foot extension can be stiffened by increasing the width of one or both of the first and second foot portions, or by otherwise altering the geometry of the foot extension in a suitable manner, to reduce the amount in which the foot extension opens, and thus reduce the extent of related foreshortening that occurs at the connection location.

15 20 25 30 Additionally, when located on a corresponding side between longitudinally-adjacent annular elements, the foot extension of one annular element includes a base portion generally facing the other annular element. The base portion provides an elongated region in which a connection location can be disposed, thus increasing versatility for design alternatives. For example, one alternative for increasing coverage provided by a stent is to configure corresponding zig-zag or sinusoidal patterns of longitudinally-adjacent annular elements less than 180 degrees out of phase with each other. That is, with the first side of a first annular element longitudinally adjacent the second side of a second annular element, it can be desirable for the apices proximate the

first side of the first annular element to be circumferentially out of alignment with the apices proximate the second side of the second annular element. The foot extensions of the present invention allow such circumferential offset between longitudinally adjacent apices, even without the use of a connector. The foot extension of the present invention therefore enables greater axial flexibility, foreshortening compensation, radial expansion and coverage of the endoprosthesis.

With reference again to Fig. 1, a plurality of connectors 60 are provided to connect adjacent annular elements 10 at a plurality of connection locations 50. Each connection location 50 of Fig. 1 includes a foot extension 40 of one annular element and an apex 30 of another annular element, with a connector 60 having opposite ends 62 connected therebetween. If desired, however, the connection location 50 can extend from a foot extension to a foot extension, or from an apex to an apex, or to a strut member of one or both annular elements if desired. As embodied in Fig. 1, each foot extension 40 generally has a circumferentially elongated base portion 46 facing an adjacent annular element 20. With a connector 60 extending longitudinally from the base portion 46 of a foot extension 40 to an apex 30, the longitudinally-adjacent apices 30 of adjacent annular elements are circumferentially out of alignment. The foot base portions 46 at the longitudinal ends 102, 104 of the endoprosthesis 100 face outward from the remainder of the structure. Preferably, one or more foot extensions at either end 102, 104 of the endoprosthesis includes an area that undergoes minimal deformation or strain, such as the base portion 46, when expanded to the deployed configuration. A wire or strip of radiopaque material can be wrapped around or otherwise secured to this area of minimal strain so as to act as a radiopaque marker 120 for imaging purposes. Alternatively, a marker tab or eyelet can be attached at one or both ends of the endoprosthesis as described in detail with reference to Fig. 25, below.

For simplicity and clarity, each connector depicted in Fig. 1 is a straight member. It is recognized, however, that the connector can be contoured or shaped to increase longitudinal flexibility if desired, as shown in Figs. 11-13 and described further below. Similarly, the connectors need not extend parallel to the longitudinal axis, but can be aligned diagonally or helically such that the ends of the connector are circumferentially offset as shown for purpose of example in Figs. 14b and 14d-14e.

A variety of design alternatives for different endoprosthesis embodiments can be achieved by selectively combining the various aspects of the present invention.

For purpose of illustration and not limitation, a number of exemplary embodiments including the combination of connectors with foot extensions of the present invention are depicted in planar format in Figs. 3-10. As with the embodiment of Fig. 1, the connectors are depicted as straight members for clarity and simplicity, but any connector configuration can be used as desired.

The embodiment of Fig. 3, shown in a deployed configuration, is similar to that of Fig. 1, but includes a connector extending from each foot extension 40 of one annular element 10 to a longitudinally adjacent apex 30 of another annular element. As previously noted, the endoprosthesis of the invention can be formed as a rolled sheet or similar coiled structure if desired. As depicted in Fig. 3, complimentary lateral edges 106, 108 can be defined by providing connection locations 50 continuously in longitudinal alignment along the length of the endoprosthesis 100. Particularly, the connectors 60 and corresponding foot extensions 40 of the connection locations along the lateral edges 106, 108 define interlocking projections 109. The endoprosthesis 100 of this embodiment can be delivered in a contracted, coiled state to a deployment site with the lateral edges 106, 108 overlapping each other. Upon deployment, the endoprosthesis 100 will unravel from its coiled state, as well as expand circumferentially from its contracted state due to expansion of the annular elements. Once deployed, the interlocking projections 109 along the lateral edges will engage the "cells" 105 defined in the overlapping layer upon the application of a compressive force to prevent collapse of the endoprosthesis. A "cell" 105 is the opening formed between two circumferentially adjacent connection locations as defined by the closed boundary created by the interconnected struts, and the foot extensions and connectors as provided. Alternative arrangements can be used to define interlocking projections or, if the annular elements are provided with sufficient radial bias or rigidity, no interlocking projections need be provided.

The embodiment of Fig. 4, shown in a slightly deployed configuration, has free foot extensions 40a, which are longitudinally free from or unconnected to adjacent annular members, and connected foot extensions 40b, which are connected to adjacent annular members 10 with connectors 60. The free foot extensions 40a are aligned in the circumferential direction at an angle of about 90 degrees to the longitudinal axis and have substantially slit-shaped foot regions 49a. The connected foot extensions 40b have enlarged foot regions 49b, for greater radial expansion of the pair 24 of connected strut

members, and extend circumferentially at an angle of less than 90 degrees from the longitudinal axis 15. The connection locations 50 are disposed at selected apices 30 and partway along the foot base portion 46. The foot base portions 46 of the connected foot extensions 40b have two portions 46', 46'' oriented at an angle to each other to affect an area of flexure upon expansion.

One longitudinal side 12 or 14 of each annular element 10 has pairs of immediately adjacent connection locations 50. The other longitudinal side of each annular element 10 has connection locations 50 that are spaced from each other by a plurality of apices 30. Additionally, the foot extensions 40a, 40b are unevenly spaced along each annular element 10. Some strut numbers 20 have foot extensions at either end 22 thereof, other strut members 20 include a foot extension 40a, 40b only at one end, and yet others do not have a foot extension at either end.

As with the embodiment of Fig. 4, the embodiment of Fig. 5 has connected foot extensions 40b with foot regions 49 that are significantly larger than the foot regions 49 of the free foot extensions 40a. In this embodiment as shown in a slightly deployed configuration selected apices 30 that are not defined by a foot extension protrude longitudinally more than other such apices for increased coverage. Additionally, the adjacent annular elements are substantially "in phase", such that longitudinally-adjacent apices of adjacent annular elements are circumferentially offset from each other. The circumferential extent of the connected foot extensions 40b allows the annular members to be connected in phase. Thus, the portion 48 of the connected foot members 40b preferably extends circumferentially at least or greater than the circumferential station of the connection location of the adjacent annular element 10.

The embodiment of Fig. 6 includes opposing and connected foot extensions 40 with substantially open foot regions 49. In the delivery configuration shown in Fig. 6, each apex 30a that is circumferentially-adjacent a foot extension 40 is positioned to mate with the foot extension in a manner similar to that of Fig. 2c. Also, when in the delivery configuration, the strut members 20 are substantially aligned with the longitudinal axis 15 as shown. The embodiment of Fig. 7 is similar to that of Fig. 6, except foot extensions 40 on each annular element 10 circumferentially spaced so as not to include two foot extensions on a single strut member 20.

In the embodiment of Fig. 8, which is shown substantially in the delivery configuration, the foot extensions 40 are disposed only on one longitudinal side of each

annular element 10. Preferably, all the foot extensions extend in the same longitudinal and circumferential directions. It is noted that connection locations 50 are evenly spaced circumferentially, with two unconnected apices 30 between circumferentially adjacent connection locations. Each connection location 50 includes a foot extension 40 on one annular element 10 and an apex 30 on the adjacent annular element 10. Furthermore, the connection locations 50 between adjacent annular elements 10 are circumferentially offset from one set of connected annular elements to the next.

Figs. 9 and 10 depict alternative embodiment in the delivery configuration, wherein connection locations 50 include connectors 60 extending between apices 30 not defined by foot extensions. All of the foot extensions 40 are free or unconnected. In Fig. 9, all foot extensions 40 extend in the same circumferential direction; in Fig. 10, the foot extensions 40 alternate between clockwise and counterclockwise directions.

As previously noted, Figs. 1 and 3-10 depict various endoprosthesis embodiments that include a straight connector between adjacent annular elements for purpose of simplicity and clarity. It is understood, however, that alternative connector shapes can be used within the scope of the invention. For example, Fig. 11 shows an endoprosthesis in the delivery configuration, which includes a plurality of annular elements connected by substantially sinusoidal connectors 60. Each annular element 10 includes a plurality of interconnected strut members 20, wherein every other apex disposed along a longitudinal side 12 and 14 is defined by a foot extension 40. Each sinusoidal connector 60 extends between a foot extension 40 on one annular element and an apex 30 on an adjacent annular element. The sinusoidal connector includes curved portions 64 between the first and second ends 62', 62" of the connector 60. In this manner, the longitudinally-adjacent apices of adjacent annular elements can be arranged in circumferential alignment with each other (that is, 180 degrees out of phase) or out of alignment with each other, as preferred. Fig. 12a is directed to an endoprosthesis embodiment similar to that of Fig. 11, however, U-shaped connectors, each including a curved portion 64, are provided in lieu of the sinusoidal connectors. In a further embodiment of the invention, as shown in a slightly deployed configuration in Fig. 12b, an endoprosthesis is provided with a connector 60 between foot extensions 40 on longitudinally adjacent apices 30 of adjacent annular elements 10, in a manner similar to the embodiment of Fig. 6. At least one unconnected apex 30 is disposed between

circumferentially adjacent foot extensions 40 on each side of the annular element 10. In this embodiment, however, each connector 60 has a U- or V-shape with at least one curved portion 64. If desired, the curved portions 64 can all extend in the same circumferential direction, as shown in Fig. 12a, or can alternate in circumferential direction from one set of adjacent annular elements to the next as shown in Fig. 12b. Furthermore, and as depicted in Fig. 12b, the number of connectors, and thus connection locations, between adjacent annular elements can be varied for varied longitudinal flexibility along the length of the endoprosthesis. In another preferred embodiment of the invention an endoprosthesis is provided with the sinusoidal shaped connectors between adjacent annular elements located proximate at least one region of the endoprosthesis as shown in Fig. 11, and with the U-shaped connectors between adjacent annular elements located proximate another region of the endoprosthesis, as shown in Fig. 12a.

In accordance with an additional aspect of the invention, and as shown in Fig. 13, an alternative connector 60 is provided having an L-shaped portion 66 between its first and second ends 62. The L-shaped portion has a first leg 66' and a second leg 66". A bend or circumferential peak 67 is provided between the first and second legs. Preferably, and as shown in Fig. 13, the length of the first leg 66' is different than that of the second leg 66". The width of the first leg 66' likewise can be different than that of the second leg 66", as shown in Fig. 13. It is preferred that the L-shaped connector be connected between adjacent annular elements 10, such that the first end 62' of the connector 60 is circumferentially offset from the second end 62" of the connector 60. Fig. 13 depicts the L-shaped connectors incorporated in an endoprosthesis embodiment similar to that of Figs. 11 and 12, as shown in the delivery configuration, wherein all of the L-shaped connectors are arranged so as to extend circumferentially in the same direction, as defined by the direction in which the bend 67 of the L-shaped portion 66 extends.

The L-shaped connector of this aspect of the invention can be configured to compensate for foreshortening of the endoprosthesis upon deployment, without altering the angle between the first and second legs. That is, the L-shaped connector can be arranged so as to have a first longitudinal dimension when in the delivery configuration, and to rotate relative to the annular elements, as deemed necessary, so as to have a second longitudinal dimension when in the deployed configuration. The difference between the first longitudinal dimension and the second longitudinal

dimension of the L-shaped connector preferably is substantially equivalent to the corresponding change in the longitudinal dimension of the annular element to be compensated upon deployment. Rotation of the L-shaped connector can be accomplished or enhanced by weakening the points of connection at either end of the connector with the corresponding annular elements. Furthermore, the degree of compensation, as well as longitudinal flexibility, can be varied by varying the length of the connectors as shown in Fig. 13.

Figs. 14a through 14e show alternative arrangements of the L-shaped connector of the present invention as disclosed in US patent application 60/379,593, which is incorporated in its entirety herein by reference. Particularly, and as shown in Figs. 14a through 14e, a plurality of L-shaped connectors can be provided between adjacent annular elements 10 such that selected connectors 60 are arranged to extend circumferentially in opposite directions, as defined by the direction in which the bend 67 of the L-shaped portion is directed. In this manner, the strut members 20 of the annular elements 10 and the connectors form a generally repeating pattern defined by two different, alternating cell shapes. In each embodiment, however, it is recognized that the number of connectors and apices, as well as the dimensions of the components and the angle of alignment between the legs of the L-shaped portion and between the ends of the connector, can be varied to achieve desired characteristics of the stent such as scaffolding, coverage, and flexibility. Although not shown, one or more of the apices of each of these embodiments can be defined by a foot extension in accordance with the invention.

For example, Fig. 14a shows circumferentially adjacent L-shaped connectors extending in opposite circumferential directions, wherein each connector 60 is connected between longitudinally adjacent apices 30 of adjacent annular elements 10. Figs. 14b and 14d show alternative embodiments of an endoprosthesis having L-shaped connectors, wherein the circumferentially-adjacent connectors 60 extend from circumferentially adjacent apices 30 on one annular element 10 to non-adjacent apices 30 on the other annular element 10. In Fig. 14c, the L-shaped connectors extend from respective apices 30 of annular elements 10 to an intermediate location on respective strut members 20 of the annular elements 10. In Fig. 14e, two connectors extend from the same apex 30 of one annular element 10 to different apices 30 on the other annular element 10. Alternatively, connectors can extend from strut member to strut member

without being connected to peaks of the annular members, or two or more connectors can extend from the same apex of both annular elements, respectively. Although each of these embodiments depict the selected connectors extending in opposite circumferential directions, it is recognized that the connectors can all be arranged in the same direction as previously shown in Fig. 13.

Furthermore, the connector peaks 67 can be aligned longitudinally with each other in the circumferential direction, i.e., located on the same transverse plane of the endoprosthesis, but need not be so aligned. In the embodiments having connector peaks that are not aligned, it is contemplated that the endoprosthesis may be more completely or uniformly crimped if the connector peaks 67 extend circumferentially in opposite directions as shown in Fig. 14a, because the peaks of adjacent connectors will not interfere with each other. Furthermore, the connection locations 50 and the connectors 60, if present, on longitudinally-adjacent annular elements 10 are preferably circumferentially displaced with respect to each other to improve flexibility of the stent. However, all of the connection locations can be aligned, if desired.

In addition to changing connector shapes, other aspects of the connectors can be altered to facilitate desired performance characteristics for the endoprosthesis. For example, the length and cross-sectional dimensions (e.g., width, thickness) of the connectors can be varied as shown in Fig. 13, or the number of connectors between adjacent annular elements can be increased or decreased to alter longitudinal flexibility and coverage accordingly. Hence, longitudinal flexibility can be uniform or varied across the length of the endoprosthesis, as desired.

Further in accordance with an additional aspect of the invention, and as previously noted, the connection location between longitudinally-adjacent annular elements need not include a separate connector. Indeed, the connection location can be defined by an overlapping geometric pattern of two adjacent annular elements. As defined herein, "overlapping geometric pattern" and "overlapping pattern" reference the resulting pattern or configuration from two or patterns arranged to share a common surface or area; it does not suggest or require that this overlapping pattern result in an increase in thickness or material of construction. Preferably, the connection location includes a foot extension.

For purpose of illustration and not limitation, reference is made to Fig. 15, which shows an endoprosthesis substantially similar to that of Fig. 1, but without

separate connectors. Fig. 15 shows an endoprosthesis in a deployed configuration including a plurality of annular elements 10, each having first and second longitudinal sides 14, 16 with selected apices defined by foot extensions 40 extending in opposite circumferential directions. Connection locations 50 between the longitudinally-adjacent annular elements 10 are provided by direct connections between opposing foot extensions 40. As shown in this embodiment, each connection location 50 is generally disposed along the base portion 46 of each foot extension 40 proximate the toe portion 48, and aligned diagonally or helically along the length of the endoprosthesis. Each foot extension 40 of this embodiment can be construed to define a three point hinge configuration defined generally at the at the toe, heel, and ankle portions 48, 42, 44. Furthermore, and as noted with regard to Fig. 1, one or more foot extensions at either end 102, 104 of the endoprosthesis includes an area that undergoes minimal deformation or strain, such as the base portion 46, when expanded to the deployed configuration. A wire or strip of radiopaque material can be wrapped around or otherwise secured to this area of minimal strain so as to act as a radiopaque marker 120 for imaging purposes during delivery and deployment.

In this embodiment, the strut members 20 that are circumferentially adjacent the foot extensions 40 and within the circumferential extension of the foot extensions 40 when in the delivery configuration are dimensioned so the corresponding apices 30a mate with the foot extension 40 as described with regard to the foot extensions of Fig. 2c. For example, Fig. 15 shows two pairs of short strut members 20a interconnected sequentially to a medium-length strut member 20b, a longer strut member 20c, a medium-length strut member 20b, two pairs of short strut members 20a, which connects to the next foot extensions 40. In the delivery configuration, the medium and longer strut members have apices 30a therebetween that are circumferentially displaced from the toe extensions 40.

As with the endoprosthesis embodiments that include a connector for each connection location, a wide variety of alternative endoprosthesis embodiments without connectors at the connection locations are likewise within the scope of the invention. Particularly, and as previously noted, at least one of the first and second foot portions of the foot extension defines a base portion generally facing a longitudinally-adjacent annular element. By defining the connection location as an overlapping pattern of the base portion and a corresponding portion of the longitudinally-adjacent annular element,

as shown schematically in Fig. 26 for clarity, no connector is required. Additionally, and as previously noted, the generally elongate area of the base portion further enables versatility in the circumferential alignment adjacent annular elements, and the multiple areas of flexure of the foot extension enable enhanced longitudinal flexibility between adjacent annular elements without the need for connectors. Furthermore, by eliminating the connectors, an endoprosthesis having more uniform coverage for scaffolding as well as for the delivery of a drug or similar beneficial agent, as described further below, can be provided.

A variety of design alternatives for different endoprosthesis embodiments without connectors can be achieved by selectively combining the various aspects of the present invention. For purpose of illustration and not limitation, as well as for comparison with the embodiment of Fig. 15, a number of exemplary embodiments including the combination of foot extensions and overlapping patterns at connection locations of the present invention are depicted in planar format in Figs. 16-26.

The embodiment of Fig. 16, shown substantially in a delivery configuration, includes a plurality of annular elements 10, wherein each longitudinal side of an annular element has 16 apices. In this embodiment, four apices on a selected side, e.g. 12, of adjacent annular elements 10 are defined by a foot extension 40, wherein the foot extensions 40 extend in the same longitudinal direction but in alternate circumferential directions from one annular element 10 to the next. Each foot extension 40 is configured substantially similar to that of Fig. 2c, wherein the base portion 46 is contoured to include first and second portions. The contoured pattern of the base portion 46 of each foot extension 40 overlaps with the pattern of an apex 30 of the circumferentially-adjacent annular element. Hence, four connection locations 50 are provided between longitudinally-adjacent annular elements 10, with three apices 30 disposed between the connection locations 50 along the corresponding longitudinal side 12, 14 of each annular element 10. The annular element 10 at the longitudinal end 102 of the endoprosthesis 100 in which the foot extensions 40 are directed is free of foot extensions 40. Fig. 17 shows an alternative embodiment similar to that of Fig. 16, wherein the lengths of the strut members 20 disposed circumferentially between the foot extensions 40 are varied to reduce the gap area defined between longitudinally-adjacent annular elements 10, and thus increase coverage.

Fig. 18 shows an alternative embodiment similar to that of Fig. 16, wherein the center apex disposed along the longitudinal side 12, between the foot extensions 40b that define connection locations is defined as a foot extension 40a. In this manner, circumferentially-adjacent foot extensions 40 along a longitudinal side of an annular element 10 are separated by single apex 30, wherein every other foot extension 40b forms a connection location with an apex 30 of a longitudinally-adjacent annular element 10. Fig. 19 shows an enlarged detail of an embodiment similar to Fig. 18, in the delivery configuration, wherein the base portion 46 of each foot extension 40 has an increased average width as previously discussed with regard to Fig. 2c. Particularly, the base portion 46 of each foot extension 40 is contoured with a generally V-shape to include a first portion 46' and second portion 46". The second portion 46" proximate the toe portion has a width greater than the first portion 46' as previously discussed. Furthermore, the foot extensions 40 of Fig. 19 are all directed in the same circumferential direction.

The embodiment of Fig. 20, which is shown substantially in a delivery configuration, includes 18 apices on each longitudinal side 12, 14 of each annular element 10. On each longitudinal side of an annular element 10 that faces an adjacent annular element, three pair of apices are defined by a pair of foot extensions 40 with each pair of foot extensions 40 having an apex 30a disposed therebetween. Furthermore, each pair of foot extensions 40 includes one foot extension 40b at a connection location 50 with a foot extension 40b on a corresponding side of a longitudinally-adjacent annular element 10. Hence, three connection locations 50 are provided between adjacent annular elements 10. Each foot extension 40 has a generally enlarged foot region 49. Particularly, each foot extension 40 at a connection location 50 has a contoured base portion 46 similar to that of Fig. 16, although more elongate in the longitudinal direction. The connection location 50 is thus defined by the overlapping base portions of the corresponding foot extensions 40b. It is noted that the foot extensions 40a that share a common strut member 20 in this embodiment are not at connection locations 50. The three pairs of foot extensions on each side 12, 14 are separated from each other in this embodiment by three apices 30.

Fig. 21 shows an embodiment, substantially in a delivery configuration, including 18 apices on each side of each annular element 10, wherein every other apex on a side facing an adjacent annular element 10 is defined by a foot extension 40. Three

pairs of circumferentially adjacent foot extensions 40b are connected to three corresponding pairs of foot extensions 40b on a longitudinally-adjacent annular element, so as to define six connection locations 50 as shown. Hence, three remaining foot extensions 40a on each side of the annular element 10 are interspersed between the three pair of foot extensions 40b of the connection locations 50. The foot extensions 40 on each side of the annular elements 10 extend in the same circumferential direction, but in a direction opposite the foot extensions 40 disposed on the opposite longitudinal side of the annular element 10.

Fig. 22 shows an embodiment similar to that of Fig. 18, however, each annular element includes additional strut members and apices. Particularly, the embodiment of Fig. 22 includes 20 apices, rather than 16 apices, on each side of each annular element 10, with every other apex defined by a foot extension 40. Hence, five connection locations 50 are defined between adjacent annular elements 10. The embodiments of Figs. 23 and 24 are similar to the embodiment of Fig. 22; however, selected apices 30s of one annular element are longitudinally aligned to be disposed between circumferentially adjacent foot extensions 40 of an adjacent annular element. As previously noted, and in accordance with the invention, the apices on longitudinally adjacent sides of adjacent annular elements 10 can be disposed so as to be circumferentially out of alignment with each other. Hence, the strut members 20s that are interconnected at the apices 30s disposed between adjacent foot extensions 40 of an adjacent annular element, are provided with a greater length than the remaining strut members so as to dispose the apex 30s generally between the foot extensions 40. In this manner, resulting coverage and scaffolding can be increased. Each of Figs. 22-24 is shown substantially in a delivery configuration.

Fig. 25 discloses an embodiment in a slightly deployed configuration having eight apices per side of each annular element 60. Each annular element 10 is arranged in a diagonal format to define a 360 degree turn of a helical pattern. In this manner, the circumferential end 18 of one annular element can be joined with the corresponding circumferential end 16 of a longitudinally-adjacent element to form a continuous helical pattern along the length of the endoprosthesis 100. Two apices on one side of each annular element are defined by foot extensions 40 similar to that of Fig. 2B. Each foot extension 40 forms an overlapping pattern with the an apex 30 on a circumferentially adjacent side of an adjacent annular element. Hence, two connection

locations 50 are defined between adjacent annular elements 10. As previously noted with regard to Fig. 2B, the apex 30a circumferentially adjacent to the foot extension 40 is longitudinally positioned to substantially contact the toe portion 48 when in the delivery configuration to increase coverage, as well as to capture balloon material if desired. The embodiment of Fig. 25 also includes an eyelet or tab to incorporate a radiopaque marker 120 at one or both ends 102, 104 of the endoprosthesis if desired. Alternative techniques for incorporating radiopaque material are described below.

Fig. 26 is an enlarged view of a connection location similar to that of Fig. 25, wherein the overlapping geometric pattern of a connection location is schematically depicted for purpose of illustration. Particularly, Fig. 26 shows an annular element having a foot extension similar to that of Fig. 2a. The pattern of the foot extension 40b along the base portion 46 is aligned longitudinally to overlap with a portion of the pattern of a circumferentially adjacent annular element 10. The resulting configuration of the overlapping pattern defines the connection location 50 between the two annular elements 10. The amount or extent of overlap between the two patterns can be varied as desired. For example, the patterns can be substantially in tangential contact, or can be fully overlapping. Additionally, fillets or a similar transition can be included to smooth or eliminate any sharp or abrupt edges. It is noted that the thickness at the juncture defined by the overlapping patterns need not be, and preferably is not, increased. Rather, the overlapping pattern refers to the resulting configuration when two separate patterns share a common surface or area.

Figs. 27a through 27d show alternative connection locations 50 defined by different degrees of geometrical overlap between adjacent annular elements 10. The connected foot extension 40b and apex 30 of Fig. 27a have a slight geometrical overlap, such as a tangential surface contact. Fig. 27b shows an overlapping pattern, wherein the connected apex 30 and foot extension 40b fully overlap to substantially share a common member. As depicted, the apex 30 at the connection location 50 extends longitudinally further than the unconnected apices 30. In Fig. 27c, the apex 30 at the connection location 50 protrudes into the foot region of the corresponding foot extension 40b. In this embodiment, the foot extension 40b is generally enlarged and rounded at the base portion 46 compared to free foot extensions 40a to stiffen and reinforce the connection location 50. Additional areas of flexure can be defined by the contour of this configuration, as compared to that of the other foot extensions. By contrast, connected foot extension 40b

of Fig. 27d includes a flattened base portion 46 substantially perpendicular to the longitudinal axis to define a more relaxed configuration. As with Fig. 27c, the connected apex 30 of this embodiment overlaps with the foot extension 40b and protrudes into the foot region 49.

5 As noted above, the various aspects of the present invention allow for a variety of different endoprosthesis embodiments, based upon selective combinations of the features previously described and shown. Similarly, the endoprosthesis of the present invention can be made using any of a number of known manufacturing techniques and materials.

10 The material of construction is preferably selected according to the performance and biological characteristics desired. For example, the endoprosthesis of the invention can be made to be expanded by the change of a delivery condition, such as by the removal of a restraint or exposure to the environment within the body lumen, so as to be self expanding, or by the application of an external force or energy, such as by a
15 balloon or by a radio frequency. For purpose of illustration and not limitation, reference is made generally to "self-expanding" embodiments and "balloon expandable" embodiments of the endoprosthesis of the present invention.

Self-expanding embodiments can be made from any of a variety of known suitable materials including super elastic or shape memory materials, such as nickel-
20 titanium (NiTi) alloys, Elgiloy, and suitable polymers, such as suitable shape memory polyurethane copolymers, or any equivalents thereof. An endoprosthesis made of a suitable super elastic material can be compressed or restrained in its delivery configuration on a delivery device using a sheath or similar restraint, and then deployed to its deployed configuration at a desired location by removal of the restraint as is known
25 in the art. An endoprosthesis made of shape memory material generally can be delivered in a like manner, and if thermally sensitive, can be deployed by exposure of the endoprosthesis to a sufficient temperature to facilitate expansion as is known in the art. It also is possible to make the self-expanding embodiment of a biocompatible material capable of expansion upon exposure to the environment within the body lumen, such as a
30 suitable hydrogel or hydrophilic polymer, including biodegradable or bioabsorbable polymers, such as polycaprolactone (PCL), poly-D,L-lactic acid, Poly-L-lactic acid, poly(lactide-co-glycolide), poly(hydroxybutyrate), polyanhydrides, poly(glycolic acid). For example, if made of an expandable hydrophilic material, the endoprosthesis can be

delivered to the desired location in an isolated state, and then exposed to the aqueous environment of the body lumen to facilitate expansion. Alternative known delivery devices and techniques for a self-expanding endoprosthesis likewise can be used.

5 Balloon expandable embodiments or the like can be made of any of a variety of known suitable deformable materials, including stainless steel, silver, platinum, cobalt chromium alloys such as L605, MP35N or MP20N or any equivalents thereof. "L605" is understood to be a trade name for an alloy available from UTI Corporation of Collegeville, Pennsylvania, including about 53% cobalt, 20% chromium and 10% nickel. "MP35N" and "MP20N" are understood to be trade names for alloys of cobalt, nickel,
10 chromium and molybdenum available from Standard Press Steel Co., Jenkintown, PA. MP35N generally includes about 35% cobalt, 35% nickel, 20% chromium, and 10% molybdenum. MP20N generally includes about 50% cobalt, 20% nickel, 20% chromium and 10% molybdenum. For delivery, the endoprosthesis of a suitable material is mounted in the delivery configuration on a balloon or similar expandable member of a
15 delivery device. Once properly positioned within the body lumen at a desired location, the expandable member is expanded to expand the endoprosthesis to its deployed configuration as is known in the art. Additionally, or alternatively, balloon expandable embodiments can be made of suitable biocompatible polymers, including biodegradable or bioabsorbable materials, which are either plastically deformable or capable of being
20 set in the deployed configuration. If plastically deformable, the material is selected to allow the endoprosthesis to be expanded in a similar manner using an expandable member so as to have sufficient radial strength and scaffolding and also to minimize recoil once expanded. If the polymer must be set in the deployed configuration, the expandable member can be provided with a heat source or infusion ports to provide the
25 required catalyst to set or cure the polymer. Alternative known delivery devices and techniques for a self-expanding endoprosthesis likewise can be used.

Additional materials or compounds also can be incorporated into or on the endoprosthesis if desired. For example, the endoprosthesis can be provided with one or more coatings of biocompatible material to enhance the biocompatibility of the device.
30 Such coatings can include hydrogels, hydrophilic and/or hydrophobic compounds, and polypeptides, proteins or amino acids or the like, including poly vinyl pyrrolidone (PVP), poly vinyl alcohol (PVA), parylene, and heparin. A preferred coating material includes

phosphorylcholine, as disclosed in U.S. Patent Nos. 5,705,583 and 6,090,901 to Bowers et al. and U.S. Patent No. 6,083,257 to Taylor et al., each of which is incorporated by reference herein. Such coatings can also be provided on the endoprosthesis to facilitate the loading or delivery of beneficial agents or drugs, such as therapeutic agents, pharmaceuticals and radiation therapies. Alternatively, the surface of the endoprosthesis can be porous or include one or more reservoirs or cavities formed therein to retain beneficial agent or drug therein as is known in the art. For purposes of illustration and not limitation, the drug or beneficial agent can include antithrombotics, anticoagulants, antiplatelet agents, thrombolytics, antiproliferatives, anti-inflammatories, agents that inhibit hyperplasia, inhibitors of smooth muscle proliferation, antibiotics, growth factor inhibitors, or cell adhesion inhibitors, as well as antineoplastics, antimetotics, antifibrins, antioxidants, agents that promote endothelial cell recovery, antiallergic substances, radiopaque agents, viral vectors, antisense compounds, oligonucleotides, cell permeation enhancers, and combinations thereof.

The endoprosthesis can also be provided with coverings, such as PTFE, ePTFE, Dacron, woven materials, cut filaments, porous membranes, or others such materials to form a stent graft prosthesis. Similarly, a medical device, such as a valve, a flow regulator or monitor device, can be attached to the endoprosthesis, such that the endoprosthesis functions as an anchor for the medical device within the body lumen.

Additionally, an imaging compound or radiopaque material can be incorporated with the endoprosthesis. For example, one or more of the annular elements of the endoprosthesis can be made of a suitable radiopaque material, such as gold, tantalum or a similar material. Alternatively, the radiopaque material can be applied on selected surfaces of one or more of the annular elements using any of a variety of known techniques, including cladding, bonding, adhesion, fusion, deposition or the like. In a preferred embodiment, the material used for fabrication of the endoprosthesis includes a composite structure having multilayers of different materials or compositions. Generally, at least one layer is a base material such as stainless steel, nickel-titanium alloy or cobalt chromium alloy to impart the intended structural characteristic of the endoprosthesis, and at least another layer is a radiopaque material such as gold or tantalum for imaging purposes. For example, a tri-layer structure of 316L-Ta-316L is preferred for a balloon expandable stent and a tri-layer structure of NiTi-Ta-NiTi is preferred for a self-

expanding stent. Suitable multi-layerd composite structures are available in sheet or tube form from UTI Corporation of Collegeville, Pennsylvania, and are disclosed in US Patent No. 5,858,556, which is incorporated herein by reference. In yet another embodiment, one or more marker elements of radiopaque material can be attached to the

5 endoprosthesis. For example, and as previously shown in Fig. 25, eyelets or tabs can be provided on one or more annular elements, preferably at at least a distal or proximal longitudinal end of the endoprosthesis. A rivet or bead of radiopaque material can then be attached to the eyelet or tab in a manner as known in the art. Alternatively, the separate marker can be attached directly to annular element. For example, and in

10 accordance with a preferred embodiment of the invention as shown in Figs. 1 and 15, a wire or strip of radiopaque material can be wrapped around and secured to a base portion of one or more foot extensions at one or both longitudinal ends of the endoprosthesis; preferably by providing the foot extension with a geometry to enable limited strain in the base portion of the foot extension upon deployment.

15 A variety of manufacturing techniques are well known and may be used for fabrication of the endoprosthesis of the present invention. For example, and in a preferred embodiment, the endoprosthesis can be formed from a hollow tube of suitable material using a known technique, such as by laser cutting, milling or chemical etching. The structure is mechanically blasted and then electropolished or otherwise finished to

20 remove burrs and eliminate sharp edges and contaminates. Alternatively, the endoprosthesis can be fabricated from a sheet of suitable material using a similar cutting, milling or etching technique, and then rolled or bent about a longitudinal axis into the desired shape. If desired, the lateral edges of the structure can be joined together, such as by welding or bonding, to form a closed tubular structure, or the lateral edges can remain

25 unattached to form an coiled, rolled sheet or open tubular structure. Conversely, a suitable material of construction can be applied selectively to a substrate to define the desired pattern of the endoprosthesis structure, and then the substrate can be removed. Other methods of manufacture also can be used for the endoprosthesis of the present invention, such as by bending toroidal rings or elongate lengths of wire into appropriately

30 shaped members, such as that corresponding to each annular element, and then joining the appropriately shaped members together at connection locations by a welding or bonding technique or the like. If a shape memory material is used, such as a nickel titanium alloy, the fabricated structure can be heat treated on a mandrel or the like using

known techniques to establish the desired endoprosthesis shape and dimensions at a predetermined temperature, e.g. when above austenitic transition temperature.

As originally cut or fabricated, the endoprosthesis can correspond to its delivery configuration or to a deployed configuration or a configuration therebetween.

5 Preferably, however, the endoprosthesis is fabricated with a configuration at least slightly larger than the delivery configuration as shown in the planar formats of Figs. 6-10 and 16-24, for example. In this manner, the endoprosthesis can be crimped or otherwise compressed into its delivery configuration on a corresponding delivery device. In another preferred embodiment, the endoprosthesis is originally fabricated from a tube
10 having a diameter corresponding to the deployed configuration. In this manner, the longitudinally-free portions of the annular elements (*e.g.*, apices not at a connection location) and circumferentially-free portions (*e.g.*, the toe portion of the foot extensions) can be maintained within the general cylindrical shape (*e.g.*, diameter) of the endoprosthesis when deployed, so as to avoid such portions from extending radially
15 inwardly when in the deployed configuration. The endoprosthesis is therefore designed to match the target vessel in which the endoprosthesis is to be deployed. For example a stent will typically be provided with an outer diameter in the deployed configuration ranging from about 1 mm for neurological vessels to about 25 mm for the aorta. Similarly, a stent will typically be provided with a length ranging from 5 mm to 200 mm.
20 Variations of these dimensions will be understood in the art based upon the intended application or indication for the endoprosthesis.

As previously noted, the geometry of each component of the endoprosthesis, such as the width, thickness, length and shape of the strut members and foot portions, as well as of the connectors if provided, is preferably selected to obtain
25 predetermined expansion, flexibility, foreshortening, coverage scaffolding, and cross profile characteristics. For example, longer strut members can promote greater radial expansion or scaffolding coverage. The phase difference or circumferential alignment between adjacent annular elements likewise can be altered to control coverage and flexibility as well as facilitate more uniform drug delivery. Similarly, the number and
30 placement of connection locations and, if present, the connectors, between longitudinally-adjacent annular elements are preferably selected to obtain the desired flexibility of the endoprosthesis. The number of apices and foot extensions between connection locations also can be varied to achieve desired performance characteristics.

Fig. 28 depicts a representative embodiment depicting such variations within an endoprosthesis of strut lengths and strut widths for varied rigidity, and of connector locations for varied flexibility.

As recognized from the detailed description above, the foot extensions particularly enhance and provide versatility in the design of the endoprosthesis of the present invention. The foot extension can be configured and dimensioned relative to the strut members and the remainder of the endoprosthesis to compensate for longitudinal foreshortening upon stent expansion. For example, the areas of flexure of the foot extensions can be adjusted by contouring the foot geometry and dimensions, as well as by altering the lengths of selected strut members. Alternatively, the geometry of the foot extension can be configured to provide a desired amount of lengthening or shortening of the endoprosthesis upon expansion. The foot extensions can be configured to balance or assist in evenly distributing strain or expansion of the endoprosthesis. The foot extensions also can improve and control the flexibility of the endoprosthesis, preferably without substantially impacting the desired coverage or scaffolding of the endoprosthesis. The circumferentially elongated base portion of each foot extension provides a wide range of connection locations, and allows adjacent annular elements to be attached over a range of phase differences or circumferential alignment. The foot extensions can be configured to produce a torque on longitudinally free portions, such as unconnected apices, to maintain these longitudinally free portions within the general cross profile of the endoprosthesis when flexed along its longitudinal axis or expanded to its deployed configuration. This feature can be adjusted if it is desired to embed portions of the endoprosthesis into the vessel wall or other tissue.

Reference is now made to two exemplary preferred embodiments of a stent of the present invention; a self-expanding stent as shown in Figs. 29a through 29f, and a balloon expandable stent as shown in Figs. 30a through 30f.

Fig. 29a shows the planar format of a preferred embodiment of a self-expanding stent as cut and polished in a slightly deployed configuration. As depicted herein, the self-expanding stent comprises ten annular elements 10 with five connection locations 50 between longitudinally-adjacent annular elements 10 for an approximate stent length of about 21 mm. Annular elements can be added to increase the stent length, or omitted to decrease the stent length, as desired. Each annular element 10 includes fifteen apices per longitudinal side. On one longitudinal side 12 of each annular element

10, five apices are defined by foot extensions 40. Two circumferentially-adjacent apices 30 are located between adjacent foot extensions. On the other longitudinal side 14 of each annular element 10, no foot extensions are provided. Each foot extension 40 has a shape similar to that of Fig. 2c, as previously described in detail. Each of the five
5 connection locations 50 between adjacent annular elements 10 is defined by a slightly overlapping pattern of the base portion 46 of each foot extension 40 with a corresponding apex 30 of a longitudinally-adjacent annular element in a manner similar to that of Fig. 27a. In this manner, longitudinally-adjacent apices of adjacent annular elements are out of circumferential alignment with each other so as to be less than 180 degrees out of
10 phase. Furthermore, connection locations 50 are circumferentially displaced or offset from one set of annular elements to the next.

The self-expanding stent of this preferred embodiment is made from a suitable tube stock of nickel-titanium alloy, such as SE508 or SM508, ASTM Standard F2063-00, comprising about 54.5 to about 57% wt. nickel and about 45.5 to about 42.7%
15 wt. titanium, which is commercially available from Minitubes, Inc. of Grenoble, France. It is recognized, however, that alternative alloy compositions can be used if desired. For fabrication of a self-expanding stent having a deployed configuration diameter of about 7 mm to about 8 mm, the tube stock has an outer diameter of about 0.091 inch and a uniform wall thickness of about 0.010 inch. The tube stock is laser cut with the
20 configuration shown in Fig. 29b as a continuous pattern around the circumference of the tube; wherein only the front half of the structure is shown for clarity. The cut tube is then mechanical blast and sequentially heat treated on a series of cylindrical mandrels of increasing diameter using known techniques to set the desired deployed configuration of the stent when in an austenitic state as shown in Fig. 29d. The heat set stent is then
25 electropolished using known techniques. The relevant dimensions of the strut members for this preferred embodiment, after electropolishing, include a nominal strut length of about 0.055 inch, a nominal strut width of about 0.004 inches and a generally uniform thickness of about 0.008 inches. Regarding each foot extension, after electropolishing, the first portion of the foot extension has a width of about 0.005 inch and a length of
30 about 0.013, as measured along its outer edge, and the base portion of the foot extension includes total length of about 0.033, as measured along its outer edge, with a first portion proximate the heel portion having a width of about 0.005 inch and a second portion proximate the toe portion having a width of about 0.007 inch. The strut member

extending from the ankle portion of the foot extension tapers from a width of about 0.005 inch at the end proximate the foot extension to about 0.004 inch at the opposite end, with a length of about 0.059 inch. The strut member extending from the heel portion of the foot extension tapers from a width of about 0.005 inch at the end proximate the foot extension to about 0.004 inch at the opposite end, with a length of about 0.068 inch. After polishing, additional cleaning or preparation may be required.

Once prepared, the self-expanding stent of this embodiment is compressed to a delivery configuration as shown in the front-half view of Fig. 29c, preferably with the strut members generally parallel to the longitudinal axis of the stent and each other. The stent can then be delivered using a conventional retractable sheath delivery catheter, as is known in the art. Figs. 29d and 29e show the self-expanding stent of this embodiment in a deployed configuration. For purpose of clarity, only the front half of the stent is shown in Fig. 29d. As depicted, the stent of this embodiment has been balanced for generally uniform expansion. Fig. 29f shows a self-expanding stent of greater length of this embodiment deployed in a curved vessel, wherein the apices proximate the inner radius of the curve generally open less than the apices proximate the outer radius of the curve.

Fig. 30a shows the planar format of a preferred embodiment of a balloon expandable stent as cut and polished in a slightly deployed configuration. As depicted herein, the balloon expandable stent comprises fifteen annular elements 10 with two connection locations 50 between longitudinally-adjacent annular elements for an approximate stent length of about 18 mm. Annular elements can be added to increase the stent length, or omitted to decrease the stent length, as desired. Each annular element includes ten apices per longitudinal side. On one longitudinal side 12 of each annular element 10, two apices are defined by foot extensions 40. Four circumferentially-adjacent apices 30 are located between adjacent foot extensions. On the other longitudinal side 14 of each annular element 10, no foot extensions are provided. Each foot extension 40 has a shape similar to that of Fig. 2a, as previously described in detail. Each of the two connection locations 50 between adjacent annular elements 10 is defined by an overlapping pattern of the base portion 46 of each foot extension 40b with a corresponding apex 30 of a longitudinally-adjacent annular element in a manner similar to that of Fig. 26. In this manner, longitudinally-adjacent apices of adjacent annular elements are out of circumferential alignment with each other so as to be less than 180

degrees out of phase. Furthermore, connection locations 50 are circumferentially displaced or offset from one set of annular elements to the next.

The balloon expandable stent of this preferred embodiment is made from a suitable tube stock of composite material including an inner layer of 316L stainless steel, a middle layer of tantalum, and an outer layer of 316L stainless steel, which is available from UTI Corporation of Collegeville, Pennsylvania. It is recognized, however, that alternative material compositions can be used if desired. For fabrication of a balloon expandable stent having a deployed configuration diameter of about 2.75 mm to about 3.0 mm, the tube stock has an outer diameter of about 0.062 inch and a generally uniform wall thickness of about 0.004 inch, with the tantalum layer constituting between about 3% to about 50% of the wall thickness, and more preferably between about 10% to about 25% of the wall thickness depending upon the intended indication. For example, a coronary stent of this dimension preferably would have a tantalum layer of between about 15% to about 17% of the tube stock thickness. The tube stock is laser cut with the configuration shown in Fig. 30b as a continuous pattern around the circumference of the tube; only seven annular elements are depicted for purpose of clarity. The cut tube is then mechanically blasted and electropolished using known techniques. The relevant dimensions of the strut members for this preferred embodiment, after electropolishing, include a nominal strut length of about 0.036 inches, a nominal strut width of about 0.003 inches and a generally uniform thickness of about 0.003 inches. Regarding each foot extension, after electropolishing, the first portion of the foot extension has a width of about 0.005 inch and a length of about 0.008 inch, as measured along the outer edge, and the base portion of the foot extension has a width of about 0.005 inch and a length of about 0.021 inch as measure along the outer edge. The strut member extending from the ankle portion of the foot extension tapers from a width of about 0.004 inch at the end proximate the foot extension to about 0.003 inch at the opposite end, with a length of about 0.034 inch. The strut member extending from the heel portion of the foot extension tapers from a width of about 0.005 inch at the end proximate the foot extension to about 0.003 inch at the opposite end, with a length of about 0.042 inch. After electropolishing, additional cleaning or preparation may be required.

Once prepared, the balloon expandable stent of this embodiment is compressed to a delivery configuration as shown in Fig. 30c, with only seven annular elements depicted for purpose of clarity. Preferably, the strut members are generally

parallel to the longitudinal axis of the stent and each other when in the delivery configuration. The stent can then be delivered using a conventional balloon delivery device, as is known in the art. Preferably, a portion of balloon material of the delivery device is captured in the gap defined by the foot extension and the circumferentially-adjacent strut member. Figs. 30d and 30e show the balloon expandable stent of this embodiment in a deployed configuration; only seven annular elements are depicted for purpose of clarity. For purpose of clarity, only the front half of the stent is shown in Fig. 30d. As depicted, the stent of this embodiment has been balanced for generally uniform expansion. Fig. 30f shows the balloon expandable stent of this embodiment deployed in a curved vessel, wherein the apices proximate the inner radius of the curve generally open less than the apices proximate the outer radius of the curve.

While illustrative embodiments of the invention have been disclosed herein, numerous modifications and other embodiments may be devised by those skilled in the art in accordance with the invention. For example, the various features depicted and described in the embodiments herein can be altered or combined to obtain desired endoprosthesis characteristics in accordance with the invention. Therefore, it will be understood that the appended claims are intended to cover all such modifications and embodiments, which are within the spirit and scope of the present invention.

20

CLAIMS

What is claimed is:

5 1. An endoprosthesis for delivery in a body lumen comprising:
a first set of interconnected strut members defining a first annular element,
each strut member of the first annular element including a first end and a second end; and
a second set of interconnected strut members defining a second annular
element, each strut member of the second annular element including a first end and a
10 second end;

the first annular element and the second annular element aligned
longitudinally adjacent to each other along a longitudinal axis and connected to each
other at at least one connection location, the first and second annular elements being
expandable between a delivery configuration and a deployed configuration;

15 at least one of the first and second annular elements including a foot
extension extending between at least one pair of circumferentially-adjacent strut
members, the foot extension including a first foot portion extending circumferentially
from the first end of one of the circumferentially-adjacent strut members of the pair and a
second foot portion extending circumferentially from the first end of the other of the
20 circumferentially-adjacent strut members, the first and second foot portions joined at a
toe portion of the foot extension.

2. The endoprosthesis of claim 1, wherein the first end of selected
circumferentially-adjacent strut members of the first annular element are interconnected
25 to define apices proximate a first longitudinal side of the first annular element and the
second end of selected circumferentially-adjacent strut members of the first annular
element are interconnected to define apices proximate a second longitudinal side of the
first annular element, and further wherein the first end of selected circumferentially-
adjacent strut members of the second annular element are interconnected to define apices
30 proximate a first longitudinal side of the second annular element and the second end of
selected circumferentially-adjacent strut members of the second annular element are
interconnected to define apices proximate a second longitudinal side of the second
annular element, the foot extension defining the apex between the pair of

circumferentially-adjacent strut members of the at least one of the first and second annular elements.

3. The endoprosthesis of claim 2, wherein each strut member of at least one of the first and second annular elements is interconnected continuously at its first and second ends with an adjacent strut member, respectively, to define the at least one annular element as a closed ring.

4. The endoprosthesis of claim 2, wherein each strut member of at least one of the first and second annular elements is a straight member.

5. The endoprosthesis of claim 4, wherein each straight strut member is substantially parallel with the longitudinal axis when in the delivery configuration.

6. The endoprosthesis of claim 2, wherein a plurality of the strut members of at least one of the first and second annular elements each has a substantially uniform width along its length between the first and second ends.

7. The endoprosthesis of claim 2, wherein at least one strut member of the pair of the circumferentially-adjacent strut members has a varied width along its length between the first and second ends.

8. The endoprosthesis of claim 7, wherein the varied width is defined by a taper from a first width at the first end of the strut and a second width at the second end of the strut, the first width being greater than the second width.

9. The endoprosthesis of claim 8, wherein a plurality of remaining strut members of the at least one of the first and second annular elements each has a substantially uniform width along its length between the first and second ends, the first width of the pair of the circumferentially-adjacent strut members being greater than the substantially uniform width of the plurality of remaining strut members.

10. The endoprosthesis of claim 2, wherein at least one of the apices of the first and second annular elements defines a V-shape with the circumferentially-adjacent strut members when in the deployed configuration.

5 11. The endoprosthesis of claim 2, wherein at least one of the apices of the first and second annular elements has an arcuate shape.

12. The endoprosthesis of claim 2, wherein the first and second foot portions of the foot extension have an average width greater than an average width of each remaining apex of the at least one of the first and second annular elements.

13. The endoprosthesis of claim 2, wherein the first side of the first annular element is longitudinally adjacent the second side of the second annular element, and further wherein the apices proximate the first side of the first annular element are circumferentially out of alignment with the apices proximate the second side of the second annular element.

14. The endoprosthesis of claim 2, wherein the foot extension of the at least one of the first and second annular elements extends in a first circumferential direction, the at least one of the first and second annular elements including a circumferentially adjacent apex located proximate the foot extension in the first circumferential direction, the circumferentially adjacent apex positioned longitudinally on the first side of the at least one of the first and second annular elements to mate with the foot extension when in the delivery configuration.

15. The endoprosthesis of claim 2, wherein the foot extension of the at least one of the first and second annular elements extends in a first circumferential direction, the at least one of the first and second annular elements including a circumferentially adjacent apex located proximate the foot extension in the first circumferential direction, the circumferentially adjacent apex positioned longitudinally on the first side of the at least one of the first and second annular elements to contact the toe portion of the foot extension when in the delivery configuration.

16. The endoprosthesis of claim 2, wherein a plurality of apices of the first and second annular elements are defined by foot extensions, each foot extension extending between a pair of circumferentially-adjacent strut members.

5 17. The endoprosthesis of claim 16, wherein at least one foot extension extends in a first circumferential direction about the longitudinal axis and at least another foot extension extends in a second circumferential direction opposite the first circumferential direction.

10 18. The endoprosthesis of claim 16, wherein each foot extension of at least one of the first and second annular elements extends in a first circumferential direction about the longitudinal axis.

15 19. The endoprosthesis of claim 16, wherein the foot extensions of at least one of the first and second annular elements are located proximate only one of the first and second sides of the annular element.

20 20. The endoprosthesis of claim 16, wherein the first and second annular elements are connected at a plurality of connection locations, each connection location including at least one of the foot extensions.

21. The endoprosthesis of claim 1, wherein the connection location between the first and second annular elements includes the foot extension.

25 22. The endoprosthesis of claim 1, further comprising at least one connector extending between the first annular element and the second annular element at the connection location, the connector having a first end and a second end.

30 23. The endoprosthesis of claim 22, wherein the connector includes an L-shaped portion between the first and second ends, the L-shaped portion including a first leg and a second leg angled relative to the first leg.

24. The endoprosthesis of claim 23, wherein the first leg has a length different than a length of the second leg.

5 25. The endoprosthesis of claim 22, wherein the connector includes a curved portion between the first end and the second end.

10 26. The endoprosthesis of claim 1, wherein at least one of the strut members of the pair of circumferentially-adjacent strut members has a length greater than a length of remaining strut members of the at least one of the first and second annular elements.

15 27. The endoprosthesis of claim 1, wherein the foot extension defines at least two areas of flexure between the pair of circumferentially-adjacent strut members.

28. The endoprosthesis of claim 1, wherein the foot extension extends circumferentially at an angle relative to a line parallel to the longitudinal axis.

20 29. The endoprosthesis of claim 1, wherein at least one of the first and second foot portions includes a curved portion.

25 30. The endoprosthesis of claim 1, wherein at least one of the first and second foot portions defines a base of the foot extension, the base generally facing the other of the at least one of the first and second annular elements.

31. The endoprosthesis of claim 30, wherein the base is defined as a generally straight member.

30 32. The endoprosthesis of claim 30, wherein the base is defined as a contoured member directed longitudinally toward the other of the at least one of the first and second annular elements.

33. The endoprosthesis of claim 32, wherein the contoured member generally has a V-shape including a first portion and a second portion.

5 34. The endoprosthesis of claim 33, wherein the first portion of the V-shape has a width different than the second portion.

10 35. The endoprosthesis of claim 30, wherein the connection location is defined by an overlapping pattern of the base of the foot extension with the other of the at least one of the first and second annular elements.

36. The endoprosthesis of claim 30, wherein the connection location includes a connector extending between the base portion and the other of the at least one of the first and second annular elements.

15 37. The endoprosthesis of claim 1, wherein the endoprosthesis is a self-expanding stent.

38. The endoprosthesis of claim 1, wherein the endoprosthesis is a balloon expandable stent.

20 39. The endoprosthesis of claim 1, further comprising a radiopaque material incorporated with at least one of the first and second annular elements.

25 40. The endoprosthesis of claim 39, wherein the radiopaque material is attached as a marker to at least one of the first and second annular elements.

41. The endoprosthesis of claim 39, wherein at least one of the first and second annular elements is formed of the radiopaque material.

30 42. The endoprosthesis of claim 39, wherein the at least one of the first and second annular elements is formed with a first layer of a base material and a second layer of the radiopaque material.

43. The endoprosthesis of claim 1, wherein at least one of the first and second annular elements is balanced for uniform expansion between the delivery configuration and the deployed configuration.

5 44. The endoprosthesis of claim 1, wherein the first annular element has a first radial bias and the second annular element has a second radial bias, the first radial bias being different than the second radial bias.

10 45. The endoprosthesis of claim 1, further comprising a third set of interconnected strut members defining a third annular element, the third annular element aligned longitudinally adjacent to the second annular element along the longitudinal axis and connected to the second annular element at at least one connection location.

15 46. An endoprosthesis for delivery in a body lumen comprising:
a first set of interconnected strut members defining a first annular element, each strut member of the first annular element including a first end and a second end, and
a foot extension extending between at least one pair of circumferentially-adjacent strut members, the foot extension including a first foot portion extending circumferentially from the first end of one of the circumferentially-adjacent strut
20 members of the pair and a second foot portion extending circumferentially from the first end of the other of the circumferentially-adjacent strut members, the first and second foot portions joined at a toe portion of the foot extension,
the first annular element defining a longitudinal axis and being expandable between a delivery configuration and a deployed configuration.

25 47. The endoprosthesis of claim 46, further comprising a second set of interconnected strut members defining a second annular element, the second annular element aligned longitudinally adjacent to the first annular element along the longitudinal axis and connected to the first annular element at at least one connection location, the
30 connection location including the foot extension of the first annular element.

48. The endoprosthesis of claim 47, wherein the foot extension has a first longitudinal dimension in the delivery configuration and a second longitudinal dimension in the deployed configuration.

5

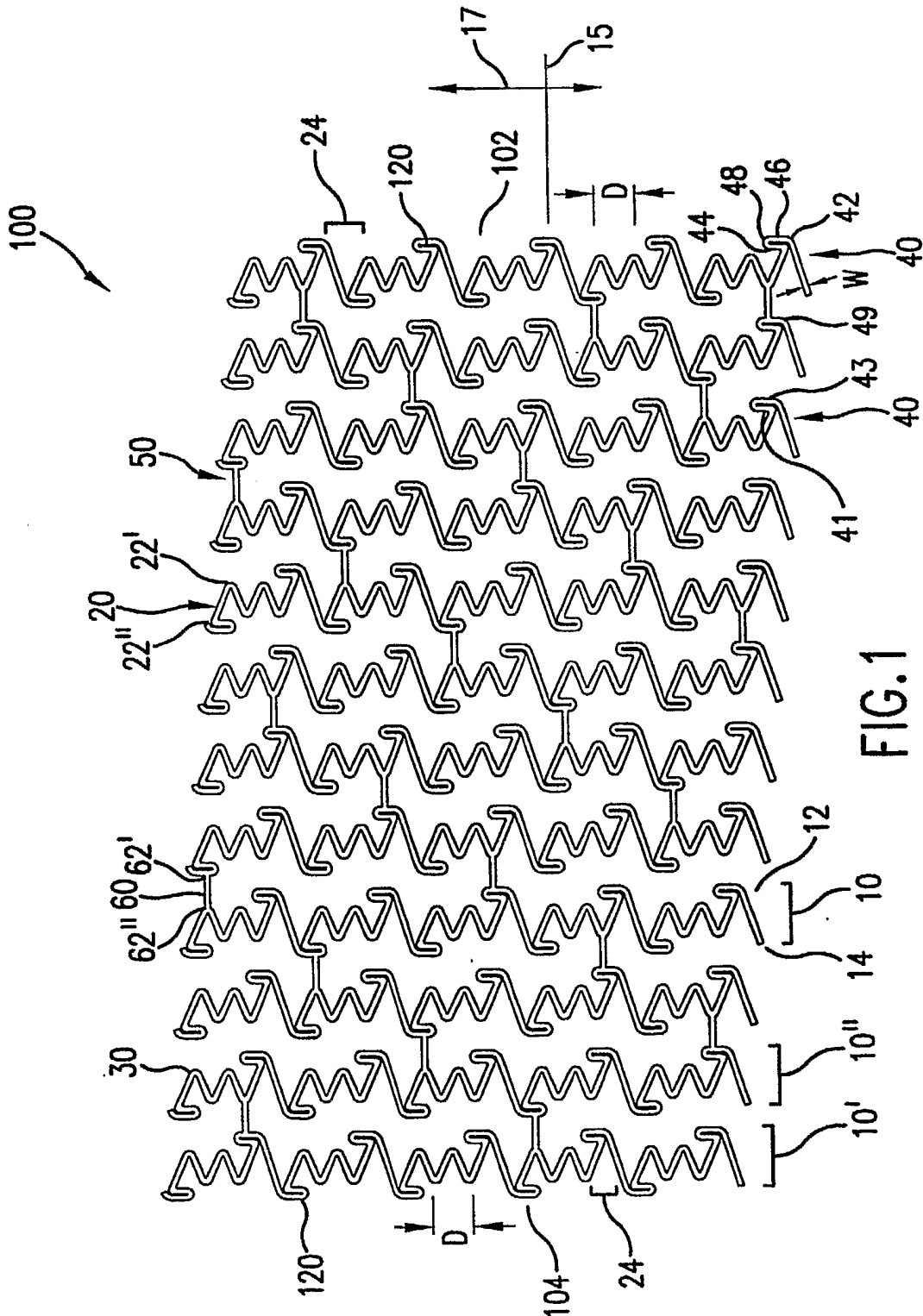

FIG. 1

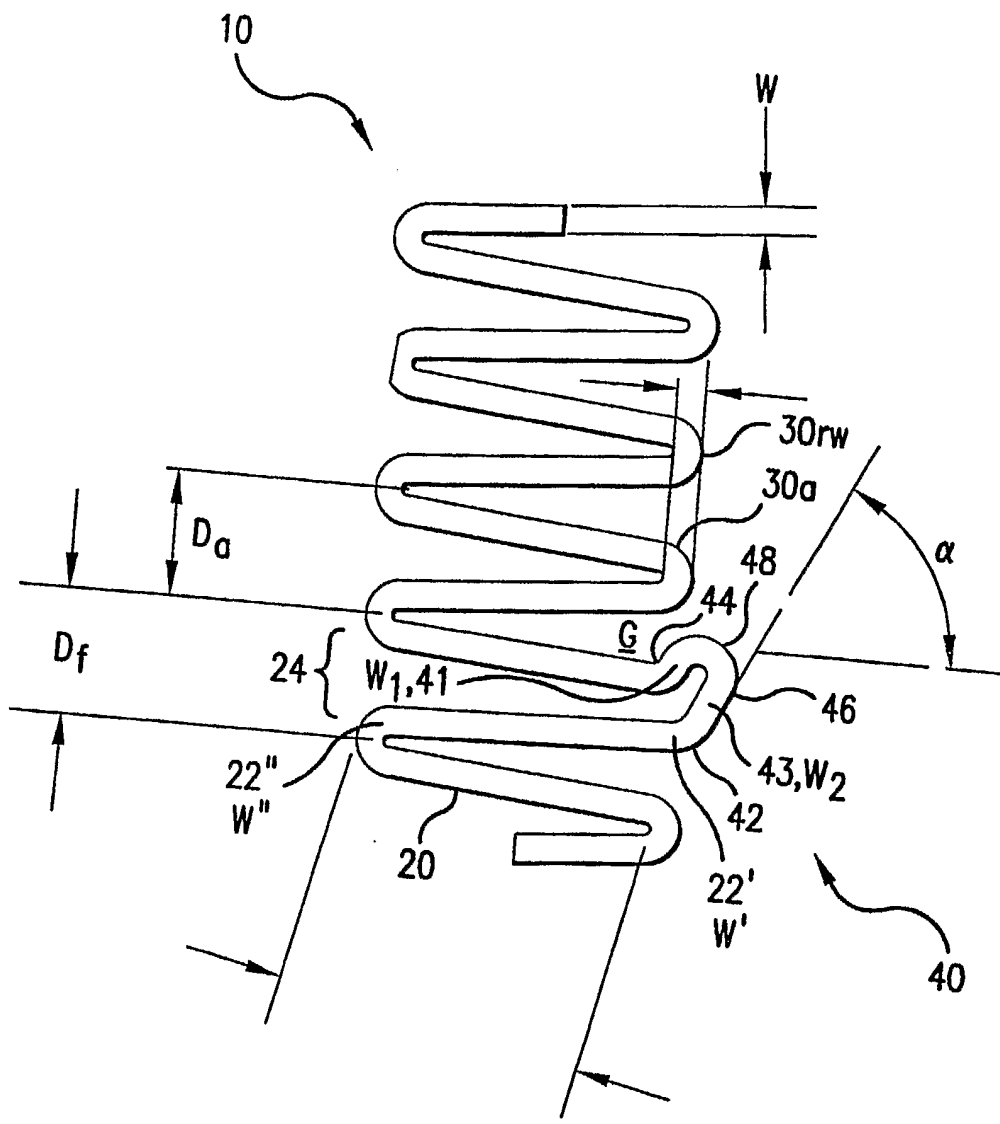

FIG.2a

PCT/US03/14167 RO/US 11/07703

3/44

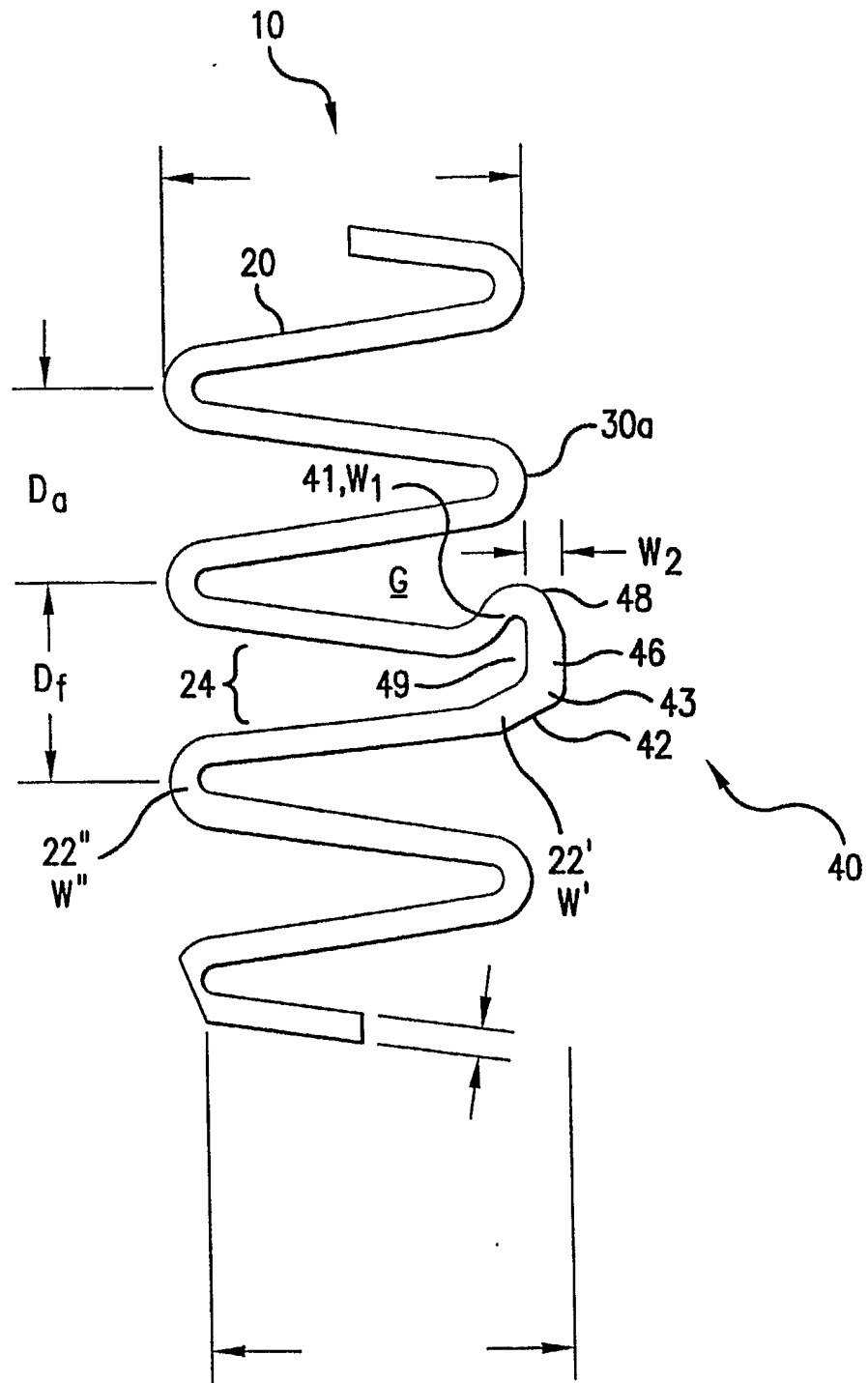

FIG.2b

PCT/US 11/07/03

4/44

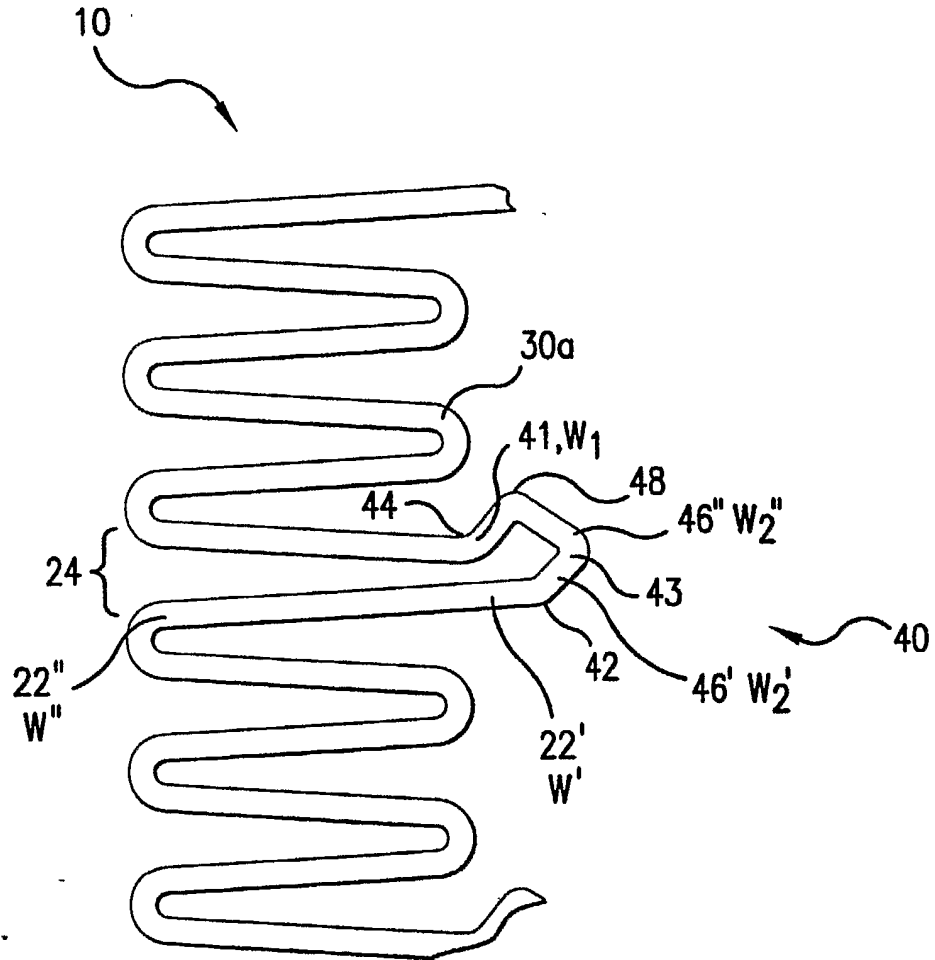

FIG.2c

RO/US 11/07/03

5/44

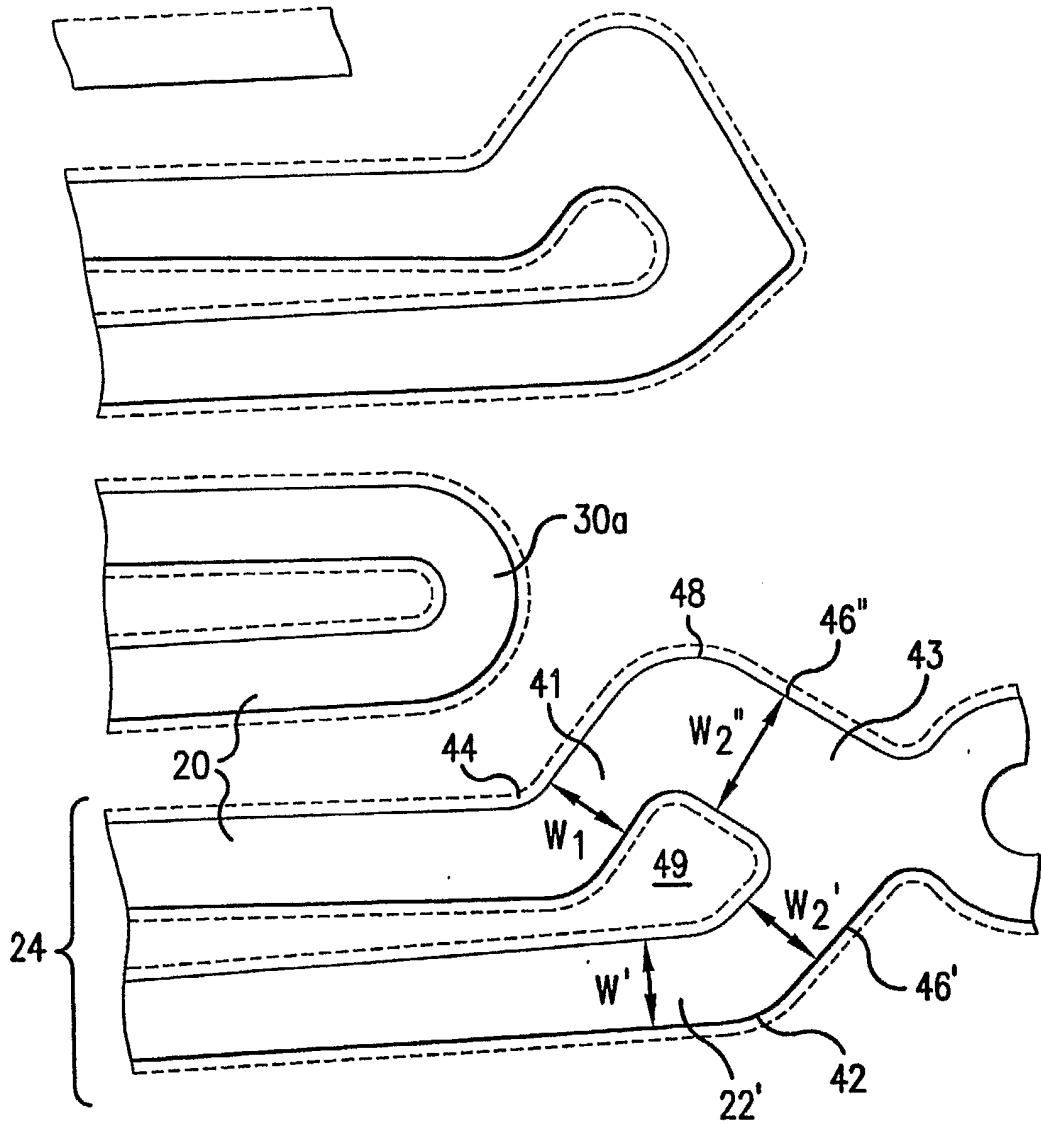

FIG.2d

WO 03/094798 PCT/US 11/07/03

6/44

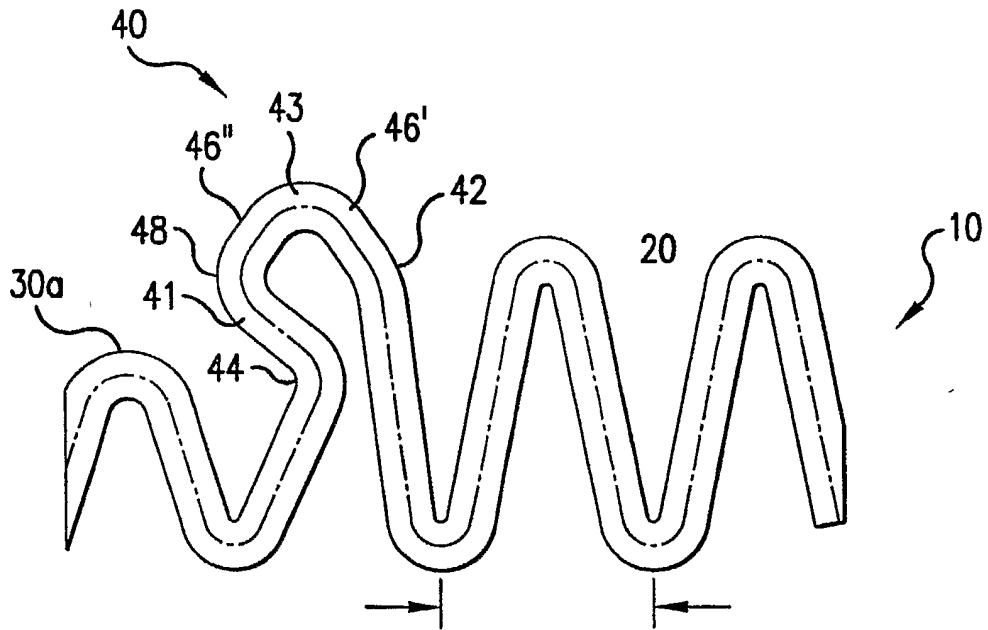

FIG.2e

PCT/US03/14167
PCT/US 11/07/03

7/44

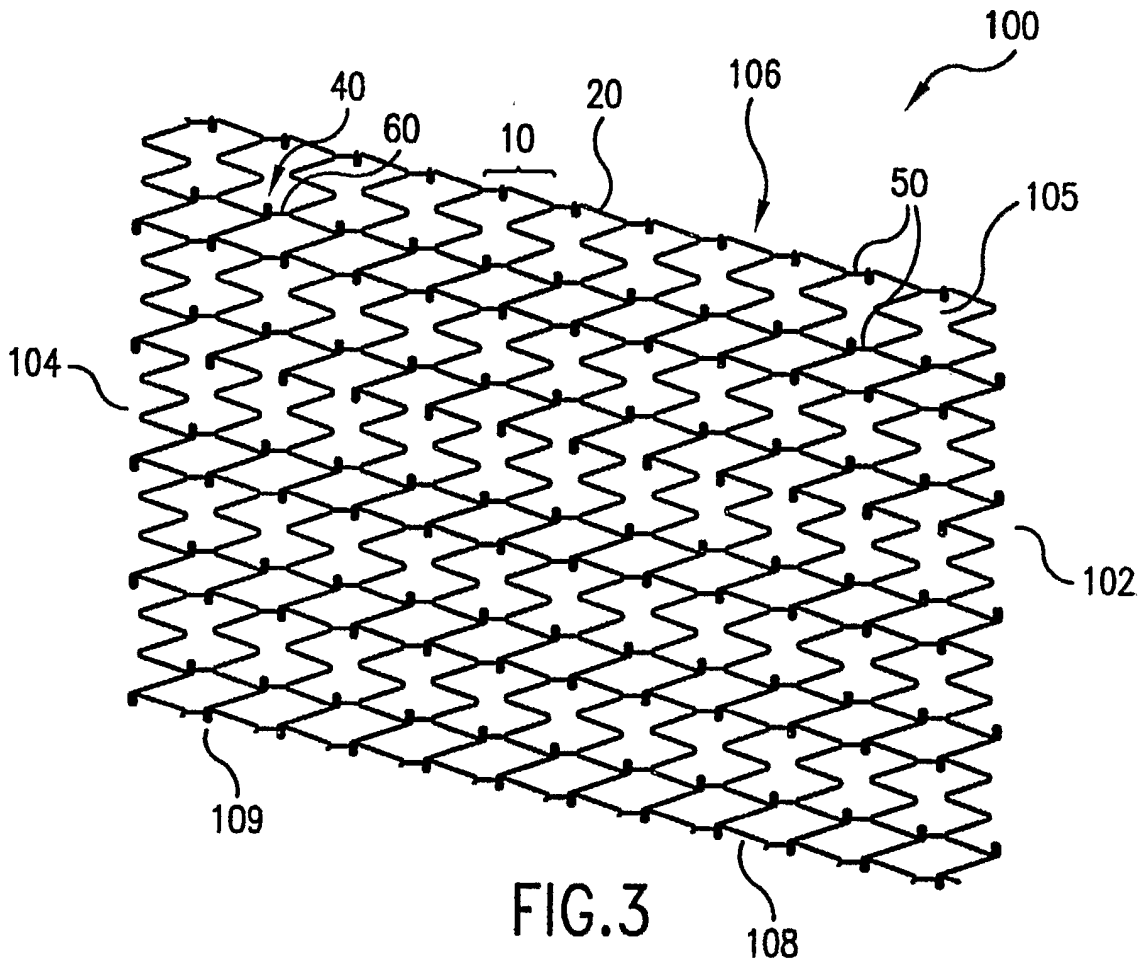

FIG. 3

RO/US 11/07/03

8/44

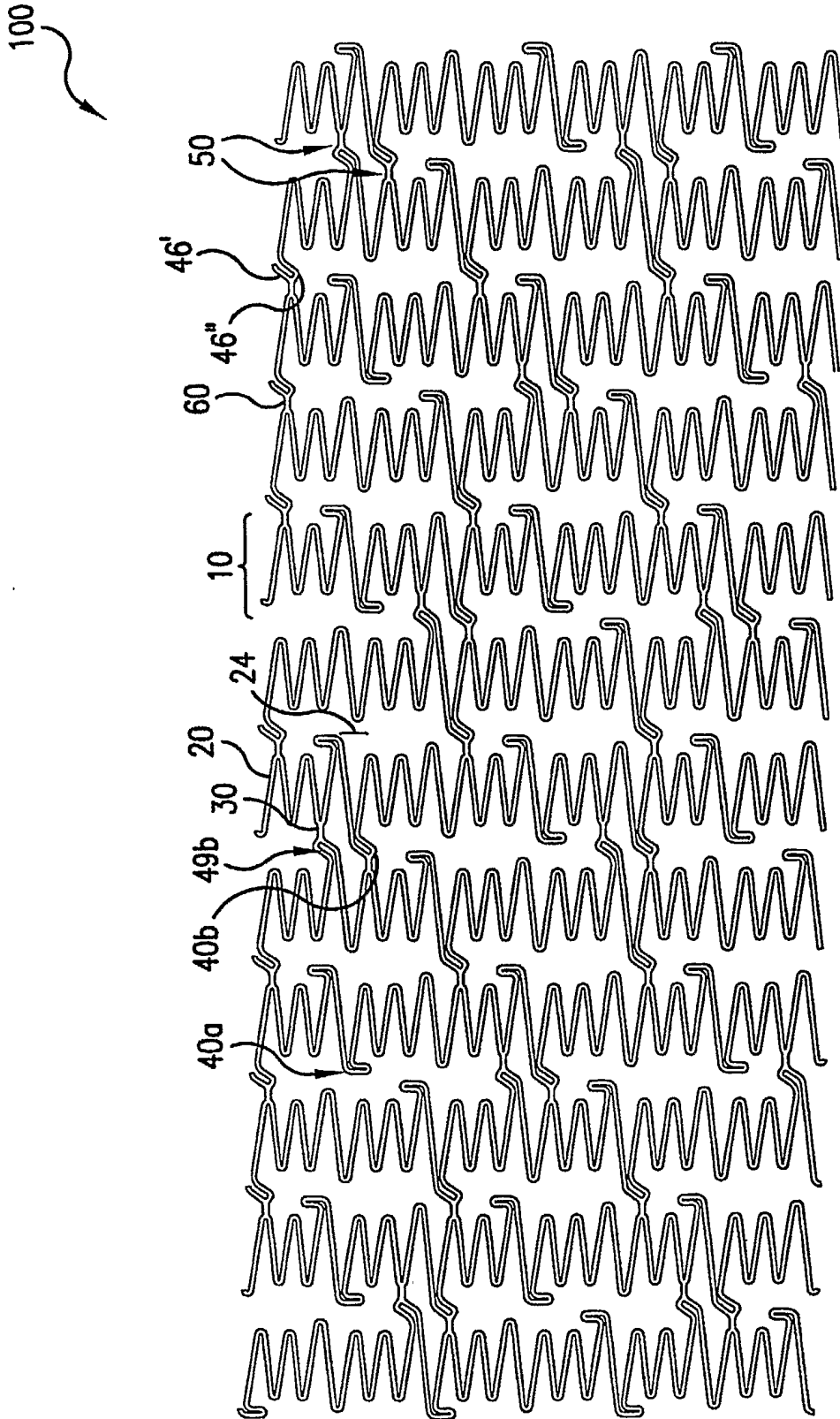

FIG. 4

PCT/US03/14167 RO/US 11/07103

9/44

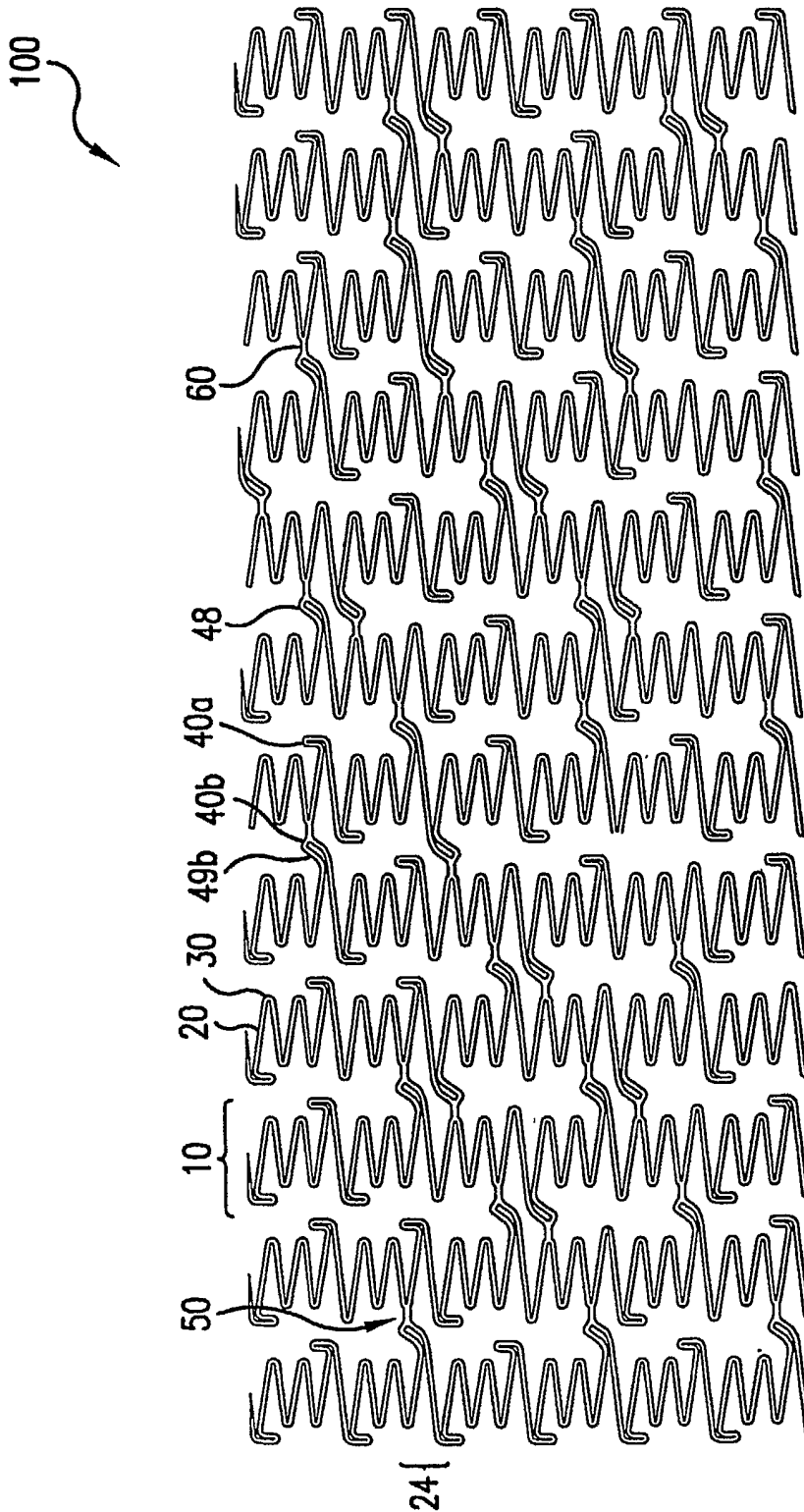

FIG.5

RO/US 11/07703

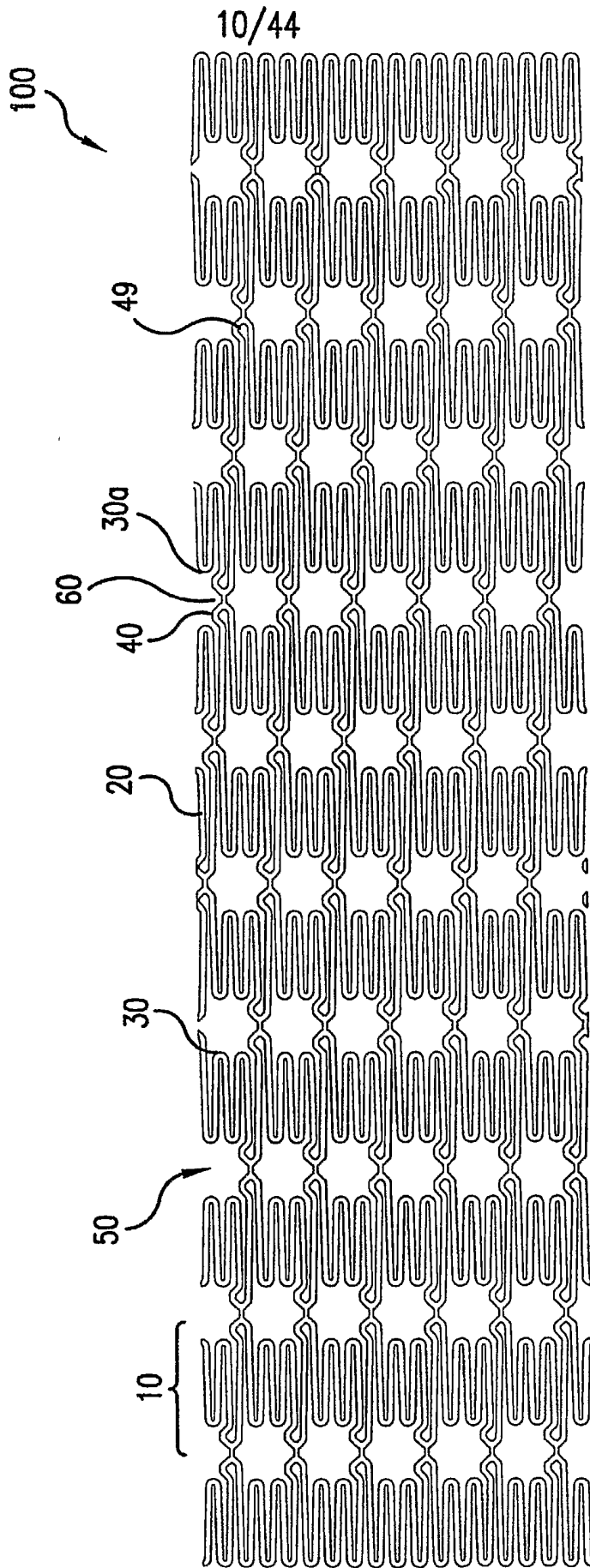

FIG.6

RO/US 11/07703

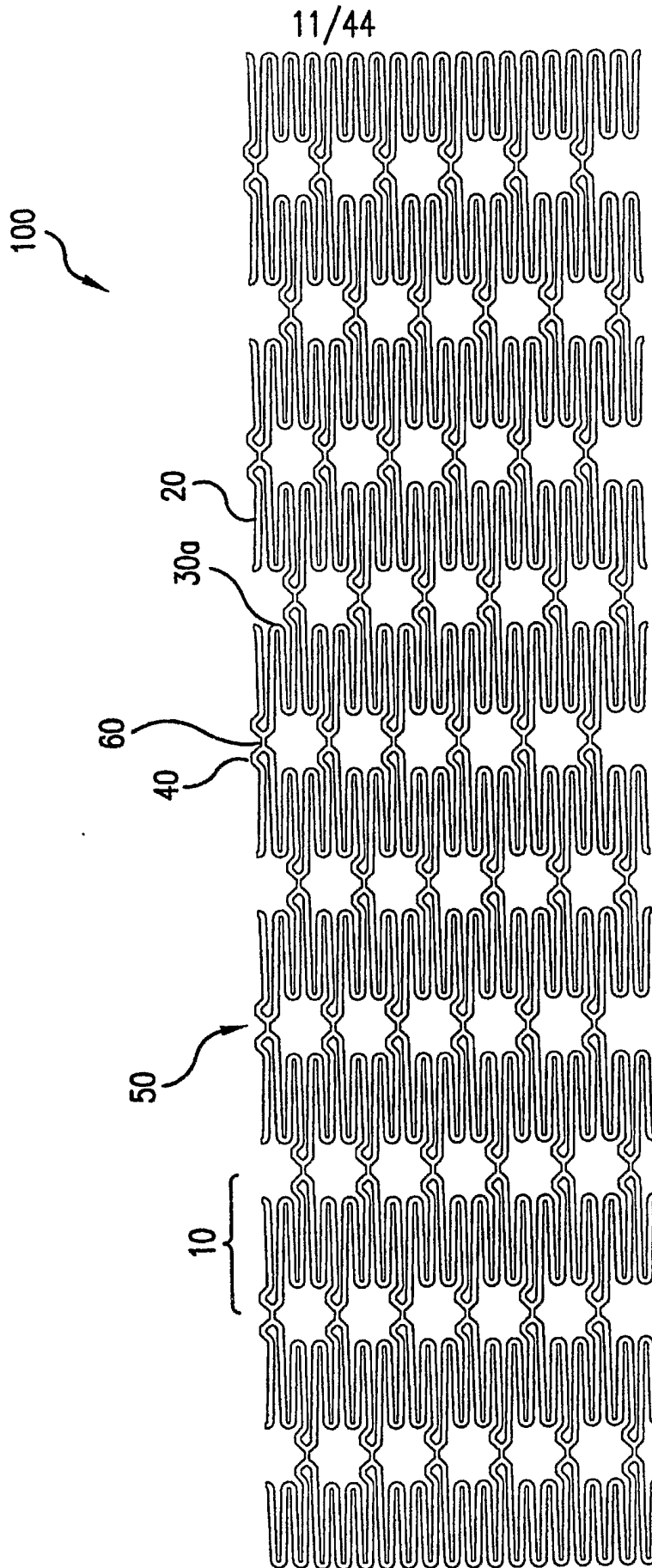

FIG.7

RO/US 11/07703

12/44

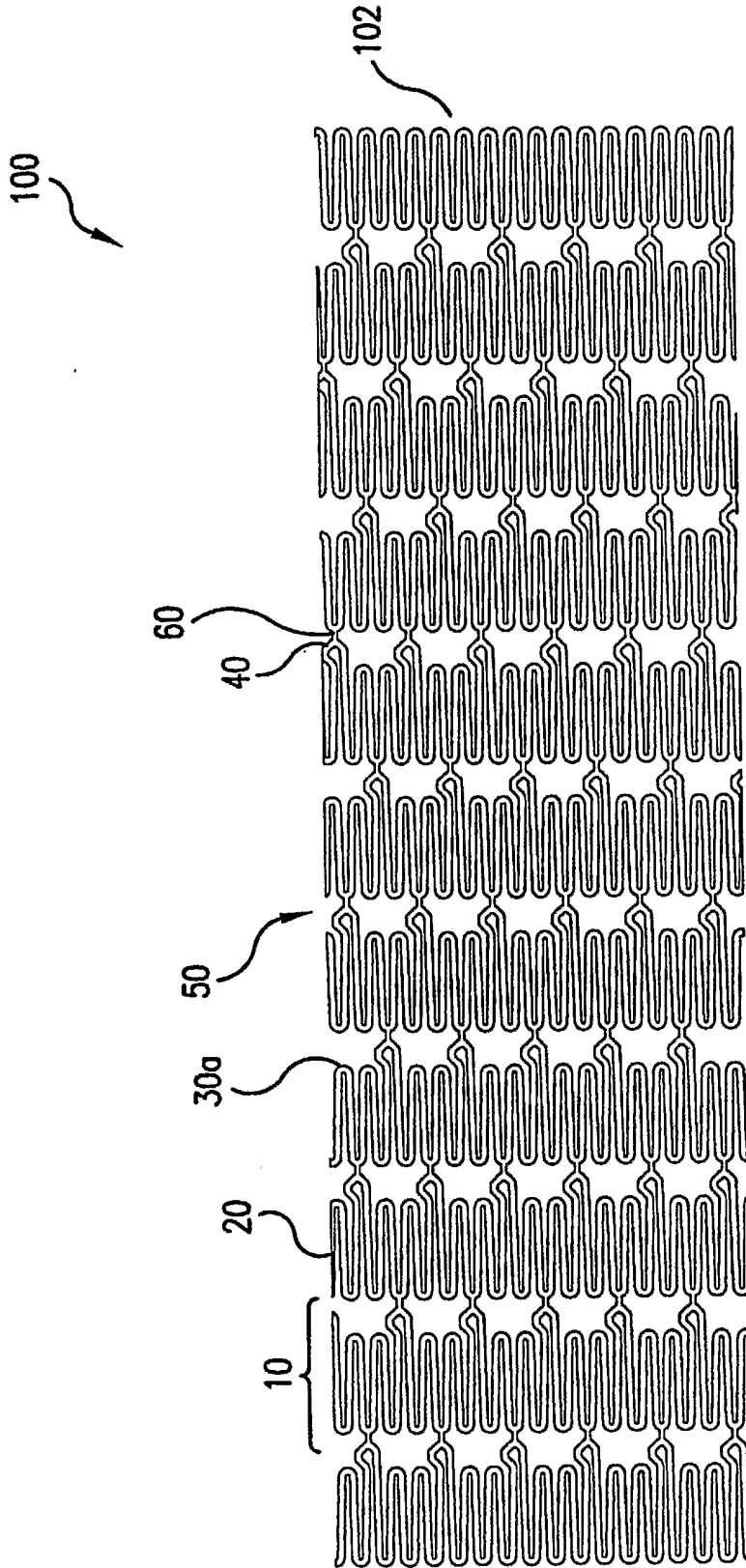

FIG.8

PCT/US03/14167 RO/US 11/07703

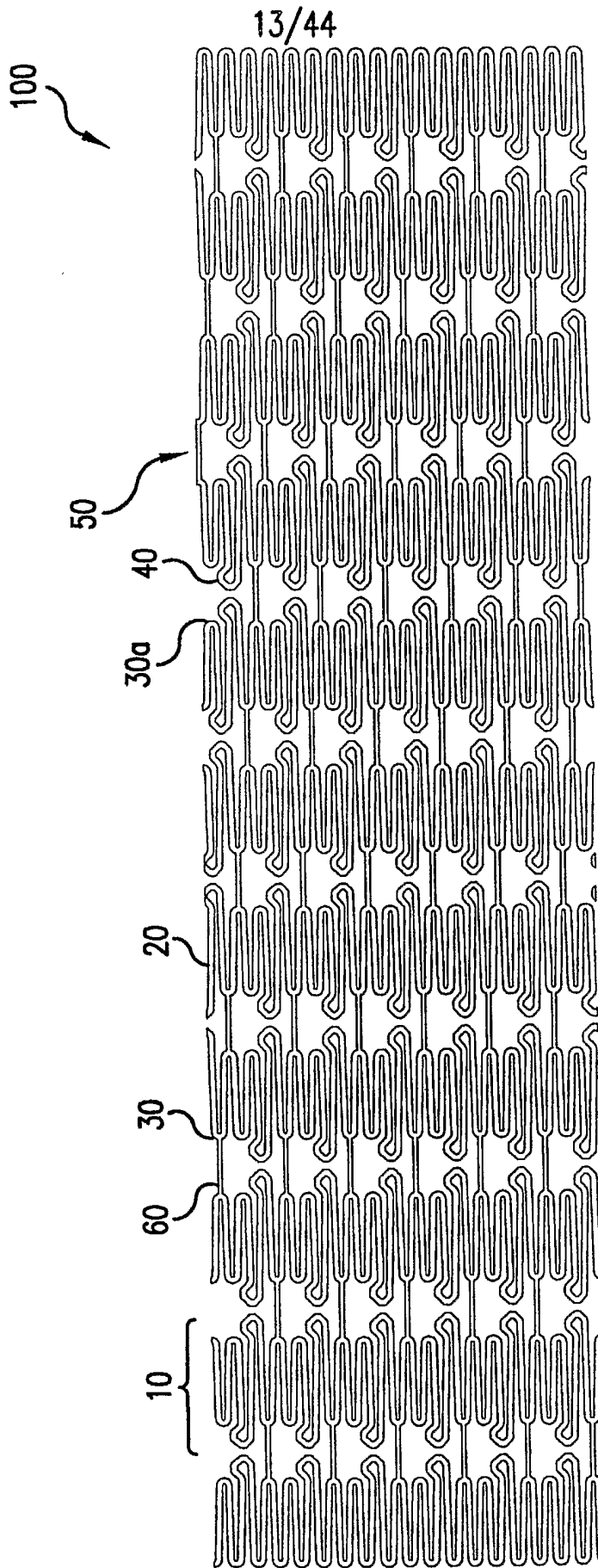

FIG. 9

RO/US 11/07703

14/44

100

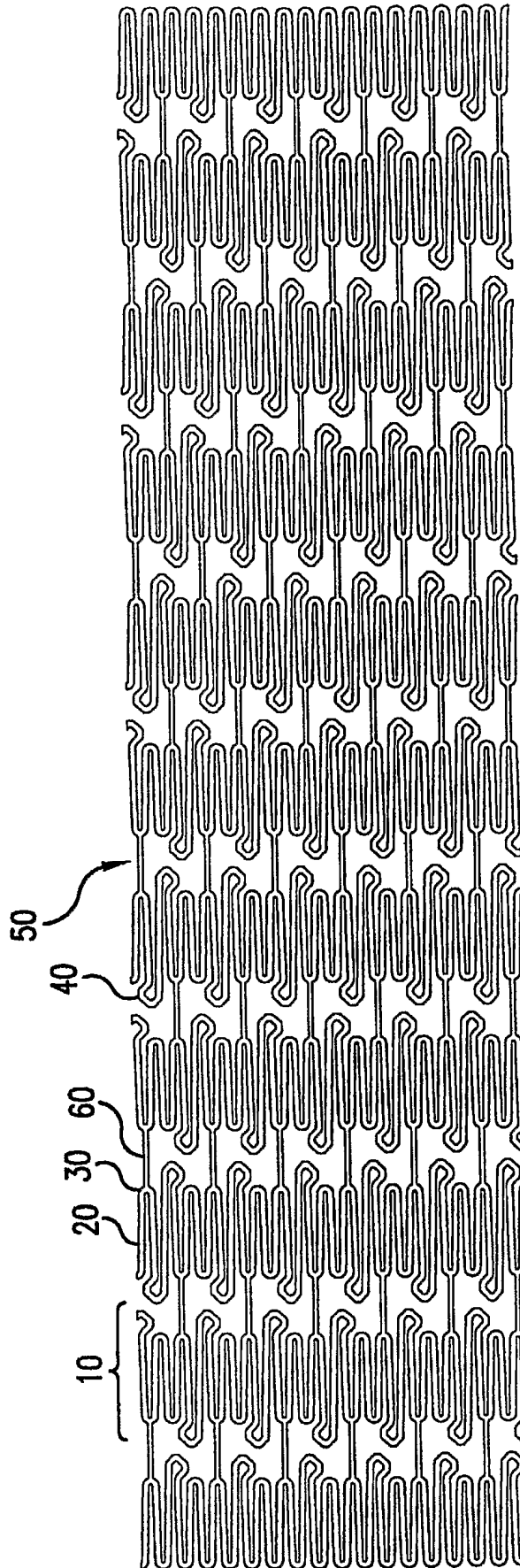

FIG.10

PATENT APPLICATION NO. PCT/US 11/07703

15/44

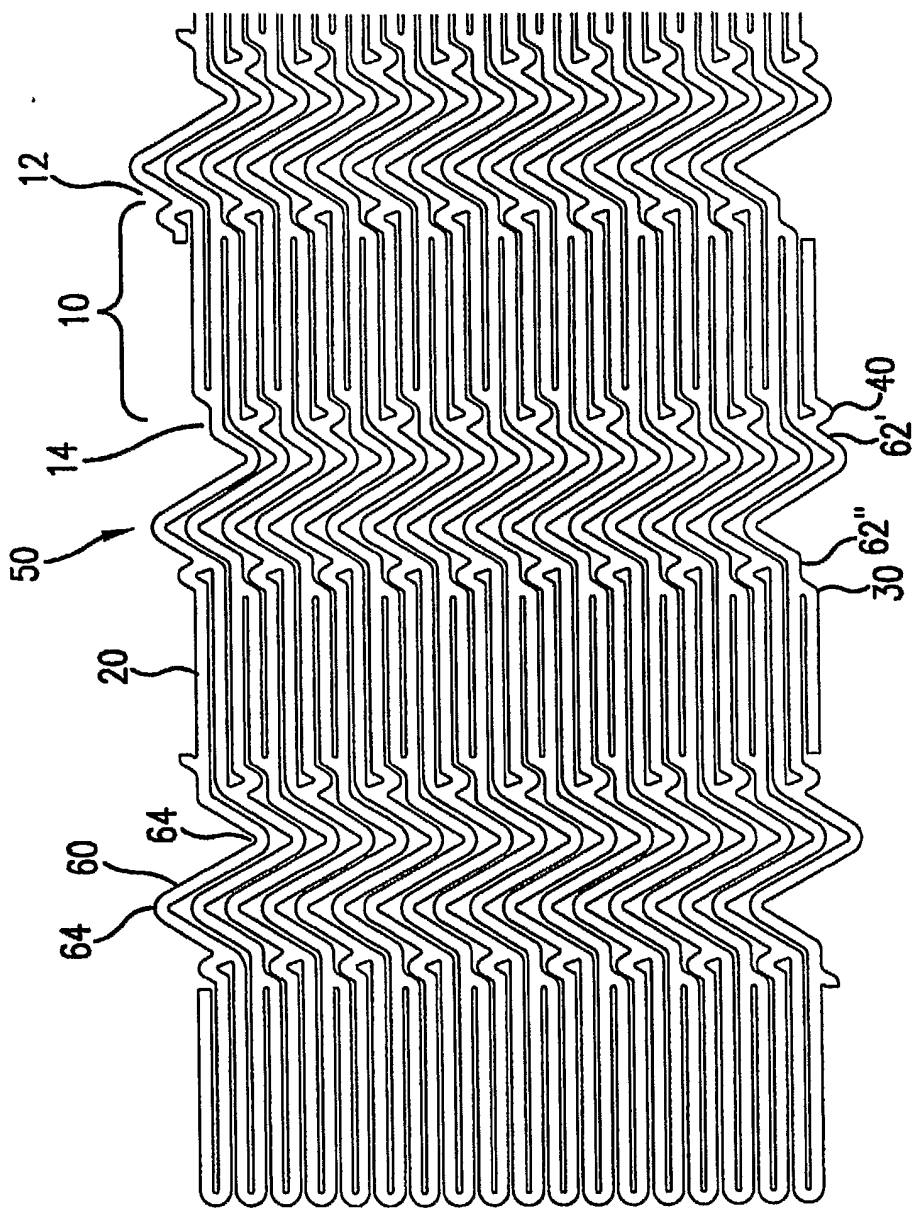

FIG.11

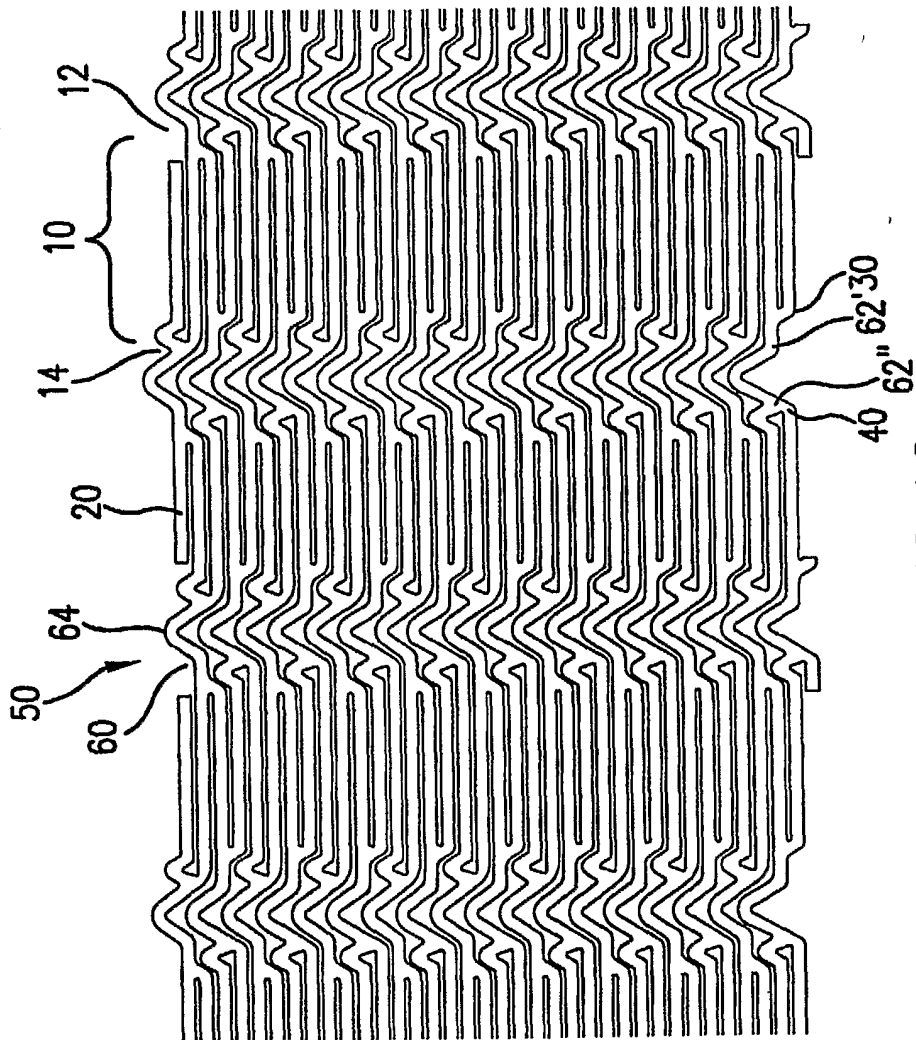

FIG. 12a

RO/US 11/07/03

17/44

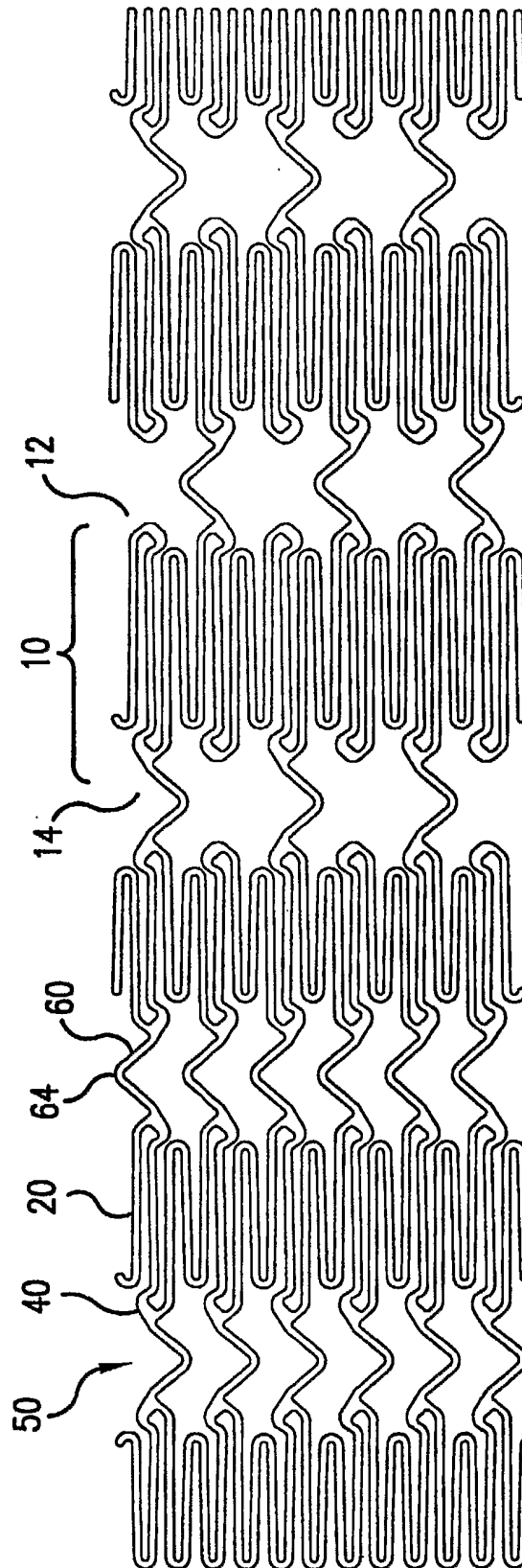

FIG.12b

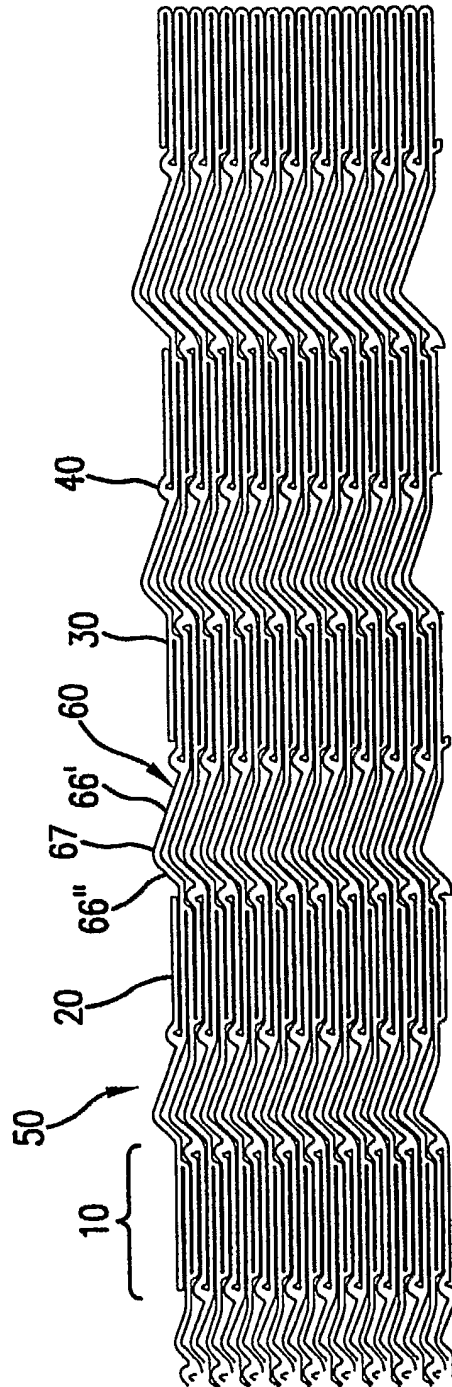

FIG.13

NO. 19/44 PCT/US 11/07/03

19/44

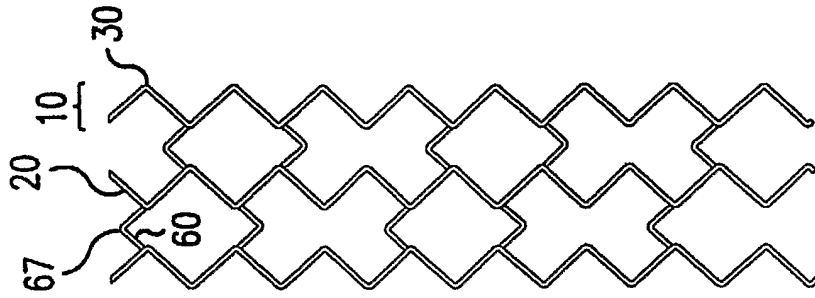

FIG. 14c

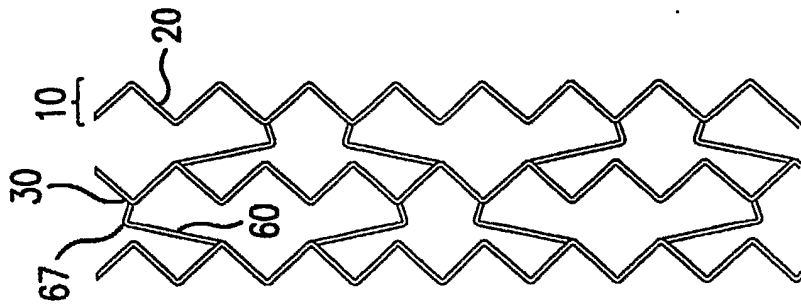

FIG. 14b

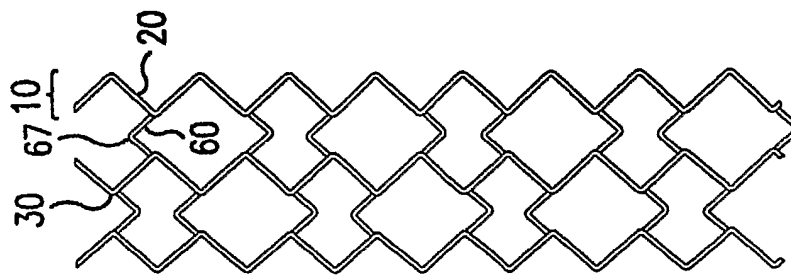

FIG. 14a

FIG. 14e

20/44

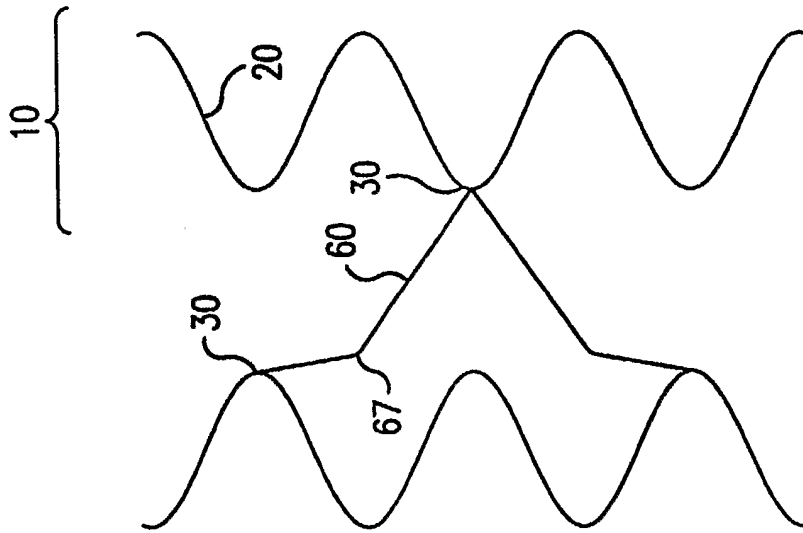

FIG. 14e

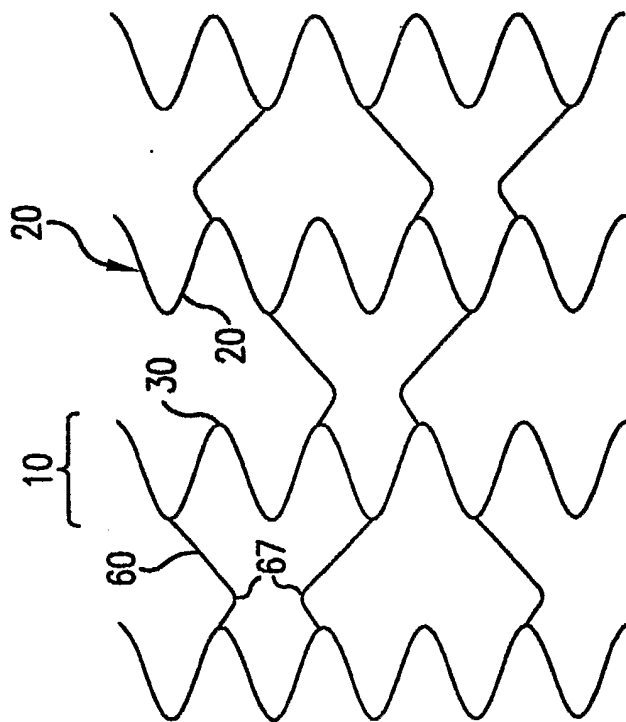

FIG. 14d

RO/US 11/07/03

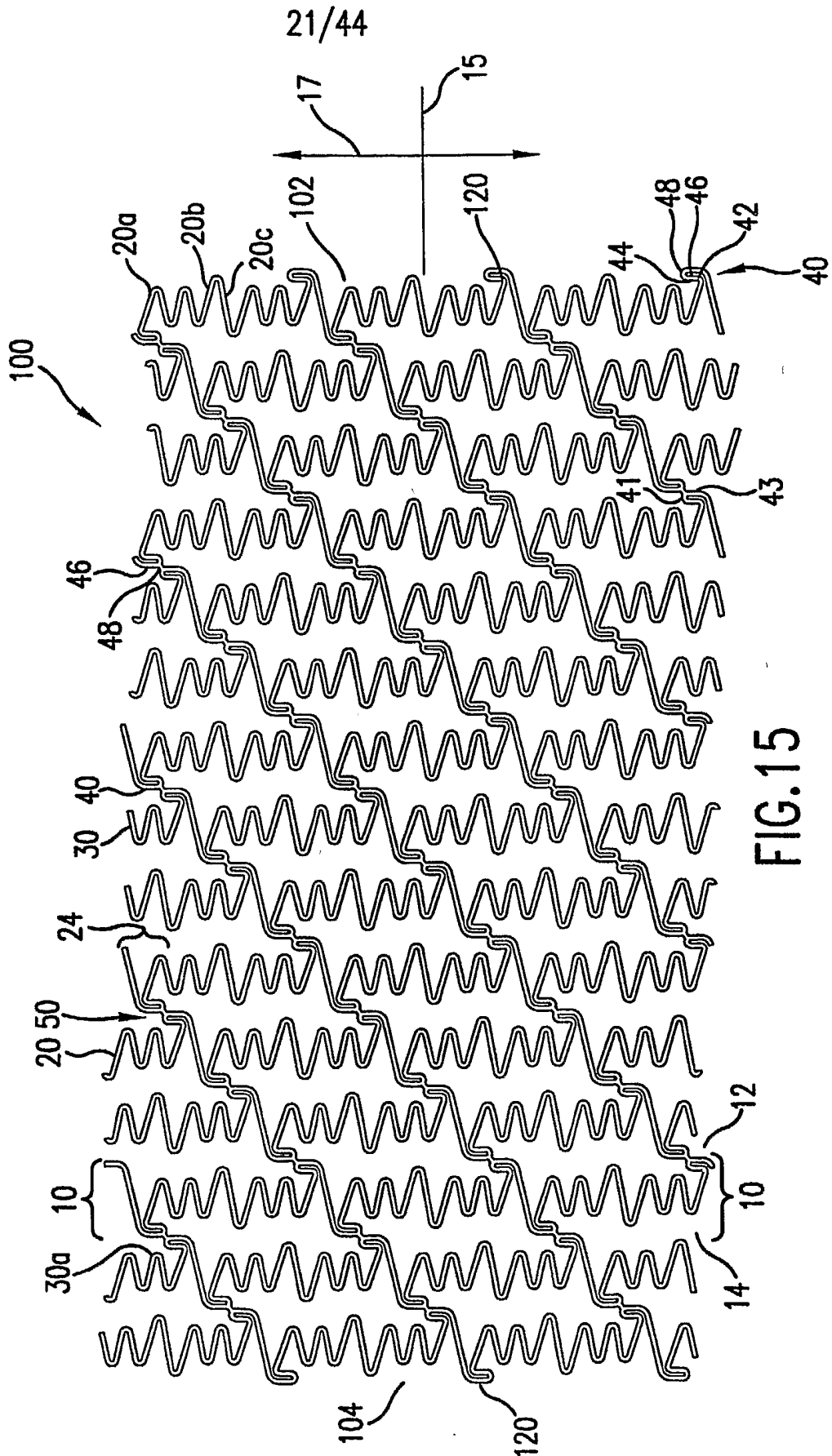

FIG.15

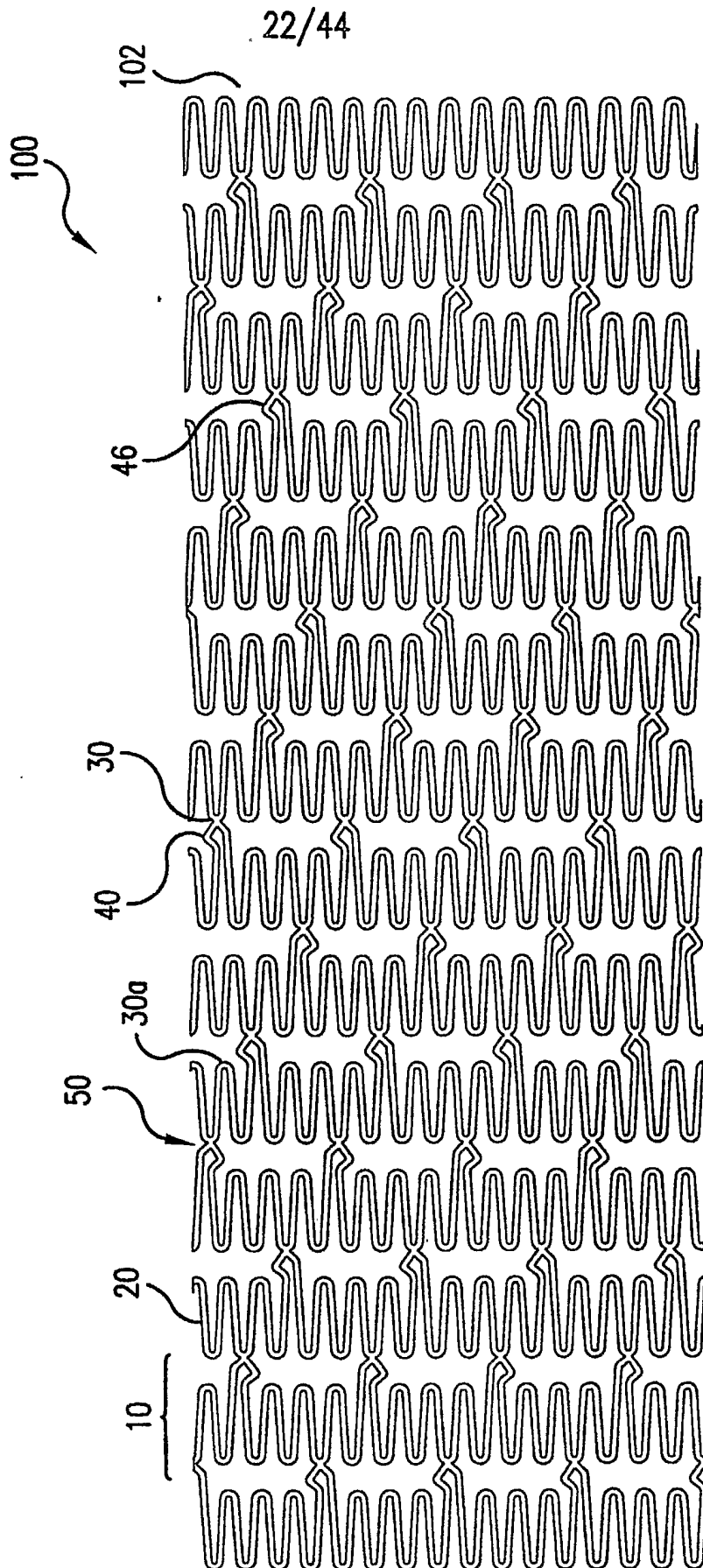

FIG. 16

23/44

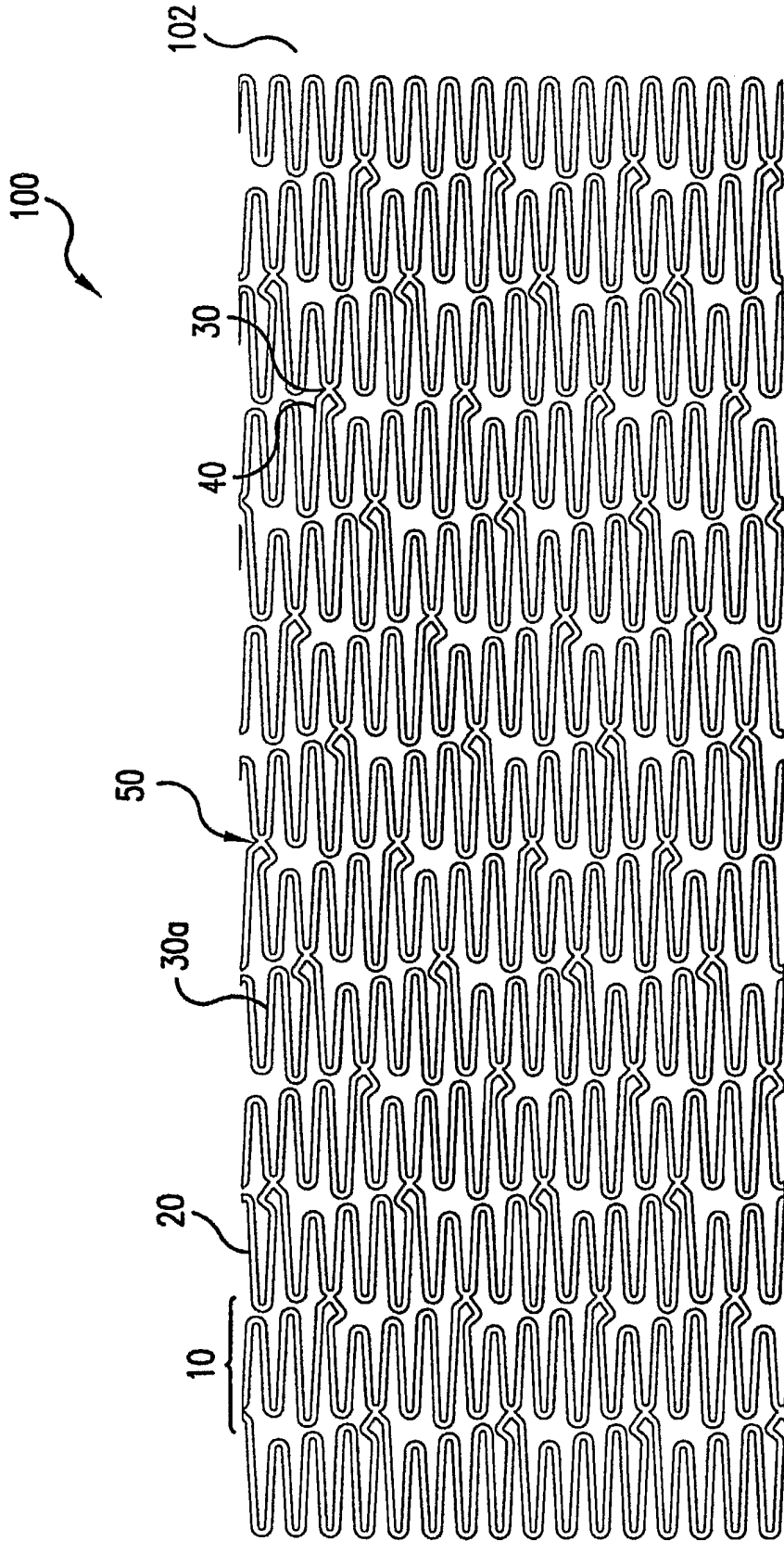

FIG.17

PCT/US03/14167 RO/US 11/07/03

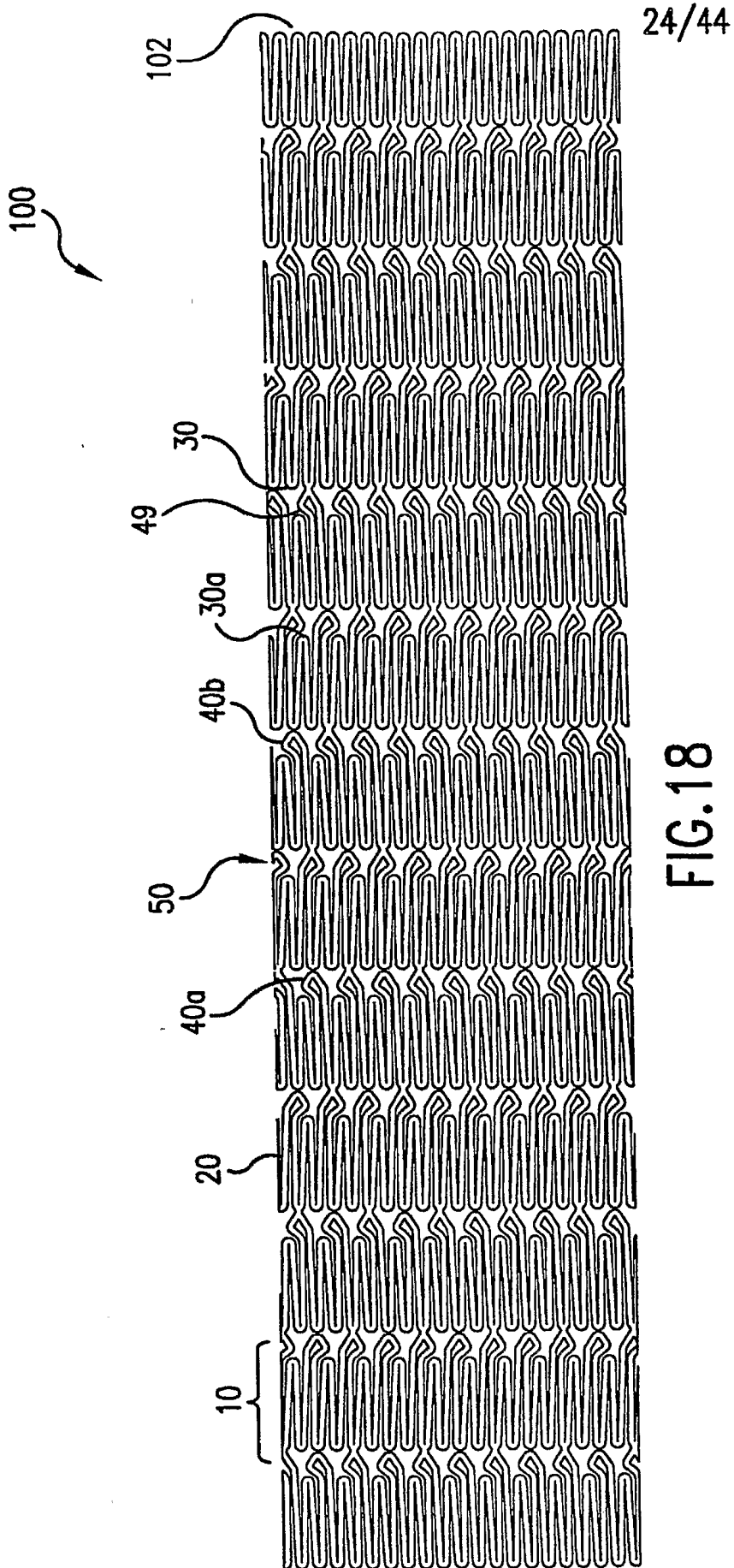

FIG.18

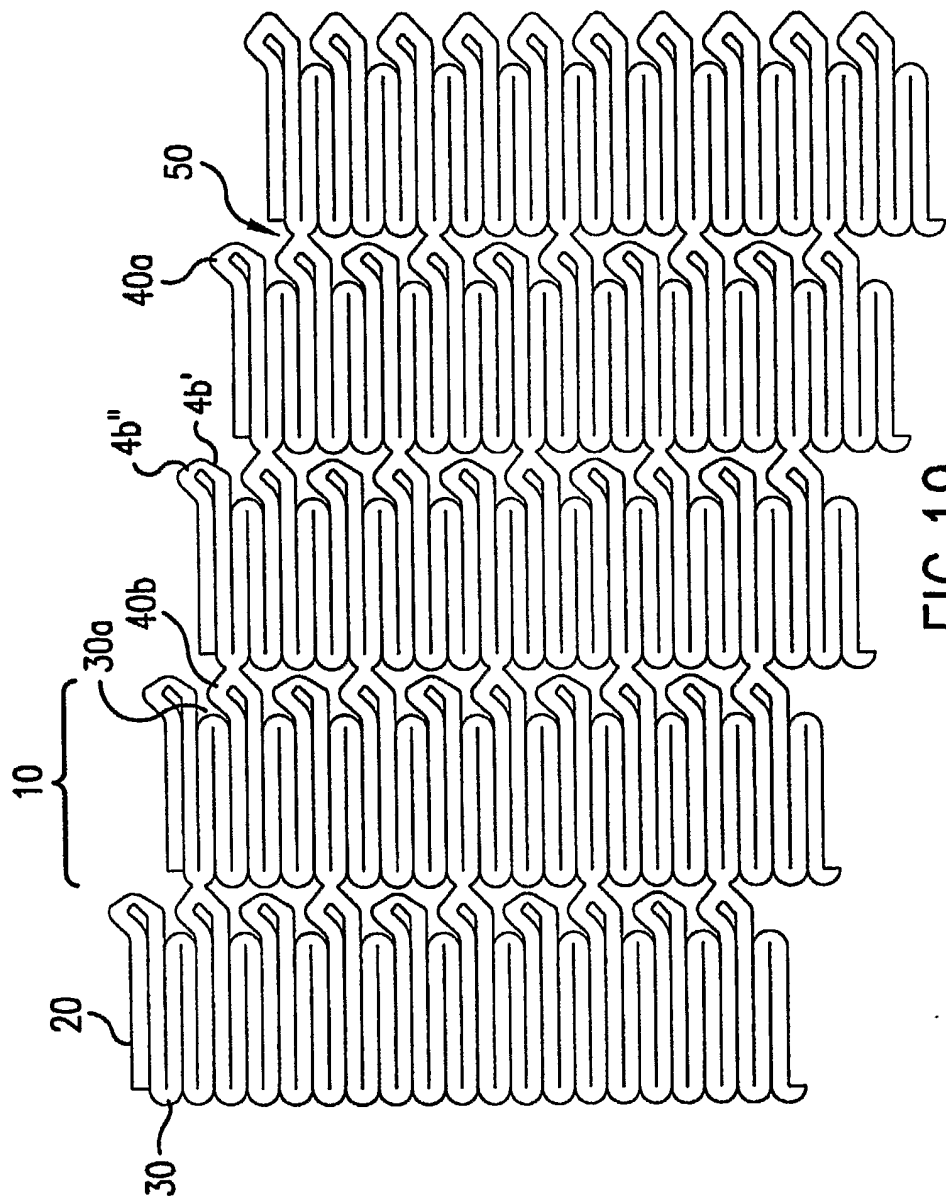

FIG. 19

RO/US 11/07703

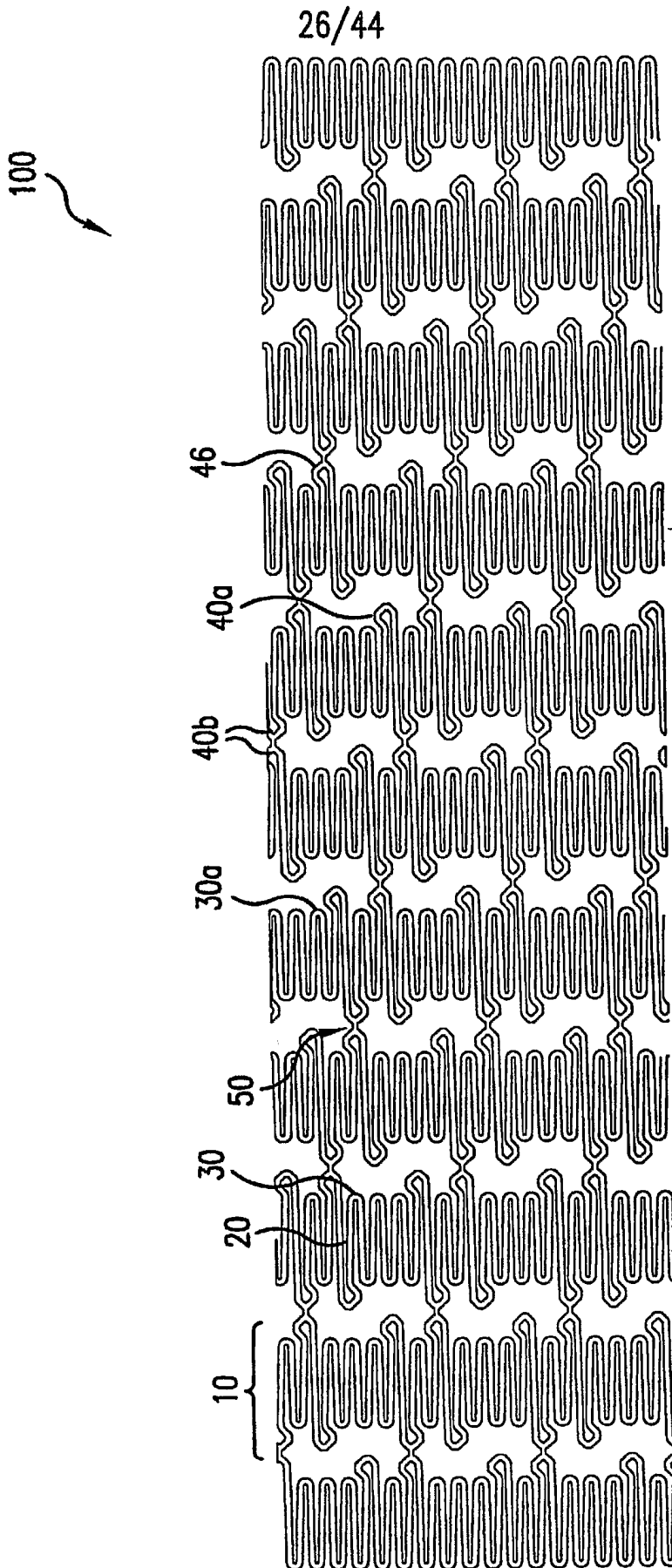
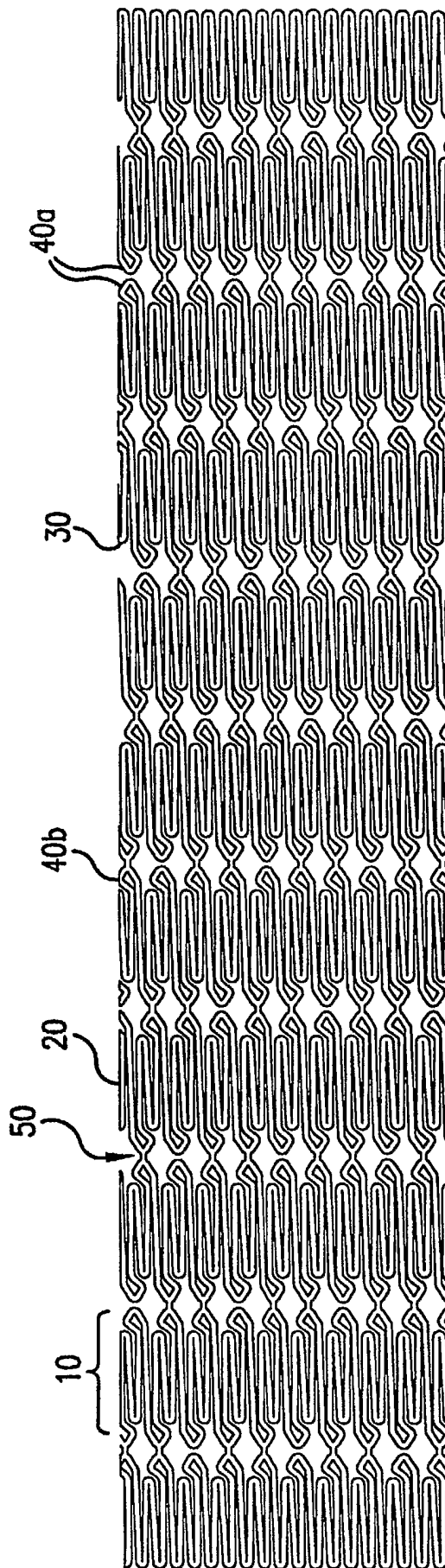

FIG.20

PCT/US03/14167 RO/US 11/07/03

100



27/44

FIG.21

PCT/US 11/07/03

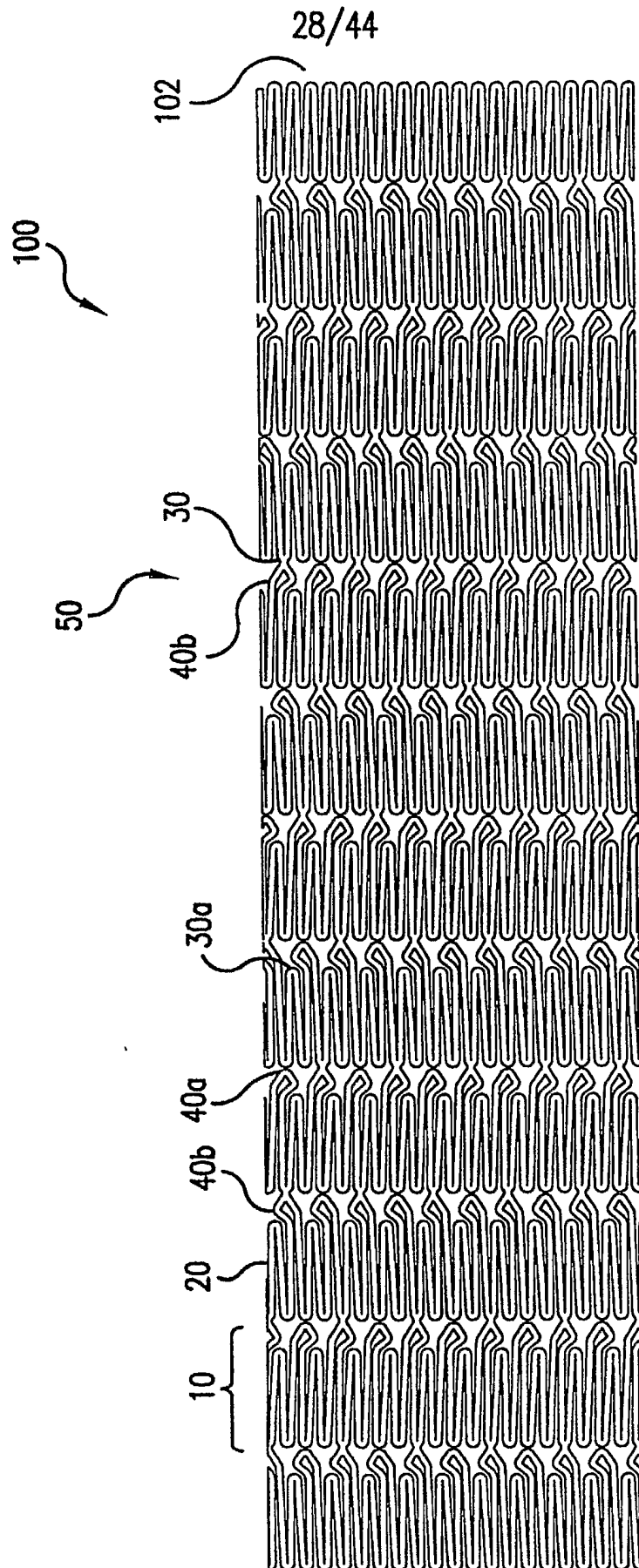

FIG. 22

RO/US 11/07/03

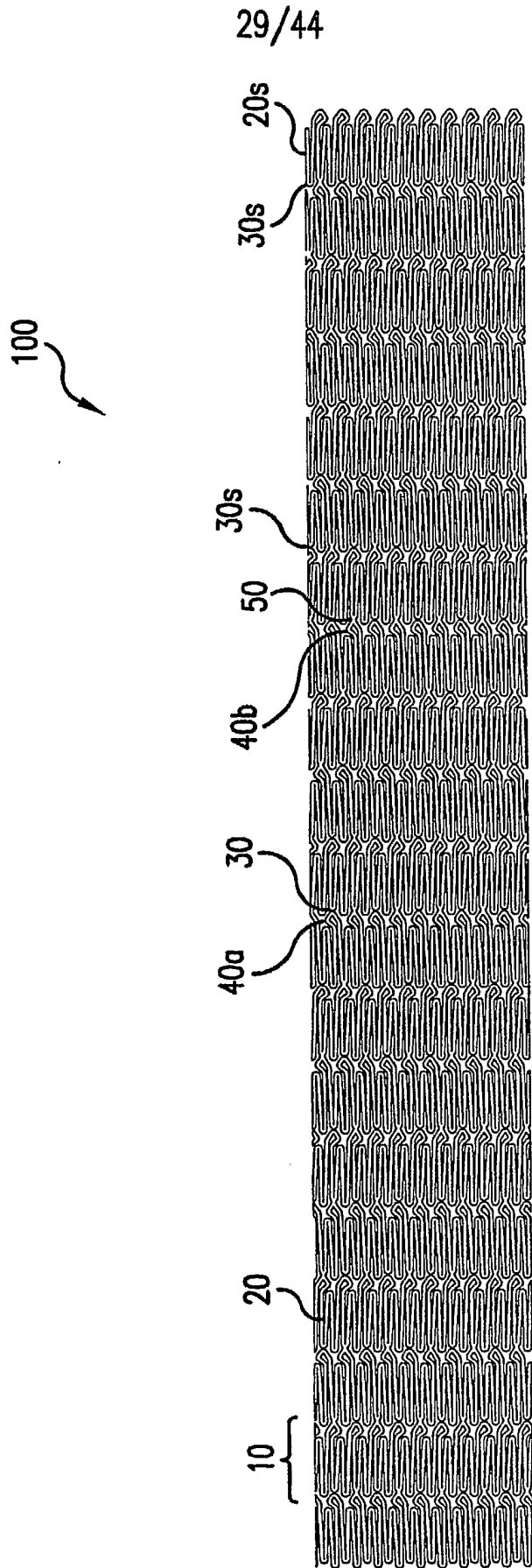

FIG.23

RO/US 11/07/03

30/44

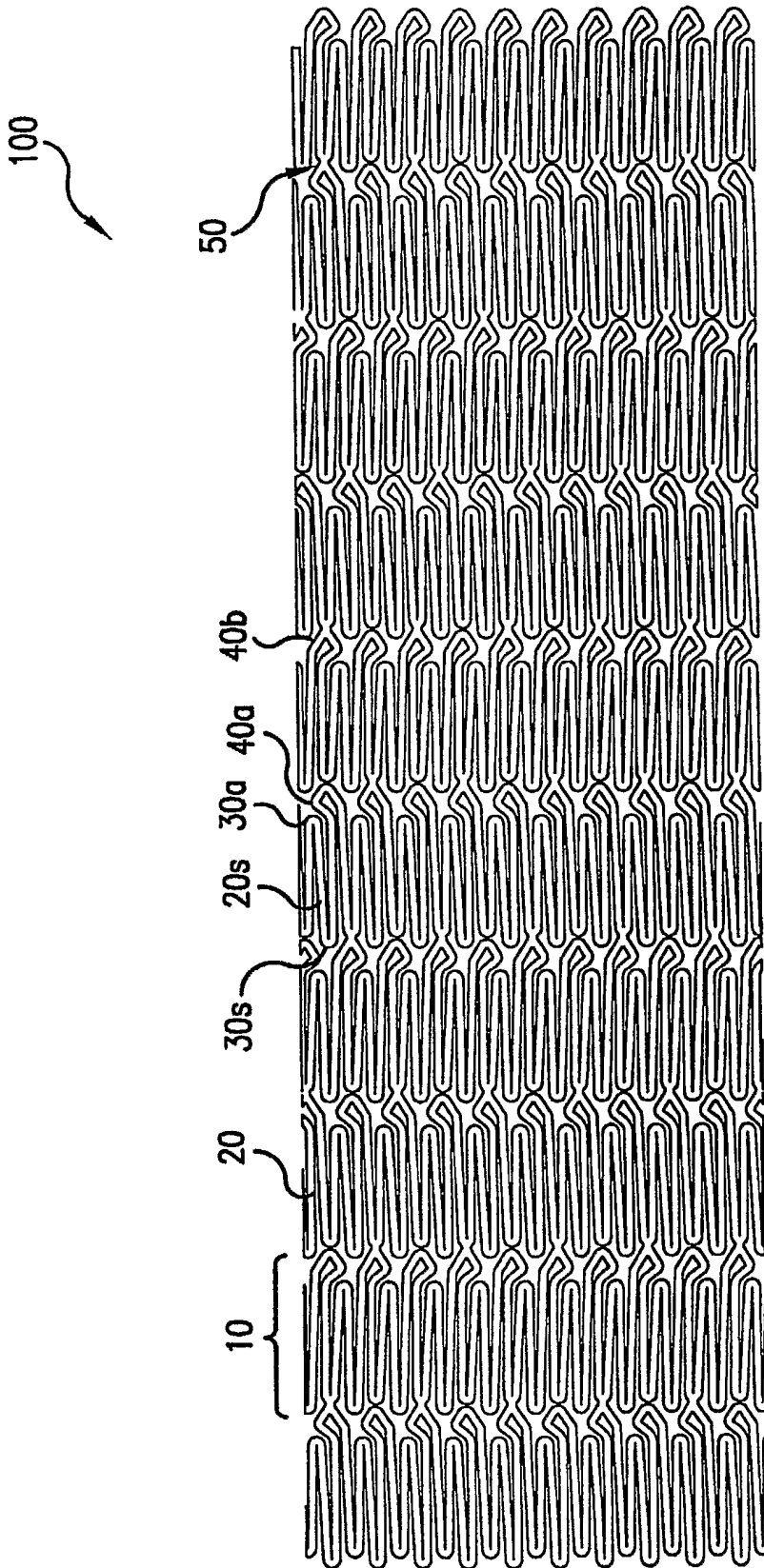

FIG. 24

RO/US 11/07/03

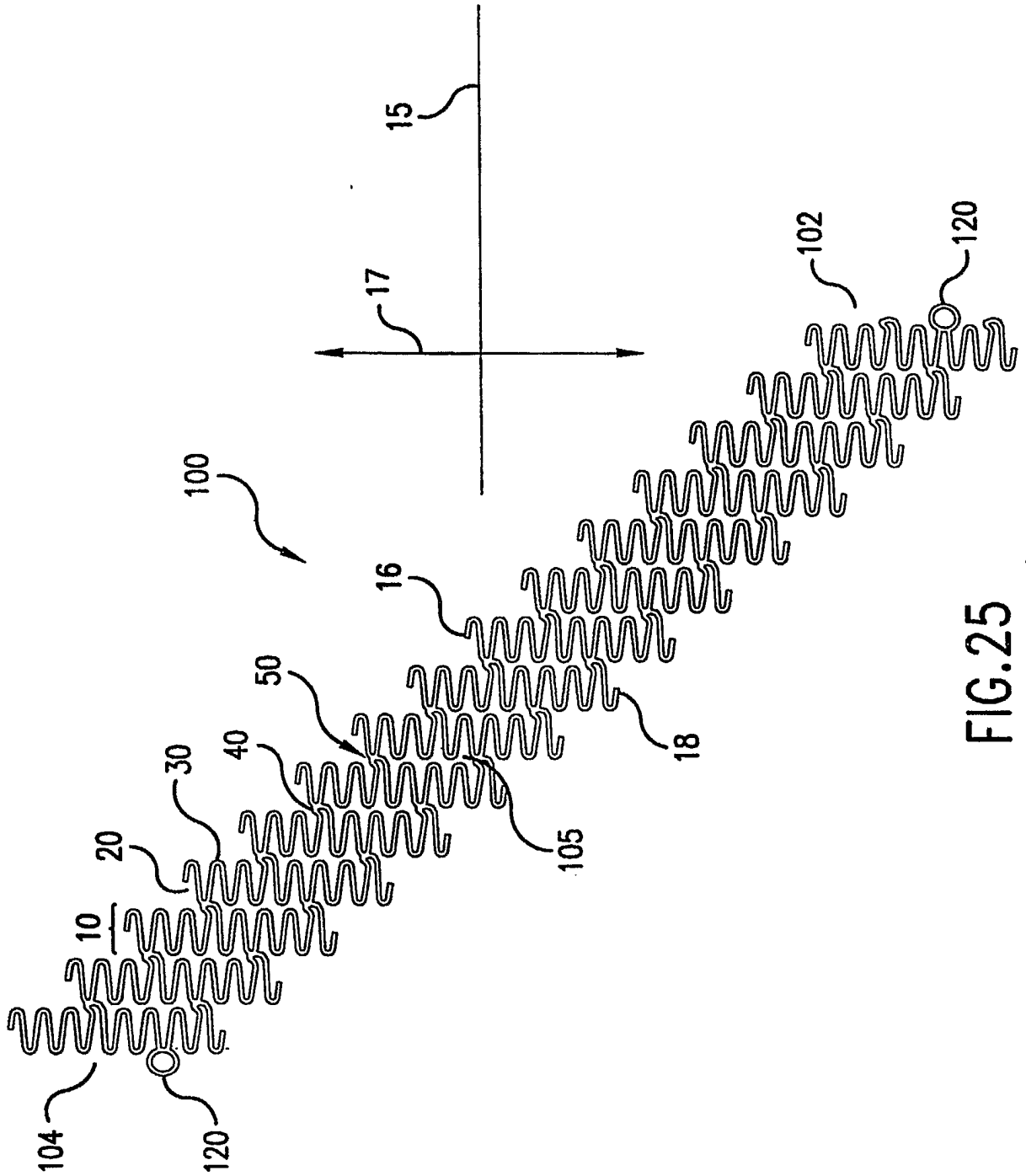

FIG.25

RO/US 11/07/03

32/44

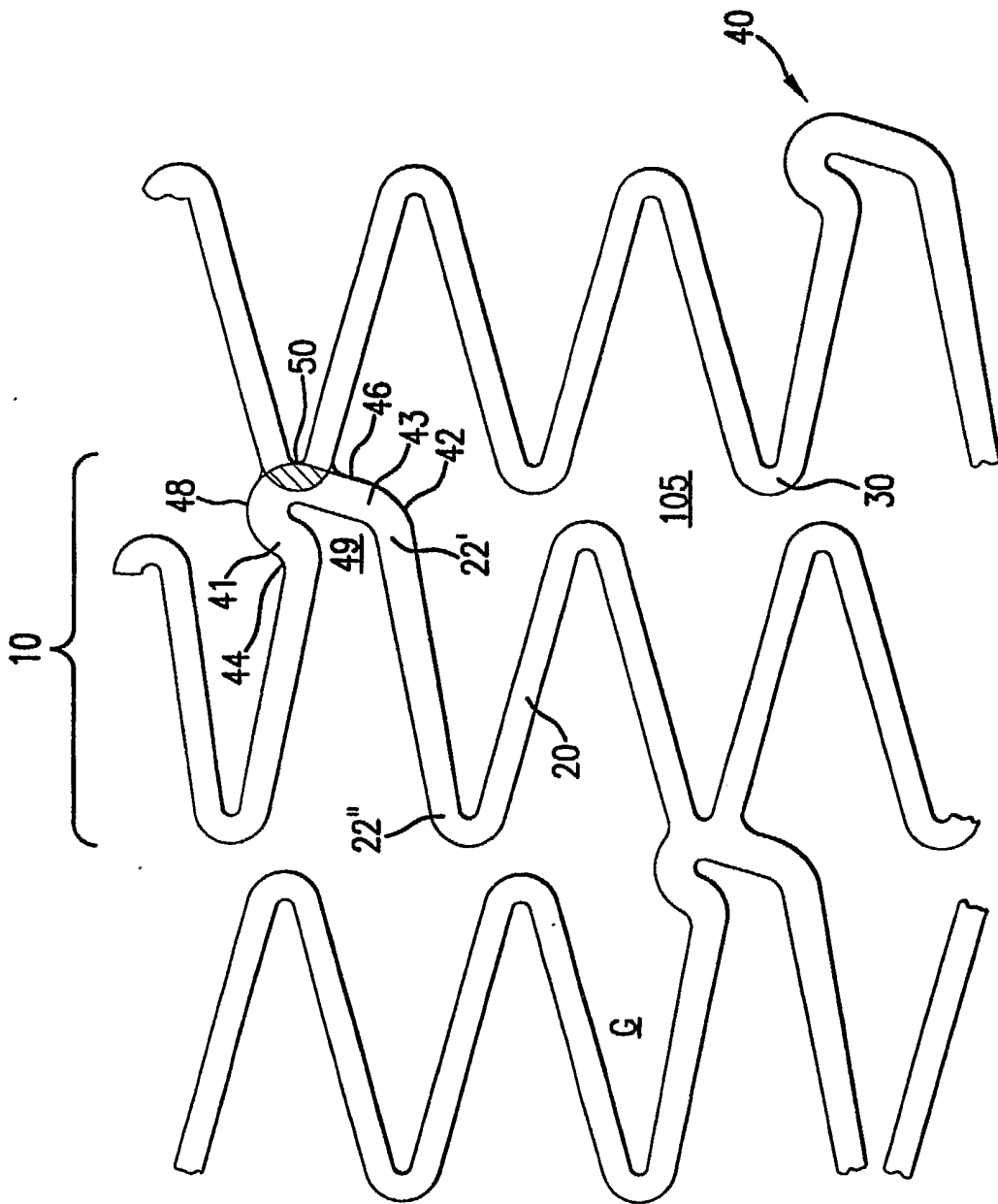

FIG.26

RO/US 11/07/03

33/44

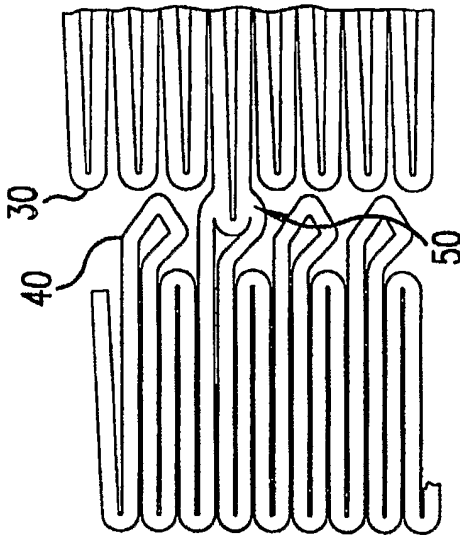

FIG. 27c

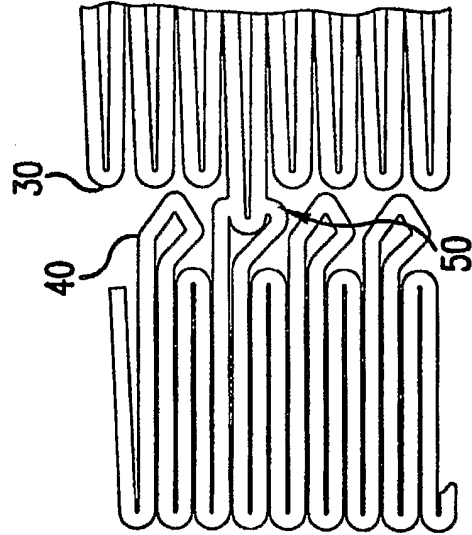

FIG. 27d

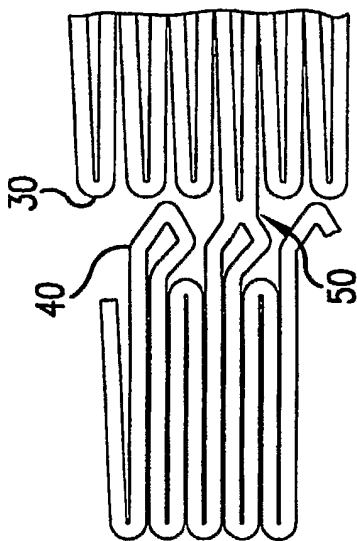

FIG. 27a

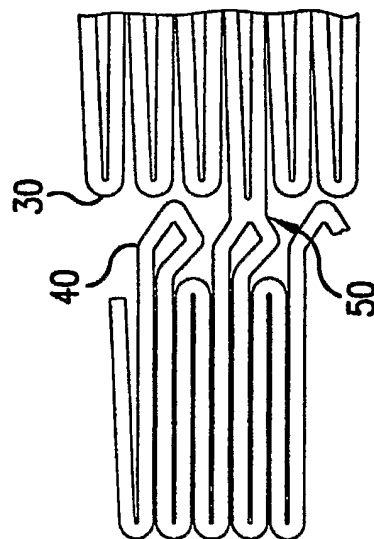

FIG. 27b

RO/US-11/07/03

34/44

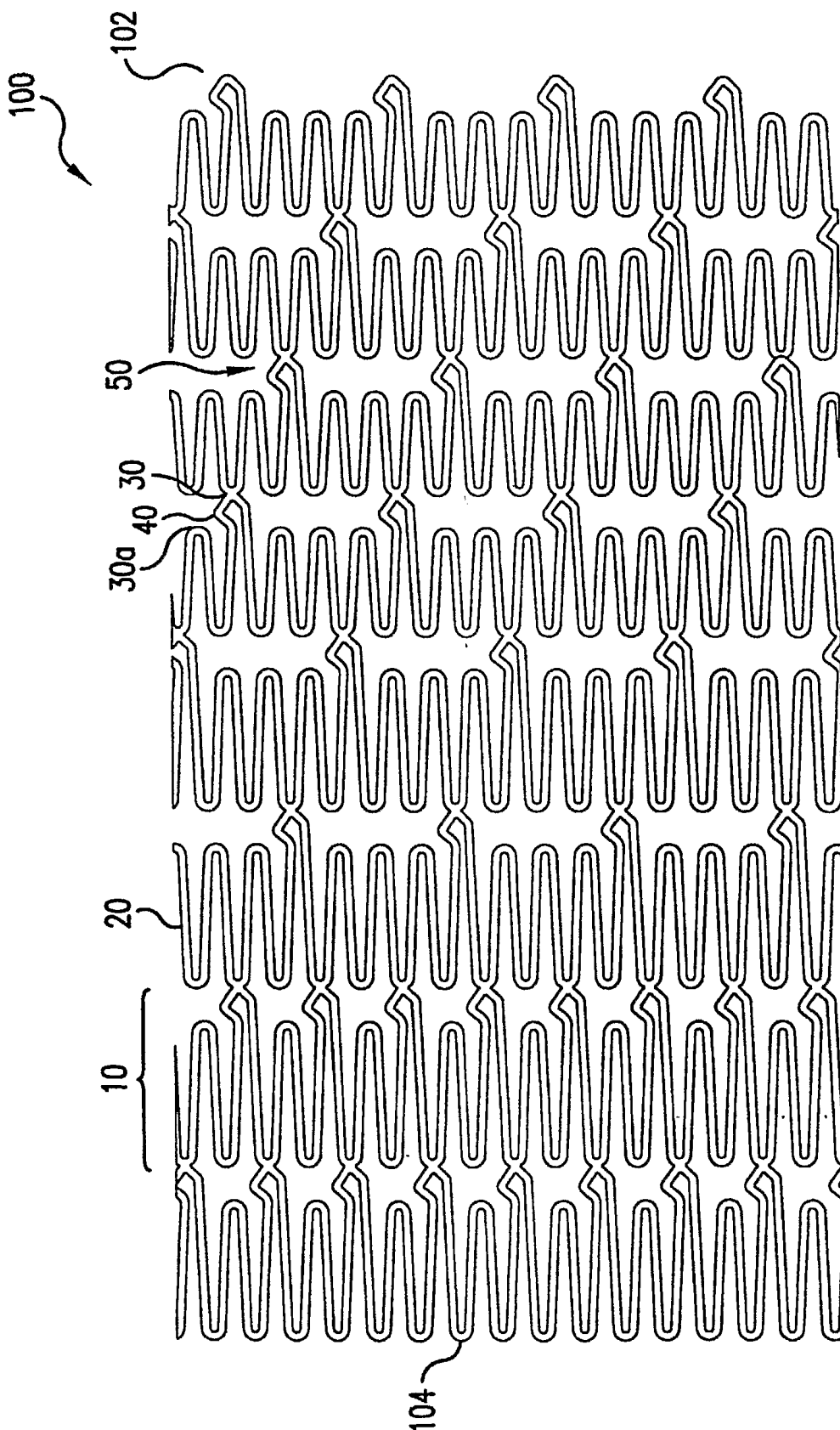

FIG.28

RO/US 11/07/03

35/44

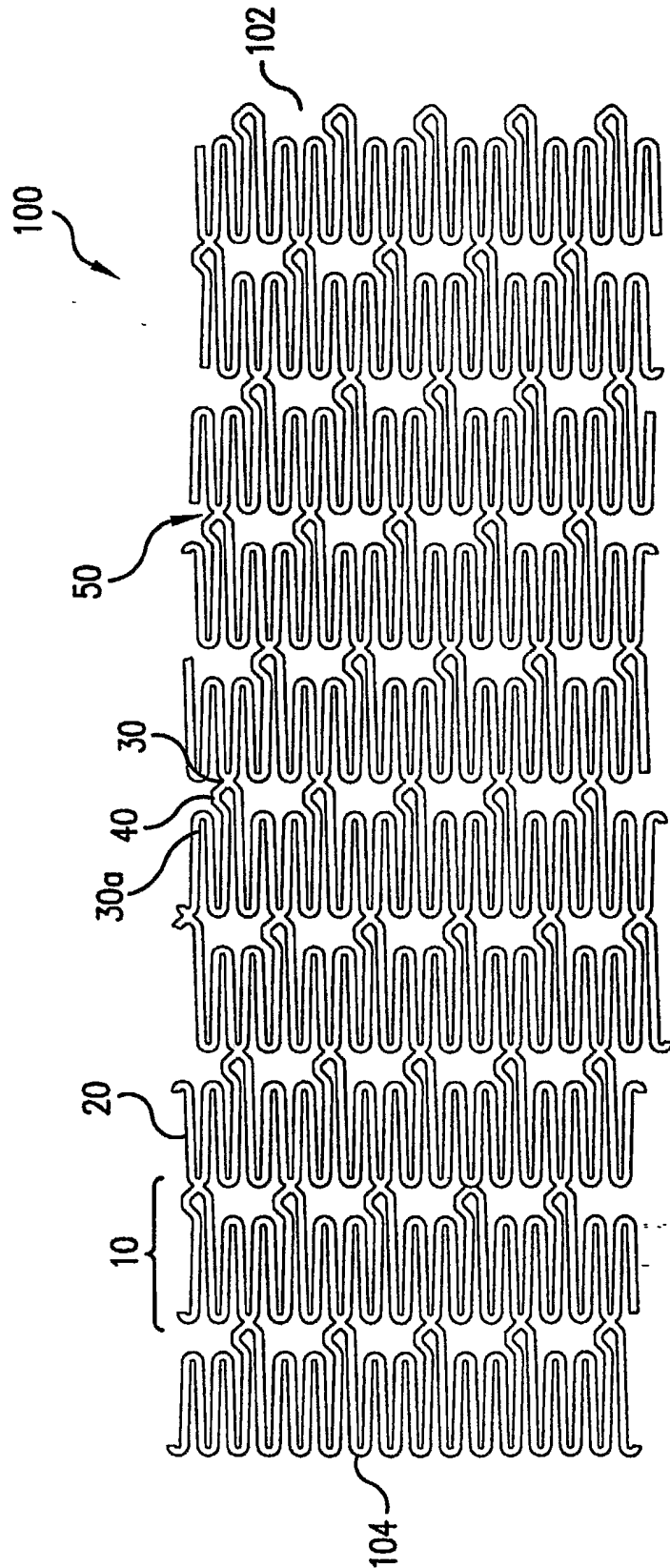

FIG. 29a

PUBLISHED IN THE NAME OF THE INTERNATIONAL BUREAU OF PATENT COOPERATION
PCT/US03/14167
RO/US 11/07703

36/44

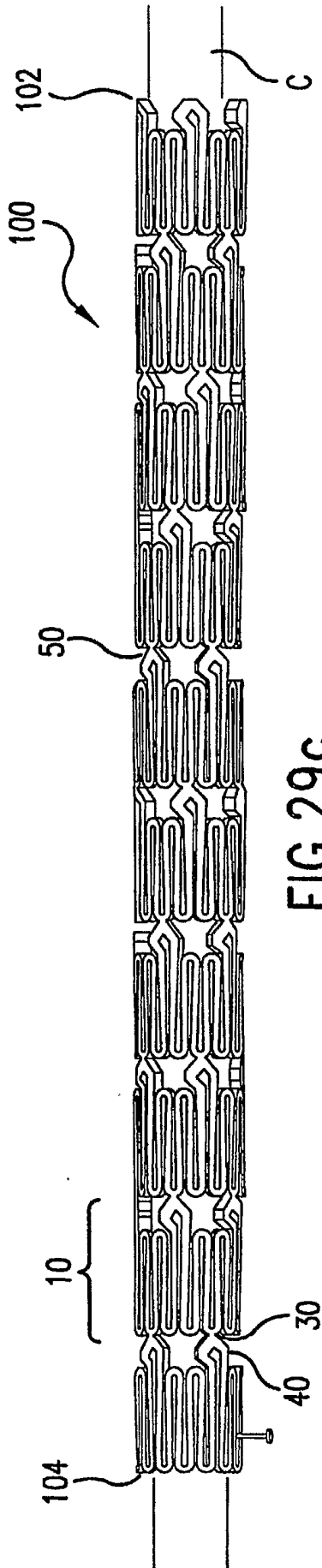

FIG. 29c

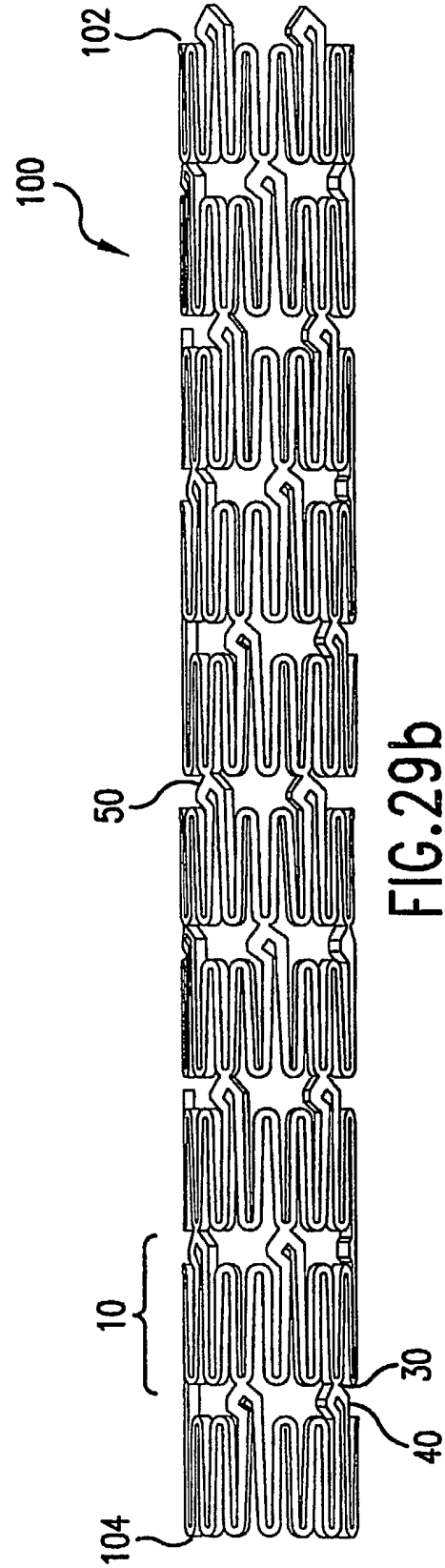

FIG. 29b

RO/US 11/07703

37/44

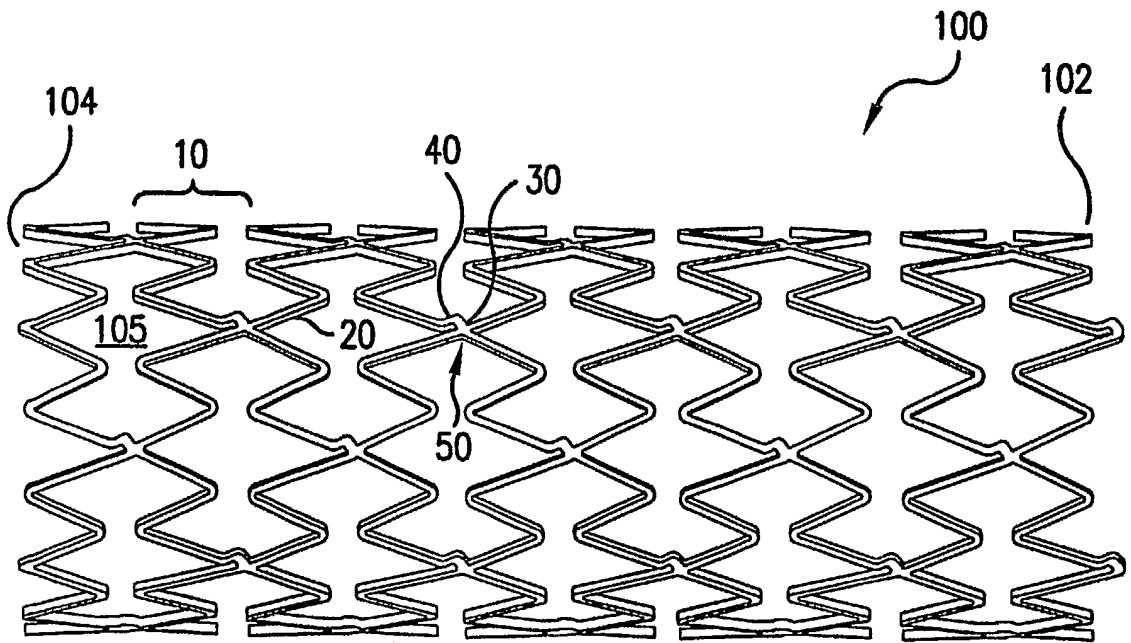

FIG.29d

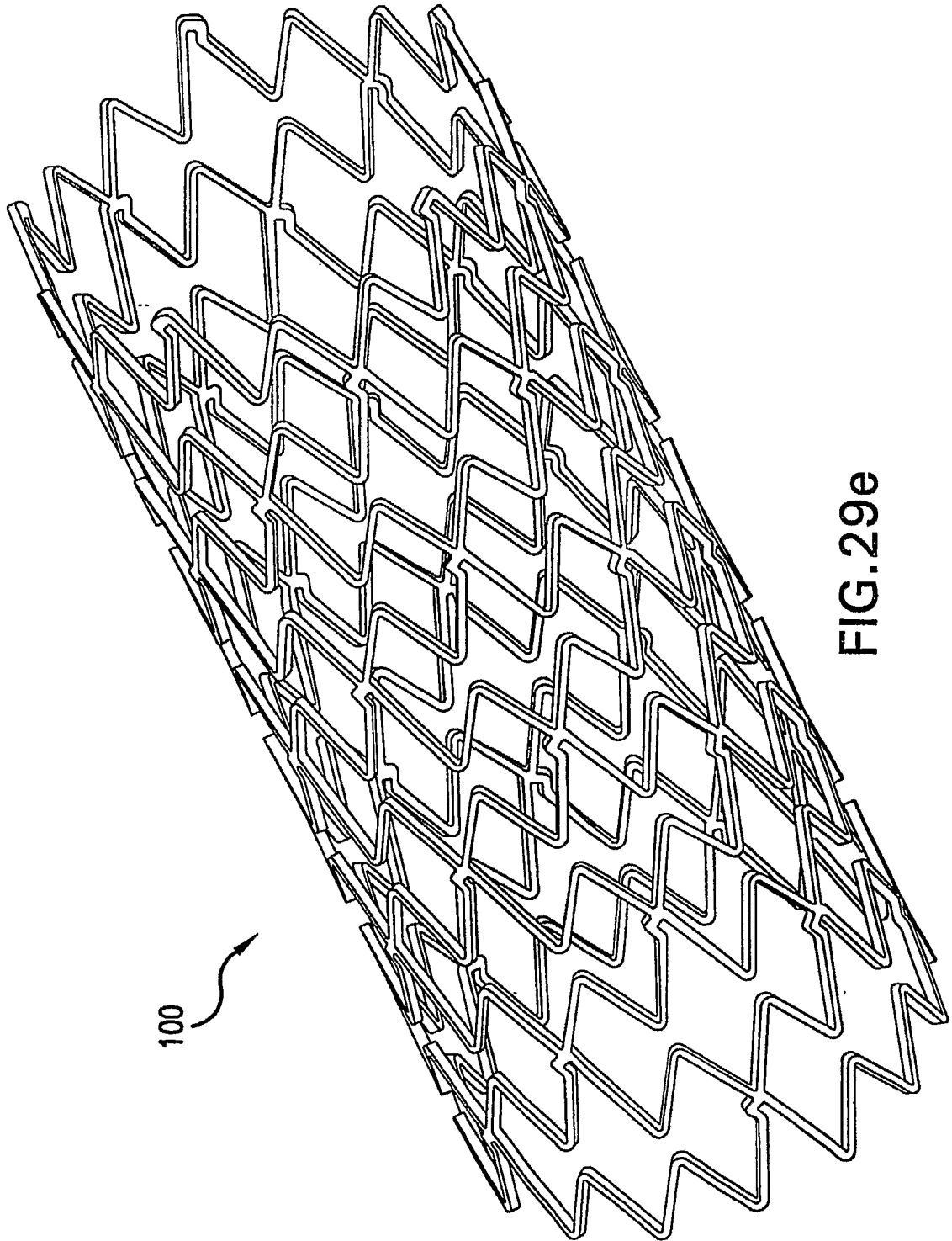

FIG. 29e

100

PCT/US03/14167 RO/US 11/07703

39/44

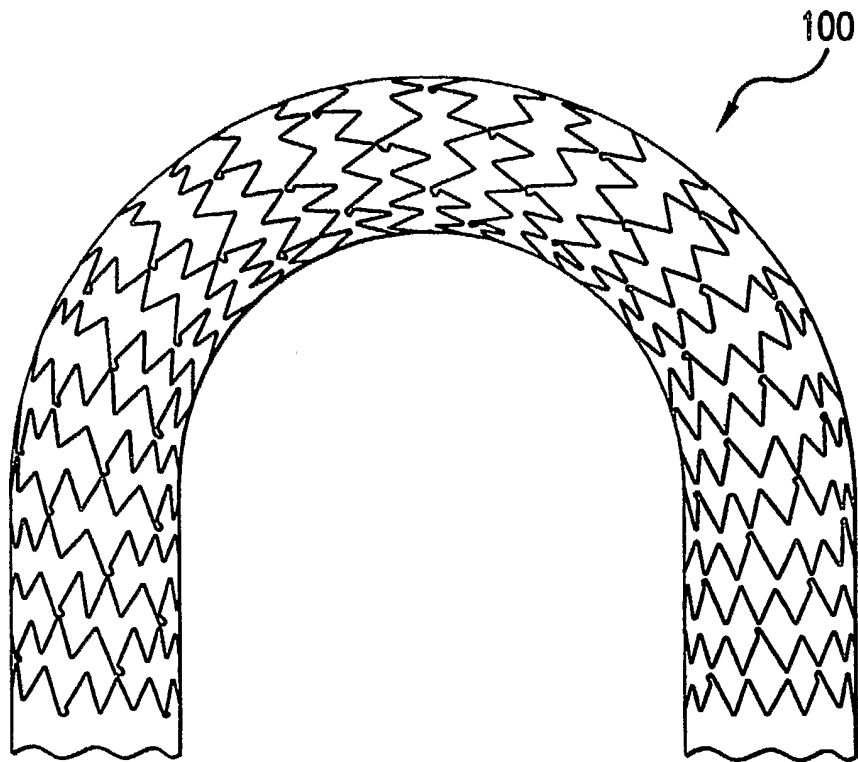

FIG.29f

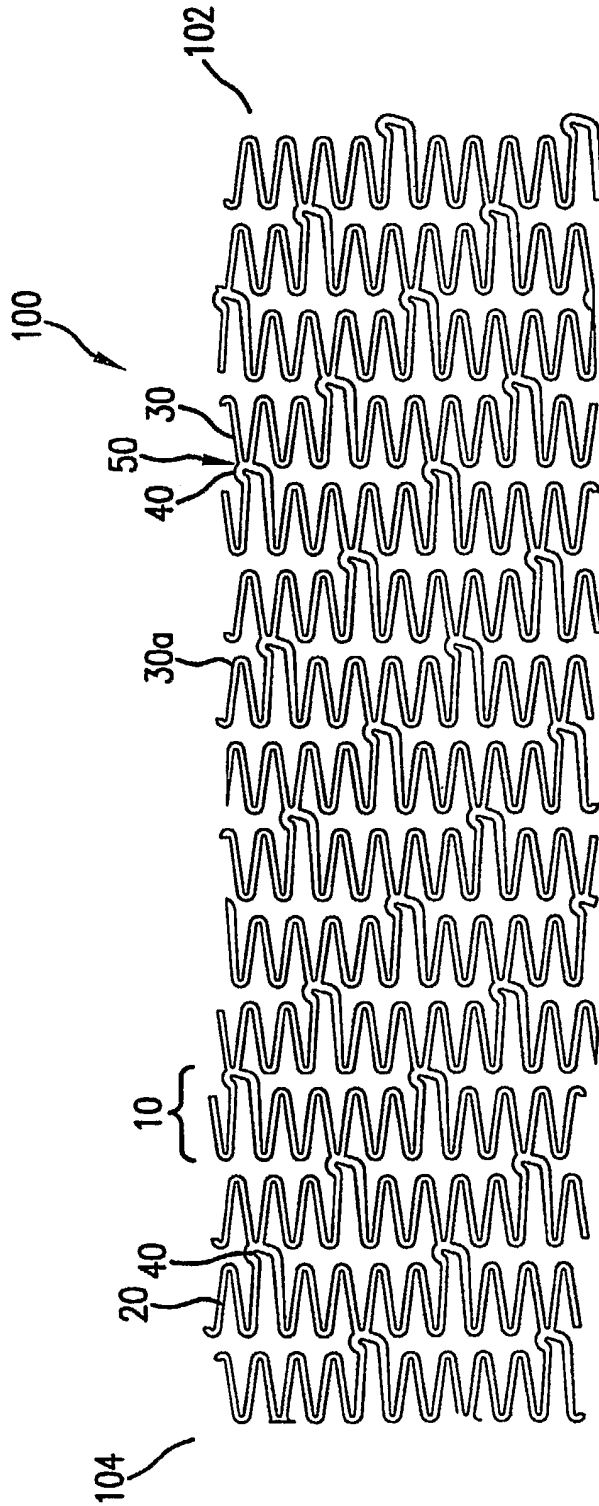

FIG. 30a

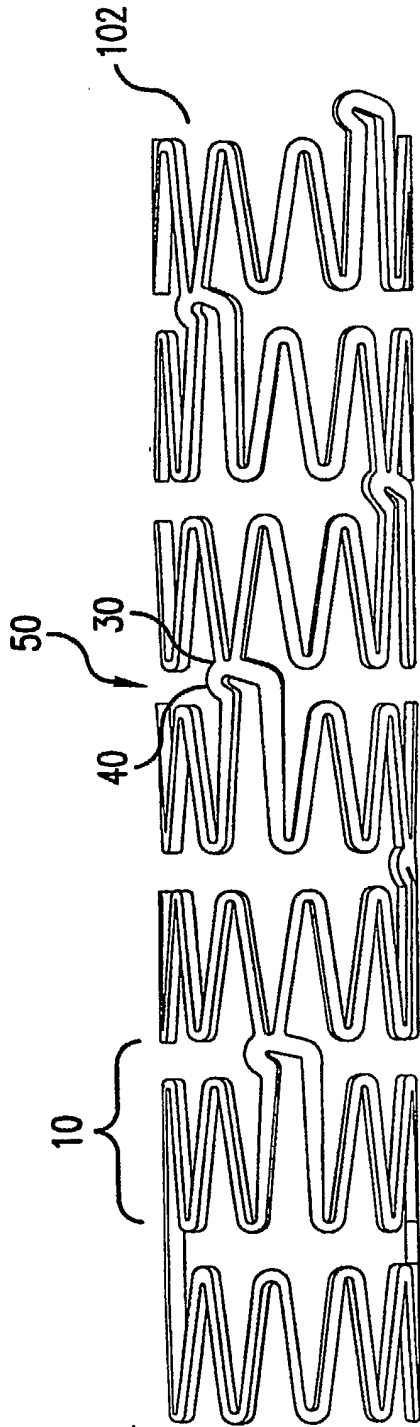

FIG. 30b

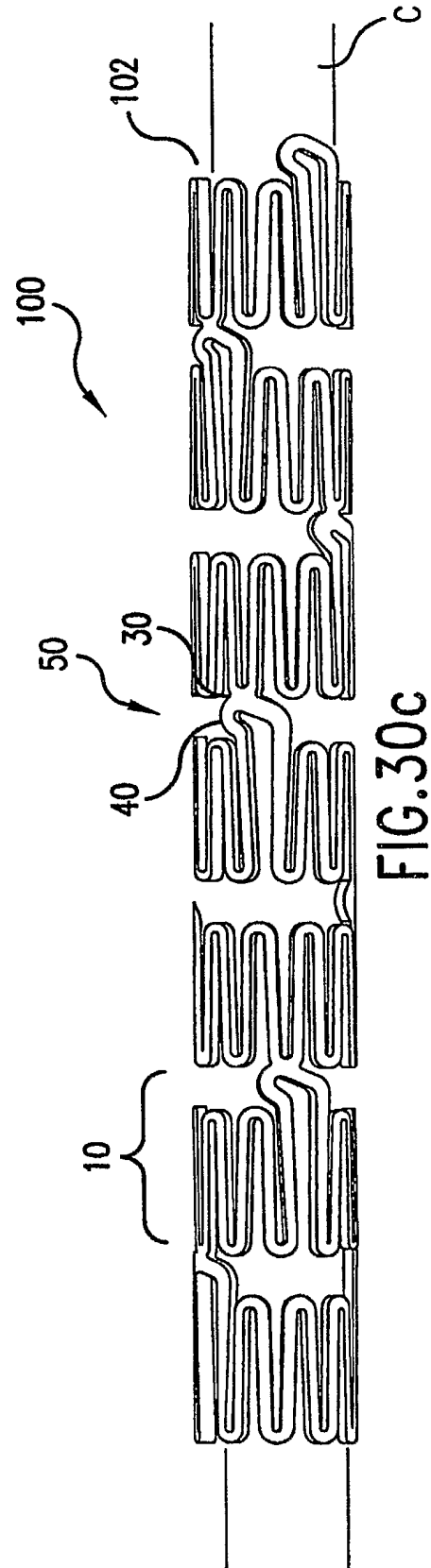

FIG. 30c

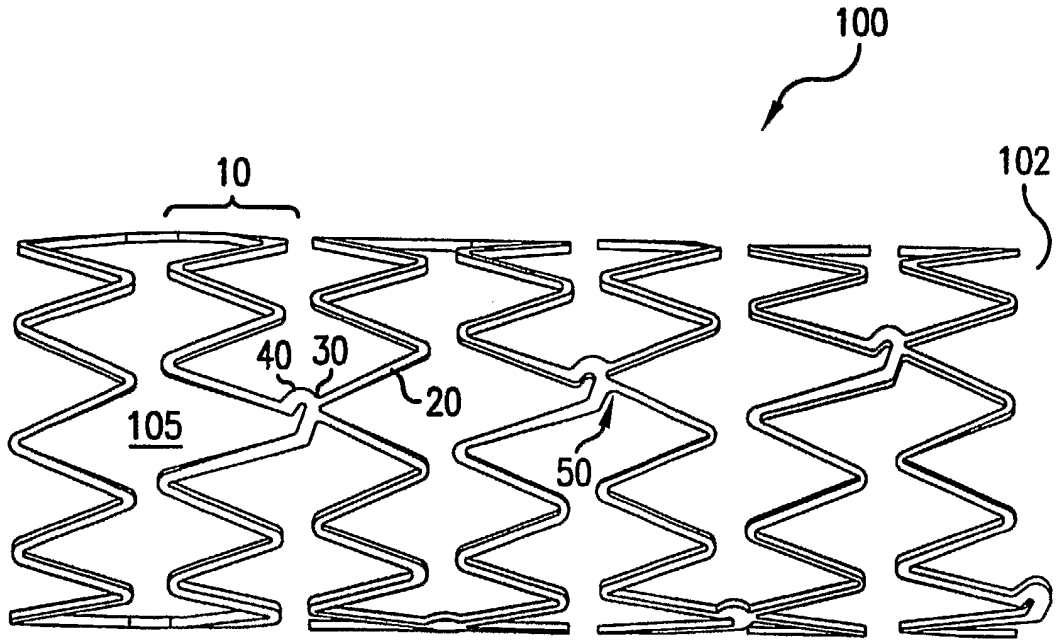

FIG.30d

RO/US 11/07703

43/44

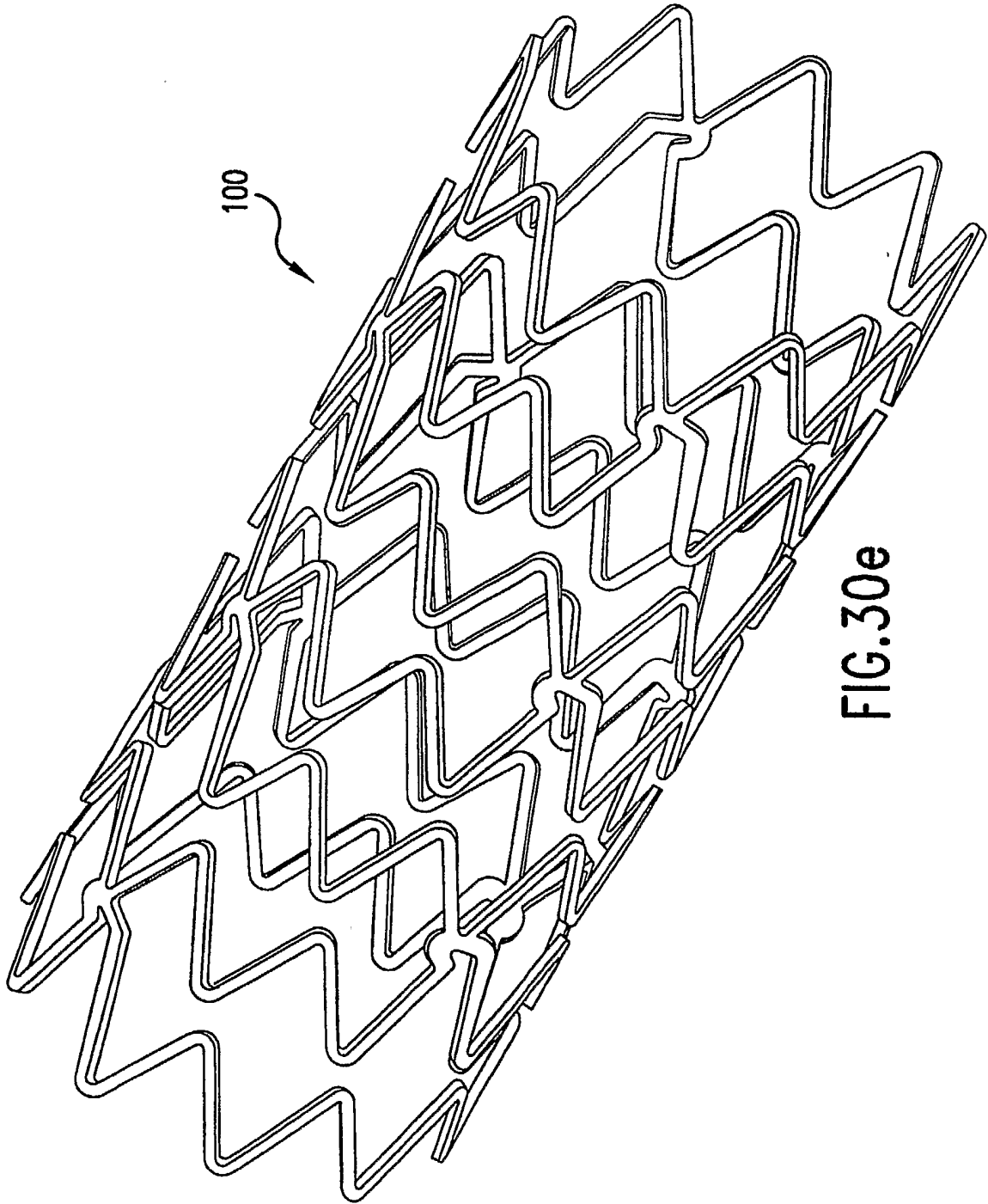

FIG. 30e

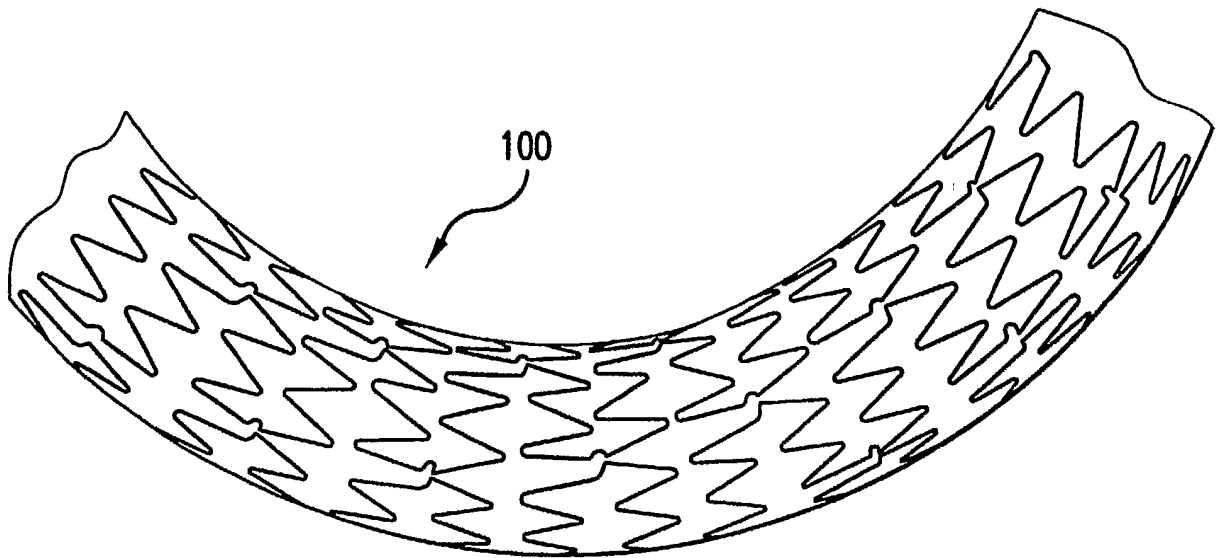

FIG.30f

INTERNATIONAL SEARCH REPORT

International Application No
PCT/US 03/14167

A. CLASSIFICATION OF SUBJECT MATTER
IPC 7 A61F2/06

EP

According to International Patent Classification (IPC) or to both national classification systems

B. FIELDS SEARCHED

Minimum documentation searched (classification system followed by classification symbols)
IPC 7 A61F

Documentation searched other than minimum documentation to the extent that such documents are included in the fields searched

Electronic data base consulted during the international search (name of data base and, where practical, search terms used)

EP0-Internal

C. DOCUMENTS CONSIDERED TO BE RELEVANT

Category °	Citation of document, with indication, where appropriate, of the relevant passages	Relevant to claim No.
X	<p>WO 99 39660 A (ROUSSIGNE MAURICE ;NADAL GUY (FR); BRAUN CELSA SA (FR)) 12 August 1999 (1999-08-12)</p> <p>page 9, line 23 -page 10, line 3 figures 2,3</p> <p style="text-align: center;">---</p> <p style="text-align: center;">-/--</p>	<p>1-6, 10, 11, 14, 16-18, 22, 27-31, 37, 43, 44, 46, 48</p>

Further documents are listed in the continuation of box C.

Patent family members are listed in annex.

° Special categories of cited documents :

- *A* document defining the general state of the art which is not considered to be of particular relevance
- *E* earlier document but published on or after the international filing date
- *L* document which may throw doubts on priority claim(s) or which is cited to establish the publication date of another citation or other special reason (as specified)
- *O* document referring to an oral disclosure, use, exhibition or other means
- *P* document published prior to the international filing date but later than the priority date claimed

- *T* later document published after the international filing date or priority date and not in conflict with the application but cited to understand the principle or theory underlying the invention
- *X* document of particular relevance; the claimed invention cannot be considered novel or cannot be considered to involve an inventive step when the document is taken alone
- *Y* document of particular relevance; the claimed invention cannot be considered to involve an inventive step when the document is combined with one or more other such documents, such combination being obvious to a person skilled in the art.
- * & * document member of the same patent family

Date of the actual completion of the international search

10 September 2003

Date of mailing of the international search report

17/09/2003

Name and mailing address of the ISA

European Patent Office, P.B. 5818 Patentlaan 2
NL - 2280 HV Rijswijk
Tel. (+31-70) 340-2040, Tx. 31 651 epo nl,
Fax: (+31-70) 340-3016

Authorized officer

Amaro, H

INTERNATIONAL SEARCH REPORT

International Application No
PCT/US 03/14167

C.(Continuation) DOCUMENTS CONSIDERED TO BE RELEVANT

Category °	Citation of document, with indication, where appropriate, of the relevant passages	Relevant to claim No.
X	EP 0 931 520 A (ADVANCED CARDIOVASCULAR SYSTEM) 28 July 1999 (1999-07-28) column 9, line 2 - line 9 figure 4	1-6, 10, 11, 13, 16, 17, 22, 27-30, 32, 38, 43, 46
A	US 2001/044648 A1 (WOLINSKY LONE ET AL) 22 November 2001 (2001-11-22) paragraph '0051! - paragraph '0054! figures 3,4	1-6, 11, 16, 22, 27, 29, 30, 38, 46

INTERNATIONAL SEARCH REPORT

 International Application No
 PCT/US 03/14167

Patent document cited in search report		Publication date	Patent family member(s)	Publication date
WO 9939660	A	12-08-1999	FR 2774279 A1	06-08-1999
			FR 2784573 A1	21-04-2000
			FR 2784574 A1	21-04-2000
			EP 1052950 A1	22-11-2000
			WO 9939660 A1	12-08-1999
<hr/>				
EP 0931520	A	28-07-1999	US 6179867 B1	30-01-2001
			EP 0931520 A2	28-07-1999
			JP 3061185 B2	10-07-2000
			JP 11285536 A	19-10-1999
<hr/>				
US 2001044648	A1	22-11-2001	EP 0971647 A2	19-01-2000
			WO 9939661 A2	12-08-1999
			US 6613079 B1	02-09-2003
			US 2003144731 A1	31-07-2003
<hr/>				