



US00D712384S

(12) **United States Design Patent**
Hibi

(10) **Patent No.:** **US D712,384 S**

(45) **Date of Patent:** **** Sep. 2, 2014**

(54) **MOBILE PHONE**

(71) Applicant: **Sony Mobile Communications AB,**
Lund (SE)

(72) Inventor: **Keita Hibi,** Tokyo (JP)

(73) Assignee: **Sony Mobile Communications AB,**
Lund (SE)

(**) Term: **14 Years**

(21) Appl. No.: **29/461,094**

(22) Filed: **Jul. 18, 2013**

Related U.S. Application Data

(63) Continuation of application No. 29/444,013, filed on
Jan. 25, 2013.

Foreign Application Priority Data

Aug. 15, 2012 (EM) 001339477

(51) **LOC (10) Cl.** **14-03**

(52) **U.S. Cl.**
USPC **D14/248**

(58) **Field of Classification Search**

CPC H04M 1/0202; H04M 1/0235; H04M
1/0237; H04M 1/0239; H04M 2250/22
USPC D14/247-248, 137, 341-347, 138 R,
D14/138 AD, 138 AC, 138 C, 138 G;
455/566, 575.1, 575.3, 575.4

See application file for complete search history.

(56) **References Cited**

U.S. PATENT DOCUMENTS

D585,040 S * 1/2009 Kim et al. D14/138 G
D589,021 S * 3/2009 Millora D14/138 AD
D605,157 S 12/2009 Kim et al.

D607,858 S * 1/2010 Millora D14/138 AD
D615,949 S * 5/2010 Kim D14/138 G
D639,277 S * 6/2011 Alvarado D14/218
D646,661 S * 10/2011 Kim D14/138 AD

(Continued)

FOREIGN PATENT DOCUMENTS

TW D135008 5/2010
TW D136926 9/2010

(Continued)

OTHER PUBLICATIONS

Sony Xperia ZL, announced Jan. 2013, [online], [retrieved on Mar. 5,
2013]. Retrieved from Internet ,<URL: http://www.gsmarena.
com>.*

(Continued)

Primary Examiner — Bridget L Eland

(74) *Attorney, Agent, or Firm* — Renner, Otto, Boisselle &
Sklar, LLP

(57) **CLAIM**

The ornamental design for a mobile phone, as shown and
described.

DESCRIPTION

FIG. 1 is a perspective view of a mobile phone showing my
new design.

FIG. 2 is a front view thereof.

FIG. 3 is a rear view thereof.

FIG. 4 is a right side view thereof.

FIG. 5 is a left side view thereof.

FIG. 6 is a bottom view thereof; and,

FIG. 7 is a top view thereof.

The broken lines in the drawings are included for the purpose
of illustrating portions of the mobile phone that form no part
of the claimed design.

1 Claim, 7 Drawing Sheets

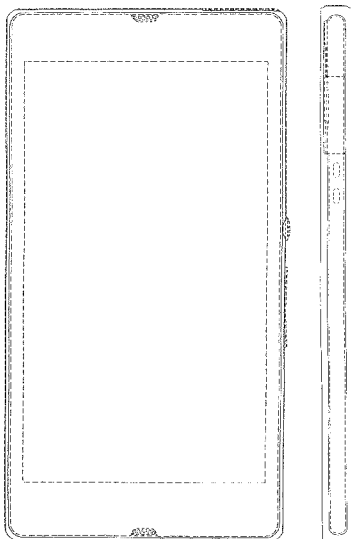

(56)

References Cited

U.S. PATENT DOCUMENTS

D647,076	S	*	10/2011	Kim	D14/138	G
D654,464	S	*	2/2012	Han	D14/138	G
D656,118	S	*	3/2012	Kim et al.	D14/138	G
D664,518	S	*	7/2012	Ryu	D14/138	G
D671,905	S	*	12/2012	Mauritzson	D14/138	G
D677,233	S	*	3/2013	Mauritzson	D14/138	G
D677,234	S	*	3/2013	Hirano	D14/138	G
D677,235	S	*	3/2013	Hibi	D14/138	G
D682,803	S	*	5/2013	Lee et al.	D14/138	G
D683,325	S	*	5/2013	Sugiyama	D14/138	G
D687,403	S	*	8/2013	Park	D14/138	G
D693,787	S	*	11/2013	Reivo et al.	D14/138	G
D694,730	S	*	12/2013	Lee	D14/138	G
D696,218	S	*	12/2013	Lee et al.	D14/138	G
D696,219	S	*	12/2013	Kim et al.	D14/138	G
D698,746	S	*	2/2014	Kaneta	D14/138	G
D702,681	S	*	4/2014	Sugiyama et al.	D14/341	
2007/0287512	A1	*	12/2007	Kilpi et al.	455/575.1	
2010/0267428	A1	*	10/2010	Wang et al.	455/575.4	
2012/0157174	A1	*	6/2012	Woo et al.	455/575.4	

FOREIGN PATENT DOCUMENTS

TW	D137773	11/2010
TW	D151010	12/2012
TW	D153730	5/2013

OTHER PUBLICATIONS

Sony Xperia Z, announced Jan. 2013, [online], [retrieved on Mar. 5, 2013]. Retrieved from Internet ,<URL: <http://www.gsmarena.com>>.*

Sony Xperia Z Ultra, announced Jun. 2013, [online], [retrieved on Mar. 30, 2014]. Retrieved from Internet ,<URL: <http://www.gsmarena.com>>.*

Sony Xperia Z1, announced Sep. 2013, [online], [retrieved on May 30, 2014]. Retrieved from Internet ,<URL: <http://www.gsmarena.com>>.*

Sony Xperia Z1 Compact, announced Jan. 2014, [online], [retrieved on May 30, 2014]. Retrieved from Internet ,<URL: <http://www.gsmarena.com>>.*

LG Optimus 3D Max P720, announced Feb. 2012, [online], [retrieved on Mar. 15, 2012]. Retrieved from Internet ,<URL: <http://www.gsmarena.com>>.*

LG Optimus 4X HD P880, announced Feb. 2012, [online], [retrieved on Mar. 15, 2012]. Retrieved from Internet ,<URL: <http://www.gsmarena.com>>.*

LG Optimus 2X, announced Dec. 2010, [online], [retrieved on Jan. 6, 2011]. Retrieved from Internet ,<URL: <http://www.gsmarena.com>>.*

Drawings from co-pending U.S. Appl. No. 29/460,835, filed Jul. 16, 2013.

Drawings from co-pending U.S. Appl. No. 29/460,837, filed Jul. 16, 2013.

* cited by examiner

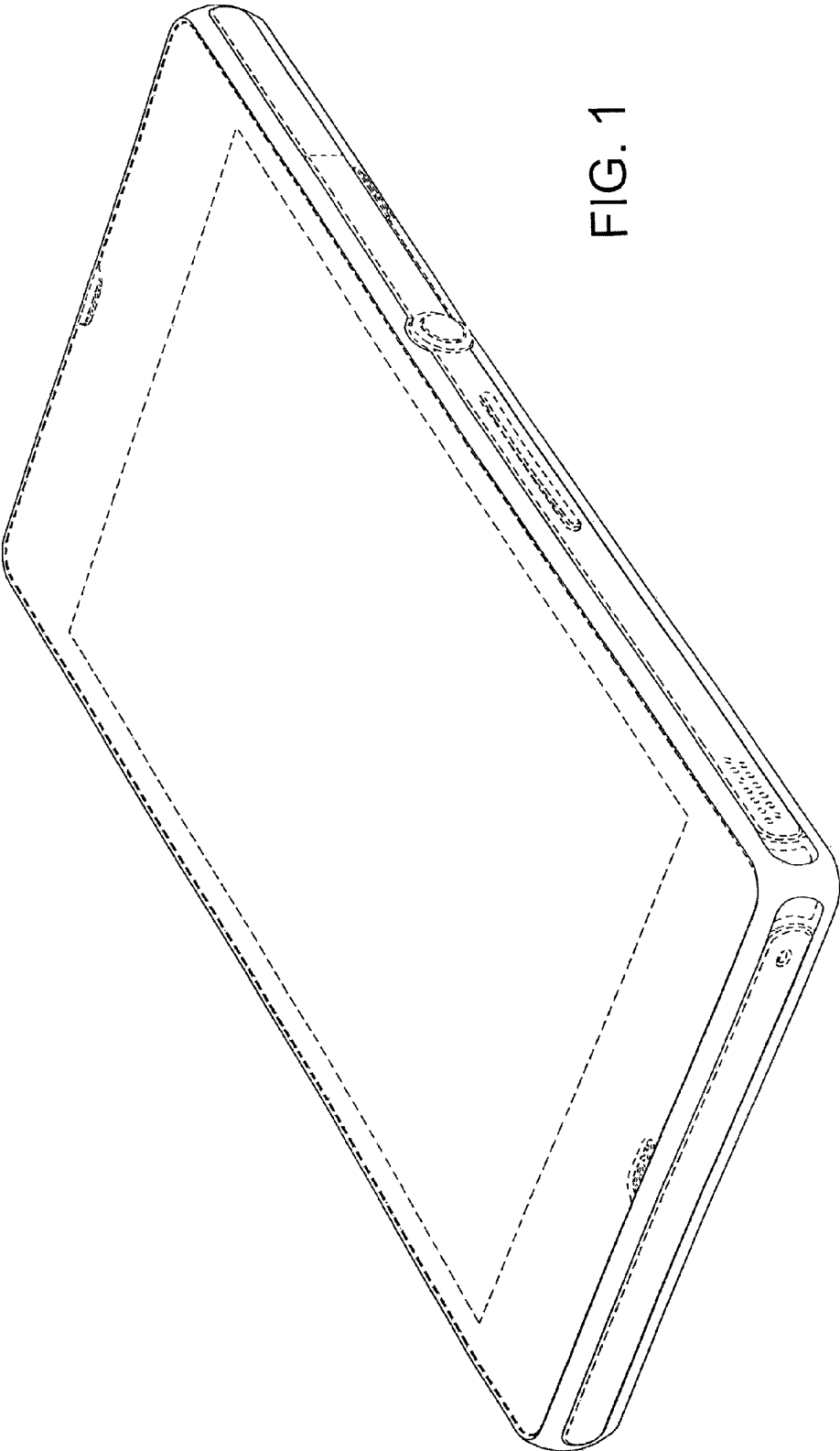

FIG. 1

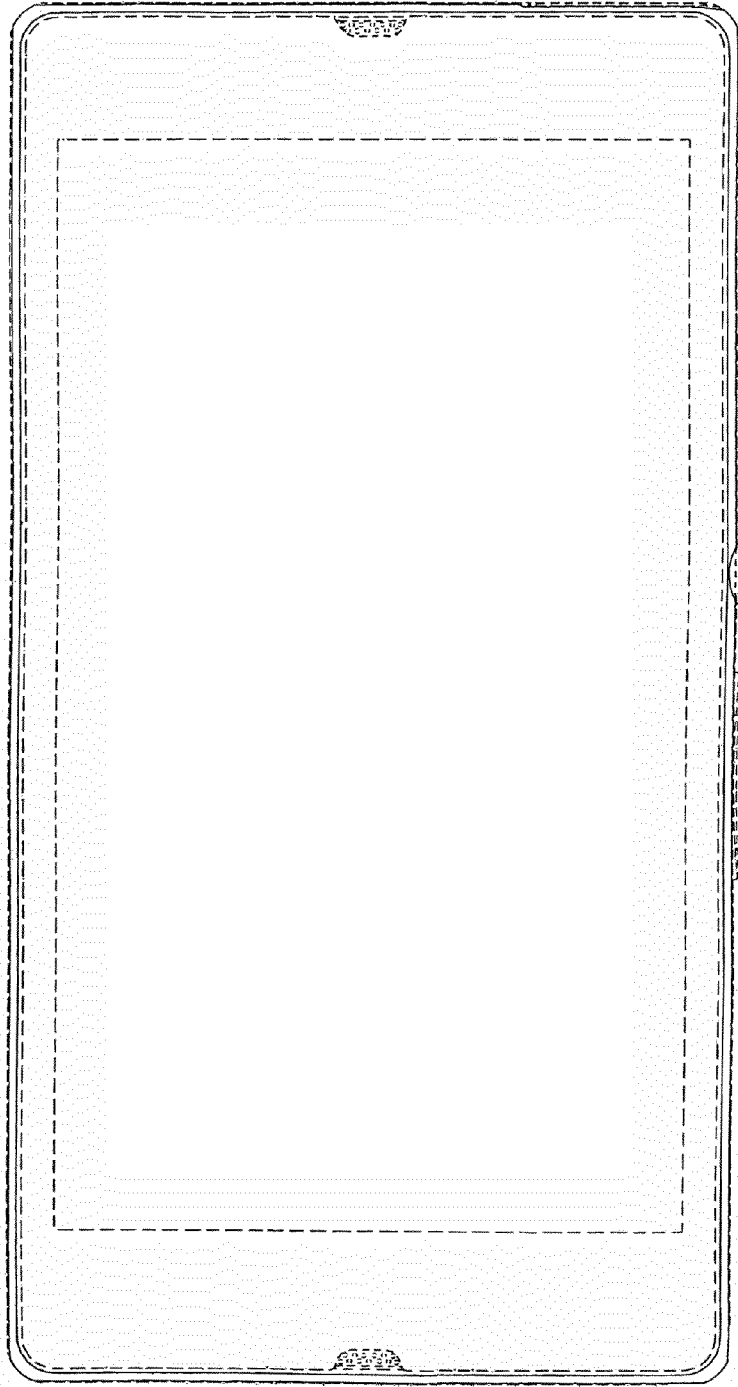

FIG. 2

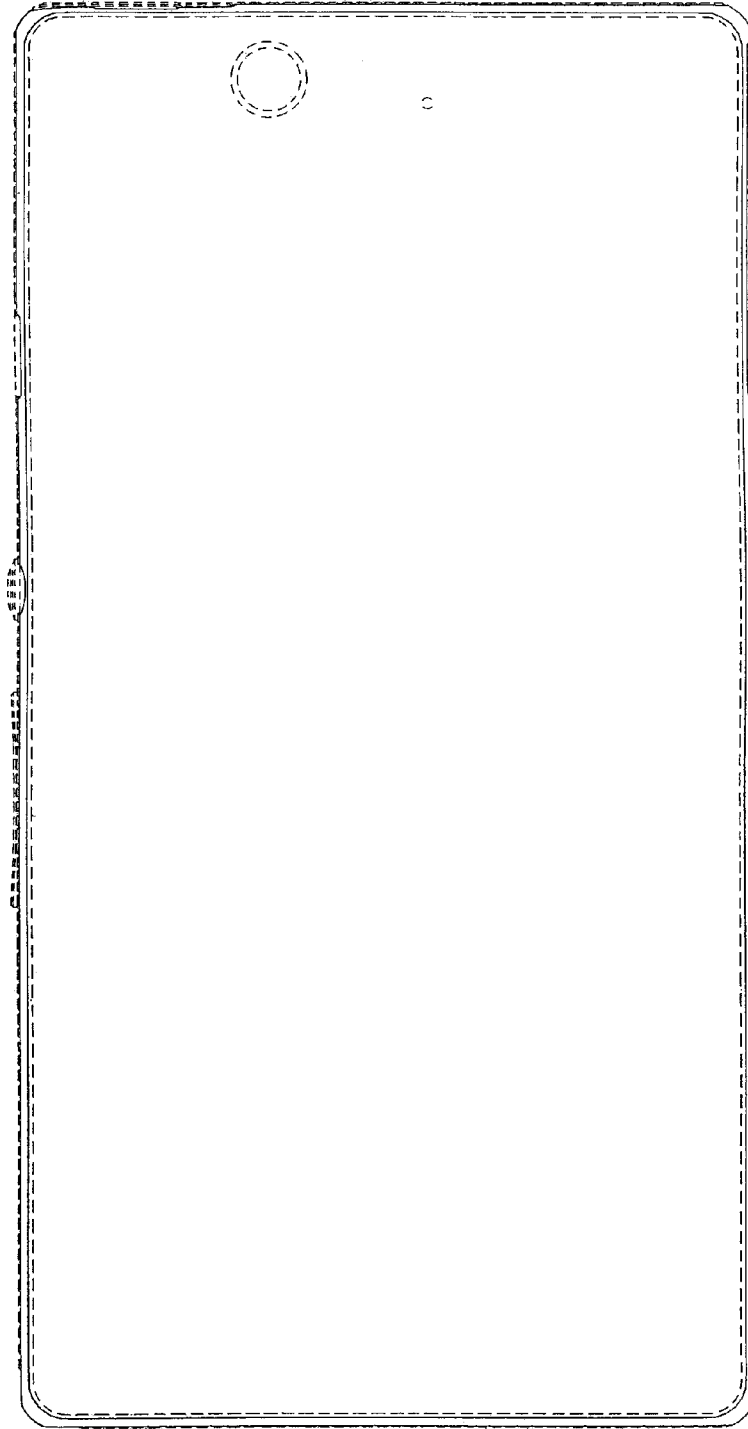

FIG. 3

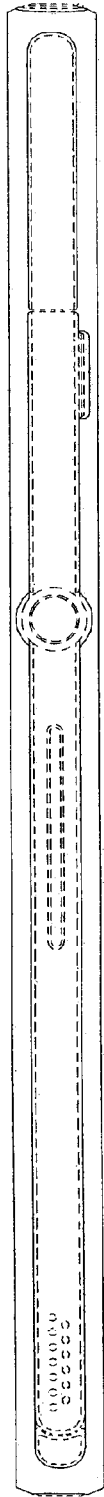

FIG. 4

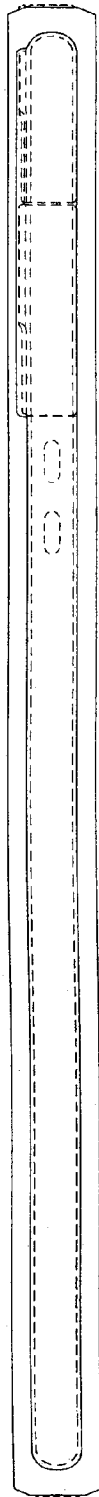

FIG. 5

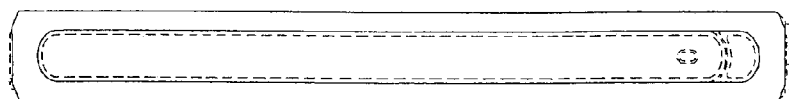

FIG. 6

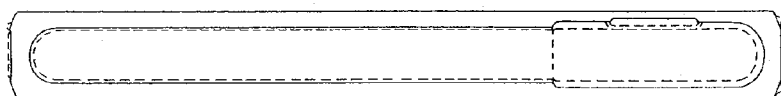

FIG. 7