

[54] **RETAINER CLIP FOR PIPES, RODS AND OTHER ELONGATED BODIES OR THE LIKE**

[75] Inventor: **Shigeru Kimura**, Kamakura, Japan

[73] Assignee: **Nifco Inc.**, Tokyo, Japan

[**] Term: **14 Years**

[21] Appl. No.: **211,496**

[22] Filed: **Dec. 1, 1980**

[30] **Foreign Application Priority Data**

May 31, 1980 [JP] Japan 55-21590

[51] Int. Cl. **D8-08**

[52] U.S. Cl. **D8/356; D8/388; D8/395; D8/396**

[58] Field of Search **D8/356, 388-390, D8/394-396; 248/49, 58, 65, 67.7, 68 R, 68 CB, 71, 74.1, 74.3, 74.5; 24/339**

[56] **References Cited**

U.S. PATENT DOCUMENTS

2,746,110	5/1956	Bedford	248/68 R
3,430,904	3/1969	Soltysik	248/74 A
3,441,986	5/1969	Pritchard	248/68 R
3,588,011	6/1971	Peres et al.	248/68 R
4,244,544	1/1981	Kornat	248/68 R

FOREIGN PATENT DOCUMENTS

950228 2/1964 United Kingdom 248/71

Primary Examiner—B. J. Bullock

Attorney, Agent, or Firm—Jerold M. Forsberg; Thomas W. Buckman; Jack R. Halvorsen

[57] **CLAIM**

The ornamental design for a retainer clip for pipes, rods and other elongated bodies or the like, as shown and described.

DESCRIPTION

FIG. 1 is a top plan view of a retainer clip for pipes, rods and other elongated bodies or the like showing my new design;

FIG. 2 is a front view thereof;

FIG. 3 is a bottom plan view thereof;

FIG. 4 is a side view taken from the left of FIG. 2;

FIG. 5 is a side view taken from the right of FIG. 2;

FIG. 6 is a sectional view taken in the direction of the arrows on line VI—VI in FIG. 2;

FIG. 7 is a top and left front perspective view thereof;

FIG. 8 is a bottom and right rear perspective view thereof;

FIG. 9 is a front view thereof, the portions of a panel and elongated bodies being shown in broken lines for illustrative purposes only;

FIG. 10 is a top plan view of a second embodiment of the design of FIG. 1;

FIG. 11 is a front view of FIG. 10;

FIG. 12 is a bottom plan view thereof;

FIG. 13 is a side view taken from the left of FIG. 11;

FIG. 14 is a side view taken from the right of FIG. 11;

FIG. 15 is a top and left front perspective view of FIG. 10;

FIG. 16 is a bottom and right rear perspective view of FIG. 10.

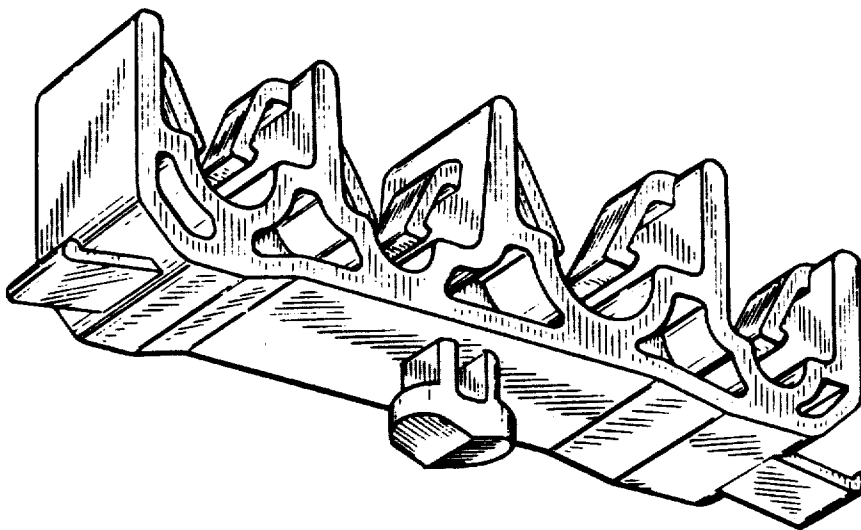

Fig. 1

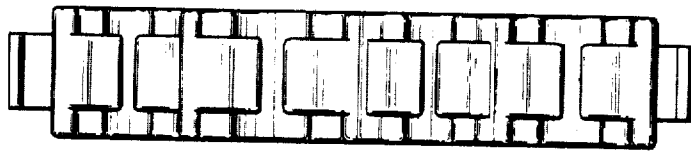
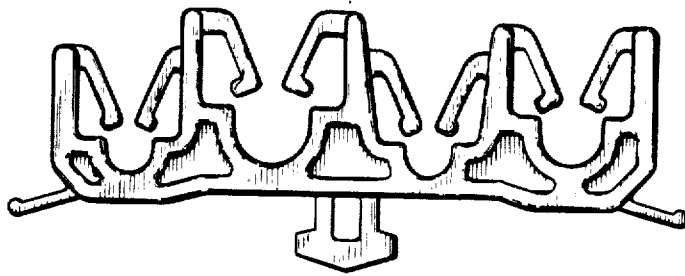

Fig. 2



VI

Fig. 3

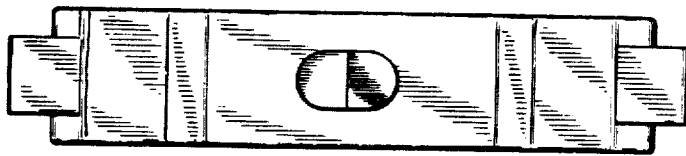

Fig. 6

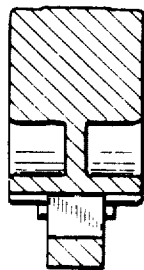

Fig. 4



Fig. 5



Fig. 7

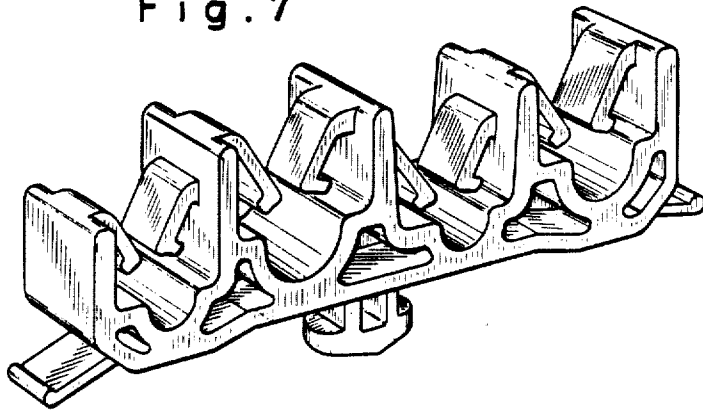

Fig. 8

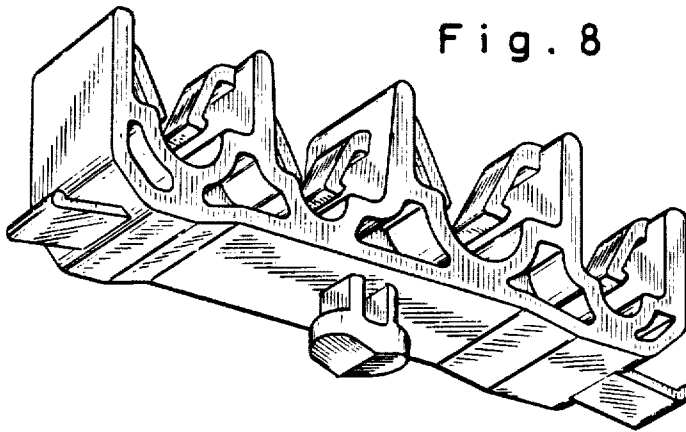

Fig. 9

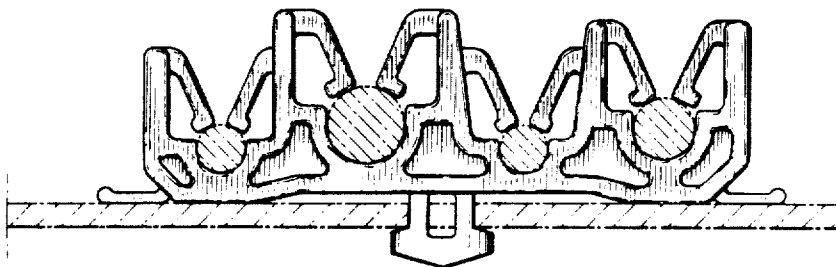

Fig. 10

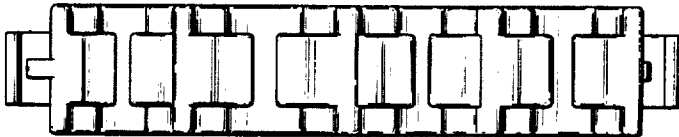

Fig. 11

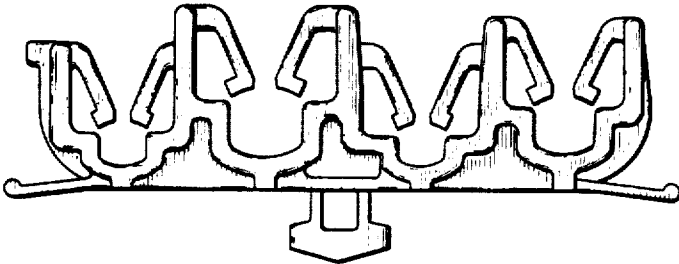

Fig. 12



Fig. 13

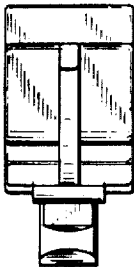

Fig. 14

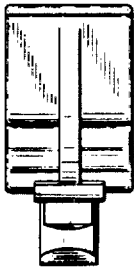

Fig. 15

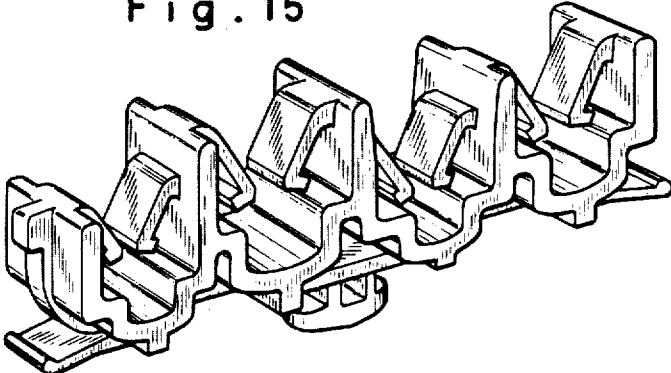

Fig. 16

