



US00D814130S

(12) **United States Design Patent**  
**Taub**

(10) **Patent No.:** **US D814,130 S**

(45) **Date of Patent:** **\*\* Mar. 27, 2018**

(54) **CLEANING APPARATUS**

10ml-frost-perfume-roll-on-bottle-with-c . . . site visited Mar. 22, 2017.\*

(71) Applicant: **SKT Productions, Inc.**, New York, NY (US)

(Continued)

(72) Inventor: **Stanley Taub**, New York, NY (US)

*Primary Examiner* — John Windmuller

*Assistant Examiner* — John R Yeh

(73) Assignee: **SKT PRODUCTIONS, INC.**, New York, NY (US)

(74) *Attorney, Agent, or Firm* — Lucas & Mercanti, LLP

(\*\*) Term: **15 Years**

(57) **CLAIM**

The ornamental design for a cleaning apparatus, as shown and described.

(21) Appl. No.: **29/566,643**

(22) Filed: **Jun. 1, 2016**

**DESCRIPTION**

(51) **LOC (11) Cl.** ..... **07-05**

(52) **U.S. Cl.**

USPC ..... **D32/40**

(58) **Field of Classification Search**

USPC ..... D32/40-44; 16/110.1-429; D8/300-301,  
D8/303, 305-307, 70, 62; D4/120, 122;  
D9/519, 545, 516  
CPC .. A47B 95/02; A47K 7/02; A63H 3/00; A47L  
13/16

See application file for complete search history.

FIG. 1 is a perspective view of a cleaning apparatus in a closed position;

FIG. 2 is a view of one end thereof;

FIG. 3 is a view of the opposite end thereof;

FIG. 4 is a left side view thereof;

FIG. 5 is a right side view thereof;

FIG. 6 is a top view thereof;

FIG. 7 is a bottom view thereof;

FIG. 8 is a perspective view of the cleaning apparatus of FIG. 1 with the cap portion removed;

FIG. 9 is a view of one end thereof;

FIG. 10 is a left side view thereof;

FIG. 11 is a right side view thereof;

FIG. 12 is a top view thereof;

FIG. 13 is a bottom view thereof;

FIG. 14 is a view of one end thereof;

FIG. 15 is a left side view of the cleaning apparatus of FIG. 1 with the cap portion placed on the base portion in a use position;

FIG. 16 is a right side view thereof;

FIG. 17 is a top view thereof;

FIG. 18 is a bottom view thereof;

FIG. 19 is a perspective view of the cleaning apparatus of FIG. 15 with a hole in the cleaning head; and,

FIG. 20 is a top view of the cleaning apparatus of FIG. 19 illustrating the hole in the cleaning head.

(56) **References Cited**

**U.S. PATENT DOCUMENTS**

854,923 A \* 5/1907 Broad ..... F42B 12/34  
102/508  
1,432,669 A \* 10/1922 Clay ..... F42B 12/38  
102/513

(Continued)

**FOREIGN PATENT DOCUMENTS**

GB 1043293 \* 3/1988  
JP D1132407 \* 1/2002

**OTHER PUBLICATIONS**

Glass Bottle.com Frost Perfume Roll on Bottle With Cap and Roller, website 2017, <http://www.glassbottlefactory.com/sale-8506118->

**1 Claim, 7 Drawing Sheets**

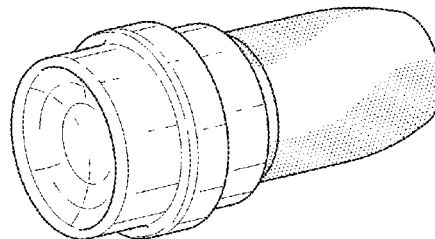
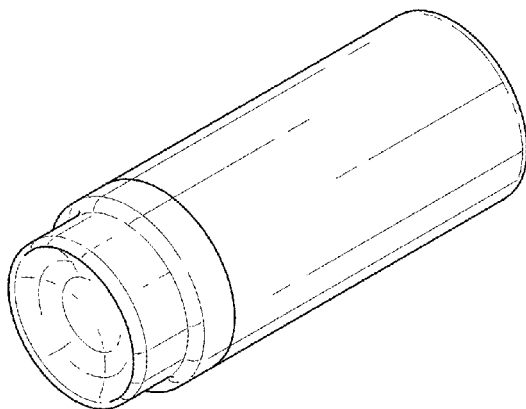

(56)

References Cited

U.S. PATENT DOCUMENTS

1,504,217 A \* 8/1924 Coryell ..... A45D 40/06  
 132/318  
 1,833,645 A \* 11/1931 Hartz ..... F42B 12/34  
 102/508  
 2,099,488 A \* 11/1937 Kasdan ..... A45D 40/06  
 401/71  
 2,287,366 A \* 6/1942 Younghusband ..... A45D 40/10  
 206/817  
 2,287,768 A \* 6/1942 Eckstein ..... B65B 41/16  
 101/475  
 2,318,365 A \* 5/1943 Boysen ..... A46B 5/04  
 15/227  
 2,542,774 A 2/1951 Hutchinson  
 2,658,217 A 11/1953 Green  
 3,381,325 A 5/1968 Reineman  
 3,542,025 A \* 11/1970 Gustafson ..... A61F 13/2082  
 604/1  
 3,991,684 A \* 11/1976 Pritchard ..... F42B 12/78  
 102/510  
 D281,654 S 12/1985 Bladh et al.  
 4,740,097 A \* 4/1988 Kapustin ..... A45D 40/00  
 132/320  
 4,979,257 A 12/1990 Heneveld  
 5,333,341 A 8/1994 Heneveld  
 D533,044 S \* 12/2006 Buening ..... D8/103  
 D539,545 S 4/2007 Crane et al.

7,213,291 B2 5/2007 Hsu  
 D663,836 S \* 7/2012 Ruiz, Sr. .... D24/133  
 D666,733 S \* 9/2012 Caggiano ..... D24/215  
 D686,367 S \* 7/2013 Ruiz, Sr. .... D28/7  
 D700,018 S \* 2/2014 Thrash ..... D7/608  
 D722,126 S \* 2/2015 Bray ..... D22/115  
 D727,567 S \* 4/2015 Bunkley ..... D28/7  
 2005/0089359 A1 \* 4/2005 Chen ..... A45D 34/042  
 401/266  
 2010/0291266 A1 \* 11/2010 Czinki ..... A23L 33/17  
 426/72  
 2011/0265279 A1 \* 11/2011 Kawaguchi ..... A46B 9/005  
 15/244.4  
 2012/0042470 A1 \* 2/2012 Putnik ..... A47L 13/60  
 15/262  
 2013/0058701 A1 \* 3/2013 Chan ..... A45D 40/023  
 401/59  
 2013/0294810 A1 \* 11/2013 Chan ..... A45D 40/06  
 401/75

OTHER PUBLICATIONS

SKT Productions, Inc. iRoller—Reusable, liquid free touch screen  
 Cleaner, review date Jan. 3, 2017, <http://www.ebay.com/itm/SKT-Productions-Inc-iRoller-Reusable-liquid-free-touch-screen-Cleaner-/252806230918#rwid>, [site visited Mar. 22, 2017 9:27:17 PM].\*

\* cited by examiner

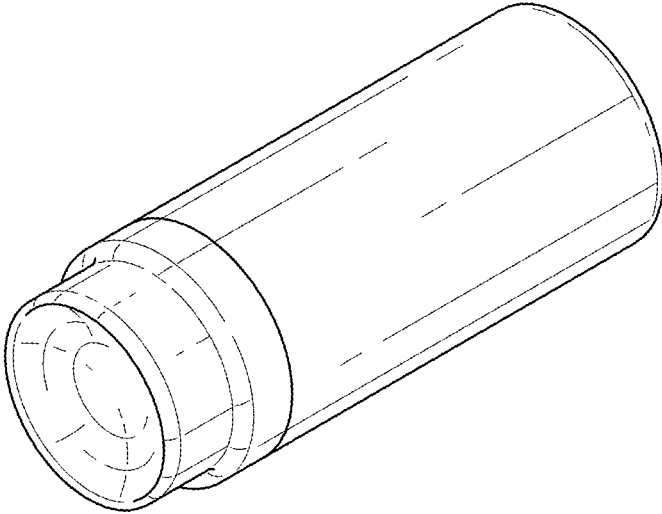

FIG. 1

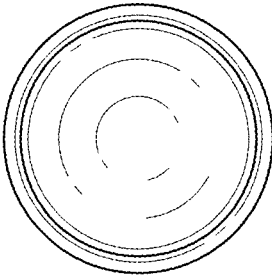

FIG. 2

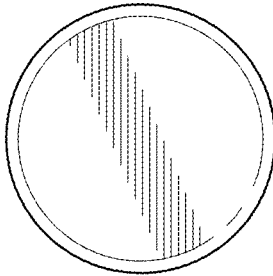

FIG. 3

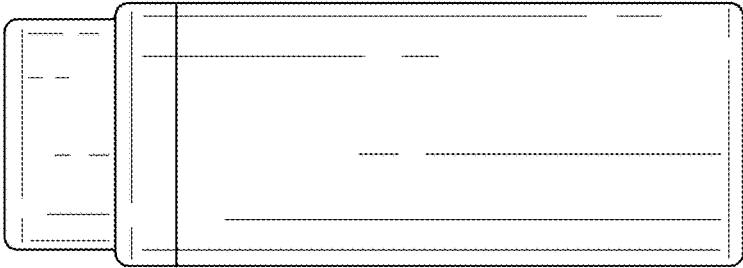

FIG. 4

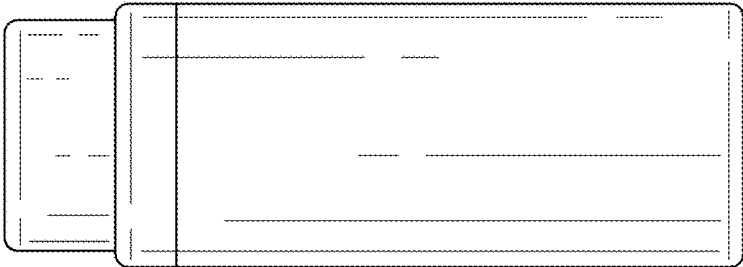

FIG. 5

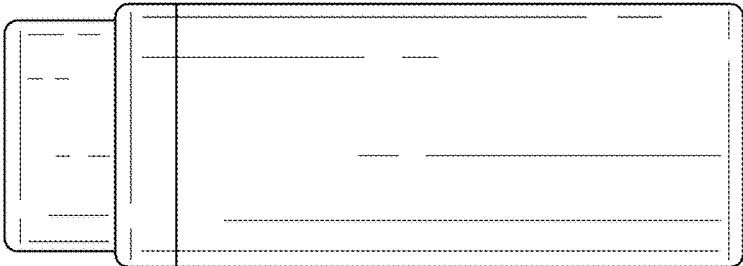

FIG. 6

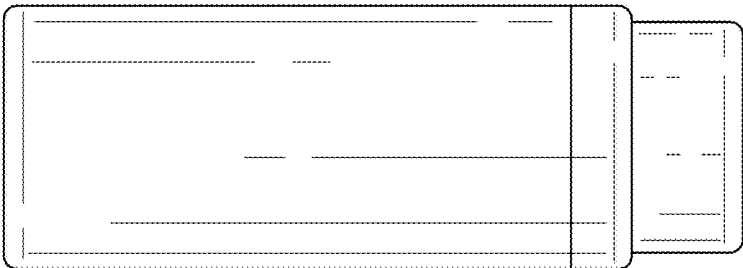

FIG. 7

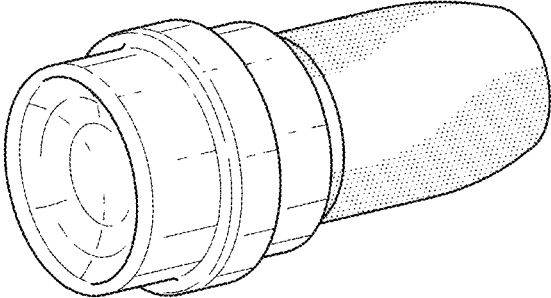

FIG. 8

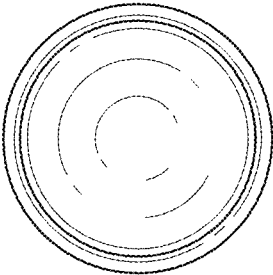

FIG. 9

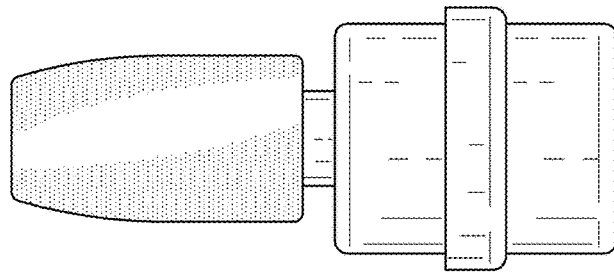

FIG. 10

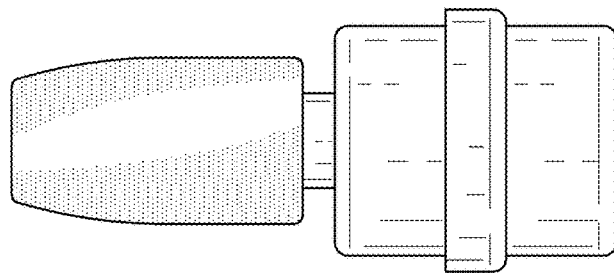

FIG. 11

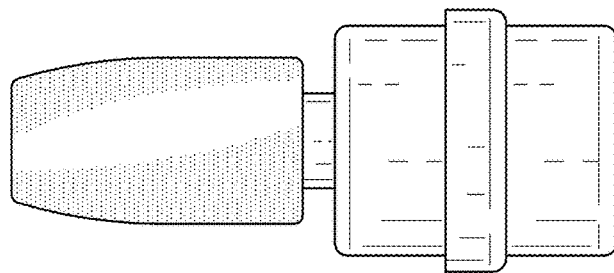

FIG. 12

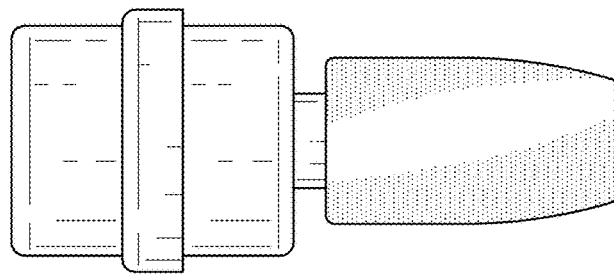

FIG. 13

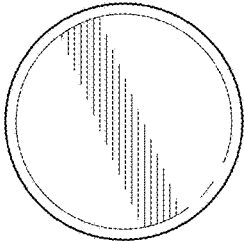

FIG. 14

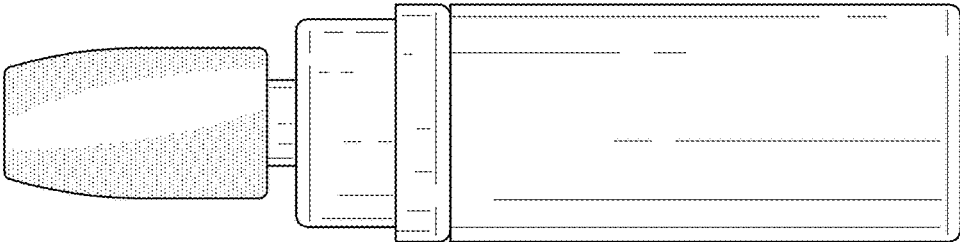

FIG. 15

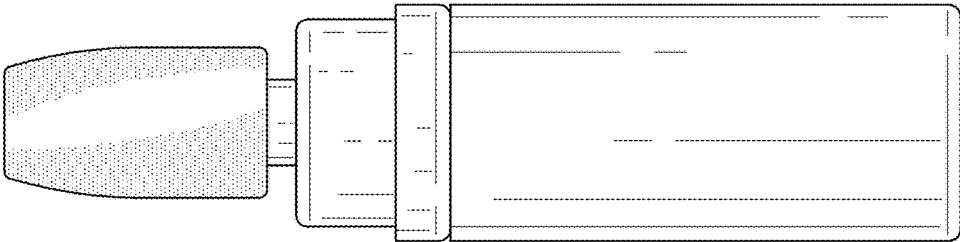

FIG. 16

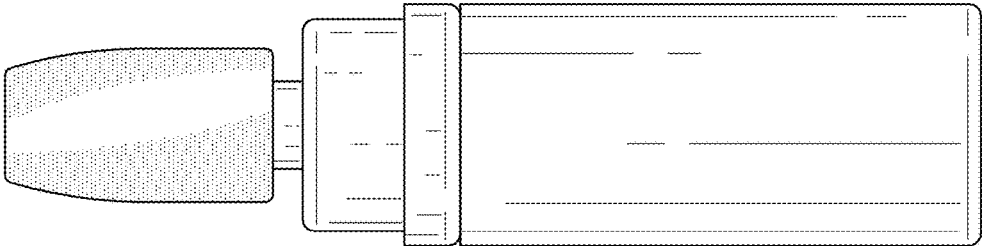

FIG. 17

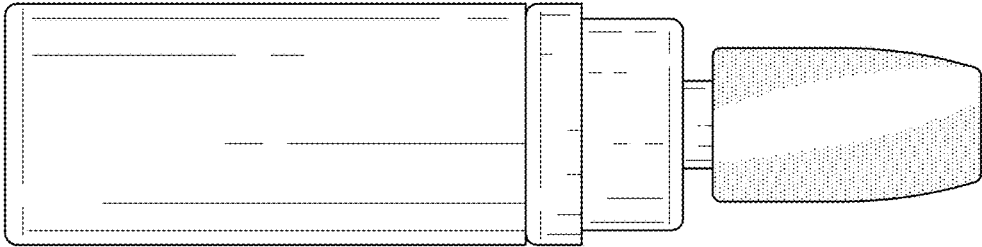

FIG. 18



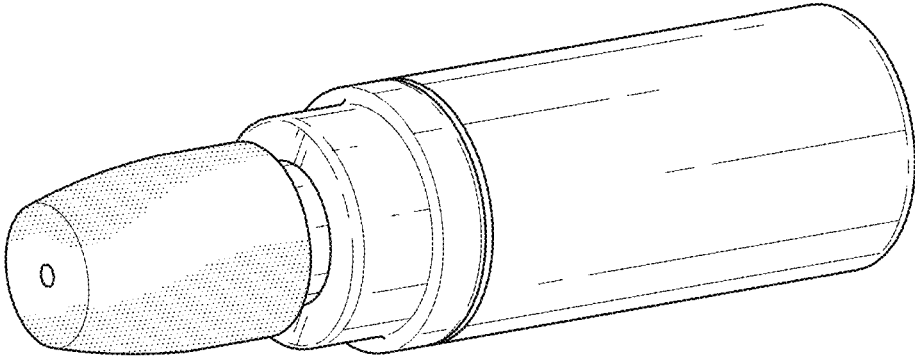

FIG. 19

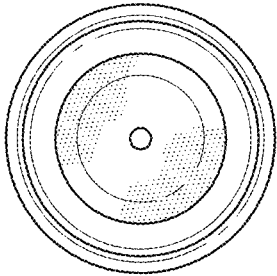

FIG. 20