



US0D1038818S

(12) **United States Design Patent**
McKenna

(10) **Patent No.:** **US D1,038,818 S**

(45) **Date of Patent:** **** Aug. 13, 2024**

(54) **PENDANT**

(71) Applicant: **NOUVEL HERITAGE**, Paris (FR)

(72) Inventor: **Camille Parruitte McKenna**, New York, NY (US)

(73) Assignee: **NOUVEL HERITAGE**, Paris (FR)

(**) Term: **15 Years**

(21) Appl. No.: **35/515,434**

(22) Filed: **May 11, 2022**

(80) **Hague Agreement Data**

Int. Filing Date: **May 11, 2022**

Int. Reg. No.: **DM/224125**

Int. Reg. Date: **May 11, 2022**

Int. Reg. Pub. Date: **Oct. 21, 2022**

(51) **LOC (14) Cl.** **11-01**

(52) **U.S. Cl.** **D11/79**

(58) **Field of Classification Search**

USPC D11/43, 44, 45, 56, 65, 79, 80, 81, 83,
D11/85, 82, 84, 7; D3/207-212

CPC ... A44C 25/001; A44C 25/002; A44C 25/004;
A44C 25/005; A44C 25/007; A44C
25/008

See application file for complete search history.

(56) **References Cited**

U.S. PATENT DOCUMENTS

1,446,894 A * 2/1923 Foley B65D 47/283
222/545
2,231,230 A * 2/1941 Sturtz G09F 3/00
248/205.5
D140,450 S * 2/1945 Rubel D11/44
D152,216 S * 12/1948 Quethera 132/286
D161,612 S * 1/1951 Carnevale D3/203.2
D257,572 S * 12/1980 Wefler D3/208
D258,874 S * 4/1981 Hocq D11/79

4,420,076 A * 12/1983 Beveridge A61J 1/03
206/37
D281,369 S * 11/1985 Harris D99/34
D292,243 S * 10/1987 O'Grady D26/38
D308,951 S * 7/1990 Rinck D11/79
D332,580 S * 1/1993 Rousseau D11/12
D337,339 S * 7/1993 An D11/79
D347,297 S * 5/1994 Vesco D28/73
D395,840 S * 7/1998 Cato D11/79

(Continued)

FOREIGN PATENT DOCUMENTS

WO D224125-001 * 10/2022
WO D224125-002 * 10/2022
WO D224125-003 * 10/2022

OTHER PUBLICATIONS

Nouvel Heritage 18k Gold Diamond Latch Pendant, available Jul. 10, 2023, online, site visited Jul. 10, 2023. Available online, URL: <https://www.ylangylang.com/products/nouvel-heritage-18k-gold-diamond-latch-pendant> (Year: 2023).*

(Continued)

Primary Examiner — W. A. Teddy Falloway

Assistant Examiner — Sarah J Ault

(74) *Attorney, Agent, or Firm* — Barnes & Thornburg LLP

(57) **CLAIM**

The ornamental design for a pendant, as shown and described.

DESCRIPTION

1. Pendant

1.1 : Front

1.2 : Front Perspective View

1.3 : Exploded Back Perspective View

1.4 : Exploded Top View

Pendant of precious metals. The broken lines in the figures illustrate portions of the design that form no part of the claimed design.

1 Claim, 4 Drawing Sheets

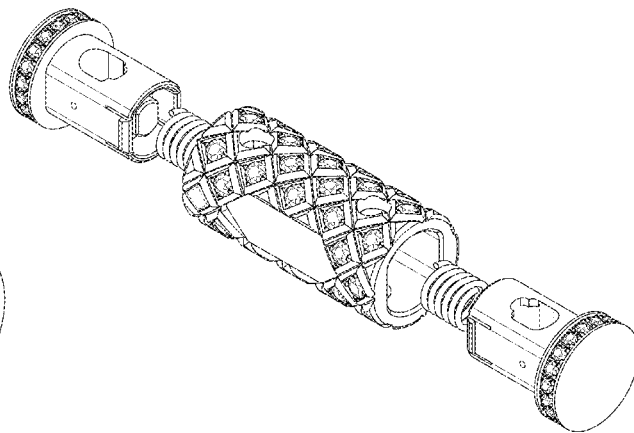
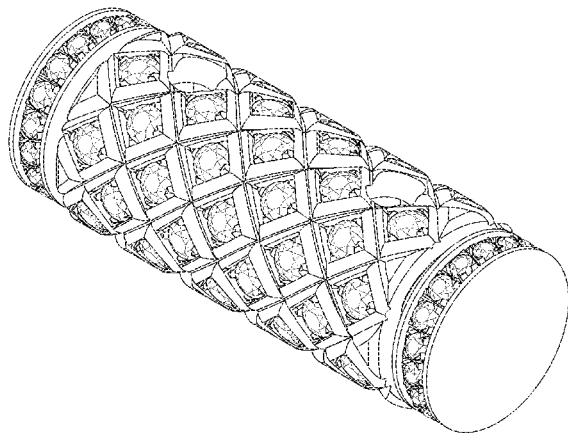

(56)

References Cited

U.S. PATENT DOCUMENTS

5,927,104	A	*	7/1999	Green	A44C 7/002	
							63/23
D532,714	S	*	11/2006	Scharr	D11/79	
D575,664	S	*	8/2008	Greer	D11/86	
D583,700	S	*	12/2008	Greer	D11/80	
D586,254	S	*	2/2009	Allert	D11/86	
D606,447	S	*	12/2009	West	D11/80	
D675,953	S	*	2/2013	Kapur	D11/81	
D761,150	S	*	7/2016	Penna	D11/79	
D777,599	S	*	1/2017	Adler	D11/81	
D791,638	S	*	7/2017	Mesica	D11/81	
D808,293	S	*	1/2018	Lenzmeier	D11/81	
D811,261	S	*	2/2018	Abdo	D11/80	
D871,248	S	*	12/2019	Boccanfuso	D11/79	
D896,682	S	*	9/2020	Rohde	D11/79	
D917,334	S	*	4/2021	Daga	D11/87	
D970,378	S	*	11/2022	Gabai-Pinsky	D3/215	
D981,897	S	*	3/2023	Liu	D11/79	
D983,699	S	*	4/2023	Hardy	D11/79	

OTHER PUBLICATIONS

Diamond Latch Pendant, available Jul. 10, 2023, online, site visited Jul. 10, 2023. Available online, URL: <https://nouvelheritage.com/collections/over-5000/products/diamond-latch-pendant> (Year: 2023).*
 The jewelry girl to follow: Camille Parraitte, available May 20, 2022, online, site visited Jul. 10, 2023. Available online, URL: <https://theeyeofjewelry.com/maison-artaner-paris/the-girl-to-follow-camille-parraitte-the-creator-of-the-brand-nouvel-heritage/> (Year: 2022).*

* cited by examiner

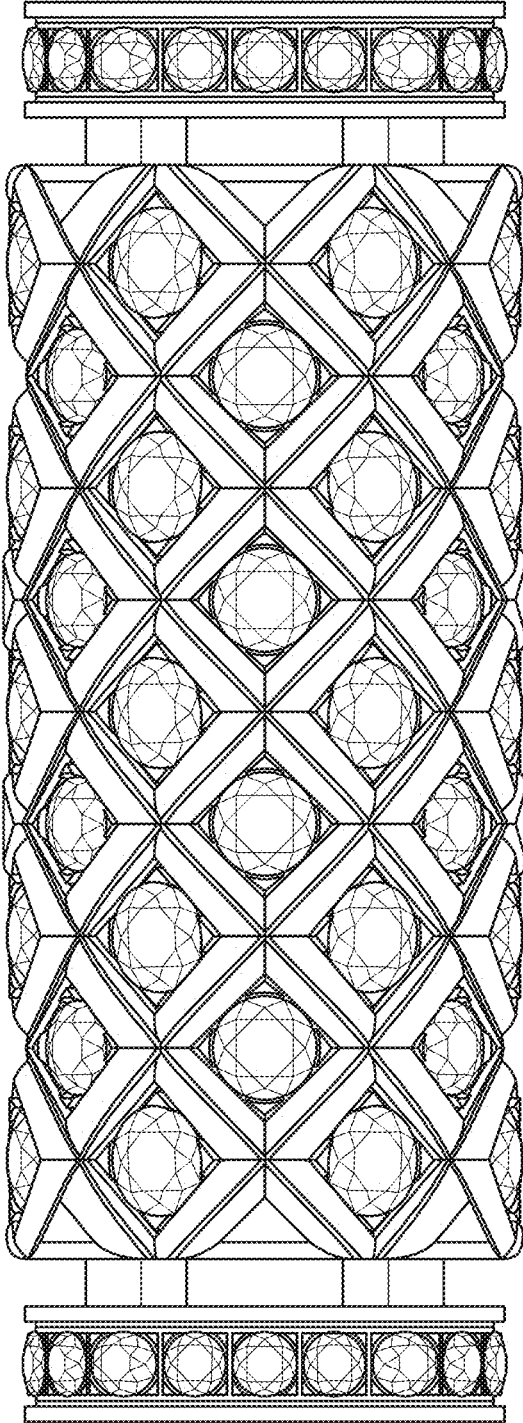

1.1

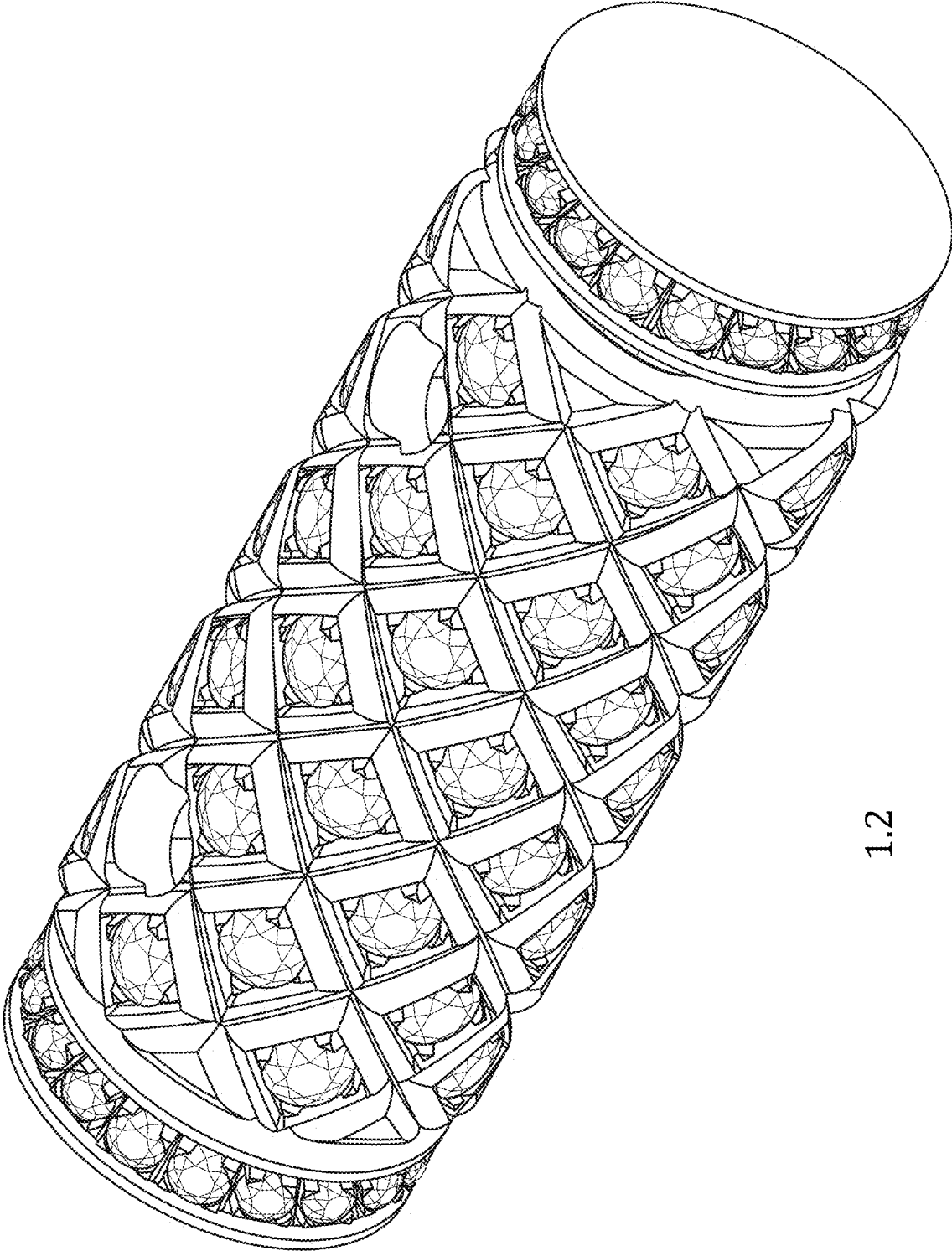

1.2

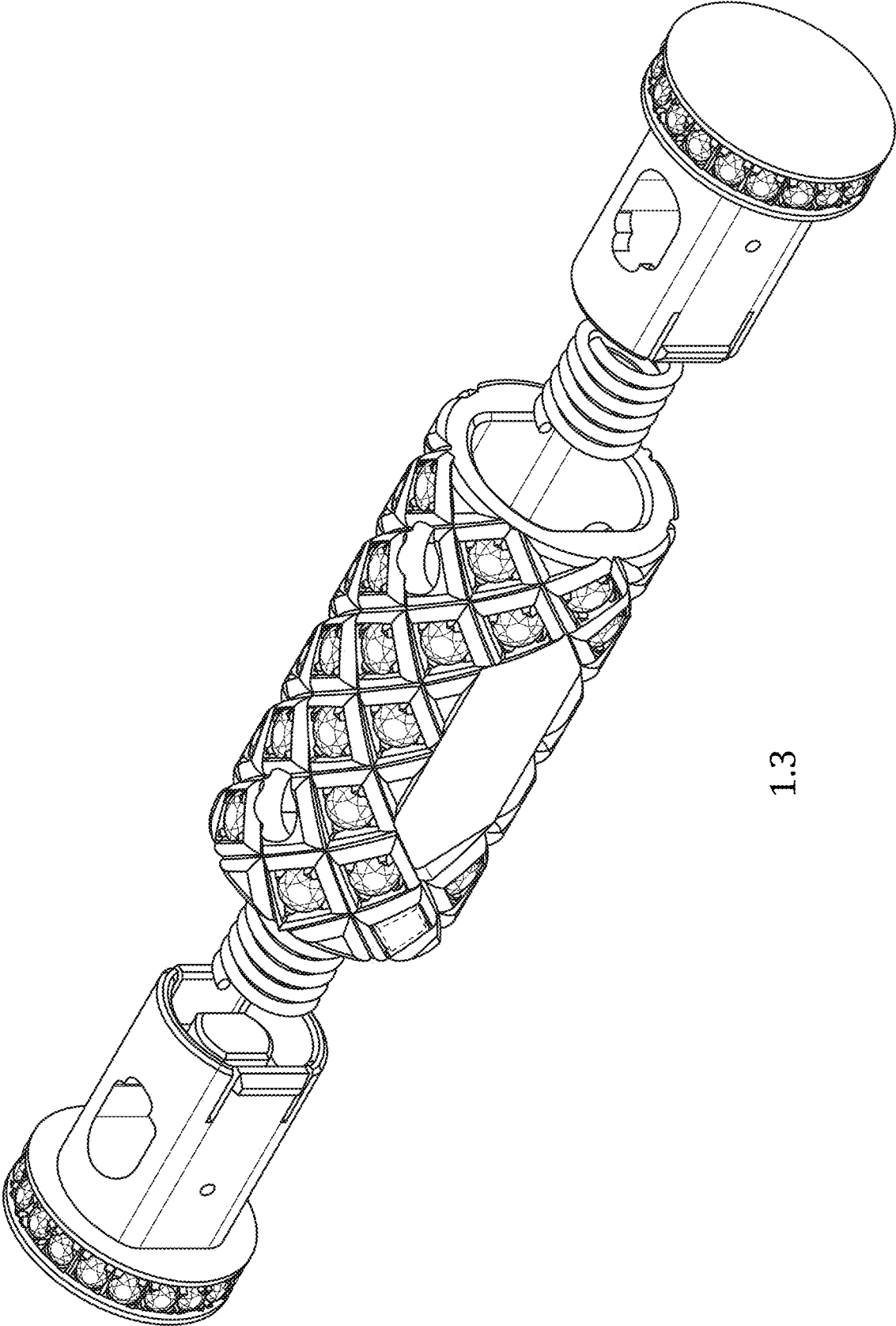

1.3

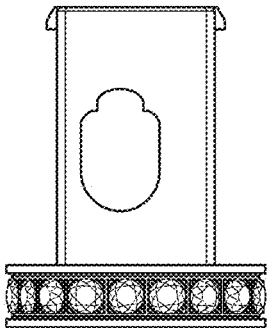
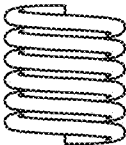
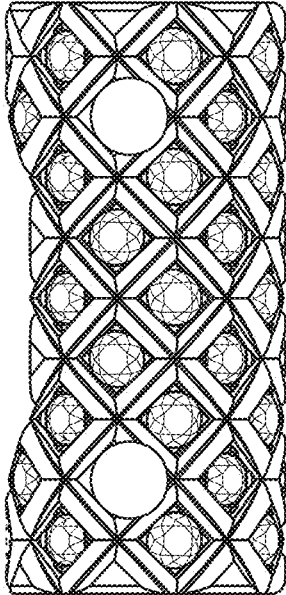
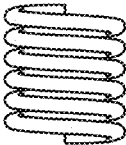
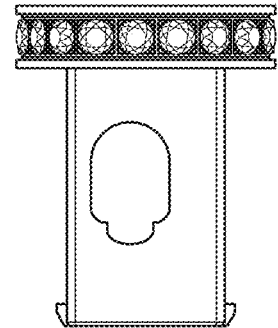

1.4