



US00D671222S

(12) **United States Design Patent**
Edwards et al.

(10) **Patent No.:** **US D671,222 S**

(45) **Date of Patent:** **** Nov. 20, 2012**

(54) **MODULE FOR A PATIENT-MONITOR OR THE LIKE**

(75) Inventors: **Ian K Edwards**, Skaneateles, NY (US);
Shawn St. Pierre, Syracuse, NY (US);
Thaddeus J Wawro, Auburn, NY (US);
Scott A Martin, Warners, NY (US);
Adam Leonards, El Cerrito, CA (US);
Alex Millie, San Francisco, CA (US)

(73) Assignee: **Welch Allyn, Inc.**, Skaneateles Falls, NY (US)

(**) Term: **14 Years**

(21) Appl. No.: **29/366,260**

(22) Filed: **Jul. 22, 2010**

(51) **LOC (9) Cl.** **24-01**

(52) **U.S. Cl.** **D24/186**

(58) **Field of Classification Search** D24/111,
D24/125, 138, 144, 158, 160, 185-186, 231,
D24/232, 169, 200; 128/915-916, 922, 660.01,
128/660.02, 660.03, 660.07, 653; 600/437-457;
248/918; D14/125, 434, 447, 217; D13/107-108,
D13/162; D10/52

See application file for complete search history.

(56) **References Cited**

U.S. PATENT DOCUMENTS

5,261,080 A	11/1993	Khoyi et al.
5,307,262 A	4/1994	Ertel
5,446,880 A	8/1995	Balgeman et al.
5,708,828 A	1/1998	Coleman
5,710,908 A	1/1998	Man
5,721,895 A	2/1998	Velissaropoulos et al.
5,734,907 A	3/1998	Jarossay et al.
5,857,195 A	1/1999	Hayashi et al.
5,892,925 A	4/1999	Aditya et al.
5,999,979 A	12/1999	Vellanki et al.
6,026,392 A	2/2000	Kouchi et al.
6,130,917 A	10/2000	Monroe
6,190,313 B1	2/2001	Hinkle

6,249,668 B1	6/2001	Abe et al.
6,250,309 B1	6/2001	Krichen et al.
6,275,869 B1	8/2001	Steffert et al.
6,400,286 B1	6/2002	Cooper
6,584,445 B2	6/2003	Papageorge
6,625,617 B2	9/2003	Yarnall et al.
6,633,833 B2	10/2003	Sharma et al.

(Continued)

FOREIGN PATENT DOCUMENTS

EP 0707824 4/1996

(Continued)

OTHER PUBLICATIONS

Colin Prodigy Press-Mate Prodigy II® Portable Vital Signs Monitors, DRE, Copyright 2009, accessed at: http://www.dremed.com/catalog/product_info.php/products_id/1181; 5 pages.

(Continued)

Primary Examiner — T. Chase Nelson

Assistant Examiner — Mark Cavanna

(74) *Attorney, Agent, or Firm* — Roger P. Bonenfant

(57) **CLAIM**

The ornamental design for module for a patient-monitor or the like, as shown and described.

DESCRIPTION

FIG. 1 is a top perspective view of a module for a patient-monitor or the like showing my new design; FIG. 2 is a bottom perspective view thereof; FIG. 3 is a front view thereof; FIG. 4 is a rear view thereof; FIG. 5 is a top view thereof; FIG. 6 is a bottom view thereof; FIG. 7 is a right-side view thereof; and, FIG. 8 is a left-side view thereof. The broken lines shown herein are for illustrative purposes only and form no part of the claimed design.

1 Claim, 6 Drawing Sheets

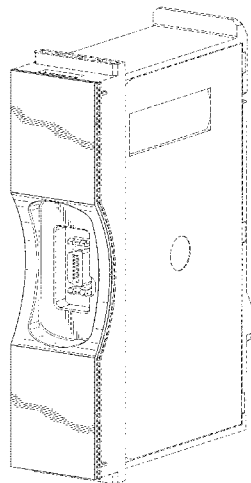

U.S. PATENT DOCUMENTS

6,644,322 B2 11/2003 Webb
 6,651,104 B1 11/2003 Moon
 6,669,631 B2 12/2003 Norris et al.
 6,697,103 B1 2/2004 Fernandez et al.
 6,721,286 B1 4/2004 Williams et al.
 6,766,361 B1 7/2004 Venigalla
 6,792,431 B2 9/2004 Tamboli et al.
 6,801,331 B1 10/2004 Motoyama
 6,839,717 B1 1/2005 Motoyama et al.
 6,848,108 B1 1/2005 Caron
 6,915,312 B2 7/2005 Bodnar et al.
 6,940,807 B1 9/2005 Rezvani et al.
 6,942,616 B2 9/2005 Kerr, II
 D511,008 S * 10/2005 Ryan D24/200
 6,951,539 B2 10/2005 Bardy
 6,978,422 B1 12/2005 Bushe et al.
 6,993,536 B2 1/2006 Yamanaka
 D516,026 S * 2/2006 Barrett et al. D13/108
 7,016,963 B1 3/2006 Judd et al.
 7,054,924 B1 5/2006 Harvey et al.
 7,124,299 B2 10/2006 Dick et al.
 7,134,994 B2 11/2006 Alpert et al.
 7,336,187 B2 2/2008 Hubbard et al.
 7,360,154 B2 4/2008 Gale
 D569,981 S * 5/2008 Collins D24/186
 7,408,932 B2 8/2008 Kounavis et al.
 D609,351 S * 2/2010 Wagener et al. D24/186
 D621,511 S * 8/2010 Lathrop et al. D24/167
 D625,015 S * 10/2010 Hansen et al. D24/186
 D632,397 S * 2/2011 Edwards et al. D24/186
 D642,279 S * 7/2011 Barker et al. D24/186
 D642,691 S * 8/2011 Barker et al. D24/186
 D649,645 S * 11/2011 Barker et al. D24/186
 2001/0023315 A1 9/2001 Flach et al.
 2002/0010797 A1 1/2002 Moulton
 2002/0037035 A1 3/2002 Singh
 2002/0072933 A1 6/2002 Vonk et al.
 2002/0099854 A1 7/2002 Jorgensen
 2002/0143824 A1 10/2002 Lee et al.
 2002/0184384 A1 12/2002 Simmon et al.
 2003/0037043 A1 2/2003 Chang et al.
 2003/0074248 A1 4/2003 Braud et al.
 2003/0233250 A1 12/2003 Joffe et al.
 2004/0044545 A1 3/2004 Wiesmann et al.
 2004/0088374 A1 5/2004 Webb et al.
 2004/0143677 A1 7/2004 Novak
 2004/0172442 A1 9/2004 Ripley
 2004/0176983 A1 9/2004 Birkett et al.
 2004/0215830 A1 10/2004 Shenfield
 2005/0054921 A1 3/2005 Katsman et al.
 2005/0071316 A1 3/2005 Caron
 2005/0071324 A1 3/2005 Bitsch et al.
 2005/0071486 A1 3/2005 Vu et al.
 2005/0091358 A1 4/2005 Mehra et al.
 2005/0154855 A1 7/2005 Harris et al.
 2005/0165947 A1 7/2005 Auriemma et al.
 2005/0198364 A1 9/2005 Val et al.
 2005/0204022 A1 9/2005 Johnston et al.
 2006/0017563 A1 1/2006 Rosenfeld et al.

2006/0069605 A1 3/2006 Hatoun
 2006/0111936 A1 5/2006 Mahesh et al.
 2006/0129435 A1 6/2006 Smitherman et al.
 2006/0168513 A1 7/2006 Coulson et al.
 2006/0229557 A1 10/2006 Fathallah et al.
 2007/0061393 A1 3/2007 Moore
 2007/0156726 A1 7/2007 Levy
 2007/0167694 A1 7/2007 Causevic et al.
 2007/0276261 A1 11/2007 Banet et al.
 2008/0052384 A1 2/2008 Marl et al.
 2008/0055074 A1 3/2008 Gao et al.
 2008/0082683 A1 4/2008 DelloStrito et al.
 2008/0103375 A1 5/2008 Kiani
 2008/0131761 A1 6/2008 Liu et al.
 2008/0133699 A1 6/2008 Crow et al.
 2008/0134133 A1 6/2008 DelloStrito et al.
 2008/0140770 A1 6/2008 DelloStrito et al.
 2008/0249377 A1 10/2008 Molducci et al.
 2008/0281168 A1 11/2008 Gibson et al.
 2009/0037514 A1 2/2009 Lankford et al.
 2009/0143652 A1 6/2009 Warburton et al.
 2009/0149927 A1 6/2009 Kneuer et al.
 2009/0240116 A1 9/2009 Bluth
 2009/0275810 A1 11/2009 Ayers et al.
 2009/0306488 A1 12/2009 Al-Ali et al.
 2010/0005448 A1 1/2010 Dellostrito et al.

FOREIGN PATENT DOCUMENTS

WO WO 03/067842 8/2003
 WO WO 2006/105139 10/2006

OTHER PUBLICATIONS

Fingertip Pulse Oximeter SPO2 Monitor Oxigen Oximeter; Copyright 1995-2010, accessed at: [http://74.125.45.132/search?q=cache:ANfHne9je7gJ:cig.ebay.com.sg/ws/eBayISAPI.dll%3FViewItem%26item%3D260412542031+*Fingertip+Pulse+Oximeter+SPO2=Monitor+Oxigen+Oximeter"&cd=2&hl=en&ct=cluk&gl=us](http://74.125.45.132/search?q=cache:ANfHne9je7gJ:cig.ebay.com.sg/ws/eBayISAPI.dll%3FViewItem%26item%3D260412542031+*Fingertip+Pulse+Oximeter+SPO2=Monitor+Oxigen+Oximeter); 6 pages.
 Handheld Pulse Oximeter PM-60A, Contec Medical System Co. Ltd., Jul. 31, 2009; accessed at: <http://www.tradeindia.com/selloffer/1858593/Handheld-Pulse-Oximeter-PM-60A.html>; 5 pages.
 International Search Report and Written Opinion for International Application No. PCT/US2006/011373, mailed Feb. 6, 2008 (12 pages).
 Multiple Vital Signs from One Non-invasive Sensor, Starr™ Life Sciences Corp., Copyright 2009, accessed at: <http://www.star-rlifesciences.com/mouseox.html>; 1 page.
 NTIA Handheld Pulse Oximeter, Frontline Systems; Dec. 31, 2009, accessed at: <http://www.tradeindia.com/fp385774/NTIA-Handheld-Pulse-Oximeter.html>; 3 pages.
 Portable Patient Monitors, Welch Allyn, Copyright 2005-2006 Med-Direct, Copyright 2005-2006, accessed at: <http://www.meddirect.co.nz/Product.aspx?ProductId=3476>; 1 page.
 U.S. Appl. No. 12/751,602, filed Mar. 31, 2010.
 U.S. Appl. No. 29/353,090, filed Dec. 31, 2009.

* cited by examiner

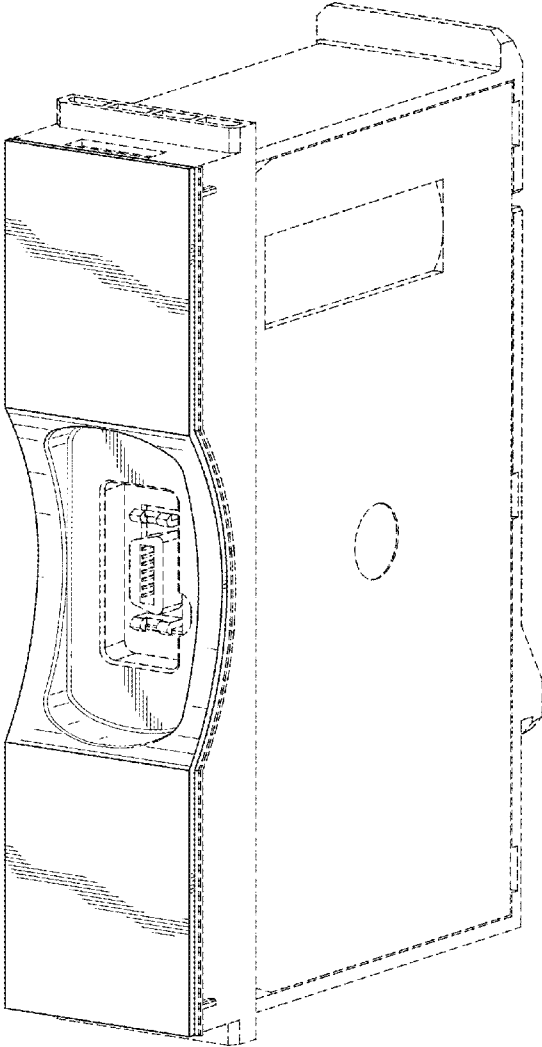

FIG. 1

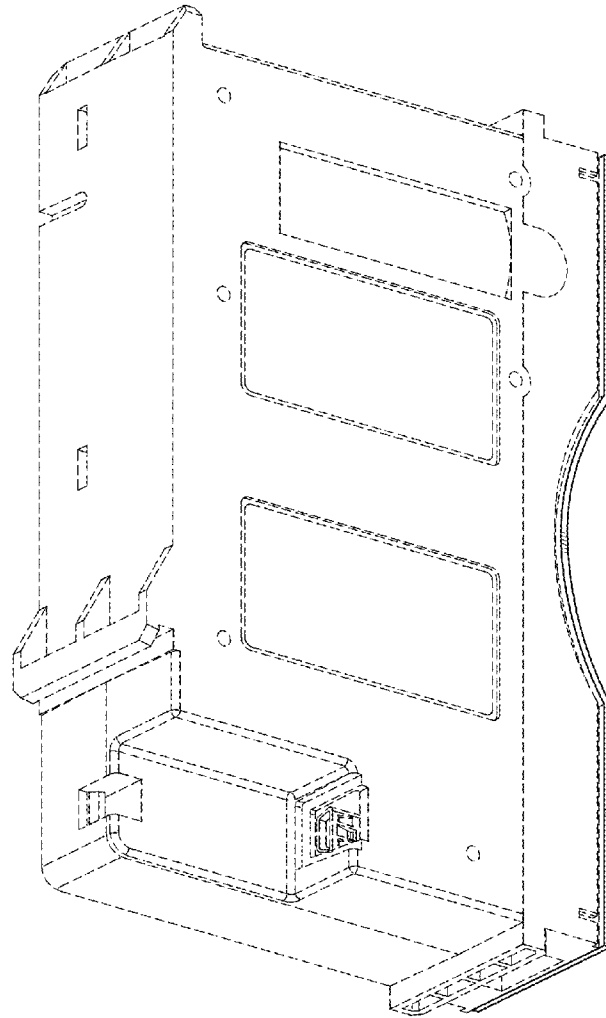

FIG. 2

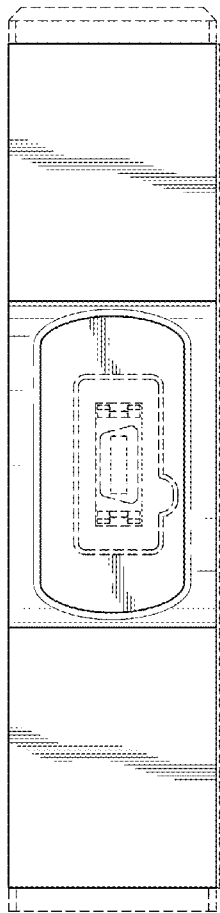

FIG. 3

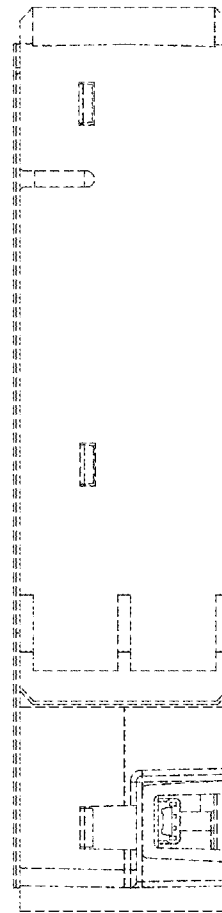

FIG. 4

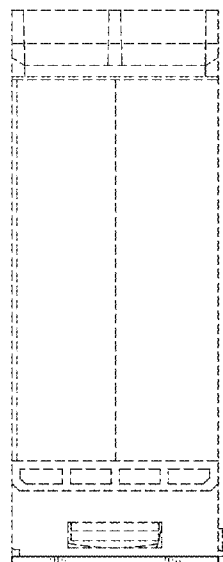

FIG. 5

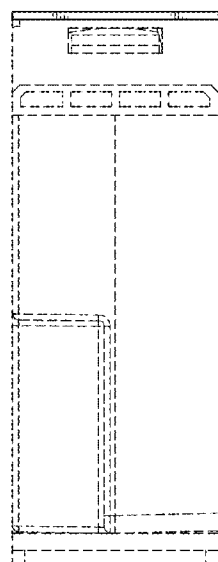

FIG. 6

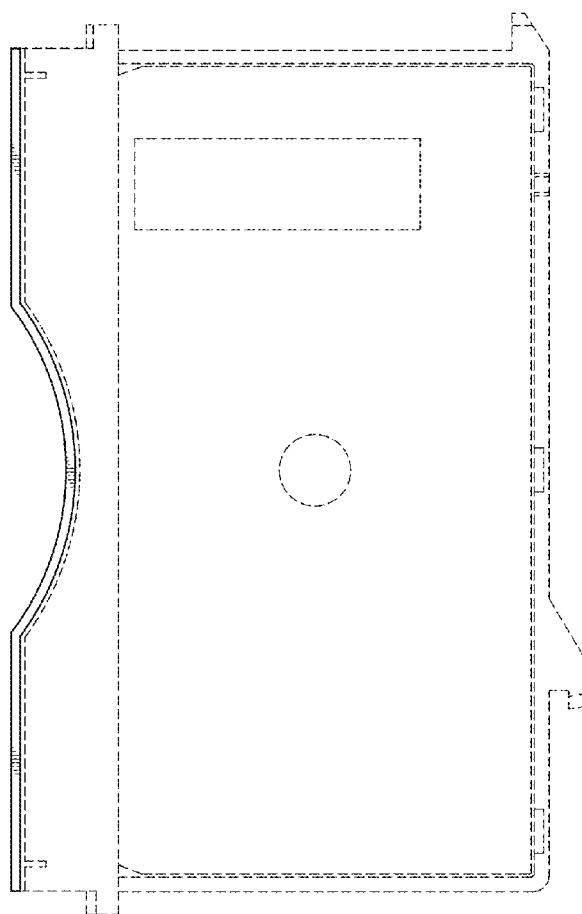

FIG. 7

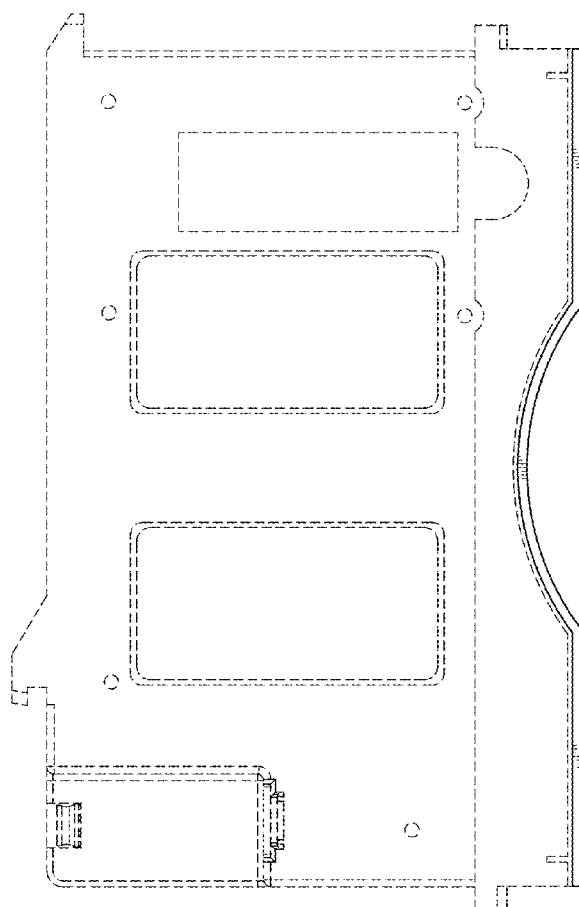

FIG. 8