



US00D663944S

(12) **United States Design Patent**
Bouskill

(10) **Patent No.:** **US D663,944 S**

(45) **Date of Patent:** **** *Jul. 24, 2012**

(54) **ZIPPERED MEDICATION STORAGE PACK**

(76) Inventor: **Patricia Ann Bouskill**, Placentia, CA (US)

(*) Notice: This patent is subject to a terminal disclaimer.

(**) Term: **14 Years**

(21) Appl. No.: **29/373,214**

(22) Filed: **Mar. 18, 2011**

(51) **LOC (9) Cl.** **03-01**

(52) **U.S. Cl.** **D3/203.1; D3/226**

(58) **Field of Classification Search** D3/201-206,
D3/224, 226, 265, 272-273, 283-289, 301,
D3/303, 900, 902, 5; 206/308.1, 570, 581,
206/810, 828, 223; D7/601-602, 605-609;
D6/631

See application file for complete search history.

(56) **References Cited**

U.S. PATENT DOCUMENTS

D359,163 S *	6/1995	Summerfield et al.	D3/205
D382,703 S *	8/1997	Alves et al.	D3/201
D389,647 S *	1/1998	White	D3/301

D393,947 S *	5/1998	Alves et al.	D3/303
D552,348 S *	10/2007	Martin	D3/265
D593,317 S *	6/2009	Yao et al.	D3/203.6
D603,167 S *	11/2009	Becker	D3/301

* cited by examiner

Primary Examiner — Catheri Oliver

(57) **CLAIM**

The ornamental design for a zippered medication storage pack, as shown and described.

DESCRIPTION

FIG. 1 is a front, top, and side perspective view of a zippered medication storage pack showing my new design; FIG. 2 is a rear, bottom, and side perspective view thereof; FIG. 3 is a front elevational view thereof; FIG. 4 is a rear elevational view thereof; FIG. 5 is a side elevational view thereof; FIG. 6 is an opposite side elevational view thereof; FIG. 7 is a top plan view thereof; FIG. 8 is a bottom plan view thereof; and, FIG. 9 is an open perspective view thereof with broken lines showing of environmental association matter being for illustrative purposes only and forming no part of the claimed design.

1 Claim, 7 Drawing Sheets

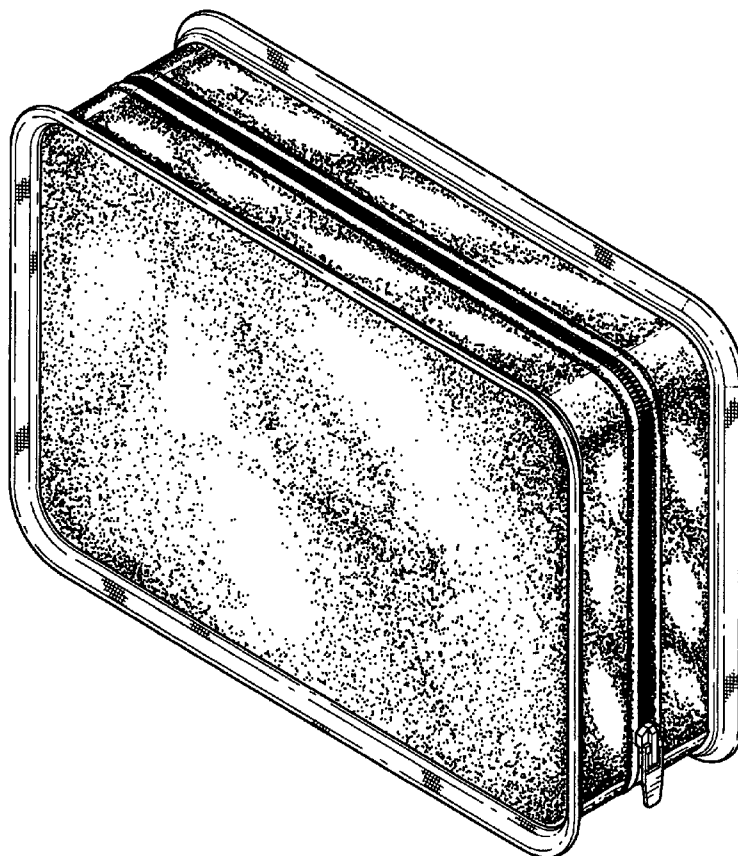

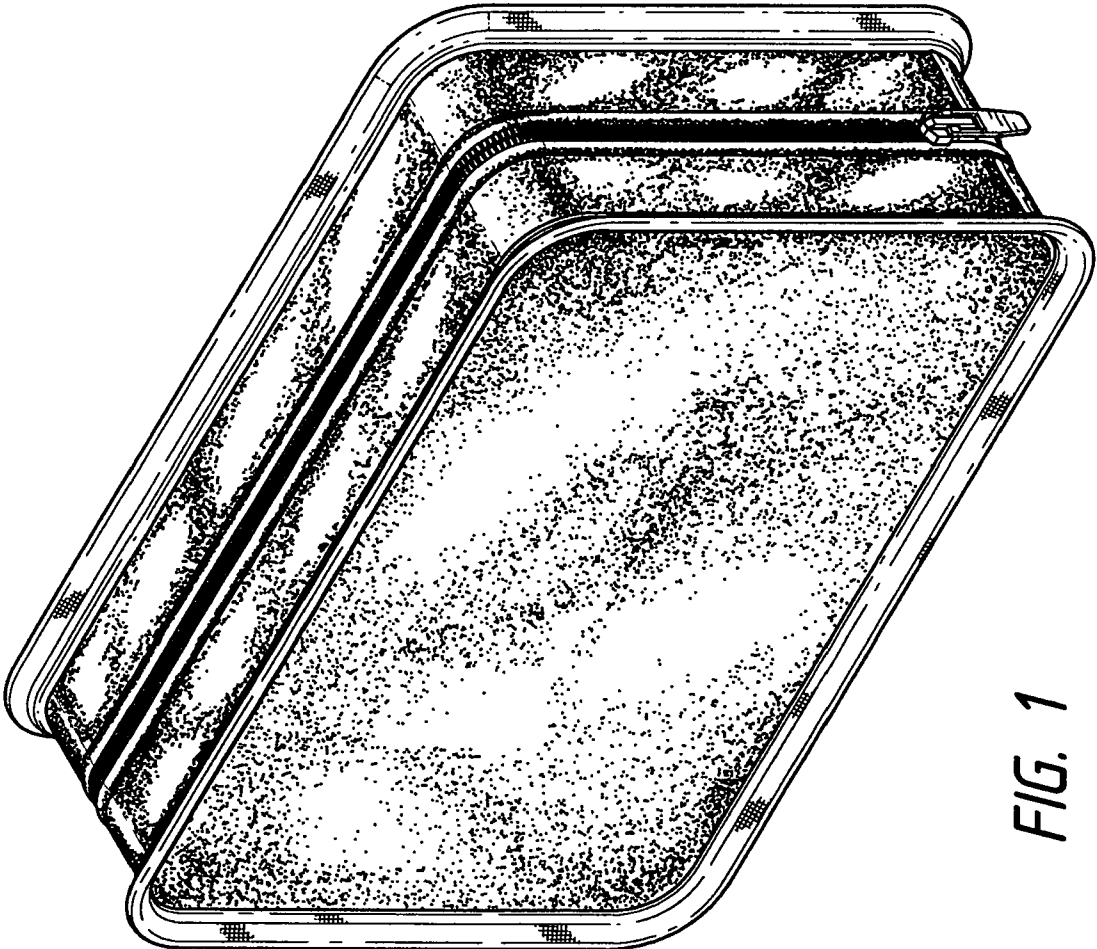

FIG. 1

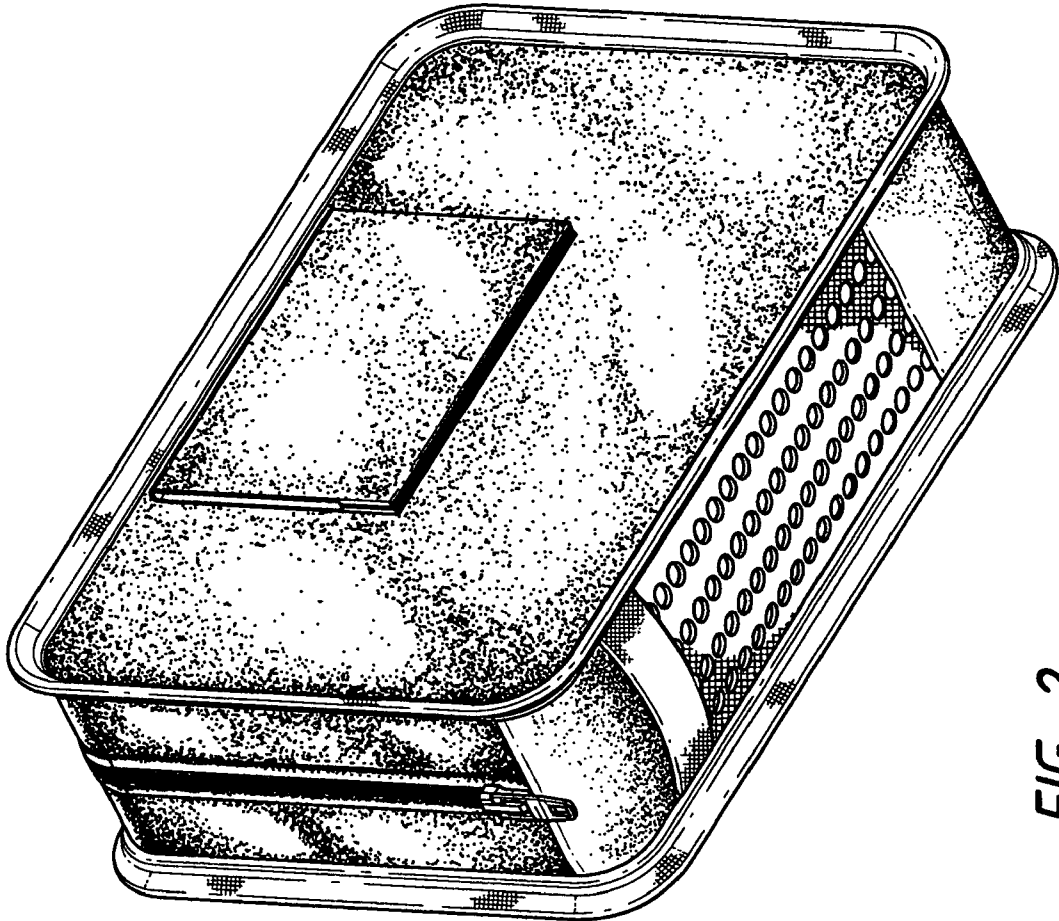

FIG. 2



FIG. 3

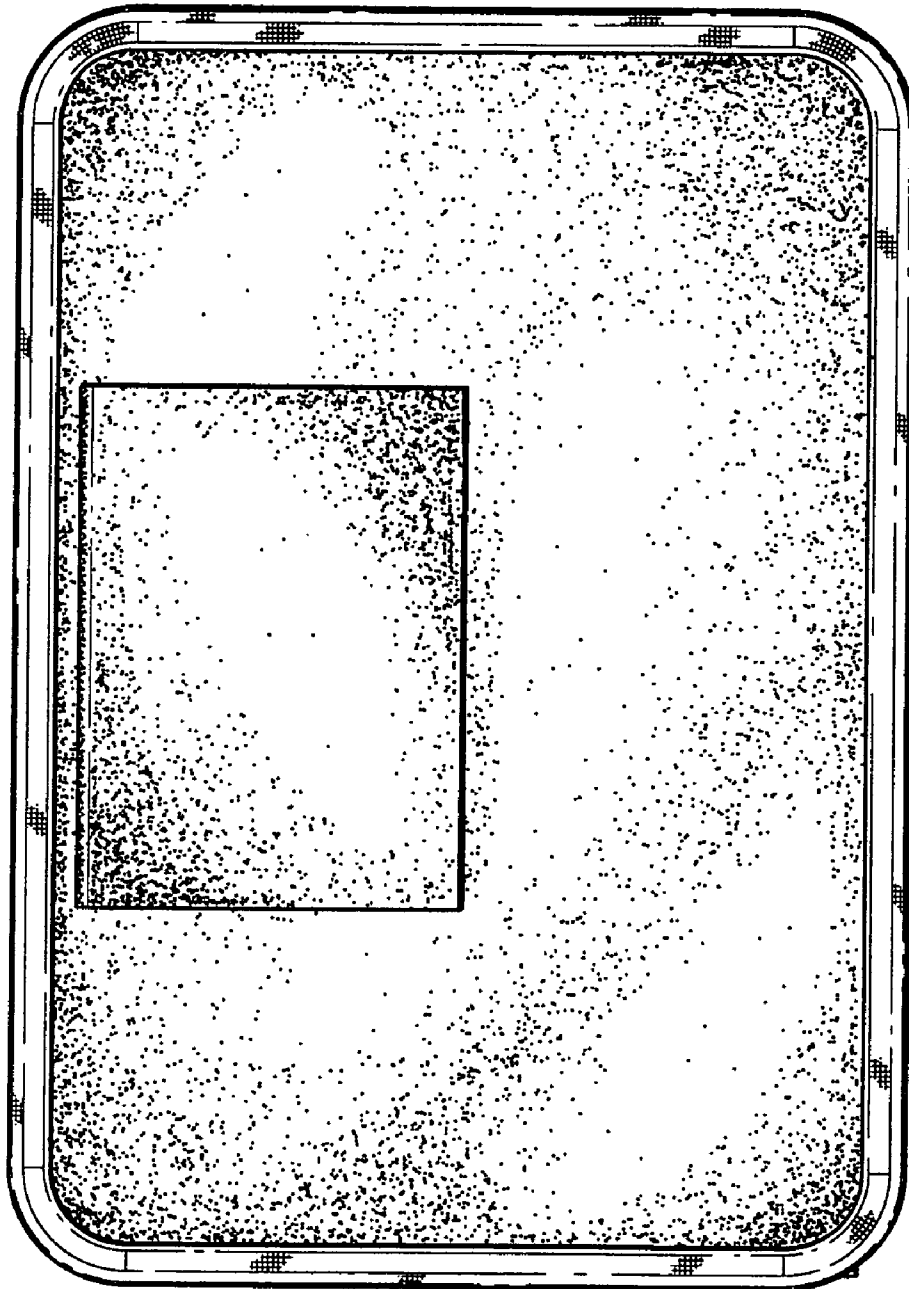

FIG. 4

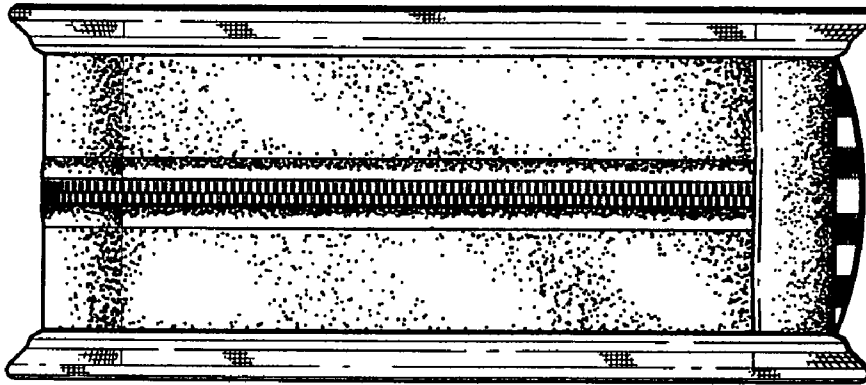

FIG. 6

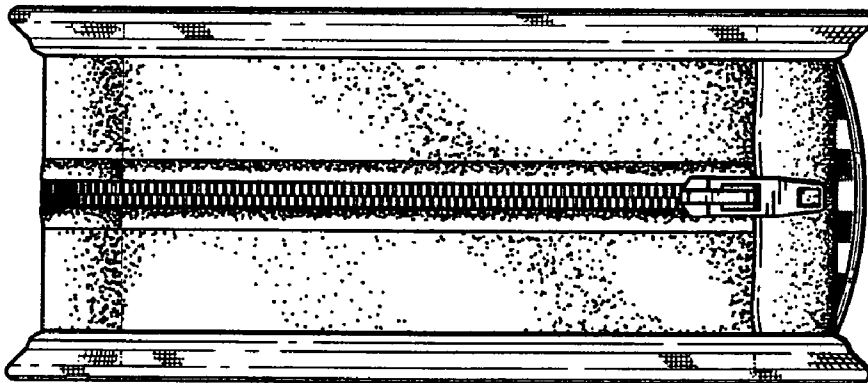

FIG. 5

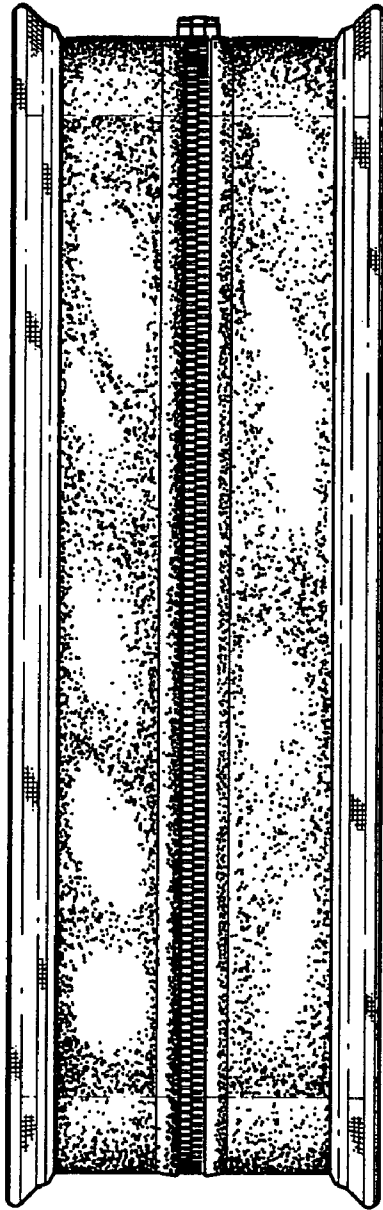

FIG. 7

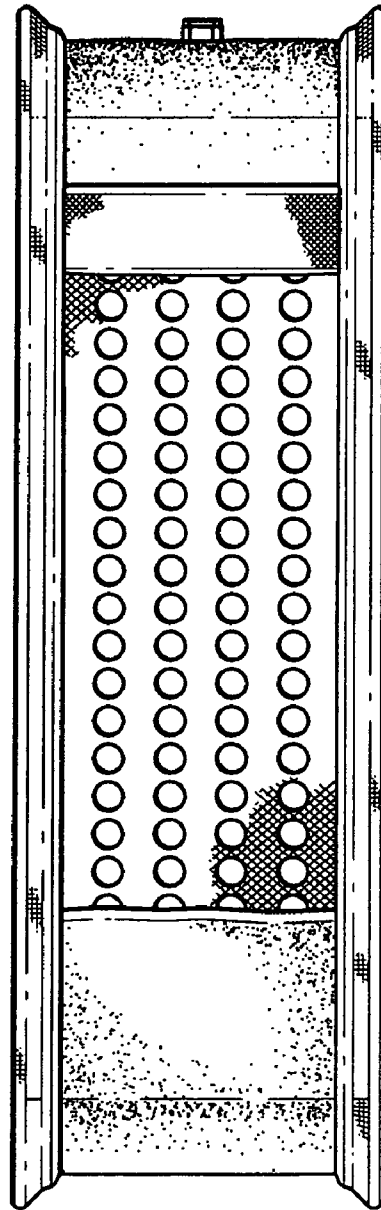

FIG. 8

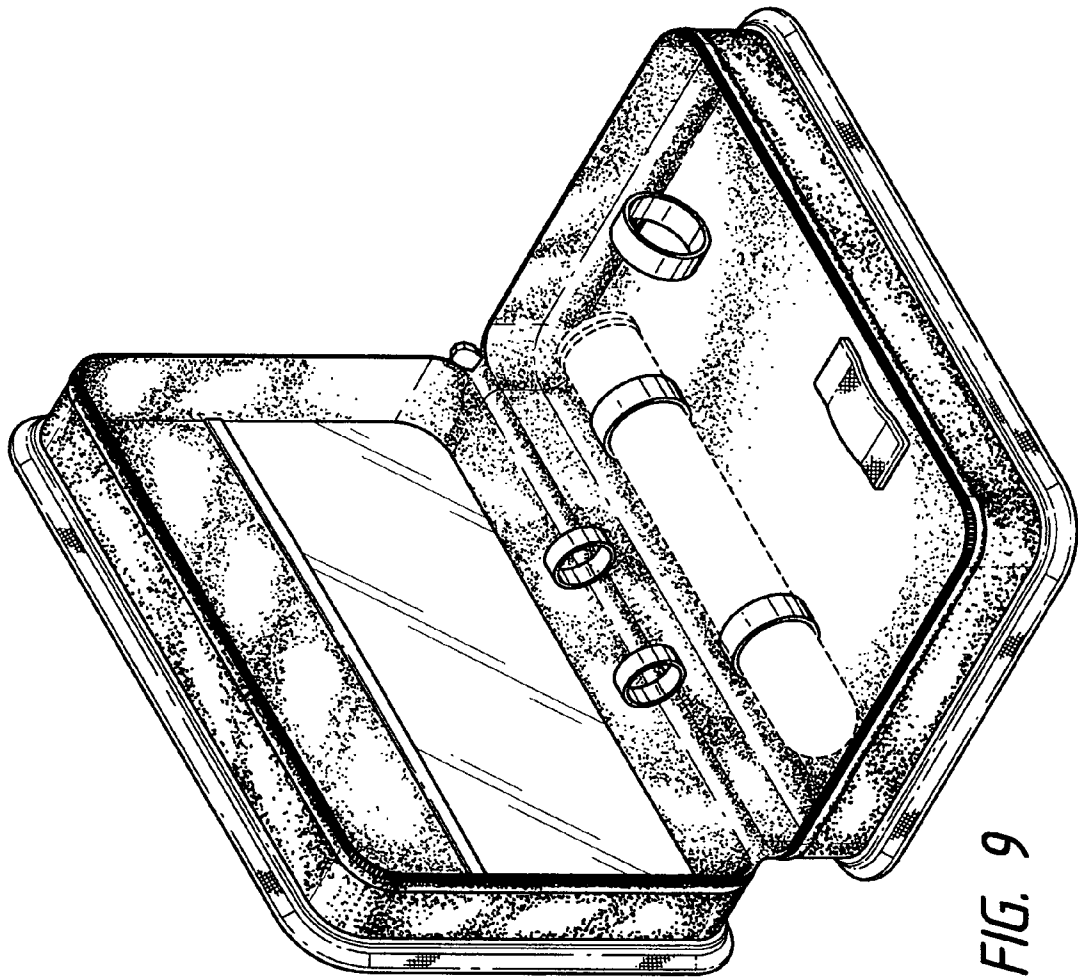

FIG. 9