



US00D988860S

(12) **United States Design Patent**
Marotti et al.

(10) **Patent No.:** **US D988,860 S**

(45) **Date of Patent:** **** Jun. 13, 2023**

(54) **TOOTHPASTE CARTON**

OTHER PUBLICATIONS

(71) Applicant: **The Procter & Gamble Company**,
Cincinnati, OH (US)

How to treat Sensitive Teeth | Crest Gum Detoxify Toothpaste on YouTube. Date posted: Jan. 19, 2020. Site visited: Oct. 24, 2022. Available online: <https://www.youtube.com/watch?v=Hqit3wOZUio> (Year: 2020).*

(72) Inventors: **Martin Jay Marotti**, Carmel, IN (US);
Jennifer Kay Seiser, Cincinnati, OH (US);
Eric Donald Weller, Liberty Township, OH (US);
Geraldine Uribe, Mason, OH (US)

(Continued)

Primary Examiner — Catherine S Posthauer
Assistant Examiner — Joan E. Diehl

(73) Assignee: **The Procter & Gamble Company**,
Cincinnati, OH (US)

(74) *Attorney, Agent, or Firm* — Elizabeth A. Conklin

(**) Term: **15 Years**

(57) **CLAIM**

(21) Appl. No.: **29/771,563**

The ornamental design for a toothpaste carton, as shown and described.

(22) Filed: **Feb. 24, 2021**

DESCRIPTION

Related U.S. Application Data

The file of this patent contains at least one drawing/photograph executed in color. Copies of this patent with color drawing(s)/photograph(s) will be provided by the Office upon request and payment of the necessary fee.

(62) Division of application No. 29/717,335, filed on Dec. 17, 2019, now Pat. No. Des. 923,471.

(51) **LOC (14) Cl.** **09-03**

FIG. 1 is a perspective view of a toothpaste carton;

(52) **U.S. Cl.**

FIG. 2 is a front view thereof;

USPC **D9/432**

FIG. 3 is a right side view thereof;

(58) **Field of Classification Search**

FIG. 4 is a back view thereof;

USPC D9/414, 415, 416, 418, 420, 423, 425,
D9/432, 433, 454, 630, 703, 713; D5/56,
(Continued)

FIG. 5 is a left side view thereof;

FIG. 6 is a top view thereof; and

FIG. 7 is a bottom view thereof.

(56) **References Cited**

FIG. 8 is a perspective view of a toothpaste carton;

U.S. PATENT DOCUMENTS

FIG. 9 is a front view thereof;

FIG. 10 is a right side view thereof;

FIG. 11 is a back view thereof;

FIG. 12 is a left side view thereof;

D40,754 S * 7/1910 Ritter D19/1
D216,871 S 3/1970 Leis

(Continued)

FIG. 13 is a top view thereof; and,

FIG. 14 is a bottom view thereof.

FOREIGN PATENT DOCUMENTS

CN 203143144 U * 8/2013
CN 208842987 U * 5/2019

(Continued)

The broken lines shown in the drawings are for the purpose of illustrating parts of the article that form no part of the claimed design. The dot-dash broken lines shown in the drawings are for the purpose of illustrating a boundary that forms no part of the claimed design.

(Continued)

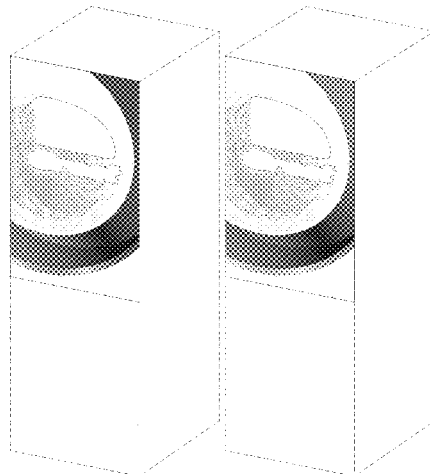

Crest™ is a registered trademark from The Procter and Gamble Company forming no part of the claimed design.

**1 Claim, 8 Drawing Sheets
(4 of 8 Drawing Sheet(s) Filed in Color)**

(58) **Field of Classification Search**

USPC D5/59, 60, 62; D7/601, 602, 607, 609,
D7/703; D27/175, 186; D20/11; D19/1,
D19/5; D28/66
CPC B65D 1/00; B65D 1/02; B65D 1/0223;
B65D 1/40; B65D 35/34; B65D 75/32;
B65D 77/24; B65D 5/00; B65D 2203/00;
B65D 2203/02; B65D 65/22
See application file for complete search history.

(56) **References Cited**

U.S. PATENT DOCUMENTS

D275,837 S 10/1984 Poelvoorde
D420,910 S * 2/2000 Brown D9/432
D496,274 S * 9/2004 Egawa D9/432
D499,019 S 11/2004 Sagmeister et al.
D542,131 S * 5/2007 Egawa D9/432
D586,210 S 2/2009 Noschang et al.
D595,129 S 6/2009 Russell et al.
D629,044 S 12/2010 Suyama et al.
D637,486 S 5/2011 Andrew
D649,874 S 12/2011 Barclay et al.
D660,145 S 5/2012 Tekulve et al.
D669,793 S 10/2012 Hynes et al.
D693,681 S 11/2013 Allen et al.
D701,760 S 4/2014 Fraser et al.
D706,630 S 6/2014 Merchant et al.
D711,737 S 8/2014 Hara et al.
D730,176 S * 5/2015 Allen D9/432
D750,899 S 3/2016 Duparc
D750,900 S 3/2016 Duparc
D762,465 S 8/2016 Popper et al.
D767,398 S 9/2016 Miyazaki et al.
D770,275 S * 11/2016 Hainaut D9/432
D784,455 S 4/2017 Sims et al.
D786,680 S 5/2017 Merchant et al.

D791,594 S 7/2017 Klarin
D795,073 S * 8/2017 Powers D9/434
D798,703 S 10/2017 Hainaut et al.
D821,199 S 6/2018 Boston et al.
D822,480 S 7/2018 Rivera
D822,481 S 7/2018 Rivera
D829,105 S 9/2018 Templeman
D833,868 S 11/2018 Marotti
D842,101 S 3/2019 Breen et al.
D842,102 S 3/2019 Janes et al.
D842,692 S 3/2019 Breen et al.
D842,693 S 3/2019 Janes et al.
D842,694 S 3/2019 Janes et al.
D852,820 S 7/2019 Sanchez
D854,551 S 7/2019 Pistiner et al.
D855,452 S 8/2019 Palacios et al.
D870,551 S 12/2019 Klesmith
D871,210 S 12/2019 Clifton
D880,293 S 4/2020 Redding
D883,088 S * 5/2020 Riffe D9/434
D897,196 S * 9/2020 Lyle D9/414
D945,260 S 3/2022 Marotti et al.

FOREIGN PATENT DOCUMENTS

RU 00087183 12/2013
WO D208728006 12/2020
WO D208728008 12/2020
WO D208728009 12/2020
WO D208728010 12/2020

OTHER PUBLICATIONS

Crest Pro Health Gum Restore Advanced Whitening Toothpaste.
Date first available: Mar. 23, 2021. Site visited: Oct. 24, 2022.
Available online: <https://www.amazon.com/Crest-Restore-Advanced-Whitening-Toothpaste/dp/B08ZT1F1K8> (Year: 2021).
*
“Amazon Crest Gum Repair Toothpaste: Announced Oct. 6, 2019, online]. Site Visited [Dec. 17, 2020, online], Available from Internet URL: <https://www.amazon.com/Crest-Enamel-Toothpaste-Advanced-Whitening/dp/B07K11XWXY> (see wayback machine for date) (Year: 2019)”.
“All Office Actions, U.S. Appl. No. 29/717,335”.
“All Office Actions, U.S. Appl. No. 29/771,561”.
“All Office Actions, U.S. Appl. No. 29/771,562”.

* cited by examiner

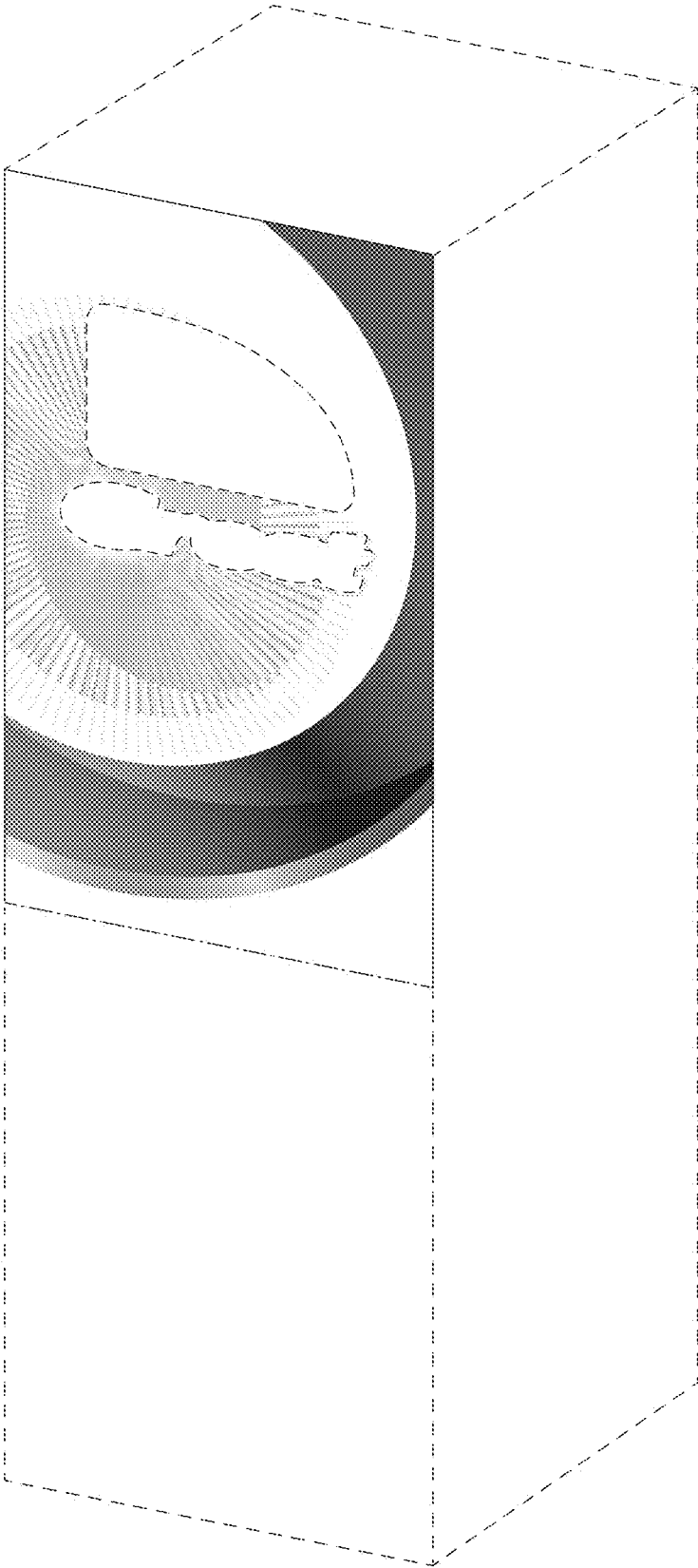

FIG. 1

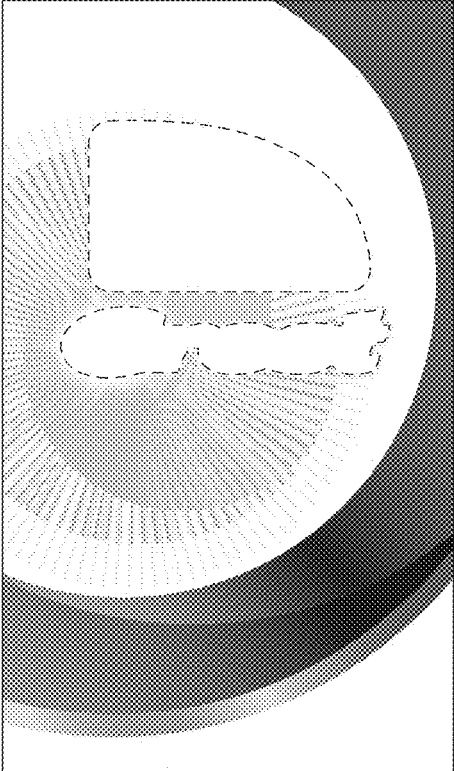

FIG. 2

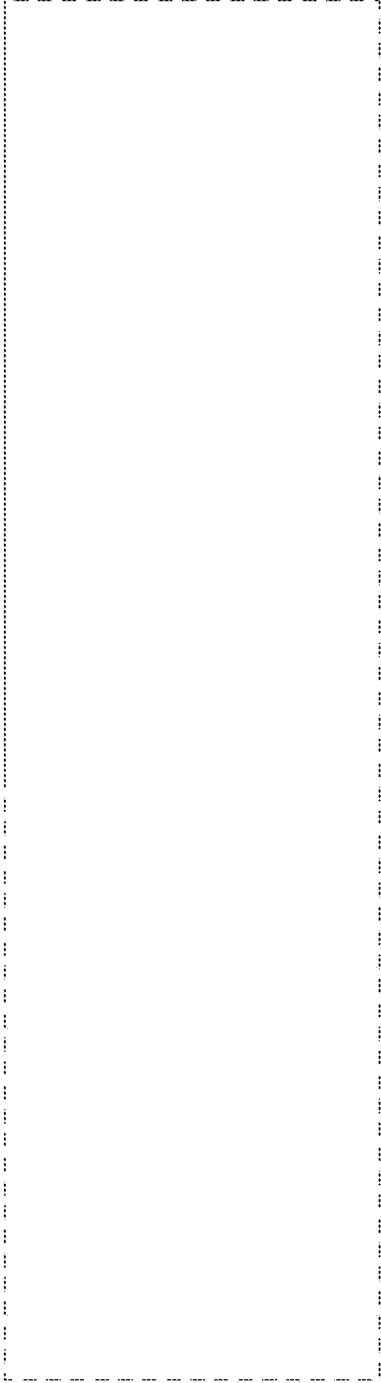

FIG. 3

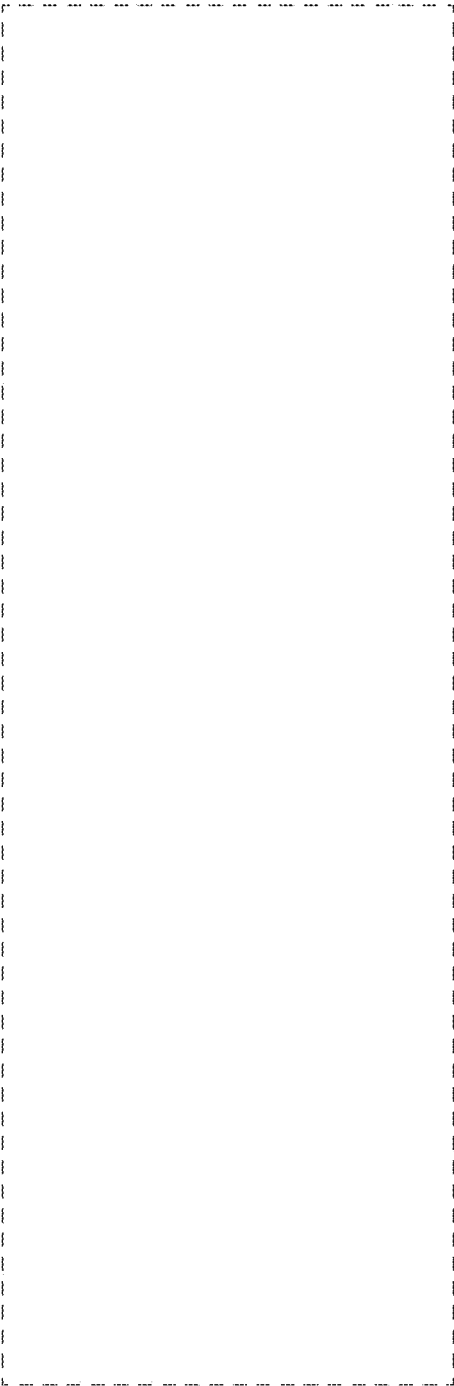

FIG. 4

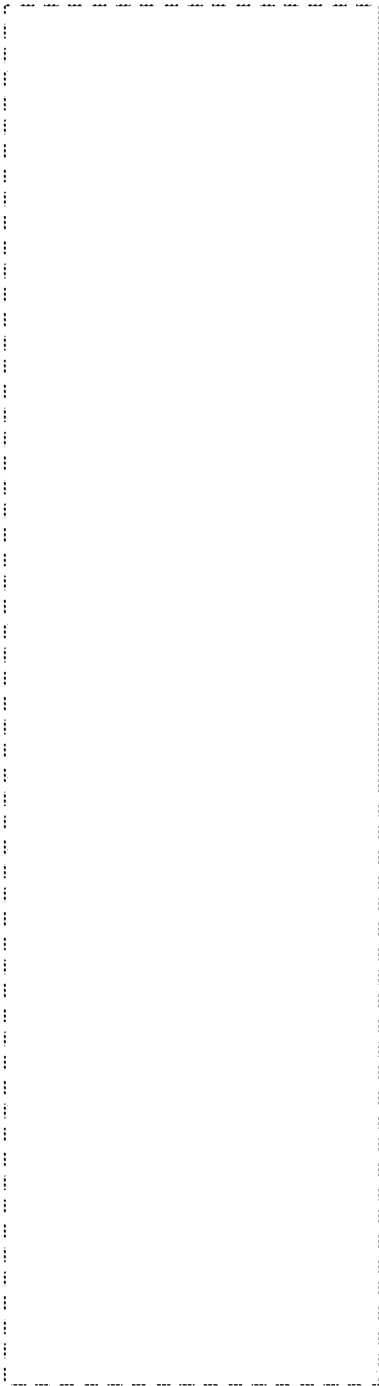

FIG. 5



FIG. 6

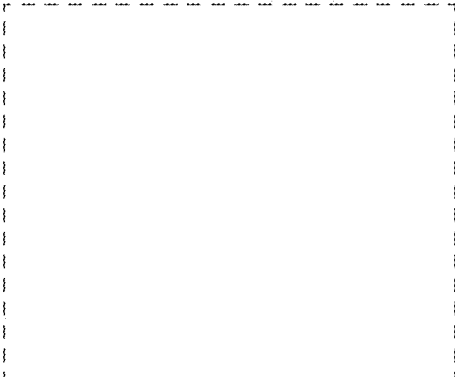

FIG. 7

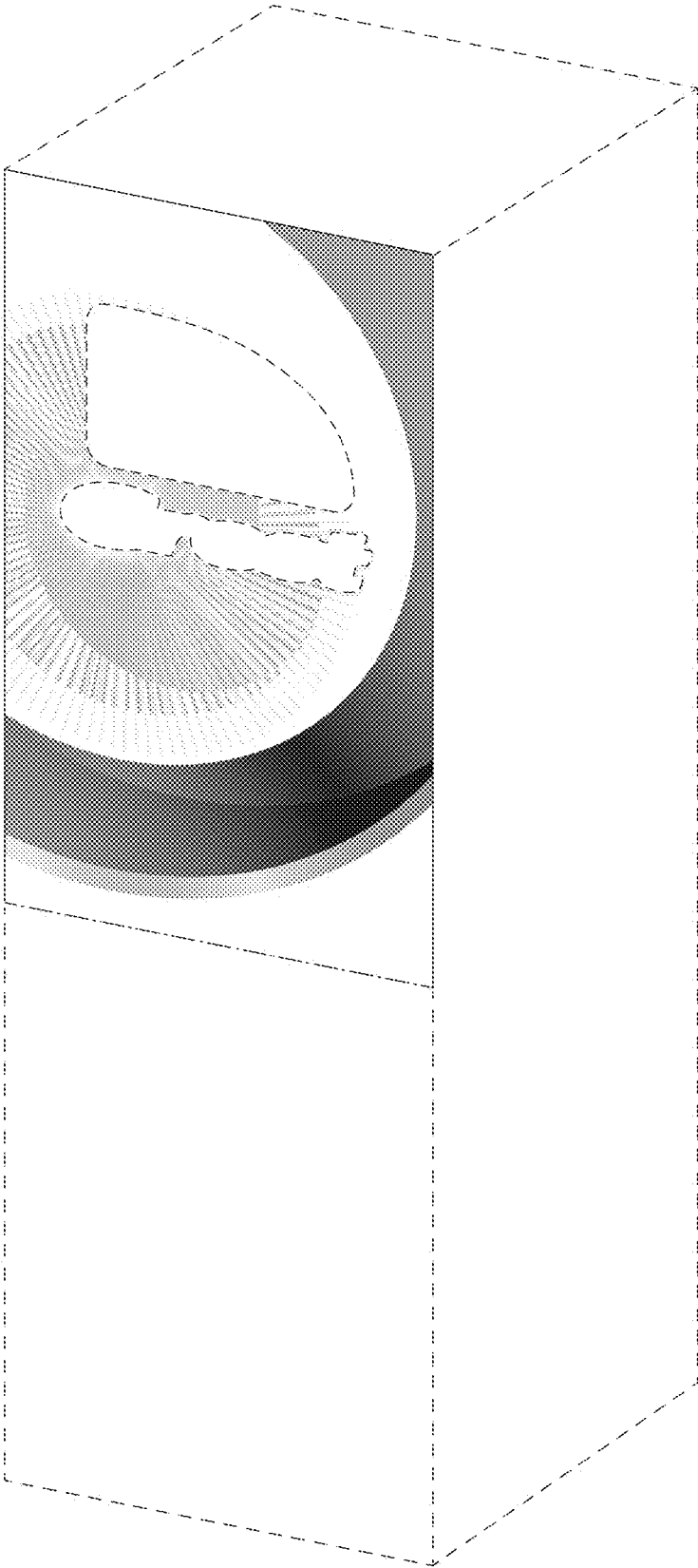

FIG. 8

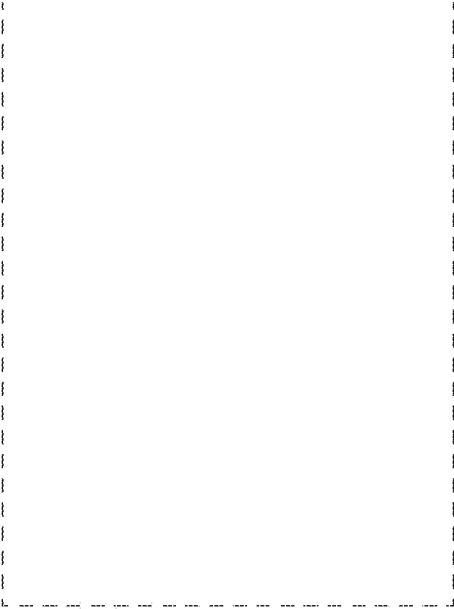
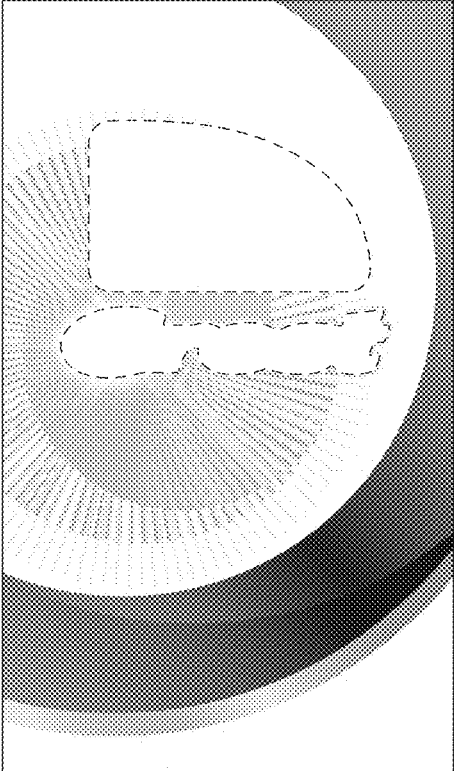

FIG. 9

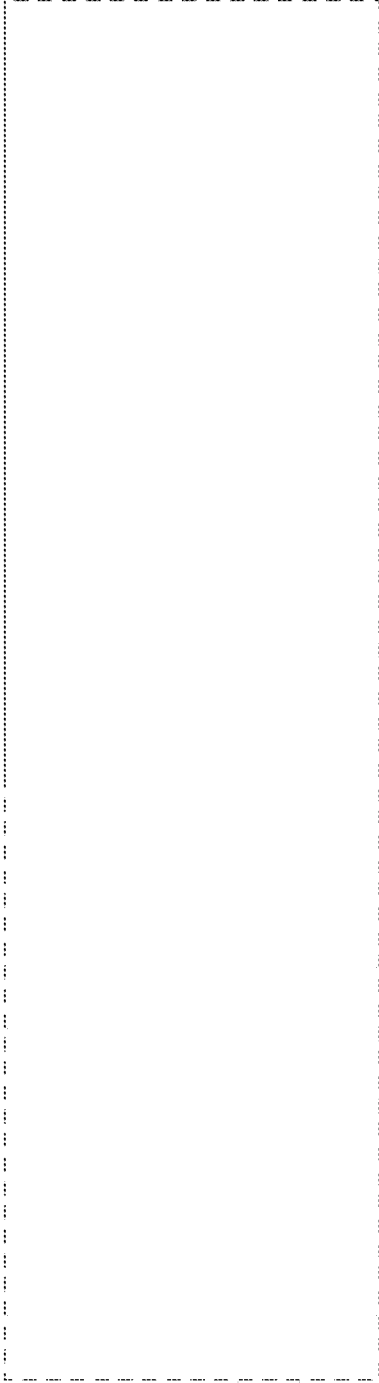

FIG. 10

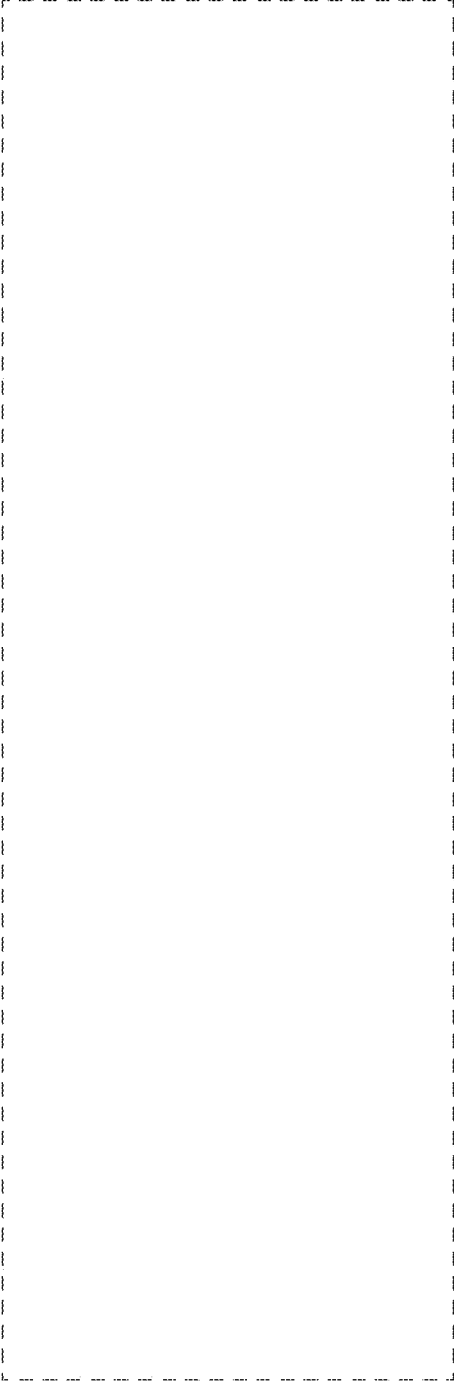

FIG. 11

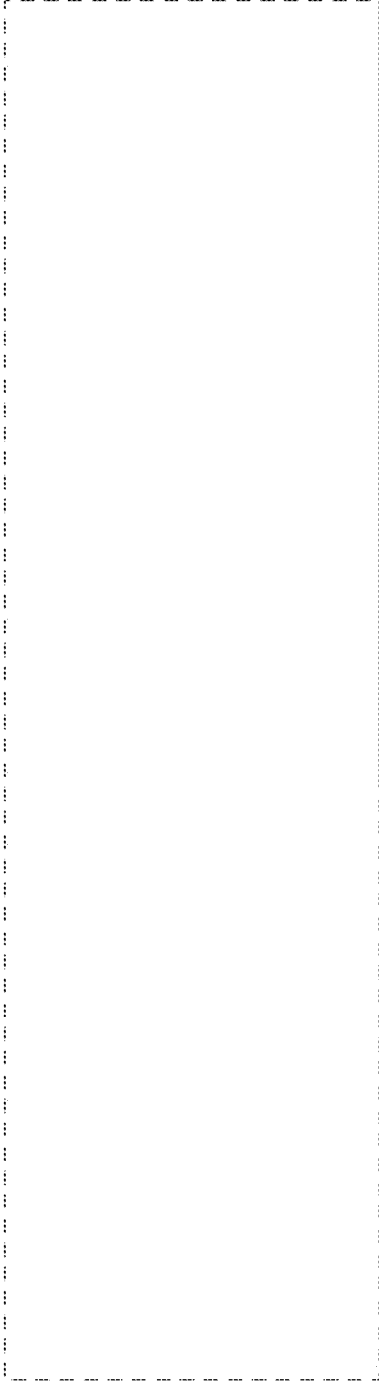

FIG. 12



FIG. 13

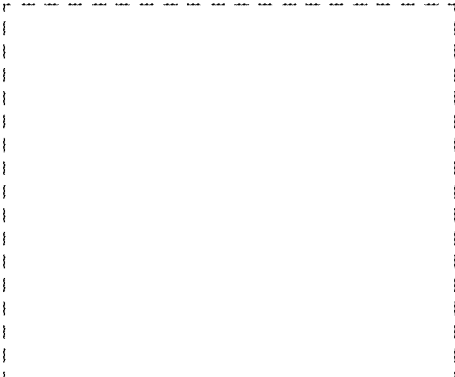

FIG. 14