



US00D860639S

(12) **United States Design Patent** (10) **Patent No.:** **US D860,639 S**  
**Thibadeau** (45) **Date of Patent:** **\*\* Sep. 24, 2019**

- (54) **BAG**
- (71) Applicant: **Thule, Inc.**, Seymour, CT (US)
- (72) Inventor: **Mark Thibadeau**, Boulder, CO (US)
- (73) Assignee: **Thule, Inc.**, Seymour, CT (US)
- (\*\*) Term: **15 Years**
- (21) Appl. No.: **29/679,998**
- (22) Filed: **Feb. 12, 2019**

D734,948 S	7/2015	Farrelly	
D745,777 S	12/2015	Zwetzig et al.	
D748,910 S *	2/2016	Ford	D3/217
D759,369 S	6/2016	Mei Yee	
9,642,443 B2	5/2017	Amago	
D819,328 S *	6/2018	Muhlenkamp, IV	D3/217
D831,952 S *	10/2018	Pennington	D3/217
D836,326 S *	12/2018	Skaff	D3/217
D843,714 S *	3/2019	Sheikh	D3/217

(Continued)

**OTHER PUBLICATIONS**

Amazon, "Thule Subterra Backpack 34L", First reviewed on Apr. 24, 2017. (<https://www.amazon.com/Thule-3203442-Subterra-Backpack-34L/dp/B079C97DTV>) (Year: 2017).\*

(Continued)

*Primary Examiner* — Jennifer Rivard  
*Assistant Examiner* — April Rivas  
(74) *Attorney, Agent, or Firm* — Sterne, Kessler, Goldstein & Fox P.L.L.C.

**Related U.S. Application Data**

- (63) Continuation of application No. 29/605,502, filed on May 26, 2017, now Pat. No. Des. 840,682.
- (51) **LOC (12) Cl.** ..... **03-01**
- (52) **U.S. Cl.**  
USPC ..... **D3/217**
- (58) **Field of Classification Search**  
USPC ..... D3/201, 215, 216, 217, 218, 222, 273, D3/276, 284, 285, 289, 290, 291, 900  
CPC ..... A45C 3/02; A45C 2003/008; A45C 5/03; A45C 2011/003; A45C 5/00; A45C 2005/032; A45C 5/08; A45C 5/14; A45F 3/04  
See application file for complete search history.

(57) **CLAIM**

The ornamental design for a bag, as shown and described.

**DESCRIPTION**

FIG. 1 is a top front perspective view of a bag showing the claimed design;  
FIG. 2 is a front view thereof;  
FIG. 3 is a rear view thereof;  
FIG. 4 is a right side view thereof;  
FIG. 5 is a left side view thereof;  
FIG. 6 is a top view thereof; and,  
FIG. 7 is a bottom view thereof.  
The broken lines in the figures show portions of the bag that form no part of the claimed design.  
The hatched lines in the figures show shading and not surface ornamentation.

(56) **References Cited**  
U.S. PATENT DOCUMENTS

D448,160 S	9/2001	Sijmons et al.
D449,162 S	10/2001	Sijmons et al.
D511,620 S	11/2005	Van Himbeek
D603,163 S	11/2009	Van Himbeek
D641,973 S	7/2011	Quehl
D674,591 S	1/2013	Hargens et al.
D706,534 S	6/2014	Zwetzig
D708,845 S	7/2014	Taylor
D709,689 S	7/2014	Brunazzi et al.

**1 Claim, 7 Drawing Sheets**



(56)

**References Cited**

## U.S. PATENT DOCUMENTS

D844,319 S \* 4/2019 Tan ..... D3/217  
D844,975 S \* 4/2019 Munie ..... D3/217  
2009/0283564 A1 \* 11/2009 Bass ..... A45C 13/1046  
224/656  
2015/0034690 A1 \* 2/2015 Shannon ..... A45F 3/04  
224/637  
2015/0351510 A1 \* 12/2015 Zwetzig ..... A45C 11/38  
206/316.2  
2017/0196345 A1 \* 7/2017 Meyer ..... A45F 3/04  
2018/0116359 A1 \* 5/2018 Demke ..... A45C 13/40

## OTHER PUBLICATIONS

Amazon, "Arcido Faroe Backpack . . .", First on sale Sep. 27, 2016. (<https://www.amazon.com/dp/B01N9IRMET/>) (Year: 2016).\*

Thule.com, "Thule Crossover Carry-on 56cm/22"" <[https://www.thule.com/en/se/luggage/carry-on-luggage/thule-crossover-carry-on-56cm22-\\_tl\\_85854224291](https://www.thule.com/en/se/luggage/carry-on-luggage/thule-crossover-carry-on-56cm22-_tl_85854224291)>, accessed Aug. 24, 2017.

Thule.com, "Thule Crossover Rolling Duffel 87L" <[https://www.thule.com/en/se/luggage/travel-duffel-bags/thule-crossover-rolling-duffel-87l-\\_tl\\_85854214261](https://www.thule.com/en/se/luggage/travel-duffel-bags/thule-crossover-rolling-duffel-87l-_tl_85854214261)>, accessed Aug. 24, 2017.

Amazon, "Thule Subterra Carry-on Rolling Duffel 36L", First reviewed on May 5, 2017. (<https://www.amazon.com/Thule-Subterra-3203446-Carry-Shadow/dp/801NCM2CN7>) (Year: 2017).

\* cited by examiner

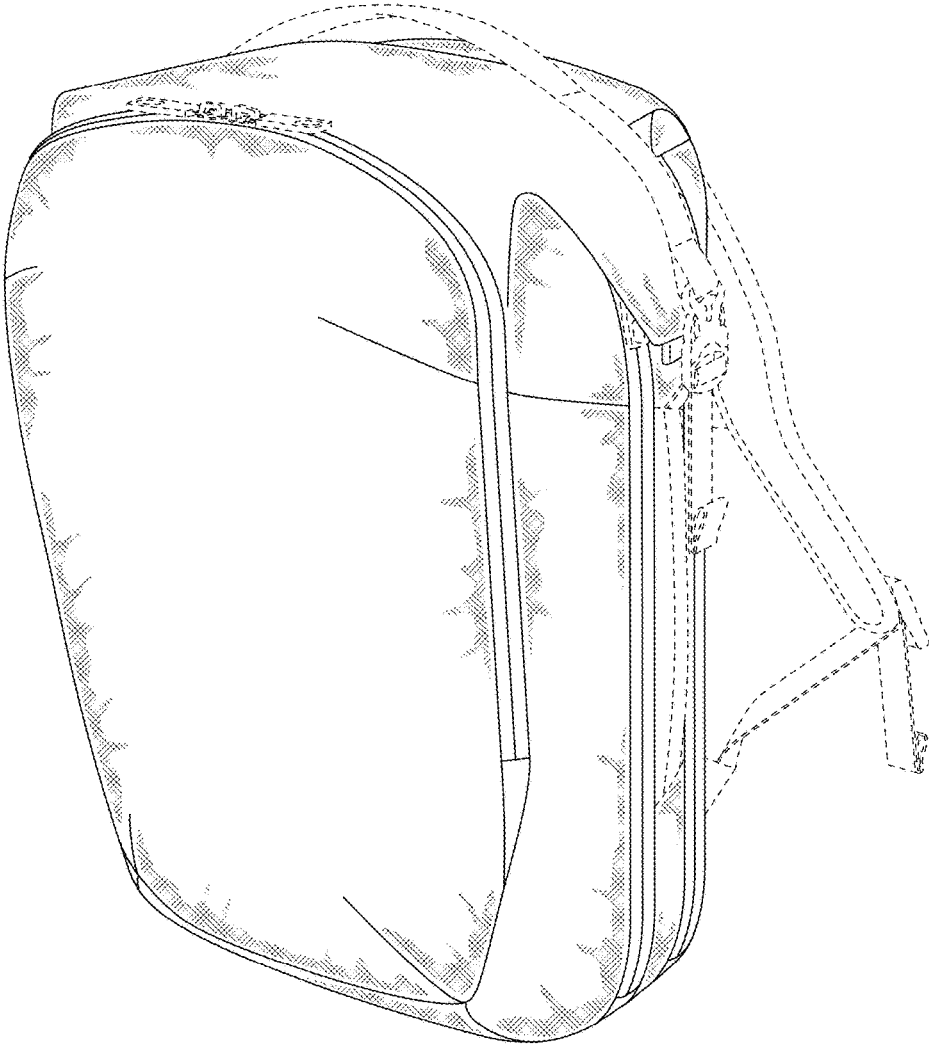

FIG. 1

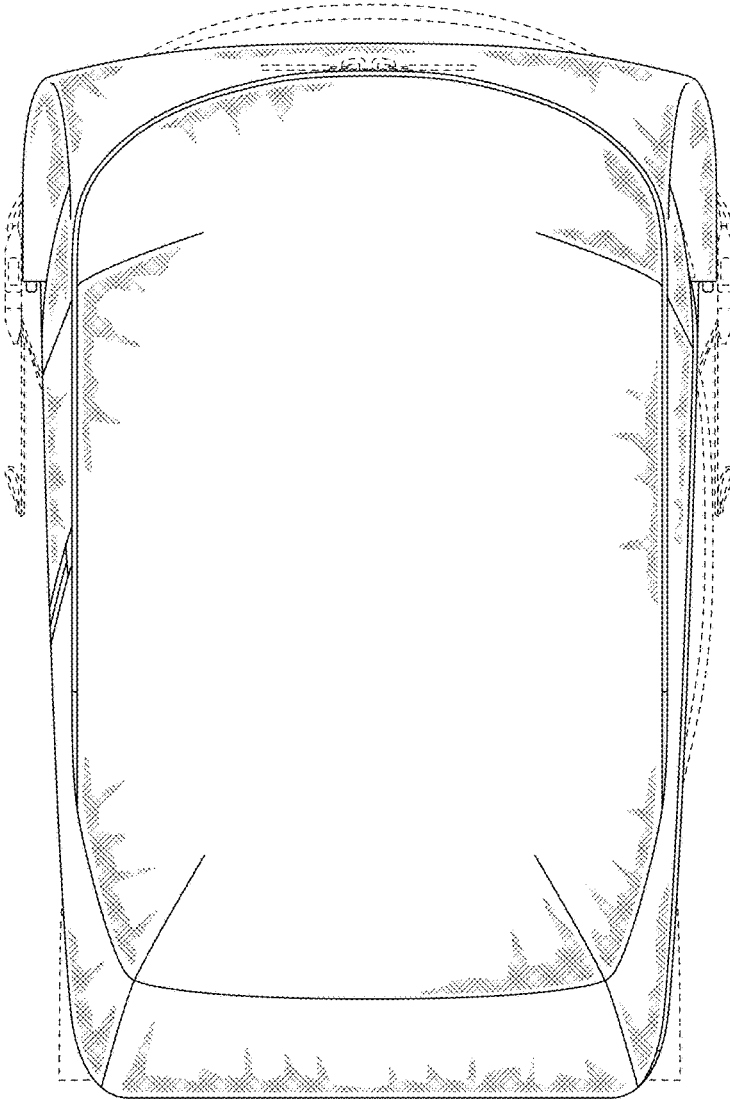

FIG. 2

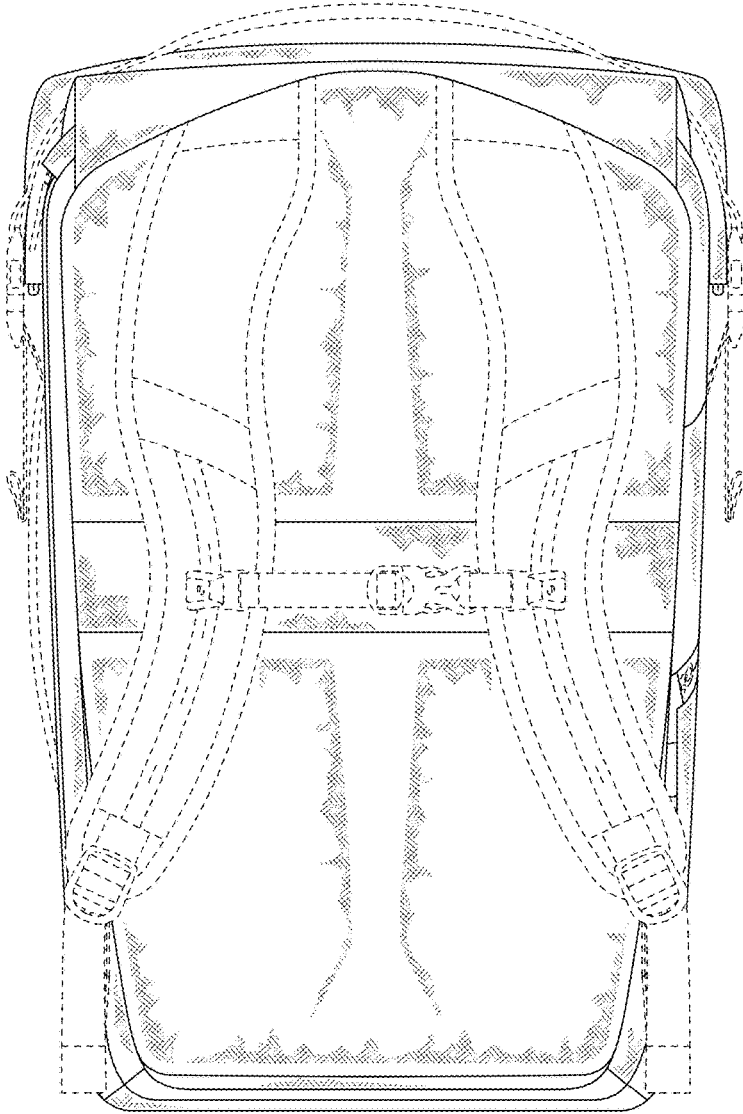

FIG. 3

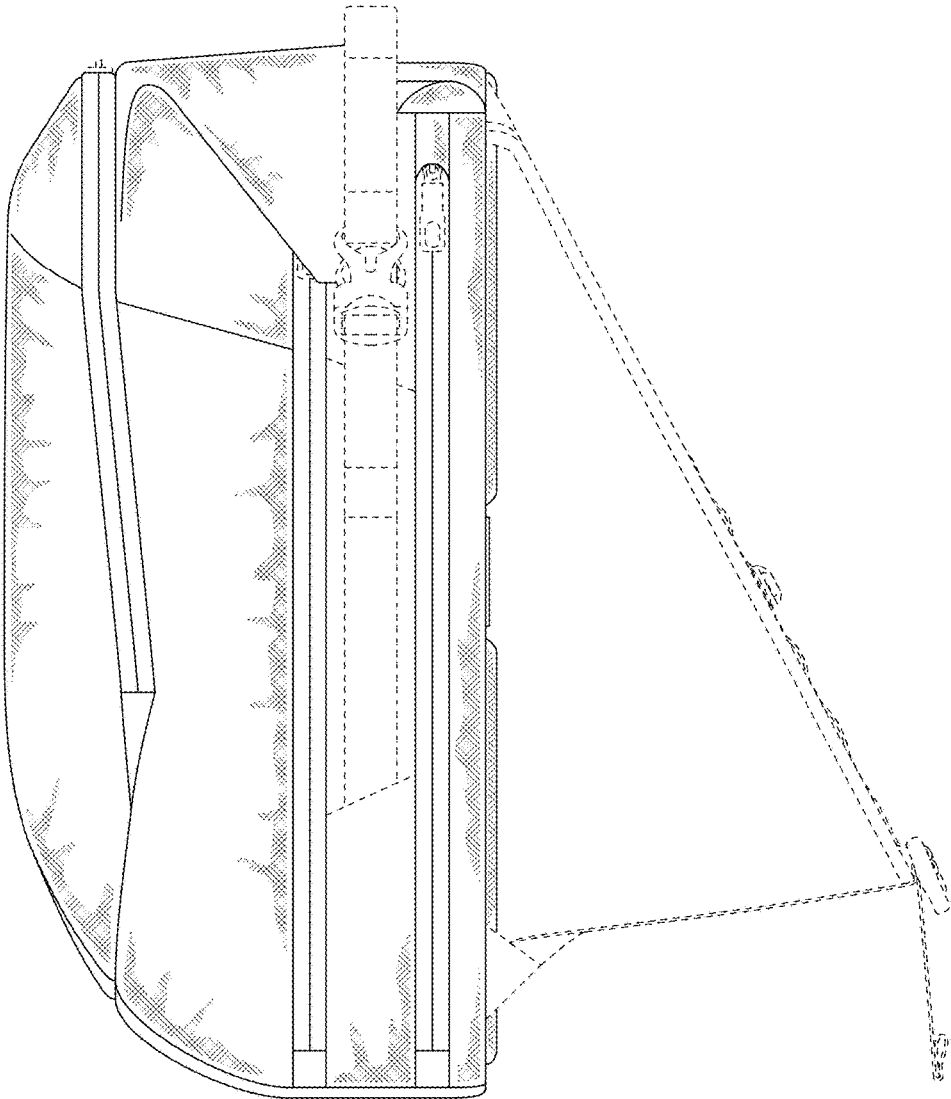

FIG. 4

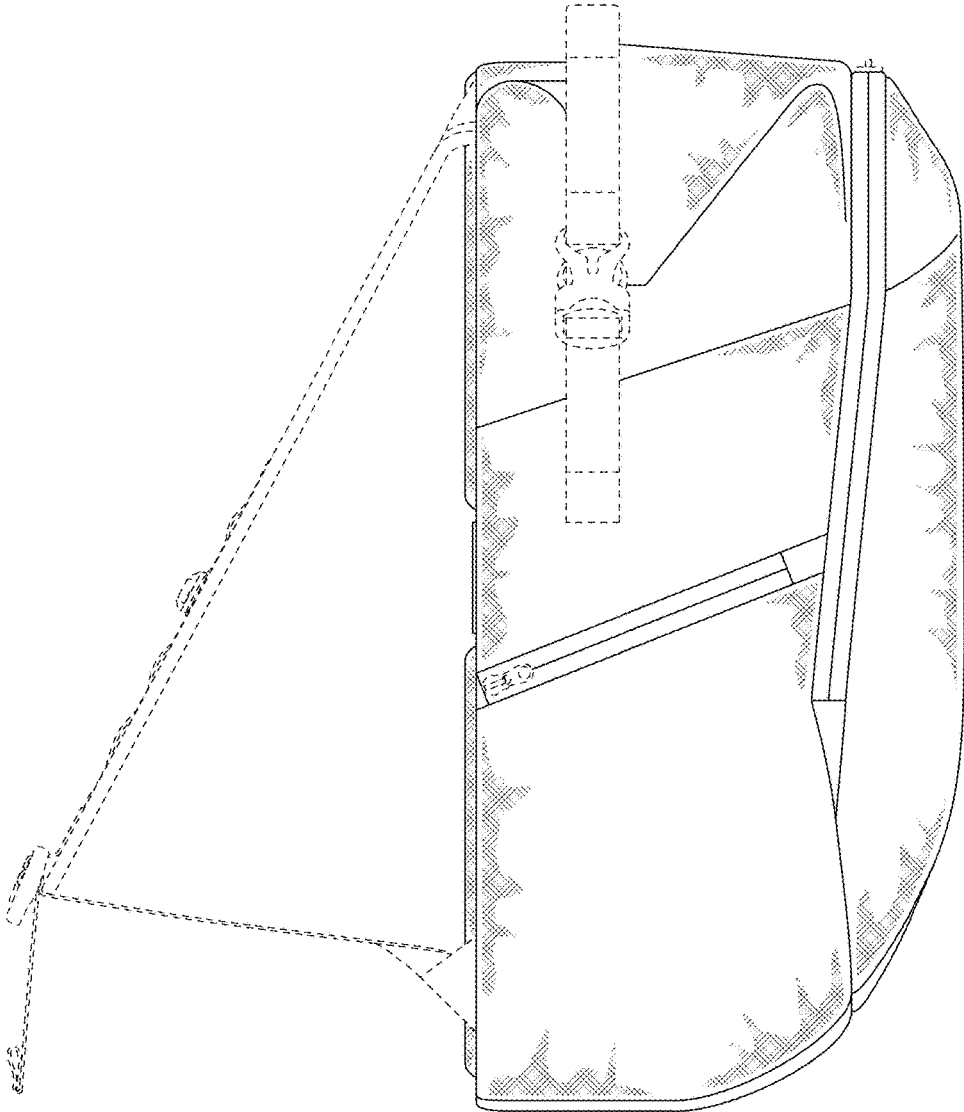

FIG. 5

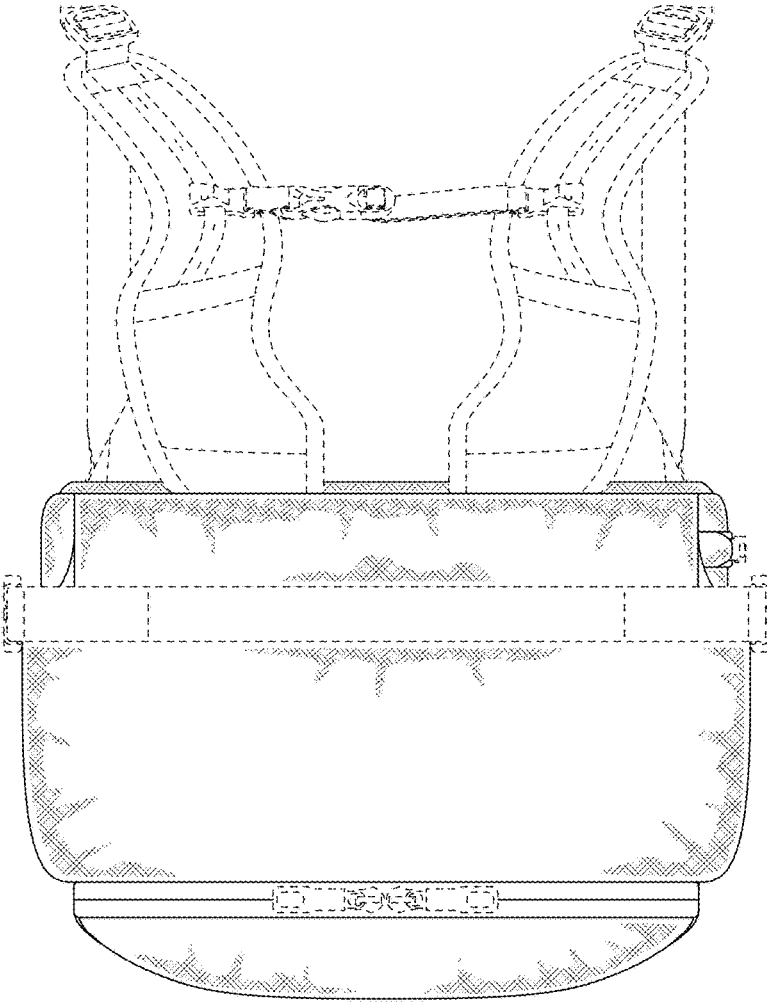

FIG. 6



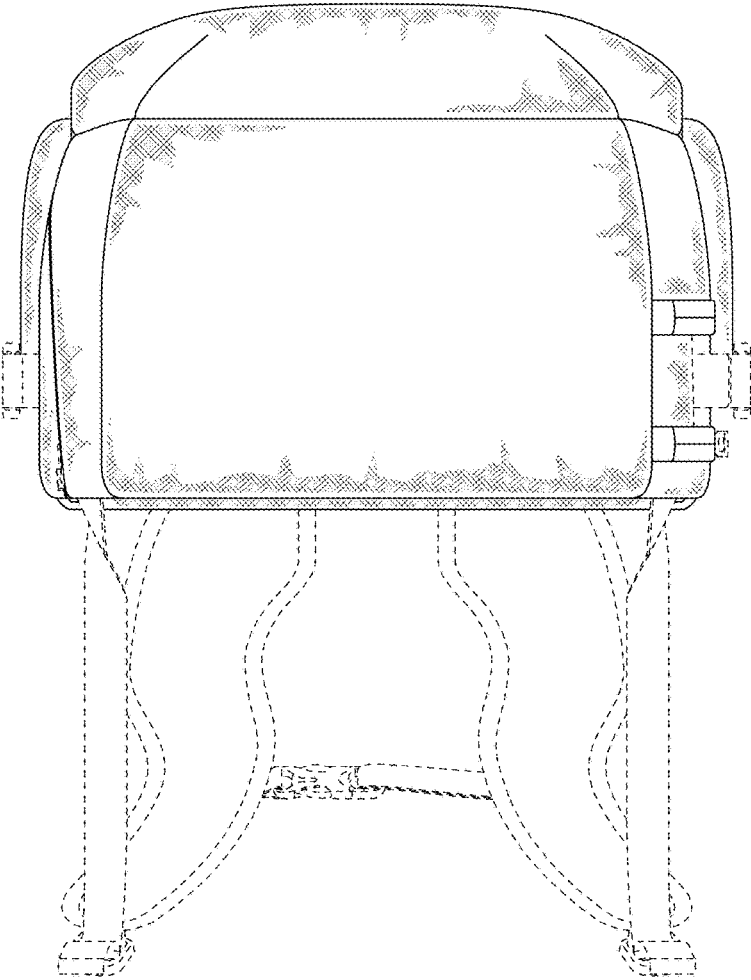

FIG. 7