



(12) **United States Design Patent**
Lee et al.

(10) **Patent No.:** **US D867,335 S**
(45) **Date of Patent:** **** Nov. 19, 2019**

(54) **AUDIO CONTROL DEVICE**

FOREIGN PATENT DOCUMENTS

(71) Applicant: **Kingston Digital, Inc.**, Fountain Valley, CA (US)

GB 60009819 * 3/2017
KR 300928655.0000 * 10/2017

(72) Inventors: **Baron King Lee**, Fountain Valley, CA (US); **Peter Leekuo Chou**, Fountain Valley, CA (US); **Lung Yuan Chen**, Hsinchu (TW); **Yaocheng He**, Hsinchu (TW)

OTHER PUBLICATIONS

Amazon.com: HyperX Cloud Revolver S Gaming Headset, reviews 2017, <https://www.amazon.com/HyperX-Revolver-Gaming-Headset-Surround/dp/B01N9RM9N3#customerReviews>, site visited Mar. 4, 2019.*

(73) Assignee: **Kingston Digital, Inc.**, Fountain Valley, CA (US)

Primary Examiner — John Windmuller
Assistant Examiner — John R Yeh

(**) Term: **15 Years**

(74) *Attorney, Agent, or Firm* — Skaar Ulbrich Macari, P.A.

(21) Appl. No.: **29/617,083**

(57) **CLAIM**

We claim the ornamental design for an audio control device, as shown and described.

(22) Filed: **Sep. 11, 2017**

(51) **LOC (12) Cl.** **14-03**

(52) **U.S. Cl.**
USPC **D14/218**

(58) **Field of Classification Search**
USPC D14/218; D13/168
CPC G09G 5/00; G06F 3/033
See application file for complete search history.

DESCRIPTION

FIG. 1 is a perspective view of an audio control device showing the claimed design;
FIG. 2 is another perspective view of FIG. 1;
FIG. 3 is a front elevational view of FIG. 1;
FIG. 4 is a rear elevational view of FIG. 1;
FIG. 5 is a left side elevational view of FIG. 1;
FIG. 6 is a right side elevational view of FIG. 1;
FIG. 7 is a top plan view of FIG. 1;
FIG. 8 is a bottom plan view of FIG. 1;
FIG. 9 is an enlarged view according to area 9 of FIG. 1;
FIG. 10 is an enlarged view according to area 10 of FIG. 2; and,
FIG. 11 is a reference view in a usage state showing an end of the audio control device of FIG. 1 with an audio plug. The dot-dash lines in the figures represent the boundaries of the enlarged areas which form no part of the claimed design. The broken lines in the figures represent portions of the article which form no part of the claimed design.

(56) **References Cited**

U.S. PATENT DOCUMENTS

D271,301 S *	11/1983	Manning	D13/168
D334,043 S *	3/1993	Taniguchi	D14/218
D524,295 S *	7/2006	Jacobson	D14/218
D524,297 S *	7/2006	Lee	D14/218
D569,841 S *	5/2008	Chung	D14/205
D606,980 S *	12/2009	Bradford	D14/218
D614,166 S *	4/2010	Brickstad	D14/205
D614,167 S *	4/2010	Brickstad	D14/205
D687,416 S *	8/2013	Lee	D14/218
D716,268 S *	10/2014	Yamamoto	D14/218
D716,758 S *	11/2014	Burgett	D14/205

(Continued)

1 Claim, 11 Drawing Sheets

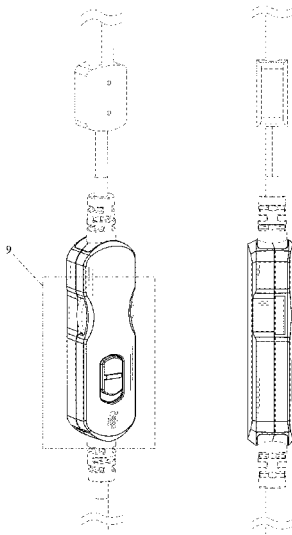

(56)

References Cited

U.S. PATENT DOCUMENTS

D718,273	S *	11/2014	Harata	D14/205
D726,831	S *	4/2015	Lee	D13/168
D728,528	S *	5/2015	Akana	D14/218
D730,873	S *	6/2015	Petterson	D14/218
D743,381	S *	11/2015	Pi	D14/218
D747,293	S *	1/2016	Mistry	D13/168
D788,077	S *	5/2017	Ducret	D14/218
D793,995	S *	8/2017	Nakagawa	D14/218
D813,204	S *	3/2018	Ducret	D14/218
D822,643	S *	7/2018	Chen	D14/218
2014/0254848	A1 *	9/2014	Petterson	H04R 1/1041 381/334

* cited by examiner

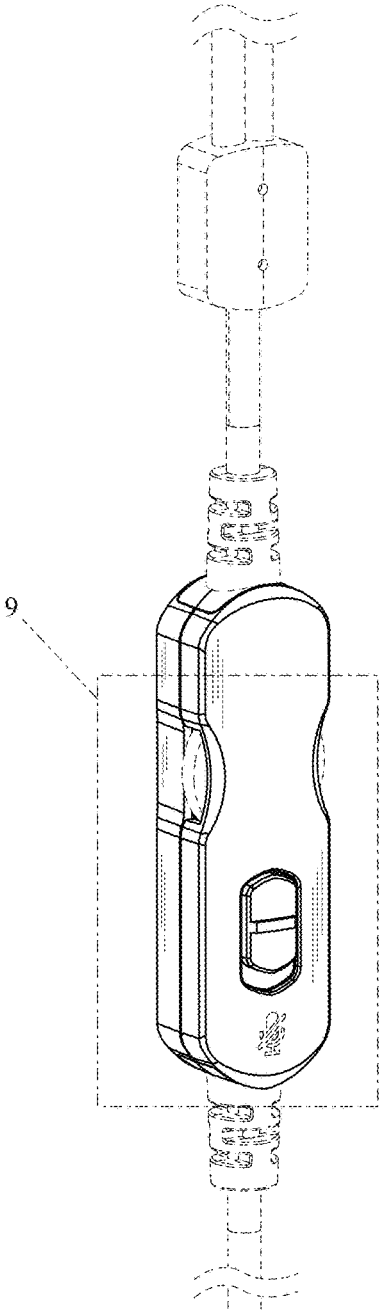

FIG.1

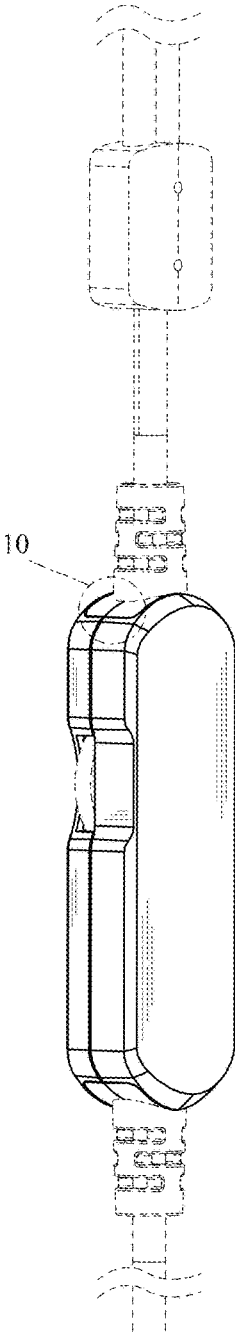

FIG.2

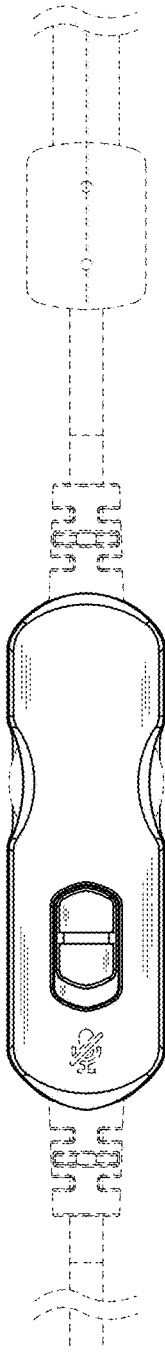

FIG.3

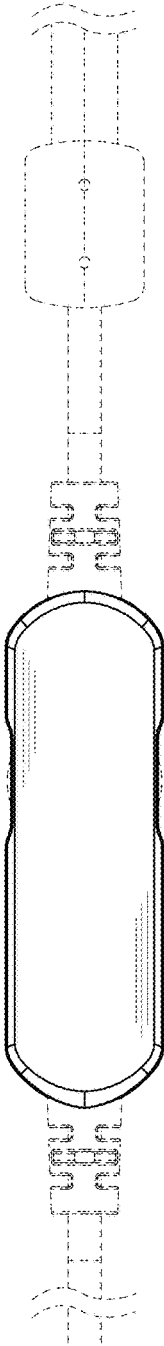

FIG.4

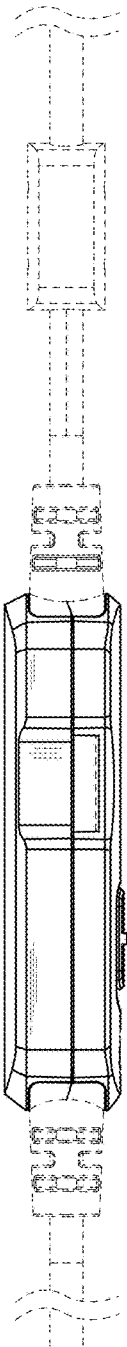

FIG.5

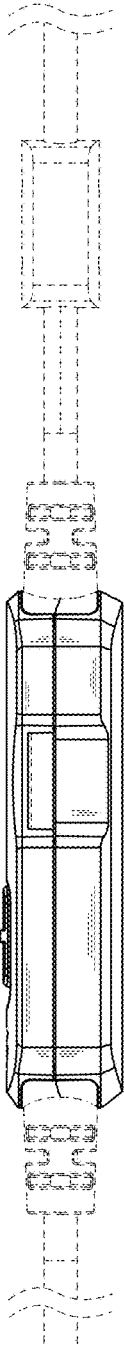

FIG.6

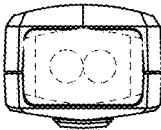

FIG.7

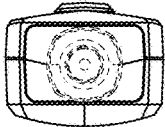

FIG.8

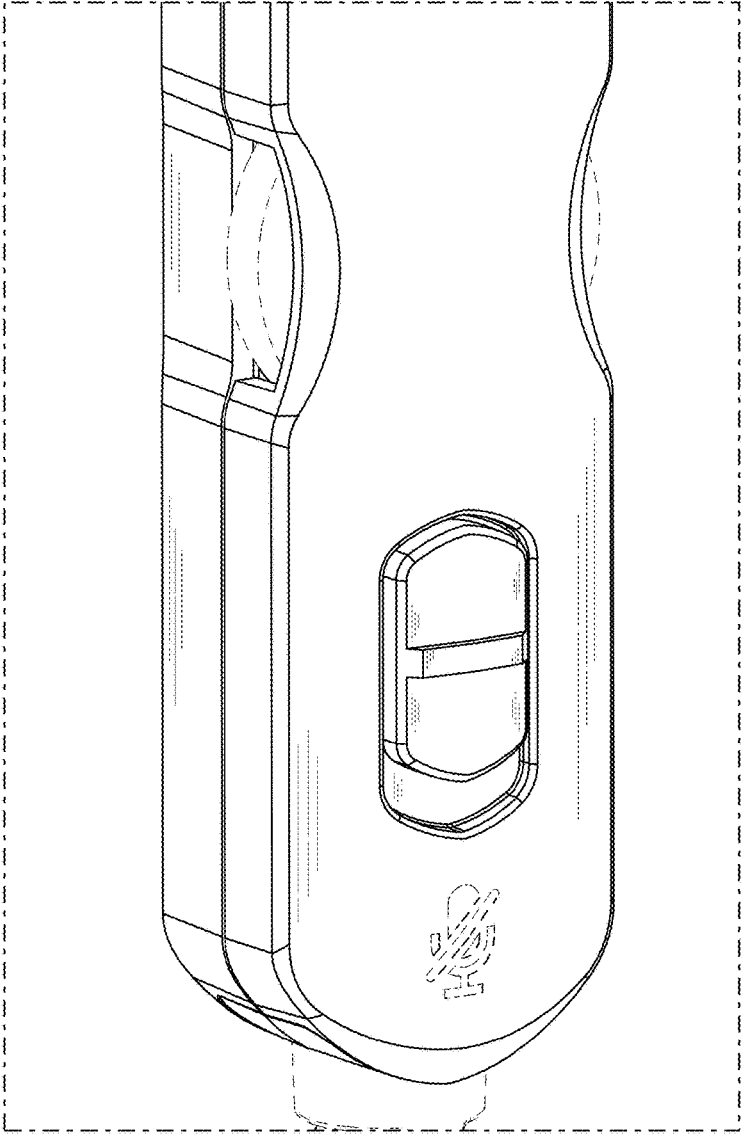

FIG.9

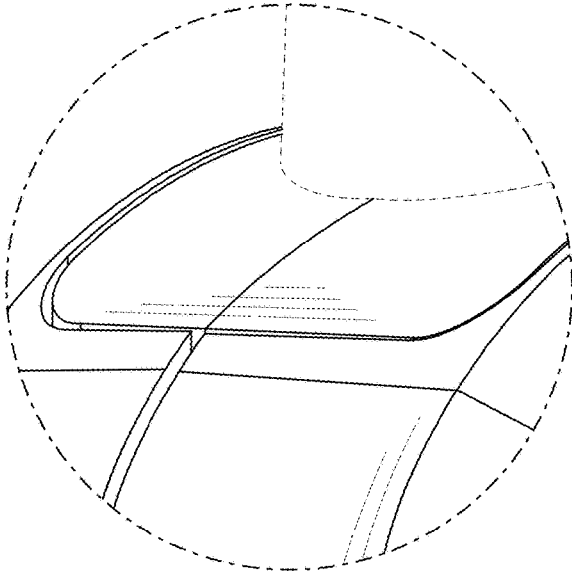

FIG.10

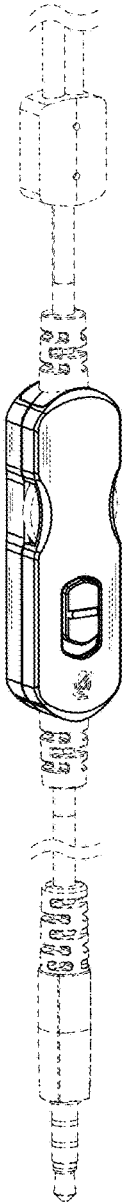

FIG. 11