



(51) International Patent Classification:

C07K 16/46 (2006.01) C07K 16/00 (2006.01)  
A61K 39/395 (2006.01) C12N 15/13 (2006.01)

(21) International Application Number:

PCT/IB2015/054107

(22) International Filing Date:

29 May 2015 (29.05.2015)

(25) Filing Language:

English

(26) Publication Language:

English

(30) Priority Data:

62/003,663 28 May 2014 (28.05.2014) US  
62/154,055 28 April 2015 (28.04.2015) US

(71) Applicant: ZYMEWORKS INC. [CA/CA]; 540-1385 West 8th Ave., Vancouver, British Columbia V6H3V9 (CA).

(72) Inventors: SANCHES, Mario; 3157 West 7th Avenue, Vancouver, British Columbia V6K1Z9 (CA). SPRETER VON KREUDENSTEIN, Thomas; 2816 6th Avenue West, Vancouver, British Columbia V6K1X1 (CA).

(81) Designated States (unless otherwise indicated, for every kind of national protection available): AE, AG, AL, AM, AO, AT, AU, AZ, BA, BB, BG, BH, BN, BR, BW, BY, BZ, CA, CH, CL, CN, CO, CR, CU, CZ, DE, DK, DM,

DO, DZ, EC, EE, EG, ES, FI, GB, GD, GE, GH, GM, GT, HN, HR, HU, ID, IL, IN, IR, IS, JP, KE, KG, KN, KP, KR, KZ, LA, LC, LK, LR, LS, LU, LY, MA, MD, ME, MG, MK, MN, MW, MX, MY, MZ, NA, NG, NI, NO, NZ, OM, PA, PE, PG, PH, PL, PT, QA, RO, RS, RU, RW, SA, SC, SD, SE, SG, SK, SL, SM, ST, SV, SY, TH, TJ, TM, TN, TR, TT, TZ, UA, UG, US, UZ, VC, VN, ZA, ZM, ZW.

(84) Designated States (unless otherwise indicated, for every kind of regional protection available): ARIPO (BW, GH, GM, KE, LR, LS, MW, MZ, NA, RW, SD, SL, ST, SZ, TZ, UG, ZM, ZW), Eurasian (AM, AZ, BY, KG, KZ, RU, TJ, TM), European (AL, AT, BE, BG, CH, CY, CZ, DE, DK, EE, ES, FI, FR, GB, GR, HR, HU, IE, IS, IT, LT, LU, LV, MC, MK, MT, NL, NO, PL, PT, RO, RS, SE, SI, SK, SM, TR), OAPI (BF, BJ, CF, CG, CI, CM, GA, GN, GQ, GW, KM, ML, MR, NE, SN, TD, TG).

Published:

- with international search report (Art. 21(3))
- with amended claims and statement (Art. 19(1))
- with information concerning request for restoration of the right of priority in respect of one or more priority claims (Rules 26bis.3 and 48.2(b)(vii))
- with sequence listing part of description (Rule 5.2(a))

(54) Title: MODIFIED ANTIGEN BINDING POLYPEPTIDE CONSTRUCTS AND USES THEREOF

FIG. 1A

VH F1 CDR1 F2 CDR2 F3

D3H44	EUGLVRSQDLPQFGSLHSCRAAGDENI *****	FE--YMH *****	WVRQAPGKLEWAF *****	LIEP--EQRHLYDPKFD *****	RACISANGMPCALQMSLRADITAVYYCAR *****
VH1	QVGLVQSDAEVKKPKAAVYKAKSHYFP	TG--YMH	WVRQAPGKLEWAF	NINP--NSQINYPKQFQ	HVIMEHITSISTAMMLSRSDITAVYYCAR
VH2	QILTRSGDPTLYPDTYLLTCTPQSHL	S7SGVQV	WVDFQSCALEWLA	LIV--WDERKAFSLSLS	RLTIPTFTRMQLFNTRMDFVTAQYCAR
VH3	EPQLVREDCDLPQFGSLHSCRAAGDTT	SE--YMH	WVRQAPGKLEWAF	NIEP--DQSEKTYVSVKQ	RPTLSRHHMDELQNSLRADITAVYYCAR
VH4	QVGLVQSDAEVKKPKAAVYKAKSHYFP	SS--NMS	WVDFQSCALEWLA	EIV--SSQINYPKSLG	RVTLSVSRMDELQNSLRADITAVYYCAR
VH5	EVQLVQSDAEVKKPKAAVYKAKSHYFP	TS--YMH	WVRQAPGKLEWAF	IYF--GSDIYSPKQ	QVTISADRSITAVLQSHLSRADITAVYYCAR
VH6	QVGLVQSDAEVKKPKAAVYKAKSHYFP	SSMSGANN	WVDFQSCALEWLA	STYR--SDIYSPKQ	RVTISVSRMDELQNSLRADITAVYYCAR
VH7	QVGLVQSDAEVKKPKAAVYKAKSHYFP	TS--YMH	WVRQAPGKLEWAF	NIEP--DQSEKTYVSVKQ	RVTLSVSRMDELQNSLRADITAVYYCAR

CDR3

D3H44	-DFARVFDYRQDCTPLTYS
IGHJ1*01	---AEYFDHRCQCLTYS
IGHJ2*01	---YVYFDHRCQCLTYS
IGHJ3*02	---DAFDHRCQCLTYS
IGHJ4*01	---YVYFDHRCQCLTYS
IGHJ5*02	---AEYFDHRCQCLTYS
IGHJ6*01	YVYFDHRCQCLTYS

(57) Abstract: The present invention provides heterodimer pairs that can comprise a first heterodimer and a second heterodimer wherein each heterodimer comprises an immunoglobulin heavy chain or fragment thereof and an immunoglobulin light chain or fragment thereof. At least one of the heterodimers can comprise one or more amino acid modifications in the CH1 and/or CL domains, one or more amino acid modifications in the VH and/or VL domains, or a combination thereof. The modified amino acid(s) can be part of the interface between the light chain and heavy chain and are typically modified to create preferential pairing between each heavy chain and a desired light chain such that when the two heavy chains and two light chains of the heterodimer pair are co-expressed in a cell, the heavy chain of the first heterodimer preferentially pairs with one of the light chains rather than the other. Likewise, the heavy chain of the second heterodimer typically preferentially pairs with the second light chain rather than first.

WO 2015/181805 A1

KTS Ref.: 97993-945204 (000110PC)

Client Ref.: ZYME023WO

**MODIFIED ANTIGEN BINDING POLYPEPTIDE CONSTRUCTS AND USES  
THEREOF**

**CROSS REFERENCE TO RELATED APPLICATIONS**

[0001] This application claims the benefit of priority to U.S. Provisional Application No. 62/003,663, filed May 28, 2014, and U.S. Provisional Application No. 62/154,055, filed April 28, 2015, which applications are incorporated herein by reference in their entirety for all purposes.

[0002] This application is related to PCT/CA2013/050914, filed November 28, 2013, U.S. Provisional Application No. 61/730,906, filed November 28, 2012, U.S. Provisional Application No. 61/761,641, filed February 6, 2013, U.S. Provisional Application No. 61/818,874, filed May 2, 2013, and U.S. Provisional Application No. 61/869,200, filed August 23, 2013, the entire disclosure of each of which is hereby incorporated by reference in its entirety for all purposes.

**SEQUENCE LISTING**

[0003] The instant application contains a Sequence Listing which has been submitted electronically in ASCII format and is hereby incorporated by reference in its entirety. Said ASCII copy, created on May 29, 2015, is named 97993-945204(000110PC)\_SL.txt and is 27,012 bytes in size.

**BACKGROUND**

[0004] Bi-specific antibodies are capable of binding to two different epitopes. The epitopes can be on the same antigen, or each epitope can be on a different antigen. This feature of bi-specific antibodies makes them an attractive tool for various therapeutic applications where there is a therapeutic benefit to targeting or recruiting more than one molecule in the treatment of disease. One of the approaches to form bi-specific antibody would involve concomitant expression of two unique antibody heavy chains and two unique antibody light chains. Correctly forming bi-specific antibodies in a format that is similar to wild-type remains a challenge, since antibody heavy chains have evolved to bind antibody light chains in a relatively promiscuous manner. As a result of this promiscuous pairing, concomitant expression of two antibody heavy

chains and two antibody light chains naturally leads to a scrambling of heavy chain – light chain pairings. This mispairing remains a major challenge for the generation of bi-specific therapeutics, where homogeneous pairing is an essential requirement for good manufacturability and biological efficacy.

[0005] Several approaches have been described to prepare bi-specific antibodies in which specific antibody light chains or fragment pair with specific antibody heavy chains or fragments. A review of various approaches to address this problem can be found in Klein et al., (2012) *mAbs* 4:6, 1-11. International Patent Application No. PCT/EP2011/056388 (WO 2011/131746) describes an in vitro method for generating a heterodimeric protein in which asymmetrical mutations are introduced into the CH3 regions of two monospecific starting proteins in order to drive directional “Fab-arm” or “half-molecule” exchange between two monospecific IgG4- or IgG4-like antibodies upon incubation under reducing conditions.

[0006] Schaefer et al. (Roche Diagnostics GmbH), describe a method to assemble two heavy and two light chains, derived from two existing antibodies, into human bivalent bi-specific IgG antibodies without use of artificial linkers (*PNAS* (2011) 108(27): 11187-11192). The method involves exchanging heavy chain and light chain domains within the antigen-binding fragment (Fab) of one half of the bi-specific antibody.

[0007] Strop et al. (Rinat-Pfizer Inc.), describe a method of producing stable bi-specific antibodies by expressing and purifying two antibodies of interest separately, and then mixing them together under specified redox conditions (*J. Mol. Biol.* (2012) 420:204-19).

[0008] Zhu et al. (Genentech) have engineered mutations in the VL/VH interface of a diabody construct consisting of variant domain antibody fragments completely devoid of constant domains, and generated a heterodimeric diabody (*Protein Science* (1997) 6:781-788). Similarly, Igawa et al. (Chugai) have also engineered mutations in the VL/ VH interface of a single-chain diabody to promote selective expression and inhibit conformational isomerization of the diabody (*Protein Engineering, Design & Selection* (2010) 23:667-677).

[0009] US Patent Publication No. 2009/0182127 (Novo Nordisk, Inc.) describes the generation of bi-specific antibodies by modifying amino acid residues at the Fc interface and at the CH1:CL interface of light-heavy chain pairs that reduce the ability of the light chain of one pair to interact with the heavy chain of the other pair.

[0010] US Patent Publication No. 2014/0370020 (Chugai), describes regulating the association between the CH1 and CL regions of an antibody by substituting amino acids that exist on the interface between these regions with charged amino acids.

### SUMMARY

[0011] Described herein is an isolated antigen binding polypeptide construct comprising at least a first heterodimer and a second heterodimer, the first heterodimer comprising a first immunoglobulin heavy chain polypeptide sequence (H1), and a first immunoglobulin light chain polypeptide sequence (L1); and the second heterodimer comprising a second immunoglobulin heavy chain polypeptide sequence (H2), and a second immunoglobulin light chain polypeptide sequence (L2), wherein at least one of the H1 or L1 sequences of the first heterodimer is distinct from the corresponding H2 or L2 sequence of the second heterodimer, and wherein H1 and H2 each comprise at least a heavy chain variable domain ( $V_H$  domain) and a heavy chain constant domain ( $C_{H1}$  domain); L1 and L2 each comprise at least a light chain variable domain ( $V_L$  domain) and a light chain constant domain ( $C_L$  domain); and at least one of H1, H2, L1 and L2 comprises at least one amino acid modification of at least one constant domain and/or at least one variable domain, wherein H1 preferentially pairs with L1 as compared to L2 and H2 preferentially pairs with L2 as compared to L1.

[0012] In some aspects, the construct further comprises a heterodimeric Fc, the Fc comprising at least two  $C_{H3}$  sequences, wherein the Fc is coupled, with or without one or more linkers, to the first heterodimer and the second heterodimer, wherein the dimerized  $C_{H3}$  sequences have a melting temperature ( $T_m$ ) of about 68°C or higher as measured by differential scanning calorimetry (DSC), and wherein the construct is bispecific.

[0013] In some aspects, the at least one amino acid modification is selected from at least one amino acid modification shown in the Tables or Examples.

[0014] In some aspects, H1 pairs preferentially with L1 as compared to L2, and H2 pairs preferentially with L2 as compared to L1, when H1, H2, L1 and L2 are co-expressed in a cell or a mammalian cell, or when H1, H2, L1 and L2 are co-expressed in a cell-free expression system, or when H1, H2, L1 and L2 are co-produced, or when H1, H2, L1 and L2 are co-produced via a redox production method.

[0015] In some aspects, at least one of H1, H2, L1 and L2 comprises at least one amino acid modification of a  $V_H$  and/or  $V_L$  domain and at least one amino acid modification of a  $C_{H1}$  and/or  $C_L$  domain such that H1 pairs preferentially with L1 as compared to L2, and/or H2 pairs preferentially with L2 as compared to L1.

[0016] In some aspects, if H1 comprises at least one amino acid modification in the  $C_{H1}$  domain, then at least one of L1 and L2 comprise at least one amino acid modification in the  $C_L$  domain; and/or if H1 comprises at least one amino acid modification in the  $V_H$  domain, then at least one of L1 and L2 comprise at least one amino acid modification in the  $V_L$  domain.

[0017] In some aspects, H1, L1, H2, and/or L2 comprises at least 1, 2, 3, 4, 5, 6, 7, 8, 9, or 10 amino acid mutations. In some aspects, at least one of H1, H2, L1 and L2 comprises at least 2, 3, 4, 5, 6, 7, 8, 9, or 10 amino acid modifications of at least one constant domain and/or at least one variable domain.

[0018] In some aspects, when both L1 and L2 are co-expressed with at least one of H1 and H2, the relative pairing of the at least one of H1-L1 and H2-L2 heterodimer pair to that of the respective corresponding H1-L2 or H2-L1 heterodimer pair is greater than 50, 51, 52, 53, 54, 55, 56, 57, 58, 59, 60, 61, 62, 63, 64, 65, 66, 67, 68, 69, 70, 71, 72, 73, 74, 75, 76, 77, 78, 79, 80, 81, 82, 83, 84, 85, 86, 87, 88, 89, 90, 91, 92, 93, 94, 95, 96, 97, 98, or 99%, and wherein the relative pairing of the modified H1-L1 or H2-L2 heterodimer pair is greater than the respective relative pairing observed in the corresponding H1-L1 or H2-L2 heterodimer pair without the at least one amino acid modification.

[0019] In some aspects, the thermal stability as measured by the melting temperature ( $T_m$ ) as measured by DSF of at least one of the first and second heterodimers is within about 0, 1, 2, 3, 4, 5, 6, 7, 8, 9, or 10°C of the  $T_m$  of the corresponding heterodimer without the at least one amino acid modification. In some aspects, the thermal stability as measured by the melting temperature ( $T_m$ ) as measured by DSF of each heterodimer comprising at least one amino acid modification is within about 0, 1, 2, 3, 4, 5, 6, 7, 8, 9, or 10°C of the  $T_m$  of the corresponding heterodimer without the at least one amino acid modification. In some embodiments, the thermal stability as measured by the melting temperature ( $T_m$ ) as measured by DSF of each heterodimer comprising at least one amino acid modification is within about 0, 1, 2, or 3°C of the  $T_m$  of the corresponding heterodimer without the at least one amino acid modification.

[0020] In some aspects, the affinity of each heterodimer for the antigen to which it binds is within about 1, 2, 3, 4, 5, 6, 7, 8, 9, 10-fold of the affinity of the respective unmodified heterodimer for the same antigen as measured by surface plasmon resonance (SPR) or FACS.

[0021] In some aspects, at least one of H1 and L1 comprises at least one domain comprising at least one amino acid modification resulting in greater steric complementarity of amino acids when H1 pairs with L1 as compared to L2. In some aspects, at least one of H2 and L2 comprises at least one domain comprising at least one amino acid modification resulting in greater steric complementarity of amino acids when H2 pairs with L2 as compared to L1. In some aspects, at least one of H1 and L1 comprises at least one domain comprising at least one amino acid modification resulting in greater electrostatic complementarity between charged amino acids when H1 pairs with L1 as compared to L2. In some aspects, at least one of H2 and L2 comprises at least one domain comprising at least one amino acid modification resulting in greater electrostatic complementarity between charged amino acids when H2 pairs with L2 as compared to L1.

[0022] In some aspects, the at least one amino acid modification of is a set of mutations shown in at least one of the Tables or Examples.

[0023] In some aspects, the construct further comprises an Fc comprising at least two C<sub>H3</sub> sequences, wherein the Fc is coupled, with or without one or more linkers, to the first heterodimer and the second heterodimer.

[0024] In some aspects, the Fc is a human Fc, a human IgG1 Fc, a human IgA Fc, a human IgG Fc, a human IgD Fc, a human IgE Fc, a human IgM Fc, a human IgG2 Fc, a human IgG3 Fc, or a human IgG4 Fc. In some aspects, the Fc is a heterodimeric Fc. In some aspects, the Fc comprises one or more modifications in at least one of the C<sub>H3</sub> sequences. In some aspects, the dimerized C<sub>H3</sub> sequences have a melting temperature (T<sub>m</sub>) as measured by DSC of about 68, 69, 70, 71, 72, 73, 74, 75, 76, 77, 77.5, 78, 79, 80, 81, 82, 83, 84, or 85°C or higher. In some aspects, the Fc is a heterodimer formed with a purity greater than about 75, 76, 77, 78, 79, 80, 81, 82, 83, 84, 85, 86, 87, 88, 89, 90, 91, 92, 93, 94, 95, 96, 97, 98, or 99% when produced; or wherein the Fc is a heterodimer formed with a purity greater than about 75, 76, 77, 78, 79, 80, 81, 82, 83, 84, 85, 86, 87, 88, 89, 90, 91, 92, 93, 94, 95, 96, 97, 98, or 99% when expressed or when expressed via a single cell. In some aspects, the Fc comprises one or more modifications in at least one of the C<sub>H3</sub> sequences that promote the formation of a heterodimeric Fc with

stability comparable to a wild-type homodimeric Fc. In some aspects, the Fc further comprises at least one C<sub>H2</sub> sequence. In some aspects, the C<sub>H2</sub> sequence(s) of the Fc comprises one or more modifications. In some aspects, the Fc comprises one or more modifications to promote selective binding of Fc-gamma receptors.

[0025] In some embodiments, the Fc comprises:

- i) a heterodimeric IgG1 Fc having the modifications L351Y\_F405A\_Y407V in the first Fc polypeptide, and the modifications T366L\_K392M\_T394W in the second Fc polypeptide;
- ii) a heterodimeric IgG1 Fc having the modifications L351Y\_F405A\_Y407V in the first Fc polypeptide, and the modifications T366L\_K392L\_T394W in the second Fc polypeptide;
- iii) a heterodimeric IgG1 Fc having the modifications T350V\_L351Y\_F405A\_Y407V in the first Fc polypeptide, and the modifications T350V\_T366L\_K392L\_T394W in the second Fc polypeptide;
- iv) a heterodimeric IgG1 Fc having the modifications T350V\_L351Y\_F405A\_Y407V in the first Fc polypeptide, and the modifications T350V\_T366L\_K392M\_T394W in the second Fc polypeptide; or
- v) a heterodimeric IgG1 Fc having the modifications T350V\_L351Y\_S400E\_F405A\_Y407V in the first Fc polypeptide, and the modifications T350V\_T366L\_N390R\_K392M\_T394W in the second Fc polypeptide.

[0026] In some aspects, the Fc is coupled to the heterodimers by one or more linkers, or wherein the Fc is coupled to H1 and H2 by one or more linkers. In some aspects, the one or more linkers are one or more polypeptide linkers. In some aspects, the one or more linkers comprises one or more antibody hinge regions. In some aspects, the one or more linkers comprises one or more IgG1 hinge regions. In some aspects, the one or more linkers comprises one or more modifications. In some aspects, the one or more modifications to the one or more linkers promote selective binding of Fc-gamma receptors.

[0027] In some aspects, the at least one amino acid modification is at least one amino acid mutation or wherein the at least one amino acid modification is at least one amino acid substitution.

[0028] In some aspects, the sequences of each of H1, H2, L1, and L2 are derived from human sequences.

[0029] In some aspects, the construct is multispecific or bispecific. In some aspects, the construct is multivalent or bivalent.

[0030] In some aspects, the heterodimers described herein preferentially pair to form a bi-specific antibody. For example, in some embodiments, the heavy chain polypeptide sequences H1 and H2 comprise a full length heavy chain sequence comprising a heavy chain constant domain ( $C_{H1}$  domain), a  $C_{H2}$  domain, and a  $C_{H3}$  domain. In some embodiments, the percentage of the correctly paired heavy and light chains in the bi-specific antibody (e.g., H1-L1:H2-L2) is greater than 50, 51, 52, 53, 54, 55, 56, 57, 58, 59, 60, 61, 62, 63, 64, 65, 66, 67, 68, 69, 70, 71, 72, 73, 74, 75, 76, 77, 78, 79, 80, 81, 82, 83, 84, 85, 86, 87, 88, 89, 90, 91, 92, 93, 94, 95, 96, 97, 98, or 99%.

[0031] Also described herein is an isolated polynucleotide or set of isolated polynucleotides comprising at least one sequence that encodes a construct or a heavy chain or light chain described herein. In some aspects, the polynucleotide or set of polynucleotides is cDNA. Also described herein is a vector or set of vectors comprising one or more of the polynucleotides or sets of polynucleotides described herein. In some aspects, the vector or set of vectors is selected from the group consisting of a plasmid, a multi-cistronic vector, a viral vector, a non-episomal mammalian vector, an expression vector, and a recombinant expression vector.

[0032] Also described herein is an isolated cell comprising a polynucleotide or set of polynucleotides described herein or a vector or set of vectors described herein. In some aspects, the cell is a hybridoma, a Chinese Hamster Ovary (CHO) cell, or a HEK293 cell.

[0033] Also described herein is a pharmaceutical composition comprising a construct described herein and a pharmaceutically acceptable carrier. In some aspects, the composition further comprises one or more substances selected from the group consisting of a buffer, an antioxidant, a low molecular weight molecule, a drug, a protein, an amino acid, a carbohydrate, a lipid, a chelating agent, a stabilizer, and an excipient.



[0034] Also described herein is a use of a construct described herein or a pharmaceutical composition described herein for the treatment of a disease or disorder or cancer or vascular disease in a subject or in the manufacture of a medicine.

[0035] Also described herein is a method of treatment of a subject having a disease or disorder or cancer or vascular disease comprising administering to the subject a construct described herein or a composition described herein.

[0036] Also described herein is a method of obtaining a construct described herein from a host cell culture, the method comprising the steps of: (a) obtaining a host cell culture comprising at least one host cell comprising one or more nucleic acid sequences encoding the construct; and (b) recovering the construct from the host cell culture.

[0037] Also described herein is a method of obtaining a construct described herein comprising the steps of: (a) obtaining H1, L1, H2, and L2; (b) allowing H1 to pair preferentially with L1 as compared to L2 and H2 to pair preferentially with L2 as compared to L1; and (c) obtaining the construct.

[0038] Also described herein is a method of preparing a construct described herein comprising: obtaining a polynucleotide or set of polynucleotides encoding at least one construct; determining the optimal ratios of each of the polynucleotide or set of polynucleotides for introduction into at least one host cell, wherein the optimal ratios are determined by assessing the amount of H1-L1 and H2-L2 heterodimer pairs formed upon expression of H1, L1, H2, and L2 as compared to mispaired H1-L2 and H2-L1 heterodimer pairs formed upon expression of H1, L1, H2, and L2; selecting a preferred optimal ratio, wherein transfection of at least one host cell with the preferred optimal ratio of the polynucleotide or set of polynucleotides results in expression of the construct; transfecting the at least one host cell with the optimal ratio of the polynucleotide or set of polynucleotides; and culturing the at least one host cell to express the construct.

[0039] In some aspects, selecting the optimal ratio is assessed by transfection in a transient transfection system. In some aspects, transfection of the at least one host cell with the preferred optimal ratio of the polynucleotide or set of polynucleotides results in optimal expression of the construct. In some aspects, the construct comprises an Fc comprising at least two  $C_{H3}$  sequences, wherein the Fc is coupled, with or without one or more linkers, to the first heterodimer and the

second heterodimer. In some aspects, the Fc is a heterodimer, optionally comprising one or more amino acid modifications.

[0040] Also described herein is a computer-readable storage medium storing a dataset comprising data representing complementary mutations in a first heterodimer comprising a first immunoglobulin heavy chain polypeptide sequence (H1) and a first immunoglobulin light chain polypeptide sequence (L1); and a second heterodimer comprising a second immunoglobulin heavy chain polypeptide sequence (H2) and a second immunoglobulin light chain polypeptide sequence (L2), wherein H1 and H2 each comprise at least a heavy chain variable domain (V<sub>H</sub> domain) and a heavy chain constant domain (C<sub>H1</sub> domain); wherein L1 and L2 each comprise at least a light chain variable domain (V<sub>L</sub> domain) and a light chain constant domain (C<sub>L</sub> domain), and wherein the dataset of complementary mutations comprises data representing those mutations listed in the Tables or Examples or a subset of those mutations; and computer executable code for determining the likelihood that H1 will pair preferentially with L1 as compared to L2 and/or H2 will pair preferentially with L2 as compared to L1.

[0041] Also described herein is a computer implemented method for determining preferential pairing, comprising: obtaining a dataset comprising data representing complementary mutations in a first heterodimer comprising a first immunoglobulin heavy chain polypeptide sequence (H1) and a first immunoglobulin light chain polypeptide sequence (L1); and a second heterodimer comprising a second immunoglobulin heavy chain polypeptide sequence (H2) and a second immunoglobulin light chain polypeptide sequence (L2), wherein H1 and H2 each comprise at least a heavy chain variable domain (V<sub>H</sub> domain) and a heavy chain constant domain (C<sub>H1</sub> domain); wherein L1 and L2 each comprise at least a light chain variable domain (V<sub>L</sub> domain) and a light chain constant domain (C<sub>L</sub> domain), and wherein the dataset of complementary mutations comprises data representing those mutations listed in the Tables or Examples or a subset of those mutations; and determining, by a computer processor, the likelihood that H1 will pair preferentially with L1 as compared to L2 and/or H2 will pair preferentially with L2 as compared to L1. In some aspects, the method further comprises producing a construct described herein.

[0042] Also described herein is a method of producing a bi-specific antigen binding polypeptide construct, said bi-specific construct comprising a first heterodimer comprising a first immunoglobulin heavy chain polypeptide sequence (H1), and a first immunoglobulin light chain

polypeptide sequence (L1) from a first mono-specific antigen binding polypeptide; and a second heterodimer comprising a second immunoglobulin heavy chain polypeptide sequence (H2), and a second immunoglobulin light chain polypeptide sequence (L2) from a second mono-specific antigen binding polypeptide, wherein H1 and H2 each comprise at least a heavy chain variable domain (V<sub>H</sub> domain) and a heavy chain constant domain (C<sub>H1</sub> domain); wherein L1 and L2 each comprise at least a light chain variable domain (V<sub>L</sub> domain) and a light chain constant domain (C<sub>L</sub> domain), the method comprising: introducing one or more complementary mutations from the dataset described herein into the first heterodimer and/or the second heterodimer; and co-expressing the first heterodimer and the second heterodimer in at least one host cell to produce an expression product comprising the bi-specific construct.

[0043] In some aspects, the method further comprises determining the amount of the bi-specific construct in the expression product relative to other polypeptide products to select a preferred subset of complementary mutations. In some aspects, the bi-specific construct is produced with a purity of greater than 70% (e.g., greater than 75%, 80%, 85%, 90%, 91%, 92%, 93%, 94%, 95%, 96%, 97%, 98%, or 99%) compared to the other polypeptide products. In some aspects, the dataset is a dataset described herein. In some aspects, the method further comprises the step of adding additional amino acid modifications to at least one of H1, H2, L1, or L2 to increase the purity of the bi-specific construct compared to the other polypeptide products. In some aspects, the construct comprises an Fc comprising at least two C<sub>H3</sub> sequences, wherein the Fc is coupled, with or without one or more linkers, to the first heterodimer and the second heterodimer. In some aspects, the Fc is a heterodimer, optionally comprising one or more amino acid modifications. In some aspects, the antigen binding polypeptide is an antibody, a Fab, or a scFv.

[0044] In some embodiments of the construct, H1 and/or H2 comprises at least one or a set of amino acid modifications at L124, K145, D146, Q179, and S186, and L1 and/or L2 comprises at least one or a set of amino acid modifications at Q124, S131, V133, Q160, S176, T178, and T180. For example, in some embodiments, H1 and/or H2 comprises at least one or a set of amino acid modifications selected from L124R, L124E, K145M, K145T, D146N, Q179E, Q179K, S186R, and S186K, and L1 and/or L2 comprises at least one or a set of amino acid modifications selected from Q124E, S131R, S131K, V133G, Q160E, S176R, S176D, T178D, T178E, and T180E. In some embodiments, H1 comprises amino acid modifications selected

from the group consisting of L124E, K145M, K145T, and Q179E, or a combination thereof; L1 comprises amino acid modifications selected from the group consisting of S131R, S131K, V133G, and S176R, or a combination thereof; H2 comprises amino acid modifications selected from the group consisting of L124R, D146N, Q179K, S186R, and S186K, or a combination thereof; and L2 comprises amino acid modifications selected from the group consisting of Q124E, V133G, Q160E, S176D, T178D, T178E, and T180E, or a combination thereof. In some embodiments, H1 comprises the amino acid modifications L124E, K145T, and Q179E; L1 comprises the amino acid modifications S131K, V133G, and S176R; H2 comprises the amino acid modifications L124R and S186R; and L2 comprises the amino acid modifications V133G, S176D, and T178D.

[0045] In some embodiments of the construct, H1 and/or H2 comprises at least one or a set of amino acid modifications at L124, L143, K145, D146, Q179, and S186; and L1 and/or L2 comprises at least one or a set of amino acid modifications at Q124, V133, Q160, S176, T178, and T180. In some embodiments, H1 and/or H2 comprises at least one or a set of amino acid modifications selected from L124E, L124R, L143E, L143D, K145T, K145M, D146N, Q179K, S186R, and S186K; and L1 and/or L2 comprises at least one or a set of amino acid modifications selected from Q124K, Q124E, V133G, Q160K, S176R, S176D, T178E, T178K, T178R, T178D, and T180E. In some embodiments, H1 comprises amino acid modifications selected from the group consisting of L124E, L143E, L143D, K145T, and K145M, or combinations thereof; L1 comprises amino acid modifications selected from the group consisting of Q124K, V133G, Q160K, S176R, T178K, and T178R, or combinations thereof; H2 comprises amino acid modifications selected from the group consisting of L124R, D146N, Q179K, S186R, and S186K, or combinations thereof; and L2 comprises amino acid modifications selected from the group consisting of Q124E, V133G, S176D, T178E, T178D, and T180E, or combinations thereof. In some embodiments, H1 comprises the amino acid modifications L124E, L143E, and K145T; L1 comprises the amino acid modifications Q124K, V133G, and S176R; H2 comprises the amino acid modifications L124R and Q179K; and L2 comprises the amino acid modifications V133G, S176D, and T178E. In some embodiments, H1 comprises the amino acid modifications L124E, L143E, and K145T; L1 comprises the amino acid modifications Q124K, V133G, and S176R; H2 comprises the amino acid modifications L124R and S186R; and L2 comprises the amino acid modifications V133G, S176D, and T178D.

[0046] In some embodiments of the construct, H1 and/or H2 comprises at least one or a set of amino acid modifications at Q39, L45, L124, L143, F122, and H172, and L1 and/or L2 comprises at least one or a set of amino acid modifications at Q38, P44, Q124, S131, V133, N137, S174, S176, and T178. In some embodiments, H1 and/or H2 comprises at least one or a set of amino acid modifications selected from Q39E, Q39R, L45P, F122C, L124E, L124R, L143F, H172T, and H172R; and L1 and/or L2 comprises at least one or a set of amino acid modifications selected from Q38R, Q38E, P44F, Q124C, S131T, S131E, V133G, N137K, S174R, S176R, S176K, S176D, T178Y, and T178D. In some embodiments, H1 comprises amino acid modifications selected from the group consisting of Q39E, L45P, F122C, L124E, L143F, H172T, and H172R or combinations thereof; L1 comprises amino acid modifications selected from the group consisting of Q38R, P44F, Q124C, S131T, V133G, N137K, S174R, S176R, S176K, and T178Y, or combinations thereof; H2 comprises amino acid modifications selected from the group consisting of Q39R, L124R, and H172R, or combinations thereof; and L2 comprises amino acid modifications selected from the group consisting of Q38E, S131E, V133G, S176D, and T178D, or combinations thereof. In some embodiments, H1 comprises the amino acid modifications Q39E and L124E; L1 comprises the amino acid modifications Q38R, V133G, and S176R; H2 comprises the amino acid modifications Q39R and L124R; and L2 comprises the amino acid modifications Q38E, V133G, and S176D. In some embodiments, H1 comprises the amino acid modifications L45P and L124E; L1 comprises the amino acid modifications P44F, V133G, and S176R; H2 comprises the amino acid modification L124R; and L2 comprises the amino acid modifications V133G, S176D, and T178D. In some embodiments, H1 comprises the amino acid modifications L124E and L143F; L1 comprises the amino acid modifications V133G, and S176R; H2 comprises the amino acid modification L124R; and L2 comprises the amino acid modifications V133G, S176D, and T178D. In some embodiments, H1 comprises the amino acid modifications F122C and L124E; L1 comprises the amino acid modifications Q124C, V133G, and S176R; H2 comprises the amino acid modification L124R; and L2 comprises the amino acid modifications V133G and S176D. In some embodiments, H1 comprises the amino acid modifications L124E and H172T; L1 comprises the amino acid modifications V133G, N137K, S174R, and S176R; H2 comprises the amino acid modification L124R and H172R; and L2 comprises the amino acid modifications V133G, S176D, and T178D.

[0047] In some embodiments of the construct, H1 and/or H2 comprises at least one or a set of amino acid modifications at L124, A125, H172, and K228, and L1 and/or L2 comprises at least one or a set of amino acid modifications at S121, V133, N137, S174, S176, and T178. In some embodiments, H1 and/or H2 comprises at least one or a set of amino acid modifications selected from L124E, L124R, A125S, A125R, H172R, H172T, and K228D; and (ii) L1 and/or L2 comprises at least one or a set of amino acid modifications selected from S121K, V133G, N137K, S174R, S176K, S176R, S176D, and T178D. In some embodiments, H1 comprises amino acid modifications selected from the group consisting of L124E, A125S, H172R, and K228D or combinations thereof; L1 comprises amino acid modifications selected from the group consisting of S121K, V133G, and S176R, or combinations thereof; H2 comprises amino acid modifications selected from the group consisting of L124R, A125R, and H172T, or combinations thereof; and L2 comprises amino acid modifications selected from the group consisting of V133G, N137K, S174R, S176D, and T178D, or combinations thereof. In some embodiments, H1 comprises the amino acid modifications L124E and K228D; L1 comprises the amino acid modifications S121K, V133G, and S176R; H2 comprises the amino acid modifications L124R and A125R; and L2 comprises the amino acid modifications V133G and S176D. In some embodiments, H1 comprises the amino acid modifications L124E and H172R; L1 comprises the amino acid modifications V133G and S176R; H2 comprises the amino acid modifications L124R and H172T; and L2 comprises the amino acid modifications V133G, S174R, and S176D.

[0048] In some embodiments of the construct, H1 and/or H2 comprises at least one or a set of amino acid modifications at L124, A139, and V190, and L1 and/or L2 comprises at least one or a set of amino acid modifications at F116, V133, L135, and S176. In some embodiments, H1 and/or H2 comprises at least one or a set of amino acid modifications selected from L124E, L124R, A139W, A139G, and V190A; and L1 and/or L2 comprises at least one or a set of amino acid modifications selected from F116A, V133G, L135V, L135W, S176R, and S176D. In some embodiments, H1 comprises amino acid modifications selected from the group consisting of L124E and A139W, or combinations thereof; L1 comprises amino acid modifications selected from the group consisting of F116A, V133G, L135V, and S176R, or combinations thereof; H2 comprises amino acid modifications selected from the group consisting of L124R, A139G, and V190A, or combinations thereof; and L2 comprises amino acid modifications selected from the

group consisting of V133G, L135W, and S176D, or combinations thereof. In some embodiments, H1 comprises the amino acid modifications L124E and A139W; L1 comprises the amino acid modifications F116A, V133G, L135V, and S176R; H2 comprises the amino acid modifications L124R, A139G, and V190A; and L2 comprises the amino acid modifications V133G, L135W, and S176D.

[0049] In some embodiments of the construct, H1 and/or H2 comprises at least one or a set of amino acid modifications at Q39, L45, K145, H172, Q179 and S186, and L1 and/or L2 comprises at least one or a set of amino acid modifications at Q38, P44, Q124, S131, Q160, T180 and C214. In some embodiments, H1 and/or H2 comprises at least one or a set of amino acid modifications selected from Q39E, Q39R, L45P, K145T, H172R, Q179E and S186R; and L1 and/or L2 comprises at least one or a set of amino acid modifications selected from Q38R, Q38E, P44F, Q124E, S131K, Q160E, T180E and C214S. In some embodiments, H1 comprises amino acid modifications selected from the group consisting of Q39E, L45P, K145T, H172R, and Q179E, or combinations thereof; L1 comprises amino acid modifications selected from the group consisting of Q38R, P44F, and S131K, or combinations thereof; H2 comprises amino acid modifications selected from the group consisting of Q39R, H172R, and S186R, or combinations thereof; and L2 comprises amino acid modifications selected from the group consisting of Q38E, Q124E, Q160E, T180E and C214S, or combinations thereof. In some embodiments, H1 comprises the amino acid modifications Q39E, K145T, and Q179E; L1 comprises the amino acid modifications Q38R and S131K; H2 comprises the amino acid modifications Q39R and S186R; and L2 comprises the amino acid modifications Q38E, Q124E, Q160E, and T180E. In some embodiments, H1 comprises the amino acid modifications L45P, K145T, H172R, and Q179E; L1 comprises the amino acid modifications P44F and S131K; H2 comprises the amino acid modifications H172R and S186R; and L2 comprises the amino acid modifications Q124E, Q160E, and T180E.

[0050] In some embodiments of the construct, H1 and/or H2 comprises at least one or a set of amino acid modifications at A139, L143, K145, Q179 and V190, and L1 and/or L2 comprises at least one or a set of amino acid modifications at F116, Q124, L135, Q160, T178, and T180. In some embodiments, H1 and/or H2 comprises at least one or a set of amino acid modifications selected from A139W, A139G, L143E, K145T, Q179E, Q179K, and V190A; and L1 and/or L2

comprises at least one or a set of amino acid modifications selected from F116A, Q124R, Q124E, L135V, L135W, Q160E, T178R, and T180E. In some embodiments, H1 comprises amino acid modifications selected from the group consisting of A139W, L143E, K145T, and Q179E, or combinations thereof; L1 comprises amino acid modifications selected from the group consisting of F116A, Q124R, L135V, and T178R, or combinations thereof; H2 comprises amino acid modifications selected from the group consisting of A139G, Q179K, and V190A, or combinations thereof; and L2 comprises amino acid modifications selected from the group consisting of Q124E, L135W, Q160E, and T180E, or combinations thereof. In some embodiments, H1 comprises the amino acid modifications A139W, L143E, K145T, and Q179E; L1 comprises the amino acid modifications F116A, Q124R, L135V, and T178R; H2 comprises the amino acid modification Q179K; and L2 comprises the amino acid modifications Q124E, L135W, Q160E, and T180E.

[0051] In some embodiments of the construct, H1 and/or H2 comprises at least one or a set of amino acid modifications at Q39, L143, K145, D146, H172, and Q179, and L1 and/or L2 comprises at least one or a set of amino acid modifications at Q38, Q124, Q160, T178, and T180. In some embodiments, H1 and/or H2 comprises at least one or a set of amino acid modifications selected from Q39E, Q39R, L143E, K145T, D146G, H172R, Q179E, and Q179K; and L1 and/or L2 comprises at least one or a set of amino acid modifications selected from Q38R, Q38E, Q124R, Q124E, Q160K, Q160E, T178R, and T180E. In some embodiments, H1 comprises amino acid modifications selected from the group consisting of Q39E, L143E, K145T, H172R, and Q179E, or combinations thereof; L1 comprises amino acid modifications selected from the group consisting of Q38R, Q124R, Q160K, and T178R, or combinations thereof; H2 comprises amino acid modifications selected from the group consisting of Q39R, H172R, and Q179K, or combinations thereof; and L2 comprises amino acid modifications selected from the group consisting of Q38E, Q124E, D146G, Q160E, and T180E, or combinations thereof. In some embodiments, H1 comprises the amino acid modifications Q39E, L143E, K145T, and Q179E; L1 comprises the amino acid modifications Q38R, Q124R, Q160K, and T178R; H2 comprises the amino acid modifications Q39R, H172R, and Q179K; and L2 comprises the amino acid modifications Q38E, Q124E, Q160E, and T180E.



[0052] In some embodiments of the construct, H1 and/or H2 comprises at least one or a set of amino acid modifications at L45, L143, K145, D146, H172, and Q179, and L1 and/or L2 comprises at least one or a set of amino acid modifications at Q38, P44, Q124, N137, Q160, S174, T178, T180, and C214. In some embodiments, H1 and/or H2 comprises at least one or a set of amino acid modifications selected from L45P, L143E, K145T, D146G, H172R, H172T, Q179E, and Q179K; and (ii) L1 and/or L2 comprises at least one or a set of amino acid modifications selected from Q38E, P44F, Q124R, Q124E, N137K, Q160K, Q160E, S174R, T178R, T180E, and C214S. In some embodiments, H1 comprises amino acid modifications selected from the group consisting of L45P, L143E, K145T, H172R, and Q179E, or combinations thereof; L1 comprises amino acid modifications selected from the group consisting of P44F, Q124R, Q160K, and T178R, or combinations thereof; H2 comprises amino acid modifications selected from the group consisting of D146G, H172R, H172T, and Q179K, or combinations thereof; and L2 comprises amino acid modifications selected from the group consisting of Q38E, Q124E, N137K, Q160E, S174R, T180E, and C214S, or combinations thereof. In some embodiments, H1 comprises the amino acid modifications L45P, L143E, and K145T; L1 comprises the amino acid modifications P44F, Q124R, Q160K, and T178R; H2 comprises the amino acid modifications D146G and Q179K; and L2 comprises the amino acid modifications Q38E, Q124E, Q160E, and T180E. In some embodiments, H1 comprises the amino acid modifications L143E, K145T, and H172R; L1 comprises the amino acid modifications Q124R, Q160K, and T178R; H2 comprises the amino acid modifications H172T and Q179K; and L2 comprises the amino acid modifications Q124E, Q160E, N137K, S174R, and T180E.

[0053] In some embodiments of the construct, H1 and/or H2 comprises at least one or a set of amino acid modifications at L124, L143, K145, and Q179, and L1 and/or L2 comprises at least one or a set of amino acid modifications at Q124, S131, V133, S176, T178, and T180. In some embodiments, H1 and/or H2 comprises at least one or a set of amino acid modifications selected from L124W, L124A, L143E, L143F, K145T, Q179E, and Q179K; and L1 and/or L2 comprises at least one or a set of amino acid modifications selected from Q124R, Q124K, Q124E, S131K, V133A, V133W, S176T, T178R, T178L, T178E, and T180E. In some embodiments, H1 comprises amino acid modifications selected from the group consisting of L124W, L143E, K145T, and Q179E, or combinations thereof; L1 comprises amino acid modifications selected

from the group consisting of Q124R, Q124K, S131K, V133A, S176T, T178R, and T178L, or combinations thereof; H2 comprises amino acid modifications selected from the group consisting of L124A, L143F, and Q179K, or combinations thereof; and L2 comprises amino acid modifications selected from the group consisting of Q124E, V133W, S176T, T178L, T178E, and T180E, or combinations thereof. In some embodiments, H1 comprises the amino acid modifications L124W, L143E, K145T, and Q179E; L1 comprises the amino acid modifications Q124R, V133A, S176T, and T178R; H2 comprises the amino acid modifications L124A, L143F, and Q179K; and L2 comprises the amino acid modifications Q124E, V133W, S176T, T178L, and T180E.

[0054] In some embodiments of the construct, H1 and/or H2 comprises at least one or a set of amino acid modifications at A139, L143, K145, Q179, and S186, and L1 and/or L2 comprises at least one or a set of amino acid modifications at F116, Q124, V133, Q160, T178, and T180. In some embodiments, H1 and/or H2 comprises at least one or a set of amino acid modifications selected from A139C, L143E, L143D, L143R, L143K, K145T, Q179E, Q179D, Q179R, Q179K, S186K, S186R; and L1 and/or L2 comprises at least one or a set of amino acid modifications selected from F116C, Q124R, Q124K, Q124E, V133E, V133D, Q160K, Q160E, T178R, T178K, T178E, and T180E. In some embodiments, H1 comprises amino acid modifications selected from the group consisting of A139C, L143E, L143D, K145T, Q179E, and Q179D, or combinations thereof; L1 comprises amino acid modifications selected from the group consisting of F116C, Q124R, Q124K, Q160K, T178R, and T178K, or combinations thereof; H2 comprises amino acid modifications selected from the group consisting of L143R, L143K, Q179R, Q179K, S186K, and S186R, or combinations thereof; and L2 comprises amino acid modifications selected from the group consisting of Q124E, V133E, V133D, Q160E, T178E, and T180E, or combinations thereof. In some embodiments, H1 comprises the amino acid modifications A139C, L143E, K145T, and Q179E; L1 comprises the amino acid modifications F116C, Q124R, and T178R; H2 comprises the amino acid modification Q179K; and L2 comprises the amino acid modifications Q124E, Q160E, and T180E. In some embodiments, H1 comprises the amino acid modifications L143E, K145T, and Q179E; L1 comprises the amino acid modifications Q124R and T178R; H2 comprises the amino acid modification S186K; and L2 comprises the amino acid modifications Q124E, Q160E, and T178E. In some embodiments, H1 comprises the amino acid modifications L143E, K145T, and Q179E; L1 comprises the amino acid modifications Q124R

and T178R; H2 comprises the amino acid modification L143R; and L2 comprises the amino acid modifications Q124E and V133E.

[0055] In some embodiments of the construct, H1 and/or H2 comprises at least one or a set of amino acid modifications at L124, L143, K145, D146, Q179, S186, and S188, and L1 and/or L2 comprises at least one or a set of amino acid modifications at Q124, S131, V133, Q160, S176, T178, and T180. In some embodiments, H1 and/or H2 comprises at least one or a set of amino acid modifications selected from L124A, L143A, L143R, L143E, L143K, K145T, D146G, Q179R, Q179E, Q179K, S186R, S186K, and S188L; and L1 and/or L2 comprises at least one or a set of amino acid modifications selected from Q124R, Q124E, S131E, S131T, V133Y, V133W, V133E, V133D, Q160E, Q160K, Q160M, S176L, T178R, T178E, T178F, T178Y, and T180E. In some embodiments, H1 comprises amino acid modifications selected from the group consisting of L143E, K145T, Q179E, and S188L, or combinations thereof; L1 comprises amino acid modifications selected from the group consisting of Q124R, Q160K, and T178R, or combinations thereof; H2 comprises amino acid modifications selected from the group consisting of L124A, L143A, L143R, L143K, D146G, Q179R, Q179K, S186R, and S186K, or combinations thereof; and L2 comprises amino acid modifications selected from the group consisting of Q124E, S131E, S131T, V133Y, V133W, V133E, V133D, Q160E, Q160M, S176L, T178E, T178F, T178Y, and T180E, or combinations thereof. In some embodiments, H1 comprises the amino acid modifications L143E, K145T, Q179E, and S188L; L1 comprises the amino acid modifications Q124R and T178R; H2 comprises the amino acid modification S186K; and L2 comprises the amino acid modifications Q124E, S176L, and T180E. In some embodiments, H1 comprises the amino acid modifications L143E, K145T, Q179E, and S188L; L1 comprises the amino acid modifications Q124R and T178R; H2 comprises the amino acid modification S186K; and L2 comprises the amino acid modifications Q124E, S131T, T178Y, and T180E. In some embodiments, H1 comprises the amino acid modifications L143E and K145T; L1 comprises the amino acid modifications Q124R, Q160K, and T178R; H2 comprises the amino acid modification S186K; and L2 comprises the amino acid modifications S131E. In some embodiments, H1 comprises the amino acid modifications L143E and K145T; L1 comprises the amino acid modification Q124R; H2 comprises the amino acid modification L143R; and L2 comprises the amino acid modifications Q124E and V133E.

[0056] In some embodiments of the construct, H1 comprises at least one or a set of amino acid modifications at F122 and C233, and L1 comprises at least one or a set of amino acid modifications at Q124 and C214. In some embodiments, H1 comprises at least one or a set of amino acid modifications selected from F122C and C233S; and L1 comprises at least one or a set of amino acid modifications selected from Q124C and C214S. In some embodiments, H1 comprises amino acid modifications selected from the group consisting of F122C and C233S, or combinations thereof; L1 comprises amino acid modifications selected from the group consisting of Q124C and C214S, or combinations thereof; H2 comprises a wild-type or unmodified amino acid sequence; and L2 comprises a wild-type or unmodified amino acid sequence. In some embodiments, H1 comprises the amino acid modifications F122C and C233S; L1 comprises the amino acid modifications Q124C and C214S; H2 comprises a wild-type or unmodified amino acid sequence; and L2 comprises a wild-type or unmodified amino acid sequence.

[0057] In some embodiments, the construct comprises amino acid modifications selected from SMCA designs 9561-9095\_1, 9561-9095\_2, 9121-9373\_1, 9121-9373\_2, 9116-9349\_1, 9116-9349\_2, 9134-9521\_1, 9134-9521\_2, 9286-9402\_1, 9286-9402\_2, 9667-9830\_1, 9667-9830\_2, 9696-9848\_1, 9696-9848\_2, 9060-9756\_1, 9060-9756\_2, 9682-9740\_1, 9682-9740\_2, 9049-9759\_1, 9049-9759\_2, 9820-9823\_1, and 9820-9823\_2 of the Tables herein. In some embodiments, the construct comprises amino acid modifications selected from SMCA designs 9327-6054\_1, 9815-9825\_1, 9815-9825\_2, 9587-9735\_1, 9587-9735\_2, 3522\_1, 3522\_2, 3519\_1, and 3519\_2 of the Tables herein.

[0058] In some embodiments, H1 and/or H2 does not comprise an amino acid modification at position Q179. In some embodiments, H1 does not comprise the amino acid modification Q179E and/or H2 does not comprise the amino acid modification Q179K. In some embodiments, L1 does not comprise an amino acid modification at position S131. In one embodiment, L1 does not comprise the amino acid modification S131K. In some embodiments, L2 does not comprise an amino acid modification at position T180. In one embodiment, L2 does not comprise the amino acid modification T180E. In some embodiments, the construct does not comprise a combination of amino acid modifications wherein H1 comprises Q179E, L1 comprises S131K, H2 comprises Q179K, and L2 comprises T180E.

[0059] In some embodiments, H1 does not comprise an amino acid modification at position Q39 and/or Q179. In some embodiments, H1 does not comprise the amino acid modification Q39E and/or Q179E. In some embodiments, L1 does not comprise an amino acid modification at position Q160. In one embodiment, L1 does not comprise the amino acid modification Q160K. In some embodiments, H2 does not comprise an amino acid modification at position Q179. In one embodiment, H2 does not comprise the amino acid modification Q179K. In some embodiments, L2 does not comprise an amino acid modification at position Q38, Q160, and/or T180. In one embodiment, L2 does not comprise the amino acid modifications Q38E, Q160E, and/or T180E. In some embodiments, the construct does not comprise a combination of amino acid modifications wherein H1 comprises Q39E and/or Q179E, L1 comprises Q160K, H2 comprises Q179K, and L2 comprises Q38E, Q160E and/or T180E. For example, in some embodiments, the construct does not comprise a combination of amino acid modifications wherein: (i) H1 comprises Q179E, L1 comprises Q160K, H2 comprises Q179K, and L2 comprises Q160E and T180E; (ii) H1 comprises Q39E and Q179E, L1 comprises Q160K, H2 comprises Q179K, and L2 comprises Q38E, Q160E and T180E; or (iii) H1 comprises Q39E, L1 comprises Q160K, H2 comprises Q179K, and L2 comprises Q38E, Q160E and T180E.

[0060] In some embodiments, H1 does not comprise an amino acid modification at position Q179. In some embodiments, H1 does not comprise the amino acid modification Q179K or Q179E. In some embodiments, L1 does not comprise an amino acid modification at position Q160 and/or T180. In one embodiment, L1 does not comprise the amino acid modification Q160E, Q160K, and/or T180E. In some embodiments, H2 does not comprise an amino acid modification at position Q179. In one embodiment, H2 does not comprise the amino acid modification Q179K or Q179E. In some embodiments, L2 does not comprise an amino acid modification at position Q160 and/or T180. In one embodiment, L2 does not comprise the amino acid modifications Q160K, Q160E, and/or T180E. In some embodiments, the construct does not comprise a combination of amino acid modifications wherein H1 comprises Q179K or Q179E, L1 comprises Q160E, Q160K, and/or T180E, H2 comprises Q179K or Q179E, and L2 comprises Q160K, Q160E, and/or T180E.

[0061] In some embodiments, H1 and/or H2 does not comprise an amino acid modification at position Q179. In some embodiments, H1 does not comprise the amino acid modification

Q179K and/or H2 does not comprise the amino acid modification Q179E. In some embodiments, L1 does not comprise an amino acid modification at position T180. In one embodiment, L1 does not comprise the amino acid modification T180E. In some embodiments, L2 does not comprise an amino acid modification at position S131. In one embodiment, L2 does not comprise the amino acid modification S131K. In some embodiments, the construct does not comprise a combination of amino acid modifications wherein H1 comprises Q179K, L1 comprises T180E, H2 comprises Q179E, and L2 comprises S131K.

[0062] In some embodiments, H1 does not comprise an amino acid modification at position Q179. In some embodiments, H1 does not comprise the amino acid modification Q179E. In some embodiments, L1 does not comprise an amino acid modification at position Q160. In one embodiment, L1 does not comprise the amino acid modification Q160K. In some embodiments, H2 does not comprise an amino acid modification at position Q179. In one embodiment, H2 does not comprise the amino acid modification Q179K. In some embodiments, L2 does not comprise an amino acid modification at position T180. In one embodiment, L2 does not comprise the amino acid modification T180E. In some embodiments, the construct does not comprise a combination of amino acid modifications wherein H1 comprises Q179E, L1 comprises Q160K, H2 comprises Q179K, and L2 comprises T180E.

[0063] In some embodiments, H1 does not comprise an amino acid modification at position A139. In some embodiments, H1 does not comprise the amino acid modification A139C. In some embodiments, L1 does not comprise an amino acid modification at position F116. In one embodiment, L1 does not comprise the amino acid modification F116C. In some embodiments, the construct does not comprise a combination of amino acid modifications wherein H1 comprises A139C and L1 comprises F116C.

[0064] In some embodiments, the construct does not comprise native disulfide linkages between the heavy and light chains. For example, in some embodiments, the cysteine at position 214 of L1 and/or L2 is modified to another amino acid. In some embodiments, L1 and/or L2 comprises the amino acid modification C214S. In some embodiments, the cysteine at position 233 of H1 and/or H2 is modified to another amino acid. In one embodiment, H1 and/or H2 comprises the amino acid modification C233S.

[0065] The embodiments described herein are applicable to constructs in the Fab format and full antibody format.

### BRIEF DESCRIPTION OF THE FIGURES

[0066] **Figure 1** depicts D3H44 heavy chain and light chain amino acid sequences aligned against canonical human germline sequences for Variable, Constant and J-region segments (Notations in figures: \* sequence identity). **Figure 1A** depicts Human VH germline subgroups (one representative sequence is displayed for each family). Sequence identity based on an alignment of D3H44 against VH3 and IGHJ3\*02. **Figure 1B** depicts Human kappa VL germline subgroups (one representative sequence is displayed from each family). Sequence identity based on an alignment of D3H44 against VKI and IGKJ1\*01. **Figure 1C** depicts Human lambda VL germline subgroups (one representative sequence is displayed from each family). Sequence identity based on an alignment of D3H44 against VL1 and IGLJ1\*01. **Figure 1D** depicts human CH1 allele sequences. **Figure 1E** depicts Human kappa and lambda allele sequences.

[0067] **Figure 2** depicts a flowchart for identifying critical interface residues and for computational modeling of designs with preferential heavy-light chain pairing.

[0068] **Figure 3** depicts an exemplary set of H1, L1, H2, L2 chains which have been designed such that H1 preferentially pairs with L1 over L2 and H2 preferentially pairs with L2 over L1. A cartoon representation of the 3D crystal structure of the variable region heavy and light chain interface is presented. The mutations introduced at the interface achieve electrostatic and steric complementarity for the preferentially forming obligate pairs H1-L1 and H2-L2, respectively. On the other hand, there is unfavorable steric and electrostatic mismatch in the incorrect pair that would result in reduced pairing propensity for the mismatched pair as well as reduced stability.

[0069] **Figure 4** illustrates a high level schematic overview of the engineering requirements for forming a bispecific Mab (monoclonal antibody), and the assay requirements needed to quantify heavy chain light chain pairs. The design goal of engineering a bispecific Mab with high purity (i.e., little or no mispaired H-L associations) can be achieved by rationally engineering (via the introduction of specific amino acid mutations) the preferential pairing of two unique heavy chains for their unique cognate light chains. This process is shown schematically; here H1 has been engineered to preferentially pair with L1 and not L2. Likewise,

H2 has been engineered to preferentially pair with L2 and not L1. The experimental screening of bispecific Mab designs requires an assay capable of simultaneously quantifying H1-L1:H1-L2 and H2-L2:H2-L1. These assay requirements can be simplified by assuming that each bispecific Fab arm can be independently engineered. In this case, the assay would only need to quantify H1-L1:H1-L2 or H2-L2:H2-L1, and not both simultaneously.

[0070] **Figure 5** provides a schematic depicting how heavy chains and light chains are tagged and preferential pairing is determined. In this schematic, the circle represents a cell in which 3 constructs are transfected. The expression products are secreted from the cell and the supernatant (SPNT) is flowed over a detection device, in this case an SPR chip. Based on the detection level of the two different tags fused to the two light chains competing for heavy chain pairing, a quantitative estimate of the preferential pairing of the heavy chain to the two light chains can be estimated.

[0071] **Figure 6** depicts box plots that show the average LCCA performance values of paired:mispaired Fab heterodimers of at least 86:14 for each cluster.

[0072] **Figure 7** shows representative UPLC-SEC profiles for A) WT Fab heterodimer as well as B) a representative designed Fab heterodimer (the H1L1 Fab component of LCCA designs 9735, 9737, and 9740).

[0073] **Figure 8** depicts the potential heavy chain associated products that can be expected when two different light chains are co-expressed with two different heavy chains in a cell. Preferential pairing is assessed using an SMCA (monoclonal antibody competition assay).

[0074] **Figure 9** depicts the bias/chain utilization preferences within a) D3H44/trastuzumab, b) D3H44/cetuximab, and c) trastuzumab/cetuximab bispecific systems. The chain utilization was assessed in the different species observed by LC-MS. The x-axis presents the H1:H2:L1:L2 DNA ratio and the Y axis shows the corresponding percentage of each chain within the different transfection experiments. In a balanced system, all H and L chains would exhibit 25%. Bias towards utilization of one light chain is observed across all bispecific systems.

[0075] **Figure 10** shows representative UPLC-SEC profiles for WT heterodimeric as well as engineered heterodimeric antibodies. Figure 10a and 10b refers to D3H44/trastuzumab WT and 9060-9756\_\_1, respectively. Figure 10c and 10d refers to D3H44/Cetuximab WT and 9820-9823\_\_1, respectively. Figure 10e and 10f refers to trastuzumab/cetuximab WT and 9696-9848\_\_1, respectively.



[0076] **Figure 11** depicts box plots of the changes in the % of the correctly paired Fab component over all mispaired Fab components utilizing the same heavy chain (H1:L1 over all H1 species with respect to wild type for D3H44/trastuzumab and D3H44/cetuximab; the change of H2:L2 over all H2 species with respect to wild type for trastuzumab/cetuximab) as well as changes in the percentage of the desired bispecific antibody with respect to wild type, for engineered bispecific antibody samples per cluster. Changes in the % of the correctly paired Fab component over all mispaired Fab components utilizing the same heavy chain vs cluster are shown for each system in a) D3H44/trastuzumab, c) D3H44/cetuximab and e) trastuzumab/cetuximab. Changes in the percentage of the desired bispecific antibody with respect to wild type vs cluster are shown for each system in b) D3H44/trastuzumab, d) D3H44/cetuximab and f) trastuzumab/cetuximab. Across all bispecific systems, changes in the % of the correctly paired Fab component over all mispaired Fab components utilizing the same heavy chain vs cluster are shown in figure 11g and changes in the percentage of the desired bispecific antibody with respect to wild type vs cluster are shown in figure 11h. Note that the values reported also include estimated changes for engineered bispecific antibody samples where the corresponding wild type constructs were not assessed by SMCA.

[0077] **Figure 12** depicts a method of preparing a bi-specific antibody using the library of obligate mutation pairs provided herein.

### DETAILED DESCRIPTION

[0078] Provided herein are antigen binding polypeptide constructs (also referred to as heterodimer pairs) which can comprise a first heterodimer and a second heterodimer wherein each heterodimer comprises an immunoglobulin heavy chain or fragment thereof and an immunoglobulin light chain. Both of the heterodimers can comprise one or more amino acid modifications in the immunoglobulin heavy chain constant domain 1 (CH1) and one or more amino acid modifications in the immunoglobulin light chain constant domain (CL); one or more amino acid modifications in the immunoglobulin heavy chain variable domain (VH) and one or more amino acid modifications in the immunoglobulin light chain variable domain (VL); or a combination of the preceding amino acid modifications to both the constant and variable domains of the heavy and light chains. The amino acids that are modified are typically part of the interface between the light chain and heavy chain and are modified to create preferential

pairing between each heavy chain and the desired light chain such that the heavy chain of the first heterodimer preferentially pairs with one of the light chains rather than the other. Likewise, the heavy chain of the second heterodimer can preferentially pair with the second light chain rather than first.

[0079] As noted above, specific combinations of the amino acid modifications described herein promote preferential pairing of heavy chains with specific light chains, thus enabling bi-specific monoclonal antibody (Mab) expression to occur with negligible or limited mispairing, and minimizing the need to purify the desired heterodimers from undesired, or mispaired products. The heterodimers can exhibit comparable thermal stability to heterodimers that do not include the amino acid modifications, and can also demonstrate binding affinity for antigen that is comparable to heterodimers that do not include the amino acid modifications.

The designs of the first and second heterodimers, can be used to create bi-specific antibodies targeting two different therapeutic targets or targeting two distinct epitopes (overlapping or non-overlapping) within the same antigen.

[0080] Also provided herein are methods of preparing the heterodimer pairs.

### **Definitions**

[0081] Unless defined otherwise, all technical and scientific terms used herein have the same meaning as is commonly understood by one of skill in the art to which the claimed subject matter belongs. In the event that there are a plurality of definitions for terms herein, those in this section prevail. Where reference is made to a URL or other such identifier or address, it is understood that such identifiers can change and particular information on the internet can come and go, but equivalent information can be found by searching the internet. Reference thereto evidences the availability and public dissemination of such information.

[0082] It is to be understood that the foregoing general description and the following detailed description are exemplary and explanatory only and are not restrictive of any subject matter claimed. In this application, the use of the singular includes the plural unless specifically stated otherwise.

[0083] In the present description, any concentration range, percentage range, ratio range, or integer range is to be understood to include the value of any integer within the recited range and, when appropriate, fractions thereof (such as one tenth and one hundredth of an integer), unless

otherwise indicated. As used herein, "about" means  $\pm 10\%$  of the indicated range, value, sequence, or structure, unless otherwise indicated. It should be understood that the terms "a" and "an" as used herein refer to "one or more" of the enumerated components unless otherwise indicated or dictated by its context. The use of the alternative (e.g., "or") should be understood to mean either one, both, or any combination thereof of the alternatives. As used herein, the terms "include" and "comprise" are used synonymously. In addition, it should be understood that the individual single chain polypeptides or immunoglobulin constructs derived from various combinations of the structures and substituents described herein are disclosed by the present application to the same extent as if each single chain polypeptide or heterodimer were set forth individually. Thus, selection of particular components to form individual single chain polypeptides or heterodimers is within the scope of the present disclosure

[0084] The section headings used herein are for organizational purposes only and are not to be construed as limiting the subject matter described. All documents, or portions of documents, cited in the application including, but not limited to, patents, patent applications, articles, books, manuals, and treatises are hereby expressly incorporated by reference in their entirety for any purpose.

[0085] It is to be understood that the methods and compositions described herein are not limited to the particular methodology, protocols, cell lines, constructs, and reagents described herein and as such may vary. It is also to be understood that the terminology used herein is for the purpose of describing particular embodiments only, and is not intended to limit the scope of the methods and compositions described herein, which will be limited only by the appended claims.

[0086] All publications and patents mentioned herein are incorporated herein by reference in their entirety for the purpose of describing and disclosing, for example, the constructs and methodologies that are described in the publications, which might be used in connection with the methods, compositions and compounds described herein. The publications discussed herein are provided solely for their disclosure prior to the filing date of the present application. Nothing herein is to be construed as an admission that the inventors described herein are not entitled to antedate such disclosure by virtue of prior invention or for any other reason.

In the present application, amino acid names and atom names (e.g. N, O, C, etc.) are used as defined by the Protein DataBank (PDB) ([www.pdb.org](http://www.pdb.org)), which is based on the IUPAC

nomenclature (IUPAC Nomenclature and Symbolism for Amino Acids and Peptides (residue names, atom names etc.), Eur. J. Biochem., 138, 9-37 (1984) together with their corrections in Eur. J. Biochem., 152, 1 (1985). The term "amino acid residue" is primarily intended to indicate an amino acid residue contained in the group consisting of the 20 naturally occurring amino acids, i.e. alanine (Ala or A), cysteine (Cys or C), aspartic acid (Asp or D), glutamic acid (Glu or E), phenylalanine (Phe or F), glycine (Gly or G), histidine (His or H), isoleucine (Ile or I), lysine (Lys or K), leucine (Leu or L), methionine (Met or M), asparagine (Asn or N), proline (Pro or P), glutamine (Gln or Q), arginine (Arg or R), serine (Ser or S), threonine (Thr or T), valine (Val or V), tryptophan (Trp or W), and tyrosine (Tyr or Y) residues.

[0087] The terms "polypeptide," "peptide" and "protein" are used interchangeably herein to refer to a polymer of amino acid residues. That is, a description directed to a polypeptide applies equally to a description of a peptide and a description of a protein, and vice versa. The terms apply to naturally occurring amino acid polymers as well as amino acid polymers in which one or more amino acid residues is a non-naturally encoded amino acid. As used herein, the terms encompass amino acid chains of any length, including full length proteins, wherein the amino acid residues are linked by covalent peptide bonds.

[0088] The term "nucleotide sequence" or "nucleic acid sequence" is intended to indicate a consecutive stretch of two or more nucleotide molecules. The nucleotide sequence can be of genomic, cDNA, RNA, semisynthetic or synthetic origin, or any combination thereof.

[0089] "Cell", "host cell", "cell line" and "cell culture" are used interchangeably herein and all such terms should be understood to include progeny resulting from growth or culturing of a cell. "Transformation" and "transfection" are used interchangeably to refer to the process of introducing a nucleic acid sequence into a cell.

[0090] The term "amino acid" refers to naturally occurring and non-naturally occurring amino acids, as well as amino acid analogs and amino acid mimetics that function in a manner similar to the naturally occurring amino acids. Naturally encoded amino acids are the 20 common amino acids (alanine, arginine, asparagine, aspartic acid, cysteine, glutamine, glutamic acid, glycine, histidine, isoleucine, leucine, lysine, methionine, phenylalanine, proline, serine, threonine, tryptophan, tyrosine, and valine) and pyrrolysine and selenocysteine. Amino acid analogs refers to compounds that have the same basic chemical structure as a naturally occurring amino acid, i.e., an a carbon that is bound to a hydrogen, a carboxyl group, an amino group, and

an R group, such as, homoserine, norleucine, methionine sulfoxide, methionine methyl sulfonium. Such analogs have modified R groups (such as, norleucine) or modified peptide backbones, but retain the same basic chemical structure as a naturally occurring amino acid. Reference to an amino acid includes, for example, naturally occurring proteogenic L-amino acids; D-amino acids, chemically modified amino acids such as amino acid variants and derivatives; naturally occurring non-proteogenic amino acids such as alanine, ornithine, etc.; and chemically synthesized compounds having properties known in the art to be characteristic of amino acids. Examples of non-naturally occurring amino acids include, but are not limited to,  $\beta$ -methyl amino acids (e.g. methyl alanine), D-amino acids, histidine-like amino acids (e.g., 2-amino-histidine, hydroxy-histidine, homohistidine), amino acids having an extra methylene in the side chain ("homo" amino acids), and amino acids in which a carboxylic acid functional group in the side chain is replaced with a sulfonic acid group (e.g., cysteic acid). The incorporation of non-natural amino acids, including synthetic non-native amino acids, substituted amino acids, or one or more D-amino acids into the proteins of the present invention can be advantageous in a number of different ways. D-amino acid-containing peptides, etc., exhibit increased stability in vitro or in vivo compared to L-amino acid-containing counterparts. Thus, the construction of peptides, etc., incorporating D-amino acids can be particularly useful when greater intracellular stability is desired or required. More specifically, D-peptides, etc., are resistant to endogenous peptidases and proteases, thereby providing improved bioavailability of the molecule, and prolonged lifetimes in vivo when such properties are desirable. Additionally, D-peptides, etc., cannot be processed efficiently for major histocompatibility complex class II-restricted presentation to T helper cells, and are therefore, less likely to induce humoral immune responses in the whole organism.

[0091] Amino acids are referred to herein by either their commonly known three letter symbols or by the one-letter symbols recommended by the IUPAC-IUB Biochemical Nomenclature Commission. Nucleotides, likewise, can be referred to by their commonly accepted single-letter codes.

[0092] "Conservatively modified variants" applies to both amino acid and nucleic acid sequences. With respect to particular nucleic acid sequences, "conservatively modified variants" refers to those nucleic acids which encode identical or essentially identical amino acid sequences, or where the nucleic acid does not encode an amino acid sequence, to essentially

identical sequences. Because of the degeneracy of the genetic code, a large number of functionally identical nucleic acids encode any given protein. For instance, the codons GCA, GCC, GCG and GCU all encode the amino acid alanine. Thus, at every position where an alanine is specified by a codon, the codon can be altered to any of the corresponding codons described without altering the encoded polypeptide. Such nucleic acid variations are "silent variations," which are one species of conservatively modified variations. Every nucleic acid sequence herein which encodes a polypeptide also describes every possible silent variation of the nucleic acid. One of ordinary skill in the art will recognize that each codon in a nucleic acid (except AUG, which is ordinarily the only codon for methionine, and TGG, which is ordinarily the only codon for tryptophan) can be modified to yield a functionally identical molecule. Accordingly, each silent variation of a nucleic acid which encodes a polypeptide is implicit in each described sequence.

[0093] As to amino acid sequences, one of ordinary skill in the art will recognize that individual substitutions, deletions or additions to a nucleic acid, peptide, polypeptide, or protein sequence which alters, adds or deletes a single amino acid or a small percentage of amino acids in the encoded sequence is a "conservatively modified variant" where the alteration results in the deletion of an amino acid, addition of an amino acid, or substitution of an amino acid with a chemically similar amino acid. Conservative substitution tables providing functionally similar amino acids are known to those of ordinary skill in the art. Such conservatively modified variants are in addition to and do not exclude polymorphic variants, interspecies homologs, and alleles of the invention.

[0094] Conservative substitution tables providing functionally similar amino acids are known to those of ordinary skill in the art. The following eight groups each contain amino acids that are conservative substitutions for one another:

Alanine (A), Glycine (G);

Aspartic acid (D), Glutamic acid (E);

Asparagine (N), Glutamine (Q);

Arginine (R), Lysine (K);

Isoleucine (I), Leucine (L), Methionine (M), Valine (V);

Phenylalanine (F), Tyrosine (Y), Tryptophan (W);

Serine (S), Threonine (T); and

## Cysteine (C), Methionine (M)

(see, e.g., Creighton, *Proteins: Structures and Molecular Properties* (W H Freeman & Co.; 2nd edition (December 1993).

[0095] The terms "identical" or percent "identity," in the context of two or more nucleic acids or polypeptide sequences, refer to two or more sequences or subsequences that are the same. Sequences are "substantially identical" if they have a percentage of amino acid residues or nucleotides that are the same (i.e., at least about 50%, 55%, 60%, 65%, 70%, 75%, 80%, 85%, 90%, 91%, 92%, 93%, 94%, 95%, 96%, 97%, 98%, or 99% identity over a specified region), when compared and aligned for maximum correspondence over a comparison window, or designated region as measured using one of the following sequence comparison algorithms (or other algorithms available to persons of ordinary skill in the art) or by manual alignment and visual inspection. This definition also refers to the complement of a test sequence. The identity can exist over a region that is at least about 50 amino acids or nucleotides in length, or over a region that is 75-100 amino acids or nucleotides in length, or, where not specified, across the entire sequence of a polynucleotide or polypeptide. A polynucleotide encoding a polypeptide of the present invention, including homologs from species other than human, can be obtained by a process comprising the steps of screening a library under stringent hybridization conditions with a labeled probe having a polynucleotide sequence of the invention or a fragment thereof, and isolating full-length cDNA and genomic clones containing said polynucleotide sequence. Such hybridization techniques are well known to the skilled artisan.

[0096] A derivative, or a variant of a polypeptide is said to share "homology" or be "homologous" with the peptide if the amino acid sequences of the derivative or variant has at least 50% identity with a 100 amino acid sequence from the original peptide. In certain embodiments, the derivative or variant is at least 75% the same as that of either the peptide or a fragment of the peptide having the same number of amino acid residues as the derivative. In certain embodiments, the derivative or variant is at least 85% the same as that of either the peptide or a fragment of the peptide having the same number of amino acid residues as the derivative. In certain embodiments, the amino acid sequence of the derivative is at least 90% the same as the peptide or a fragment of the peptide having the same number of amino acid residues as the derivative. In some embodiments, the amino acid sequence of the derivative is at least 95% the same as the peptide or a fragment of the peptide having the same number of amino acid

residues as the derivative. In certain embodiments, the derivative or variant is at least 99% the same as that of either the peptide or a fragment of the peptide having the same number of amino acid residues as the derivative.

[0097] As used herein, an “isolated” polypeptide or construct means a construct or polypeptide that has been identified and separated and/or recovered from a component of its natural cell culture environment. Contaminant components of its natural environment are materials that would typically interfere with diagnostic or therapeutic uses for the heteromultimer, and can include enzymes, hormones, and other proteinaceous or non-proteinaceous solutes.

[0098] In certain embodiments, as used herein, “isolated” antigen-binding polypeptide constructs described herein comprise heterodimer pairs or “isolated” heterodimer pairs that comprise a heterodimer or heterodimer pair that has been identified and separated and/or recovered from a component of its natural cell culture environment. Contaminant components of its natural environment are materials that would interfere with diagnostic or therapeutic uses for the heterodimer or antigen-binding polypeptide constructs, and can include enzymes, hormones, and other proteinaceous or non-proteinaceous solutes.

[0099] The heterodimers and antigen-binding polypeptide constructs and heterodimer pairs are generally purified to substantial homogeneity. The phrases “substantially homogeneous”, “substantially homogeneous form” and “substantial homogeneity” are used to indicate that the product is substantially devoid of by-products originated from undesired polypeptide combinations (e.g. homodimers). In this context, the species of interest is the heterodimer comprising H1 and L1 (H1-L1), or H2 and L2 (H2-L2). Contaminants include heterodimers comprising H1 and L2 (H1-L2), or H2 and L1 (H2-L1) or homodimers comprising H1 and L1 or H2 and L2 (regardless of whether the Fab portion is correctly paired or mispaired). Expressed in terms of purity, substantial homogeneity means that the amount of by-products does not exceed 10%, for example is below 5%, below 1%, or below 0.5% of the total LC-MS intensity from all species present in the mixture, wherein the percentages reflect results from Mass Spectrometric analysis.

[0100] The phrase “selectively (or specifically) hybridizes to” refers to the binding, duplexing, or hybridizing of a molecule only to a particular nucleotide sequence under stringent



hybridization conditions when that sequence is present in a complex mixture (including but not limited to, total cellular or library DNA or RNA).

[0101] Terms understood by those in the art of antibody technology are each given the meaning acquired in the art, unless expressly defined differently herein. Antibodies are known to have variable regions, a hinge region, and constant domains. Immunoglobulin structure and function are reviewed, for example, in Harlow et al, Eds., *Antibodies: A Laboratory Manual*, Chapter 14 (Cold Spring Harbor Laboratory, Cold Spring Harbor, 1988).

[0102] As used herein, the terms “antibody” and “immunoglobulin” or “antigen binding polypeptide construct” are used interchangeably. An “antigen binding polypeptide construct” refers to a polypeptide substantially encoded by an immunoglobulin gene or immunoglobulin genes, or one or more fragments thereof, which specifically bind an analyte (antigen). The recognized immunoglobulin genes include the kappa, lambda, alpha, gamma, delta, epsilon and mu constant region genes, as well as the myriad immunoglobulin variable region genes. Light chains are classified as either kappa or lambda. Heavy chains are classified as gamma, mu, alpha, delta, or epsilon, which in turn define the immunoglobulin isotypes, IgG, IgM, IgA, IgD, and IgE, respectively. Further, the antibody can belong to one of a number of subtypes, for instance, the IgG can belong to the IgG1, IgG2, IgG3, or IgG4 subclasses.

[0103] An exemplary immunoglobulin (antibody) structural unit is composed of two pairs of polypeptide chains, each pair having one “light” (about 25 kD) and one “heavy” chain (about 50-70 kD). The term “light chain” includes a full-length light chain and fragments thereof having sufficient variable region sequence to confer binding specificity. A full-length light chain includes a variable region domain, VL, and a constant region domain, CL. The variable region domain of the light chain is at the amino-terminus of the polypeptide. Light chains include kappa chains and lambda chains. The term “heavy chain” includes a full-length heavy chain and fragments thereof having sufficient variable region sequence to confer binding specificity. A full-length heavy chain includes a variable region domain, VH, and three constant region domains, CH1, CH2, and CH3. The VH domain is at the amino-terminus of the polypeptide, and the CH domains are at the carboxyl-terminus, with the CH3 being closest to the carboxy-terminus of the polypeptide. Heavy chains can be of any isotype, including IgG (including IgG1, IgG2, IgG3 and IgG4 subclasses), IgA (including IgA1 and IgA2 subclasses), IgM and IgE. The term “variable region” or “variable domain” refers to a portion of the light and/or heavy chains

of an antibody generally responsible for antigen recognition, typically including approximately the amino-terminal 120 to 130 amino acids in the heavy chain (VH) and about 100 to 110 amino terminal amino acids in the light chain (VL). A “complementarity determining region” or “CDR” is an amino acid sequence that contributes to antigen binding specificity and affinity. “Framework” regions (FR) can aid in maintaining the proper conformation of the CDRs to promote binding between the antigen binding region and an antigen. Structurally, framework regions can be located in antibodies between CDRs. The variable regions typically exhibit the same general structure of relatively conserved framework regions (FR) joined by three hyper variable regions, CDRs. The CDRs from the two chains of each pair typically are aligned by the framework regions, which can enable binding to a specific epitope. From N-terminal to C-terminal, both light and heavy chain variable regions typically comprise the domains FR1, CDR1, FR2, CDR2, FR3, CDR3, and FR4. The assignment of amino acids to each domain is typically in accordance with the definitions of Kabat Sequences of Proteins of Immunological Interest (National Institutes of Health, Bethesda, Md. (1987 and 1991)), unless stated otherwise. In certain embodiments, the antigen-binding polypeptide constructs comprise at least one immunoglobulin domain from IgG, IgM, IgA, IgD, or IgE connected to a therapeutic polypeptide. In some embodiments, the immunoglobulin domain comprised in an antigen-binding polypeptide construct provided herein, is from an immunoglobulin-based construct such as a diabody, or a nanobody. In certain embodiments, the antigen-binding polypeptide constructs described herein comprise at least one immunoglobulin domain from a heavy chain antibody such as a camelid antibody. In certain embodiments, the antigen-binding polypeptide constructs provided herein comprise at least one immunoglobulin domain from a mammalian antibody such as a bovine antibody, a human antibody, a camelid antibody (single domain and non-single domain), a rodent antibody, humanized antibody, a non-humanized antibody, a mouse antibody, or any chimeric antibody. In certain embodiments, the antigen-binding polypeptide constructs provided herein comprise at least one immunoglobulin domain from an antibody generated from a synthetic library.

**[0104]** A “bi-specific,” “dual-specific” or “bifunctional” antigen binding protein or antibody is a hybrid antigen binding protein having two different antigen binding sites. Bispecific antigen binding proteins and antibodies are a species of multispecific antigen binding protein antibody. The two binding sites of a bispecific antigen binding protein or antibody will bind to two

different epitopes, which can reside on the same or different molecular targets. A “multispecific antigen binding protein” or “multispecific antibody” is one that targets more than one antigen or epitope. A “bivalent antigen binding protein” or “bivalent antibody” comprises two antigen binding sites. In some instances, the two binding sites have the same antigen specificities. Bivalent antigen binding proteins and bivalent antibodies can be bispecific, see, *infra*. A bivalent antibody other than a “multispecific” or “multifunctional” antibody, in certain embodiments, typically is understood to have each of its binding sites identical.

[0105] The term “preferential pairing” is used herein to describe the pairing pattern of a first polypeptide with a second polypeptide, e.g., an immunoglobulin heavy chain with an immunoglobulin light chain in the antigen-binding polypeptide constructs and heterodimer pairs described herein. As such, “preferential pairing” refers to the preferred pairing of a first polypeptide with a second polypeptide when one or more additional, distinct polypeptides are present at the same time as the pairing occurs between the first and second polypeptide. Typically preferential pairing occurs as a result of the modification (e.g., amino acid modification) of one or both of the first and second polypeptide. Typically preferential pairing results in the paired first and second polypeptide being the most abundant dimer present after pairing occurs. It is known in the art that an immunoglobulin heavy chain (H1) will if co-expressed with two different immunoglobulin light chains (L1 and L2), statistically pair equally with both light chains, resulting in an approximate 50:50 mixture of H1 paired with L1 and H1 paired with L2. In this context, “preferential pairing” would occur between, for example, H1 and L1, if the amount of the H1-L1 heavy chain-light chain heterodimer was greater than the amount of the H1-L2 heterodimer when H1 is co-expressed with both L1 and L2. Thus, in this case, H1 preferentially pairs with L1 relative to L2.

[0106] However, in the context of wild-type bispecific antibodies generated from two starting antibody systems, it is also known in the art that in some cases there is an inherent bias where the light chain of one antibody system preferentially pairs with the heavy chains of both antibody systems. Thus, when determining the strength of a design in the context of a bispecific antigen-binding construct, it may be necessary to assess the degree of pairing with the design compared to the degree of pairing in the wild-type system. Thus, in one embodiment, a design is considered to show preferential pairing if the amount of desired bispecific antibody is greater than the amount of desired bispecific antibody obtained in wild-type systems. In another

embodiment, a design is considered to show preferential pairing if the amount of pairing in the weaker arm of the antibody, is greater than that seen in the wild-type system.

[0107] Antibody heavy chains pair with antibody light chains and meet or contact one another at one or more "interfaces." The "interface" includes one or more "contact" amino acid residues in a first polypeptide that interact with one or more "contact" amino acid residues of a second polypeptide. For example, an interface exists between the CH3 polypeptide sequences of a dimerized CH3 domain, between the CH1 domain of the heavy chain and CL domain of the light chain, and between the VH domain of the heavy chain and the VL domain of the light chain. The "interface" can be derived from an IgG antibody and for example, from a human IgG1 antibody.

[0108] The term "amino acid modifications" as used herein includes, but is not limited to, amino acid mutations, insertions, deletions, substitutions, chemical modifications, physical modifications, and rearrangements.

#### **Antigen binding polypeptide constructs and heterodimer pairs**

[0109] The antigen-binding polypeptide constructs described herein can comprise a first heterodimer and a second heterodimer; each heterodimer obtained by pairing an immunoglobulin heavy chain with an immunoglobulin light chain. The structure and organization of the constant and variable domains of immunoglobulin heavy and light chains are well known in the art. Immunoglobulin heavy chains typically comprise one variable (VH) domain, and three constant domains, CH1, CH2, and CH3. Immunoglobulin light chains typically comprise one variable (VL) domain and one constant (CL) domain. Various modifications to these typical formats can be made.

[0110] The antigen-binding polypeptide constructs and heterodimer pairs described herein can comprise a first heterodimer and a second heterodimer, each heterodimer comprising an immunoglobulin/antibody heavy chain or fragment thereof having at least a VH and CH1 domain, and an immunoglobulin/antibody light chain having a VL domain and a CL domain. In one embodiment, both heterodimers of the heterodimer pair and antigen-binding polypeptide constructs comprise a full-length immunoglobulin heavy chain. In another embodiment, both heterodimers of the heterodimer pair or antigen-binding polypeptide constructs comprise a fragment of the immunoglobulin heavy chain that includes at least a VH and a CH1 domain. In

one embodiment, both heterodimers of the heterodimer pair comprise an amino terminal fragment of the immunoglobulin heavy chain that comprises at least a VH and a CH1 domain. In another embodiment, both heterodimers of the heterodimer pair comprise a carboxy terminal fragment of the immunoglobulin heavy chain that comprises at least a VH and a CH1 domain.

[0111] Each heterodimer of the heterodimer pair can bind specifically to an antigen or epitope. In one embodiment, the immunoglobulin heavy chain and the immunoglobulin light chain of each heterodimer comprises one or more modifications from a known antibody, for example a therapeutic antibody. A therapeutic antibody is one that is effective in treating a disease or disorder in a mammal with or predisposed to the disease or disorder. Suitable therapeutic antibodies from which each heterodimer can be derived include, but are not limited to abagovomab, adalimumab, alemtuzumab, aurograb, bapineuzumab, basiliximab, belimumab, bevacizumab, briakinumab, canakinumab, catumaxomab, certolizumab pegol, cetuximab, daclizumab, denosumab, efalizumab, galiximab, gemtuzumab ozogamicin, golimumab, ibritumomab tiuxetan, infliximab, ipilimumab, lumiliximab, mepolizumab, motavizumab, muromonab, mycograb, natalizumab, nimotuzumab, ocrelizumab, ofatumumab, omalizumab, palivizumab, panitumumab, pertuzumab, ranibizumab, reslizumab, rituximab, teplizumab, tocilizumab/atlizumab, tositumomab, trastuzumab, Proxinium<sup>TM</sup>, Rencarex<sup>TM</sup>, ustekinumab, and zalutumumab.

[0112] In one embodiment, the immunoglobulin heavy chain and/or the immunoglobulin light chain of each heterodimer comprise one or more modifications from an antibody that binds a molecule including, but not limited to, the following list of proteins, as well as subunits, domains, motifs and epitopes belonging to the following list of proteins: renin; a growth hormone, including human growth hormone and bovine growth hormone; growth hormone releasing factor; parathyroid hormone; thyroid stimulating hormone; lipoproteins; alpha-1-antitrypsin; insulin A-chain; insulin B-chain; proinsulin; follicle stimulating hormone; calcitonin; luteinizing hormone; glucagon; clotting factors such as factor VII, factor VIIIc, factor IX, tissue factor (TF), and von Willebrands factor; anti-clotting factors such as Protein C; atrial natriuretic factor; lung surfactant; a plasminogen activator, such as urokinase or human urine or tissue-type plasminogen activator (t-PA); bombesin; thrombin; hemopoietic growth factor; tumor necrosis factor-alpha and -beta; enkephalinase; RANTES (regulated on activation normally T-cell expressed and secreted); human macrophage inflammatory protein (MIP-1-alpha); a serum

albumin such as human serum albumin; Muellierian-inhibiting substance; relaxin A-chain; relaxin B-chain; prorelaxin; mouse gonadotropin-associated peptide; a microbial protein, such as beta-lactamase; DNase; IgE; a cytotoxic T-lymphocyte associated antigen (CTLA), such as CTLA-4; inhibin; activin; vascular endothelial growth factor (VEGF); receptors for hormones or growth factors such as, for example, EGFR, VEGFR; interferons such as alpha interferon (alpha-IFN), beta interferon (beta-IFN) and gamma interferon (gamma-IFN); protein A or D; rheumatoid factors; a neurotrophic factor such as bone-derived neurotrophic factor (BDNF), neurotrophin-3, -4, -5, or -6 (NT-3, NT-4, NT-5, or NT-6), or a nerve growth factor; platelet-derived growth factor (PDGF); fibroblast growth factor such as AFGF and PFGF; epidermal growth factor (EGF); transforming growth factor (TGF) such as TGF-alpha and TGF-beta, including TGF-1, TGF-2, TGF-3, TGF-4, or TGF-5; insulin-like growth factor-I and -II (IGF-I and IGF-II); des (1-3)-IGF-I (brain IGF-I), insulin-like growth factor binding proteins; CD proteins such as CD2, CD3, CD4, CD8, CD11a, CD14, CD18, CD19, CD20, CD22, CD23, CD25, CD33, CD34, CD40, CD40L, CD52, CD63, CD64, CD80 and CD147; erythropoietin; osteoinductive factors; immunotoxins; a bone morphogenetic protein (BMP); an interferon such as interferon-alpha, -beta, and -gamma; colony stimulating factors (CSFs), such as M-CSF, GM-CSF, and G-CSF; interleukins (ILs), e.g., IL-1 to IL-13; TNF-alpha, superoxide dismutase; T-cell receptors; surface membrane proteins; decay accelerating factor; viral antigen such as, for example, a portion of the AIDS envelope, e.g., gp120; transport proteins; homing receptors; addressins; regulatory proteins; cell adhesion molecules such as LFA-1, Mac 1, p150.95, VLA-4, ICAM-1, ICAM-3 and VCAM, alpha4/p7 integrin, and (Xv/p3 integrin including either a or subunits thereof, integrin alpha subunits such as CD49a, CD49b, CD49c, CD49d, CD49e, CD49f, alpha7, alpha8, alpha9, alphaD, CD11a, CD11b, CD51, CD11c, CD41, alphaIIb, alphaIELb; integrin beta subunits such as, CD29, CD 18, CD61, CD104, beta5, beta6, beta7 and beta8; Integrin subunit combinations including but not limited to, alphaVbeta3, alphaVbeta5 and alpha4beta7; a member of an apoptosis pathway; IgE; blood group antigens; flk2/flt3 receptor; obesity (OB) receptor; mp1 receptor; CTLA-4; protein C; an Eph receptor such as EphA2, EphA4, EphB2, etc.; a Human Leukocyte Antigen (HLA) such as HLA-DR; complement proteins such as complement receptor CR1, C1Rq and other complement factors such as C3, and C5; a glycoprotein receptor such as GpIb.alpha., GPIIb/IIIa and CD200; and fragments of any of the above-listed polypeptides.

[0113] In an embodiment, the immunoglobulin heavy and/or light chains of each heterodimer comprise one or more modifications from antibodies that specifically bind cancer antigens including, but not limited to, ALK receptor (pleiotrophin receptor), pleiotrophin, KS 1/4 pan-carcinoma antigen; ovarian carcinoma antigen (CA125); prostatic acid phosphate; prostate specific antigen (PSA); melanoma-associated antigen p97; melanoma antigen gp75; high molecular weight melanoma antigen (HMW-MAA); prostate specific membrane antigen; carcinoembryonic antigen (CEA); polymorphic epithelial mucin antigen; human milk fat globule antigen; colorectal tumor-associated antigens such as: CEA, TAG-72, CO17-1A, GICA 19-9, CTA-1 and LEA; Burkitt's lymphoma antigen-38.13; CD19; human B-lymphoma antigen-CD20; CD33; melanoma specific antigens such as ganglioside GD2, ganglioside GD3, ganglioside GM2 and ganglioside GM3; tumor-specific transplantation type cell-surface antigen (TSTA); virally-induced tumor antigens including T-antigen, DNA tumor viruses and Envelope antigens of RNA tumor viruses; oncofetal antigen-alpha-fetoprotein such as CEA of colon, 514 oncofetal trophoblast glycoprotein and bladder tumor oncofetal antigen; differentiation antigen such as human lung carcinoma antigens L6 and L20; antigens of fibrosarcoma; human leukemia T cell antigen-Gp37; neoglycoprotein; sphingolipids; breast cancer antigens such as EGFR (Epidermal growth factor receptor); NY-BR-16; NY-BR-16 and HER2 antigen (p185HER2); polymorphic epithelial mucin (PEM); malignant human lymphocyte antigen-APO-1; differentiation antigen such as I antigen found in fetal erythrocytes; primary endoderm I antigen found in adult erythrocytes; preimplantation embryos; I(Ma) found in gastric adenocarcinomas; M18, M39 found in breast epithelium; SSEA-1 found in myeloid cells; VEP8; VEP9; Myl; Va4-D5; D156-22 found in colorectal cancer; TRA-1-85 (blood group H); SCP-1 found in testis and ovarian cancer; C14 found in colonic adenocarcinoma; F3 found in lung adenocarcinoma; AH6 found in gastric cancer; Y hapten; Ley found in embryonal carcinoma cells; TL5 (blood group A); EGF receptor found in A431 cells; E1 series (blood group B) found in pancreatic cancer; FC10.2 found in embryonal carcinoma cells; gastric adenocarcinoma antigen; CO-514 (blood group Lea) found in Adenocarcinoma; NS-10 found in adenocarcinomas; CO-43 (blood group Leb); G49 found in EGF receptor of A431 cells; MH2 (blood group ALeb/Ley) found in colonic adenocarcinoma; 19.9 found in colon cancer; gastric cancer mucins; T5A7 found in myeloid cells; R24 found in melanoma; 4.2, GD3, D1.1, OFA-1, GM2, OFA-2, GD2, and M1:22:25:8 found in embryonal carcinoma cells and SSEA-3 and SSEA-4 found in 4 to 8-cell stage

embryos; Cutaneous Tcell Lymphoma antigen; MART-1 antigen; Sialy Tn (STn) antigen; Colon cancer antigen NY-CO-45; Lung cancer antigen NY-LU-12 valiant A; Adenocarcinoma antigen ART1; Paraneoplastic associated brain-testis-cancer antigen (onconeuroal antigen MA2; paraneoplastic neuronal antigen); Neuro-oncological ventral antigen 2 (NOVA2); Hepatocellular carcinoma antigen gene 520; TUMOR-ASSOCIATED ANTIGEN CO-029; Tumor-associated antigens MAGE-C1 (cancer/testis antigen CT7), MAGE-B1 (MAGE-XP antigen), MAGE-B2 (DAM6), MAGE-2, MAGE-4-a, MAGE-4-b and MAGE-X2; Cancer-Testis Antigen (NY-EOS-1) and fragments of any of the above-listed polypeptides.

[0114] Human antibodies can be grouped into isotypes including IgG, IgA, IgE, IgM, and IgD. In one embodiment, an Fc is derived from an IgG isotype. In another embodiment, an Fc is derived from an IgA isotype. In another embodiment, an Fc is derived from an IgE isotype. In another embodiment, an Fc is derived from an IgM isotype. In another embodiment, an Fc is derived from an IgD isotype.

[0115] Human IgG antibodies can also be divided into the subclasses IgG1, IgG2, IgG3, and IgG4. Thus, in some embodiments, it is contemplated an Fc can be derived from an IgG1, IgG2, IgG3, or IgG4 subclass of antibodies.

[0116] Each heterodimer of the heterodimer pair can bind specifically to an epitope or antigen. In one embodiment, each heterodimer of the heterodimer pair binds to the same epitope. In another embodiment, the first heterodimer of the heterodimer pair specifically binds to an epitope on one antigen and the second heterodimer of the heterodimer pair binds specifically to a different epitope on the same antigen. In another embodiment, the first heterodimer of the heterodimer pair specifically binds to an epitope on a first antigen, and the second heterodimer of the heterodimer pair specifically binds to an epitope on a second antigen that is different from the first antigen. For example, in one embodiment, the first heterodimer binds specifically to Tissue Factor, while the second heterodimer binds specifically to antigen Her2(ErbB2), or vice-versa. In an alternative embodiment, the first heterodimer binds specifically to Tissue Factor, while the second heterodimer binds specifically to EGFR, or vice-versa. In yet another embodiment, the first heterodimer binds specifically to EGFR, while the second heterodimer binds specifically to antigen Her2, or vice-versa. In another embodiment, the first heterodimer binds specifically to a molecule or cancer antigen described above. In another embodiment, the second heterodimer binds specifically to a molecule or cancer antigen described above.



[0117] As indicated above, in some embodiments, the immunoglobulin heavy chain and the immunoglobulin light chain of each heterodimer comprises one or more modifications from a known therapeutic antibody, or from an antibody that binds various target molecules or cancer antigens. The amino acid and nucleotide sequences of numerous such molecules are readily available (see for example, GenBank: AJ308087.1 (Humanized anti-human tissue factor antibody D3H44 light chain variable region and CL domain); GenBank: AJ308086.1 (humanized anti-human tissue factor antibody D3H44 heavy chain variable region and CH1 domain); GenBank: HC359025.1 (Pertuzumab Fab light chain gene module); GenBank: HC359024.1 (Pertuzumab Fab heavy chain gene module); GenBank: GM685465.1 (Antibody Trastuzumab (= Herceptin) - wildtype; light chain); GenBank: GM685463.1 (Antibody Trastuzumab (= Herceptin) - wildtype; heavy chain); GenBank: GM685466.1 (Antibody Trastuzumab (= Herceptin) - GC-optimized light chain); and GenBank: GM685464.1 (Antibody Trastuzumab (= Herceptin) - GC-optimized heavy chain). The sequences of each of the GenBank numbers described herein are available from the NCBI website as of November 28, 2012 and are each incorporated by reference in its entirety for all purposes. Amino acid and nucleotide sequences for cetuximab are also known in the art, see for example the Drug Bank website supported by Canadian Institutes of Health Research, Alberta Innovates - Health Solutions, and by The Metabolomics Innovation Centre (TMIC), Accession No. DB00002.

[0118] In some aspects, an isolated antigen-binding polypeptide construct comprises an amino acid sequence that is at least 80, 85, 90, 91, 92, 93, 94, 95, 96, 97, 98, 99, or 100% identical to an amino acid sequence or fragment thereof set forth in the Tables or accession numbers disclosed herein. In some aspects, an isolated antigen-binding polypeptide construct comprises an amino acid sequence encoded by a polynucleotide that is at least 80, 85, 90, 91, 92, 93, 94, 95, 96, 97, 98, 99, or 100% identical to a nucleotide sequence or fragment thereof set forth in the Tables or accession numbers disclosed herein.

*Amino acid modifications to immunoglobulin heavy and light chains*

[0119] At least one of the heterodimers of a heterodimer pair can comprise one or more amino acid modifications to their immunoglobulin heavy and/or immunoglobulin light chains such that the heavy chain of the first heterodimer preferentially pairs with one of the light chains rather than the other. Likewise, the heavy chain of the second heterodimer can preferentially

pair with the second light chain rather than the first. This preferential pairing of one heavy chain with one of two light chains can be based on design sets comprising one immunoglobulin heavy chain and two immunoglobulin light chains (referred to as an LCCA design set) where the immunoglobulin heavy chain preferentially pairs with one of the two immunoglobulin light chains over the other when the immunoglobulin heavy chain is co-expressed with both immunoglobulin light chains. Thus, a LCCA design set can comprise one immunoglobulin heavy chain, a first immunoglobulin light chain and a second immunoglobulin light chain.

[0120] In one embodiment, the one or more amino acid modifications comprise one or more amino acid substitutions.

[0121] In one embodiment, the preferential pairing demonstrated in the LCCA design set is established by modifying one or more amino acids that are part of the interface between the light chain and heavy chain. In one embodiment, the preferential pairing demonstrated in the LCCA design set is established by modifying one or more amino acids in at least one of the CH1 domain of the immunoglobulin heavy chain, the CL domain of a first immunoglobulin light chain and the CL domain of the second immunoglobulin light chain.

[0122] In one embodiment the one or amino acid modifications are limited to the conserved framework residues of the variable (VH, VL) and constant (CH1, CL) domains as indicated by the Kabat numbering of residues. For example, Almagro [Frontiers In Bioscience (2008) 13: 1619-1633] provides a definition of the framework residues on the basis of Kabat, Chotia, and IMGT numbering schemes.

[0123] In one embodiment, at least one of the heterodimers comprises one or more mutations introduced in the immunoglobulin heavy and immunoglobulin light chains that are complementary to each other. Complementarity at the heavy and light chain interface can be achieved on the basis of steric and hydrophobic contacts, electrostatic/charge interactions or a combination of the variety of interactions. The complementarity between protein surfaces is broadly described in the literature in terms of lock and key fit, knob into hole, protrusion and cavity, donor and acceptor etc., all implying the nature of structural and chemical match between the two interacting surfaces. In one embodiment, at least one of the heterodimers comprises one or more mutations where the mutations introduced in the immunoglobulin heavy and immunoglobulin light chains introduce a new hydrogen bond across the light and heavy chain at the interface. In one embodiment, at least one of the heterodimers comprises one or more

mutations where the mutations introduced in the immunoglobulin heavy and immunoglobulin light chains introduce a new salt bridge across the light and heavy chain at the interface.

[0124] Non-limiting examples of suitable LCCA design sets are described in the Examples, Tables, and Figures. In one embodiment, the LCCA design set comprises an immunoglobulin heavy chain with at least one amino acid modification in the CH1 domain, a first immunoglobulin light chain with at least one amino acid modification in the CL domain, and a second immunoglobulin light chain without any amino acid modifications in the CL domain. In another embodiment, the LCCA design set comprises an immunoglobulin heavy chain with at least one amino acid modification in the CH1 domain, a first immunoglobulin light chain with at least one amino acid modification in the CL domain, and a second immunoglobulin light chain with at least one amino acid modification in the CL domain. In another embodiment, the LCCA design set comprises an immunoglobulin heavy chain with at least one amino acid modification in the CH1 domain, a first immunoglobulin light chain with at least two amino acid modifications in the CL domain, and a second immunoglobulin light chain with at least two amino acid modifications in the CL domain. In another embodiment, the LCCA design set comprises an immunoglobulin heavy chain with at least one amino acid modification in the CH1 domain, a first immunoglobulin light chain with at least two amino acid modifications in the CL domain, and a second immunoglobulin light chain with at least one amino acid modification in the CL domain.

[0125] In one embodiment, the LCCA design set comprises an immunoglobulin heavy chain with no amino acid modifications in the CH1 domain, a first immunoglobulin light chain with no amino acid modifications in the CL domain, and a second immunoglobulin light chain with at least one amino acid modification in the CL domain. In one embodiment, the LCCA design set comprises an immunoglobulin heavy chain with no amino acid modifications in the CH1 domain, a first immunoglobulin light chain with no amino acid modifications in the CL domain, and a second immunoglobulin light chain with at least two amino acid modifications in the CL domain.

[0126] In one embodiment, the LCCA design set comprises an immunoglobulin heavy chain with at least two amino acid modifications in the CH1 domain, a first immunoglobulin light chain with no amino acid modifications in the CL domain, and a second immunoglobulin light chain with at least one amino acid modification in the CL domain. In one embodiment, the

LCCA design set comprises an immunoglobulin heavy chain with at least two amino acid modifications in the CH1 domain, a first immunoglobulin light chain with at least one amino acid modifications in the CL domain, and a second immunoglobulin light chain with at least one amino acid modification in the CL domain. In one embodiment, the LCCA design set comprises an immunoglobulin heavy chain with at least two amino acid modifications in the CH1 domain, a first immunoglobulin light chain with at least one amino acid modification in the CL domain, and a second immunoglobulin light chain with at least two amino acid modifications in the CL domain. In one embodiment, the LCCA design set comprises an immunoglobulin heavy chain with at least two amino acid modifications in the CH1 domain, a first immunoglobulin light chain with at least two amino acid modifications in the CL domain, and a second immunoglobulin light chain with at least two amino acid modifications in the CL domain. In one embodiment, the LCCA design set comprises an immunoglobulin heavy chain with at least two amino acid modifications in the CH1 domain, a first immunoglobulin light chain with at least three amino acid modifications in the CL domain, and a second immunoglobulin light chain with at least two amino acid modifications in the CL domain.

[0127] In one embodiment, the LCCA design set comprises an immunoglobulin heavy chain with at least three amino acid modifications in the CH1 domain, a first immunoglobulin light chain with no amino acid modifications in the CL domain, and a second immunoglobulin light chain with at least one amino acid modifications in the CL domain. In one embodiment, the LCCA design set comprises an immunoglobulin heavy chain with at least three amino acid modifications in the CH1 domain, a first immunoglobulin light chain with at least one amino acid modification in the CL domain, and a second immunoglobulin light chain with at least one amino acid modification in the CL domain. In one embodiment, the LCCA design set comprises an immunoglobulin heavy chain with at least three amino acid modifications in the CH1 domain, a first immunoglobulin light chain with at least three amino acid modifications in the CL domain, and a second immunoglobulin light chain with at least two amino acid modifications in the CL domain. In one embodiment, the LCCA design set comprises an immunoglobulin heavy chain with at least three amino acid modifications in the CH1 domain, a first immunoglobulin light chain with at least four amino acid modifications in the CL domain, and a second immunoglobulin light chain with at least three amino acid modifications in the CL domain.

In one embodiment, the preferential pairing demonstrated in the LCCA design set is established by modifying one or more amino acids in at least one of the VH domain of the immunoglobulin heavy chain, the VL domain of a first immunoglobulin light chain and the VL domain of the second immunoglobulin light chain. Non-limiting examples of suitable LCCA design sets are shown in Tables and Examples below.

[0128] In one embodiment, the LCCA design set comprises an immunoglobulin heavy chain with no amino acid modifications in the VH domain, a first immunoglobulin light chain with no amino acid modifications in the VL domain, and a second immunoglobulin light chain with at least one amino acid modification in the VL domain. In one embodiment, the LCCA design set comprises an immunoglobulin heavy chain with no amino acid modifications in the VH domain, a first immunoglobulin light chain with no amino acid modifications in the VL domain, and a second immunoglobulin light chain with at least two amino acid modifications in the VL domain.

[0129] In one embodiment, the LCCA design set comprises an immunoglobulin heavy chain with at least one amino acid modification in the VH domain, a first immunoglobulin light chain with no amino acid modifications in the VL domain, and a second immunoglobulin light chain with at least one amino acid modification in the VL domain. In one embodiment, the LCCA design set comprises an immunoglobulin heavy chain with at least one amino acid modification in the VH domain, a first immunoglobulin light chain with at least one amino acid modification in the VL domain, and a second immunoglobulin light chain with at least one amino acid modification in the VL domain. In one embodiment, the LCCA design set comprises an immunoglobulin heavy chain with at least one amino acid modification in the VH domain, a first immunoglobulin light chain with at least two amino acid modifications in the VL domain, and a second immunoglobulin light chain with at least two amino acid modifications in the VL domain.

[0130] In one embodiment, the LCCA design set comprises an immunoglobulin heavy chain with at least two amino acid modifications in the VH domain, a first immunoglobulin light chain with no amino acid modifications in the VL domain, and a second immunoglobulin light chain with at least one amino acid modification in the VL domain. In one embodiment, the LCCA design set comprises an immunoglobulin heavy chain with at least two amino acid modifications in the VH domain, a first immunoglobulin light chain with at least two amino acid modifications

in the VL domain, and a second immunoglobulin light chain with at least one amino acid modification in the VL domain. In one embodiment, the LCCA design set comprises an immunoglobulin heavy chain with at least two amino acid modifications in the VH domain, a first immunoglobulin light chain with at least one amino acid modification in the VL domain, and a second immunoglobulin light chain with at least one amino acid modification in the VL domain.

[0131] In one embodiment, the LCCA design sets can be combined to provide a combination comprising two distinct immunoglobulin heavy chains (H1 and H2) and two distinct immunoglobulin light chains (L1 and L2), where H1 preferentially pairs with L1 and H2 preferentially pairs with L2 when H1, H2, L1, and L2 are co-expressed.

In some embodiments, the amino acid modifications described herein are in the context of a bi-specific antibody construct. For example, the design sets described herein can be incorporated into full length immunoglobulin heavy chains such that the full length heavy chains preferentially pair with the immunoglobulin light chains. In some embodiments, the full length immunoglobulin heavy chains contain amino acid modifications that promote dimerization in the Fc region, as described in the Examples.

*Transferability of specific amino acid modifications identified herein to other antibodies:*

[0132] Although the specific amino acid modifications to immunoglobulin heavy and light chains identified above have been described with respect to the D3H44 anti-tissue factor extracellular domain antibody, Trastuzumab, and Cetuximab immunoglobulin heavy and light chains, it is contemplated and demonstrated herein (see Examples, Figures, and Tables) that these amino acid modifications are transferable to other immunoglobulin heavy and light chains, resulting in similar patterns of preferential pairing of one immunoglobulin heavy chain with one of the two immunoglobulin light chains in view of the following.

[0133] The VH:VL and CH1:CL interface residues in the interface between immunoglobulin heavy and light chains are relatively well conserved (Padlan et al., 1986, Mol. Immunol. 23(9): 951-960). This sequence conservation, a result of evolutionary constraints, increases the likelihood that functionally active antibody binding domains will be formed during combinatorial pairing of light and heavy chains. As a result of this sequence conservation, it

follows that sequence modifications in the specific examples noted above for D3H44, which drive preferential pairing, could transfer to other heavy and light chain pair heterodimers with approximately equivalent results being obtained with respect to preferential pairing, since this region displays high sequence conservation across antibodies; Further, when sequence differences do occur, these usually lie distal to the CH1:CL interface. This is particularly the case for the CH1 and CL domains. There is, however, some sequence variability at the antigen-binding site with respect to CDR (complementarity-determining regions) loop residues (and length), particularly for CDR-H3. Thus, in one embodiment, the heterodimer pairs described herein comprise heterodimers where at least one heterodimer comprises one or more amino acid modifications in the VH and/or VL domains that lie distal to the CDR loops when the amino acid sequence of the antigen-binding site is significantly different from that of the D3H44 antibody. In another embodiment, the heterodimer pairs described herein comprise heterodimers where at least one heterodimer comprises one or more amino acid modifications in the VH and/or VL domains that lie proximal or distal to the CDR loops, when the amino acid sequence of the antigen-binding site is substantially the same as that of the D3H44 antibody.

[0134] In one embodiment, the amino acid modifications described herein are transferable to the immunoglobulin heavy and light chains of antibodies based on human or humanized IgG1/ $\kappa$ . Non-limiting examples of such IgG1/ $\kappa$  chains include Ofatumumab (for human) or Trastuzumab, Pertuzumab or Bevacizumab (for humanized).

[0135] In another embodiment, the amino acid modifications described herein are transferable to the immunoglobulin heavy and light chains of antibodies utilizing commonly used VH and VL subgroups. Non-limiting examples of such antibodies include Pertuzumab.

[0136] In one embodiment, the amino acid modifications described herein are transferable to the immunoglobulin heavy and light chains of antibodies having a framework close to germline. Examples of such antibodies include Obinutuzumab.

[0137] In one embodiment, the amino acid modifications described herein are transferable to the immunoglobulin heavy and light chains of antibodies having a VH:VL interdomain angle close to the average observed for heavy and light chain pairs. An example of this type of antibody includes, but is not limited to Pertuzumab. In another embodiment, the amino acid modifications described herein are transferable to the immunoglobulin heavy and light chains of

antibodies having canonical CL and CH1 domains. Suitable examples of such antibodies include, but are not limited to Trastuzumab.

[0138] In some embodiments, certain subsets of the amino acid modifications described herein are utilized in variant domains in antigen binding constructs provided above.

[0139] The Examples, Figures, and Tables demonstrate that amino acid modifications (e.g., within one or more Fab fragments comprising a variable region and a constant region) are transferable to other immunoglobulin heavy and light chains, resulting in similar patterns of preferential pairing of one immunoglobulin heavy chain with one of the two immunoglobulin light chains.

### *Preferential Pairing*

[0140] As described above, at least one heterodimer of the antigen binding construct/heterodimer pairs described herein can comprise one or more amino acid modifications to their immunoglobulin heavy and/or immunoglobulin light chains such that the heavy chain of the one heterodimer, for example H1, preferentially pairs with one of the light chains, for example L1, rather than the other light chain, L2, and the heavy chain of the other heterodimer, H2, preferentially pairs with the light chain, L2, rather than the light chain L1. In other words, the desired, preferential pairing is considered to be between H1 and L1, and between H2 and L2. Preferential pairing between, for example, H1 and L1 is considered to occur if the yield of the H1-L1 heterodimer is greater than the yield of the mispaired H1-L2 heterodimer when H1 is combined with L1 and L2, relative to the respective pairing of corresponding H1/L1 pair to H2/L2 pair without the one or more amino acid modifications. Likewise, preferential pairing between H2 and L2 is considered to occur if the yield of the H2-L2 heterodimer is greater than the yield of the mispaired H2-L1 heterodimer when H2 is combined with L1 and L2, relative to the respective pairing of corresponding H1-L1 pair to H2-L2 pair without the one or more amino acid modifications. In this context, an heterodimer comprising H1 and L1 (H1-L1), or H2 and L2 (H2-L2), is referred to herein as a preferentially paired, correctly paired, obligate pair, or desired heterodimer, while a heterodimer comprising H1 and L2 (H1-L2), or H2 and L1 (H2-L1), is referred to herein as a mispaired heterodimer. The set of mutations corresponding to the two heavy chains and the two light chains meant to achieve selective pairing of H1-L1 and H2-L2 is referred to as a design set.



[0141] Thus, in one embodiment, when one immunoglobulin heavy chain of a heterodimer is co-expressed with two immunoglobulin light chains, the relative yield of the desired heterodimer is greater than 55%. In another embodiment, when one immunoglobulin heavy chain of a heterodimer is co-expressed with two immunoglobulin light chains, the relative yield of the desired heterodimer is greater than 60%. In another embodiment, when one immunoglobulin heavy chain of a heterodimer is co-expressed with two immunoglobulin light chains, the relative yield of the desired heterodimer is greater than 70%. In another embodiment, when one immunoglobulin heavy chain of a heterodimer is co-expressed with two immunoglobulin light chains, the relative yield of the desired heterodimer is greater than 80%. In another embodiment, when one immunoglobulin heavy chain of a heterodimer is co-expressed with two immunoglobulin light chains, the relative yield of the desired heterodimer is greater than 90%. In another embodiment, when one immunoglobulin heavy chain of a heterodimer is co-expressed with two immunoglobulin light chains, the relative yield of the desired heterodimer is greater than 95%.

[0142] In the above example, preferential pairing between H1-L1 is considered to occur if the amount of the desired H1-L1 heterodimer is greater than the amount of the mispaired H1-L2 heterodimer when H1 is co-expressed with L1 and L2. Similarly, preferential pairing between H2-L2 is considered to occur if the amount of the desired H2-L2 heterodimer is greater than the amount of the mispaired H2-L1 heterodimer when H2 is co-expressed with L1 and L2. Thus, in one embodiment, when one immunoglobulin heavy chain of a heterodimer is co-expressed with two immunoglobulin light chains, the ratio of the desired heterodimer to the mispaired heterodimer is greater than 1.25:1. In one embodiment, when one immunoglobulin heavy chain of a heterodimer is co-expressed with two immunoglobulin light chains, the ratio of the desired heterodimer to the mispaired heterodimer is greater than 1.5:1. In another embodiment, when one immunoglobulin heavy chain of a heterodimer is co-expressed with two immunoglobulin light chains, the ratio of the desired heterodimer to the mispaired heterodimer is greater than 2:1. In another embodiment, when one immunoglobulin heavy chain of a heterodimer is co-expressed with two immunoglobulin light chains, the ratio of the desired heterodimer to the mispaired heterodimer is greater than 3:1. In another embodiment, when one immunoglobulin heavy chain of a heterodimer is co-expressed with two immunoglobulin light chains, the ratio of the desired heterodimer to the mispaired heterodimer is greater than 5:1. In another embodiment, when one

immunoglobulin heavy chain of a heterodimer is co-expressed with two immunoglobulin light chains, the ratio of the desired heterodimer to the mispaired heterodimer is greater than 10:1. In another embodiment, when one immunoglobulin heavy chain of a heterodimer is co-expressed with two immunoglobulin light chains, the ratio of the desired heterodimer to the mispaired heterodimer is greater than 25:1. In another embodiment, when one immunoglobulin heavy chain of a heterodimer is co-expressed with two immunoglobulin light chains, the ratio of the desired heterodimer to the mispaired heterodimer is greater than 50:1.

[0143] In some embodiments, the heterodimers described herein preferentially pair to form a bi-specific antibody. In some embodiments, the construct comprises a heterodimer that preferentially pairs to form a bi-specific antibody selected from D3H44/trastuzumab, D3H44/cetuximab, and trastuzumab/cetuximab. In some embodiments, the bi-specific antibodies comprise the amino acid modifications described in Tables 28a-28c.

[0144] In some embodiments, two full-length heavy chain constructs are co-expressed with two unique light chain constructs, yielding ten possible antibody species: H1-L1:H1-L1, H1-L2:H1-L2, H1-L1:H1-L2, H2-L1:H2-L1, H2-L2:H2-L2, H2-L1:H2-L2, H1-L1:H2-L1, H1-L2:H2-L2, H1-L2:H2-L1 and H1-L1:H2-L2. The H1-L1:H2-L2 species is considered the correctly paired bispecific antibody species. In some embodiments, the DNA ratios are selected to yield the greatest amount of the correctly paired bispecific antibody species. For example, in some embodiments, the ratio of H1:H2:L1:L2 is 15:15:53:17. In some embodiments, the ratio of H1:H2:L1:L2 is 15:15:17:53.

[0145] In some embodiments, the percentage of the correctly paired bispecific species is at least 40%, 45%, 50%, 55%, 60%, 65%, 70%, 75%, 80%, 85%, 90%, 91%, 92%, 93%, 94%, 95%, 96%, 97%, 98%, 99%, or 100% relative to all species (see, e.g., Tables 29a-29c and 30a-30c). In some embodiments, the percentage of correctly paired bispecific species is greater than the percentage of correctly paired bispecific species obtained by co-expressing a corresponding wild-type H1, H2, L1 and L2 without the amino acid modifications described in Tables 28a-28c. In some embodiments, the percentage of correctly paired bispecific species is increased by at least 5%, 10%, 15%, 20%, 30%, 40%, 50%, 60%, 70%, or 75% compared to the percentage of correctly paired bispecific species obtained by co-expressing wild-type H1, H2, L1 and L2 without the amino acid modifications described in Tables 28a-28c.

*Thermal Stability of Heterodimers*

[0146] In addition to promoting preferential pairing, the amino acid substitutions were selected such that the mutations would not destabilize the Fab heterodimers. Thus, in most cases, the stability measurements of the Fab heterodimers were very close to that of the wild-type Fab (e.g., within 3°C of the wild-type Fab).

[0147] Thus, in some embodiments, each heterodimer of the heterodimer pair described herein has a thermal stability that is comparable to that of a heterodimer comprising the same immunoglobulin heavy and light chains but without the amino acid modifications to the CH1, CL, VH, or VL domains described herein. In one embodiment, thermal stability is determined by measurement of melting temperature, or  $T_m$ . Thus, in one embodiment, the thermal stability of a heterodimer described herein is within about 10°C of that of a heterodimer comprising the same immunoglobulin heavy and light chains without the amino acid modifications to the CH1, CL, VH, or VL domains described herein. Thus, in one embodiment, the thermal stability of a heterodimer described herein is within about 5°C of that of a heterodimer comprising the same immunoglobulin heavy and light chains without the amino acid modifications to the CH1, CL, VH, or VL domains described herein. In another embodiment, the thermal stability of a heterodimer described herein is within about 3°C of that of a heterodimer comprising the same immunoglobulin heavy and light chains without the amino acid modifications to the CH1, CL, VH, or VL domains described herein. In another embodiment, the thermal stability of a heterodimer described herein is within about 2°C of that of a heterodimer comprising the same immunoglobulin heavy and light chains without the amino acid modifications to the CH1, CL, VH, or VL domains described herein. In another embodiment, the thermal stability of a heterodimer described herein is within about 1.5°C of that of a heterodimer comprising the same immunoglobulin heavy and light chains without the amino acid modifications to the CH1, CL, VH, or VL domains described herein. In another embodiment, the thermal stability of a heterodimer described herein is within about 1°C of that of a heterodimer comprising the same immunoglobulin heavy and light chains without the amino acid modifications to the CH1, CL, VH, or VL domains described herein. In another embodiment, the thermal stability of a heterodimer described herein is within about 0.5°C of that of a heterodimer comprising the same immunoglobulin heavy and light chains without the amino acid modifications to the CH1, CL,

VH, or VL domains described herein. In another embodiment, the thermal stability of a heterodimer described herein is within about 0.25°C of that of a heterodimer comprising the same immunoglobulin heavy and light chains without the amino acid modifications to the CH1, CL, VH, or VL domains described herein.

[0148] Furthermore, in some embodiments, the thermal stability of a heterodimer described herein is surprisingly improved (i.e., increased) relative to that of a heterodimer comprising the same immunoglobulin heavy and light chains without the amino acid modifications to the CH1, CL, VH, or VL domains described herein. Thus, in one embodiment, the thermal stability of a heterodimer described herein is increased by about 0.1, 0.2, 0.3, 0.4, 0.5, 0.6, 0.7, 0.8, 0.9, 1.0, 1.1, 1.2, 1.3, 1.4, 1.5, 1.6, 1.7, 1.8, 1.9, 2.0, 2.1, 2.2, 2.3, 2.4, 2.5, 3.0, 3.1, 3.2, 3.3, 3.4, 3.5, 3.6, 3.7, 3.8, 3.9, 4.0, 4.5, 5.0 °C or more compared to a heterodimer comprising the same immunoglobulin heavy and light chains without the amino acid modifications to the CH1, CL, VH, or VL domains described herein.

#### *Affinity of heterodimers for antigen*

[0149] In one embodiment, each heterodimer of the heterodimer pair has an affinity for its respective antigen that is the same or comparable to that of a heterodimer comprising the same immunoglobulin heavy and light chains but without the amino acid modifications to the CH1, CL, VH, or VL domains described herein. In one embodiment, a heterodimer of the heterodimer pair has an affinity for its respective antigen that is within about 50 fold of that of a heterodimer comprising the same immunoglobulin heavy and light chains without the amino acid modifications to the CH1, CL, VH, or VL domains described herein. In one embodiment, a heterodimer of the heterodimer pair has an affinity for its respective antigen that is within about 25 fold of that of a heterodimer comprising the same immunoglobulin heavy and light chains without the amino acid modifications to the CH1, CL, VH, or VL domains described herein. In one embodiment, a heterodimer of the heterodimer pair has an affinity for its respective antigen that is within about 10 fold of that of a heterodimer comprising the same immunoglobulin heavy and light chains without the amino acid modifications to the CH1, CL, VH, or VL domains described herein. In another embodiment, a heterodimer of the heterodimer pair has an affinity for its respective antigen that is within about 5 fold of that of a heterodimer comprising the same immunoglobulin heavy and light chains without the amino acid modifications to the CH1, CL,

VH, or VL domains described herein. In another embodiment, a heterodimer of the heterodimer pair has an affinity for its respective antigen that is within about 2.5 fold of that of a heterodimer comprising the same immunoglobulin heavy and light chains without the amino acid modifications to the CH1, CL, VH, or VL domains described herein. In another embodiment, a heterodimer of the heterodimer pair has an affinity for its respective antigen that is within about 2 fold of that of a heterodimer comprising the same immunoglobulin heavy and light chains without the amino acid modifications to the CH1, CL, VH, or VL domains described herein. In another embodiment, a heterodimer of the heterodimer pair has an affinity for its respective antigen that is within about 1.5 fold of that of a heterodimer comprising the same immunoglobulin heavy and light chains without the amino acid modifications to the CH1, CL, VH, or VL domains described herein. In another embodiment, a heterodimer of the heterodimer pair has an affinity for its respective antigen that is about the same as that of a heterodimer comprising the same immunoglobulin heavy and light chains without the amino acid modifications to the CH1, CL, VH, or VL domains described herein.

*Additional optional modifications*

[0150] In one embodiment, the immunoglobulin heavy and light chains of the heterodimer pairs described herein can be further modified (i.e., by the covalent attachment of various types of molecules) such that covalent attachment does not interfere with the preferential pairing between heavy chain and light chains or affect the ability of the heterodimer to bind to its antigen, or affect its stability. Such modification include, for example, but not by way of limitation, glycosylation, acetylation, pegylation, phosphorylation, amidation, derivatization by known protecting/blocking groups, proteolytic cleavage, linkage to a cellular ligand or other protein, etc. Any of numerous chemical modifications can be carried out by known techniques, including, but not limited to, specific chemical cleavage, acetylation, formylation, metabolic synthesis of tunicamycin, etc.

[0151] In another embodiment, the immunoglobulin heavy and light chains of the heterodimer pairs described herein can be conjugated (directly or indirectly) to a therapeutic agent or drug moiety that modifies a given biological response. Therapeutic agents or drug moieties are not to be construed as limited to classical chemical therapeutic agents. For example, the drug moiety can be a protein or polypeptide possessing a desired biological activity. Such

proteins can include, for example, a toxin such as abrin, ricin A, Onconase (or another cytotoxic RNase), pseudomonas exotoxin, cholera toxin, or diphtheria toxin; a protein such as tumor necrosis factor, alpha-interferon, beta-interferon, nerve growth factor, platelet derived growth factor, tissue plasminogen activator, an apoptotic agent, e.g., TNF-alpha, TNF-beta, AIM I (see, International Publication No. WO 97/33899), AIM II (see, International Publication No. WO 97/34911), Fas Ligand (Takahashi et al., 1994, J. Immunol., 6:1567), and VEGI (see, International Publication No. WO 99/23105), a thrombotic agent or an anti-angiogenic agent, e.g., angiostatin or endostatin; or, a biological response modifier such as, for example, a lymphokine (e.g., interleukin-1 ("IL-1"), interleukin-2 ("IL-2"), interleukin-6 ("IL-6"), granulocyte macrophage colony stimulating factor ("GM-CSF"), and granulocyte colony stimulating factor ("G-CSF")), or a growth factor (e.g., growth hormone ("GH")).

**[0152]** Moreover, in an alternate embodiment, an antibody can be conjugated to therapeutic moieties such as a radioactive materials or macrocyclic chelators useful for conjugating radiometal ions (see above for examples of radioactive materials). In certain embodiments, the macrocyclic chelator is 1,4,7,10-tetraazacyclododecane-N,N',N'',N'''-tetraacetic acid (DOTA) which can be attached to the antibody via a linker molecule. Such linker molecules are commonly known in the art and described in Denardo et al., 1998, Clin Cancer Res. 4:2483; Peterson et al., 1999, Bioconjug. Chem. 10:553; and Zimmerman et al., 1999, Nucl. Med. Biol. 26:943.

**[0153]** In some embodiments, the immunoglobulin heavy and light chains of the heterodimer are expressed as fusion proteins comprising a tag to facilitate purification and/or testing etc. As referred to herein, a "tag" is any added series of amino acids which are provided in a protein at either the C-terminus, the N-terminus, or internally that contributes to the identification or purification of the protein. Suitable tags include but are not limited to tags known to those skilled in the art to be useful in purification and/or testing such as albumin binding domain (ABD), His tag, FLAG tag, glutathione-s-transferase, haemagglutinin (HA) and maltose binding protein. Such tagged proteins can also be engineered to comprise a cleavage site, such as a thrombin, enterokinase or factor X cleavage site, for ease of removal, of the tag before, during or after purification.

**[0154]** In some embodiments, one or more of the cysteine residues at the bottom of the Fab domain in the light (position 214, Kabat numbering) and heavy (position 233, Kabat numbering)

chain that form an interchain disulphide bond can be modified to serine or alanine or a non-cysteine or a distinct amino acid.

[0155] It is contemplated that additional amino acid modifications can be made to the immunoglobulin heavy chains in order to increase the level of preferential pairing, and/or the thermal stability of the heterodimer pairs. For example, additional amino acid modifications can be made to the immunoglobulin heavy chain Fc domain in order to drive preferential pairing between heterodimer pairs relative to homodimer pairs. Such amino acid modifications are known in the art and include, for example, those described, in US Patent Publication No. 2012/0149876. Alternatively, alternate strategies for driving preferential pairing between heterodimer pairs relative to homodimer pairs such as, for example, “knobs into holes”, charged residues with ionic interactions, and strand-exchange engineered domain (SEED) technologies can also be employed. The latter strategies have been described in the art and are reviewed in Klein *et al*, *supra*. Further discussion of Fc domains follows below.

#### **Fc domains**

[0156] In embodiments where the antigen-binding polypeptide construct comprises full-length immunoglobulin heavy chains, the construct will comprise an Fc. In some aspects, the Fc comprises at least one or two CH<sub>3</sub> domain sequences. In some aspects, where the antigen-binding polypeptide construct comprises heterodimers that comprise only the Fab region of the heavy chain, the Fc is coupled, with or without one or more linkers, to a first heterodimer and/or a second heterodimer. In some aspects, the Fc is a human Fc. In some aspects, the Fc is a human IgG or IgG1 Fc. In some aspects, the Fc is a heterodimeric Fc. In some aspects, the Fc comprises at least one or two CH<sub>2</sub> domain sequences.

[0157] In some aspects, the Fc comprises one or more modifications in at least one of the CH<sub>3</sub> domain sequences. In some aspects, the Fc comprises one or more modifications in at least one of the CH<sub>2</sub> domain sequences. In some aspects, an Fc is a single polypeptide. In some aspects, an Fc is multiple peptides, e.g., two polypeptides.

[0158] In some aspects, the Fc comprises one or more modifications in at least one of the CH<sub>3</sub> sequences. In some aspects, the Fc comprises one or more modifications in at least one of the CH<sub>2</sub> sequences. In some aspects, an Fc is a single polypeptide. In some aspects, an Fc is multiple peptides, e.g., two polypeptides.

[0159] In some aspects, Fc is an Fc described in patent applications PCT/CA2011/001238, filed November 4, 2011 or PCT/CA2012/050780, filed November 2, 2012, the entire disclosure of each of which is hereby incorporated by reference in its entirety for all purposes.

[0160] In some aspects, a construct described herein comprises a heterodimeric Fc comprising a modified CH3 domain that has been asymmetrically modified. The heterodimeric Fc can comprise two heavy chain constant domain polypeptides: a first heavy chain polypeptide and a second heavy chain polypeptide, which can be used interchangeably provided that Fc comprises one first heavy chain polypeptide and one second heavy chain polypeptide. Generally, the first heavy chain polypeptide comprises a first CH3 sequence and the second heavy chain polypeptide comprises a second CH3 sequence.

[0161] Two CH3 sequences that comprise one or more amino acid modifications introduced in an asymmetric fashion generally results in a heterodimeric Fc, rather than a homodimer, when the two CH3 sequences dimerize. As used herein, "asymmetric amino acid modifications" refers to any modification where an amino acid at a specific position on a first CH3 sequence is different from the amino acid on a second CH3 sequence at the same position, and the first and second CH3 sequence preferentially pair to form a heterodimer, rather than a homodimer. This heterodimerization can be a result of modification of only one of the two amino acids at the same respective amino acid position on each sequence; or modification of both amino acids on each sequence at the same respective position on each of the first and second CH3 sequences. The first and second CH3 sequence of a heterodimeric Fc can comprise one or more than one asymmetric amino acid modification.

Table X provides the amino acid sequence of the human IgG1 Fc sequence, corresponding to amino acids 231 to 447 of the full-length human IgG1 heavy chain. The CH3 sequence comprises amino acid 341-447 of the full-length human IgG1 heavy chain.

[0162] Typically an Fc can include two contiguous heavy chain sequences (A and B) that are capable of dimerizing. In some aspects, one or both sequences of an Fc include one or more mutations or modifications at the following locations: L351, F405, Y407, T366, K392, T394, T350, S400, and/or N390, using EU numbering. In some aspects, an Fc includes a mutant sequence shown in Table X. In some aspects, an Fc includes the mutations of Variant 1 A-B. In some aspects, an Fc includes the mutations of Variant 2 A-B. In some aspects, an Fc includes



the mutations of Variant 3 A-B. In some aspects, an Fc includes the mutations of Variant 4 A-B. In some aspects, an Fc includes the mutations of Variant 5 A-B.

Table X		
Human IgG1 Fc sequence 231-447 (EU-numbering)	APELLGGPSVFLFPPKPKDTLMISRTPEVTCVVVDVSHEDPEVKFNWYV DGVEVHNAKTKPREEQYNSTYRVVSVLTVLHQDWLNGKEYKCKVSNKAL PAPIEKTISKAKGQPREPQVYTLPPSRDELTKNQVSLTCLVKGFYPSDI AVEWESNGQPENNYKTTTPVLDSDGSFFLYSKLTVDKSRWQQGNVFPSCS VMHEALHNHYTQKSLSLSPGK	
Variant IgG1 Fc sequence (231-447)	Chain	Mutations
1	A	L351Y_F405A_Y407V
1	B	T366L_K392M_T394W
2	A	L351Y_F405A_Y407V
2	B	T366L_K392L_T394W
3	A	T350V_L351Y_F405A_Y407V
3	B	T350V_T366L_K392L_T394W
4	A	T350V_L351Y_F405A_Y407V
4	B	T350V_T366L_K392M_T394W
5	A	T350V_L351Y_S400E_F405A_Y407V
5	B	T350V_T366L_N390R_K392M_T394W

[0163] The first and second CH3 sequences can comprise amino acid mutations as described herein, with reference to amino acids 231 to 447 of the full-length human IgG1 heavy chain. In one embodiment, the heterodimeric Fc comprises a modified CH3 domain with a first CH3 sequence having amino acid modifications at positions F405 and Y407, and a second CH3 sequence having amino acid modifications at position T394. In one embodiment, the heterodimeric Fc comprises a modified CH3 domain with a first CH3 sequence having one or more amino acid modifications selected from L351Y, F405A, and Y407V, and the second CH3 sequence having one or more amino acid modifications selected from T366L, T366I, K392L, K392M, and T394W.

[0164] In one embodiment, a heterodimeric Fc comprises a modified CH3 domain with a first CH3 sequence having amino acid modifications at positions L351, F405 and Y407, and a second CH3 sequence having amino acid modifications at positions T366, K392, and T394, and one of the first or second CH3 sequences further comprising amino acid modifications at position Q347, and the other CH3 sequence further comprising amino acid modification at position K360. In another embodiment, a heterodimeric Fc comprises a modified CH3 domain with a first CH3 sequence having amino acid modifications at positions L351, F405 and Y407, and a second CH3 sequence having amino acid modifications at position T366, K392, and T394, one of the first or second CH3 sequences further comprising amino acid modifications at position Q347, and the other CH3 sequence further comprising amino acid modification at position K360, and one or both of said CH3 sequences further comprise the amino acid modification T350V.

[0165] In one embodiment, a heterodimeric Fc comprises a modified CH3 domain with a first CH3 sequence having amino acid modifications at positions L351, F405 and Y407, and a second CH3 sequence having amino acid modifications at positions T366, K392, and T394 and one of said first and second CH3 sequences further comprising amino acid modification of D399R or D399K and the other CH3 sequence comprising one or more of T411E, T411D, K409E, K409D, K392E and K392D. In another embodiment, a heterodimeric Fc comprises a modified CH3 domain with a first CH3 sequence having amino acid modifications at positions L351, F405 and Y407, and a second CH3 sequence having amino acid modifications at positions T366, K392, and T394, one of said first and second CH3 sequences further comprises amino acid modification of D399R or D399K and the other CH3 sequence comprising one or more of T411E, T411D, K409E, K409D, K392E and K392D, and one or both of said CH3 sequences further comprise the amino acid modification T350V.

[0166] In one embodiment, a heterodimeric Fc comprises a modified CH3 domain with a first CH3 sequence having amino acid modifications at positions L351, F405 and Y407, and a second CH3 sequence having amino acid modifications at positions T366, K392, and T394, wherein one or both of said CH3 sequences further comprise the amino acid modification of T350V.

[0167] In one embodiment, a heterodimeric Fc comprises a modified CH3 domain comprising the following amino acid modifications, where "A" represents the amino acid modifications to the first CH3 sequence, and "B" represents the amino acid modifications to the

second CH3 sequence: A:L351Y\_F405A\_Y407V, B:T366L\_K392M\_T394W, A:L351Y\_F405A\_Y407V, B:T366L\_K392L\_T394W, A:T350V\_L351Y\_F405A\_Y407V, B:T350V\_T366L\_K392L\_T394W, A:T350V\_L351Y\_F405A\_Y407V, B:T350V\_T366L\_K392M\_T394W, A:T350V\_L351Y\_S400E\_F405A\_Y407V, and/or B:T350V\_T366L\_N390R\_K392M\_T394W.

[0168] The one or more asymmetric amino acid modifications can promote the formation of a heterodimeric Fc in which the heterodimeric CH3 domain has a stability that is comparable to a wild-type homodimeric CH3 domain. In an embodiment, the one or more asymmetric amino acid modifications promote the formation of a heterodimeric Fc domain in which the heterodimeric Fc domain has a stability that is comparable to a wild-type homodimeric Fc domain. In an embodiment, the one or more asymmetric amino acid modifications promote the formation of a heterodimeric Fc domain in which the heterodimeric Fc domain has a stability observed via the melting temperature ( $T_m$ ) in a differential scanning calorimetry study, and where the melting temperature is within 4°C of that observed for the corresponding symmetric wild-type homodimeric Fc domain. In some aspects, the Fc comprises one or more modifications in at least one of the  $C_{H3}$  sequences that promote the formation of a heterodimeric

[0169] Fc with stability comparable to a wild-type homodimeric Fc.

In one embodiment, the stability of the CH3 domain can be assessed by measuring the melting temperature of the CH3 domain, for example by differential scanning calorimetry (DSC). Thus, in a further embodiment, the CH3 domain has a melting temperature of about 68°C or higher. In another embodiment, the CH3 domain has a melting temperature of about 70°C or higher. In another embodiment, the CH3 domain has a melting temperature of about 72°C or higher. In another embodiment, the CH3 domain has a melting temperature of about 73°C or higher. In another embodiment, the CH3 domain has a melting temperature of about 75°C or higher. In another embodiment, the CH3 domain has a melting temperature of about 78°C or higher. In some aspects, the dimerized  $C_{H3}$  sequences have a melting temperature ( $T_m$ ) of about 68, 69, 70, 71, 72, 73, 74, 75, 76, 77, 77.5, 78, 79, 80, 81, 82, 83, 84, or 85°C or higher.

[0170] In some embodiments, a heterodimeric Fc comprising modified CH3 sequences can be formed with a purity of at least about 75% as compared to homodimeric Fc in the expressed product. In another embodiment, the heterodimeric Fc is formed with a purity greater than about 80%. In another embodiment, the heterodimeric Fc is formed with a purity greater than about

85%. In another embodiment, the heterodimeric Fc is formed with a purity greater than about 90%. In another embodiment, the heterodimeric Fc is formed with a purity greater than about 95%. In another embodiment, the heterodimeric Fc is formed with a purity greater than about 97%. In some aspects, the Fc is a heterodimer formed with a purity greater than about 75, 76, 77, 78, 79, 80, 81, 82, 83, 84, 85, 86, 87, 88, 89, 90, 91, 92, 93, 94, 95, 96, 97, 98, or 99% when expressed. In some aspects, the Fc is a heterodimer formed with a purity greater than about 75, 76, 77, 78, 79, 80, 81, 82, 83, 84, 85, 86, 87, 88, 89, 90, 91, 92, 93, 94, 95, 96, 97, 98, or 99% when expressed via a single cell.

[0171] Additional methods for modifying monomeric Fc polypeptides to promote heterodimeric Fc formation are described in International Patent Publication No. WO 96/027011 (knobs into holes), in Gunasekaran et al. (Gunasekaran K. et al. (2010) *J Biol Chem.* 285, 19637-46, electrostatic design to achieve selective heterodimerization), in Davis et al. (Davis, JH. et al. (2010) *Prot Eng Des Sel* ;23(4): 195-202, strand exchange engineered domain (SEED) technology), and in Labrijn et al [Efficient generation of stable bispecific IgG1 by controlled Fab-arm exchange. Labrijn AF, Meesters JJ, de Goeij BE, van den Bremer ET, Neijssen J, van Kampen MD, Strumane K, Verploegen S, Kundu A, Gramer MJ, van Berkel PH, van de Winkel JG, Schuurman J, Parren PW. *Proc Natl Acad Sci U S A.* 2013 Mar 26;110(13):5145-50. In some embodiments an isolated construct described herein comprises an antigen binding construct which binds an antigen; and a dimeric Fc polypeptide construct that has superior biophysical properties like stability and ease of manufacture relative to an antigen binding construct which does not include the same Fc polypeptide. A number of mutations in the heavy chain sequence of the Fc are known in the art for selectively altering the affinity of the antibody Fc for the different Fcγ receptors. In some aspects, the Fc comprises one or more modifications to promote selective binding of Fc-γ receptors.

[0172] The CH2 domain is amino acid 231-340 of the sequence shown in Table X. Exemplary mutations are listed below:

[0173] S298A/E333A/K334A, S298A/E333A/K334A/K326A (Lu Y, Vernes JM, Chiang N, et al. *J Immunol Methods.* 2011 Feb 28;365(1-2):132-41); F243L/R292P/Y300L/V305I/P396L, F243L/R292P/Y300L/L235V/P396L (Stavenhagen JB, Gorlatov S, Tuaille N, et al. *Cancer Res.* 2007 Sep 15;67(18):8882-90; Nordstrom JL, Gorlatov S, Zhang W, et al. *Breast Cancer Res.* 2011 Nov 30;13(6):R123); F243L (Stewart R, Thom G,

Levens M, et al. Protein Eng Des Sel. 2011 Sep;24(9):671-8.), S298A/E333A/K334A (Shields RL, Namenuk AK, Hong K, et al. J Biol Chem. 2001 Mar 2;276(9):6591-604); S239D/I332E/A330L, S239D/I332E (Lazar GA, Dang W, Karki S, et al. Proc Natl Acad Sci U S A. 2006 Mar 14;103(11):4005-10); S239D/S267E, S267E/L328F (Chu SY, Vostiar I, Karki S, et al. Mol Immunol. 2008 Sep;45(15):3926-33); S239D/D265S/S298A/I332E, S239E/S298A/K326A/A327H, G237F/S298A/A330L/I332E, S239D/I332E/S298A, S239D/K326E/A330L/I332E/S298A, G236A/S239D/D270L/I332E, S239E/S267E/H268D, L234F/S267E/N325L, G237F/V266L/S267D and other mutations listed in WO2011/120134 and WO2011/120135, herein incorporated by reference. *Therapeutic Antibody Engineering* (by William R. Strohl and Lila M. Strohl, Woodhead Publishing series in Biomedicine No 11, ISBN 1 907568 37 9, Oct 2012) lists mutations on page 283.

[0174] In some embodiments a CH2 domain comprises one or more asymmetric amino acid modifications. In some embodiments a CH2 domain comprises one or more asymmetric amino acid modifications to promote selective binding of a FcγR. In some embodiments the CH2 domain allows for separation and purification of an isolated construct described herein.

#### FcRn binding and PK parameters

[0175] As is known in the art, binding to FcRn recycles endocytosed antibody from the endosome back to the bloodstream (Raghavan et al., 1996, Annu Rev Cell Dev Biol 12:181-220; Ghetie et al., 2000, Annu Rev Immunol 18:739-766). This process, coupled with preclusion of kidney filtration due to the large size of the full-length molecule, results in favorable antibody serum half-lives ranging from one to three weeks. Binding of Fc to FcRn also plays a key role in antibody transport. Thus, in one embodiment, the constructs of the invention are able to bind FcRn.

#### Additional modifications to improve effector function.

[0176] In some embodiments a construct described herein can be modified to improve its effector function. Such modifications are known in the art and include afucosylation, or engineering of the affinity of the Fc portion of antibodies towards an activating receptor, mainly FCGR3a for ADCC, and towards C1q for CDC. The following Table Y summarizes various designs reported in the literature for effector function engineering.

Table Y
---------

Reference	Mutations	Effect
Lu, 2011, Ferrara 2011, Mizushima 2011	Afucosylated	Increased ADCC
Lu, 2011	S298A/E333A/K334A	Increased ADCC
Lu, 2011	S298A/E333A/K334A/K326A	Increased ADCC
Stavnhagen, 2007	F243L/R292P/Y300L/V305I/P396L	Increased ADCC
Nordstrom, 2011	F243L/R292P/Y300L/L235V/P396L	Increased ADCC
Stewart, 2011	F243L	Increased ADCC
Shields, 2001	S298A/E333A/K334A	Increased ADCC
Lazar, 2006	S239D/I332E/A330L	Increased ADCC
Lazar, 2006	S239D/I332E	Increased ADCC
Bowles, 2006	AME-D, not specified mutations	Increased ADCC
Heider, 2011	37.1, mutations not disclosed	Increased ADCC
Moore, 2010	S267E/H268F/S324T	Increased CDC

[0177] Thus, in one embodiment, a construct described herein can include a dimeric Fc that comprises one or more amino acid modifications as noted in the above table that confer improved effector function. In another embodiment, the construct can be afucosylated to improve effector function.

#### Linkers

[0178] The constructs described herein can include one or more heterodimers described herein operatively coupled to an Fc described herein. In some aspects, Fc is coupled to the one or more heterodimers with or without one or more linkers. In some aspects, Fc is directly coupled to the one or more heterodimers. In some aspects, Fc is coupled to the one or more heterodimers by one or more linkers. In some aspects, Fc is coupled to the heavy chain of each heterodimer by a linker.

[0179] In some aspects, the one or more linkers are one or more polypeptide linkers. In some aspects, the one or more linkers comprise one or more antibody hinge regions. In some aspects, the one or more linkers comprise one or more IgG1 hinge regions.

### Methods of preparing heterodimer pairs

[0180] As described above, the heterodimer pairs described herein can comprise a first heterodimer and a second heterodimer, each heterodimer comprising an immunoglobulin heavy chain or fragment thereof having at least a VH and CH1 domain, and an immunoglobulin light chain having a VL domain and a CL domain. The immunoglobulin heavy chains and immunoglobulin light chains of the heterodimer can readily be prepared using recombinant DNA technology known in the art. Standard techniques such as, for example, those described in Sambrook and Russell, *Molecular Cloning: A Laboratory Manual* (Cold Spring Harbor Laboratory Press, Cold Spring Harbor, N.Y., 3rd ed., 2001); Sambrook et al., *Molecular Cloning: A Laboratory Manual* (Cold Spring Harbor Laboratory Press, Cold Spring Harbor, N.Y., 2nd ed., 1989); Short Protocols in Molecular Biology (Ausubel et al., John Wiley and Sons, New York, 4th ed., 1999); and Glick and Pasternak, *Molecular Biotechnology: Principles and Applications of Recombinant DNA* (ASM Press, Washington, D.C., 2nd ed., 1998) can be used for recombinant nucleic acid methods, nucleic acid synthesis, cell culture, transgene incorporation, and recombinant protein expression. Alternatively, the heterodimers and heterodimer pairs described herein can be chemically synthesized.

[0181] The nucleic acid and amino acid sequences of the immunoglobulin heavy and light chains of the antibodies from which the heterodimers are derived are either known in the art or can be readily determined using nucleic acid and/or protein sequencing methods. Methods of genetically fusing the tags described herein to the immunoglobulin heavy and/or light chains are known in the art, and some are described below and in the Examples.

[0182] For example, methods of expressing and co-expressing immunoglobulin heavy and light chains in a host cell are well known in the art. In addition, methods of tagging heavy chains and/or light chains using recombinant DNA technology are also well known in the art. Expression vectors and host cells suitable for expression of the heavy and light chains are also well known in the art as described below.

[0183] Bispecific antibody production methods that do not rely on the use only a single clonal or transient cell line expressing all four chains are known in the art (Gramer, et al. (2013) *mAbs* 5, 962; Strop et al. (2012) *J Mol Biol* 420, 204.). These methods rely on a post production arm exchange under redox conditions of the two pairs of light and heavy chain involved in the

formation of bispecific antibody (Redox production). In this approach the H1:L1 and H2:L2 pairs can be expressed in two different cell lines to independently produce the two Fab arms. Subsequently, the two Fab arms are mixed under select redox conditions to achieve re-association of the two unique heavy chain H1 and H2 to form the bispecific antibody comprising L1:H1:H2:L2 chains. One can envision the use of the library/dataset of designs described herein in the production of bispecific antibodies using the Redox production method or modified versions of that method.

[0184] In certain embodiments, cell-free protein expression systems are utilized to co-express polypeptides (e.g., heavy and light chain polypeptides) without the use of living cells. Instead, all components needed to transcribe DNA to RNA and translate the RNA to protein (e.g. ribosomes, tRNAs, enzymes, cofactors, amino acids) are provided in solution for use *in vitro*. In certain embodiments, the *in vitro* expression requires (1) the genetic template (mRNA or DNA) encoding the heavy and light chain polypeptides and (2) a reaction solution containing the necessary transcriptional and translational molecular machinery. In certain embodiments, cell extracts substantially supply components of the reaction solution, for instance: RNA polymerases for mRNA transcription, ribosomes for polypeptide translation, tRNA, amino acids, enzymatic cofactors, an energy source, and cellular components essential for proper protein folding. Cell-free protein expression systems can be prepared using lysates derived from bacterial cells, yeast cells, insect cells, plant cells, mammalian cells, human cells or combinations thereof. Such cell lysates can provide the correct composition and proportion of enzymes and building blocks required for translation. In some embodiments, cell membranes are removed to leave only the cytosolic and organelle components of the cell.

[0185] Several cell-free protein expression systems are known in the art as reviewed in Carlson *et al.* (2012) *Biotechnol. Adv.* 30:1185-1194. For example, cell-free protein expression systems are available based on prokaryotic or eukaryotic cells. Examples of prokaryotic cell-free expression systems include those from *E. coli*. Eukaryotic cell-free protein expression systems are available based on extracts from rabbit reticulocytes, wheat germ, and insect cells, for example. Such prokaryotic and eukaryotic cell-free protein expression systems are commercially available from companies such as Roche, Invitrogen, Qiagen, and Novagen. One skilled in the art would readily be able to select suitable cell-free protein expression systems that would produce polypeptides (e.g., heavy chain and light chain polypeptides) that are capable of pairing



with each other. Further, the cell-free protein expression system can also be supplemented with chaperones (e.g. BiP) and isomerases (e.g. disulphide isomerase) to improve the efficiency of IgG folding.

[0186] In some embodiments, cell-free expression systems are utilized to co-express the heavy and light chain polypeptides from DNA templates (transcription and translation) or mRNA templates (translation only).

### *Vectors and Host Cells*

[0187] Recombinant expression of heavy and light chains requires construction of an expression vector containing a polynucleotide that encodes the heavy or light chain (e.g., antibody, or fusion protein). Once a polynucleotide encoding the heavy or light chain has been obtained, the vector for the production of the heavy or light chain can be produced by recombinant DNA technology using techniques well known in the art. Thus, methods for preparing a protein by expressing a polynucleotide containing the heavy or light chain encoding nucleotide sequence are described herein. Methods that are well known to those skilled in the art can be used to construct expression vectors containing heavy or light chain coding sequences and appropriate transcriptional and translational control signals. These methods include, for example, in vitro recombinant DNA techniques, synthetic techniques, and in vivo genetic recombination. The invention, thus, provides replicable vectors comprising a nucleotide sequence encoding heavy or light chains, operably linked to a promoter.

[0188] The expression vector is transferred to a host cell by conventional techniques and the transfected cells are then cultured by conventional techniques to produce the modified heavy or light chains for use in the method of the invention. In specific embodiments the heavy and light chains for use in the method are co-expressed in the host cell for expression of the entire immunoglobulin molecule, as detailed below.

[0189] A variety of host-expression vector systems can be utilized to express the modified heavy and light chains. Such host-expression systems represent vehicles by which the coding sequences of interest can be produced and subsequently purified, but also represent cells which can, when transformed or transfected with the appropriate nucleotide coding sequences, express the modified heavy and light chains in situ. These include but are not limited to microorganisms such as bacteria (e.g., *E. coli* and *B. subtilis*) transformed with recombinant bacteriophage DNA,

plasmid DNA or cosmid DNA expression vectors containing the modified heavy and light chain coding sequences; yeast (e.g., *Saccharomyces Pichia*) transformed with recombinant yeast expression vectors containing modified heavy and light chain coding sequences; insect cell systems infected with recombinant virus expression vectors (e.g., baculovirus) containing modified heavy and light chain coding sequences; plant cell systems infected with recombinant virus expression vectors (e.g., cauliflower mosaic virus, CaMV; tobacco mosaic virus, TMV) or transformed with recombinant plasmid expression vectors (e.g., Ti plasmid) containing modified heavy and light chain coding sequences; or mammalian cell systems (e.g., COS, CHO, BHK, HEK-293, NSO, and 3T3 cells) harboring recombinant expression constructs containing promoters derived from the genome of mammalian cells (e.g., metallothionein promoter) or from mammalian viruses (e.g., the adenovirus late promoter; the vaccinia virus 7.5K promoter). In certain embodiments, bacterial cells such as *Escherichia coli*, or eukaryotic cells, are used for the expression of modified heavy and light chains, which is a recombinant antibody or fusion protein molecules. For example, mammalian cells such as Chinese hamster ovary cells (CHO), in conjunction with a vector such as the major intermediate early gene promoter element from human cytomegalovirus is an effective expression system for antibodies (Foecking et al., 1986, *Gene* 45:101; and Cockett et al., 1990, *Bio/Technology* 8:2). In a specific embodiment, the expression of nucleotide sequences encoding the immunoglobulin heavy and light chains of each heterodimer is regulated by a constitutive promoter, inducible promoter or tissue specific promoter.

[0190] In mammalian host cells, a number of viral-based expression systems can be utilized. In cases where an adenovirus is used as an expression vector, the modified heavy and light chain coding sequences of interest can be ligated to an adenovirus transcription/translation control complex, e.g., the late promoter and tripartite leader sequence. This chimeric gene can then be inserted in the adenovirus genome by *in vitro* or *in vivo* recombination. Insertion in a non-essential region of the viral genome (e.g., region E1 or E3) will result in a recombinant virus that is viable and capable of expressing the modified heavy and light chains in infected hosts (e.g., see Logan & Shenk, 1984, *Proc. Natl. Acad. Sci. USA* 81 :355-359). Specific initiation signals can also be required for efficient translation of inserted antibody coding sequences. These signals include the ATG initiation codon and adjacent sequences. Furthermore, the initiation codon must be in phase with the reading frame of the desired coding sequence to ensure translation of the

entire insert. These exogenous translational control signals and initiation codons can be of a variety of origins, both natural and synthetic. The efficiency of expression can be enhanced by the inclusion of appropriate transcription enhancer elements, transcription terminators, etc. (see, e.g., Bittner et al., 1987, *Methods in Enzymol.* 153:516-544).

[0191] The expression of the immunoglobulin heavy and light chains of the heterodimers can be controlled by any promoter or enhancer element known in the art. Promoters which can be used to control the expression of the gene encoding modified heavy and light chains (e.g., antibody or fusion protein) include, but are not limited to, the SV40 early promoter region (Bernoist and Chambon, 1981, *Nature* 290:304-310), the promoter contained in the 3' long terminal repeat of Rous sarcoma virus (Yamamoto, et al., 1980, *Cell* 22:787-797), the herpes thymidine kinase promoter (Wagner et al., 1981, *Proc. Natl. Acad. Sci. U.S.A.* 78:1441-1445), the regulatory sequences of the metallothionein gene (Brinster et al., 1982, *Nature* 296:39-42), the tetracycline (Tet) promoter (Gossen et al., 1995, *Proc. Nat. Acad. Sci. USA* 89:5547-5551); prokaryotic expression vectors such as the  $\beta$ -lactamase promoter (Villa-Kamaroff et al, 1978, *Proc. Natl. Acad. Sci. U.S.A.* 75:3727-3731), or the tac promoter (DeBoer et al., 1983, *Proc. Natl. Acad. Sci. U.S.A.* 80:21-25; see also "Useful proteins from recombinant bacteria" in *Scientific American*, 1980, 242:74-94); plant expression vectors comprising the nopaline synthetase promoter region (Herrera-Estrella et al., *Nature* 303:209-213) or the cauliflower mosaic virus 35S RNA promoter (Gardner et al., 1981, *Nucl. Acids Res.* 9:2871), and the promoter of the photosynthetic enzyme ribulose biphosphate carboxylase (Herrera-Estrella et al., 1984, *Nature* 310:115-120); promoter elements from yeast or other fungi such as the Gal 4 promoter, the ADC (alcohol dehydrogenase) promoter, PGK (phosphoglycerol kinase) promoter, alkaline phosphatase promoter, and the following animal transcriptional control regions, which exhibit tissue specificity and have been utilized in transgenic animals: elastase I gene control region which is active in pancreatic acinar cells (Swift et al., 1984, *Cell* 38:639-646; Ornitz et al., 1986, *Cold Spring Harbor Symp. Quant. Biol.* 50:399-409; MacDonald, 1987, *Hepatology* 7:425-515); insulin gene control region which is active in pancreatic beta cells (Hanahan, 1985, *Nature* 315:115-122), immunoglobulin gene control region which is active in lymphoid cells (Grosschedl et al., 1984, *Cell* 38:647-658; Adames et al., 1985, *Nature* 318:533-538; Alexander et al., 1987, *Mol. Cell. Biol.* 7:1436-1444), mouse mammary tumor virus control region which is active in testicular, breast, lymphoid and mast cells (Leder et al., 1986, *Cell* 45:485-495),

albumin gene control region which is active in liver (Pinkert et al., 1987, *Genes and Devel.* 1 :268-276), alpha-fetoprotein gene control region which is active in liver (Krumlauf et al., 1985, *Mol. Cell. Biol.* 5:1639-1648; Hammer et al., 1987, *Science* 235:53-58; alpha 1-antitrypsin gene control region which is active in the liver (Kelsey et al., 1987, *Genes and Devel.* 1 :161-171), beta-globin gene control region which is active in myeloid cells (Mogram et al., 1985, *Nature* 315:338-340; Kollias et al., 1986, *Cell* 46:89-94; myelin basic protein gene control region which is active in oligodendrocyte cells in the brain (Readhead et al., 1987, *Cell* 48:703-712); myosin light chain-2 gene control region which is active in skeletal muscle (Sani, 1985, *Nature* 314:283-286); neuronal-specific enolase (NSE) which is active in neuronal cells (Morelli et al., 1999, *Gen. Virol.* 80:571-83); brain-derived neurotrophic factor (BDNF) gene control region which is active in neuronal cells (Tabuchi et al., 1998, *Biochem. Biophys. Res. Com.* 253:818-823); glial fibrillary acidic protein (GFAP) promoter which is active in astrocytes (Gomes et al., 1999, *Braz J Med Biol Res* 32(5): 619-631 ; Morelli et al., 1999, *Gen. Virol.* 80:571-83) and gonadotropic releasing hormone gene control region which is active in the hypothalamus (Mason et al., 1986, *Science* 234:1372-1378).

[0192] In addition, a host cell strain can be chosen which modulates the expression of the inserted sequences, or modifies and processes the gene product in the specific fashion desired. Expression from certain promoters can be elevated in the presence of certain inducers; thus, expression of the genetically engineered fusion protein can be controlled. Furthermore, different host cells have characteristic and specific mechanisms for the translational and post-translational processing and modification (e.g., glycosylation, phosphorylation of proteins). Appropriate cell lines or host systems can be chosen to ensure the desired modification and processing of the foreign protein expressed. For example, expression in a bacterial system will produce an unglycosylated product and expression in yeast will produce a glycosylated product. Eukaryotic host cells that possess the cellular machinery for proper processing of the primary transcript (e.g., glycosylation, and phosphorylation) of the gene product can be used. Such mammalian host cells include, but are not limited to, CHO, VERO, BHK, HeLa, COS, MDCK, HEK-293, 3T3, WI38, NSO, and in particular, neuronal cell lines such as, for example, SK-N-AS, SK-N-FI, SK-N-DZ human neuroblastomas (Sugimoto et al., 1984, *J. Natl. Cancer Inst.* 73: 51-57), SK-N-SH human neuroblastoma (*Biochim. Biophys. Acta*, 1982, 704: 450-460), Daoy human cerebellar medulloblastoma (He et al., 1992, *Cancer Res.* 52: 1144-1148) DBTRG-05MG glioblastoma

cells (Kruse et al., 1992, *In Vitro Cell. Dev. Biol.* 28A: 609-614), IMR-32 human neuroblastoma (*Cancer Res.*, 1970, 30: 2110-2118), 1321 NI human astrocytoma (*Proc. Natl. Acad. Sci. USA*, 1977, 74: 4816), MOG-G-CCM human astrocytoma (*Br. J. Cancer*, 1984, 49: 269), U87MG human glioblastoma-astrocytoma (*Acta Pathol. Microbiol. Scand.*, 1968, 74: 465-486), A172 human glioblastoma (Olopade et al., 1992, *Cancer Res.* 52: 2523-2529), C6 rat glioma cells (Benda et al., 1968, *Science* 161 : 370-371), Neuro-2a mouse neuroblastoma (*Proc. Natl. Acad. Sci. USA*, 1970, 65: 129-136), NB41A3 mouse neuroblastoma (*Proc. Natl. Acad. Sci. USA*, 1962, 48: 1184-1190), SCP sheep choroid plexus (Bolin et al., 1994, *J. Virol. Methods* 48: 211-221), G355-5, PG-4 Cat normal astrocyte (Haapala et al., 1985, *J. Virol.* 53: 827-833), Mpf ferret brain (Trowbridge et al., 1982, *In Vitro* 18: 952-960), and normal cell lines such as, for example, CTX TNA2 rat normal cortex brain (Radany et al., 1992, *Proc. Natl. Acad. Sci. USA* 89: 6467-6471) such as, for example, CRL7030 and Hs578Bst. Furthermore, different vector/host expression systems can effect processing reactions to different extents.

**[0193]** For long-term, high-yield production of recombinant proteins, stable expression is often preferred. For example, cell lines that stably express the modified heavy and light chains of the invention (e.g., antibody or fusion protein) can be engineered. Rather than using expression vectors that contain viral origins of replication, host cells can be transformed with DNA controlled by appropriate expression control elements (e.g., promoter, enhancer, sequences, transcription terminators, polyadenylation sites, etc.), and a selectable marker. Following the introduction of the foreign DNA, engineered cells are allowed to grow for 1-2 days in an enriched medium, and then are switched to a selective medium. The selectable marker in the recombinant plasmid confers resistance to the selection and allows cells to stably integrate the plasmid into their chromosomes and grow to form foci that in turn can be cloned and expanded into cell lines.

**[0194]** A number of selection systems can be used, including but not limited to the herpes simplex virus thymidine kinase (Wigler et al., 1977, *Cell* 11 :223), hypoxanthine-guanine phosphoribosyltransferase (Szybalska & Szybalski, 1962, *Proc. Natl. Acad. Sci. USA* 48:2026), and adenine phosphoribosyltransferase (Lowy et al., 1980, *Cell* 22:817) genes can be employed in tk-, hgprt- or aprt-cells, respectively. Also, antimetabolite resistance can be used as the basis of selection for dhfr, which confers resistance to methotrexate (Wigler et al., 1980, *Natl. Acad. Sci. USA* 77:3567; O'Hare et al., 1981, *Proc. Natl. Acad. Sci. USA* 78:1527); gpt, which confers

resistance to mycophenolic acid (Mulligan & Berg, 1981 , Proc. Natl. Acad. Sci. USA 78:2072); neo, which confers resistance to the aminoglycoside G-418 (Colberre-Garapin et al., 1981 , J. Mol. Biol. 150:1); and hygro, which confers resistance to hygromycin (Santerre et al., 1984, Gene 30:147) genes.

### *Co-expression of heavy chains and light chains*

[0195] The immunoglobulin heavy chains and light chains of the heterodimer pairs described herein can be co-expressed in mammalian cells, as noted above. In one embodiment, one heavy chain is co-expressed with two different light chains in a LCCA design set as described above, where the heavy chain preferentially pairs with one of the two light chains. In another embodiment, two unique heavy chains are co-expressed with two unique light chains, where each heavy chain preferentially pairs with one of the light chains.

### **Testing of heterodimer pairs**

[0196] As described above, at least one heterodimer of the heterodimer pairs described herein can comprise one or more amino acid modifications to their immunoglobulin heavy and/or immunoglobulin light chains such that when the two unique heavy chains and two unique light chains of the heterodimer pair are co-expressed in a mammalian cell, the heavy chain of the first heterodimer preferentially pairs with one of the light chains rather than the other. Likewise, the heavy chain of the second heterodimer preferentially pairs with the second light chain rather than the first. The degree of preferential pairing can be assessed, for example, by using the methods described below. The affinity of each heterodimer of the heterodimer pair for its respective antigen can be tested as described below. The thermal stability of each heterodimer of the heterodimer pair can also be tested as described below.

### *Methods to measure preferential pairing*

#### LCCA

[0197] In one embodiment, preferential pairing between immunoglobulin heavy and light chains is determined by performing a Light Chain Competition Assay (LCCA). Co-owned patent application PCT/US2013/063306, filed October 3, 2013, describes various embodiments of LCCA and is herein incorporated by reference in its entirety for all purposes. The method

allows quantitative analysis of the pairing of heavy chains with specific light chains within the mixture of co-expressed proteins and can be used to determine if one particular immunoglobulin heavy chain selectively associates with either one of two immunoglobulin light chains when the heavy chain and light chains are co-expressed. The method is briefly described as follows: At least one heavy chain and two different light chains are co-expressed in a cell, in ratios such that the heavy chain is the limiting pairing reactant; optionally separating the secreted proteins from the cell; separating the immunoglobulin light chain polypeptides bound to heavy chain from the rest of the secreted proteins to produce an isolated heavy chain paired fraction; detecting the amount of each different light chain in the isolated heavy chain fraction; and analyzing the relative amount of each different light chain in the isolated heavy chain fraction to determine the ability of the at least one heavy chain to selectively pair with one of the light chains.

[0198] The method provides reasonable throughput and is robust (i.e. insensitive to minor changes in operation, such as user or flow rate) and accurate. The method provides a sensitive assay that can measure the effects of small variations in the protein sequences. Promiscuous protein – protein; domain-domain; chain –chain interactions over large surface areas usually require multiple mutations (swaps) in order to introduce selectivity. The protein products do not need to be isolated and purified which enables more efficient screening. Further details regarding an embodiment of this method are described in the Examples.

#### Alternative methods to determine preferential pairing

[0199] Alternative methods for detecting preferential pairing include using LC-MS (Liquid chromatography – Mass spectrometry) to quantify the relative heterodimer populations including each light chain using differences in their molecular weight to identify each distinct species. An antigen activity assay could also be used to quantify relative heterodimer populations containing each light chain whereby the degree of binding measured (relative to controls) would be used to estimate each respective heterodimer population.

[0200] Additional methods such as SMCA are described in the Examples, Figures, and Tables.

#### *Thermal stability*

[0201] The thermal stability of the heterodimers can be determined according to methods known in the art. The melting temperature of each heterodimer is indicative of its thermal

stability. The melting point of the heterodimer can be measured using techniques such as differential scanning calorimetry (Chen et al (2003) Pharm Res 20:1952-60; Ghirlando et al (1999) Immunol Lett 68:47-52). Alternatively, the thermal stability of the heterodimer can be measured using circular dichroism (Murray et al. (2002) J. Chromatogr Sci 40:343-9).

### *Affinity for antigen*

[0202] The binding affinity of the heterodimers for their respective antigens and the off-rate of the interaction can be determined by competitive binding assays according to methods well known in the art. One example of a competitive binding assay is a radioimmunoassay comprising the incubation of labeled antigen (e.g., <sup>3</sup>H or <sup>125</sup>I with a molecule of interest (e.g., heterodimers of the present invention) in the presence of increasing amounts of unlabeled antigen, and the detection of the molecule bound to the labeled ligand. The affinity of the heterodimer of the present invention for the antigen and the binding off-rates can be determined from the saturation data by Scatchard analysis.

[0203] The kinetic parameters of a heterodimer described herein can also be determined using surface plasmon resonance (SPR) based assays known in the art (e.g., BIAcore kinetic analysis). For a review of SPR-based technology see Mullet et al., 2000, Methods 22: 77-91; Dong et al., 2002, Review in Mol. Biotech., 82: 303-23; Fivash et al., 1998, Current Opinion in Biotechnology 9: 97-101; Rich et al., 2000, Current Opinion in Biotechnology 11: 54-61. Additionally, any of the SPR instruments and SPR based methods for measuring protein-protein interactions described in U.S. Pat. Nos. 6,373,577; 6,289,286; 5,322,798; 5,341,215; 6,268,125 are contemplated in the methods of the invention. FACS can also be used to measure affinity, as is known in the art.

### *Generation of bispecific antibodies given Mab1 and Mab2 using a library of bispecific antibody mutation design sets.*

[0204] In one embodiment, described here is a bispecific antibody mutation design set aimed at selectively forming bispecific antibodies starting from two canonical antibodies Mab1 and Mab2 comprising of the antigen binding fragments Fab1 and Fab2 respectively. The design set consists of cognate mutations corresponding to Fab1, Fab2 and Fc respectively. In one embodiment, design set libraries are represented by design sets included in Table 5, Table 12, or any one of Tables 15 to 17. Mutations are introduced at the interface of light and heavy chain of



Fab1 to achieve selective pairing between the two obligate chains in the presence of competing light and heavy chain of Fab2. Selective pairing is achieved by introducing favorable complementary mutations in the two obligate light and heavy chains on the basis of steric, hydrophobic or electrostatic complementarity between certain hotspot framework residues at the interface while involving these mutated residues in unfavorable interface interaction for the non-obligate chain pairs. In each design set selective pairing mutations can also be introduced at the interface of light and heavy chain of Fab2 to achieve selective pairing between these two obligate chains in the presence of competing light and heavy chain of Fab1. The mutations are aimed at reducing the mis-pairing of light chain from Fab1 with heavy chain of Fab2 and vice-versa. Mutations are introduced at the Fc interface in order to achieve selective pairing of heavy chains to form asymmetric antibody molecules comprising two different heavy chains. Engineering at certain interface residue positions of light and heavy chains of an antibody can often lead to detrimental effects such as loss in antigen binding affinity, stability, solubility, aggregation propensity etc of that antibody. A number of related properties can be affected such as kon and koff rates, melting temperature (Tm), stability to stress conditions like acid, base, oxidation, freeze/thaw, agitation, pressure etc. This is often impacted by the complementarity determining regions (CDRs) of the antibody of interest. Given that the CDRs of different antibodies are generally not identical, the impact of the mutation design set on the properties described above may not be the same across all antibodies. Presented here is a method to create a bispecific antibody with noted purity relative to other contaminants containing incorrectly paired antibody-like structures, given any two available antibodies Mab1 and Mab2. The light and heavy chains of Mab1 and Mab2 are co-expressed after introducing the cognate mutations of each of the mutation design sets and the expressed antibody product is analytically screened to estimate the purity of the preferred bispecific antibody relative to other Mab like species expressed in the protein product. In some embodiments the analytical screening procedure may be based on an LC-MS technique. In some embodiments the analytical screening procedure may be based on charge based separation such as a capillary isoelectric focusing (cIEF) technique or a chromatographic technique. An example of the screening technique is presented in Example 9 based on the SMCA procedure. In some embodiments the noted purity of the bispecific antibody is defined as being greater than 70% of all the obtained Mab like species in the expressed protein product. In some embodiments the noted purity of the bispecific antibody is defined as being

greater than 90% of all the obtained Mab like species in the expressed protein product. The procedure for preparation and selection of bispecific Mab design set given Mab1 and Mab2 is shown schematically in Figure 12.

### **Pharmaceutical compositions**

[0205] The present invention also provides pharmaceutical compositions comprising the heterodimers or heterodimer pairs described herein. Such compositions comprise a therapeutically effective amount of the heterodimer or heterodimer pair, and a pharmaceutically acceptable carrier. In a specific embodiment, the term "pharmaceutically acceptable" means approved by a regulatory agency of the Federal or a state government or listed in the U.S. Pharmacopeia or other generally recognized pharmacopeia for use in animals, and more particularly in humans. The term "carrier" refers to a diluent, adjuvant, excipient, or vehicle with which the therapeutic is administered. Such pharmaceutical carriers can be sterile liquids, such as water and oils, including those of petroleum, animal, vegetable or synthetic origin, such as peanut oil, soybean oil, mineral oil, sesame oil and the like. Water is a preferred carrier when the pharmaceutical composition is administered intravenously. Saline solutions and aqueous dextrose and glycerol solutions can also be employed as liquid carriers, particularly for injectable solutions. Suitable pharmaceutical excipients include starch, glucose, lactose, sucrose, gelatin, malt, rice, flour, chalk, silica gel, sodium stearate, glycerol monostearate, talc, sodium chloride, dried skim milk, glycerol, propylene, glycol, water, ethanol and the like. The composition, if desired, can also contain minor amounts of wetting or emulsifying agents, or pH buffering agents. These compositions can take the form of solutions, suspensions, emulsion, tablets, pills, capsules, powders, sustained-release formulations and the like. The composition can be formulated as a suppository, with traditional binders and carriers such as triglycerides. Oral formulation can include standard carriers such as pharmaceutical grades of mannitol, lactose, starch, magnesium stearate, sodium saccharine, cellulose, magnesium carbonate, etc. Examples of suitable pharmaceutical carriers are described in "Remington's Pharmaceutical Sciences" by E. W. Martin. Such compositions will contain a therapeutically effective amount of the compound, preferably in purified form, together with a suitable amount of carrier so as to provide the form for proper administration to the patient. The formulation should suit the mode of administration.

[0206] In certain embodiments, the composition comprising the heterodimer or heterodimer pair is formulated in accordance with routine procedures as a pharmaceutical composition adapted for intravenous administration to human beings. Typically, compositions for intravenous administration are solutions in sterile isotonic aqueous buffer. Where necessary, the composition can also include a solubilizing agent and a local anesthetic such as lignocaine to ease pain at the site of the injection. Generally, the ingredients are supplied either separately or mixed together in unit dosage form, for example, as a dry lyophilized powder or water free concentrate in a hermetically sealed container such as an ampoule or sachette indicating the quantity of active agent. Where the composition is to be administered by infusion, it can be dispensed with an infusion bottle containing sterile pharmaceutical grade water or saline. Where the composition is administered by injection, an ampoule of sterile water for injection or saline can be provided so that the ingredients can be mixed prior to administration.

[0207] In certain embodiments, the compositions described herein are formulated as neutral or salt forms. Pharmaceutically acceptable salts include those formed with anions such as those derived from hydrochloric, phosphoric, acetic, oxalic, tartaric acids, etc., and those formed with cations such as those derived from sodium, potassium, ammonium, calcium, ferric hydroxide, isopropylamine, triethylamine, 2-ethylamino ethanol, histidine, procaine, etc.

[0208] The amount of the composition described herein which will be effective in the treatment, inhibition and prevention of a disease or disorder associated with aberrant expression and/or activity of a therapeutic protein can be determined by standard clinical techniques. In addition, *in vitro* assays can optionally be employed to help identify optimal dosage ranges. The precise dose to be employed in the formulation will also depend on the route of administration, and the seriousness of the disease or disorder, and should be decided according to the judgment of the practitioner and each patient's circumstances. Effective doses are extrapolated from dose-response curves derived from *in vitro* or animal model test systems.

### **Uses of heterodimer pairs**

[0209] As described above, the heterodimer pairs described herein can comprise a first heterodimer and a second heterodimer, where the immunoglobulin heavy chain and/or the immunoglobulin light chain of each heterodimer comprise one or more modifications from a known therapeutic antibody or from a known antibody that binds a molecule. Thus, it is

contemplated that heterodimers comprising the modifications to these antibodies could be used for the treatment or prevention of the same disease, disorder, or infection that the known therapeutic antibody or known antibody can be used for.

[0210] In another embodiment, the heterodimer pairs described herein can also be advantageously utilized in combination with other therapeutic agents known in the art for the treatment or prevention of a cancer, autoimmune disease, inflammatory disorders or infectious diseases. In a specific embodiment, the heterodimer pairs described herein can be used in combination with monoclonal or chimeric antibodies, lymphokines, or hematopoietic growth factors (such as, e.g., IL-2, IL-3 and IL-7), which, for example, serve to increase the number or activity of effector cells which interact with the molecules and, increase immune response. The heterodimer pairs described herein can also be advantageously utilized in combination with one or more drugs used to treat a disease, disorder, or infection such as, for example anti-cancer agents, anti-inflammatory agents or anti-viral agents.

#### **Kits**

[0211] The present invention additionally provides for kits comprising one or more heterodimer pairs. Individual components of the kit would be packaged in separate containers and, associated with such containers, can be a notice in the form prescribed by a governmental agency regulating the manufacture, use or sale of pharmaceuticals or biological products, which notice reflects approval by the agency of manufacture, use or sale. The kit can optionally contain instructions or directions outlining the method of use or administration regimen for the heterodimer pairs.

[0212] When one or more components of the kit are provided as solutions, for example an aqueous solution, or a sterile aqueous solution, the container means can itself be an inhalant, syringe, pipette, eye dropper, or other such like apparatus, from which the solution can be administered to a subject or applied to and mixed with the other components of the kit.

[0213] The components of the kit can also be provided in dried or lyophilized form and the kit can additionally contain a suitable solvent for reconstitution of the lyophilized components. Irrespective of the number or type of containers, the kits of the invention also can comprise an instrument for assisting with the administration of the composition to a patient. Such an

instrument can be an inhalant, nasal spray device, syringe, pipette, forceps, measured spoon, eye dropper or similar medically approved delivery vehicle.

### **Computer implementation**

[0214] In one embodiment, a computer comprises at least one processor coupled to a chipset. Also coupled to the chipset are a memory, a storage device, a keyboard, a graphics adapter, a pointing device, and a network adapter. A display is coupled to the graphics adapter. In one embodiment, the functionality of the chipset is provided by a memory controller hub and an I/O controller hub. In another embodiment, the memory is coupled directly to the processor instead of the chipset.

[0215] The storage device is any device capable of holding data, like a hard drive, compact disk read-only memory (CD-ROM), DVD, or a solid-state memory device. The memory holds instructions and data used by the processor. The pointing device can be a mouse, track ball, or other type of pointing device, and is used in combination with the keyboard to input data into the computer system. The graphics adapter displays images and other information on the display. The network adapter couples the computer system to a local or wide area network.

[0216] As is known in the art, a computer can have different and/or other components than those described previously. In addition, the computer can lack certain components. Moreover, the storage device can be local and/or remote from the computer (such as embodied within a storage area network (SAN)).

[0217] As is known in the art, the computer is adapted to execute computer program modules for providing functionality described herein. As used herein, the term “module” refers to computer program logic utilized to provide the specified functionality. Thus, a module can be implemented in hardware, firmware, and/or software. In one embodiment, program modules are stored on the storage device, loaded into the memory, and executed by the processor.

It is understood that the examples and embodiments described herein are for illustrative purposes only and that various modifications or changes in light thereof will be suggested to persons skilled in the art and are to be included within the spirit and purview of this application and scope of the appended claims.

## EXAMPLES

[0218] Below are examples of specific embodiments for carrying out the present invention. The examples are offered for illustrative purposes only, and are not intended to limit the scope of the present invention in any way. Efforts have been made to ensure accuracy with respect to numbers used (e.g., amounts, temperatures, etc.), but some experimental error and deviation should, of course, be allowed for.

[0219] The practice of the present invention will employ, unless otherwise indicated, conventional methods of protein chemistry, biochemistry, recombinant DNA techniques and pharmacology, within the skill of the art. Such techniques are explained fully in the literature. See, e.g., T.E. Creighton, *Proteins: Structures and Molecular Properties* (W.H. Freeman and Company, 1993); A.L. Lehninger, *Biochemistry* (Worth Publishers, Inc., current addition); Sambrook, et al., *Molecular Cloning: A Laboratory Manual* (2nd Edition, 1989); *Methods In Enzymology* (S. Colowick and N. Kaplan eds., Academic Press, Inc.); Remington's *Pharmaceutical Sciences*, 18th Edition (Easton, Pennsylvania: Mack Publishing Company, 1990); Carey and Sundberg *Advanced Organic Chemistry* 3rd Ed. (Plenum Press) Vols A and B(1992).

### **Example 1: Molecular modeling and computer guided engineering of Fab interface**

[0220] A structure and computational molecular modeling guided approach was used to produce a library of heavy and light chain mutation designs that can be screened in the context of other antibodies (Abs) or fragments thereof to identify mutations that exhibit the desired specificity in the antibodies of interest. The design strategy for engineering preferential heavy chain (H)- light chain (L) pairing included first identifying a representative Fab (i.e. D3H44).

[0221] As indicated in Table 1, key criteria for this Fab were that it was human/humanized, has the commonly used VH and VL subgroups and contained minimal framework region mutations. In addition, structural considerations were that the VH:VL interdomain angle should be close to the average observed for antibodies. After selection of the Fab D3H44, an *in silico* analysis of the Fab interface was carried out to identify and understand residues important for interaction between heavy and light chains, using a two-pronged approach.

[0222] The first approach involved a global analysis of the sequence conservation across the Fab variable and constant interfaces was carried out via sequence and structure alignments of known antibodies. An alignment of constant and variable domain sequences from various antibody subgroups is shown in Figure 1. Figure 1A depicts an alignment of representative human VH germline subgroups. Figure 1B depicts an alignment of representative human kappa VL germline subgroups. Figure 1C depicts an alignment of representative human lambda VL germline subgroups. Figure 1D depicts an alignment of human CH1 allele sequences. Figure 1E depicts an alignment of human kappa and lambda allele sequences. The second approach involved the analysis of the D3H44 crystal structure interface using a number of molecular modeling tools as shown in Figure 2 (e.g. ResidueContacts<sup>TM</sup>). These analyses resulted in the identification of a list of hotspot positions for engineering preferential H-L pairing. The hotspot positions determined from this analysis are listed in Table 2. These positions and amino acids are mainly framework residues (except for a few located in the CDR3 loops) and are also mostly conserved in the lambda L chains. The amino acids in the parent D3H44 sequences with Kabat numbering are provided in Tables 3a-3b.

[0223] Next, potential mutations at the hotspot positions as well as positions neighboring the hotspots of interest in the 3D crystal structure were simulated and identified via *in silico* mutagenesis and packing / modeling with Zymepack<sup>TM</sup>. Zymepack<sup>TM</sup> is a software suite that, given an input structure and a set of mutations, will alter the residue types in the input structure according to the supplied mutations, and generate a new structure that is an approximation to the physical structure of the mutant protein. Additionally, Zymepack evaluates the properties of the mutant protein by computing a variety of quantitative metrics. These metrics include measures of steric and electrostatic complementarity, which may correlate with the stability, binding affinity, or heterodimeric specificity of the mutant protein.

[0224] Figure 3 presents a subset of hotspot positions at the heavy and light chain interface in the variable domains and demonstrates how mutations can be introduced at these interface positions to facilitate selective pairing of the obligate chains while disfavoring the formation of incorrect chain pairs. Using computational methods including Zymepack<sup>TM</sup>, steric complementarity was modeled and also computed on the basis of energy factors such as van der Waals packing, cavitation effects and close contact of hydrophobic groups. Similarly,

electrostatic interaction energies were modeled and evaluated on the basis of coulomb interactions between charges, hydrogen bonds, and desolvation effects. Both the preferred heavy and light chain pair models such as H1:L1 (or H2:L2) and the incorrect pair models such as H1:L2 (and H2:L1) obtained by introducing the mutations of interest were simulated to compute the relative steric and electrostatic scores. This allowed the determination of whether a particular mutation set led to favorable energies i.e. greater steric and/or electrostatic complementarity for the preferred (obligate) heavy – light chain pairs relative to the incorrect (non-obligate) pairs. The computed steric and electrostatic energies are components of the free energy associated with the light and heavy chain pairing. Hence greater steric and electrostatic complementarity is indicative of a larger free energy change associated with the pairing of the obligate pair relative to the pairing of the non-obligate pair. The greater steric or electrostatic complementarity results in preferential (selective) pairing of the obligate heavy and light chains relative to the non-obligate pair.

#### **Example 2: Selection and description of designs**

[0225] The approach described in Example 1 was used to design heavy chain-light chain heterodimer pairs (*i.e.* H1-L1 and H2-L2) that exhibit selective or preferential pairing. The heterodimers were designed in pairs, referred to as a “design” or “design set,” and include a set of substitutions on H1, L1, H2, and L2 chains that promote preferential pairing (Table 5). The design sets were initially tested as “LCCA designs” (Table 4) where one heavy chain was co-expressed with two light chains in order to assess relative pairing. The amino acid substitutions are identified with reference to Tables 3a, 3b, using the Kabat numbering system.

[0226] The design library described in Table 30 from International Patent application number PCT/CA2013/050914 was used as a starting point to identify some of the LCCA designs shown in Table 4 and the design sets shown in Table 5. Some of the designs in Table 4 and Table 5 are new independent designs. Core designs are shown in Table 6, along with the associated unique identifiers. Most of the designs span the constant region only, with a few of the designs also incorporating modifications in the variable region. These designs were proposed to further drive pairing specificity while also favoring transferability to other antibody systems.



[0227] For the derived designs, the library of designs described in Table 30 from International Patent application number PCT/CA2013/050914 was used as a starting point, with the designs clustered by structural similarity and ranked based on strength of pairing specificity, effect on antigen binding, and stability as measured by Differential Scanning Calorimetry (DSC). Designs were then combined (see example in Table 7) and/or optimized (see examples in Table 8 and Table 9) to yield the derived designs. For the combinations, at least one of the designs exhibited high pairing specificity with the other design(s) exhibiting a range of favorable pairing specificities. All of the designs chosen for combination and/or optimization exhibited no/minimal effects on antigen binding and no/minimal effects on melting temperature (T<sub>m</sub>).

[0228] Independent designs were tested alone (classified as independent, under design type column, Table 5), and in combination with the derived designs as well (classified as independent/combo, under design type column, Table 5; see also example in Table 10).

[0229] The designs were packed onto a molecular model of D3H44 and metrics were calculated (as described in Example 1). The top designs were then selected based on risk (possible effects on stability as well as immunogenicity) and impact (which takes into account the proposed strength of the drive pairing specificity). These top designs are shown in Table 5.

**Example 3: Preparation of Fab constructs encoding D3H44 IgG heavy chains and D3H44 IgG light chains.**

[0230] The wild-type Fab heavy and light chains of the anti-tissue factor antibody D3H44 were prepared as follows. D3H44 Fab light (AJ308087.1) and heavy (AJ308086.1) chain sequences were taken from GenBank (Table 3c), gene synthesized and codon optimized for mammalian expression. Light chain vector inserts, consisting of a 5'-EcoRI cutsite – HLA-A signal peptide – HA or FLAG tag – Light chain Ig clone – 'TGA stop' – BamHI cutsite-3', were ligated into a pTT5 vector (Durocher Y et al., Nucl. Acids Res. 2002; 30, No. 2 e9). The resulting vector + insert were sequenced to confirm correct reading frame and sequence of the coding DNA. Likewise, heavy chain vector inserts, consisting of a 5'-EcoRI cutsite – HLA-A signal peptide – heavy chain clone (terminating at T238; see Table 3a) – ABD<sub>2</sub>-His<sub>6</sub>tag – TGA stop – BamHI cutsite-3', were ligated into a pTT5 vector (ABD; albumin binding domain). The resulting vector + insert were also sequenced to confirm correct reading frame and sequence of

the coding DNA. The various Fab D3H44 constructs containing amino acid substitutions for the design sets were generated either by gene synthesis or by site-directed mutagenesis (Braman J, Papworth C & Greener A., *Methods Mol. Biol.* (1996) 57:31-44).

[0231] Heavy and light chains were tagged at the C- and N-termini respectively, in order to facilitate the assessment of preferential pairing via a competition assay-SPR screen. The ABD<sub>2</sub>-His<sub>6</sub> heavy chain tag specifically allowed H-L complexes to be captured on an anti-his tag SPR chip surface, whilst FLAG and HA light chain tags allowed the relative L1 and L2 populations to be quantified.

**Example 4: Assessment of Preferential Pairing of Fab heterodimers comprising either constant domain modifications or a combination of constant and variable domain modifications in D3H44 IgG light and/or heavy chains.**

[0232] Constructs encoding the D3H44 IgG heavy and light chains in Fab format comprising amino acid modifications according to the LCCA design sets in Table 12 were prepared as described in Example 3. The ability of the constructs to preferentially pair to form the desired H1-L1 heterodimer in the context of an LCCA design set (H1, L1, L2) was determined using a Light Chain Competition Assay (LCCA).

[0233] The LCCA quantifies the relative pairing of one heavy chain for at least two unique light chains and can be summarized as follows. One D3H44 heavy chain Fab construct was co-expressed with two unique D3H44 light chain Fab constructs and the relative light chain pairing specificity (e.g. H1-L1:H1-L2) was determined from a competition assay-SPR screen, conducted in duplicate. The LCCA screen ratio was skewed to identify strong drivers, by reducing the amount of L1 (designed to preferentially pair with the H chain) compared to L2, (e.g. L1:L2 = 1:3, by weight), while keeping the heavy chain in limiting quantities (i.e. H1: L1 + L2 of 1:3). The amount of each heterodimer formed (*i.e.* H1-L1 and H1-L2) was determined by binding heavy chains to the SPR chip via a his-tag pull-down, followed by detection of the amount of each light chain tag (HA or FLAG) using antibodies specific for these tags. Subsequently, selected heterodimer hits were verified via a light chain competition assay verification whereby the L1:L2 DNA ratios were varied by 1:3 and 1:9 during transfection, while keeping the heavy chain in limiting quantities. Also note that the light chain tags (HA or FLAG) do not affect

LCCA pairing in the D3H44 system (see example 10 from International Patent application number PCT/CA2013/050914). A schematic representing the design of the assay is shown in Figure 4. Figure 5 depicts how the heavy chains and light chains are tagged and how preferential pairing is assessed. The experimental details of the LCCA are provided below.

#### Transfection method

[0234] LCCA designs comprising one heavy chain and two light chain constructs, prepared as described in Example 3, were transfected into CHO-3E7 cells as follows. CHO-3E7 cells, at a density of  $1.7 - 2 \times 10^6$  cells /ml, were cultured at 37°C in FreeStyle™ F17 medium (Invitrogen cat# A-1383501) supplemented with 4 mM glutamine and 0.1% KoliphorP188 (Sigma #K4894). A total volume of 2ml was transfected with a total of 2 µg DNA using PEI-pro (Polyplus transfection # 115-375) at a DNA:PEI ratio of 1:2.5. Twenty-four hours after the addition of the DNA-PEI mixture, the cells were transferred to 32°C. Supernatants were tested for expression on day 7 by non-reducing SDS-PAGE analysis followed by Coomassie blue staining to visualize the bands. H: L ratios are as indicated in Table 11.

#### Competition assay SPR method

[0235] The degree of preferential D3H44 light chain pairing to D3H44 heavy chain in LCCA designs was assessed using an SPR-based readout of unique epitope tags located at the N-terminus of each light chain.

[0236] *Surface Plasmon resonance (SPR) supplies.* GLC sensorchips, the Biorad ProteOn amine coupling kit (*N*-ethyl-3-(3-dimethylaminopropyl) carbodiimide hydrochloride (EDC), *N*-hydroxysulfosuccinimide (sNHS) and ethanolamine), and 10mM sodium acetate buffers were purchased from Bio-Rad Laboratories (Canada) Ltd. (Mississauga, ON). 4-(2-hydroxyethyl)-*N*-piperazineethanesulfonic acid (HEPES) buffer, ethylenediaminetetraacetic acid (EDTA), and NaCl were purchased from from Sigma-Aldrich (Oakville, ON). 10% Tween 20 solution was purchased from Teknova (Hollister, CA).

[0237] *SPR biosensor assays.* All surface plasmon resonance assays were carried out using a BioRad ProteOn XPR36 instrument (Bio-Rad Laboratories (Canada) Ltd. (Mississauga, ON))

with PBST running buffer (PBS Teknova Inc with 0.05% Tween20) at a temperature of 25°C. The anti-penta His capture surface was generated using a GLM sensorchip activated by a 1:5 dilution of the standard BioRad sNHS/EDC solutions injected for 140 s at 100 µL/min in the analyte (horizontal) direction. Immediately after the activation, a 25 µg/mL solution of anti-penta His antibody (Qiagen Inc.) in 10 mM NaOAc pH 4.5 was injected in the analyte (vertical) direction at a flow rate of 25 µL/min until approximately 3000 resonance units (RUs) are immobilized. Remaining active groups were quenched by a 140 s injection of 1M ethanolamine at 100 µL/min in the analyte direction, and this also ensures mock-activated interspots were created for blank referencing.

[0238] The screening of the heterodimers for binding to the anti-FLAG (Sigma Inc.) and anti-HA (Roche Inc.) monoclonal antibodies occurred in two steps: an indirect capture of the heterodimers onto the anti-penta His surface in the ligand direction followed by an anti-FLAG and anti-HA injection in the analyte direction. First, one injection of PBST for 30 s at 100 µL/min in the ligand direction was used to stabilize the baseline. For each heterodimer capture, unpurified heterodimers in cell-culture media were diluted to 4 % in PBST. One to five heterodimers or controls (i.e. controls containing either 100% HA-light chain or 100% FLAG-light chain) were simultaneously injected in individual ligand channels for 240 s at flow 25 µL/min, resulting in a saturating heterodimer capture of approximately 300 to 400 RUs onto the anti-penta His surface. The first ligand channel was left empty to use as a blank control if required. This heterodimer capture step was immediately followed by two buffer injections in the analyte direction to stabilize the baseline, and then 5 nM anti-FLAG and 5 nM anti-HA were each injected in duplicate at 50 µL/min for 120 s with a 180 s dissociation phase, resulting in a set of binding sensorgrams with a buffer reference for each of the captured heterodimer. The tissue factor (TF) antigen to which the heterodimer binds was also injected over the last remaining analyte channel as an activity control. The heterodimers were regenerated by an 18 s pulse of 0.85% phosphoric acid for 18 s at 100 µL/min to prepare the anti-penta His surface for the next injection cycle. Sensorgrams were aligned and double-referenced using the buffer blank injection and interspots, and the resulting sensorgrams were analyzed using ProteOn Manager software v3.0.

## Results

[0239] The LCCA results are shown in Tables 12, 13a and 14a. Note that in Tables 13 and 14, the “Unique identifier” may not exactly correspond with Table 5, as the unique identifiers for the two constituent LCCAs may be in either of orientation ((Set#H1L1L2 -Set#H2L2L1) or (Set#H2L2L1-Set#H1L1L2)). The assessment of preferential pairing for each LCCA design is shown in the last 3 columns of Table 12. The same data is also included in the context of design pairs in Tables 13a and 14a, in columns 5, 6, and 8, or 10, 11 and 13. Each unique set of H1, L1 and L2 mutations (LCCA design) was assigned a unique number, or ‘Set #’ (e.g. 9567 or 9087). When data is presented in H1 L1 H2 L2 format (Fab pair format or design set), such a design set is consequently denoted with a ‘unique identifier’ comprised of set numbers for the two constituent LCCAs (e.g. 9567-9087). Note that the majority of LCCA experiments were performed on constructs containing the inter-chain Fab disulfide bond(s) located in the constant domain (H/C233-L/C214, Kabat numbering). Within Tables 13(a and b) and 14(a and b), for the purposes of highlighting a particular design’s success with respect to preferential pairing, two complementary LCCA sets (H1, L1, L2 and H2, L2, L1) are represented in a Fab pair format. Presence of tags (L chain: HA and FLAG and H chain: ABD<sub>2</sub>-His<sub>6</sub>) did not affect the expected neutral pairing of ~50%: 50% for D3H44 WT.

[0240] In the tables, the LCCA data reported are the median values in ratio format (H1-L1:H1-L2 and H2-L2:H2-L1) normalized to L1:L2 DNA ratios of 1:1. Furthermore, the LCCA data were normalized to 100%, as it was observed for some variants that the total amount of L1 and L2 significantly differed from 100%. This discrepancy in total light chain percentage is believed to be due in part to the occurrence of variable non-specific binding during initial heterodimer capture on the SPR chip. As the LCCA experiments were conducted at 2 different L1:L2 DNA ratios (L1:L2 of 1:3 and 1:9, respectively), both of the LCCA normalized ratios are listed in the tables. Note that LCCA data were not reported for some LCCA experiments, as the experimental data obtained did not meet the inclusion criteria (e.g. Fab capture on SPR chip was less than 100, or the LCCA total amounts of L1 and L2 fell outside the 60 to 140 range).

[0241] Table 12 lists all of the LCCA designs (530) for which data were obtained. Out of the 530 LCCA designs, 490 (92.5%) of these LCCA designs had at least 60% correct pairing (at the normalized L1:L2 DNA ratio of 1:1), considering both of the L1:L2 DNA ratios of 1:3 and 1:9. The remaining LCCA designs included LCCA designs that were primarily neutral (32/530 or

6.0%) as well as a small proportion that yielded inconsistent (8/530 or 1.5%) results. The designs shown in Table 12 were primarily electrostatic (based on specificity drivers that utilize hydrogen bonding or charge-charge interactions) with some designs also including steric complementarity and/or inter-chain covalent disulfide bonds. Some designs also comprised mutations for the formation of new disulfide bonds in the absence of the natural inter-chain disulfide bond (formed by H/C233-L/C214).

[0242] Tables 13(a and b) and 14(a and b) list the 447 designs for which LCCA data was present for both heterodimers of a design set. Tables 13a and 14a demonstrate that the *in silico* design approach described in Example 1 led to achievement of preferential pairing of H1-L1 over H1-L2 and that of H2-L2 over H2-L1 across a diverse set of designs and their variations.

[0243] Tables 13(a and b) list those designs that have an average LCCA performance (average of the median normalized values to L1:L2 ratio of 1:1 for H1-L1:H1-L2 and H2-L2:H2-L1) of paired:mispaired Fab heterodimers of at least 86:14 whereas Tables 14 (a and b) list those designs that have an average LCCA performance of paired:mispaired Fab heterodimers below 86:14. The performance of each LCCA was normalized to 100% as well as to an L1:L2 DNA ratio of 1:1 (as described in this example above), and is described by both the scalar value ( $(\ln(r1/f1) \text{ or } \ln(r2/f2))$  where  $r1$  and  $r2$  correspond to the median values of H1L1:H1L2 and H2L2:H2L1 at the experimental ratios, respectively, and  $f1$  and  $f2$  correspond to the respective experimental ratios) as well as by the ratio of paired to mispaired Fab heterodimers. Each design also has an associated average LCCA performance scalar value ( $0.5(\ln(r1/f1) + \ln(r2/f2))$ ) that is also normalized to 100% as well as to an L1:L2 DNA ratio of 1:1 (as described in this example above). Furthermore, the scalar range for each LCCA of a design (LCCA1 and LCCA2, corresponding to H1L1:H1L2 and H2L2:H2L1 experiments, respectively) is shown. Out of 447 Mab designs, 354 (79.2 %) exhibit at least an average LCCA performance of 86:14 (Table 13 a and b). The designs within Tables 13 (a and b) were further characterized into 13 clusters based on the similarity of designs. Designs within each cluster were arranged from highest to lowest average LCCA performance scalar value.

[0244] In addition, the LCCA data within Table 13a was also graphically represented in Figure 7. Figure 7 depicts box plots that show the average LCCA performance values of

paired/mispaired Fab heterodimers of at least 86:14 for each cluster. The bottom of each box indicates the first quartile (Q1), which is the middle average LCCA performance value between the smallest value and the median value, such that values below the 1<sup>st</sup> quartile indicate the lowest 25% of data. The horizontal bar inside the box indicates the second quartile, which is the median average LCCA performance value for the cluster. The top of each box indicates the third quartile (Q3), which is the middle average LCCA performance value between the largest value and the median value, such that values above the 3<sup>rd</sup> quartile indicate the highest 25% of data. The interquartile region is the difference between Q3 and Q1. The whiskers extending vertically in both directions indicate the data range for those values that are within  $Q1 - (1.5 * IQR)$  or  $Q3 + (1.5 * IQR)$ . The horizontal bars that cap the whiskers indicate the largest and smallest values within the range. Data that exist outside the box plots and whiskers are identified as outliers, with mild outliers indicated by a dot (differs from Q1 or Q3 by  $1.5 * IQR$  to  $3 * IQR$ ), and extreme outliers indicated by a plus sign (differs from Q1 or Q3 by greater than  $3 * IQR$ ).

#### **Example 5: Scale up for biophysical characterization**

[0245] Correctly paired heterodimers, as indicated in the unique identifier sets (Table 5), were scaled up (typically to 20 ml) and purified as follows in order to test for thermal stability and antigen binding. The heavy and light chains of each heterodimer were expressed in 20 ml cultures of CHO-3E7 cells. CHO-3E7 cells, at a density of  $1.7 - 2 \times 10^6$  cells/ml, were cultured at 37°C in FreeStyle™ F17 medium (Invitrogen cat# A-1383501) supplemented with 4 mM glutamine and 0.1% Koliphor P188 (Sigma #K4894). A total volume of 20 ml were transfected with a total of 20 µg DNA using PEI-pro (Polyplus cat# 115-375) at a DNA:PEI ratio of 1:2.5. Twenty-four hours after the addition of the DNA-PEI mixture, the cells were transferred to 32°C.

[0246] Cells were centrifuged 7 days after transfection, and heterodimers were purified from supernatant by high throughput nickel affinity chromatography purification, as follows. Supernatants were diluted to 20 - 25% cell culture supernatant in equilibration buffer (Dulbecco's phosphate buffered salines (DPBS) without Calcium, Magnesium, and phenol red (HyClone™# SH30028.02)) and then incubated with mixing for 12 hours with HisPur® Ni-NTA resin (Thermo Scientific # PI-88222), also previously equilibrated with the equilibration buffer. The

resin was then collected by centrifugation, transferred to a 96 well-fritted plate, washed with equilibration buffer three times and eluted using HIS-Select® elution buffer (Sigma-Aldrich # H5413).

[0247] Following purification, heterodimer expression was assessed by non-reducing High Throughput Protein Express assay using Caliper LabChip GXII (Perkin Elmer #760499). Procedures were carried out according to HT Protein Express LabChip User Guide version2 LabChip GXII User Manual, with the following modifications. Heterodimer samples, at either 2  $\mu$ l or 5  $\mu$ l (concentration range 5-2000 ng/ $\mu$ l), were added to separate wells in 96 well plates (BioRad # HSP9601) along with 7  $\mu$ l of HT Protein Express Sample Buffer (Perkin Elmer # 760328). The heterodimer samples were then denatured at 70°C for 15 mins. The LabChip instrument was operated using the HT Protein Express Chip (Perkin Elmer #760499) and the Ab-200 assay setting. After use, the chip was cleaned with MilliQ water and stored at 4°C.

#### **Example 6: Thermal stability measurements of Fab heterodimers by DSF.**

[0248] To assess thermal stability, Differential Scanning Fluorescence (DSF) was used as a high throughput method to screen all correctly paired heterodimers in comparison to that of wild type, unmodified heavy chain-light chain pair. Heterodimers were prepared as described in Example 5.

#### Measurement of thermal stability

[0249] The thermal stability of all heterodimer pairs was measured using DSF as follows. Each heterodimer was purified as described in Example 5 and diluted to 0.5 mg/mL in DPBS (HyClone Cat # SH30028.02). For the majority of samples, a working stock of Sypro Orange gel stain (Life Technologies Cat # S-6650) was prepared by diluting 4  $\mu$ L of Sypro Orange gel stain to 2 ml DPBS. The DSF samples were prepared by adding 14  $\mu$ L of 0.5 mg/mL protein to 60  $\mu$ L of the diluted Sypro Orange gel stain working stock. However, for proteins that had less than 0.5 mg/mL, each DSF sample were prepared by adding 14  $\mu$ L of the undiluted protein to 60  $\mu$ L of a working stock of Sypro Orange dye (that was diluted to 1:1500 in DPBS). DSF analysis was then conducted, in duplicate, on 20  $\mu$ l aliquots using the Rotor-Gene 6000 qPCR instrument (QiaGen Inc). Each sample was scanned from 30°C to 94°C using 1°C intervals with a 10 second



equilibrium between each step and a 30 second wait time at the start. An excitation filter of 470 nM and emission filter of 610 nM with a gain of 9 was used. Data was analyzed with the Rotor-Gene 6000 software using the maxima value from the first derivative of the denaturation curve as the  $T_m$ . The remaining DSF samples were prepared and analyzed similarly, with the following protocol modifications that do not alter the measured  $T_m$  values: 1) the working stock was prepared by diluting 1  $\mu$ L of Sypro Orange gel stain to 2 ml DPBS, 2) 30  $\mu$ l aliquots were analyzed and 3) a gain of 10 was used.

[0250] DSF results are shown in Tables 12, 13b and 14b. The thermal stability of the H1:L1 Fab in the context of an LCCA design (DSF value and change in DSF value compared to wild-type) is shown in columns 3 and 4 of Table 12. The same DSF values are also included in the context of design pairs in Tables 13b and 14b, in columns 7 and 8. For each Fab heterodimer where repeats were conducted, the reported  $T_m$  value is the median value. Comparisons of the Fab heterodimer  $T_m$  values with respect to the  $T_m$  value of the wild-type Fab heterodimer (wild type Fab construct containing a HA tag, with a median  $T_m$  of 81.0°C) are reported in the H1L1\_dTm\_dsf column. Note that for the few Fab heterodimers lacking the natural inter-chain disulfide (between H chain C233 and L chain C214), the H1L1\_dTm\_dsf values were not determined as the corresponding wild-type Fab lacking the natural inter-chain disulfide was not assessed. Also note that some Fab heterodimers do not have reported  $T_m$  values (17/230 or 7.4 % of Fab heterodimers), due to the quality of the respective experiments (e.g. low yields, low intensities, partially occluded peaks, and variability between repeats of Fab heterodimers of greater than 1°C). For some of these Fab heterodimers, estimated  $T_m$  values are reported instead, corresponding to the  $T_m$  values from similar Fab heterodimers that differ only in the presence/absence or identity of the attached L chain tag (HA or FLAG). For the estimated  $T_m$  values, the corresponding wild-type  $T_m$  value (81.2°C) is the median value obtained from all wild-type Fab heterodimer constructs (i.e. Fab constructs containing HA tag or FLAG tag). The HA or FLAG tag does not significantly affect the  $T_m$  values of the wild-type Fab heterodimers. Overall, the Fab heterodimers exhibited similar  $T_m$  values compared to WT. Of the Fab heterodimers containing the natural inter-chain disulfide and also for which DSF data are available, 93% (195/209) of the Fab heterodimers exhibited a loss of 3°C or less with respect to

WT. Furthermore, the most affected Fab heterodimer exhibited a loss of 6.5 °C with respect to WT. Table 12 lists the LCCA designs in decreasing T<sub>m</sub> rank order.

[0251] Furthermore, thirteen amino acid substitutions were identified that generally improved the stability of Fab heterodimers (see Table 34). The stabilizing mutations were identified following comparisons of Fab heterodimers that include the stabilizing mutation versus similar Fab heterodimers that differ in the absence of the stabilizing mutation. Heavy chain stabilizing mutations include A125R, H172R, L143F, Q179D, Q179E, Q39R, S188L, and V190F. Light chain stabilizing mutations include Q124E, Q124R, Q160F, S176L, and T180E. Overall, the stabilizing mutations increased stability by 0.4°C to 2.1°C. The heavy chain stabilizing mutations A125R, H172R, L143F, Q179D, Q179E, Q39R, S188L, and V190F increased stability by 0.4°C to 0.6°C, 0.4°C to 2.1°C, 0.4°C, 0.5°C to 0.6°C, 0.5°C to 0.8°C, 1.1°C to 1.6°C, 0.4°C to 1.2°C, and 1°C, respectively. The light chain stabilizing mutations Q124E, Q124R, Q160F, S176L, and T180E increased stability by 0.4°C to 0.5°C, 0.8°C to 0.9°C, 0.6°C, 0.4°C to 1.0°C, and 0.5°C, respectively.

#### **Example 7: Antigen affinity measurements of Fab heterodimers.**

[0252] The ability of the Fab heterodimers to bind to tissue factor was assessed in order to determine whether the amino acid substitutions had any effect on the ability of the heterodimer to bind to antigen. The affinity of each Fab heterodimer for tissue factor was determined by SPR as follows.

[0253] *SPR supplies.* GLC sensorchips, the Biorad ProteOn amine coupling kit (EDC, sNHS and ethanolamine), and 10mM sodium acetate buffers were purchased from Bio-Rad Laboratories (Canada) Ltd. (Mississauga, ON). PBS running buffer with 0.05% Tween20 (PBST) was purchased from Teknoca Inc. (Hollister, CA).

[0254] *Fab heterodimer batches.* The purified Fab heterodimers were tested in 3 batches, A, B, and C. Batches A and B were stored at 4 °C for approximately 1 month prior to conducting the SPR assays, whereas the purified Fab heterodimers from batch C were stored at 4 °C for

approximately 2 months, prior to conducting the SPR assays. The Fab heterodimers from batch C are indicated by a "+" next to the corresponding KD values in Table 12.

[0255] All surface plasmon resonance assays were carried out using a BioRad ProteOn XPR36 instrument (Bio-Rad Laboratories (Canada) Ltd. (Mississauga, ON)) with PBST running buffer at a temperature of 25°C. The anti-penta His capture surface was generated using a GLC sensorchip activated by a 1:5 dilution of the standard BioRad sNHS/EDC solutions injected for 140 s at 100 µL/min in the analyte (horizontal) direction. Immediately after the activation, a 25 µg/mL solution of anti-penta His antibody (Qiagen Inc.) in 10 mM NaOAc pH 4.5 was injected in the analyte (vertical) direction at a flow rate of 25 µL/min until approximately 3000 resonance units (RUs) was immobilized. Remaining active groups were quenched by a 140 s injection of 1M ethanolamine at 100 µL/min in the analyte direction, and this also ensured mock-activated interspots were created for blank referencing.

[0256] The screening of the Fab heterodimers for binding to TF antigen occurred in two steps: an indirect capture of the Fab heterodimers onto the anti-penta His antibody surface in the ligand direction followed by the simultaneous injection of 5 concentrations of purified antigen and one buffer blank for double referencing in the analyte direction. First, the baseline was stabilized with one buffer injection for 30 s at 100 µL/min in the ligand direction. One to five variants or controls, at a concentration of 3.4 µg/ml in PBST, were simultaneously injected in individual ligand channels for 240 s at a flow 25 µL/min. This resulted in an average capture of approximately 1000 RUs onto the anti-penta His surface for batches A and B, and an average capture of approximately 600 RUs onto the anti-penta His surface for batch C. The first ligand channel was left empty to use as a blank control if required. This capture step was immediately followed by two buffer injections, at 100 µL/min for 30 s each, in the analyte direction to stabilize the baseline, and then 60nM, 20nM, 6.7nM, 2.2nM and 0.74nM antigen (TF) along with a buffer blank was simultaneously injected at 50 µL/min for 120 s with a 600 s dissociation phase. The captured antibody surfaces were regenerated by two 18 s pulses of 0.85% phosphoric acid for 18 s at 100 µL/min to prepare for the next injection cycle. Sensorgrams were aligned and double-referenced using the buffer blank injection and interspots, and the resulting sensorgrams were analyzed using ProteOn Manager software v3.1. The double-referenced

sensorgrams were fit to the 1:1 binding model. Rmax values for each antigen were normalized to antibody capture levels for each variant and compared to 100% controls.

[0257] Antigen affinity (KD) values for Fab heterodimer samples are reported in Tables 12, 13b and 14b. The KD values of the H1:L1 Fab in the context of an LCCA design (KD, range of KD values, and change in median KD values compared to wild-type) are shown in columns 5, 6, and 7, respectively, of Table 12. The same KD values are also included in the context of design pairs in Tables 13b and 14b, in columns 3 (KD of H1-L1 Fab heterodimer), 4 (change in KD of H1-L1 Fab heterodimer compared to wild-type), 5 (KD of H2-L2 Fab heterodimer), and 6 (change in KD of H2-L2 Fab heterodimer compared to wild-type). KD values were determined only for Fab heterodimer samples that exhibited a Fab heterodimer capture of at least 100 RU. The reference wild-type KD (0.157 nM) reflects the median value of the wild-type Fab heterodimer where the light chain contains a FLAG tag. The wild-type Fab heterodimers (containing either the FLAG or HA tag) exhibited similar KD values, such that a 2.6 fold difference was observed between the maximum and minimum values. In Tables 12, 13b and 14b, the difference in KD with respect to wild type antigen binding affinity is shown using the calculation  $-(\log(\text{KD})_{\text{design}} - \log(\text{KD})_{\text{wt}})$ , such that positive values indicate lower KD values whereas negative values indicate increased KD values of the Fab heterodimer compared with wild type binding affinity for antigen. Note that some Fab heterodimers lack measured KD values. In some of these cases, the Fab heterodimers were assessed but the SPR experiments exhibited low Fab heterodimer capture (i.e. less than 100 RU), and therefore accurate determinations of KD values were not possible. For those Fab heterodimers that exhibit similarity to other Fab heterodimers (i.e. differ only in the presence/absence or identity of the attached L chain tag (HA or FLAG)), estimated KD values are provided instead (as noted in Table 12, 13b and 14b), corresponding to the KD values from the similar Fab heterodimers. The corresponding estimated wild-type KD value (0.15 nM) was the median value obtained from all wild-type Fab heterodimers constructs (i.e. Fab constructs containing HA tag or FLAG tag). Overall, the results indicate that the correctly paired heterodimers (from a design perspective) exhibit wild-type like binding affinity for antigen (within approximately 2.3 times of the reference wild-type affinity).

**Example 8. UltraPerformance liquid chromatography size exclusion chromatography (UPLC-SEC) profiles of wild-type tagged D3H44 heterodimers and preferentially paired heterodimers.**

[0258] Wild-type D3H44 heterodimers (one heavy chain and one light chain) with a C-terminus ABD2-His<sub>6</sub> tag on the heavy chain and an N-terminus tag (FLAG in one construct and HA in another construct) on the light chain were expressed and purified according to methods known in the art and similar to those described in Example 5. Preferentially or correctly paired heterodimers were individually scaled up and purified via His tag affinity purification as described in Example 5.

[0259] UPLC-SEC was performed using a Waters BEH200 SEC column (2.5 mL, 4.6 x 150 mm, stainless steel, 1.7 µm particles) set to 30°C and mounted on a Waters Acquity UPLC system with a PDA detector. Run times consisted of 7 min and a total volume per injection of 2.8 mL with a running buffer of Hyclone DPBS/Modified -Calcium -Magnesium (part no. SH30028.02) at 0.4 ml/min. Elution was monitored by UV absorbance in the range 200-400 nm, and chromatograms were extracted at 280 nm. Peak integration was performed using Empower 3 software.

[0260] Figure 6 shows UPLC-SEC profiles for a representative WT Fab heterodimer pair (containing the FLAG tag on the L chain) as well as a representative (the H1L1 Fab component of LCCA designs 9735, 9737, and 9740) for the designed Fab heterodimer pairs. In general, the designed Fab heterodimer pairs exhibited similar UPLC-SEC profiles compared with WT.

**Example 9: Assessment of preferential pairing of heterodimers in co-expression sets comprising either constant domain or constant and variable domain modifications in a bi-specific antibody format**

[0261] The heterodimer designs were assessed to determine if they also allowed for preferential pairing in bi-specific antibody format. In this example, to promote heterodimerization of the unique heavy chains, the Fc region of the full-length heavy chain of each heterodimer was asymmetrically modified such that one heavy chain comprised the mutations T350V, L351Y, F405A and Y407V and the other heavy chain comprised the mutations T350V, T366L, K392L and T394W (EU numbering).

Preparation of constructs:

[0262] The heterodimer designs were tested in the context of the following bi-specific antibodies: a) D3H44/trastuzumab, b) D3H44/cetuximab, and c) trastuzumab/cetuximab. Note that D3H44 is a human antibody, trastuzumab is a humanized antibody and cetuximab is a chimeric antibody comprised of human IgG1 and mouse Fv regions. Constructs encoding the D3H44, trastuzumab and cetuximab IgG heavy and light chains comprising amino acid modifications according to the designs were prepared as follows. The base DNA sequences for the heavy and light chains of D3H44, trastuzumab and cetuximab are shown in Table 3C. The D3H44, trastuzumab and cetuximab light chain sequences were prepared as described in Example 3, except that some sequences lack a tag whereas other sequences contain a FLAG or HA tag. D3H44, trastuzumab and cetuximab heavy chain sequences were prepared as described in Example 3, except that full-length heavy chains were created by appending the IgG1\*01 DNA sequence encoding the hinge-CH2-CH3 domains and modified to promote heterodimerization, onto the C-terminus of the CH1 domain of the Fab heavy chains. Of note, the canonical C-terminal heavy chain lysine residue was removed in order to prevent LC-MS signal heterogeneity due to C-terminal lysine clipping (Lawrence W. Dick Jr. et al., *Biotechnol. Bioeng.* (2008) 100:1132-43).

Assay format (SMCA)

[0263] The ability of the heterodimer co-expression set designs to preferentially pair to form a bi-specific antibody was assessed as described below. The assay is based on co-expressing the four chains (H1 and L1 chains from one antibody with the H2 and L2 chains from the other antibody) and detecting the presence of correctly formed bispecific antibody using mass spectrometry (LC-MS). Figure 8 provides a schematic depicting the four starting polypeptide chains and the potential products resulting from co-expression of these starting polypeptide chains in the absence of preferential pairing between heavy and light chains of the heterodimer pairs. Two full-length heavy chain constructs were co-expressed with two unique light chain constructs, yielding ten possible antibody species: H1-L1:H1-L1, H1-L2:H1-L2, H1-L1:H1-L2, H2-L1:H2-L1, H2-L2:H2-L2, H2-L1:H2-L2, H1-L1:H2-L1, H1-L2:H2-L2, H1-L2:H2-L1 and H1-L1:H2-L2. The H1-L1:H2-L2 species is the correctly paired bispecific antibody (see Figure 8). The relative pairing specificity in terms of amount of preferred species H1-L1:H2-L2 vs. others was determined using LC-MS after pA purification and deglycosylation. When possible,

chains were left untagged, provided all Mab and half-Ab species differed from each other by at least 50 Da. When mass differences precluded this possibility, N-terminal tags (HA or FLAG) were added to the light chains in order to provide sufficient mass differentiation between species.

[0264] This assay, involving the expression and screening steps of a bispecific antibody, is referred to as SMCA.

#### Mass Spectrometry method

[0265] The degree of preferential D3H44 light chain pairing to D3H44 heavy chain in co-expression sets was assessed using mass spectrometry after protein A purification and non-denaturing deglycosylation. As the D3H44/trastuzumab heterodimers contained Fc N-linked glycans only, this system was treated with only one enzyme, N-glycosidase F (PNGase-F). The purified samples were de-glycosylated with PNGaseF as follows: 0.2U PNGaseF/ $\mu$ g of antibody in 50mM Tris-HCl pH 7.0, overnight incubation at 37°C, final protein concentration of 0.5 mg/mL. For the D3H44/cetuximab and the trastuzumab/cetuximab systems, due to the additional N-linked glycan in the Fab region of cetuximab, the systems were treated with N-glycosidase F plus a number of exoglycosidases. Typically, a four enzyme mixture was used for this purpose: N-glycosidase F,  $\beta$ -galactosidase (Prozyme),  $\beta$ -N-acetylglucosaminidase (New England Biolabs) and neuraminidase. N-glycosidase F removes the Fc N-linked glycans while the exoglycosidases trim the Fab N-linked glycans to a uniform core structure, M3F (GlcNAc<sub>2</sub>Man<sub>3</sub>Fuc<sub>1</sub>). The purified samples were de-glycosylated with the four enzyme mixture as follows: 0.2U PNGaseF/ $\mu$ g of antibody, 0.002U  $\alpha$ -Neuraminidase/ $\mu$ g of antibody, 0.0001U  $\beta$ -Galactosidase/ $\mu$ g of antibody and 0.2U  $\beta$ -N-Acetylglucosaminidase/ $\mu$ g of antibody in 50mM Tris-HCl pH 7.0, overnight incubation at 37°C, final protein concentration of 0.5 mg/mL. However, in some cases, a three enzyme treatment (N-glycosidase F,  $\beta$ -galactosidase and neuraminidase) was preferable in order to avoid mass overlaps of sample components in the LC-MS analysis. In these instances the Fab glycans were reduced to a slightly larger structure G0F (Man<sub>3</sub>GlcNAc<sub>2</sub>Fuc<sub>1</sub>GlcNAc<sub>2</sub>). The purified samples were de-glycosylated with the three enzyme mixture using the same concentrations and conditions as described for the four enzyme mixture. After deglycosylation, the samples were stored at 4 °C prior to LC-MS analysis.

[0266] The deglycosylated protein samples were analyzed by intact LC-MS using an Agilent 1100 HPLC system coupled to an LTQ-Orbitrap XL mass spectrometer (ThermoFisher

Scientific) via an Ion Max electrospray ion source (ThermoFisher). The samples (5  $\mu$ g) were injected onto a 2.1 x 30 mm Poros R2 reverse phase column (Applied Biosystems) and resolved using the following gradient conditions: 0-3 min: 20% solvent B; 3-6 min: 20-90% solvent B; 6-7 min: 90-20% Solvent B; 7-9 min: 20% solvent B. Solvent A was degassed 0.1% formic acid aq. and solvent B was degassed acetonitrile. The flow rate was 3 mL/min. The flow was split post-column to direct 100 $\mu$ L into the electrospray interface. The column was heated to 82.5  $^{\circ}$ C and solvents were heated pre-column to 80  $^{\circ}$ C to improve protein peak shape. The LTQ-Orbitrap XL was calibrated using ThermoFisher Scientific's LTQ Positive Ion ESI calibration solution (caffeine, MRFA and Ultramark 1621), and tuned using a 10 mg/mL solutions of CsI. The cone voltage (source fragmentation setting) was 40 V, the FT resolution was 7,500 and the scan range was m/z 400-4,000. The LTQ-Orbitrap XL was tuned for optimal detection of larger proteins (>50 kDa).

[0267] The ranges containing the multiply charged ions from from the full-sized antibodies (m/z 2000-3800) and the half-antibodies (m/z 1400-2000) were separately deconvoluted into molecular weight profiles using MaxEnt 1 module of MassLynx, the instrument control and data analysis software (Waters). Briefly, the raw protein LC-MS data were first opened in QualBrower, the spectrum viewing module of Xcalibur (Thermo Scientific) and converted to be compatible with MassLynx using Databridge, a file conversion program provided by Waters. The converted protein spectra were viewed in the Spectrum module of MassLynx and deconvoluted using MaxEnt 1. The abundances of the different antibody species in each sample were determined directly from the resulting molecular weight profiles.

#### Representative Designs for the SMCA assay

[0268] A total of 25 representative designs with high average LCCA performance values were selected from clusters 1 through 12 for testing in SMCA format. Representative designs were chosen based on the corresponding designs sets occupying similar space, using similar drivers while also sharing similar mutations. At least one representative design was chosen from each cluster. Some clusters were represented by one representative design (i.e. clusters 1, 5, 7, 8, 10). The remaining clusters had more than one representative design as the clusters were either large (i.e. cluster 2) or were comprised of minor clusters (i.e. clusters 3, 4, 6, 9, 11 and 12). Although the designs within each cluster shared sequence similarities, minor clusters within a



cluster differed in at least one set of driver mutations. For the clusters that were comprised of minor clusters, additional representative designs were chosen from each of the minor clusters.

[0269] The amino acid substitutions for each of the clusters are listed in Tables 15 through 27 and the corresponding representatives for each cluster/minor cluster are indicated. For cluster 1, only one design (9134-9521) was chosen to represent the cluster as these designs utilized similar electrostatic drivers occupying similar space (see Table 15). For all members of this cluster, H1 was designed to allow negatively charged substitutions (L124E and Q179E) to form salt bridges with L1 positively charged substitutions (S176R and either S131K or S131R). H2 was designed to allow for positively charged substitutions (L124R and either Q179K or S186K) to form salt bridges with L2 negatively charged substitutions (S176D and either T178D or T178E and/or T180E). Mismatched pairing of H1L2 and H2L1 would be disfavored primarily due to electrostatic repulsion.

[0270] For cluster 2, two representative designs (9279-9518 and 9286-9402) were chosen to represent the large cluster (see Table 16). The designs within this cluster utilized similar electrostatic drivers occupying similar space. For all members of this cluster, H1 was designed to allow negatively charged substitutions (L124E and L143E or L143D) to form salt bridges with L1 positively charged substitutions (S176R and a combination of either (Q124K and/or T178K) or (Q124K and Q160K)). H2 was designed to allow for positively charged substitutions (L124R and Q179K or S186K or S186R) to form salt bridges with L2 negatively charged substitutions (S176D and T178D or T178E and/or T180E). Mismatched pairing of H1L2 and H2L1 would be disfavored primarily due to electrostatic repulsion.

[0271] For cluster 3, five representative designs (9338-9748, 9815-9825, 6054-9327, 9066-9335 and 9121-9373) were chosen to represent each of the five minor clusters (see Table 17). All members of this cluster utilized similar electrostatic drivers on H1 (L124E), L1 (S176R), H2 (L124R), and L2 (S176D), which would allow for the formation of salt bridges in the preferentially paired heterodimers while the mismatched pairs would be disfavored primarily due to electrostatic repulsion. To represent those designs that utilized primarily those constant region drivers, the 6054-9327 design was chosen to represent this minor cluster. In addition to these electrostatic interactions, one minor cluster also comprised a variable region steric driver (H1 L45P and L1 P44F) and therefore a representative including this variable region driver was

chosen to represent this minor cluster (9338-9748). Another minor cluster also comprised variable region electrostatic drivers in both Fab heterodimers (H1 Q39E, L1 Q38R, H2 Q39R, L2 Q38E) and therefore a representative including this variable region driver was chosen to represent this minor cluster (9815-9825). Furthermore, one minor cluster comprised of one member and hence one representative design (9066-9335) includes an engineered disulfide between H1 F122C and L1 Q124C. The remaining minor cluster, represented by 9121-9373, utilized primarily the constant region drivers with additional substitutions H172T in H1 and S174R in L1 to slightly modify the interaction of the H1L1 constant region drivers, while also probing the effect of H172R in HC2.

[0272] For cluster 4, two representative designs (9168-9342 and 9118-6098) were chosen to represent each of the two minor clusters (see Table 18). All members of this cluster utilized similar electrostatic drivers on H1 (L124E), L1 (S176R or S176K), H2 (L124R), and L2 (S176D), which would allow for the formation of salt bridges in the preferentially paired heterodimers while the mismatched pairs would be disfavored primarily due to electrostatic repulsion. One minor cluster, represented by 9118-6098, primarily utilized the shared electrostatic drivers for preferential pairing whereas the other minor cluster represented by 9168-9342, further utilized substitutions from H1 (K228D) and L1 (S121K) that would allow for the formation of an additional salt bridge.

[0273] Cluster 5, represented by unique identifier 9116-9349, is comprised of only 1 member (see Table 19). This design utilized both electrostatic drivers on H1 (L124E), L1 (S176R), H2 (L124R) and L2 (S176D) as well as steric drivers on H1 (A139W), L1 (F116A\_V133G\_L135V), H2 (A139G\_V190A) and L2 (V133G\_L135W). As a result, for the preferentially paired heterodimers, the charged substitutions would allow for the formation of salt bridges. As for the mispaired Fab heterodimers, the formation would be disfavoured due to electrostatic repulsion as well as additional steric effects.

[0274] For cluster 6, two representative designs were chosen to represent each of the two minor clusters (see Table 20). All members of this cluster utilized similar electrostatic drivers in the constant region (Q179E on H1, S131K on L1, S186R on H2, and Q124E, Q160E, and T180E on L2) which would allow for the formation of salt bridges in the preferentially paired heterodimers while the mismatched pairs would be disfavored primarily due to electrostatic repulsion. In addition, the minor clusters also were comprised of different variable region

drivers. One minor cluster, represented by unique identifier 9814-9828, utilized the electrostatic drivers in the variable regions (Q39E on H1, Q38R on L1, Q39R on H2, and Q38E on L2). The other minor cluster utilized a variable region steric driver comprised of L45P in H1 and P44F in L1. As a result, for this minor cluster, the mismatched pairs would be further disfavored due to the introduced steric effects. Note that this minor cluster is represented by a design derived from unique identifier 9745-9075, which differs only in the absence of Q38E on L2.

[0275] For cluster 7, only one design (9060-9756) was chosen to represent the cluster as these designs utilized similar electrostatic and steric drivers (see Table 21). Shared electrostatic drivers comprised L143E and Q179E on H1, Q124R on L1, Q179K on H2, and Q124E, Q160E, and T180E on L2. Shared steric drivers comprised A139W on H1, F116A\_L135V on L1, and L135W on L2. As a result, for the preferentially paired heterodimers, the charged substitutions in the Fab regions would allow for the formation of salt bridges. As for the mispaired heterodimers, the formation would be disfavoured due to electrostatic repulsion as well as additional steric effects.

[0276] For cluster 8, only one design (9820-9823) was chosen to represent the cluster as these designs utilized similar electrostatic drivers (see Table 22). In the variable region, Q39E on H1, Q38R on L1, Q39R on H2, and Q38E on L2 were utilized. In the constant region, L143E on H1, Q124R, Q160K and T178R on L1, Q179K on H2, and Q124E, Q160E and T180E on L2 were utilized. For the preferentially paired heterodimers, the charged substitutions in the Fab regions would allow for the formation of salt bridges whereas for the mispaired heterodimers, the formation would be disfavoured primarily due to electrostatic repulsion.

[0277] For cluster 9, two representative designs were chosen to represent each of the two minor clusters (see Table 23). All members of this cluster utilized similar electrostatic drivers in the constant region (L143E on H1, Q124R on L1, Q179K on H2, and Q124E, Q160E, and T180E on L2) which would allow for the formation of salt bridges in the preferentially paired heterodimers while the mismatched pairs would be disfavored primarily due to electrostatic repulsion. In addition, the minor clusters differ in the presence/absence of a variable region driver (L45P on H1, and P44F on L1). As a result, for the minor cluster comprising the variable region driver, the mismatched pairs would be further disfavored due to the introduced steric effects. The representative design for this minor cluster comprising the variable region driver was derived from the unique identifier 9751-9065, which differs only in the absence of Q38E on

L2. The representative design for the minor cluster lacking the variable region substitutions is 9611-9077.

[0278] For cluster 10, only one design (9561-9095) was chosen to represent the cluster as these designs utilized similar electrostatic and steric drivers occupying similar space (see Table 24). The shared electrostatic drivers comprised L143E and Q179E on H1, similarly located Q124R, Q124K or S131K on L1, Q179K on H2, and Q124E and T180E on L2. The shared steric drivers comprised L124W on H1, V133A on L1, and V133W on L2. As a result, for the preferentially paired heterodimers, the charged substitutions in the Fab regions would allow for the formation of salt bridges. As for the mispaired heterodimers, the formation would be disfavoured due to electrostatic repulsion as well as additional steric effects.

[0279] For cluster 11, three designs (9049-9759, 9682-9740 and 9667-9830) were chosen to represent each of the three minor clusters (see Table 25). All members of this cluster utilized electrostatic substitutions to drive preferential pairing of heterodimers. As a result, for the preferentially paired heterodimers, the charged substitutions in the Fab regions would allow for the formation of salt bridges. As for the mispaired heterodimers, the formation would be disfavoured primarily due to electrostatic repulsion. For the minor cluster represented by unique identifier 9667-9830, the shared substitutions comprised negatively charged substitutions (L143E or L143D and Q179E or Q179D) on H1, positively charged substitutions on (T178R or T178K) L1, positively charged substitutions (S186K or S186R or Q179K or Q179R) on H2 and negatively charged substitutions (Q124E) on L2. Another minor cluster, represented by the sole member of this minor cluster (unique identifier 9049-9759), additionally contained substitutions for the formation of an engineered disulfide bond. The remaining cluster, represented by unique identifier 9682-9740, utilized similar drivers for H1 and L1 as the other two minor clusters; however, different constant region H2 and L2 drivers were utilized. H2 utilized L143R or L143K and L2, in addition to the Q124E substitution (shared with the other two minor clusters), utilized V133E or V133D.

[0280] For cluster 12, four designs (9696-9848, 9986-9978, 9692-9846 and 9587-9735) were chosen to represent each of the four minor clusters (see Table 26). All members of this cluster utilized electrostatic substitutions to drive preferential pairing of heterodimers. Some members additionally utilized steric drivers. The minor cluster represented by the unique identifier 9696-9848, utilized both electrostatic and steric drivers. The shared electrostatic substitutions within

this minor cluster comprised of L143E on H1, Q124R and T178R on L1, similarly located S186K or S186R or Q179K or Q179R on H2, and Q124E and T180E on L2. The shared steric substitutions within this minor cluster comprised of S188L on H1, and either S176L or V133Y or V133W on L2; for designs that utilized V133Y or V133W on L2, either L143A or L124A was also present on H2 to accommodate the bulky mutations. For the minor cluster represented by the unique identifier 9692-9846, similar electrostatic drivers were utilized compared with the minor cluster represented by the unique identifier 9696-9848; for some members, a similar located substitution, T178E, was utilized instead of T180E on L2. Furthermore, a subset from this minor cluster also utilized similar steric drivers, with a similarly located substitution of T178Y or T178F instead of S176L on L2. The minor cluster represented by the unique identifier 9986-9978 utilized only electrostatic drivers to drive preferential pairing. Similar shared substitutions were utilized for H1, L1 and H2; however, a different L2 substitution (S131E) was utilized. The remaining minor cluster, represented by the unique identifier 9587-9735, utilized similar electrostatic drivers on H1 and L1 (except that T178R on L1 was not utilized in all members within this minor cluster); however, different electrostatic drivers were utilized for H2 (L143R or L143K) and L2 (Q124E and V133E or Q124E and V133D). A couple of members within this minor cluster also utilized similar steric drivers comprised of S188L on H1 and S176L on L2. Overall, for the preferentially paired heterodimers, the charged substitutions in the Fab regions would allow for the formation of salt bridges. As for the mispaired heterodimers, the formation would be disfavoured due to electrostatic repulsion. Furthermore, for the designs that also utilized steric drivers, the formation would be additionally disfavoured due to steric effects. Cluster 13 is comprised of one member, 9122-9371 (see Table 27). This design utilized an engineered disulfide between H1 F122C and L1 Q124C as a covalent driver for preferential pairing of heterodimers. In addition, since the design also lacked the natural interchain disulfide, the formation of the disulfide bond was confirmed by non-reducing and reducing SDS-PAGE gel. This design was not tested in SMCA format; however, the engineered disulfide was tested in the presence of the natural interchain disulfide and in combination with additional constant region drivers (cluster 3, representative design 9066-9335).

#### Transfection method

[0281] Co-expression sets comprising two heavy chains and two light chain constructs were transfected into CHO-3E7 cells as follows. CHO-3E7 cells, at a density of  $1.7 - 2 \times 10^6$  cells/ml,

were cultured at 37°C in FreeStyle(TM) F17 medium (Invitrogen cat# A-1383501) supplemented with 4 mM glutamine and 0.1% Pluronic F-68 (Invitrogen cat# 24040-032). A total volume of 50 ml were transfected with a total of 50 ug DNA using PEI-pro (Polyplus cat# 115-010) at a DNA:PEI ratio of 1:2.5. Twenty-four hours after the addition of the DNA-PEI mixture, the cells were transferred to 32°C and incubated for 7 days prior to harvesting. Culture media was harvested by centrifugation and vacuum filtered using a Steriflip 0.2 µM filter. The filtered culture media was then purified using protein A MabSelect SuRe resin (GE Healthcare #17-5438-02) as follows. The filtered culture media was applied to a column (Hyclone DPBS/modified, No Calcium, No Magnesium, # SH-300028.02) that was previously equilibrated with PBS. The heterodimeric antibody species was then washed with PBS and eluted with 100 mM citrate pH 3.6 in an Amicon ultra 15 centrifuge filter Ultracel 10K (Millipore # SCGP00525). The buffer was then exchanged with PBS and the samples were assessed by caliper prior to deglycosylation and LC-MS.

[0282] To assess bispecific system biases inherent in the wild-type bispecific Ab systems, where the light chain of one system preferentially binds the heavy chains of both Ab systems, a set of H1:H2:L1:L2 DNA ratios was then tested in CHO expressions. These ratios attempt to compensate for natural differences in expression levels and/or intrinsic pairing biases between heavy and light chains of the two different antibodies. For all of the bispecific Ab systems, biases were observed across all of the ratios tested (Figure 9). For the D3H44/trastuzumab system, a bias is observed towards trastuzumab i.e. the D3H44 heavy chain preferentially pairs with the Trastuzumab light chain (see Figure 9a). For the D3H44/cetuximab, a bias is observed towards Cetuximab i.e. the D3H44 heavy chain preferentially pairs with the cetuximab light chain (see Figure 9b). For the trastuzumab/cetuximab system, a bias is observed towards trastuzumab i.e. the cetuximab heavy chain preferentially pairs with the trastuzumab light chain (see Figure 9c).

[0283] For testing each of the 25 representative designs within each bispecific Ab system, the H1:H2:L1:L2 DNA ratios used were the ratios from the corresponding wild-type bispecific systems that yielded the most amount of bispecific Ab species while having a low amount of half Ab (see Tables 32a, b and c). For the D3H44/trastuzumab system, the ratio used was 15 (H1), 15 (H2), 53 (L1), 17 (L2), where H1 and L1 refer to D3H44 and H2 and L2 refer to trastuzumab. For the trastuzumab/cetuximab system, the ratio used was 15 (H1), 15 (H2), 17 (L1), 53 (L2)

where H1 and L1 refer to trastuzumab and H2 and L2 refer to cetuximab. For the D3H44/cetuximab system, the ratio used was 15 (H1), 15 (H2), 53 (L1), 17 (L2), where H1 and L1 refer to D3H44 and H2 and L2 refer to cetuximab.

[0284] Furthermore, the designs were tested in both orientations for the D3H44/cetuximab and trastuzumab/cetuximab bispecific systems, such that in one orientation, substitutions present on H1L1 and H2L2 were tested on antibody 1 (Ab1) and antibody 2 (Ab2), of the bispecific Ab system, respectively, and in the other “flipped” orientation, substitutions present on H1L1 and H2L2 were tested on Ab2 and Ab1, respectively (see Table 28 a and b). An “\_1” appended to the unique identifier indicates those designs where the heavy chain and associated light chain substitutions that gave the stronger LCCA preferential pairing result (see Table 13a) were placed on the antibody where the heavy chain competed weakly for its associated light chain compared with the light chain from the other antibody. An “\_2” appended to the unique identifier indicates the opposite “flipped” orientation where the heavy chain and associated light chain substitutions that gave the stronger LCCA preferential pairing result (see Table 13a) were placed on the antibody where the heavy chain competed more strongly for its associated light chain compared with the light chain from the other antibody. For the D3H44/trastuzumab system, designs were tested only in the “\_1” orientation (see Table 28c).

#### SMCA results

[0285] The D3H44/trastuzumab system was treated with only one enzyme (PNGase-F) and was fully deglycosylated. For the multi-enzyme treatment, the attached sugars in the Fab region were generally truncated to either a core M3F (using the four enzyme treatment) or G0F (using the 3 enzyme treatment). Overall, in most cases, the deglycosylation treatments resulted in the ability to identify all of the possible different species identified by LC-MS. In many cases, each species was represented by a single LC-MS peak. Exceptions include side peaks that likely also correspond to the desired bispecific species (possibly adducts or heterogeneity in the cleavage of leader peptides); however, due to the ambiguity of the side peaks, these side peaks were not considered in the contributions to the bispecific species. In addition, some designs within the D3H44/cetuximab (3519\_1, 3522\_1) and the trastuzumab/cetuximab (9748-9338\_1) systems required multiple peaks to account for a species due to the variability of the attached high

mannose. All of these designs introduced a glycosylation site in the cetuximab light chain. Note that in some cases, it was not possible to distinguish between some minor species (comprise less than 5% of all species) due to low mass separation between the species (i.e. less than 50 Da difference). Furthermore, the desired bispecific species, H1-L1\_H2-L2, cannot generally be distinguished experimentally on the basis of LC/MS from the mispaired type: H1-L2\_H2-L1. As such, when bispecific content is reported in the tables, it cannot be completely excluded that it does not contain this type of mispaired species. However, the very low content observed for species such as H1-L2\_H1-L2 and H2-L1\_H2-L1 as well as H1-L2 and H2-L1 half antibodies is indicative that only minor if any contamination of the bispecific species occurred.

[0286] The LC-MS data are presented in Tables 29a, 29b and 29c. For comparison, wild-type data is also presented in Tables 33a, 33b and 33c and is indicated by “NA” in the “SMCA unique identifier” column as well as in the “Cluster” column. All of the three bispecific wild-type systems exhibited skewed biases such that one light chain dominated binding to both heavy chains (see Tables 33 and Figure 9). Furthermore, at least in the in the trastuzumab/cetuximab system, tag placement also seemed to have a significant influence on H1L1 and H2L2 pairing. Therefore, to assess the effects of the designs on transferability and the percentage of the desired bispecific species vs wild-type, comparisons to the corresponding wild type bispecific construct at the same H1:H2:L1:L2 DNA ratio were conducted and reported in the “Change in % H1L1 Pairing (over all H1 species) with respect to wild type”, “Change in % H2L2 Pairing (over all H2 species) with respect to wild type” and “Change in % of H1:H2:L1:L2 with respect to wild type” (considering full sized antibody species only) columns (see Table 29). Note that for assessing either % H1L1 Pairing (over all H1 species) or % H2L2 Pairing (over all H2 species), all species are assessed for pairing in the Fab region. When the corresponding wild type bispecific construct was not assessed by SMCA, comparisons were made to a similar wild-type construct. The estimates are indicated by a “\*\*\*\*” next to the values reported. The similar wild type construct chosen for comparison was selected, as follows. To assess transferability, each wild type construct was represented by the SMCA experiment (conducted at the different ratios) that exhibited the highest “% H1L1 and % H2L2 Pairing (over all species)”. To assess effects of designs on the percentage of the desired bispecific species vs wild-type, each wild type construct was represented by the SMCA experiment (conducted at the different ratios) that exhibited the highest % of H1:H2:L1:L2 (considering full sized antibody species only). For both cases, out of



all of the wild type constructs within the bispecific system, the median values were then chosen as the wild-type values for comparison.

[0287] For each design, transferability was assessed by noting increases in the overall H:L pairing across all species with respect to WT, specifically in the %H1L1/all H1 species and/or %H2L2/all H2 species. In addition, the effects on the percentage of the desired bispecific species were also assessed, with an emphasis on the full sized antibody species only comparison, as half antibodies, if present, may be removed/minimized by preparative SEC or through further H1:H2:L1:L2 DNA titrations. Tables 30 a, b and c show that preparative SEC can be effective in the removal/minimization of half Ab species. Tables 32 a, b and c show that the percentage of half Ab species can also be manipulated during transfection using various DNA titration ratios.

[0288] For the D3H44/cetuximab system (Table 29a), all except one design (9327-6054\_2) transferred as assessed by H1L1 pairing across all species with respect to wild-type. The majority of the designs (except for 9327-6054\_2 and 9134-9521\_2) also exhibited increased percentage of the desired bispecific antibodies when considering full Ab species only. Furthermore, except for the one design that did not transfer (9327-6054\_2), the designs decreased the primary mispaired antibody species (H1H2L2L2) observed for the wild-type. In addition, except for 9327-6054\_2 and the corresponding design 9327-6054\_1 in the other orientation, the designs transferred in both orientations, with the majority of the designs showing similar effective H:L pairing in both orientations.

[0289] For the D3H44/trastuzumab system (Table 29b), all designs transferred as assessed by H1L1 pairing across all species with respect to wild-type. In addition, all of the designs exhibited increased percentage of the desired bispecific antibodies (when considering full Ab species only). Furthermore, most of the designs significantly decreased the primary mispaired antibody species (H1H2L2L2) observed for the wild-type. Note however, that no data was reported for 9611-9077\_1 (table 28c), due to lack of expression.

[0290] As for the trastuzumab/cetuximab system (Table 29c), at least 35 out of 49 designs showed transferability as assessed by H2L2 pairing across all H2 species (positive values in the "Change in % H2L2 Pairing (over all H2 species) with respect to wild type" column). The designs that did not seem to transfer include 9279-9518\_2, 3522\_2, 9815-9825\_2, 9327-6054\_2,

9118-6098\_\_2, 9748-9338\_\_2, 9692-9846\_\_2, 9587-9735\_\_2, 9814-9828\_\_2, 3519\_\_2, 9986-9978\_\_2, 9168-9342\_\_2 and 9066-9335\_\_1 (negative values in the “Change in % H2L2 Pairing (over all H2 species) with respect to wild type” column); however, the designs in the other orientation did exhibit transferability (note that 9279-9518\_\_1 was not tested due to lack of sample). All of the designs that exhibited transferability exhibited decreased percentage of the primary mispaired antibody species (H1H2L1L1) that was observed in the wild-type experiments. In addition, of the designs that transferred, only 2 designs (9134-9521\_\_1 and 9279-9518\_\_2) showed decreased percentages of the desired bispecific Ab when considering the full antibody species only, compared with wild-type.

[0291] In general, most of the designs that increased the H:L pairing of the weaker competing antibody resulted in the increased percentage of the desired bispecific antibodies (considering full sized antibodies only). As for orientation, most designs in the “\_\_1” orientation exhibited either similar or better transferability comparing the H:L pairing compared with the “\_\_2” orientations (with exceptions being primarily observed in the trastuzumab/cetuximab system). Furthermore, table 35a lists those designs that transferred in both orientations across all 3 tested bispecific systems (D3H44/cetuximab, D3H44/trastuzumab, and trastuzumab/cetuximab). Table 35b lists those designs that transferred in one orientation across all 3 bispecific systems (D3H44/cetuximab, D3H44/trastuzumab, and trastuzumab/cetuximab) and transferred in the other orientation for only one bispecific system. In addition, in a specified orientation, the same mutations are present on the heavy chain and the weaker competing cognate light chain in all 3 bispecific systems, and light chain utilization is at least greater than 10%.

[0292] As for the transferability and performance of the clusters, for the D3H44/trastuzumab bispecific system, all of the members within all of the clusters exhibited transferability (see Figure 11a) and increased the percentage of the desired bispecific antibody (considering full sized antibodies only)(see Figure 11b). For the D3H44/cetuximab bispecific system, all clusters showed transferability, with only one member within cluster 3 that showed decreased H1L1 pairing over all H1 species, compared with wild-type (see Figure 11c). Also, all clusters included members that exhibited increases in the percentage of the desired bispecific antibody with respect to wild type (considering full sized antibodies only); however 3 clusters (clusters 1, 3 and 4) also include members that showed decreases in the percentage of the desired bispecific

antibody with respect to wild type (considering full sized antibodies only) (see Figure 11d). As for the trastuzumab/cetuximab bispecific system, all clusters include variants that exhibit design transferability; however, only a few clusters (1, 5, 7, 8, 10, 11) include variants where all of the respective members exhibited transferability (see Figure 11e). In addition, all clusters include members that exhibit increased percentage of the desired bispecific antibody with respect to wild type (considering full sized antibodies only) (see Figure 11f). For those clusters where all members showed transferability, all of the members within clusters 5, 7, 8, 10 and 11 also showed increases in the percentage of the desired bispecific antibody with respect to wild type (considering full sized antibodies only).

[0293] Overall, when considering all 3 bispecific systems altogether, all of the members within clusters 1, 5, 7, 8, 10, and 11 exhibited transferability (see Figure 11g); clusters 5, 7, 8, 10, and 11 comprised members where all members exhibited increases in the percentage of the desired bispecific antibody with respect to wild type (considering full sized antibodies only) (see Figure 11h).

[0294] Overall, most of the designs that increased the H:L pairing of the weaker competing antibody resulted in the increased percentage of the desired bispecific antibodies (considering full sized antibodies only). As for orientation, most designs in the “\_1” orientation exhibited either similar or better transferability comparing the H:L pairing compared with the “\_2” orientations (with exceptions being primarily observed in the trastuzumab/cetuximab system).

**Example 10: Preparative size exclusion chromatography (SEC) of selected SMCA bispecific heterodimeric antibodies and parental Mabs for biophysical characterization.**

[0295] A subset of the SMCA samples was selected for additional biophysical characterization. Most of these SMCA samples typically exhibited high pairing (greater than ~80% pairing in the H1L1+H2L2/all species column) and a low amount of half antibody species (less than ~30% considering all of the half antibody species). Preparative SEC was carried out as follows. Heterodimeric antibody samples were separated using a Superdex 200 10/300 GL (GE Healthcare) column mounted on a Pharmacia (GE Healthcare) ÄKTA *Purifier* system. Heterodimeric antibody samples (0.3-0.5 ml) in PBS (Hyclone DPBS/modified, No Calcium, No Magnesium, Cat no SH-300028.02) were manually loaded into a 0.5ml loop filled with PBS.

Samples were then automatically injected onto the column and resolved at 0.5ml/min with a 1 CV elution volume. Protein elution was monitored at OD<sub>280</sub> and collected in 0.5 ml fractions. For each SMCA sample, those fractions that comprised the main peak were pooled and further biophysically characterized.

**Example 11: Assessment of preferential pairing of bi-specific heterodimers in antibody format following preparative Size Exclusion Chromatography**

[0296] Following preparative SEC, selected samples were analyzed for preferential pairing of bi-specific heterodimeric antibodies using the LC-MS method as described in Example 9. All of these samples show enrichment in the percentage of the desired bispecific antibody species as well as decreases in the percentage of half antibody species (Tables 29 and 30).

**Example 12: Thermal stability of SMCA bispecific heterodimeric antibodies.**

[0297] Following preparative SEC, the thermal stability of selected SMCA bispecific heterodimeric antibodies was measured and compared with that of parental D3H44 and trastuzumab monoclonal antibodies as well as a cetuximab one armed antibody. In general, one-armed antibodies refer to constructs comprised of one full-length heavy chain, one truncated heavy chain lacking the Fab region (and incorporating a C233S substitution) and one light chain with heavy chain heterodimerization achieved as described in Example 9.

Measurement of thermal stability

[0298] The thermal stability of selected bispecific heterodimeric antibodies and wild-type controls was measured using differential scanning calorimetry (DSC) as follows. Following preparative SEC treatment, 400 µL samples primarily at concentrations of either 0.2 mg/ml or 0.4 mg/mL in PBS were used for DSC analysis with a VP-Capillary DSC (GE Healthcare). At the start of each DSC run, 5 buffer blank injections were performed to stabilize the baseline, and a buffer injection was placed before each sample injection for referencing. Each sample was scanned from 20 to 100°C at a 60°C/hr rate, with low feedback, 8 sec filter, 5 min preTstat, and 70 psi nitrogen pressure. The resulting thermograms were referenced and analyzed using Origin 7 software.

[0299] The results are shown in Tables 31a, b and c. The Fab T<sub>m</sub> values reported in the tables for the wild-type were obtained for the homodimeric antibodies for D3H44 (79 °C) and

trastuzumab (81 °C) and for the one-armed antibody for cetuximab (72 °C). For the WT D3H44/cetuximab and trastuzumab/cetuximab heterodimeric antibodies, only 2 peaks corresponding to the Fab Tms are observed. Distinct peaks are not observed for CH2 (due to overlap with the cetuximab Fab) or CH3 (due to overlap with the Tm values of D3H44 and trastuzumab Fab). For the WT D3H44/trastuzumab heterodimeric antibody, as the Tm values of the two Fabs from D3H44 and trastuzumab are similar, the peak at 81 °C likely corresponds to both Fabs, while the peak at approximately 72 °C likely corresponds to CH2.

[0300] In Table 31a, b and c, only the Tm value(s) of the peak(s) corresponding to both Fabs were reported, unless otherwise indicated. Note also that for some heterodimeric samples, the protein concentration was low (below 0.4 mg/mL) leading to increased noise in the baseline. As a result, in the D3H44/trastuzumab system, some samples yielded DSC curves with low peak intensities, such that it was difficult to distinguish between the CH2 peak and a possibly destabilized Fab. In these cases, the Tm values at 70 to 72 °C are also reported (Table 31a). Overall, most of the heterodimeric antibodies exhibit thermal stabilities similar to the corresponding wild-type molecules (3 °C or less). Furthermore, most of the heterodimeric antibodies do not exhibit additional peaks to suggest significant destabilization of the CH2 or CH3 peaks. One exception includes the engineered heterodimeric antibody 9611-9077\_2 from the trastuzumab/cetuximab system that exhibits an additional peak at 60 °C, which may be due to CH2 destabilization.

### **Example 13: Antigen affinity measurements of bispecific heterodimeric antibodies**

[0301] The ability of the bispecific antibodies to bind the associated antigens was assessed in order to determine whether the amino acid substitutions had any effects on antigen binding. The antigen binding affinity was determined by SPR as follows.

#### SPR biosensor assays

[0302] EDC: *N*-ethyl-3-(3-dimethylaminopropyl) carbodiimide hydrochloride; NHS: *N*-Hydroxysuccinimide; SPR: surface plasmon resonance; EDTA : ethylenediaminetetraacetic acid; TF: tissue factor; EGFR ECD: epidermal growth factor receptor extracellular domain; Her2 ECD: human epithelial growth factor receptor 2 extracellular domain.

[0303] *SPR supplies.* Series S Sensor Chip CM5, Biacore amine coupling kit (NHS, EDC and 1 M ethanolamine), and 10mM sodium acetate buffers were purchased from GE Healthcare Life

Science (Mississauga, ON). Recombinant Her2 extracellular domain (ECD) protein was purchased from eBioscience (San Diego, CA). PBS running buffer with 1% Tween20 (PBST) was purchased from Teknova Inc. (Hollister, CA). Goat polyclonal anti-human Fc antibody was purchased from Jackson Immuno Research Laboratories Inc. (West Grove, PA). EDTA was purchased from Bioshop (Burlington, ON).

[0304] All surface plasmon resonance assays were carried out using a Biacore T200 Surface Plasmon Resonance instrument (GE Healthcare Life Science, (Mississauga, ON)) with PBST running buffer (with 0.5 M EDTA stock solution added to 3.4 mM final concentration) at a temperature of 25°C. The anti-human Fc capture surface was generated using a Series S Sensor Chip CM5 using the default parameters under the Immobilization Wizard in the Biacore T200 control software which was set to target 2000 resonance units (RUs). The screening of the antibody variants for binding to Her2 ECD, TF or EGFR ECD antigen targets occurred in two steps: an indirect capture of the antibody variants onto the anti-human Fc antibody flow cell surface followed by the injection of 5 concentrations of purified antigen for kinetic analysis using the single cycle kinetics methodology. Variants or controls for capture were injected at 1 µg/mL over individual flow cells for 60 s at a flow rate of 10 µL/min. In general, this resulted in a capture of approximately 50 to 100 RUs onto the anti-human Fc surface. The first flow cell was left empty to use as a blank control. This capture step was immediately followed by five concentrations of antigen (either 5 nM, 2.5 nM, 1.25 nM, 0.63 nM and 0.31 nM for TF or EGFR ECD antigens, or 40 nM, 20 nM, 10 nM, 5 nM, and 2.5 nM for Her2 ECD antigen) that were sequentially injected over all of the four flow cells at 100 µL/min for 180 s with a dissociation phase of 300 s for EGFR ECD, 1800 s for Her2 ECD, and 3600 s for TF. The captured antibody surfaces were regenerated by 10 mM Glycine pH 1.5 for 120s at 30µL/min to prepare for the next injection cycle. At least two mock-buffer injections were performed for each analyte injection to be used for referencing. The resulting single cycle kinetics sensorgrams were analyzed using Biacore T200 BiaEvaluation software and were fit to the 1:1 binding model.

[0305] Antigen affinities of the heterodimeric antibodies were assessed with reference to the respective wild-type controls: Mab for D3H44, trastuzumab OAA and cetuximab OAA. Antigen affinities were also obtained for the wild-type bispecific antibodies; however, SPR capture of the WT bispecifics can be heterogeneous (e.g. involving capture of mispaired heterodimers), thereby

interfering with KD determination (see Table 31a and c). For the heterodimeric antibodies that had antigen binding measured in the D3H44/cetuximab system, antigen affinities were similar to the corresponding WT controls (see Table 31b). For most of the heterodimeric antibodies that had antigen binding measured in both the D3H44/trastuzumab and trastuzumab/cetuximab systems, antigen affinities were similar to the corresponding WT controls (see Tables 31a and c). Exceptions include eleven engineered antibodies that did not exhibit Her2 binding. In both of the D3H44/trastuzumab and trastuzumab/cetuximab systems, her2 binding was not observed for six engineered heterodimeric antibodies, 9049-9759\_\_1 and 9682-9740\_\_1 and 3522\_\_1. Furthermore, for the trastuzumab/cetuximab system, five additional engineered antibodies, 9696-9848\_\_1, 9561-9095\_\_2, 9611-9077\_\_2, 9286-9402\_\_2 and 9060-9756\_\_2 also lacked binding to Her2. Ten of these eleven engineered antibodies shared constant region mutations on the H chain (L143E\_K145T) and L chain (Q124R\_T178R). The other engineered antibody 9286-9402\_\_2 shared the same constant region mutations on the H chain (L143E\_K145T) and similar mutations on the L chain (Q124K and S176R).

**Example 14: UltraPerformance liquid chromatography size exclusion chromatography (UPLC-SEC) profiles of engineered heterodimeric antibodies as well as wild-type heterodimeric and homodimeric antibodies**

[0306] Following preparative SEC of the engineered heterodimeric antibodies as well as the control wild-type bispecific and homodimeric antibodies, UPLC-SEC was performed using a Waters BEH200 SEC column (2.5 mL, 4.6 x 150 mm, stainless steel, 1.7 µm particles) set to 30°C and mounted on a Waters Acquity UPLC system with a PDA detector. Run times consisted of 7 min and a total volume per injection of 2.8 mL with a running buffer of either PBS and 0.02% polysorbate 20 or 20 mM NaPO<sub>4</sub>, 50 mM KCl, 0.02% polysorbate 20, 10% acetonitrile, pH 7 at 0.4 ml/min. Elution was monitored by UV absorbance in the range 210-400 nm, and chromatograms were extracted at 280 nm. Peak integration was performed using Empower 3 software.

[0307] Figure 10 shows UPLC-SEC profiles for representatives of the engineered heterodimeric antibodies as well as representative WT heterodimeric antibodies. In most cases,

the engineered heterodimeric antibodies exhibited UPLC-SEC profiles similar to the corresponding WT heterodimeric antibodies, with average percentage of the monomers of 99.18 %, 98.70 % and 98.77 % for D3H44/trastuzumab, D3H44/cetuximab, and trastuzumab/cetuximab, respectively (see Tables 31a, 31b and 31c).

[0308] While the invention has been particularly shown and described with reference to a preferred embodiment and various alternate embodiments, it will be understood by persons skilled in the relevant art that various changes in form and details can be made therein without departing from the spirit and scope of the invention.

[00253] All references, issued patents, patent publications, and sequence accession numbers disclosed herein are hereby incorporated by reference in their entirety, for all purposes.



## TABLES

## Key for Tables

Table 1. Key criteria for Fab model

Table 2. Hotspot amino acid positions at the interface of the heavy and light chains in D3H44 (a typical Fab containing a kappa light chain).

Table 3A. Kabat numbering of the heavy chain amino acid sequences of D3H44, Trastuzumab, and Cetuximab

Table 3B. Kabat numbering of the light chain amino acid sequences of D3H44, Trastuzumab, and Cetuximab

Table 3C. Amino acid and DNA sequences of D3H44, Trastuzumab and Cetuximab

Table 4: LCCA designs with modifications to one immunoglobulin heavy chain and/or two immunoglobulin light chains, where H1 preferentially pairs with L1

Table 5. Design library

Table 6. Core Designs

Table 7. Example of a combination design

Table 8. Example of a modified/optimized design

Table 9. Example of a combination design including an optimized design

Table 10. Example of a combination design including an independent design

Table 11. H1:L1:L2 DNA ratios used for the light chain competition assays and verifications

Table 12. LCCA performance, stability and antigen binding assessments of the LCCA designs, arranged by decreasing DSF values of H1L1 Fab heterodimers

Table 13a. LCCA performance of the designs that met the LCCA average performance criteria of correctly paired: mispaired Fab heterodimers of 86:14

Table 13b. Stability and antigen binding assessments of the designs that met the LCCA average performance criteria of correctly paired: mispaired Fab heterodimers of 86:14

Table 14a. LCCA performance of the designs that performed below the LCCA average performance criteria of correctly paired: mispaired Fab heterodimers of 86:14

Table 14b. Stability and antigen binding assessments of the designs that performed below the LCCA average performance criteria of correctly paired: mispaired Fab heterodimers of 86:14

Table 15. Cluster 1 designs including the representative design

Table 16. Cluster 2 designs including representative designs

Table 17. Cluster 3 designs including representative designs

Table 18. Cluster 4 designs including representative designs

Table 19. Cluster 5 designs including the representative design

Table 20. Cluster 6 designs including representative designs

Table 21. Cluster 7 designs including the representative design

Table 22. Cluster 8 designs including the representative design

Table 23. Cluster 9 designs including representative designs

Table 24. Cluster 10 designs including representative designs

Table 25. Cluster 11 designs including representative designs

Table 26. Cluster 12 designs including representative designs

Table 27. Cluster 13 designs including representative designs

Table 28a. SMCA unique identifiers for the trastuzumab/cetuximab bispecific system

Table 28b. SMCA unique identifiers for the D3H44/cetuximab bispecific system

Table 28c. SMCA unique identifiers for the D3H44/trastuzumab bispecific system

Table 29a. LC-MS pairing data and post pA yields (mg/L) for the heterodimeric antibodies from the D3H44 (H1L1)/cetuximab (H2L2) bispecific system

Table 29b. LC-MS pairing data and post pA yields (mg/L) for the heterodimeric antibodies from the D3H44 (H1L1)/ trastuzumab (H2L2) bispecific system

Table 29c. LC-MS pairing data and post pA yields (mg/L) for the heterodimeric antibodies from the trastuzumab (H1L1)/ cetuximab (H2L2) bispecific system

Table 30a. LC-MS pairing of the heterodimeric antibodies from the D3H44 (H1L1)/cetuximab (H2L2) bispecific system following preparative SEC

Table 30b. LC-MS pairing of the heterodimeric antibodies from the D3H44 (H1L1)/ trastuzumab (H2L2) bispecific system following preparative SEC

Table 30c. LC-MS pairing of the heterodimeric antibodies from the trastuzumab (H1L1)/ cetuximab (H2L2) bispecific system following preparative SEC

Table 31a. Biophysical characterization (antigen binding, thermal stability, UPLC-SEC) of selected designs from the D3H44/trastuzumab system

Table 31b. Biophysical characterization (antigen binding, thermal stability, UPLC-SEC) of selected designs from the D3H44/cetuximab system

Table 31c. Biophysical characterization (antigen binding, thermal stability, UPLC-SEC) of selected designs from the trastuzumab/cetuximab system

Table 32a. Effect of DNA titration ratio on the percentage of antibody species, as assessed by LC-MS, of the wild-type D3H44/trastuzumab system. H1 and L1 refer to D3H44 heavy and light chains, respectively. H2 and L2 refer to trastuzumab heavy and light chains, respectively.

Table 32b. Effect of DNA titration ratio on the percentage of antibody species, as assessed by LC-MS, of the wild-type D3H44/cetuximab system. H1 and L1 refer to D3H44 heavy and light chains, respectively. H2 and L2 refer to cetuximab heavy and light chains, respectively.

Table 32c. Effect of DNA titration ratio on the percentage of antibody species, as assessed by LC-MS, of the wild-type trastuzumab/cetuximab system. H1 and L1 refer to trastuzumab heavy and light chains, respectively. H2 and L2 refer to cetuximab heavy and light chains, respectively.

Table 33a. LC-MS pairing for the wild type antibody constructs from the D3H44 (H1L1)/ cetuximab (H2L2) bispecific system

Table 33b. LC-MS pairing for the wild type antibody constructs from the D3H44 (H1L1)/ trastuzumab (H2L2) bispecific system

Table 33c. LC-MS pairing for the wild type antibody constructs from the trastuzumab (H1L1)/ cetuximab (H2L2) bispecific system

Table 34. Stabilizing mutations in Fab heterodimers

Table 35a. Designs that exhibited transferability across all 3 bispecific systems (D3H44/cetuximab, D3H44/trastuzumab, and trastuzumab/cetuximab) in both orientations.

Table 35b. Designs that exhibited transferability across all 3 bispecific systems (D3H44/cetuximab, D3H44/trastuzumab, and trastuzumab/cetuximab) in one orientation, and transferred in the other orientation for only one bispecific system, while also meeting the light chain utilization criteria of at least 10%.

Table 1: Key criteria for Fab model

Criteria	Importance
Human or humanized IgG1/ $\kappa$ Has commonly used V <sub>H</sub> and V <sub>L</sub> subgroups Framework close to germline V <sub>H</sub> :V <sub>L</sub> interdomain packing angle close to observed average for Fabs	Similarity
Structure available for apo- and complexed Fab No major structural changes observed upon binding antigen	Design
Antigen binding can be readily assayed	Assay

Table 2: Hotspot amino acid positions at the interface of the heavy and light chains in D3H44 (a typical Fab containing a kappa light chain).

Heavy*	Light*
V37	Y36
Q39	Q38
L45	P44
W47	L89
F100	F98
W103	F116
L124	F118
A139	V133
F174	L135

\* Kabat numbering

Table 3A. Kabat numbering of the heavy chain amino acid sequences of D3H44, Trastuzumab and Cetuximab

KABAT numbering	Table 3A			
	Heavy chain origin		Heavy chain origin	
	D3H44	TRASTUZUMAB	CETUXIMAB	CETUXIMAB
1	E	E	Q	Q
2	V	V	V	V
3	Q	Q	Q	Q
4	L	L	L	L
5	V	V	V	K
6	E	E	E	Q
7	S	S	S	S
8	G	G	G	G
9	G	G	G	P
10	G	G	G	G
11	L	L	L	L
12	V	V	V	V
13	Q	Q	Q	Q
14	P	P	P	P
15	G	G	G	S
16	G	G	G	Q
17	S	S	S	S
18	L	L	L	L
19	R	R	R	S
20	L	L	L	I
21	S	S	S	T
22	C	C	C	C
23	A	A	A	T
24	A	A	A	V
25	S	S	S	S
26	G	G	G	G
27	F	F	F	F
28	N	N	N	S
29	I	I	I	L
32	K	K	K	T
33	E	D	D	N
34	Y	T	T	Y
35	Y	Y	Y	G
35A	M	I	I	V
35B	H	H	H	H
36	W	W	W	W
37	V	V	V	V
38	R	R	R	R
39	Q	Q	Q	Q
40	A	A	A	S
41	P	P	P	P
42	G	G	G	G
43	K	K	K	K
44	G	G	G	G

KABAT numbering	Table 3A		
	Heavy chain origin		
	D3H44	TRASTUZUMAB	CETUXIMAB
67	A	F	L
68	T	T	S
69	I	I	I
70	S	S	N
71	A	A	K
72	D	D	D
73	N	T	N
74	S	S	S
75	K	K	K
76	N	N	S
77	T	T	Q
78	A	A	V
79	Y	Y	F
80	L	L	F
81	Q	Q	K
82	M	M	M
82A	N	N	N
82B	S	S	S
82C	L	L	L
83	R	R	Q
84	A	A	S
85	E	E	N
86	D	D	D

KABAT numbering	Table 3A		
	Heavy chain origin		
	D3H44	TRASTUZUMAB	CETUXIMAB
45	L	L	L
46	E	E	E
47	W	W	W
48	V	V	L
49	G	A	G
50	L	R	V
51	I	I	I
52	D	Y	W
52A	P	P	-
53	E	T	S
54	Q	N	G
55	G	G	G
56	N	Y	N
57	T	T	T
58	I	R	D
59	Y	Y	Y
60	D	A	N
61	P	D	T
62	K	S	P
63	F	V	F
64	Q	K	T
65	D	G	S
66	R	R	R

KABAT numbering	Table 3A			
	Heavy chain origin			
	D3H44	TRASTUZUMAB	CETUXIMAB	
107	T	T	T	T
108	L	L	L	L
109	V	V	V	V
110	T	T	T	T
111	V	V	V	V
112	S	S	S	S
113	S	S	S	A
114	A	A	A	A
115	S	S	S	S
116	T	T	T	T
117	K	K	K	K
118	G	G	G	G
119	P	P	P	P
120	S	S	S	S
121	V	V	V	V
122	F	F	F	F
123	P	P	P	P
124	L	L	L	L
125	A	A	A	A
126	P	P	P	P
127	S	S	S	S
128	S	S	S	S
129	K	K	K	K

KABAT numbering	Table 3A			
	Heavy chain origin			
	D3H44	TRASTUZUMAB	CETUXIMAB	
87	T	T	T	T
88	A	A	A	A
89	V	V	V	V
90	Y	Y	Y	Y
91	Y	Y	Y	Y
92	C	C	C	C
93	A	S	A	A
94	R	R	R	R
95	D	W	A	A
96	T	G	L	L
97	A	G	T	T
98	A	D	Y	Y
99	Y	G	Y	Y
100	F	F	D	D
100A		Y	Y	Y
100B		A	E	E
100C		M	F	F
101	D	D	A	A
102	Y	Y	Y	Y
103	W	W	W	W
104	G	G	G	G
105	Q	Q	Q	Q
106	G	G	G	G

Table 3A			
KABAT numbering	Heavy chain origin		
	D3H44	TRASTUZUMAB	CETUXIMAB
156	S	S	S
157	W	W	W
162	N	N	N
163	S	S	S
164	G	G	G
165	A	A	A
166	L	L	L
167	T	T	T
168	S	S	S
169	G	G	G
171	V	V	V
172	H	H	H
173	T	T	T
174	F	F	F
175	P	P	P
176	A	A	A
177	V	V	V
178	L	L	L
179	Q	Q	Q
180	S	S	S
182	S	S	S
183	G	G	G
184	L	L	L

Table 3A			
KABAT numbering	Heavy chain origin		
	D3H44	TRASTUZUMAB	CETUXIMAB
130	S	S	S
133	T	T	T
134	S	S	S
135	G	G	G
136	G	G	G
137	T	T	T
138	A	A	A
139	A	A	A
140	L	L	L
141	G	G	G
142	C	C	C
143	L	L	L
144	V	V	V
145	K	K	K
146	D	D	D
147	Y	Y	Y
148	F	F	F
149	P	P	P
150	E	E	E
151	P	P	P
152	V	V	V
153	T	T	T
154	V	V	V



Table 3A			
KABAT numbering	Heavy chain origin		
	D3H44	TRASTUZUMAB	CETUXIMAB
211	N	N	N
212	H	H	H
213	K	K	K
214	P	P	P
215	S	S	S
216	N	N	N
217	T	T	T
218	K	K	K
219	V	V	V
220	D	D	D
221	K	K	K
222	K	K	K
223	V	V	V
226	E	E	E
227	P	P	P
228	K	K	K
232	S	S	S
233	C	C	C
234	D	D	D
235	K	K	K
236	T	T	T
237	H	H	H
238	T	T	T

Table 3A			
KABAT numbering	Heavy chain origin		
	D3H44	TRASTUZUMAB	CETUXIMAB
185	Y	Y	Y
186	S	S	S
187	L	L	L
188	S	S	S
189	S	S	S
190	V	V	V
191	V	V	V
192	T	T	T
193	V	V	V
194	P	P	P
195	S	S	S
196	S	S	S
197	S	S	S
198	L	L	L
199	G	G	G
200	T	T	T
203	Q	Q	Q
205	T	T	T
206	Y	Y	Y
207	I	I	I
208	C	C	C
209	N	N	N
210	V	V	V

KABAT numbering	Table 3A		
	Heavy chain origin		
	D3H44	TRASTUZUMAB	CETUXIMAB
262	D	D	D
263	T	T	T
264	L	L	L
265	M	M	M
266	I	I	I
267	S	S	S
268	R	R	R
269	T	T	T
270	P	P	P
271	E	E	E
272	V	V	V
273	T	T	T
274	C	C	C
275	V	V	V
276	V	V	V
277	V	V	V
278	D	D	D
279	V	V	V
280	S	S	S
281	H	H	H
282	E	E	E
283	D	D	D
284	P	P	P

KABAT numbering	Table 3A		
	Heavy chain origin		
	D3H44	TRASTUZUMAB	CETUXIMAB
239	C	C	C
240	P	P	P
241	P	P	P
242	C	C	C
243	P	P	P
244	A	A	A
245	P	P	P
246	E	E	E
247	L	L	L
248	L	L	L
249	G	G	G
250	G	G	G
251	P	P	P
252	S	S	S
253	V	V	V
254	F	F	F
255	L	L	L
256	F	F	F
257	P	P	P
258	P	P	P
259	K	K	K
260	P	P	P
261	K	K	K

Table 3A			
KABAT numbering	Heavy chain origin		
	D3H44	TRASTUZUMAB	CETUXIMAB
312	Q	Q	Q
313	Y	Y	Y
314	N	N	N
317	S	S	S
318	T	T	T
319	Y	Y	Y
320	R	R	R
321	V	V	V
322	V	V	V
323	S	S	S
324	V	V	V
325	L	L	L
326	T	T	T
327	V	V	V
328	L	L	L
329	H	H	H
330	Q	Q	Q
331	D	D	D
332	W	W	W
333	L	L	L
334	N	N	N
335	G	G	G
336	K	K	K

Table 3A			
KABAT numbering	Heavy chain origin		
	D3H44	TRASTUZUMAB	CETUXIMAB
285	E	E	E
286	V	V	V
287	K	K	K
288	F	F	F
289	N	N	N
290	W	W	W
291	Y	Y	Y
292	V	V	V
295	D	D	D
296	G	G	G
299	V	V	V
300	E	E	E
301	V	V	V
302	H	H	H
303	N	N	N
304	A	A	A
305	K	K	K
306	T	T	T
307	K	K	K
308	P	P	P
309	R	R	R
310	E	E	E
311	E	E	E

KABAT numbering	Table 3A		
	Heavy chain origin		
	D3H44	TRASTUZUMAB	CETUXIMAB
361	G	G	G
363	Q	Q	Q
364	P	P	P
365	R	R	R
366	E	E	E
367	P	P	P
368	Q	Q	Q
369	V	V	V
370	Y	Y	Y
371	T	T	T
372	L	L	L
373	P	P	P
374	P	P	P
375	S	S	S
376	R	R	R
377	D	D	D
378	E	E	E
381	L	L	L
382	T	T	T
383	K	K	K
384	N	N	N
385	Q	Q	Q
386	V	V	V

KABAT numbering	Table 3A		
	Heavy chain origin		
	D3H44	TRASTUZUMAB	CETUXIMAB
337	E	E	E
338	Y	Y	Y
339	K	K	K
340	C	C	C
341	K	K	K
342	V	V	V
343	S	S	S
344	N	N	N
345	K	K	K
346	A	A	A
347	L	L	L
348	P	P	P
349	A	A	A
350	P	P	P
351	I	I	I
352	E	E	E
353	K	K	K
354	T	T	T
355	I	I	I
357	S	S	S
358	K	K	K
359	A	A	A
360	K	K	K

Table 3A			
KABAT numbering	Heavy chain origin		
	D3H44	TRASTUZUMAB	CETUXIMAB
415	P	P	P
416	E	E	E
417	N	N	N
418	N	N	N
419	Y	Y	Y
420	K	K	K
421	T	T	T
422	T	T	T
423	P	P	P
424	P	P	P
425	V	V	V
426	L	L	L
427	D	D	D
428	S	S	S
430	D	D	D
433	G	G	G
434	S	S	S
435	F	F	F
436	F	F	F
437	L	L	L
438	Y	Y	Y
439	S	S	S
440	K	K	K

Table 3A			
KABAT numbering	Heavy chain origin		
	D3H44	TRASTUZUMAB	CETUXIMAB
387	S	S	S
388	L	L	L
389	T	T	T
390	C	C	C
391	L	L	L
392	V	V	V
393	K	K	K
394	G	G	G
395	F	F	F
396	Y	Y	Y
397	P	P	P
398	S	S	S
399	D	D	D
400	I	I	I
401	A	A	A
402	V	V	V
405	E	E	E
406	W	W	W
407	E	E	E
408	S	S	S
410	N	N	N
411	G	G	G
414	Q	Q	Q

KABAT numbering	Table 3A		
	Heavy chain origin		
	D3H44	TRASTUZUMAB	CETUXIMAB
464	H	H	H
465	N	N	N
466	H	H	H
467	Y	Y	Y
468	T	T	T
469	Q	Q	Q
470	K	K	K
471	S	S	S
472	L	L	L
473	S	S	S
474	L	L	L
475	S	S	S
476	P	P	P
477	G	G	G

Variable regions: HFR1; 1 – 30, CDR-H1; 31 – 35, HFR2; 36 – 49, CDR-H2; 50 – 65, HFR3; 66 – 94, CDR-H3; 95 – 102, HFR4; 103 – 113 (Reference: Molecular Immunology, Volume 45, Issue 14, August 2008, Pages 3832–3839).

KABAT numbering	Table 3A		
	Heavy chain origin		
	D3H44	TRASTUZUMAB	CETUXIMAB
441	L	L	L
442	T	T	T
443	V	V	V
444	D	D	D
445	K	K	K
446	S	S	S
447	R	R	R
448	W	W	W
449	Q	Q	Q
450	Q	Q	Q
451	G	G	G
452	N	N	N
453	V	V	V
454	F	F	F
455	S	S	S
456	C	C	C
457	S	S	S
458	V	V	V
459	M	M	M
460	H	H	H
461	E	E	E
462	A	A	A
463	L	L	L

Table 3B. Kabat numbering of the light chain amino acid sequences of D3H44, Trastuzumab and Cetuximab

KABAT numbering	Table 3B		
	Light chain origin		
	D3H44	TRASTUZUMAB	CETUXIMAB
1	D	D	D
2	I	I	I
3	Q	Q	L
4	M	M	L
5	T	T	T
6	Q	Q	Q
7	S	S	S
8	P	P	P
9	S	S	V
10	S	S	I
11	L	L	L
12	S	S	S
13	A	A	V
14	S	S	S
15	V	V	P
16	G	G	G
17	D	D	E
18	R	R	R
19	V	V	V
20	T	T	S
21	I	I	F

KABAT numbering	Table 3B		
	Light chain origin		
	D3H44	TRASTUZUMAB	CETUXIMAB
22	T	T	S
23	C	C	C
24	R	R	R
25	A	A	A
26	S	S	S
27	R	Q	Q
28	D	D	S
29	I	V	I
30	K	N	G
31	S	T	T
32	Y	A	N
33	L	V	I
34	N	A	H
35	W	W	W
36	Y	Y	Y
37	Q	Q	Q
38	Q	Q	Q
39	K	K	R
40	P	P	T
41	G	G	N
42	K	K	G

Table 3B			
KABAT numbering	Light chain origin		
	D3H44	TRASTUZUMAB	CETUXIMAB
66	G	R	G
67	S	S	S
68	G	G	G
69	T	T	T
70	D	D	D
71	Y	F	F
72	T	T	T
73	L	L	L
74	T	T	S
75	I	I	I
76	S	S	N
77	S	S	S
78	L	L	V
79	Q	Q	E
80	P	P	S
81	E	E	E
82	D	D	D
83	F	F	I
84	A	A	A
85	T	T	D
86	Y	Y	Y
87	Y	Y	Y
88	C	C	C

Table 3B			
KABAT numbering	Light chain origin		
	D3H44	TRASTUZUMAB	CETUXIMAB
43	A	A	S
44	P	P	P
45	K	K	R
46	V	L	L
47	L	L	L
48	I	I	I
49	Y	Y	K
50	Y	S	Y
51	A	A	A
52	T	S	S
53	S	F	E
54	L	L	S
55	A	Y	I
56	E	S	S
57	G	G	G
58	V	V	I
59	P	P	P
60	S	S	S
61	R	R	R
62	F	F	F
63	S	S	S
64	G	G	G
65	S	S	S



Table 38			
KABAT numbering	Light chain origin		
	D3H44	TRASTUZUMAB	CETUXIMAB
112	A	A	A
113	P	P	P
114	S	S	S
115	V	V	V
116	F	F	F
117	I	I	I
118	F	F	F
119	P	P	P
120	P	P	P
121	S	S	S
122	D	D	D
123	E	E	E
124	Q	Q	Q
125	L	L	L
126	K	K	K
127	S	S	S
128	G	G	G
129	T	T	T
130	A	A	A
131	S	S	S
132	V	V	V
133	V	V	V
134	C	C	C

Table 38			
KABAT numbering	Light chain origin		
	D3H44	TRASTUZUMAB	CETUXIMAB
89	L	Q	Q
90	Q	Q	Q
91	H	H	N
92	G	Y	N
93	E	T	N
94	S	T	W
95	P	P	P
96	W	P	T
97	T	T	T
98	F	F	F
99	G	G	G
100	Q	Q	A
101	G	G	G
102	T	T	T
103	K	K	K
104	V	V	L
105	E	E	E
106	I	I	L
107	K	K	K
108	R	R	R
109	T	T	T
110	V	V	V
111	A	A	A

Table 38			
KABAT numbering	Light chain origin		
	D3H44	TRASTUZUMAB	CETUXIMAB
158	N	N	N
159	S	S	S
160	Q	Q	Q
161	E	E	E
162	S	S	S
163	V	V	V
164	T	T	T
165	E	E	E
166	Q	Q	Q
167	D	D	D
168	S	S	S
169	K	K	K
170	D	D	D
171	S	S	S
172	T	T	T
173	Y	Y	Y
174	S	S	S
175	L	L	L
176	S	S	S
177	S	S	S
178	T	T	T
179	L	L	L
180	T	T	T

Table 38			
KABAT numbering	Light chain origin		
	D3H44	TRASTUZUMAB	CETUXIMAB
135	L	L	L
136	L	L	L
137	N	N	N
138	N	N	N
139	F	F	F
140	Y	Y	Y
141	P	P	P
142	R	R	R
143	E	E	E
144	A	A	A
145	K	K	K
146	V	V	V
147	Q	Q	Q
148	W	W	W
149	K	K	K
150	V	V	V
151	D	D	D
152	N	N	N
153	A	A	A
154	L	L	L
155	Q	Q	Q
156	S	S	S
157	G	G	G

Table 3B			
KABAT numbering	Light chain origin		
	D3H44	TRASTUZUMAB	CETUXIMAB
204	P	P	P
205	V	V	V
206	T	T	T
207	K	K	K
208	S	S	S
209	F	F	F
210	N	N	N
211	R	R	R
212	G	G	G
213	E	E	E
214	C	C	C

**Variable regions:** LFR1; 1 – 23, CDR-L1; 24 – 34, LFR2; 35 – 49, CDR-L2; 50 – 56, LFR3; 57 – 88, CDR-L3; 89 – 97, LFR4; 98 – 110 (Reference: Molecular Immunology. Volume 45, issue 14, August 2008, Pages 3832–3839).

Table 3B			
KABAT numbering	Light chain origin		
	D3H44	TRASTUZUMAB	CETUXIMAB
181	L	L	L
182	S	S	S
183	K	K	K
184	A	A	A
185	D	D	D
186	Y	Y	Y
187	E	E	E
188	K	K	K
189	H	H	H
190	K	K	K
191	V	V	V
192	Y	Y	Y
193	A	A	A
194	C	C	C
195	E	E	E
196	V	V	V
197	T	T	T
198	H	H	H
199	Q	Q	Q
200	G	G	G
201	L	L	L
202	S	S	S
203	S	S	S

SEQ ID NO	DESCRIPTION	SEQUENCE
1	D3H44 light chain (Domain boundaries: VL; D1 - K107, CL: R108 - C214)	DIQMTQSPSSLSASVGRVITTCRASRDIKSYLNWYQKPKGAKPLVIYATSLAEGVPSRFSGSFGSDYTLTISSIQPE DFATYYCLOHGESPWTFGGGTVEIKRTVAAPSFPPSPDEQLKSGTASVCLLNINFPYPREAKVQWVKVDNALQSGN SQESVTEQDSKDYSLSLTSLKADYEKHKVYACEVTHQGLSSPVTKSFNRGEC
2	Trastuzumab light chain (Domain boundaries: VL; D1 - K107, CL: R108 - C214)	DIQMTQSPSSLSASVGRVITTCRASQDVNTAVAWYQKPKGAKPLIYSASFLYSGVPSRFSGSRSDFTLTISSIQPE EDFATYYCOQHYTTPFGGQTKVEIKRTVAAPSFVHPPSDEQLKSGTASVCLLNINFPYPREAKVQWVKVDNALQSGN SQESVTEQDSKDYSLSLTSLKADYEKHKVYACEVTHQGLSSPVTKSFNRGEC
3	Cetuximab light chain (Domain boundaries: VL; D1 - K107, CL: R108 - C214)	DIILITQSPVHLSVSPGERVFSFRASQSIGTNIHWYQQRNTGSPRLLIKVAESISGIPSRFSGSGSDFTLTISSVSESDIA DYVCQQNNWPTTFGAGTKLELKRVAAPSVFHPSPDEQLKSGTASVCLLNINFPYPREAKVQWVKVDNALQSGNSQ ESVTEQDSKDYSLSLTSLKADYERKHYVACEVTHQGLSSPVTKSFNRGEC
4	D3H44 heavy chain (Domain boundaries: VH; E1 - S117, CH3: A118 - V215, Hinge: E216 - P230, CH2: A231 - K340, CH3: G341 - G446)	EVQLVESGGGLVQPGRSLRLSCAASGFNIKEYHHWVRQAPGKGLWVLIDPEQGNITVDPKFEQDRATISADNSK NTAVLQMNISLRAEDTAVYCARDTAAFDYWGQGTLVTVSASTKGPSVFLPAPSSKTSGGTAALGLVKDYFPEPV TVSWNSGALTSVHTFPVAVLQSSGLYSLSVTVTPSSSLGTTQYICNVNHKPSNTKVDKKVEPKSCDKTHCTCPPEPE LLGGPSPVFLPPKPKDTLMISRTPEVTCVVVDVSHEDPEVFNWYVDGVEVFNHAKTKPRREEQYNSTYRVVSVLTVLHQ DWLNGKEYKCKVSNKALPAPIEKTIKAAGQPREPQVYTLPPSRDELTKNQVSLTCLVKGFYPSDIAVEWESNGQPEN NYKPTTPPVLDSGGSFYSLKLTVDKSRWQQGNVSCVSMHEALHNHYTQKSLSLSPG
5	Trastuzumab heavy chain (Domain boundaries: VH; E1 - S120, CH3: A121 - V218, Hinge: E219 - P233, CH2: A234 - K343, CH3: G344 - G449)	EVQLVESGGGLVQPGRSLRLSCAASGFNIKDTYHWVRQAPGKGLWVARIPTGTFRYADSVKGRFTISADTSKNT AYLQMNISLRAEDTAVYVYCSRWGSDGFYAMDYWGQGTLVTVSAASTKGPSVFLPAPSSKTSGGTAALGLVKDYFPP EPVTVSWNSGALTSVHTFPVAVLQSSGLYSLSVTVTPSSSLGTTQYICNVNHKPSNTKVDKKVEPKSCDKTHCTCPPE APELGGPSPVFLPPKPKDTLMISRTPEVTCVVVDVSHEDPEVFNWYVDGVEVFNHAKTKPRREEQYNSTYRVVSVLTV LHQDWLNGKEYKCKVSNKALPAPIEKTIKAAGQPREPQVYTLPPSRDELTKNQVSLTCLVKGFYPSDIAVEWESNGQ PENNYKPTTPPVLDSGGSFYSLKLTVDKSRWQQGNVSCVSMHEALHNHYTQKSLSLSPG
6	Cetuximab heavy chain (Domain boundaries: VH;Q1 - A119, CH1: A120 - V217, Hinge: E218 - P232, CH2: A233 - K342, CH3: G343-G448)	QVQLKQSGPQLVQPSQSITCTVSGFSLTINGVHWRQSPGKGLWLVGWISGGNTDYNTPHTRLSINIKDINSKQ VFFKMNSLQSNIDTAYICARALTYDYEFAVWYWGQGTLVTVSAASTKGPSVFLPAPSSKTSGGTAALGLVKDYFPEPV TVSWNSGALTSVHTFPVAVLQSSGLYSLSVTVTPSSSLGTTQYICNVNHKPSNTKVDKKVEPKSCDKTHCTCPPEPE LLGGPSPVFLPPKPKDTLMISRTPEVTCVVVDVSHEDPEVFNWYVDGVEVFNHAKTKPRREEQYNSTYRVVSVLTVLHQ DWLNGKEYKCKVSNKALPAPIEKTIKAAGQPREPQVYTLPPSRDELTKNQVSLTCLVKGFYPSDIAVEWESNGQPEN NYKPTTPPVLDSGGSFYSLKLTVDKSRWQQGNVSCVSMHEALHNHYTQKSLSLSPG
7	Trastuzumab_Heavy Chain	GAGGTGACGTGTGGAAAGCGGAGGAGACTGGTGACAGCCAGGAGGACTTCGCGACTGAGTTGCCCGCGCT CAGGATTCACACATCAAGGACACACTTCATCTGGGTGGCAGAGCTCCAGGAAAGGACTGGAGTGGTGGCT CGAATTCACCACTAATGGATACACCGGTATGCCACTTCGTAAGGGAGGATTTACTATATAGCCGCATACA TCCAAAACAACCTACTTACAGATGACAGCTCCGAGCGGAGCGGAGGACTGGTGTACTATTCAGTCCGATGG GGAGGAGAGGATTCACGCTATGGATTATGGGACAGGAGCCCTGGTGGACAGTGGCTCCGCTTACCAA GGGCCCATGTGTTCCCTGGCTCTACTAGTAATCCACTCTGGAGGACAGCGGCTGGGATGGTCTGGT GAAGACTATTTCCCGACCTGTGACCGTAGTGGAACTCAGGCGCCCTGACCAAGCGGAGTGGACACTTTTC TGCTGTGCTGACGCAAGCGGCTGTACTCTCTGCTGTCAGCTGCAAGTTCAAGCTCCAGGCAACAGGCTGTG GACTATATCTGCAAGCTGAATCAATAAGCCCTCAATACAAAAGTGGCAAGAAAGTGGAGCCCAAGAGCTGTG

<p>ATAAGACCACACCTGCTCCCTCCCTGTCAGCTCCAGAACTGCTGGAGGACCTAGCGTGTCTTCCCTTAA          GCCAAAGACACTTGAATTTCCAGGACTCCGAGGTGACTCGCTGGTGGTGGAGCTGCTCACAGGAC          CCGAAGTGAAGTTCAACTGACGTGGATGGCTGGAGTGCATAATGCTAAGACAAAACCAAGAGAGGAACA          GTAACCTCACTTATCGCTGTGAGCGTGTGACCGTGTGCAAGGACTGTAACGAGGAAAGAGGTATA          AGTGCAAAATCAGTAATAAGGCCCTGCTGCTCAATCGAAAACCAATCTTAAGGCCAAAGGCCAGCCAAAGG          GAGCCCAAGGTGACACACTGCCACCAGCAGAGAACAACTACCAAGAACCAAGGTGCTCCCTGACATGTGGT          GAAAGCTTCTCTAGTGAATAATGCTGGAGTGGAAATCAAAATGGACAGCCAGAGAACAAATACAGACCA          CACTCCAGTGTGGACAGCGATGGCAGCTTCTCTGTAATCCAAAGTACAGTGGATAAATCTCGATGCGACG          AGGGAAAGGTGTTAGTGTTCAGTATGCAATGCAATGCAATCTGCAAGAACCTGCTGCTCCCTGT          CTCGCGC</p>	<p>Trastuzumab_Light Chain</p>	<p>8</p>
<p>GACATCCAGATGACCCAGTCCCTCCCTGCTGCAATCTGTAGAGAGACAGAGATCACCACTACTTCCCGGCA          AGTCAGGAGCTTAAACCCCTGTAGCTTGGTATCAGCAGAAAACAGGAAAGCCCTAAGCTCTGATCTATTCT          GCATCTTTTGTACAGTGGGTCCTCAAGGTTCAAGTGGCAGTGGATCTGGACAGATTTCACTCTCACCATCA          GCAGTCTGCAACCTGAAGATTTGCACTTACTGTCAAGCAGATTAACAATACCCACCTTTCGGCCAAAGS          GACCAAGTGGAGATCAACAGAACTGGGCTGCACCATCTGCTCACTTCCCGCCATCTGATGACAGTTGAA          ATCTGAACTGCTCTGTTGCTGCTGTAATAACTTATCCAGAGAGGCCAAAAGTACAGTGGAAAGTGGAA          TAAGCCCTCAATCGGTAACCTCCCAAGAGAGTGTACAGAGCAGGACAGCAAGSACACCTACAGCCTCA          GCAGCACCTGTAGCAGTGAAGCAAGCAGACTAGCAGAAACACAAAAGTCTACGCTTSCGAAAGTACCCCATCAGGSC          CTGAGCTGCCCTCACAAAAGACTTCAACAGGGGAGAGTGT          CAGGTGCAGCTGAAACAGAGCGGCTCGGGCTGTGTGTCAGCCAGCCAGAGCTGAGCATTTACCTGCACCGTGA          GCGGCTTAGCTGACCAACTATGGCTGCAATGGTGGCCAGAGCCCGGCAAGGCTGGAAATGGCTGGG          CGTGATTTGGAGCGGGCAACCGGATTAACACCCCTTTACCAAGCCCTGAGGACTTAACAAAAGATAACAG          CAAAAGCCAGGTGTTTTAAATGAACAGCTGTCAGAGCAACGATACCCGGATTTATTTGGCCGCGCGCT          GACTATATGATATGAAATTTGGTATTGGGCGAGGCAACCCCTGGTACCCTGGAGCGCGGCGGAGCACC          GCGGAGCGTGTTCGGTGGCCGAGCAGCAAAAAGCAGCAGCGCGGCGGCGGCGCTGGGCTGGCTGGT          GAAAGATTTTCCGGAACCGTGGCCGAGTGGAGCAGCGGCGCTGAGCAGCGGCGGCTGGCTGATACCTTC          CGCGGTGCTGCAGAGCAGCGGCTGTATAGCCTGAGCAGCTGTTGACCGTCCGAGCAGAGCCTGGGCA          CAGACTATTTGCAACGTGAACATAAACCGAGCAACCAAAAGTGGATAAAAAGTGGAAACGAAAGACT          GCGATAAACCCATACCTCCCGCTGCCCCGGCCGGAAGCTGCTGGGGCCCGGAGGGTGTTCCTGTTCCGG          CGAAAACGAAAGTACCTGATGATAGCCGCAACCCGGAAGTACCTGCGGAGTGGTGGATGAGCCATGAA          GATCCGGAAGTGAATTAAGTGTGATGGATGGGTGGAGTGCATAACCGGAAACCAACCGCGGGAAG          AACAGTAAACAGTGAACCAAGCGCTGCGGCGCCGATTTGAAAAACCAATTAGCAAGGAAAGSCCAGC          CCGCGAACCGCAGGTGTATCCGAGCGATATGCGGTGGAAATGGGAAGCAACGCGCAGGAGGCTGACCTGC          CTGGTGAAGGCTTTATCCGAGCGATATGCGGTGGAAATGGGAAGCAACGCGCAGGCGGAAACAACTATA          AACACCCCGCGGTGCTGGATAGCGATGGCAGCTTTTCTGTATAGCAAACTGACCGTGGATAAAGCCGCTG          GCAGCAGGGCAACGTGTTAGCTGCAGCGTGTGATGAAGSCGCTGCATAACCATTAACCCAGAAAAGGCTGA          GCCTGAGCCCGGGC</p>	<p>Cetuximab_Heavy Chain</p>	<p>9</p>
<p>GACATCTGCTGACTCAGAGCCAGTGTCTGTAGTACAGCCAGGAGAGCGGGTCTCTCTTGCAGAGCA          AGTCAGTCAATCGGAAACAAATATCACTGGTACCAGAGAGACTAAGCGCTCCCTCGCTGATTAAGTAT          GCTAGCGAATCCATCTCTGGCAATCCATCTCGGTTCCAGTGGCTCAGGGAGCAAGACTTTACTCTGTCCTC          AATTCTGTGGAGTGAAGACATTTGGCGATTAATGGCCAGCAACAATAACTGCGCCACCACTTCGCGGCT</p>	<p>Cetuximab_Light Chain</p>	<p>10</p>



Table 4. LCCA designs with modifications to one immunoglobulin heavy chain and/or two immunoglobulin light chains, where H1 preferentially pairs with L1

Set #**	H1 mutation*	L1 mutation*	L2 mutation*
9567	L124W_L143F	V133A	V133W_S176T_T178L
9087	L124A_L143F	V133W_S176T_T178L	V133A
9570	L124W_L143F	V133G	V133W_S176T_T178L
9089	L124A_L143F	V133W_S176T_T178L	V133G
9569	L124W_L143F	V133A_S176T_T178L	V133W_S176T_T178L
9088	L124A_L143F	V133W_S176T_T178L	V133A_S176T_T178L
9566	L124W_L143F	V133A	V133W
9085	L124A_L143F	V133W	V133A
9568	L124W_L143F	V133A_S176T_T178L	V133W
9086	L124A_L143F	V133W	V133A_S176T_T178L
9572	L124W_L143F_K145T_Q179E	S131K_V133A_S176T_T178L	Q124E_V133W_S176T_T178L_T180E
9096	L124A_L143F_Q179K	Q124E_V133W_S176T_T178L_T180E	S131K_V133A_S176T_T178L
9571	L124W_L143F_K145T_Q179E	S131K_V133A_S176T_T178L	Q124E_V133W_S176T_T178E_T180E
9092	L124A_L143F_Q179K	Q124E_V133W_S176T_T178E_T180E	S131K_V133A_S176T_T178L
9564	L124W_L143E_K145T_Q179E	S131K_V133A_S176T_T178L	Q124E_V133W_S176T_T178L_T180E
9562	L124W_L143E_K145T_Q179E	S131K_V133A_S176T_T178L	Q124E_V133W_S176T_T178E_T180E
9561	L124W_L143E_K145T_Q179E	Q124R_V133A_S176T_T178R	Q124E_V133W_S176T_T178L_T180E
9095	L124A_L143F_Q179K	Q124E_V133W_S176T_T178L_T180E	Q124R_V133A_S176T_T178R
9560	L124W_L143E_K145T_Q179E	Q124R_V133A_S176T_T178R	Q124E_V133W_S176T_T178E_T180E
9091	L124A_L143F_Q179K	Q124E_V133W_S176T_T178E_T180E	Q124R_V133A_S176T_T178R
9559	L124W_L143E_K145T_Q179E	Q124K_V133A_S176T_T178R	Q124E_V133W_S176T_T178L_T180E
9094	L124A_L143F_Q179K	Q124E_V133W_S176T_T178L_T180E	Q124K_V133A_S176T_T178R
9558	L124W_L143E_K145T_Q179E	Q124K_V133A_S176T_T178R	Q124E_V133W_S176T_T178E_T180E
9090	L124A_L143F_Q179K	Q124E_V133W_S176T_T178E_T180E	Q124K_V133A_S176T_T178R
9099	L124A_Q179K	Q124E_V133W_S176T_T178L_T180E	S131K_V133A_S176T_T178L
9098	L124A_Q179K	Q124E_V133W_S176T_T178E_T180E	S131K_V133A_S176T_T178L
9110	L124E	V133G_S176R	V133G_S176D_T178Y
9341	L124R	V133G_S176D_T178Y	V133G_S176R
9104	L124E	S131T_V133G_S176R_T178Y	V133G_S176D
9336	L124R	V133G_S176D	S131T_V133G_S176R_T178Y
9105	L124E	S131T_V133G_S176R_T178Y	V133G_S176D_T178Y
9340	L124R	V133G_S176D_T178Y	S131T_V133G_S176R_T178Y
9106	L124E	V133G_S176K	V133G_S176D
9337	L124R	V133G_S176D	V133G_S176K
9107	L124E	V133G_S176K	V133G_S176D_T178D
9339	L124R	V133G_S176D_T178D	V133G_S176K
9109	L124E	V133G_S176R	S131E_V133G_S176D
9332	L124R	S131E_V133G_S176D	V133G_S176R
9108	L124E	V133G_S176K	S131E_V133G_S176D
9330	L124R	S131E_V133G_S176D	V133G_S176K
9326	L124E_L143F	V133G_S176R	V133G_S176D
6048	L124R	V133G_S176D	V133G_S176R
9327	L124E_L143F	V133G_S176R	V133G_S176D_T178D
6054	L124R	V133G_S176D_T178D	V133G_S176R
9328	L124E_L143F	V133G_S176R	S131E_V133G_S176D
9113	L124E_A125S_K228D	S121K_V133G_S176R	V133G_S176D
9342	L124R_A125R	V133G_S176D	S121K_V133G_S176R
9114	L124E_A125S_K228D	S121K_V133G_S176R	V133G_S176D_T178D
9344	L124R_A125R	V133G_S176D_T178D	S121K_V133G_S176R
9168	L124E_K228D	S121K_V133G_S176R	V133G_S176D
9169	L124E_K228D	S121K_V133G_S176R	V133G_S176D_T178D
9119	L124E_H172R	V133G_S176R	V133G_N137K_S174R_S176D
9375	L124R_H172T	V133G_N137K_S174R_S176D	V133G_S176R
9118	L124E_H172R	V133G_S176R	V133G_S174R_S176D
6098	L124R_H172T	V133G_S174R_S176D	V133G_S176R
9117	L124E_H172R	V133G_S176K	V133G_N137K_S174R_S176D
9374	L124R_H172T	V133G_N137K_S174R_S176D	V133G_S176K
9120	L124E_H172T	V133G_N137K_S174R_S176R	V133G_S176D
9370	L124R_H172R	V133G_S176D	V133G_N137K_S174R_S176R
9122	L124E_H172T	V133G_S174R_S176R	V133G_S176D
9371	L124R_H172R	V133G_S176D	V133G_S174R_S176R

9121	L124E_H172T	V133G_N137K_S174R_S176R	V133G_S176D_T178D
9373	L124R_H172R	V133G_S176D_T178D	V133G_N137K_S174R_S176R
9111	L124E_A125S_H172R_K228D	S121K_V133G_S176R	V133G_N137K_S174R_S176D
9347	L124R_A125R_H172T	V133G_N137K_S174R_S176D	S121K_V133G_S176R
9112	L124E_A125S_H172T_K228D	S121K_V133G_N137K_S174R_S176R	V133G_S176D
9346	L124R_A125R_H172R	V133G_S176D	S121K_V133G_N137K_S174R_S176R
9115	L124E_A139W	F116A_V133G_L135A_S176R	V133G_L135W_S176D
9348	L124R_A139G_V190A	V133G_L135W_S176D	F116A_V133G_L135A_S176R
9116	L124E_A139W	F116A_V133G_L135V_S176R	V133G_L135W_S176D
9349	L124R_A139G_V190A	V133G_L135W_S176D	F116A_V133G_L135V_S176R
9140	L124E_K145T_Q179E	S131K_V133G_S176R	V133G_S176D_T178D_T180E
9481	L124R_S186K	V133G_S176D_T178D_T180E	S131K_V133G_S176R
9146	L124E_K145T_Q179E	S131K_V133G_S176R	V133G_S176D_T180E
9498	L124R_S186K	V133G_S176D_T180E	S131K_V133G_S176R
9134	L124E_K145T_Q179E	S131K_V133G_S176R	V133G_S176D_T178D
9466	L124R_S186K	V133G_S176D_T178D	S131K_V133G_S176R
9136	L124E_K145T_Q179E	S131K_V133G_S176R	Q124E_V133G_S176D_T178D_T180E
9459	L124R_S186K	Q124E_V133G_S176D_T178D_T180E	S131K_V133G_S176R
9158	L124E_K145T_Q179E	S131R_V133G_S176R	V133G_S176D_T178D_T180E
9483	L124R_S186K	V133G_S176D_T178D_T180E	S131R_V133G_S176R
9164	L124E_K145T_Q179E	S131R_V133G_S176R	V133G_S176D_T180E
9500	L124R_S186K	V133G_S176D_T180E	S131R_V133G_S176R
9150	L124E_K145T_Q179E	S131R_V133G_S176R	V133G_S176D_T178D
9468	L124R_S186K	V133G_S176D_T178D	S131R_V133G_S176R
9152	L124E_K145T_Q179E	S131R_V133G_S176R	Q124E_V133G_S176D_T178D_T180E
9460	L124R_S186K	Q124E_V133G_S176D_T178D_T180E	S131R_V133G_S176R
9536	L124R_S186R	V133G_S176D_T178D_T180E	S131K_V133G_S176R
9553	L124R_S186R	V133G_S176D_T180E	S131K_V133G_S176R
9521	L124R_S186R	V133G_S176D_T178D	S131K_V133G_S176R
9513	L124R_S186R	Q124E_V133G_S176D_T178D_T180E	S131K_V133G_S176R
9538	L124R_S186R	V133G_S176D_T178D_T180E	S131R_V133G_S176R
9555	L124R_S186R	V133G_S176D_T180E	S131R_V133G_S176R
9523	L124R_S186R	V133G_S176D_T178D	S131R_V133G_S176R
9515	L124R_S186R	Q124E_V133G_S176D_T178D_T180E	S131R_V133G_S176R
9127	L124E_K145M_Q179E	S131K_V133G_S176R	V133G_S176D_T178D_T180E
9131	L124E_K145M_Q179E	S131K_V133G_S176R	V133G_S176D_T180E
9123	L124E_K145M_Q179E	S131K_V133G_S176R	V133G_S176D_T178D
9125	L124E_K145M_Q179E	S131K_V133G_S176R	Q124E_V133G_S176D_T178D_T180E
9296	L124E_L143E_K145T	Q124K_V133G_S176R_T178K	Q124E_V133G_S176D_T178D_T180E
9505	L124R_S186R	Q124E_V133G_S176D_T178D_T180E	Q124K_V133G_S176R_T178K
9308	L124E_L143E_K145T	Q124K_V133G_S176R_T178K	V133G_S176D_T180E
9547	L124R_S186R	V133G_S176D_T180E	Q124K_V133G_S176R_T178K
9300	L124E_L143E_K145T	Q124K_V133G_S176R_T178K	V133G_S176D_T178D_T180E
9528	L124R_S186R	V133G_S176D_T178D_T180E	Q124K_V133G_S176R_T178K
9294	L124E_L143E_K145T	Q124K_V133G_S176R_T178K	V133G_S176D_T178D
9519	L124R_S186R	V133G_S176D_T178D	Q124K_V133G_S176R_T178K
9304	L124E_L143E_K145T	Q124K_V133G_S176R_T178K	V133G_S176D_T178E_T180E
9542	L124R_S186R	V133G_S176D_T178E_T180E	Q124K_V133G_S176R_T178K
9314	L124E_L143E_K145T	Q124K_V133G_S176R_T178R	Q124E_V133G_S176D_T178D_T180E
9509	L124R_S186R	Q124E_V133G_S176D_T178D_T180E	Q124K_V133G_S176R_T178R
9323	L124E_L143E_K145T	Q124K_V133G_S176R_T178R	V133G_S176D_T180E
9550	L124R_S186R	V133G_S176D_T180E	Q124K_V133G_S176R_T178R
9317	L124E_L143E_K145T	Q124K_V133G_S176R_T178R	V133G_S176D_T178D_T180E
9532	L124R_S186R	V133G_S176D_T178D_T180E	Q124K_V133G_S176R_T178R
9312	L124E_L143E_K145T	Q124K_V133G_S176R_T178R	V133G_S176D_T178D
9520	L124R_S186R	V133G_S176D_T178D	Q124K_V133G_S176R_T178R
9320	L124E_L143E_K145T	Q124K_V133G_S176R_T178R	V133G_S176D_T178E_T180E
9543	L124R_S186R	V133G_S176D_T178E_T180E	Q124K_V133G_S176R_T178R
9281	L124E_L143E_K145T	Q124K_V133G_S176R	Q124E_V133G_S176D_T178D_T180E
9503	L124R_S186R	Q124E_V133G_S176D_T178D_T180E	Q124K_V133G_S176R
9290	L124E_L143E_K145T	Q124K_V133G_S176R	V133G_S176D_T180E
9546	L124R_S186R	V133G_S176D_T180E	Q124K_V133G_S176R
9284	L124E_L143E_K145T	Q124K_V133G_S176R	V133G_S176D_T178D_T180E
9526	L124R_S186R	V133G_S176D_T178D_T180E	Q124K_V133G_S176R
9279	L124E_L143E_K145T	Q124K_V133G_S176R	V133G_S176D_T178D
9518	L124R_S186R	V133G_S176D_T178D	Q124K_V133G_S176R
9287	L124E_L143E_K145T	Q124K_V133G_S176R	V133G_S176D_T178E_T180E



9541	L124R_S186R	V133G_S176D_T178E_T180E	Q124K_V133G_S176R
9451	L124R_S186K	Q124E_V133G_S176D_T178D_T180E	Q124K_V133G_S176R_T178K
9492	L124R_S186K	V133G_S176D_T180E	Q124K_V133G_S176R_T178K
9473	L124R_S186K	V133G_S176D_T178D_T180E	Q124K_V133G_S176R_T178K
9464	L124R_S186K	V133G_S176D_T178D	Q124K_V133G_S176R_T178K
9487	L124R_S186K	V133G_S176D_T178E_T180E	Q124K_V133G_S176R_T178K
9455	L124R_S186K	Q124E_V133G_S176D_T178D_T180E	Q124K_V133G_S176R_T178R
9495	L124R_S186K	V133G_S176D_T180E	Q124K_V133G_S176R_T178R
9477	L124R_S186K	V133G_S176D_T178D_T180E	Q124K_V133G_S176R_T178R
9465	L124R_S186K	V133G_S176D_T178D	Q124K_V133G_S176R_T178R
9488	L124R_S186K	V133G_S176D_T178E_T180E	Q124K_V133G_S176R_T178R
9449	L124R_S186K	Q124E_V133G_S176D_T178D_T180E	Q124K_V133G_S176R
9491	L124R_S186K	V133G_S176D_T180E	Q124K_V133G_S176R
9471	L124R_S186K	V133G_S176D_T178D_T180E	Q124K_V133G_S176R
9463	L124R_S186K	V133G_S176D_T178D	Q124K_V133G_S176R
9486	L124R_S186K	V133G_S176D_T178E_T180E	Q124K_V133G_S176R
9264	L124E_L143E_K145M	Q124K_V133G_S176R_T178R	Q124E_V133G_S176D_T178D_T180E
9267	L124E_L143E_K145M	Q124K_V133G_S176R_T178R	V133G_S176D_T178D_T180E
9250	L124E_L143E_K145M	Q124K_V133G_S176R	Q124E_V133G_S176D_T178D_T180E
9253	L124E_L143E_K145M	Q124K_V133G_S176R	V133G_S176D_T178D_T180E
9257	L124E_L143E_K145M	Q124K_V133G_S176R_T178K	Q124E_V133G_S176D_T178D_T180E
9260	L124E_L143E_K145M	Q124K_V133G_S176R_T178K	V133G_S176D_T178D_T180E
9214	L124E_L143D_K145T	Q124K_V133G_S176R_T178K	Q124E_V133G_S176D_T178D_T180E
9223	L124E_L143D_K145T	Q124K_V133G_S176R_T178R	Q124E_V133G_S176D_T178D_T180E
9217	L124E_L143D_K145T	Q124K_V133G_S176R_T178K	V133G_S176D_T178D_T180E
9226	L124E_L143D_K145T	Q124K_V133G_S176R_T178R	V133G_S176D_T178D_T180E
9220	L124E_L143D_K145T	Q124K_V133G_S176R_T178K	V133G_S176D_T180E
9229	L124E_L143D_K145T	Q124K_V133G_S176R_T178R	V133G_S176D_T180E
9234	L124E_L143D_K145T	V133G_S176R_T178K	Q124E_V133G_S176D_T178D_T180E
9516	L124R_S186R	Q124E_V133G_S176D_T178D_T180E	V133G_S176R_T178K
9243	L124E_L143D_K145T	V133G_S176R_T178K	V133G_S176D_T180E
9556	L124R_S186R	V133G_S176D_T180E	V133G_S176R_T178K
9237	L124E_L143D_K145T	V133G_S176R_T178K	V133G_S176D_T178D_T180E
9539	L124R_S186R	V133G_S176D_T178D_T180E	V133G_S176R_T178K
9232	L124E_L143D_K145T	V133G_S176R_T178K	V133G_S176D_T178D
9524	L124R_S186R	V133G_S176D_T178D	V133G_S176R_T178K
9240	L124E_L143D_K145T	V133G_S176R_T178K	V133G_S176D_T178E_T180E
9544	L124R_S186R	V133G_S176D_T178E_T180E	V133G_S176R_T178K
9461	L124R_S186K	Q124E_V133G_S176D_T178D_T180E	V133G_S176R_T178K
9501	L124R_S186K	V133G_S176D_T180E	V133G_S176R_T178K
9484	L124R_S186K	V133G_S176D_T178D_T180E	V133G_S176R_T178K
9469	L124R_S186K	V133G_S176D_T178D	V133G_S176R_T178K
9489	L124R_S186K	V133G_S176D_T178E_T180E	V133G_S176R_T178K
9176	L124E_L143D_K145M	Q124K_V133G_S176R_T178K	Q124E_V133G_S176D_T178D_T180E
9185	L124E_L143D_K145M	Q124K_V133G_S176R_T178R	Q124E_V133G_S176D_T178D_T180E
9179	L124E_L143D_K145M	Q124K_V133G_S176R_T178K	V133G_S176D_T178D_T180E
9188	L124E_L143D_K145M	Q124K_V133G_S176R_T178R	V133G_S176D_T178D_T180E
9182	L124E_L143D_K145M	Q124K_V133G_S176R_T178K	V133G_S176D_T180E
9191	L124E_L143D_K145M	Q124K_V133G_S176R_T178R	V133G_S176D_T180E
9196	L124E_L143D_K145M	V133G_S176R_T178K	Q124E_V133G_S176D_T178D_T180E
9205	L124E_L143D_K145M	V133G_S176R_T178K	V133G_S176D_T180E
9199	L124E_L143D_K145M	V133G_S176R_T178K	V133G_S176D_T178D_T180E
9194	L124E_L143D_K145M	V133G_S176R_T178K	V133G_S176D_T178D
9202	L124E_L143D_K145M	V133G_S176R_T178K	V133G_S176D_T178E_T180E
9273	L124E_L143E_K145T	Q124K_V133G_Q160K_S176R	V133G_S176D_T178E
9398	L124R_Q179K	V133G_S176D_T178E	Q124K_V133G_Q160K_S176R
9271	L124E_L143E_K145T	Q124K_V133G_Q160K_S176R	Q124E_V133G_S176D_T178E_T180E
9376	L124R_Q179K	Q124E_V133G_S176D_T178E_T180E	Q124K_V133G_Q160K_S176R
9275	L124E_L143E_K145T	Q124K_V133G_Q160K_S176R	V133G_S176D_T178E_T180E
9419	L124R_Q179K	V133G_S176D_T178E_T180E	Q124K_V133G_Q160K_S176R
9277	L124E_L143E_K145T	Q124K_V133G_Q160K_S176R	V133G_S176D_T180E
9428	L124R_Q179K	V133G_S176D_T180E	Q124K_V133G_Q160K_S176R
9302	L124E_L143E_K145T	Q124K_V133G_S176R_T178K	V133G_S176D_T178E
9406	L124R_Q179K	V133G_S176D_T178E	Q124K_V133G_S176R_T178K
9298	L124E_L143E_K145T	Q124K_V133G_S176R_T178K	Q124E_V133G_S176D_T178E_T180E
9384	L124R_Q179K	Q124E_V133G_S176D_T178E_T180E	Q124K_V133G_S176R_T178K
9421	L124R_Q179K	V133G_S176D_T178E_T180E	Q124K_V133G_S176R_T178K

9436	L124R_Q179K	V133G_S176D_T180E	Q124K_V133G_S176R_T178K
9319	L124E_L143E_K145T	Q124K_V133G_S176R_T178R	V133G_S176D_T178E
9410	L124R_Q179K	V133G_S176D_T178E	Q124K_V133G_S176R_T178R
9316	L124E_L143E_K145T	Q124K_V133G_S176R_T178R	Q124E_V133G_S176D_T178E_T180E
9388	L124R_Q179K	Q124E_V133G_S176D_T178E_T180E	Q124K_V133G_S176R_T178R
9422	L124R_Q179K	V133G_S176D_T178E_T180E	Q124K_V133G_S176R_T178R
9440	L124R_Q179K	V133G_S176D_T180E	Q124K_V133G_S176R_T178R
9286	L124E_L143E_K145T	Q124K_V133G_S176R	V133G_S176D_T178E
9402	L124R_Q179K	V133G_S176D_T178E	Q124K_V133G_S176R
9283	L124E_L143E_K145T	Q124K_V133G_S176R	Q124E_V133G_S176D_T178E_T180E
9380	L124R_Q179K	Q124E_V133G_S176D_T178E_T180E	Q124K_V133G_S176R
9420	L124R_Q179K	V133G_S176D_T178E_T180E	Q124K_V133G_S176R
9432	L124R_Q179K	V133G_S176D_T180E	Q124K_V133G_S176R
9248	L124E_L143E_K145M	Q124K_V133G_Q160K_S176R	V133G_S176D_T178E
9247	L124E_L143E_K145M	Q124K_V133G_Q160K_S176R	Q124E_V133G_S176D_T178E_T180E
9249	L124E_L143E_K145M	Q124K_V133G_Q160K_S176R	V133G_S176D_T180E
9262	L124E_L143E_K145M	Q124K_V133G_S176R_T178K	V133G_S176D_T178E
9259	L124E_L143E_K145M	Q124K_V133G_S176R_T178K	Q124E_V133G_S176D_T178E_T180E
9263	L124E_L143E_K145M	Q124K_V133G_S176R_T178K	V133G_S176D_T180E
9269	L124E_L143E_K145M	Q124K_V133G_S176R_T178R	V133G_S176D_T178E
9266	L124E_L143E_K145M	Q124K_V133G_S176R_T178R	Q124E_V133G_S176D_T178E_T180E
9270	L124E_L143E_K145M	Q124K_V133G_S176R_T178R	V133G_S176D_T180E
9255	L124E_L143E_K145M	Q124K_V133G_S176R	V133G_S176D_T178E
9252	L124E_L143E_K145M	Q124K_V133G_S176R	Q124E_V133G_S176D_T178E_T180E
9256	L124E_L143E_K145M	Q124K_V133G_S176R	V133G_S176D_T180E
9209	L124E_L143D_K145T	Q124K_V133G_Q160K_S176R	V133G_S176D_T178E
9208	L124E_L143D_K145T	Q124K_V133G_Q160K_S176R	Q124E_V133G_S176D_T178E_T180E
9210	L124E_L143D_K145T	Q124K_V133G_Q160K_S176R	V133G_S176D_T180E
9219	L124E_L143D_K145T	Q124K_V133G_S176R_T178K	V133G_S176D_T178E
9216	L124E_L143D_K145T	Q124K_V133G_S176R_T178K	Q124E_V133G_S176D_T178E_T180E
9228	L124E_L143D_K145T	Q124K_V133G_S176R_T178R	V133G_S176D_T178E
9225	L124E_L143D_K145T	Q124K_V133G_S176R_T178R	Q124E_V133G_S176D_T178E_T180E
9212	L124E_L143D_K145T	Q124K_V133G_S176R	V133G_S176D_T178E
9211	L124E_L143D_K145T	Q124K_V133G_S176R	Q124E_V133G_S176D_T178E_T180E
9213	L124E_L143D_K145T	Q124K_V133G_S176R	V133G_S176D_T180E
9239	L124E_L143D_K145T	V133G_S176R_T178K	V133G_S176D_T178E
9417	L124R_Q179K	V133G_S176D_T178E	V133G_S176R_T178K
9236	L124E_L143D_K145T	V133G_S176R_T178K	Q124E_V133G_S176D_T178E_T180E
9395	L124R_Q179K	Q124E_V133G_S176D_T178E_T180E	V133G_S176R_T178K
9426	L124R_Q179K	V133G_S176D_T178E_T180E	V133G_S176R_T178K
9447	L124R_Q179K	V133G_S176D_T180E	V133G_S176R_T178K
9171	L124E_L143D_K145M	Q124K_V133G_Q160K_S176R	V133G_S176D_T178E
9170	L124E_L143D_K145M	Q124K_V133G_Q160K_S176R	Q124E_V133G_S176D_T178E_T180E
9172	L124E_L143D_K145M	Q124K_V133G_Q160K_S176R	V133G_S176D_T180E
9181	L124E_L143D_K145M	Q124K_V133G_S176R_T178K	V133G_S176D_T178E
9178	L124E_L143D_K145M	Q124K_V133G_S176R_T178K	Q124E_V133G_S176D_T178E_T180E
9190	L124E_L143D_K145M	Q124K_V133G_S176R_T178R	V133G_S176D_T178E
9187	L124E_L143D_K145M	Q124K_V133G_S176R_T178R	Q124E_V133G_S176D_T178E_T180E
9174	L124E_L143D_K145M	Q124K_V133G_S176R	V133G_S176D_T178E
9173	L124E_L143D_K145M	Q124K_V133G_S176R	Q124E_V133G_S176D_T178E_T180E
9175	L124E_L143D_K145M	Q124K_V133G_S176R	V133G_S176D_T180E
9201	L124E_L143D_K145M	V133G_S176R_T178K	V133G_S176D_T178E
9198	L124E_L143D_K145M	V133G_S176R_T178K	Q124E_V133G_S176D_T178E_T180E
9355	L124R_D146N_Q179K	V133G_S176D_T178E	Q124K_V133G_Q160K_S176R
9350	L124R_D146N_Q179K	Q124E_V133G_S176D_T178E_T180E	Q124K_V133G_Q160K_S176R
9359	L124R_D146N_Q179K	V133G_S176D_T178E_T180E	Q124K_V133G_Q160K_S176R
9363	L124R_D146N_Q179K	V133G_S176D_T180E	Q124K_V133G_Q160K_S176R
9356	L124R_D146N_Q179K	V133G_S176D_T178E	Q124K_V133G_S176R_T178K
9351	L124R_D146N_Q179K	Q124E_V133G_S176D_T178E_T180E	Q124K_V133G_S176R_T178K
9360	L124R_D146N_Q179K	V133G_S176D_T178E_T180E	Q124K_V133G_S176R_T178K
9365	L124R_D146N_Q179K	V133G_S176D_T180E	Q124K_V133G_S176R_T178K
9364	L124R_D146N_Q179K	V133G_S176D_T180E	Q124K_V133G_S176R
9368	L124R_D146N_Q179K	V133G_S176D_T180E	V133G_S176R_T178K
9142	L124E_K145T_Q179E	S131K_V133G_S176R	V133G_S176D_T178E
9414	L124R_Q179K	V133G_S176D_T178E	S131K_V133G_S176R
9138	L124E_K145T_Q179E	S131K_V133G_S176R	Q124E_V133G_S176D_T178E_T180E
9392	L124R_Q179K	Q124E_V133G_S176D_T178E_T180E	S131K_V133G_S176R

9144	L124E_K145T_Q179E	S131K_V133G_S176R	V133G_S176D_T178E_T180E
9423	L124R_Q179K	V133G_S176D_T178E_T180E	S131K_V133G_S176R
9444	L124R_Q179K	V133G_S176D_T180E	S131K_V133G_S176R
9160	L124E_K145T_Q179E	S131R_V133G_S176R	V133G_S176D_T178E
9416	L124R_Q179K	V133G_S176D_T178E	S131R_V133G_S176R
9154	L124E_K145T_Q179E	S131R_V133G_S176R	Q124E_V133G_S176D_T178E_T180E
9394	L124R_Q179K	Q124E_V133G_S176D_T178E_T180E	S131R_V133G_S176R
9162	L124E_K145T_Q179E	S131R_V133G_S176R	V133G_S176D_T178E_T180E
9425	L124R_Q179K	V133G_S176D_T178E_T180E	S131R_V133G_S176R
9446	L124R_Q179K	V133G_S176D_T180E	S131R_V133G_S176R
9156	L124E_K145T_Q179E	S131R_V133G_S176R	V133G_Q160E_S176D_T180E
9397	L124R_Q179K	V133G_Q160E_S176D_T180E	S131R_V133G_S176R
9129	L124E_K145M_Q179E	S131K_V133G_S176R	V133G_S176D_T178E
9126	L124E_K145M_Q179E	S131K_V133G_S176R	Q124E_V133G_S176D_T178E_T180E
9130	L124E_K145M_Q179E	S131K_V133G_S176R	V133G_S176D_T178E_T180E
9357	L124R_D146N_Q179K	V133G_S176D_T178E	S131K_V133G_S176R
9352	L124R_D146N_Q179K	Q124E_V133G_S176D_T178E_T180E	S131K_V133G_S176R
9361	L124R_D146N_Q179K	V133G_S176D_T178E_T180E	S131K_V133G_S176R
9366	L124R_D146N_Q179K	V133G_S176D_T180E	S131K_V133G_S176R
9358	L124R_D146N_Q179K	V133G_S176D_T178E	S131R_V133G_S176R
9353	L124R_D146N_Q179K	Q124E_V133G_S176D_T178E_T180E	S131R_V133G_S176R
9362	L124R_D146N_Q179K	V133G_S176D_T178E_T180E	S131R_V133G_S176R
9367	L124R_D146N_Q179K	V133G_S176D_T180E	S131R_V133G_S176R
9354	L124R_D146N_Q179K	V133G_Q160E_S176D_T180E	S131R_V133G_S176R
9814	Q39E_K145T_Q179E	Q38R_S131K	Q38E_Q124E_Q160E_T180E
9828	Q39R_S186R	Q38E_Q124E_Q160E_T180E	Q38R_S131K
9817	Q39E_L143E_K145T	Q38R_Q124R_Q160K_T178R	Q38E_Q124E_Q160E_T180E
9822	Q39R_D146G_Q179K	Q38E_Q124E_Q160E_T180E	Q38R_Q124R_Q160K_T178R
9820	Q39E_L143E_K145T_Q179E	Q38R_Q124R_Q160K_T178R	Q38E_Q124E_Q160E_T180E
9827	Q39R_Q179K	Q38E_Q124E_Q160E_T180E	Q38R_Q124R_Q160K_T178R
9815	Q39E_L124E	Q38R_V133G_S176R	Q38E_V133G_S176D
9825	Q39R_L124R	Q38E_V133G_S176D	Q38R_V133G_S176R
9746	L45P_K145T_Q179E	P44F_S131K	Q38E_Q124E_Q160E_T180E
9905	S186R	Q38E_Q124E_Q160E_T180E	P44F_S131K
9751	L45P_L143E_K145T	P44F_Q124R_Q160K_T178R	Q38E_Q124E_Q160E_T180E
9065	D146G_Q179K	Q38E_Q124E_Q160E_T180E	P44F_Q124R_Q160K_T178R
9754	L45P_L143E_K145T_Q179E	P44F_Q124R_Q160K_T178R	Q124E_Q160E_T180E
9760	Q179K	Q124E_Q160E_T180E	P44F_Q124R_Q160K_T178R
9747	L45P_L124E	P44F_V133G_S176R	V133G_S176D
9334	L124R	V133G_S176D	P44F_V133G_S176R
9748	L45P_L124E	P44F_V133G_S176R	V133G_S176D_T178D
9338	L124R	V133G_S176D_T178D	P44F_V133G_S176R
9813	Q39E_K145T_H172R_Q179E	Q38R_S131K	Q38E_Q124E_Q160E_T180E
9824	Q39R_H172R_S186R	Q38E_Q124E_Q160E_T180E	Q38R_S131K
9818	Q39E_L143E_K145T_H172R	Q38R_Q124R_Q160K_T178R	Q38E_Q124E_Q160E_T180E
9821	Q39R_D146G_H172R_Q179K	Q38E_Q124E_Q160E_T180E	Q38R_Q124R_Q160K_T178R
9819	Q39E_L143E_K145T_H172R_Q179E	Q38R_Q124R_Q160K_T178R	Q38E_Q124E_Q160E_T180E
9823	Q39R_H172R_Q179K	Q38E_Q124E_Q160E_T180E	Q38R_Q124R_Q160K_T178R
9816	Q39E_L124E_H172R	Q38R_V133G_S176R	Q38E_V133G_S176D
9826	Q39R_L124R_H172R	Q38E_V133G_S176D	Q38R_V133G_S176R
9745	L45P_K145T_H172R_Q179E	P44F_S131K	Q38E_Q124E_Q160E_T180E
9075	H172R_S186R	Q38E_Q124E_Q160E_T180E	P44F_S131K
9752	L45P_L143E_K145T_H172R	P44F_Q124R_Q160K_T178R	Q38E_Q124E_Q160E_T180E
9064	D146G_H172R_Q179K	Q38E_Q124E_Q160E_T180E	P44F_Q124R_Q160K_T178R
9753	L45P_L143E_K145T_H172R_Q179E	P44F_Q124R_Q160K_T178R	Q124E_Q160E_T180E
9074	H172R_Q179K	Q124E_Q160E_T180E	P44F_Q124R_Q160K_T178R
9749	L45P_L124E_H172R	P44F_V133G_S176R	V133G_S176D
9369	L124R_H172R	V133G_S176D	P44F_V133G_S176R
9750	L45P_L124E_H172R	P44F_V133G_S176R	V133G_S176D_T178D
9372	L124R_H172R	V133G_S176D_T178D	P44F_V133G_S176R
9079	K145T_Q179E	S131K	Q124E_Q160E_T180E
9878	S186R	Q124E_Q160E_T180E	S131K
9840	S186K	Q124E_Q160E_T180E	S131K
9082	K145T_Q179E	S131K	Q124E_T180E
9900	S186R	Q124E_T180E	S131K
9862	S186K	Q124E_T180E	S131K

9772	Q179K	Q124E_Q160E_T180E	S131K
9796	Q179K	Q124E_T180E	S131K
9590	L143E_K145T	Q124R_Q160K_T178R	Q124E_Q160E_T180E
9871	S186R	Q124E_Q160E_T180E	Q124R_Q160K_T178R
9833	S186K	Q124E_Q160E_T180E	Q124R_Q160K_T178R
9506	L143E_K145T	Q124R_Q160K_T178R	Q124E_T180E
9893	S186R	Q124E_T180E	Q124R_Q160K_T178R
9655	S186K	Q124E_T180E	Q124R_Q160K_T178R
9763	Q179K	Q124E_Q160E_T180E	Q124R_Q160K_T178R
9789	Q179K	Q124E_T180E	Q124R_Q160K_T178R
9651	L143E_K145T_Q179E	Q124R_Q160K_T178R	Q124E_Q160E_T180E
9654	L143E_K145T_Q179E	Q124R_Q160K_T178R	Q124E_T180E
9620	L143E_K145T_Q179D	Q124R_Q160K_T178R	Q124E_Q160E_T180E
9623	L143E_K145T_Q179D	Q124R_Q160K_T178R	Q124E_T180E
9663	L143E_K145T_Q179E	Q124R_T178R	Q124E_Q160E_T180E
9876	S186R	Q124E_Q160E_T180E	Q124R_T178R
9838	S186K	Q124E_Q160E_T180E	Q124R_T178R
9679	L143E_K145T_Q179E	Q124R_T178R	Q124E_T180E
9898	S186R	Q124E_T180E	Q124R_T178R
9860	S186K	Q124E_T180E	Q124R_T178R
9769	Q179K	Q124E_Q160E_T180E	Q124R_T178R
9794	Q179K	Q124E_T180E	Q124R_T178R
9632	L143E_K145T_Q179D	Q124R_T178R	Q124E_Q160E_T180E
9635	L143E_K145T_Q179D	Q124R_T178R	Q124E_T180E
9557	L143E_K145T_Q179E	Q124R_T178K	Q124E_Q160E_T180E
9874	S186R	Q124E_Q160E_T180E	Q124R_T178K
9836	S186K	Q124E_Q160E_T180E	Q124R_T178K
9660	L143E_K145T_Q179E	Q124R_T178K	Q124E_T180E
9896	S186R	Q124E_T180E	Q124R_T178K
9858	S186K	Q124E_T180E	Q124R_T178K
9767	Q179K	Q124E_Q160E_T180E	Q124R_T178K
9792	Q179K	Q124E_T180E	Q124R_T178K
9626	L143E_K145T_Q179D	Q124R_T178K	Q124E_Q160E_T180E
9629	L143E_K145T_Q179D	Q124R_T178K	Q124E_T180E
9645	L143E_K145T_Q179E	Q124K_T178R	Q124E_Q160E_T180E
9869	S186R	Q124E_Q160E_T180E	Q124K_T178R
9831	S186K	Q124E_Q160E_T180E	Q124K_T178R
9648	L143E_K145T_Q179E	Q124K_T178R	Q124E_T180E
9891	S186R	Q124E_T180E	Q124K_T178R
9853	S186K	Q124E_T180E	Q124K_T178R
9761	Q179K	Q124E_Q160E_T180E	Q124K_T178R
9787	Q179K	Q124E_T180E	Q124K_T178R
9614	L143E_K145T_Q179D	Q124K_T178R	Q124E_Q160E_T180E
9617	L143E_K145T_Q179D	Q124K_T178R	Q124E_T180E
9684	L143E_K145T_Q179E	T178R	Q124E_T180E
9901	S186R	Q124E_T180E	T178R
9863	S186K	Q124E_T180E	T178R
9683	L143E_K145T_Q179E	T178R	Q124E_Q160E_T180E
9773	Q179K	Q124E_Q160E_T180E	T178R
9797	Q179K	Q124E_T180E	T178R
9638	L143E_K145T_Q179D	T178R	Q124E_Q160E_T180E
9879	S186R	Q124E_Q160E_T180E	T178R
9841	S186K	Q124E_Q160E_T180E	T178R
9641	L143E_K145T_Q179D	T178R	Q124E_T180E
9579	L143D_K145T_Q179E	T178R	Q124E_T180E
9575	L143D_K145T_Q179E	T178R	Q124E_Q160E_T180E
9598	L143E_K145T	Q124R_Q160K_T178R	Q124E_T178E
9887	S186R	Q124E_T178E	Q124R_Q160K_T178R
9849	S186K	Q124E_T178E	Q124R_Q160K_T178R
9783	Q179K	Q124E_T178E	Q124R_Q160K_T178R
9809	Q179R	Q124E_T178E	Q124R_Q160K_T178R
9502	L143E_K145T	Q124R_Q160K_T178R	Q124E_T178E_T180E
9689	S186R	Q124E_T178E_T180E	Q124R_Q160K_T178R
9851	S186K	Q124E_T178E_T180E	Q124R_Q160K_T178R
9785	Q179K	Q124E_T178E_T180E	Q124R_Q160K_T178R
9811	Q179R	Q124E_T178E_T180E	Q124R_Q160K_T178R
9594	L143E_K145T	Q124R_Q160K_T178R	Q124E_Q160E_T178E

9867	S186R	Q124E_Q160E_T178E	Q124R_Q160K_T178R
9829	S186K	Q124E_Q160E_T178E	Q124R_Q160K_T178R
9757	Q179K	Q124E_Q160E_T178E	Q124R_Q160K_T178R
9801	Q179R	Q124E_Q160E_T178E	Q124R_Q160K_T178R
9671	L143E_K145T_Q179E	Q124R_T178R	Q124E_T178E
9888	S186R	Q124E_T178E	Q124R_T178R
9850	S186K	Q124E_T178E	Q124R_T178R
9784	Q179K	Q124E_T178E	Q124R_T178R
9810	Q179R	Q124E_T178E	Q124R_T178R
9675	L143E_K145T_Q179E	Q124R_T178R	Q124E_T178E_T180E
9890	S186R	Q124E_T178E_T180E	Q124R_T178R
9852	S186K	Q124E_T178E_T180E	Q124R_T178R
9786	Q179K	Q124E_T178E_T180E	Q124R_T178R
9812	Q179R	Q124E_T178E_T180E	Q124R_T178R
9667	L143E_K145T_Q179E	Q124R_T178R	Q124E_Q160E_T178E
9858	S186R	Q124E_Q160E_T178E	Q124R_T178R
9830	S186K	Q124E_Q160E_T178E	Q124R_T178R
9758	Q179K	Q124E_Q160E_T178E	Q124R_T178R
9802	Q179R	Q124E_Q160E_T178E	Q124R_T178R
9708	L143E_K145T_S188L	Q124R_Q160K_T178R	Q124E_S131T_T178F_T180E
9843	S186K	Q124E_S131T_T178F_T180E	Q124R_Q160K_T178R
9712	L143E_K145T_S188L	Q124R_Q160K_T178R	Q124E_S131T_T178Y_T180E
9845	S186K	Q124E_S131T_T178Y_T180E	Q124R_Q160K_T178R
9777	Q179K	Q124E_S131T_T178F_T180E	Q124R_Q160K_T178R
9779	Q179K	Q124E_S131T_T178Y_T180E	Q124R_Q160K_T178R
9803	Q179R	Q124E_S131T_T178F_T180E	Q124R_Q160K_T178R
9805	Q179R	Q124E_S131T_T178Y_T180E	Q124R_Q160K_T178R
9881	S186R	Q124E_S131T_T178F_T180E	Q124R_Q160K_T178R
9883	S186R	Q124E_S131T_T178Y_T180E	Q124R_Q160K_T178R
9688	L143E_K145T_Q179E_S188L	Q124R_T178R	Q124E_S131T_T178F_T180E
9844	S186K	Q124E_S131T_T178F_T180E	Q124R_T178R
9692	L143E_K145T_Q179E_S188L	Q124R_T178R	Q124E_S131T_T178Y_T180E
9846	S186K	Q124E_S131T_T178Y_T180E	Q124R_T178R
9778	Q179K	Q124E_S131T_T178F_T180E	Q124R_T178R
9780	Q179K	Q124E_S131T_T178Y_T180E	Q124R_T178R
9804	Q179R	Q124E_S131T_T178F_T180E	Q124R_T178R
9806	Q179R	Q124E_S131T_T178Y_T180E	Q124R_T178R
9882	S186R	Q124E_S131T_T178F_T180E	Q124R_T178R
9884	S186R	Q124E_S131T_T178Y_T180E	Q124R_T178R
9723	L143E_K145T_S188L	Q124R_Q160K_T178R	Q124E_V133W_T180E
9102	L124A_S186K	Q124E_V133W_T180E	Q124R_Q160K_T178R
9100	L124A_Q179K	Q124E_V133W_T180E	Q124R_Q160K_T178R
9725	L143E_K145T_S188L	Q124R_Q160K_T178R	Q124E_V133Y_T180E
9573	L143A_Q179K	Q124E_V133Y_T180E	Q124R_Q160K_T178R
9700	L143E_K145T_Q179E_S188L	Q124R_T178R	Q124E_V133W_T180E
9103	L124A_S186K	Q124E_V133W_T180E	Q124R_T178R
9101	L124A_Q179K	Q124E_V133W_T180E	Q124R_T178R
9702	L143E_K145T_Q179E_S188L	Q124R_T178R	Q124E_V133Y_T180E
9574	L143A_Q179K	Q124E_V133Y_T180E	Q124R_T178R
9716	L143E_K145T_S188L	Q124R_Q160K_T178R	Q124E_S176L_T180E
9885	S186R	Q124E_S176L_T180E	Q124R_Q160K_T178R
9847	S186K	Q124E_S176L_T180E	Q124R_Q160K_T178R
9781	Q179K	Q124E_S176L_T180E	Q124R_Q160K_T178R
9807	Q179R	Q124E_S176L_T180E	Q124R_Q160K_T178R
9696	L143E_K145T_Q179E_S188L	Q124R_T178R	Q124E_S176L_T180E
9886	S186R	Q124E_S176L_T180E	Q124R_T178R
9848	S186K	Q124E_S176L_T180E	Q124R_T178R
9782	Q179K	Q124E_S176L_T180E	Q124R_T178R
9808	Q179R	Q124E_S176L_T180E	Q124R_T178R
9986	L143E_K145T	Q124R_Q160K_T178R	S131E
9981	S186R	S131E	Q124R_Q160K_T178R
9978	S186K	S131E	Q124R_Q160K_T178R
9979	Q179K	S131E	Q124R_Q160K_T178R
9980	Q179R	S131E	Q124R_Q160K_T178R
9987	L143E_K145T	Q124R_T178R	S131E
9985	S186R	S131E	Q124R_T178R
9982	S186K	S131E	Q124R_T178R

9983	Q179K	S131E	Q124R_T178R
9984	Q179R	S131E	Q124R_T178R
9988	L143E_K145T_Q179E	Q124R_Q160K_T178R	S131E
9989	L143E_K145T_Q179E	Q124R_T178R	S131E
9611	L143E_K145T_H172R	Q124R_Q160K_T178R	Q124E_N137K_Q160E_S174R_T180E
9077	H172T_Q179K	Q124E_N137K_Q160E_S174R_T180E	Q124R_Q160K_T178R
9510	L143E_K145T_H172R	Q124R	Q124E_N137K_Q160E_S174R_T180E
9076	H172T_Q179K	Q124E_N137K_Q160E_S174R_T180E	Q124R
9512	L143E_K145T_H172R_Q179E	Q124R_T178R	Q124E_N137K_Q160E_S174R_T180E
9078	H172T_Q179K	Q124E_N137K_Q160E_S174R_T180E	Q124R_T178R
9060	A139W_L143E_K145T_Q179E	F116A_Q124R_L135V_T178R	Q124E_L135W_Q160E_T180E
9054	A139G_Q179K_V190A	Q124E_L135W_Q160E_T180E	F116A_Q124R_L135V_T178R
9058	A139W_L143E_K145T_Q179E	F116A_Q124R_L135V	Q124E_L135W_Q160E_T180E
9053	A139G_Q179K_V190A	Q124E_L135W_Q160E_T180E	F116A_Q124R_L135V
9756	Q179K	Q124E_L135W_Q160E_T180E	F116A_Q124R_L135V_T178R
9755	Q179K	Q124E_L135W_Q160E_T180E	F116A_Q124R_L135V
9585	L143E_K145T	Q124R	Q124E_V133D
9734	L143K_D146G	Q124E_V133D	Q124R
9587	L143E_K145T	Q124R	Q124E_V133E
9735	L143R	Q124E_V133E	Q124R
9726	L143K	Q124E_V133D	Q124R
9609	L143E_K145T	Q124R_Q160K_T178R	Q124E_V133E
9737	L143R	Q124E_V133E	Q124R_Q160K_T178R
9593	L143E_K145T	Q124R_Q160K_T178R	Q124E_V133D
9728	L143K	Q124E_V133D	Q124R_Q160K_T178R
9682	L143E_K145T_Q179E	Q124R_T178R	Q124E_V133E
9740	L143R	Q124E_V133E	Q124R_T178R
9666	L143E_K145T_Q179E	Q124R_T178R	Q124E_V133D
9731	L143K	Q124E_V133D	Q124R_T178R
9705	L143E_K145T_S188L	Q124R	Q124E_V133E
9703	L143E_K145T_S188L	Q124R	Q124E_V133D
9706	L143E_K145T_S188L	Q124R	Q124E_V133E_S176L
9743	L143R	Q124E_V133E_S176L	Q124R
9704	L143E_K145T_S188L	Q124R	Q124E_V133D_S176L
9732	L143K	Q124E_V133D_S176L	Q124R
9721	L143E_K145T_S188L	Q124R_Q160K_T178R	Q124E_V133E
9707	L143E_K145T_S188L	Q124R_Q160K_T178R	Q124E_V133D
9722	L143E_K145T_S188L	Q124R_Q160K_T178R	Q124E_V133E_S176L
9744	L143R	Q124E_V133E_S176L	Q124R_Q160K_T178R
9720	L143E_K145T_S188L	Q124R_Q160K_T178R	Q124E_V133D_S176L
9733	L143K	Q124E_V133D_S176L	Q124R_Q160K_T178R
9687	L143E_K145T_Q179E_S188L	Q124R_Q160K_T178R	Q124E_V133E
9544	L143E_K145T_Q179D_S188L	Q124R_Q160K_T178R	Q124E_V133D
9588	L143E_K145T	Q124R	Q124E_V133E_Q160F
9741	L143R	Q124E_V133E_Q160F	Q124R
9589	L143E_K145T	Q124R	Q124E_V133E_Q160M
9742	L143R	Q124E_V133E_Q160M	Q124R
9911	S188L	WT	S176L
9906	S188G	S176L	WT
9907	S188L	WT	S131T_S176F_T178F
9071	F174V	S131T_S176F_T178F	WT
9909	S188L	WT	S131T_S176F_T178Y
9073	F174V	S131T_S176F_T178Y	WT
9068	F174G	S131T_S176F_T178F	WT
9070	F174G	S131T_S176F_T178Y	WT
9916	S188L_V190Y	V133S	L135W_S176L
9057	A139G_V190A	L135W_S176L	V133S
9912	S188L_V190F	WT	L135W_S176L
9055	A139G_V190A	L135W_S176L	WT
9914	S188L_V190F	WT	S131T_S176F_T178F
9917	S188L_V190Y	V133S	S131T_L135F_S176F_T178F
9052	A139G_F174V_V190A	S131T_L135F_S176F_T178F	V133S
9913	S188L_V190F	WT	S131T_L135F_S176F_T178F
9050	A139G_F174V_V190A	S131T_L135F_S176F_T178F	WT
9062	A139W_S188L	F116A_L135V	L135W_S176L
9056	A139G_V190A	L135W_S176L	F116A_L135V
9063	A139W_S188L	F116A_L135V	S131T_L135F_S176F_T178F

9051	A139G_F174V_V190A	S131T_L135F_S176F_T178F	F116A_L135V
9041	A139C	F116C	WT
9045	WT	WT	F116C
9043	F122C	S121C	WT
9047	WT	WT	S121C
9042	F122C	Q124C	WT
9046	WT	WT	Q124C
9044	P175C	S162C	WT
9048	WT	WT	S162C
9049	A139C_L143E_K145T_Q179E	F116C_Q124R_T178R	Q124E_Q160E_T180E
9759	Q179K	Q124E_Q160E_T180E	F116C_Q124R_T178R
9067	F122C_L143E_K145T_Q179E	S121C_Q124R_T178R	Q124E_Q160E_T180E
9771	Q179K	Q124E_Q160E_T180E	S121C_Q124R_T178R
9066	F122C_L124E	Q124C_V133G_S176R	V133G_S176D
9335	L124R	V133G_S176D	Q124C_V133G_S176R
9513	L143E_K145T_P175C_Q179E	Q124R_S162C_T178R	Q124E_Q160E_T180E
9766	Q179K	Q124E_Q160E_T180E	Q124R_S162C_T178R

\*Kabat numbering; WT refers to a wild-type immunoglobulin chain without amino acid mutations.

\*\*Each unique set of H1, L1 and L2 mutations (iCCA format) was assigned a set number, or 'unique identifier'.

TABLE 5. Design library

Unique identifier {Set#H1L1L2 - Set#H2L2L1, if corresponding LCCA experiments are conducted}**	H1_mutation*	L1_mutation*	H2_mutation*	L2_mutation*	Design type
9567-9087	L124W_L143F	V133A	L124A_L143F	V133W_S176T_T178L	Optimization
9570-9088	L124W_L143F	V133G	L124A_L143F	V133W_S176T_T178L	Optimization
9569-9088	L124W_L143F	V133A_S176T_T178L	L124A_L143F	V133W_S176T_T178L	Optimization
9566-9085	L124W_L143F	V133A	L124A_L143F	V133W	Optimization
9568-9086	L124W_L143F	V133A_S176T_T178L	L124A_L143F	V133W	Optimization
9572-9096	L124W_L143F_K145T_Q179E	S131K_V133A_S176T_T178L	L124A_L143F_Q179K	Q124E_V133W_S176T_T178L_T180E	Combination/optimization
9571-9092	L124W_L143F_K145T_Q179E	S131K_V133A_S176T_T178L	L124A_L143F_Q179K	Q124E_V133W_S176T_T178L_T180E	Combination/optimization
9564-9096	L124W_L143E_K145T_Q179E	S131K_V133A_S176T_T178L	L124A_L143E_Q179K	Q124E_V133W_S176T_T178L_T180E	Combination/optimization
9562-9092	L124W_L143E_K145T_Q179E	S131K_V133A_S176T_T178L	L124A_L143E_Q179K	Q124E_V133W_S176T_T178L_T180E	Combination/optimization
9561-9095	L124W_L143E_K145T_Q179E	Q124R_V133A_S176T_T178R	L124A_L143E_Q179K	Q124E_V133W_S176T_T178L_T180E	Combination/optimization
9560-9091	L124W_L143E_K145T_Q179E	Q124R_V133A_S176T_T178R	L124A_L143E_Q179K	Q124E_V133W_S176T_T178L_T180E	Combination/optimization
9559-9094	L124W_L143E_K145T_Q179E	Q124K_V133A_S176T_T178R	L124A_L143E_Q179K	Q124E_V133W_S176T_T178L_T180E	Combination/optimization
9558-9090	L124W_L143E_K145T_Q179E	Q124K_V133A_S176T_T178R	L124A_L143E_Q179K	Q124E_V133W_S176T_T178L_T180E	Combination/optimization
9564-9099	L124W_L143E_K145T_Q179E	S131K_V133A_S176T_T178L	L124A_Q179K	Q124E_V133W_S176T_T178L_T180E	Combination/optimization
9562-9098	L124W_L143E_K145T_Q179E	S131K_V133A_S176T_T178L	L124A_Q179K	Q124E_V133W_S176T_T178L_T180E	Combination/optimization
9110-9341	L124E	V133G_S176R	L124R	V133G_S176D_T178Y	Optimization
9104-9336	L124E	S131T_V133G_S176R_T178Y	L124R	V133G_S176D	Optimization
9105-9340	L124E	S131T_V133G_S176R_T178Y	L124R	V133G_S176D_T178Y	Optimization
9106-9337	L124E	V133G_S176K	L124R	V133G_S176D	Optimization
9107-9339	L124E	V133G_S176K	L124R	V133G_S176D_T178D	Optimization
9109-9332	L124E	V133G_S176R	L124R	S131E_V133G_S176D	Optimization
9108-9330	L124E	V133G_S176K	L124R	S131E_V133G_S176D	Optimization
9326-6048	L124E_L143F	V133G_S176R	L124R	V133G_S176D	Optimization
9327-6054	L124E_L143F	V133G_S176R	L124R	V133G_S176D_T178D	Optimization
9328-9332	L124E_L143F	V133G_S176R	L124R	S131E_V133G_S176D	Optimization
9113-9342	L124E_A125S_K228D	S121K_V133G_S176R	L124R_A125R	V133G_S176D	Combination
9114-9344	L124E_A125S_K228D	S121K_V133G_S176R	L124R_A125R	V133G_S176D_T178D	Combination
9168-9342	L124E_K228D	S121K_V133G_S176R	L124R_A125R	V133G_S176D	Combination
9169-9344	L124E_K228D	S121K_V133G_S176R	L124R_A125R	V133G_S176D_T178D	Combination
9119-9375	L124E_H172R	V133G_S176R	L124R_H172T	V133G_N137K_S174R_S176D	Combination
9118-6098	L124E_H172R	V133G_S176R	L124R_H172T	V133G_S174R_S176D	Combination
9117-9374	L124E_H172R	V133G_S176K	L124R_H172T	V133G_N137K_S174R_S176D	Combination
9120-9370	L124E_H172T	V133G_N137K_S174R_S176R	L124R_H172R	V133G_S176D	Combination
9122-9371	L124E_H172T	V133G_S174R_S176R	L124R_H172R	V133G_S176D	Combination
9121-9373	L124E_H172T	V133G_N137K_S174R_S176R	L124R_H172R	V133G_S176D_T178D	Combination



9111-9347	L124E_A125S_H172R_K228D	S121K_V133G_S176R	L124R_A125R_H172T	V133G_N137K_S174R_S176D	Combination
9112-9348	L124E_A125S_H172T_K228D	L124K_V133G_N137K_S174R_S176R	L124R_A125R_H172R	V133G_S176D	Combination
9115-9348	L124E_A139W	F116A_V133G_L135A_S176R	L124R_A139G_V190A	V133G_L135W_S176D	Combination
9116-9349	L124E_A139W	F116A_V133G_L135V_S176R	L124R_A139G_V190A	V133G_S176D	Combination
9140-9481	L124E_K145T_Q179E	S131K_V133G_S176R	L124R_S186K	V133G_S176D_T178D_T180E	Combination
9146-9498	L124E_K145T_Q179E	S131K_V133G_S176R	L124R_S186K	V133G_S176D_T180E	Combination
9134-9466	L124E_K145T_Q179E	S131K_V133G_S176R	L124R_S186K	V133G_S176D_T178D	Combination
9136-9459	L124E_K145T_Q179E	S131K_V133G_S176R	L124R_S186K	Q124E_V133G_S176D_T178D_T180E	Combination
9158-9483	L124E_K145T_Q179E	S131R_V133G_S176R	L124R_S186K	V133G_S176D_T178D_T180E	Combination
9164-9500	L124E_K145T_Q179E	S131R_V133G_S176R	L124R_S186K	V133G_S176D_T180E	Combination
9150-9468	L124E_K145T_Q179E	S131R_V133G_S176R	L124R_S186K	V133G_S176D_T178D	Combination
9152-9460	L124E_K145T_Q179E	S131R_V133G_S176R	L124R_S186K	Q124E_V133G_S176D_T178D_T180E	Combination
9140-9536	L124E_K145T_Q179E	S131K_V133G_S176R	L124R_S186R	V133G_S176D_T180E	Combination
9146-9553	L124E_K145T_Q179E	S131K_V133G_S176R	L124R_S186R	V133G_S176D_T180E	Combination
9134-9521	L124E_K145T_Q179E	S131K_V133G_S176R	L124R_S186R	V133G_S176D_T178D	Combination
9136-9513	L124E_K145T_Q179E	S131K_V133G_S176R	L124R_S186R	Q124E_V133G_S176D_T178D_T180E	Combination
9158-9538	L124E_K145T_Q179E	S131R_V133G_S176R	L124R_S186R	V133G_S176D_T178D_T180E	Combination
9164-9555	L124E_K145T_Q179E	S131R_V133G_S176R	L124R_S186R	V133G_S176D_T180E	Combination
9150-9523	L124E_K145T_Q179E	S131R_V133G_S176R	L124R_S186R	V133G_S176D_T178D	Combination
9152-9515	L124E_K145T_Q179E	S131R_V133G_S176R	L124R_S186R	Q124E_V133G_S176D_T178D_T180E	Combination
9127-9481	L124E_K145M_Q179E	S131K_V133G_S176R	L124R_S186K	V133G_S176D_T178D_T180E	Combination/optimization
9131-9498	L124E_K145M_Q179E	S131K_V133G_S176R	L124R_S186K	V133G_S176D_T180E	Combination/optimization
9123-9466	L124E_K145M_Q179E	S131K_V133G_S176R	L124R_S186K	V133G_S176D_T178D	Combination/optimization
9127-9536	L124E_K145M_Q179E	S131K_V133G_S176R	L124R_S186R	V133G_S176D_T178D_T180E	Combination/optimization
9131-9553	L124E_K145M_Q179E	S131K_V133G_S176R	L124R_S186R	V133G_S176D_T180E	Combination/optimization
9123-9521	L124E_K145M_Q179E	S131K_V133G_S176R	L124R_S186R	V133G_S176D_T178D	Combination/optimization
9125-9513	L124E_K145M_Q179E	S131K_V133G_S176R	L124R_S186R	Q124E_V133G_S176D_T178D_T180E	Combination/optimization
9296-9505	L124E_L143E_K145T	Q124K_V133G_S176R_T178K	L124R_S186R	Q124E_V133G_S176D_T178D_T180E	Combination
9308-9547	L124E_L143E_K145T	Q124K_V133G_S176R_T178K	L124R_S186R	V133G_S176D_T180E	Combination
9300-9528	L124E_L143E_K145T	Q124K_V133G_S176R_T178K	L124R_S186R	V133G_S176D_T178D_T180E	Combination
9294-9519	L124E_L143E_K145T	Q124K_V133G_S176R_T178K	L124R_S186R	V133G_S176D_T178D	Combination
9304-9542	L124E_L143E_K145T	Q124K_V133G_S176R_T178K	L124R_S186R	V133G_S176D_T178E_T180E	Combination
9314-9509	L124E_L143E_K145T	Q124K_V133G_S176R_T178R	L124R_S186R	Q124E_V133G_S176D_T178D_T180E	Combination
9323-9550	L124E_L143E_K145T	Q124K_V133G_S176R_T178R	L124R_S186R	V133G_S176D_T180E	Combination
9317-9532	L124E_L143E_K145T	Q124K_V133G_S176R_T178R	L124R_S186R	V133G_S176D_T178D_T180E	Combination
9312-9520	L124E_L143E_K145T	Q124K_V133G_S176R_T178R	L124R_S186R	V133G_S176D_T178D	Combination
9320-9543	L124E_L143E_K145T	Q124K_V133G_S176R_T178R	L124R_S186R	V133G_S176D_T178E_T180E	Combination
9281-9503	L124E_L143E_K145T	Q124K_V133G_S176R	L124R_S186R	Q124E_V133G_S176D_T178D_T180E	Combination
9290-9546	L124E_L143E_K145T	Q124K_V133G_S176R	L124R_S186R	V133G_S176D_T180E	Combination
9284-9526	L124E_L143E_K145T	Q124K_V133G_S176R	L124R_S186R	V133G_S176D_T178D_T180E	Combination
9279-9518	L124E_L143E_K145T	Q124K_V133G_S176R	L124R_S186R	V133G_S176D_T178D	Combination

9287-9541	L124E_L143E_K145T	Q124K_V133G_S176R	L124R_S186R	V133G_S176D_T178E_T180E	Combination
9296-9451	L124E_L143E_K145T	Q124K_V133G_S176R_T178K	L124R_S186K	Q124E_V133G_S176D_T178D_T180E	Combination
9308-9492	L124E_L143E_K145T	Q124K_V133G_S176R_T178K	L124R_S186K	Q124E_V133G_S176D_T180E	Combination
9300-9473	L124E_L143E_K145T	Q124K_V133G_S176R_T178K	L124R_S186K	Q124E_V133G_S176D_T178D_T180E	Combination
9294-9464	L124E_L143E_K145T	Q124K_V133G_S176R_T178K	L124R_S186K	Q124E_V133G_S176D_T178D_T180E	Combination
9304-9487	L124E_L143E_K145T	Q124K_V133G_S176R_T178K	L124R_S186K	Q124E_V133G_S176D_T178D_T180E	Combination
9314-9455	L124E_L143E_K145T	Q124K_V133G_S176R_T178R	L124R_S186K	Q124E_V133G_S176D_T178D_T180E	Combination
9323-9495	L124E_L143E_K145T	Q124K_V133G_S176R_T178R	L124R_S186K	Q124E_V133G_S176D_T180E	Combination
9317-9475	L124E_L143E_K145T	Q124K_V133G_S176R_T178R	L124R_S186K	Q124E_V133G_S176D_T178D_T180E	Combination
9312-9465	L124E_L143E_K145T	Q124K_V133G_S176R_T178R	L124R_S186K	Q124E_V133G_S176D_T178D	Combination
9320-9488	L124E_L143E_K145T	Q124K_V133G_S176R_T178R	L124R_S186K	Q124E_V133G_S176D_T178E_T180E	Combination
9281-9449	L124E_L143E_K145T	Q124K_V133G_S176R	L124R_S186K	Q124E_V133G_S176D_T178D_T180E	Combination
9290-9491	L124E_L143E_K145T	Q124K_V133G_S176R	L124R_S186K	Q124E_V133G_S176D_T180E	Combination
9284-9471	L124E_L143E_K145T	Q124K_V133G_S176R	L124R_S186K	Q124E_V133G_S176D_T178D_T180E	Combination
9279-9463	L124E_L143E_K145T	Q124K_V133G_S176R	L124R_S186K	Q124E_V133G_S176D_T178E_T180E	Combination
9287-9486	L124E_L143E_K145T	Q124K_V133G_S176R	L124R_S186K	Q124E_V133G_S176D_T178E_T180E	Combination
9264-9509	L124E_L143E_K145M	Q124K_V133G_S176R_T178R	L124R_S186R	Q124E_V133G_S176D_T178D_T180E	Combination/optimization
9267-9502	L124E_L143E_K145M	Q124K_V133G_S176R_T178R	L124R_S186R	Q124E_V133G_S176D_T180E	Combination/optimization
9250-9503	L124E_L143E_K145M	Q124K_V133G_S176R	L124R_S186R	Q124E_V133G_S176D_T178D_T180E	Combination/optimization
9253-9525	L124E_L143E_K145M	Q124K_V133G_S176R	L124R_S186R	Q124E_V133G_S176D_T180E	Combination/optimization
9257-9505	L124E_L143E_K145M	Q124K_V133G_S176R_T178K	L124R_S186R	Q124E_V133G_S176D_T178D_T180E	Combination/optimization
9260-9528	L124E_L143E_K145M	Q124K_V133G_S176R_T178K	L124R_S186R	Q124E_V133G_S176D_T180E	Combination/optimization
9264-9455	L124E_L143E_K145M	Q124K_V133G_S176R_T178R	L124R_S186K	Q124E_V133G_S176D_T178D_T180E	Combination/optimization
9267-9477	L124E_L143E_K145M	Q124K_V133G_S176R_T178R	L124R_S186K	Q124E_V133G_S176D_T178D_T180E	Combination/optimization
9250-9449	L124E_L143E_K145M	Q124K_V133G_S176R	L124R_S186K	Q124E_V133G_S176D_T178D_T180E	Combination/optimization
9253-9471	L124E_L143E_K145M	Q124K_V133G_S176R	L124R_S186K	Q124E_V133G_S176D_T180E	Combination/optimization
9257-9451	L124E_L143E_K145M	Q124K_V133G_S176R_T178K	L124R_S186K	Q124E_V133G_S176D_T178D_T180E	Combination/optimization
9260-9473	L124E_L143E_K145M	Q124K_V133G_S176R_T178K	L124R_S186K	Q124E_V133G_S176D_T180E	Combination/optimization
9214-9505	L124E_L143D_K145T	Q124K_V133G_S176R_T178K	L124R_S186R	Q124E_V133G_S176D_T178D_T180E	Combination/optimization
9223-9509	L124E_L143D_K145T	Q124K_V133G_S176R_T178R	L124R_S186R	Q124E_V133G_S176D_T178D_T180E	Combination/optimization
9217-9528	L124E_L143D_K145T	Q124K_V133G_S176R_T178K	L124R_S186R	Q124E_V133G_S176D_T180E	Combination/optimization
9226-9532	L124E_L143D_K145T	Q124K_V133G_S176R_T178R	L124R_S186R	Q124E_V133G_S176D_T178D_T180E	Combination/optimization
9220-9547	L124E_L143D_K145T	Q124K_V133G_S176R_T178K	L124R_S186R	Q124E_V133G_S176D_T180E	Combination/optimization
9229-9550	L124E_L143D_K145T	Q124K_V133G_S176R_T178R	L124R_S186R	Q124E_V133G_S176D_T180E	Combination/optimization
9234-9516	L124E_L143D_K145T	V133G_S176R_T178K	L124R_S186R	Q124E_V133G_S176D_T178D_T180E	Combination/optimization
9243-9556	L124E_L143D_K145T	V133G_S176R_T178K	L124R_S186R	Q124E_V133G_S176D_T180E	Combination/optimization
9237-9539	L124E_L143D_K145T	Q124K_V176R_T178K	L124R_S186R	Q124E_V133G_S176D_T178D_T180E	Combination/optimization
9232-9524	L124E_L143D_K145T	V133G_S176R_T178K	L124R_S186R	Q124E_V133G_S176D_T178D_T180E	Combination/optimization
9240-9544	L124E_L143D_K145T	V133G_S176R_T178K	L124R_S186R	Q124E_V133G_S176D_T178E_T180E	Combination/optimization
9214-9451	L124E_L143D_K145T	Q124K_V133G_S176R_T178K	L124R_S186K	Q124E_V133G_S176D_T178D_T180E	Combination/optimization
9223-9455	L124E_L143D_K145T	Q124K_V133G_S176R_T178R	L124R_S186K	Q124E_V133G_S176D_T178D_T180E	Combination/optimization

9217-9473	L124E_L143D_K145T	Q124K_V133G_S176R_T178K	L124R_S186K	V133G_S176D_T178D_T180E	Combination/Optimization
9226-9477	L124E_L143D_K145T	Q124K_V133G_S176R_T178R	L124R_S186K	V133G_S176D_T178D_T180E	Combination/Optimization
9220-9492	L124E_L143D_K145T	Q124K_V133G_S176R_T178K	L124R_S186K	V133G_S176D_T180E	Combination/Optimization
9229-9495	L124E_L143D_K145T	Q124K_V133G_S176R_T178R	L124R_S186K	V133G_S176D_T180E	Combination/Optimization
9234-9461	L124E_L143D_K145T	V133G_S176R_T178K	L124R_S186K	Q124E_V133G_S176D_T178D_T180E	Combination/Optimization
9243-9501	L124E_L143D_K145T	V133G_S176R_T178K	L124R_S186K	V133G_S176D_T180E	Combination/Optimization
9237-9484	L124E_L143D_K145T	V133G_S176R_T178K	L124R_S186K	V133G_S176D_T178D_T180E	Combination/Optimization
9232-9469	L124E_L143D_K145T	V133G_S176R_T178K	L124R_S186K	V133G_S176D_T178D	Combination/Optimization
9240-9489	L124E_L143D_K145T	V133G_S176R_T178K	L124R_S186K	V133G_S176D_T178E_T180E	Combination/Optimization
9176-9505	L124E_L143D_K145M	Q124K_V133G_S176R_T178K	L124R_S186R	Q124E_V133G_S176D_T178D_T180E	Combination/Optimization
9185-9509	L124E_L143D_K145M	Q124K_V133G_S176R_T178R	L124R_S186R	Q124E_V133G_S176D_T178D_T180E	Combination/Optimization
9179-9528	L124E_L143D_K145M	Q124K_V133G_S176R_T178K	L124R_S186R	V133G_S176D_T178D_T180E	Combination/Optimization
9188-9532	L124E_L143D_K145M	Q124K_V133G_S176R_T178R	L124R_S186R	V133G_S176D_T178D_T180E	Combination/Optimization
9182-9547	L124E_L143D_K145M	Q124K_V133G_S176R_T178K	L124R_S186R	V133G_S176D_T180E	Combination/Optimization
9191-9550	L124E_L143D_K145M	Q124K_V133G_S176R_T178R	L124R_S186R	V133G_S176D_T180E	Combination/Optimization
9196-9516	L124E_L143D_K145M	V133G_S176R_T178K	L124R_S186R	Q124E_V133G_S176D_T178D_T180E	Combination/Optimization
9205-9556	L124E_L143D_K145M	V133G_S176R_T178K	L124R_S186R	V133G_S176D_T180E	Combination/Optimization
9199-9539	L124E_L143D_K145M	V133G_S176R_T178K	L124R_S186R	V133G_S176D_T178D_T180E	Combination/Optimization
9194-9524	L124E_L143D_K145M	V133G_S176R_T178K	L124R_S186R	V133G_S176D_T178D	Combination/Optimization
9202-9544	L124E_L143D_K145M	V133G_S176R_T178K	L124R_S186R	V133G_S176D_T178E_T180E	Combination/Optimization
9176-9451	L124E_L143D_K145M	Q124K_V133G_S176R_T178K	L124R_S186K	Q124E_V133G_S176D_T178D_T180E	Combination/Optimization
9185-9455	L124E_L143D_K145M	Q124K_V133G_S176R_T178R	L124R_S186K	Q124E_V133G_S176D_T178D_T180E	Combination/Optimization
9179-9473	L124E_L143D_K145M	Q124K_V133G_S176R_T178R	L124R_S186K	V133G_S176D_T178D_T180E	Combination/Optimization
9188-9477	L124E_L143D_K145M	Q124K_V133G_S176R_T178R	L124R_S186K	V133G_S176D_T178D_T180E	Combination/Optimization
9182-9492	L124E_L143D_K145M	Q124K_V133G_S176R_T178K	L124R_S186K	V133G_S176D_T180E	Combination/Optimization
9191-9495	L124E_L143D_K145M	Q124K_V133G_S176R_T178R	L124R_S186K	V133G_S176D_T180E	Combination/Optimization
9196-9461	L124E_L143D_K145M	V133G_S176R_T178K	L124R_S186K	Q124E_V133G_S176D_T178D_T180E	Combination/Optimization
9205-9501	L124E_L143D_K145M	V133G_S176R_T178K	L124R_S186K	V133G_S176D_T180E	Combination/Optimization
9199-9484	L124E_L143D_K145M	V133G_S176R_T178K	L124R_S186K	V133G_S176D_T178D_T180E	Combination/Optimization
9194-9469	L124E_L143D_K145M	V133G_S176R_T178K	L124R_S186K	V133G_S176D_T178D	Combination/Optimization
9202-9489	L124E_L143D_K145M	V133G_S176R_T178K	L124R_S186K	V133G_S176D_T178E_T180E	Combination/Optimization
9273-9396	L124E_L143E_K145T	Q124K_V133G_Q160K_S176R	L124R_Q179K	V133G_S176D_T178E	Combination/Optimization
9271-9376	L124E_L143E_K145T	Q124K_V133G_Q160K_S176R	L124R_Q179K	Q124E_V133G_S176D_T178E_T180E	Combination/Optimization
9275-9419	L124E_L143E_K145T	Q124K_V133G_Q160K_S176R	L124R_Q179K	V133G_S176D_T178E_T180E	Combination/Optimization
9277-9428	L124E_L143E_K145T	Q124K_V133G_Q160K_S176R	L124R_Q179K	V133G_S176D_T180E	Combination/Optimization
9302-9406	L124E_L143E_K145T	Q124K_V133G_S176R_T178K	L124R_Q179K	V133G_S176D_T178E	Combination/Optimization
9298-9384	L124E_L143E_K145T	Q124K_V133G_S176R_T178K	L124R_Q179K	Q124E_V133G_S176D_T178E_T180E	Combination/Optimization
9304-9421	L124E_L143E_K145T	Q124K_V133G_S176R_T178K	L124R_Q179K	V133G_S176D_T178E_T180E	Combination/Optimization
9308-9436	L124E_L143E_K145T	Q124K_V133G_S176R_T178K	L124R_Q179K	V133G_S176D_T180E	Combination/Optimization
9319-9410	L124E_L143E_K145T	Q124K_V133G_S176R_T178R	L124R_Q179K	V133G_S176D_T178E	Combination/Optimization
9316-9388	L124E_L143E_K145T	Q124K_V133G_S176R_T178R	L124R_Q179K	Q124E_V133G_S176D_T178E_T180E	Combination/Optimization

9320-9422	L124E_L143E_K145T	Q124K_V133G_S176R_T178R	L124R_Q179K	V133G_S176D_T178E_T180E	Combination/optimization
9323-9440	L124E_L143E_K145T	Q124K_V133G_S176R_T178R	L124R_Q179K	V133G_S176D_T180E	Combination/optimization
9286-9402	L124E_L143E_K145T	Q124K_V133G_S176R	L124R_Q179K	V133G_S176D_T178E	Combination/optimization
9283-9380	L124E_L143E_K145T	Q124K_V133G_S176R	L124R_Q179K	Q124E_V133G_S176D_T178E_T180E	Combination/optimization
9287-9420	L124E_L143E_K145T	Q124K_V133G_S176R	L124R_Q179K	V133G_S176D_T178E_T180E	Combination/optimization
9290-9432	L124E_L143E_K145T	Q124K_V133G_S176R	L124R_Q179K	V133G_S176D_T180E	Combination/optimization
9248-9398	L124E_L143E_K145M	Q124K_V133G_Q160K_S176R	L124R_Q179K	V133G_S176D_T178E	Combination/optimization
9247-9376	L124E_L143E_K145M	Q124K_V133G_Q160K_S176R	L124R_Q179K	Q124E_V133G_S176D_T178E_T180E	Combination/optimization
9249-9428	L124E_L143E_K145M	Q124K_V133G_Q160K_S176R	L124R_Q179K	V133G_S176D_T180E	Combination/optimization
9262-9406	L124E_L143E_K145M	Q124K_V133G_S176R_T178K	L124R_Q179K	V133G_S176D_T178E	Combination/optimization
9259-9384	L124E_L143E_K145M	Q124K_V133G_S176R_T178K	L124R_Q179K	Q124E_V133G_S176D_T178E_T180E	Combination/optimization
9263-9436	L124E_L143E_K145M	Q124K_V133G_S176R_T178K	L124R_Q179K	V133G_S176D_T180E	Combination/optimization
9269-9410	L124E_L143E_K145M	Q124K_V133G_S176R_T178R	L124R_Q179K	V133G_S176D_T178E	Combination/optimization
9266-9388	L124E_L143E_K145M	Q124K_V133G_S176R_T178R	L124R_Q179K	Q124E_V133G_S176D_T178E_T180E	Combination/optimization
9270-9440	L124E_L143E_K145M	Q124K_V133G_S176R_T178R	L124R_Q179K	V133G_S176D_T180E	Combination/optimization
9255-9402	L124E_L143E_K145M	Q124K_V133G_S176R	L124R_Q179K	V133G_S176D_T178E	Combination/optimization
9252-9380	L124E_L143E_K145M	Q124K_V133G_S176R	L124R_Q179K	Q124E_V133G_S176D_T178E_T180E	Combination/optimization
9256-9432	L124E_L143E_K145M	Q124K_V133G_S176R	L124R_Q179K	V133G_S176D_T180E	Combination/optimization
9209-9398	L124E_L143D_K145T	Q124K_V133G_Q160K_S176R	L124R_Q179K	V133G_S176D_T178E	Combination/optimization
9208-9376	L124E_L143D_K145T	Q124K_V133G_Q160K_S176R	L124R_Q179K	Q124E_V133G_S176D_T178E_T180E	Combination/optimization
9210-9428	L124E_L143D_K145T	Q124K_V133G_Q160K_S176R	L124R_Q179K	V133G_S176D_T180E	Combination/optimization
9219-9406	L124E_L143D_K145T	Q124K_V133G_S176R_T178K	L124R_Q179K	V133G_S176D_T178E	Combination/optimization
9216-9432	L124E_L143D_K145T	Q124K_V133G_S176R_T178K	L124R_Q179K	Q124E_V133G_S176D_T178E_T180E	Combination/optimization
9220-9436	L124E_L143D_K145T	Q124K_V133G_S176R_T178K	L124R_Q179K	V133G_S176D_T180E	Combination/optimization
9228-9410	L124E_L143D_K145T	Q124K_V133G_S176R_T178R	L124R_Q179K	V133G_S176D_T178E	Combination/optimization
9225-9388	L124E_L143D_K145T	Q124K_V133G_S176R_T178R	L124R_Q179K	Q124E_V133G_S176D_T178E_T180E	Combination/optimization
9229-9440	L124E_L143D_K145T	Q124K_V133G_S176R_T178R	L124R_Q179K	V133G_S176D_T180E	Combination/optimization
9212-9402	L124E_L143D_K145T	Q124K_V133G_S176R	L124R_Q179K	V133G_S176D_T178E	Combination/optimization
9211-9380	L124E_L143D_K145T	Q124K_V133G_S176R	L124R_Q179K	Q124E_V133G_S176D_T178E_T180E	Combination/optimization
9213-9432	L124E_L143D_K145T	Q124K_V133G_S176R	L124R_Q179K	V133G_S176D_T180E	Combination/optimization
9239-9417	L124E_L143D_K145T	V133G_S176R_T178K	L124R_Q179K	V133G_S176D_T178E	Combination/optimization
9236-9395	L124E_L143D_K145T	V133G_S176R_T178K	L124R_Q179K	Q124E_V133G_S176D_T178E_T180E	Combination/optimization
9240-9426	L124E_L143D_K145T	V133G_S176R_T178K	L124R_Q179K	V133G_S176D_T180E	Combination/optimization
9243-9447	L124E_L143D_K145T	V133G_S176R_T178K	L124R_Q179K	V133G_S176D_T180E	Combination/optimization
9171-9398	L124E_L143D_K145M	Q124K_V133G_Q160K_S176R	L124R_Q179K	V133G_S176D_T178E	Combination/optimization
9170-9376	L124E_L143D_K145M	Q124K_V133G_Q160K_S176R	L124R_Q179K	Q124E_V133G_S176D_T178E_T180E	Combination/optimization
9172-9428	L124E_L143D_K145M	Q124K_V133G_Q160K_S176R	L124R_Q179K	V133G_S176D_T180E	Combination/optimization
9181-9406	L124E_L143D_K145M	Q124K_V133G_S176R_T178K	L124R_Q179K	V133G_S176D_T178E	Combination/optimization
9178-9384	L124E_L143D_K145M	Q124K_V133G_S176R_T178K	L124R_Q179K	Q124E_V133G_S176D_T178E_T180E	Combination/optimization
9182-9436	L124E_L143D_K145M	Q124K_V133G_S176R_T178K	L124R_Q179K	V133G_S176D_T180E	Combination/optimization
9190-9410	L124E_L143D_K145M	Q124K_V133G_S176R_T178R	L124R_Q179K	V133G_S176D_T178E	Combination/optimization

9187-9388	L124E_L143D_K145M	Q124K_V133G_S176R_T178R	L124R_Q179K	Q124E_V133G_S176D_T178E_T180E	Combination/optimization
9191-9440	L124E_L143D_K145M	Q124K_V133G_S176R_T178R	L124R_Q179K	V133G_S176D_T180E	Combination/optimization
9174-9402	L124E_L143D_K145M	Q124K_V133G_S176R	L124R_Q179K	V133G_S176D_T178E	Combination/optimization
9173-9380	L124E_L143D_K145M	Q124K_V133G_S176R	L124R_Q179K	Q124E_V133G_S176D_T178E_T180E	Combination/optimization
9175-9432	L124E_L143D_K145M	Q124K_V133G_S176R	L124R_Q179K	V133G_S176D_T180E	Combination/optimization
9201-9417	L124E_L143D_K145M	V133G_S176R_T178K	L124R_Q179K	V133G_S176D_T178E	Combination/optimization
9198-9395	L124E_L143D_K145M	V133G_S176R_T178K	L124R_Q179K	Q124E_V133G_S176D_T178E_T180E	Combination/optimization
9202-9426	L124E_L143D_K145M	V133G_S176R_T178K	L124R_Q179K	V133G_S176D_T180E	Combination/optimization
9205-9447	L124E_L143D_K145M	V133G_S176R_T178K	L124R_Q179K	V133G_S176D_T180E	Combination/optimization
9273-9355	L124E_L143E_K145T	Q124K_V133G_Q160K_S176R	L124R_D146N_Q179K	V133G_S176D_T178E	Combination/optimization
9271-9350	L124E_L143E_K145T	Q124K_V133G_Q160K_S176R	L124R_D146N_Q179K	Q124E_V133G_S176D_T178E_T180E	Combination/optimization
9277-9359	L124E_L143E_K145T	Q124K_V133G_Q160K_S176R	L124R_D146N_Q179K	V133G_S176D_T180E	Combination/optimization
9302-9356	L124E_L143E_K145T	Q124K_V133G_S176R_T178K	L124R_D146N_Q179K	V133G_S176D_T178E	Combination/optimization
9298-9351	L124E_L143E_K145T	Q124K_V133G_S176R_T178K	L124R_D146N_Q179K	Q124E_V133G_S176D_T178E_T180E	Combination/optimization
9304-9360	L124E_L143E_K145T	Q124K_V133G_S176R_T178K	L124R_D146N_Q179K	V133G_S176D_T180E	Combination/optimization
9308-9365	L124E_L143E_K145T	Q124K_V133G_S176R_T178K	L124R_D146N_Q179K	V133G_S176D_T180E	Combination/optimization
9290-9364	L124E_L143E_K145T	Q124K_V133G_S176R	L124R_D146N_Q179K	V133G_S176D_T180E	Combination/optimization
9243-9368	L124E_L143D_K145T	V133G_S176R_T178K	L124R_D146N_Q179K	V133G_S176D_T180E	Combination/optimization
9142-9414	L124E_K145T_Q179E	S131K_V133G_S176R	L124R_Q179K	V133G_S176D_T178E	Combination/optimization
9138-9392	L124E_K145T_Q179E	S131K_V133G_S176R	L124R_Q179K	Q124E_V133G_S176D_T178E_T180E	Combination/optimization
9144-9423	L124E_K145T_Q179E	S131K_V133G_S176R	L124R_Q179K	V133G_S176D_T180E	Combination/optimization
9146-9444	L124E_K145T_Q179E	S131K_V133G_S176R	L124R_Q179K	V133G_S176D_T180E	Combination/optimization
9160-9416	L124E_K145T_Q179E	S131R_V133G_S176R	L124R_Q179K	V133G_S176D_T178E	Combination/optimization
9154-9394	L124E_K145T_Q179E	S131R_V133G_S176R	L124R_Q179K	Q124E_V133G_S176D_T178E_T180E	Combination/optimization
9162-9425	L124E_K145T_Q179E	S131R_V133G_S176R	L124R_Q179K	V133G_S176D_T180E	Combination/optimization
9164-9446	L124E_K145T_Q179E	S131R_V133G_S176R	L124R_Q179K	V133G_S176D_T180E	Combination/optimization
9156-9397	L124E_K145T_Q179E	S131R_V133G_S176R	L124R_Q179K	V133G_Q160E_S176D_T180E	Combination/optimization
9129-9414	L124E_K145M_Q179E	S131K_V133G_S176R	L124R_Q179K	V133G_S176D_T178E	Combination/optimization
9126-9392	L124E_K145M_Q179E	S131K_V133G_S176R	L124R_Q179K	Q124E_V133G_S176D_T178E_T180E	Combination/optimization
9130-9423	L124E_K145M_Q179E	S131K_V133G_S176R	L124R_Q179K	V133G_S176D_T180E	Combination/optimization
9131-9444	L124E_K145M_Q179E	S131K_V133G_S176R	L124R_Q179K	V133G_S176D_T180E	Combination/optimization
9142-9357	L124E_K145T_Q179E	S131K_V133G_S176R	L124R_D146N_Q179K	V133G_S176D_T178E	Combination/optimization
9138-9352	L124E_K145T_Q179E	S131K_V133G_S176R	L124R_D146N_Q179K	Q124E_V133G_S176D_T178E_T180E	Combination/optimization
9144-9361	L124E_K145T_Q179E	S131K_V133G_S176R	L124R_D146N_Q179K	V133G_S176D_T178E_T180E	Combination/optimization
9146-9366	L124E_K145T_Q179E	S131K_V133G_S176R	L124R_D146N_Q179K	V133G_S176D_T180E	Combination/optimization
9160-9358	L124E_K145T_Q179E	S131R_V133G_S176R	L124R_D146N_Q179K	V133G_S176D_T178E	Combination/optimization
9154-9353	L124E_K145T_Q179E	S131R_V133G_S176R	L124R_D146N_Q179K	Q124E_V133G_S176D_T178E_T180E	Combination/optimization
9162-9362	L124E_K145T_Q179E	S131R_V133G_S176R	L124R_D146N_Q179K	V133G_S176D_T178E_T180E	Combination/optimization
9164-9367	L124E_K145T_Q179E	S131R_V133G_S176R	L124R_D146N_Q179K	V133G_S176D_T180E	Combination/optimization
9156-9354	L124E_K145T_Q179E	S131R_V133G_S176R	L124R_D146N_Q179K	V133G_Q160E_S176D_T180E	Combination/optimization

9814-9828	Q39E_K145T_Q179E	Q38R_S131K	Q39R_S186R	Q38E_Q124E_Q160E_T180E	Combination
9817-9822	Q39E_L143E_K145T	Q38R_Q124R_Q160K_T178R	Q39R_D146G_Q179K	Q38E_Q124E_Q160E_T180E	Combination
9820-9827	Q39E_L143E_K145T_Q179E	Q38R_Q124R_Q160K_T178R	Q39R_Q179K	Q38E_Q124E_Q160E_T180E	Combination
9815-9825	Q39E_L124E	Q38R_V133G_S176R	Q39R_L124R	Q38E_V133G_S176D	Combination
9746-9905	L45P_K145T_Q179E	P44F_S131K	S186R	Q38E_Q124E_Q160E_T180E	Combination
9751-9065	L45P_L143E_K145T	P44F_Q124R_Q160K_T178R	D146G_Q179K	Q38E_Q124E_Q160E_T180E	Combination
9754-9760	L45P_L143E_K145T_Q179E	P44F_Q124R_Q160K_T178R	Q179K	Q124E_Q160E_T180E	Combination
9747-9334	L45P_L124E	P44F_V133G_S176R	L124R	V133G_S176D	Combination
9748-9338	L45P_L124E	P44F_V133G_S176R	L124R	V133G_S176D_T178D	Combination
9813-9824	Q39E_K145T_H172R_Q179E	Q38R_S131K	Q39R_H172R_S186R	Q38E_Q124E_Q160E_T180E	Combination
9818-9821	Q39E_L143E_K145T_H172R	Q38R_Q124R_Q160K_T178R	Q39R_D146G_H172R_Q179K	Q38E_Q124E_Q160E_T180E	Combination
9819-9823	Q39E_L143E_K145T_H172R_Q179E	Q38R_Q124R_Q160K_T178R	Q39R_H172R_Q179K	Q38E_Q124E_Q160E_T180E	Combination
9816-9826	Q39E_L124E_H172R	Q38R_V133G_S176R	Q39R_L124R_H172R	Q38E_V133G_S176D	Combination
9745-9075	L45P_K145T_H172R_Q179E	P44F_S131K	H172R_S186R	Q38E_Q124E_Q160E_T180E	Combination
9752-9064	L45P_L143E_K145T_H172R	P44F_Q124R_Q160K_T178R	D146G_H172R_Q179K	Q38E_Q124E_Q160E_T180E	Combination
9753-9074	L45P_L143E_K145T_H172R_Q179E	P44F_Q124R_Q160K_T178R	H172R_Q179K	Q124E_Q160E_T180E	Combination
9749-9369	L45P_L124E_H172R	P44F_V133G_S176R	L124R_H172R	V133G_S176D	Combination
9750-9372	L45P_L124E_H172R	P44F_V133G_S176R	L124R_H172R	V133G_S176D_T178D	Combination
9079-9878	K145T_Q179E	S131K	S186R	Q124E_Q160E_T180E	Optimization
9079-9840	K145T_Q179E	S131K	S186K	Q124E_Q160E_T180E	Optimization
9082-9900	K145T_Q179E	S131K	S186R	Q124E_T180E	Optimization
9082-9862	K145T_Q179E	S131K	S186K	Q124E_T180E	Optimization
9079-9772	K145T_Q179E	S131K	Q179K	Q124E_Q160E_T180E	Combination/optimization
9082-9796	K145T_Q179E	S131K	Q179K	Q124E_T180E	Combination/optimization
9590-9871	L143E_K145T	Q124R_Q160K_T178R	S186R	Q124E_Q160E_T180E	Combination/optimization
9590-9833	L143E_K145T	Q124R_Q160K_T178R	S186K	Q124E_Q160E_T180E	Combination/optimization
9606-9893	L143E_K145T	Q124R_Q160K_T178R	S186R	Q124E_T180E	Optimization
9606-9855	L143E_K145T	Q124R_Q160K_T178R	S186K	Q124E_T180E	Optimization
9590-9763	L143E_K145T	Q124R_Q160K_T178R	Q179K	Q124E_Q160E_T180E	Combination/optimization
9606-9789	L143E_K145T	Q124R_Q160K_T178R	Q179K	Q124E_T180E	Combination/optimization
9651-9871	L143E_K145T_Q179E	Q124R_Q160K_T178R	S186R	Q124E_Q160E_T180E	Optimization
9651-9833	L143E_K145T_Q179E	Q124R_Q160K_T178R	S186K	Q124E_Q160E_T180E	Optimization
9654-9893	L143E_K145T_Q179E	Q124R_Q160K_T178R	S186R	Q124E_T180E	Optimization
9654-9855	L143E_K145T_Q179E	Q124R_Q160K_T178R	S186K	Q124E_T180E	Optimization
9651-9763	L143E_K145T_Q179E	Q124R_Q160K_T178R	Q179K	Q124E_Q160E_T180E	Combination/optimization
9654-9789	L143E_K145T_Q179E	Q124R_Q160K_T178R	Q179K	Q124E_T180E	Combination/optimization
9620-9871	L143E_K145T_Q179D	Q124R_Q160K_T178R	S186R	Q124E_Q160E_T180E	Optimization
9620-9833	L143E_K145T_Q179D	Q124R_Q160K_T178R	S186K	Q124E_Q160E_T180E	Optimization
9623-9893	L143E_K145T_Q179D	Q124R_Q160K_T178R	S186R	Q124E_T180E	Optimization
9623-9855	L143E_K145T_Q179D	Q124R_Q160K_T178R	S186K	Q124E_T180E	Optimization
9620-9763	L143E_K145T_Q179D	Q124R_Q160K_T178R	Q179K	Q124E_Q160E_T180E	Combination/optimization

9623-9789	L143E_K145T_Q179D	Q124R_Q160K_I178R	Q179K	Q124E_T180E	Combination/Optimization
9663-9876	L143E_K145T_Q179E	Q124R_I178R	S186R	Q124E_Q160E_T180E	Optimization
9663-9838	L143E_K145T_Q179E	Q124R_I178R	S186K	Q124E_Q160E_T180E	Optimization
9679-9898	L143E_K145T_Q179E	Q124R_I178R	S186R	Q124E_T180E	Optimization
9663-9769	L143E_K145T_Q179E	Q124R_I178R	Q179K	Q124E_Q160E_T180E	Combination/Optimization
9679-9794	L143E_K145T_Q179E	Q124R_I178R	Q179K	Q124E_T180E	Combination/Optimization
9632-9876	L143E_K145T_Q179D	Q124R_I178R	S186R	Q124E_Q160E_T180E	Optimization
9632-9838	L143E_K145T_Q179D	Q124R_I178R	S186K	Q124E_Q160E_T180E	Optimization
9635-9898	L143E_K145T_Q179D	Q124R_I178R	S186R	Q124E_T180E	Optimization
9635-9860	L143E_K145T_Q179D	Q124R_I178R	S186K	Q124E_T180E	Optimization
9632-9769	L143E_K145T_Q179D	Q124R_I178R	Q179K	Q124E_Q160E_T180E	Combination/Optimization
9657-9874	L143E_K145T_Q179E	Q124R_I178R	Q179K	Q124E_T180E	Combination/Optimization
9657-9836	L143E_K145T_Q179E	Q124R_I178K	S186R	Q124E_Q160E_T180E	Optimization
9660-9896	L143E_K145T_Q179E	Q124R_I178K	S186K	Q124E_T180E	Optimization
9660-9858	L143E_K145T_Q179E	Q124R_I178K	S186R	Q124E_T180E	Optimization
9657-9767	L143E_K145T_Q179E	Q124R_I178K	S186K	Q124E_T180E	Optimization
9660-9792	L143E_K145T_Q179E	Q124R_I178K	Q179K	Q124E_Q160E_T180E	Combination/Optimization
9626-9874	L143E_K145T_Q179D	Q124R_I178K	Q179K	Q124E_T180E	Combination/Optimization
9626-9836	L143E_K145T_Q179D	Q124R_I178K	S186R	Q124E_Q160E_T180E	Optimization
9629-9896	L143E_K145T_Q179D	Q124R_I178K	S186K	Q124E_T180E	Optimization
9629-9858	L143E_K145T_Q179D	Q124R_I178K	S186R	Q124E_T180E	Optimization
9626-9767	L143E_K145T_Q179D	Q124R_I178K	Q179K	Q124E_Q160E_T180E	Combination/Optimization
9629-9792	L143E_K145T_Q179D	Q124R_I178K	Q179K	Q124E_T180E	Combination/Optimization
9645-9869	L143E_K145T_Q179E	Q124K_I178R	S186R	Q124E_Q160E_T180E	Optimization
9645-9831	L143E_K145T_Q179E	Q124K_I178R	S186K	Q124E_T180E	Optimization
9648-9891	L143E_K145T_Q179E	Q124K_I178R	S186R	Q124E_T180E	Optimization
9648-9853	L143E_K145T_Q179E	Q124K_I178R	S186K	Q124E_T180E	Optimization
9645-9761	L143E_K145T_Q179E	Q124K_I178R	Q179K	Q124E_Q160E_T180E	Combination/Optimization
9648-9787	L143E_K145T_Q179E	Q124K_I178R	Q179K	Q124E_T180E	Combination/Optimization
9614-9869	L143E_K145T_Q179D	Q124K_I178R	S186R	Q124E_Q160E_T180E	Optimization
9614-9831	L143E_K145T_Q179D	Q124K_I178R	S186K	Q124E_Q160E_T180E	Optimization
9617-9891	L143E_K145T_Q179D	Q124K_I178R	S186R	Q124E_T180E	Optimization
9617-9853	L143E_K145T_Q179D	Q124K_I178R	S186K	Q124E_T180E	Optimization
9614-9761	L143E_K145T_Q179D	Q124K_I178R	Q179K	Q124E_Q160E_T180E	Combination/Optimization
9617-9787	L143E_K145T_Q179D	Q124K_I178R	Q179K	Q124E_T180E	Combination/Optimization
9684-9901	L143E_K145T_Q179E	I178R	S186R	Q124E_T180E	Optimization
9684-9863	L143E_K145T_Q179E	I178R	S186K	Q124E_T180E	Optimization
9683-9773	L143E_K145T_Q179E	I178R	Q179K	Q124E_Q160E_T180E	Combination/Optimization
9684-9797	L143E_K145T_Q179E	I178R	Q179K	Q124E_T180E	Combination/Optimization

9638-9879	L143E_K145T_Q179D	T178R	S186R	Q124E_Q160E_T180E	Optimization
9638-9841	L143E_K145T_Q179D	T178R	S186K	Q124E_Q160E_T180E	Optimization
9641-9901	L143E_K145T_Q179D	T178R	S186R	Q124E_T180E	Optimization
9641-9863	L143E_K145T_Q179D	T178R	S186K	Q124E_T180E	Optimization
9638-9773	L143E_K145T_Q179D	T178R	Q179K	Q124E_Q160E_T180E	Combination/optimization
9641-9797	L143E_K145T_Q179D	T178R	Q179K	Q124E_T180E	Combination/optimization
9579-9901	L143D_K145T_Q179E	T178R	S186R	Q124E_T180E	Optimization
9579-9863	L143D_K145T_Q179E	T178R	S186K	Q124E_T180E	Optimization
9575-9879	L143D_K145T_Q179E	T178R	S186R	Q124E_Q160E_T180E	Optimization
9575-9841	L143D_K145T_Q179E	T178R	S186K	Q124E_Q160E_T180E	Optimization
9579-9901	L143D_K145T_Q179E	T178R	S186R	Q124E_T180E	Optimization
9579-9863	L143D_K145T_Q179E	T178R	S186K	Q124E_T180E	Optimization
9575-9773	L143D_K145T_Q179E	T178R	Q179K	Q124E_Q160E_T180E	Combination/optimization
9579-9797	L143D_K145T_Q179E	T178R	Q179K	Q124E_T180E	Combination/optimization
9598-9887	L143E_K145T	Q124R_Q160K_T178R	S186R	Q124E_T178E	Optimization
9598-9849	L143E_K145T	Q124R_Q160K_T178R	S186K	Q124E_T178E	Optimization
9598-9783	L143E_K145T	Q124R_Q160K_T178R	Q179K	Q124E_T178E	Combination/optimization
9598-9809	L143E_K145T	Q124R_Q160K_T178R	Q179R	Q124E_T178E	Combination/optimization
9602-9889	L143E_K145T	Q124R_Q160K_T178R	S186R	Q124E_T178E_T180E	Optimization
9602-9851	L143E_K145T	Q124R_Q160K_T178R	S186K	Q124E_T178E_T180E	Optimization
9602-9785	L143E_K145T	Q124R_Q160K_T178R	Q179K	Q124E_T178E_T180E	Combination/optimization
9602-9811	L143E_K145T	Q124R_Q160K_T178R	Q179R	Q124E_T178E_T180E	Combination/optimization
9594-9867	L143E_K145T	Q124R_Q160K_T178R	S186R	Q124E_Q160E_T178E	Optimization
9594-9829	L143E_K145T	Q124R_Q160K_T178R	S186K	Q124E_Q160E_T178E	Optimization
9594-9757	L143E_K145T	Q124R_Q160K_T178R	Q179K	Q124E_Q160E_T178E	Combination/optimization
9594-9801	L143E_K145T	Q124R_Q160K_T178R	Q179R	Q124E_Q160E_T178E	Combination/optimization
9671-9888	L143E_K145T_Q179E	Q124R_T178R	S186R	Q124E_T178E	Optimization
9671-9850	L143E_K145T_Q179E	Q124R_T178R	S186K	Q124E_T178E	Optimization
9671-9784	L143E_K145T_Q179E	Q124R_T178R	Q179K	Q124E_T178E	Combination/optimization
9671-9810	L143E_K145T_Q179E	Q124R_T178R	Q179R	Q124E_T178E	Combination/optimization
9675-9890	L143E_K145T_Q179E	Q124R_T178R	S186R	Q124E_T178E_T180E	Optimization
9675-9852	L143E_K145T_Q179E	Q124R_T178R	S186K	Q124E_T178E_T180E	Optimization
9675-9786	L143E_K145T_Q179E	Q124R_T178R	Q179K	Q124E_T178E_T180E	Combination
9675-9812	L143E_K145T_Q179E	Q124R_T178R	Q179R	Q124E_T178E_T180E	Combination
9667-9868	L143E_K145T_Q179E	Q124R_T178R	S186R	Q124E_Q160E_T178E	Optimization
9667-9830	L143E_K145T_Q179E	Q124R_T178R	S186K	Q124E_Q160E_T178E	Optimization
9667-9758	L143E_K145T_Q179E	Q124R_T178R	Q179K	Q124E_Q160E_T178E	Combination
9667-9802	L143E_K145T_Q179E	Q124R_T178R	Q179R	Q124E_Q160E_T178E	Combination
9708-9843	L143E_K145T_S186L	Q124R_Q160K_T178R	S186K	Q124E_S131T_T178E_T180E	Optimization
9712-9845	L143E_K145T_S186L	Q124R_Q160K_T178R	S186K	Q124E_S131T_T178E_T180E	Optimization
9708-9777	L143E_K145T_S186L	Q124R_Q160K_T178R	Q179K	Q124E_S131T_T178E_T180E	Combination/optimization



9712-9779	L143E_K145T_S188L	Q124R_Q160K_T178R	Q179K	Q124E_S131T_T178Y_T180E	Combination/Optimization
9708-9803	L143E_K145T_S188L	Q124R_Q160K_T178R	Q179R	Q124E_S131T_T178F_T180E	Combination/Optimization
9712-9805	L143E_K145T_S188L	Q124R_Q160K_T178R	Q179R	Q124E_S131T_T178Y_T180E	Combination/Optimization
9708-9881	L143E_K145T_S188L	Q124R_Q160K_T178R	S186R	Q124E_S131T_T178F_T180E	Optimization
9712-9883	L143E_K145T_S188L	Q124R_Q160K_T178R	S186R	Q124E_S131T_T178Y_T180E	Optimization
9688-9844	L143E_K145T_Q179E_S188L	Q124R_T178R	S186K	Q124E_S131T_T178F_T180E	Optimization
9692-9846	L143E_K145T_Q179E_S188L	Q124R_T178R	S186K	Q124E_S131T_T178Y_T180E	Optimization
9688-9778	L143E_K145T_Q179E_S188L	Q124R_T178R	Q179K	Q124E_S131T_T178F_T180E	Combination/Optimization
9692-9780	L143E_K145T_Q179E_S188L	Q124R_T178R	Q179K	Q124E_S131T_T178Y_T180E	Combination/Optimization
9688-9804	L143E_K145T_Q179E_S188L	Q124R_T178R	Q179R	Q124E_S131T_T178F_T180E	Combination/Optimization
9692-9805	L143E_K145T_Q179E_S188L	Q124R_T178R	Q179R	Q124E_S131T_T178Y_T180E	Combination/Optimization
9688-9882	L143E_K145T_Q179E_S188L	Q124R_T178R	S186R	Q124E_S131T_T178F_T180E	Optimization
9692-9884	L143E_K145T_Q179E_S188L	Q124R_T178R	S186R	Q124E_S131T_T178Y_T180E	Optimization
9723-9102	L143E_K145T_S188L	Q124R_Q160K_T178R	L124A_S186K	Q124E_V133W_T180E	Combination/Optimization
9723-9100	L143E_K145T_S188L	Q124R_Q160K_T178R	L124A_Q179K	Q124E_V133W_T180E	Combination/Optimization
9725-9573	L143E_K145T_S188L	Q124R_Q160K_T178R	L143A_Q179K	Q124E_V133Y_T180E	Combination/Optimization
9700-9103	L143E_K145T_Q179E_S188L	Q124R_T178R	L124A_S186K	Q124E_V133W_T180E	Combination/Optimization
9700-9101	L143E_K145T_Q179E_S188L	Q124R_T178R	L124A_Q179K	Q124E_V133W_T180E	Combination/Optimization
9702-9574	L143E_K145T_Q179E_S188L	Q124R_T178R	L143A_Q179K	Q124E_V133Y_T180E	Combination/Optimization
9715-9885	L143E_K145T_S188L	Q124R_Q160K_T178R	S186R	Q124E_S176L_T180E	Optimization
9715-9847	L143E_K145T_S188L	Q124R_Q160K_T178R	S186K	Q124E_S176L_T180E	Optimization
9715-9781	L143E_K145T_S188L	Q124R_Q160K_T178R	Q179K	Q124E_S176L_T180E	Combination/Optimization
9715-9807	L143E_K145T_S188L	Q124R_Q160K_T178R	Q179R	Q124E_S176L_T180E	Combination/Optimization
9696-9886	L143E_K145T_Q179E_S188L	Q124R_T178R	S186R	Q124E_S176L_T180E	Optimization
9696-9848	L143E_K145T_Q179E_S188L	Q124R_T178R	S186K	Q124E_S176L_T180E	Optimization
9696-9782	L143E_K145T_Q179E_S188L	Q124R_T178R	Q179K	Q124E_S176L_T180E	Combination/Optimization
9696-9808	L143E_K145T_Q179E_S188L	Q124R_T178R	Q179R	Q124E_S176L_T180E	Combination/Optimization
9985-9981	L143E_K145T	Q124R_Q160K_T178R	S186R	S131E	Optimization
9985-9978	L143E_K145T	Q124R_Q160K_T178R	S186K	S131E	Optimization
9985-9979	L143E_K145T	Q124R_Q160K_T178R	Q179K	S131E	Optimization
9985-9980	L143E_K145T	Q124R_Q160K_T178R	Q179R	S131E	Optimization
9987-9985	L143E_K145T	Q124R_T178R	S186R	S131E	Optimization
9987-9982	L143E_K145T	Q124R_T178R	S186K	S131E	Optimization
9987-9983	L143E_K145T	Q124R_T178R	Q179K	S131E	Optimization
9987-9984	L143E_K145T	Q124R_T178R	Q179R	S131E	Optimization
9988-9981	L143E_K145T_Q179E	Q124R_Q160K_T178R	S186R	S131E	Optimization
9988-9978	L143E_K145T_Q179E	Q124R_Q160K_T178R	S186K	S131E	Optimization
9988-9979	L143E_K145T_Q179E	Q124R_Q160K_T178R	Q179K	S131E	Optimization
9988-9980	L143E_K145T_Q179E	Q124R_Q160K_T178R	Q179R	S131E	Optimization
9989-9985	L143E_K145T_Q179E	Q124R_T178R	S186R	S131E	Optimization
9989-9982	L143E_K145T_Q179E	Q124R_T178R	S186K	S131E	Optimization

9989-9983	L143E_K145T_Q179E	Q124R_T178R	Q179K	S131E	Optimization
9989-9984	L143E_K145T_Q179E	Q124R_T178R	Q179R	S131E	Optimization
9611-9077	L143E_K145T_H172R	Q124R_Q160K_T178R	H172T_Q179K	Q124E_N137K_Q160E_S174R_T180E	Combination
9610-9076	L143E_K145T_H172R	Q124R	H172T_Q179K	Q124E_N137K_Q160E_S174R_T180E	Combination
9612-9078	L143E_K145T_H172R_Q179E	Q124R_T178R	H172T_Q179K	Q124E_N137K_Q160E_S174R_T180E	Combination
9060-9054	A139W_L143E_K145T_Q179E	F116A_Q124R_L135V_T178R	A139G_Q179K_V190A	Q124E_L135W_Q160E_T180E	Combination
9058-9053	A139W_L143E_K145T_Q179E	F116A_Q124R_L135V	A139G_Q179K_V190A	Q124E_L135W_Q160E_T180E	Combination
9060-9756	A139W_L143E_K145T_Q179E	F116A_Q124R_L135V_T178R	Q179K	Q124E_L135W_Q160E_T180E	Combination
9058-9755	A139W_L143E_K145T_Q179E	F116A_Q124R_L135V	Q179K	Q124E_L135W_Q160E_T180E	Combination
9585-9734	L143E_K145T	Q124R	L143K_D146G	Q124E_V133D	Optimization
9587-9735	L143E_K145T	Q124R	L143R	Q124E_V133E	Optimization
9585-9725	L143E_K145T	Q124R	L143K	Q124E_V133D	Optimization
9609-9737	L143E_K145T	Q124R	L143R	Q124E_V133E	Optimization
9593-9728	L143E_K145T	Q124R_Q160K_T178R	L143K	Q124E_V133D	Optimization
9682-9740	L143E_K145T_Q179E	Q124R_T178R	L143R	Q124E_V133E	Combination/optimization
9666-9731	L143E_K145T_Q179E	Q124R_T178R	L143R	Q124E_V133E	Combination/optimization
9705-9735	L143E_K145T_S188L	Q124R	L143R	Q124E_V133E	Optimization
9703-9726	L143E_K145T_S188L	Q124R	L143R	Q124E_V133D	Optimization
9706-9743	L143E_K145T_S188L	Q124R	L143R	Q124E_V133E_S176L	Optimization
9704-9732	L143E_K145T_S188L	Q124R	L143K	Q124E_V133D_S176L	Optimization
9721-9737	L143E_K145T_S188L	Q124R_Q160K_T178R	L143R	Q124E_V133E	Optimization
9707-9728	L143E_K145T_S188L	Q124R_Q160K_T178R	L143R	Q124E_V133D	Optimization
9722-9744	L143E_K145T_S188L	Q124R_Q160K_T178R	L143R	Q124E_V133E_S176L	Optimization
9720-9733	L143E_K145T_S188L	Q124R_Q160K_T178R	L143K	Q124E_V133D_S176L	Optimization
9687-9737	L143E_K145T_Q179E_S188L	Q124R_Q160K_T178R	L143R	Q124E_V133E	Optimization
9644-9728	L143E_K145T_Q179D_S188L	Q124R_Q160K_T178R	L143K	Q124E_V133D	Optimization
9588-9741	L143E_K145T	Q124R	L143R	Q124E_V133E_Q160F	Optimization
9589-9742	L143E_K145T	Q124R	L143R	Q124E_V133E_Q160M	Optimization
9911-9906	S188L	WT	S188G	S176L	Optimization
9907-9071	S188L	WT	F174V	S131T_S176F_T178F	Optimization
9909-9073	S188L	WT	F174V	S131T_S176F_T178Y	Optimization
9907-9068	S188L	WT	F174G	S131T_S176F_T178Y	Optimization
9909-9070	S188L	WT	F174G	S131T_S176F_T178Y	Optimization
9916-9057	S188L_V190Y	V133S	A139G_V190A	L135W_S176L	Combination/optimization
9912-9055	S188L_V190F	WT	A139G_V190A	L135W_S176L	Combination/optimization
9914-9071	S188L_V190F	WT	F174V	S131T_S176F_T178F	Optimization
9914-9068	S188L_V190F	WT	F174G	S131T_S176F_T178F	Optimization
9917-9052	S188L_V190Y	V133S	A139G_F174V_V190A	S131T_L135F_S176F_T178F	Combination/optimization
9913-9050	S188L_V190F	WT	A139G_F174V_V190A	S131T_L135F_S176F_T178F	Combination/optimization
9062-9056	A139W_S188L	F116A_L135V	A139G_V190A	L135W_S176L	Combination/optimization
9063-9051	A139W_S188L	F116A_L135V	A139G_F174V_V190A	S131T_L135F_S176F_T178F	Combination/optimization

9041-9045	A139C_C233S	F116C_C214S	WT	WT	independent
9043-9047	F122C_C233S	S121C_C214S	WT	WT	independent
9042-9046	F122C_C233S	Q124C_C214S	WT	WT	independent
9044-9048	P175C_C233S	S162C_C214S	WT	WT	independent
9049-9759	A139C_L143E_K145T_Q179E	F116C_Q124R_T178R	Q179K	Q124E_Q160E_T180E	Independent/combination
9067-9771	F122C_L143E_K145T_Q179E	S121C_Q124R_T178R	Q179K	Q124E_Q160E_T180E	Independent/combination
9066-9335	F122C_L124E	Q124C_V133G_S176R	L124R	V133G_S176D	Independent/combination
9613-9766	L143E_K145T_P175C_Q179E	Q124R_S162C_T178R	Q179K	Q124E_Q160E_T180E	Independent/combination
6037-9566	L124A	V133W	L124W_L143F	V133A	Optimization
9064-9751	D146G_H172R_Q179K	Q38E_Q124E_Q160E_T180E	L45P_L143E_K145T	P44F_Q124R_Q160K_T178R	Combination
9065-9752	D146G_Q179K	Q38E_Q124E_Q160E_T180E	L45P_L143E_K145T_H172R	P44F_Q124R_Q160K_T178R	Combination
9074-9754	H172R_Q179K	Q124E_Q160E_T180E	L45P_L143E_K145T_Q179E	P44F_Q124R_Q160K_T178R	Combination
9075-9746	H172R_S186R	Q38E_Q124E_Q160E_T180E	L45P_K145T_Q179E	P44F_S131K	Combination
9098-9571	L124A_Q179K	Q124E_V133W_S176T_T178E_T180E	L124W_L143F_K145T_Q179E	S131K_V133A_S176T_T178L	Combination/optimization
9099-9572	L124A_Q179K	Q124E_V133W_S176T_T178L_T180E	L124W_L143F_K145T_Q179E	S131K_V133A_S176T_T178L	Combination/optimization
9125-9459	L124E_K145M_Q179E	S131K_V133G_S176R	L124R_S186K	Q124E_V133G_S176D_T178E_T180E	Combination/optimization
9126-9352	L124E_K145M_Q179E	S131K_V133G_S176R	L124R_D146N_Q179K	Q124E_V133G_S176D_T178E_T180E	Combination/optimization
9129-9357	L124E_K145M_Q179E	S131K_V133G_S176R	L124R_D146N_Q179K	V133G_S176D_T178E	Combination/optimization
9130-9361	L124E_K145M_Q179E	S131K_V133G_S176R	L124R_D146N_Q179K	V133G_S176D_T178E_T180E	Combination/optimization
9131-9366	L124E_K145M_Q179E	S131K_V133G_S176R	L124R_D146N_Q179K	V133G_S176D_T180E	Combination/optimization
9170-9350	L124E_L143D_K145M	Q124K_V133G_Q160K_S176R	L124R_D146N_Q179K	Q124E_V133G_S176D_T178E_T180E	Combination/optimization
9175-9364	L124E_L143D_K145M	Q124K_V133G_S176R	L124R_D146N_Q179K	V133G_S176D_T180E	Combination/optimization
9175-9491	L124E_L143D_K145M	Q124K_V133G_S176R	L124R_S186K	V133G_S176D_T180E	Combination/optimization
9175-9546	L124E_L143D_K145M	Q124K_V133G_S176R	L124R_S186R	V133G_S176D_T180E	Combination/optimization
9178-9351	L124E_L143D_K145M	Q124K_V133G_S176R_T178K	L124R_S186R	V133G_S176D_T180E	Combination/optimization
9205-9368	L124E_L143D_K145M	V133G_S176R_T178K	L124R_D146N_Q179K	Q124E_V133G_S176D_T178E_T180E	Combination/optimization
9208-9350	L124E_L143D_K145T	Q124K_V133G_Q160K_S176R	L124R_D146N_Q179K	Q124E_V133G_S176D_T178E_T180E	Combination/optimization
9213-9364	L124E_L143D_K145T	Q124K_V133G_S176R	L124R_D146N_Q179K	V133G_S176D_T180E	Combination/optimization
9213-9491	L124E_L143D_K145T	Q124K_V133G_S176R	L124R_S186K	V133G_S176D_T180E	Combination/optimization
9213-9546	L124E_L143D_K145T	Q124K_V133G_S176R	L124R_S186R	V133G_S176D_T180E	Combination/optimization
9216-9351	L124E_L143D_K145T	Q124K_V133G_S176R_T178K	L124R_D146N_Q179K	Q124E_V133G_S176D_T178E_T180E	Combination/optimization
9247-9350	L124E_L143E_K145M	Q124K_V133G_Q160K_S176R	L124R_D146N_Q179K	Q124E_V133G_S176D_T178E_T180E	Combination/optimization
9256-9364	L124E_L143E_K145M	Q124K_V133G_S176R	L124R_D146N_Q179K	V133G_S176D_T180E	Combination/optimization
9256-9491	L124E_L143E_K145M	Q124K_V133G_S176R	L124R_S186K	V133G_S176D_T180E	Combination/optimization
9256-9546	L124E_L143E_K145M	Q124K_V133G_S176R	L124R_S186R	V133G_S176D_T180E	Combination/optimization
9259-9351	L124E_L143E_K145M	Q124K_V133G_S176R_T178K	L124R_D146N_Q179K	Q124E_V133G_S176D_T178E_T180E	Combination/optimization
9263-9492	L124E_L143E_K145M	Q124K_V133G_S176R_T178K	L124R_S186K	V133G_S176D_T180E	Combination/optimization
9270-9495	L124E_L143E_K145M	Q124K_V133G_S176R_T178K	L124R_S186R	V133G_S176D_T180E	Combination/optimization
9270-9550	L124E_L143E_K145M	Q124K_V133G_S176R_T178R	L124R_S186K	V133G_S176D_T180E	Combination/optimization
9749-9334	L45P_L124E_H172R	P44F_V133G_S176R	L124R	V133G_S176D	Combination

9750-9338	L45P_L124E_H172R	P44F_V133G_S176R	L124R	V133G_S176D_T178D	Combination
9747-9369	L45P_L124E	P44F_V133G_S176R	L124R_H172R	V133G_S176D	Combination
9748-9372	L45P_L124E	P44F_V133G_S176R	L124R_H172R	V133G_S176D_T178D	Combination
9683-9841	L143E_K145T_Q179E	T178R	S186K	Q124E_Q160E_T180E	Optimization
9683-9879	L143E_K145T_Q179E	T178R	S186R	Q124E_Q160E_T180E	Optimization
9703-9734	L143E_K145T_S188L	Q124R	L143K_D146G	Q124E_V133D	Optimization
9745-9905	L45P_K145T_H172R_Q179E	P44F_Q124R_Q160K_T178R	S186R	Q38E_Q124E_Q160E_T180E	Combination
9753-9760	L45P_L143E_K145T_H172R_Q179E	P44F_Q124R_Q160K_T178R	Q179K	Q124E_Q160E_T180E	Combination
9813-9828	Q39E_K145T_H172R_Q179E	Q38R_S131K	Q39R_S186R	Q38E_Q124E_Q160E_T180E	Combination
9814-9824	Q39E_K145T_Q179E	Q38R_S131K	Q39R_H172R_S186R	Q38E_Q124E_Q160E_T180E	Combination
9815-9826	Q39E_L124E	Q38R_V133G_S176R	Q39R_L124R_H172R	Q38E_V133G_S176D	Combination
9816-9825	Q39E_L124E_H172R	Q38R_V133G_S176R	Q39R_L124R	Q38E_V133G_S176D	Combination
9817-9821	Q39E_L143E_K145T	Q38R_Q124R_Q160K_T178R	Q39R_D146G_H172R_Q179K	Q38E_Q124E_Q160E_T180E	Combination
9817-9823	Q39E_L143E_K145T	Q38R_Q124R_Q160K_T178R	Q39R_H172R_Q179K	Q38E_Q124E_Q160E_T180E	Combination
9817-9827	Q39E_L143E_K145T	Q38R_Q124R_Q160K_T178R	Q39R_Q179K	Q38E_Q124E_Q160E_T180E	Combination
9818-9822	Q39E_L143E_K145T_H172R	Q38R_Q124R_Q160K_T178R	Q39R_D146G_Q179K	Q38E_Q124E_Q160E_T180E	Combination
9818-9823	Q39E_L143E_K145T_H172R	Q38R_Q124R_Q160K_T178R	Q39R_H172R_Q179K	Q38E_Q124E_Q160E_T180E	Combination
9818-9827	Q39E_L143E_K145T_H172R	Q38R_Q124R_Q160K_T178R	Q39R_Q179K	Q38E_Q124E_Q160E_T180E	Combination
9819-9821	Q39E_L143E_K145T_H172R_Q179E	Q38R_Q124R_Q160K_T178R	Q39R_D146G_H172R_Q179K	Q38E_Q124E_Q160E_T180E	Combination
9819-9822	Q39E_L143E_K145T_H172R_Q179E	Q38R_Q124R_Q160K_T178R	Q39R_D146G_Q179K	Q38E_Q124E_Q160E_T180E	Combination
9819-9827	Q39E_L143E_K145T_H172R_Q179E	Q38R_Q124R_Q160K_T178R	Q39R_Q179K	Q38E_Q124E_Q160E_T180E	Combination
9820-9821	Q39E_L143E_K145T_Q179E	Q38R_Q124R_Q160K_T178R	Q39R_D146G_H172R_Q179K	Q38E_Q124E_Q160E_T180E	Combination
9820-9823	Q39E_L143E_K145T_Q179E	Q38R_Q124R_Q160K_T178R	Q39R_D146G_Q179K	Q38E_Q124E_Q160E_T180E	Combination
10549-10545	L45P_K145T_Q179E	P44F_S131K	S186R	Q124E_Q160E_T180E_C214S	Combination
10551-10545	L45P_K145T_H172R_Q179E	P44F_S131K	S186R	Q124E_Q160E_T180E_C214S	Combination
10546-10550	D146G_Q179K	Q124E_Q160E_T180E_C214S	L45P_L143E_K145T	P44F_Q124R_Q160K_T178R	Combination
10546-10552	D146G_Q179K	Q124E_Q160E_T180E_C214S	L45P_L143E_K145T_H172R	P44F_Q124R_Q160K_T178R	Combination
10547-10549	H172R_S186R	Q124E_Q160E_T180E_C214S	L45P_K145T_Q179E	P44F_S131K	Combination
10547-10551	H172R_S186R	Q124E_Q160E_T180E_C214S	L45P_K145T_H172R_Q179E	P44F_S131K	Combination
10548-10550	D146G_H172R_Q179K	Q124E_Q160E_T180E_C214S	L45P_L143E_K145T	P44F_Q124R_Q160K_T178R	Combination
10548-10552	D146G_H172R_Q179K	Q124E_Q160E_T180E_C214S	L45P_L143E_K145T_H172R	P44F_Q124R_Q160K_T178R	Combination
3522	L45P_L143E_K145T	P44F_Q124R_Q160K_T178R	D146G_Q179K	Q124E_Q160E_T180E	Combination
3519	L45P_K145T_H172R_Q179E	P44F_S131K	H172R_S186R	Q124E_Q160E_T180E	Combination

\*Kabat numbering; WT refers to a wild-type immunoglobulin chain without amino acid mutations

\*\*A 'unique identifier' is either comprised of the unique identifiers for the two constituent LCCAs or a single identifier for those designs tested only in SIMCA format.



9220-9492 9229-9495 9182-9547 9191-9550 9182-9492 9191-9495 9294-9519 9312-9520 9279-9518 9294-9464 9312-9465 9279-9463 9296-9505 9300-9528 9304-9542 9314-9509 9317-9532 9320-9543 9281-9503 9284-9526 9287-9541 9296-9451 9300-9473 9304-9487 9314-9455 9317-9477 9320-9488 9281-9449 9284-9471 9287-9486 9264-9509 9267-9532 9250-9503 9253-9526 9257-9505 9260-9528 9264-9455 9267-9477 9250-9449 9253-9471 9257-9451 9260-9473 9214-9505 9223-9509 9217-9528 9226-9532 9214-9451 9223-9455 9217-9473 9226-9477 9176-9505 9185-9509 9179-9528 9188-9532 9176-9451 9185-9455 9179-9473 9188-9477 9273-9398 9271-9376 9275-9419 9302-9406 9298-9384 9304-9421 9319-9410 9316-9388 9320-9422 9286-9402 9283-9380 9287-9420 9248-9398 9247-9376 9262-9406 9259-9384 9269-9410 9266-9388 9255-9402 9252-9380 9209-9398 9208-9376 9219-9406 9216-9384 9228-9410 9225-9388 9212-9402 9211-9380	L124E L143E K145T L124E L143[ED] K145[TM]	Q124K V133G S176R Q124K V133G S176R	L124R_S186[RK] L124R_S186[RK]	V133G_S176D_T178D V133G_S176D_T178[DE]_T180E
---	--	--	----------------------------------	---

9171-9398 9170-9376					
9181-9406 9178-9384					
9190-9410 9187-9388					
9174-9402 9173-9380					
9273-9355 9271-9350					
9275-9359 9302-9356					
9298-9351 9304-9360					
9277-9428 9308-9436					
9323-9440 9290-9432					
9249-9428 9263-9436					
9270-9440 9256-9432					
9210-9428 9220-9436					
9229-9440 9213-9432					
9172-9428 9182-9436					
9191-9440 9175-9432					
9277-9363 9308-9365					
9290-9364	L124E_L143[ED]_K145[TM]	Q124K_V133G_S176R	L124R_Q179K	V133G_S176D_T180E	
9243-9556 9234-9516					
9237-9539 9240-9544					
9243-9501 9371-9484					
9240-9489 9205-9556					
9199-9539 9202-9544					
9196-9461 9205-9501					
9199-9484 9202-9489	L124E_L143D_K145[MT]	V133G_S176R_T178K	L124R_S186[KR]	V133G_S176D_T180E	
9232-9524 9234-9461					
9232-9469 9196-9516					
9194-9524 9194-9469	L124E_L143D_K145[MT]	V133G_S176R_T178K	L124R_S186[KR]	V133G_S176D_T178D	
9239-9417 9236-9395					
9240-9426 9201-9417					
9198-9395 9202-9426	L124E_L143D_K145[TM]	V133G_S176R_T178K	L124R_Q179K	V133G_S176D_T178E	
9243-9447 9205-9447					
9243-9368	L124E_L143D_K145[TM]	V133G_S176R_T178K	L124R_Q179K	V133G_S176D_T180E	
9142-9414 9138-9392					
9144-9423 9160-9416					
9154-9394 9162-9425					
9129-9414 9126-9392					
9130-9423 9142-9357					
9138-9352 9144-9361					
9160-9358 9154-9353					
9162-9362	L124E_K145[TM]_Q179E	S131[KR]_V133G_S176R	L124R_Q179K	V133G_S176D_T178E	
9146-9444 9164-9446					
9156-9397 9131-9444					
9146-9366 9164-9367	L124E_K145[TM]_Q179E	S131[KR]_V133G_S176R	L124R_Q179K	V133G_S176D_T180E	

9156-9354							
9814-9828 9813-9824	Q39E_K145T_Q179E	Q38R_S131K	Q39R_S186R	Q38E_Q124E_Q160E_T180E			
9817-9822 9818-9821	Q39E_L143E_K145T	Q38R_Q124R_Q160K_T178R	Q39R_D146G_Q179K	Q38E_Q124E_Q160E_T180E			
9820-9827 9819-9823	Q39E_L143E_K145T_Q179E	Q38R_Q124R_Q160K_T178R	Q39R_Q179K	Q38E_Q124E_Q160E_T180E			
9815-9825 9816-9826	Q39E_L124E	Q38R_V133G_S176R	Q39R_L124R	Q38E_V133G_S176D			
9746-9905 9745-9975	L45P_K145T_Q179E	P44F_S131K	S186R	Q38E_Q124E_Q160E_T180E			
9751-9065 9752-9064	L45P_L143E_K145T	P44F_Q124R_Q160K_T178R	D146G_Q179K	Q38E_Q124E_Q160E_T180E			
9754-9760 9753-9074	L45P_L143E_K145T_Q179E	P44F_Q124R_Q160K_T178R	Q179K	Q124E_Q160E_T180E			
9747-9334 9748-9338							
9749-9369 9750-9372	L45P_L124E	P44F_V133G_S176R	L124R	V133G_S176D			
9079-9878 9079-9840							
9082-9900 9082-9862	K145T_Q179E	S131K	S186[RK]	Q124E_T180E			
9079-9772 9082-9796	K145T_Q179E	S131K	Q179K	Q124E_T180E			
9590-9871 9590-9833							
9606-9893 9606-9855							
9651-9871 9651-9833							
9654-9893 9654-9855							
9620-9871 9620-9833							
9623-9893 9623-9855							
9602-9889 9602-9851							
9708-9843 9712-9845							
9708-9881 9712-9883							
9716-9885 9716-9847	L143E_K145T	Q124R_Q160K_T178R	S186[RK]	Q124E_T180E			
9598-9887 9598-9849							
9594-9867 9594-9829	L143E_K145T	Q124R_Q160K_T178R	S186[RK]	Q124E_T178E			
9663-9876 9663-9838							
9679-9898 9679-9860							
9632-9876 9632-9838							
9635-9898 9635-9860							
9657-9874 9657-9836							
9660-9896 9660-9858							
9626-9874 9626-9836							
9629-9896 9629-9858							
9645-9869 9645-9831							
9648-9891 9648-9853							
9614-9869 9614-9831							
9617-9891 9617-9853							
9684-9901 9684-9863							
9638-9879 9638-9841							
9641-9901 9641-9863							
9579-9901 9579-9863							
9575-9879 9575-9841							
9579-9901 9579-9863	L143[DE]_K145T_Q179[DE]	T178[RK]	S186[RK]	Q124E_T180E			



9675-9890 9675-9852						
9688-9844 9692-9846						
9688-9882 9692-9884						
9696-9886 9696-9848						
9671-9888 9671-9850						Q124E_T178E
9667-9868 9667-9830	L143E_K145T_Q179E		Q124R_T178R		S186[RK]	
9590-9763 9606-9789						
9651-9763 9654-9789						
9620-9763 9623-9789						
9602-9785 9708-9777						
9712-9779 9723-9100						
9725-9573 9716-9781						
9611-9077	L143E_K145T		Q124R_Q160K_T178R		Q179K	Q124E_T180E
9708-9803 9712-9805	L143E_K145T_S188L		Q124R_Q160K_T178R		Q179R	Q124E_S131T_T178[FY]_T180E
9663-9769 9679-9794						
9632-9769 9635-9794						
9645-9761 9648-9787						
9614-9761 9617-9787						
9683-9773 9684-9797						
9638-9773 9641-9797						
9575-9773 9579-9797						
9675-9786 9688-9778						
9692-9780 9700-9101						
9702-9574 9696-9782						
9612-9078	L143[DE]_K145T_Q179[DE]		T178R		Q179K	Q124E_T180E
9657-9767 9660-9792						
9626-9767 9629-9792	L143E_K145T_Q179[DE]		Q124R_T178K		Q179K	Q124E_T180E
9598-9783 9598-9809						
9594-9757 9594-9801						
9602-9811	L143E_K145T		Q124R_Q160K_T178R		Q179[RK]	Q124E_T178E
9671-9784 9671-9810						
9675-9812 9667-9758						
9667-9802	L143E_K145T_Q179E		Q124R_T178R		Q179[RK]	Q124E_T178E
9688-9804	L143E_K145T_Q179E_S188L		Q124R_T178R		Q179R	Q124E_S131T_T178E_T180E
9692-9806	L143E_K145T_Q179E_S188L		Q124R_T178R		Q179R	Q124E_S131T_T178Y_T180E
9723-9102	L143E_K145T_S188L		Q124R_Q160K_T178R		L124A_S186K	Q124E_V133W_T180E
9700-9103	L143E_K145T_Q179E_S188L		Q124R_T178R		L124A_S186K	Q124E_V133W_T180E
9696-9808	L143E_K145T_Q179E_S188L		Q124R_T178R		Q179R	Q124E_S176L_T180E
9716-9807	L143E_K145T_S188L		Q124R_Q160K_T178R		Q179R	Q124E_S176L_T180E
9986-9981 9986-9978						
9987-9985 9987-9982						
9988-9981 9988-9978						
9989-9985 9989-9982	L143E_K145T		Q124R_T178R		S186[RK]	S131E

9985-9979 9986-9980	L143E_K145T_H172R	Q124R_T178R	Q179[KR]	S131E
9987-9983 9987-9984	L143E_K145T_H172R	Q124R	H172T_Q179K	Q124E_Q160E_T180E_N137K_S174R
9988-9979 9988-9980	L143E_K145T_H172R	Q124R	Q179K	Q124E_Q160E_T180E_L135W
9989-9983 9989-9984	L143E_K145T_H172R	Q124R	Q179K	Q124E_Q160E_T180E_L135W
9610-9076	L143E_K145T_H172R	Q124R	Q179K	Q124E_Q160E_T180E_L135W
9060-9054 9058-9053	L143E_K145T_H172R	Q124R	Q179K	Q124E_Q160E_T180E_L135W
9060-9756 9058-9755	A139W_L143E_K145T_Q179E	Q124R_F116A_L135V	Q179K	Q124E_Q160E_T180E_L135W
9587-9735 9609-9737	L143E_K145T	Q124R	L143R	Q124E_V133E
9682-9740 9705-9735	L143E_K145T	Q124R	L143R	Q124E_V133E
9706-9743 9721-9737	L143E_K145T	Q124R	L143R	Q124E_V133E
9722-9744 9687-9737	L143E_K145T	Q124R	L143R	Q124E_V133E
9588-9741 9589-9742	L143E_K145T	Q124R	L143R	Q124E_V133E
9585-9734 9585-9726	L143E_K145T	Q124R	L143R	Q124E_V133E
9593-9728 9666-9731	L143E_K145T	Q124R	L143R	Q124E_V133E
9703-9726 9704-9732	L143E_K145T	Q124R	L143R	Q124E_V133E
9707-9728 9720-9733	L143E_K145T	Q124R	L143R	Q124E_V133E
9644-9728	L143E_K145T	Q124R	L143R	Q124E_V133E
9911-9906	S188L	WT	S188G	S176L
9907-9071 9909-9073	S188L	WT	F174V	S131T_S176F_T178[FY]
9917-9052	S188L	WT	F174G	S131T_S176F_T178[FY]
9907-9068 9909-9070	S188L	WT	F174G	S131T_S176F_T178[FY]
9916-9057	S188L_V190Y	V133S	A139G_V190A	L135W_S176L
9912-9055	S188L_V190F	WT	A139G_V190A	L135W_S176L
9914-9071 9914-9068	S188L_V190F	WT	F174[G]	S131T_S176F_T178F
9913-9050	S188L_V190F	WT	F174[G]	S131T_S176F_T178F
9062-9056	A139W_S188L	F116A_L135V	A139G_V190A	L135W_S176L
9063-9051	A139W_S188L	F116A_L135V	A139G_V190A	L135W_S176L
9041-9045 9049-9759	A139C	F116C	WT	S131T_L135F_S176F_T178F
9043-9047 9067-9771	F122C	S121C	WT	WT
9042-9046 9066-9935	F122C	Q124C	WT	WT
9044-9048 9613-9766	P175C	S162C	WT	WT

\* Kabat numbering; WT refers to a wild-type immunoglobulin chain without amino acid mutations

\*\* A 'unique identifier set' is comprised of the unique identifiers for the two constituent LCCAs

Table 7. Example of a combination design

Unique Identifier (Set#H1:H2- Set#Q1:Q3)	H1_mutation*	H1_mutation*	H2_mutation*	H2_mutation*	Normalized Median H1 L1:H1:12	Normalized Median H2- L2:H2:13
9835-9825 (from table 5 above)	Q39E_L124E	Q38R_V133G_S176R	Q39R_L124R	Q38E_V133G_S176D		
51-52 (from Table 14 in PCT/CA2013/050914)	Q39E	Q38R	Q39R	Q38E	76:24	70:30
263-264 (from Table 15 in PCT/CA2013/050914)	L124E	V133G_S176R	L124R	V133G_S176D	88:12	84:16

\*Kabat numbering.

Table 8. Example of a modified/optimized design

Unique identifier (Set#H1:H2- Set#L1:L2)	H1_mutation*	L1_mutation*	H2_mutation*	L2_mutation*	Normalized Median H1 (1:H1:12)	Normalized Median H2 (2:H2:11)
910-9341 (from Table 5 above)	L124E	V133G_S176R	L124R	V133G_S176D_T178V		
263-264 (from Table 15 in PCT/CA2013/050914)	L124E	V133G_S176R	L124R	V133G_S176D	88.12	84.16

\*Kabat numbering

Table 9. Example of a combination design including an optimized design

Unique identifier (Set#H1L12- Set#H2L2L1)	H1_mutation*	L1_mutation*	H2_mutation*	L2_mutation*	Normalized Median H1 (L1.H1.L2)	Normalized Median H2- (L2.H3.L1)
9314-9509 (combination including optimized design from Table 5 above)	L124E_L143E_K145T	Q124K_V133G_S176R_T178R	L124R_S186R	Q124E_V133G_S176D_T178D_T180E		
263-264 (from Table 15 in PCT/CA2013/050914)	L124E	V133G_S176R	L124R	V133G_S176D	88.12	84.16
265-266 (from Table 15 in PCT/CA2013/050914)	L143E_K145T	Q124K_T178R	S186R	Q124E	90.13	96.6

Table 10. Example of a combination design including an independent design

Unique Identifier (Set#H1L1L2- Set#H2L1L1)	H1_mutation*	L1_mutation*	H2_mutation*	L2_mutation*	Normalized Median H1 (L1+L1L2)	Normalized Median H2 (L2+H2L1)
9066-9335 (combination including independent design from Table 5 above)	F124C_L124E	Q124C_V133G_S176R	L124R	V133G_S176D		
535-536 (independent design from Table 5 above)	F122C	Q124C	WT	WT		
263-264 (from Table 15 in PCT/CA2013/050914)	L124E	V133G_S176R	L124R	V133G_S176D	88:12	84:16

\*Kabat numbering. WT refers to a wild-type immunoglobulin chain without amino acid mutations

Table 11: H1:L1:L2 DNA ratios used for the light chain competition assays and verifications

H1:L1:L2 ratio	Experiment	DNA quantity used for transfection (ng)			^Additional DNA	
		H1	L1	L2	AKTdd pT122	ssDNA
1:0.75:2.25	Competition assay screen	333	250	749	300	368
1:0.75:2.25	Competition assay verification	333	250	749	300	368
1:0.3:2.7	Competition assay verification	333	100	899	300	368

^Additional DNA: AKTdd pT122 refers to a vector containing a constitutively active protein kinase B mutant (dominant positive AKT mutant); ssDNA refers to salmon sperm DNA.

Table 12. LCCA performance, stability and antigen binding assessments of the LCCA designs, arranged by decreasing DSF values of H11.1 Fab heterodimers

Row #	Set #	DSF values of h111 Fab heterodimer (°C)	Change in DSF values of h111 Fab heterodimer compared to wild-type	KD of h111 Fab heterodimer (nM)	Range of KD values for h111 Fab heterodimer (nM)	Change in median values of KD of h111 Fab heterodimer compared to wild type $(-\log(KD_{design}) - \log(KD_{wt}))$	Median LCCA performance normalized to a L1:L2 DNA ratio of 1:1 (Ratio)**	LCCA performance range (Max-Min) at L1:L2 DNA ratio of 1:1**	Median LCCA performance normalized to a L1:L2 DNA ratio of 1:1 (Ratio)***
1	6113	83.1	2.1	0.12	0	0.11	64:36	1.4	ND
2	9780	83	2	0.16+	0.00+	-0.01+	93:7	1	ND
3	9779	83	2	0.16+	0.00+	-0.01+	95:5	2.1	ND
4	9845	82.7	1.7	0.13+	0.00+	0.09+	94:6	12.8	89:11
5	9846	82.7	1.7	0.13+	0.00+	0.09+	95:5	2	89:11
6	9805	82.6	1.6	0.13+	0.00+	0.07+	95:5	2.3	ND
7	9806	82.6	1.6	0.13+	0.00+	0.07+	94:6	0.9	91:9
8	6163	82.5	1.5	0.15	0	0.02	75:25	7.4	ND
9	6024	82.50*	1.30*	0.15*	0.00*	0.02*	50:50	0.9	ND
10	9906	82.5	1.5	0.11+	0.00+	0.14+	22:78	6.3	ND
11	9068	82.5	1.5	0.13	0	0.07	63:37	9.5	61:39
12	9070	82.5	1.5	0.16	0	0	67:33	3.3	ND
13	9074	82.5	1.5	0.16	0	-0.01	97:3	1.4	99:1
14	9570	82.4	1.4	0.23	0	-0.17	64:36	3.2	ND
15	9883	82.3	1.3	ND, low Fab capture	ND, low Fab capture	ND, low Fab capture	88:12	2.5	ND
16	9884	82.3	1.3	ND, low Fab capture	ND, low Fab capture	ND, low Fab capture	88:12	6.3	ND
17	9844	82.3	1.3	0.17+	0.00+	-0.03+	96:4	1.1	ND
18	9843	82.3	1.3	0.17+	0.00+	-0.03+	96:4	1.5	ND
19	9073	82.3	1.3	0.14	0	0.04	63:37	1.9	ND
20	9803	82.2	1.2	0.11+	0.00+	0.14+	96:4	0.6	ND
21	9804	82.2	1.2	0.11+	0.00+	0.14+	96:4	0.5	ND
22	9782	82.2	1.2	0.08+	0.00+	0.28+	96:4	5.6	ND
23	9781	82.2	1.2	0.08+	0.00+	0.28+	97:3	5.2	ND
24	9610	82.1	1.1	ND, low Fab capture	ND, low Fab capture	ND, low Fab capture	99:1	1.8	98:2
25	6042	82.1	1.1	0.11	0	0.14	66:34	5.3	ND
26	9914	82	1	0.15+	0.00+	0.01+	61:39	13.2	72:28
27	9569	82	1	0.3	0	-0.28	70:30	0	ND
28	9568	82	1	0.3	0	-0.28	61:39	1.4	ND
29	9807	81.8	0.8	0.17+	0.00+	-0.02+	98:2	5.6	ND
30	9808	81.8	0.8	0.17+	0.00+	-0.02+	93:7	12.7	85:15
31	9794	81.8	0.8	0.11+	0.00+	0.16+	96:4	0.9	ND
32	9796	81.8	0.8	0.11+	0.00+	0.16+	98:2	10.8	88:12
33	9797	81.8	0.8	0.11+	0.00+	0.16+	96:4	2.9	ND
34	9792	81.8	0.8	0.11+	0.00+	0.16+	96:4	1	ND
35	9567	81.8	0.8	0.25	0	-0.21	58:42	1.9	ND
36	9881	81.8	0.8	0.11+	0.00+	0.15+	90:10	0.9	ND
37	9882	81.8	0.8	0.11+	0.00+	0.15+	90:10	3.2	ND
38	9611	81.8	0.8	0.12+	0.00+	0.12+	99:1	4.6	99:1
39	9789	81.8	0.8	0.11+	0.00+	0.16+	96:4	1.1	ND
40	9787	81.8	0.8	0.11+	0.00+	0.16+	96:4	1.4	87:13
41	9566	81.8	0.8	0.25	0	-0.21	56:44	3.6	ND
42	9692	81.6	0.6	0.34	0	-0.34	83:17	5.2	79:21
43	9696	81.6	0.6	0.34	0	-0.34	87:13	18.1	90:10
44	6017	81.6	0.6	0.14	0	0.06	47:53	7.1	ND
45	9705	81.6	0.6	0.21	0	-0.12	69:31	0	ND
46	9688	81.6	0.6	0.34	0	-0.34	77:23	0.6	ND



47	9706	81.6	0.6	0.21	0	-0.12	69:31	0.2	ND
48	9704	81.6	0.6	0.21	0	-0.12	74:26	0.1	ND
49	9703	81.60*	0.40*	0.21*	0.00*	-0.12*	84:16	14.8	79:21
50	9702	81.6	0.6	0.34	0	-0.34	71:29	5	ND
51	9700	81.6	0.6	0.34	0	-0.34	75:25	3.1	ND
52	9346	81.6	0.6	0.2	0	-0.11	95:5	1.9	ND
53	9612	81.5	0.5	ND, low Fab capture	ND, low Fab capture	ND, low Fab capture	99:1	2.7	99:1
54	9057	81.5	0.5	0.16	0	-0.02	43:57	22.8	ND
55	9056	81.5	0.5	0.16	0	-0.02	32:68	6.8	72:28
56	9055	81.5	0.5	0.16	0	-0.02	40:60	15	ND
57	9731	81.5	0.5	0.28	0	-0.26	92:8	3.9	92:8
58	9071	81.5	0.5	0.21	0	-0.12	56:44	14	85:15
59	9104	81.40*	0.30*	0.16*	0.00*	-0.01*	90:10	1.8	ND
60	9885	81.4	0.4	0.18+	0.00+	-0.06+	95:5	2.3	ND
61	9886	81.4	0.4	0.18+	0.00+	-0.06+	93:7	4.3	ND
62	10551	81.4	0.4	ND, low Fab capture	ND, low Fab capture	ND, low Fab capture	94:6	1.1	92:8
63	5998	81.4	0.4	0.14	0	0.06	71:29	5	ND
64	6036	81.4	0.4	0.17	0	-0.03	59:41	0.1	ND
65	9745	81.4	0.4	ND, low Fab capture	ND, low Fab capture	ND, low Fab capture	95:5	0.1	ND
66	9769	81.3	0.3	0.32	0	-0.31	88:12	10.6	90:10
67	9767	81.3	0.3	0.32	0	-0.31	89:11	14.7	93:7
68	9763	81.3	0.3	0.32	0	-0.31	87:13	2.4	88:12
69	9759	81.3	0.3	0.32	0	-0.31	94:6	0	ND
70	9813	81.3	0.3	0.18+	0.00+	-0.05+	93:7	3.6	89:11
71	9099	81.3	0.3	0.19	0	-0.09	97:3	11.1	92:8
72	9052	81.3	0.3	0.14	0	0.06	74:26	36.9	89:11
73	9051	81.3	0.3	0.14	0	0.06	51:49	3.9	60:40
74	9050	81.3	0.3	0.14	0	0.06	53:47	6	ND
75	9761	81.3	0.3	0.32	0	-0.31	92:8	5.9	90:10
76	9760	81.3	0.3	0.32	0	-0.31	97:3	2.8	95:5
77	9062	81.3	0.3	0.17	0	-0.02	66:34	7	75:25
78	9063	81.3	0.3	0.17	0	-0.02	59:41	6.1	55:45
79	9687	81.3	0.3	ND, low Fab capture	ND, low Fab capture	ND, low Fab capture	89:11	5.4	87:13
80	9732	81.3	0.3	0.28	0	-0.25	90:10	5.7	ND
81	9733	81.3	0.3	0.28	0	-0.25	94:6	8.2	91:9
82	9848	81.3	0.3	0.15+	0.00+	0.03+	96:4	11.8	91:9
83	9847	81.3	0.3	0.15+	0.00+	0.03+	97:3	3.3	ND
84	9773	81.3	0.3	0.32	0	-0.31	78:22	5	ND
85	9066	81.2	0.2	0.17	0	-0.04	93:7	2.7	96:4
86	9118	81.20*	0.00*	0.01	0	-0.28	95:5	1.9	ND
87	9119	81.2	0.2	0.17	0	-0.03	97:3	1.7	97:3
88	9741	81.1	0.1	0.07+	0.00+	0.34+	83:17	0.1	ND
89	9101	81	0	0.12	0	0.1	95:5	0.2	ND
90	9100	81	0	0.12	0	0.1	93:7	1.2	ND
91	9635	81.00*	-0.20*	0.14*	0.00*	0.04*	76:24	28.6	ND
92	9632	81	0	0.14+	0.00+	0.04+	87:13	14.8	82:18
93	9045	81	0	0.14+	0.11+	0.00+	65:35	4.8	52:48
94	9046	81	0	0.14+	0.11+	0.00+	55:45	11.4	55:45
95	9047	81	0	0.14+	0.11+	0.00+	38:62	5.2	ND
96	9048	81	0	0.14+	0.11+	0.00+	63:37	9.3	79:21
97	9786	81	0	0.13	0.05	0.1	92:8	6.7	91:9
98	9785	81	0	0.13	0.05	0.1	94:6	0.1	ND
99	9911	81	0	0.09+	0.00+	0.27+	93:7	1.5	ND
100	9571	81	0	0.26	0	-0.21	70:30	10.7	ND
101	9572	81	0	0.26	0	-0.21	69:31	8.7	ND

102	9371	81	0	0.22	0	-0.14	93:7	2	ND
103	9370	81	0	0.22	0	-0.14	92:8	0.5	ND
104	9909	81	0	0.09+	0.00+	0.27+	61:39	0	ND
105	9907	81	0	0.09+	0.00+	0.27+	63:37	0	ND
106	9060	81	0	0.14	0	0.04	98:2	2.7	97:3
107	9369	81	0	0.22	0	-0.14	84:16	56.1	ND
108	5957	81	0	0.14+	0.11+	0.00+	71:29	4.4	ND
109	9082	80.9	-0.1	0.16	0.02	-0.01	42:58	22.9	75:25
110	6136	80.9	-0.1	0.16	0.02	-0.01	52:48	2.2	ND
111	6138	80.9	-0.1	0.16	0.02	-0.01	56:44	5.7	ND
112	6666	80.9	-0.1	0.16	0.02	-0.01	60:40	2.6	ND
113	9079	80.90*	-0.30*	0.16*	0.02*	-0.01*	73:27	3.7	ND
114	9078	80.9	-0.1	0.15	0	0.01	92:8	3.7	85:15
115	9077	80.9	-0.1	0.15	0	0.01	91:9	2.1	80:20
116	9076	80.9	-0.1	0.15	0	0.01	77:23	5.2	82:18
117	9858	80.3	-0.2	0.06+	0.00+	0.46+	97:3	0.8	ND
118	9853	80.8	-0.2	0.06+	0.00+	0.46+	98:2	2.6	95:5
119	2951	80.8	-0.2	0.13	0	0.08	66:34	8.7	ND
120	6164	80.8	-0.2	0.17	0	-0.04	43:57	18.5	ND
121	9721	80.8	-0.2	0.24	0	-0.19	51:49	7.5	ND
122	9720	80.8	-0.2	0.24	0	-0.19	77:23	6.9	76:24
123	9723	80.8	-0.2	0.24	0	-0.19	60:40	10.2	ND
124	9722	80.8	-0.2	0.24	0	-0.19	74:26	6.4	86:14
125	9725	80.8	-0.2	0.24	0	-0.19	56:44	7.5	ND
126	9855	80.8	-0.2	0.06+	0.00+	0.46+	97:3	0.7	ND
127	9812	80.8	-0.2	0.16+	0.00+	-0.01+	94:6	5.3	90:10
128	9811	80.8	-0.2	0.16+	0.00+	-0.01+	93:7	6.3	92:8
129	9862	80.8	-0.2	0.06+	0.00+	0.46+	98:2	8.1	93:7
130	9863	80.8	-0.2	0.06+	0.00+	0.46+	96:4	3.9	ND
131	9860	80.8	-0.2	0.06+	0.00+	0.46+	94:6	10.8	89:11
132	9589	80.3	-0.2	0.28	0	-0.25	85:15	1.9	ND
133	9716	80.8	-0.2	0.24	0	-0.19	57:43	0	ND
134	9712	80.8	-0.2	0.24	0	-0.19	74:26	13.9	84:16
135	9574	80.8	-0.2	0.27	0	-0.23	96:4	1.2	ND
136	9573	80.8	-0.2	0.27	0	-0.23	96:4	0.8	ND
137	9587	80.8	-0.2	0.28	0	-0.25	91:9	6.3	88:12
138	5933	80.8	-0.2	0.15	0	0.03	62:38	2.1	ND
139	9898	80.8	-0.2	0.07+	0.00+	0.36+	96:4	0.3	ND
140	9708	80.8	-0.2	0.24	0	-0.19	59:41	11.3	ND
141	9893	80.8	-0.2	0.07+	0.00+	0.36+	98:2	2.3	ND
142	9891	80.8	-0.2	0.07+	0.00+	0.36+	97:3	0.5	ND
143	9896	80.3	-0.2	0.07+	0.00+	0.36+	97:3	1.6	ND
144	9058	80.8	-0.2	0.12	0	0.12	97:3	2	95:5
145	9588	80.8	-0.2	0.28	0	-0.25	85:15	0	ND
146	9585	80.80*	-0.40*	0.28*	0.00*	-0.25*	67:33	2	ND
147	9336	80.3	-0.2	0.2	0	-0.1	86:14	1.9	ND
148	9337	80.8	-0.2	0.2	0	-0.1	83:17	2.5	ND
149	9334	80.8	-0.2	0.2	0	-0.1	97:3	2.4	95:5
150	9335	80.8	-0.2	0.2	0	-0.1	92:8	2.8	95:5
151	6048	80.8	-0.2	0.2	0	-0.1	88:12	4	ND
152	9901	80.8	-0.2	0.07+	0.00+	0.36+	96:4	1	ND
153	9900	80.3	-0.2	0.07+	0.00+	0.36+	96:4	2.7	ND
154	9707	80.80*	-0.40*	0.24*	0.00*	-0.19*	90:10	0	ND
155	9117	80.8	-0.2	0.17	0	-0.03	97:3	1.2	ND
156	9742	80.8	-0.2	0.25	0	-0.21	88:12	2.4	ND
157	9644	80.8	-0.2	0.13+	0.00+	0.09+	85:15	9.7	ND
158	9809	80.7	-0.3	0.14+	0.00+	0.04+	97:3	0.3	ND
159	9810	80.7	-0.3	0.14+	0.00+	0.04+	97:3	4.9	85:15
160	9054	80.7	-0.3	0.14	0	0.05	87:13	5	86:14
161	9053	80.7	-0.3	0.14	0	0.05	85:15	7.6	91:9
162	9559	80.6	-0.4	0.27	0	-0.24	96:4	1.4	ND
163	9098	80.6	-0.4	0.17	0	-0.03	97:3	2.3	ND
164	9626	80.6	-0.4	0.12+	0.00+	0.12+	89:11	5.8	78:22

165	9629	80.60*	-0.60*	0.12*	0.00*	0.12*	84:16	2.6	ND
166	9111	80.6	-0.4	0.13	0	0.09	91:9	4.3	98:2
167	9558	80.6	-0.4	0.27	0	-0.24	89:11	2.4	92:8
168	6112	80.50*	-0.70*	0.13*	0.00*	0.10*	13:87	9.2	ND
169	2950	80.5	-0.5	0.13	0	0.1	62:38	4.4	ND
170	9831	80.5	-0.5	0.13+	0.00+	0.09+	83:17	0	ND
171	9833	80.5	-0.5	0.13+	0.00+	0.09+	81:19	0	ND
172	9841	80.5	-0.5	0.13+	0.00+	0.09+	91:9	2	87:13
173	10549	80.5	-0.5	0.35	0	-0.35	96:4	2.9	93:7
174	9784	80.5	-0.5	0.14+	0.00+	0.05+	96:4	9.4	89:11
175	9783	80.5	-0.5	0.14+	0.00+	0.05+	96:4	1.4	ND
176	9657	80.50*	-0.70*	0.19*	0.00*	-0.08*	83:17	33.4	ND
177	9753	80.5	-0.5	ND, low Fab capture	ND, low Fab capture	ND, low Fab capture	89:11	4.9	77:23
178	9660	80.5	-0.5	0.19+	0.00+	-0.08+	84:16	4.8	ND
179	9836	80.5	-0.5	0.13+	0.00+	0.09+	92:8	5	89:11
180	9838	80.5	-0.5	0.13+	0.00+	0.09+	94:6	3.5	94:6
181	9987	80.5	-0.5	0.11+	0.00+	0.15+	46:54	0	ND
182	9740	80.5	-0.5	0.2	0	-0.09	95:5	3.3	89:11
183	9746	80.5	-0.5	0.35	0	-0.35	94:6	0.1	ND
184	9342	80.5	-0.5	0.34	0	-0.34	97:3	3.1	96:4
185	9737	80.5	-0.5	0.2	0	-0.09	96:4	10	93:7
186	9735	80.5	-0.5	0.2	0	-0.09	96:4	21.1	74:26
187	7046	80.50*	-0.70*	0.17*	0.00*	-0.04*	91:9	4.3	ND
188	9801	80.4	-0.6	0.11+	0.00+	0.16+	97:3	1.4	ND
189	9802	80.4	-0.6	0.11+	0.00+	0.16+	95:5	10.8	86:14
190	9667	80.4	-0.6	0.27	0	-0.23	91:9	8.6	90:10
191	9869	80.4	-0.6	0.05	0	0.51	82:18	7.5	ND
192	9654	80.4	-0.6	0.15+	0.00+	0.02+	73:27	38.5	ND
193	9651	80.40*	-0.80*	0.15*	0.00*	0.02*	84:16	24.7	ND
194	9755	80.4	-0.6	0.28	0	-0.26	77:23	3.2	80:20
195	9756	80.4	-0.6	0.28	0	-0.26	88:12	0.9	87:13
196	9620	80.4	-0.6	0.06+	0.00+	0.39+	84:16	10.3	88:12
197	9623	80.40*	-0.80*	0.06*	0.00*	0.39*	69:31	30.5	ND
198	9871	80.4	-0.6	0.05	0	0.51	80:20	0	ND
199	9874	80.4	-0.6	0.05	0	0.51	83:17	6.3	89:11
200	9876	80.4	-0.6	0.05	0	0.51	81:19	17.1	86:14
201	9879	80.4	-0.6	0.05	0	0.51	72:28	5.7	ND
202	9663	80.40*	-0.80*	0.27*	0.00*	-0.23*	91:9	13.6	78:22
203	9666	80.40*	-0.80*	0.27*	0.00*	-0.23*	92:8	5.1	83:12
204	9682	80.4	-0.6	0.27	0	-0.23	93:7	1.3	92:8
205	9679	80.4	-0.6	0.27	0	-0.23	85:15	5.6	83:17
206	9671	80.4	-0.6	0.27	0	-0.23	86:14	2.5	85:15
207	9675	80.4	-0.6	0.27	0	-0.23	92:8	15.4	92:8
208	9140	80.30*	-0.90*	0.16*	0.00*	0.00*	95:5	3.4	ND
209	10552	80.3	-0.7	0.29	0	-0.27	99:1	0.1	99:1
210	9547	80.3	-0.7	0.24	0	-0.18	92:8	0	ND
211	9546	80.3	-0.7	0.24	0	-0.18	87:13	14.2	85:15
212	9144	80.30*	-0.90*	0.16*	0.00*	0.00*	95:5	2.6	ND
213	9146	80.30*	-0.90*	0.16*	0.00*	0.00*	96:4	3.1	96:4
214	9142	80.30*	-0.90*	0.16*	0.00*	0.00*	97:3	3.4	97:3
215	9758	80.3	-0.7	0.29	0	-0.27	95:5	17.8	84:16
216	9614	80.3	-0.7	ND, low Fab capture	ND, low Fab capture	ND, low Fab capture	86:14	6.2	86:14
217	9757	80.3	-0.7	0.29	0	-0.27	98:2	3.9	ND
218	9134	80.3	-0.7	0.16	0	0	94:6	6.7	ND
219	9136	80.30*	-0.90*	0.16*	0.00*	0.00*	96:4	2.2	ND
220	9374	80.3	-0.7	0.23	0	-0.16	77:23	34.8	ND
221	9375	80.3	-0.7	0.23	0	-0.16	76:24	23.2	75:25
222	6135	80.3	-0.7	0.13	0	0.07	87:13	0.3	ND
223	9752	80.3	-0.7	0.29	0	-0.27	95:5	3	ND

224	9138	80.30*	-0.90*	0.16*	0.00*	0.00*	95:5	4.6	ND
225	9347	80.3	-0.7	0.23	0	-0.16	89:11	1.8	94:6
226	9617	80.30*	-0.90*	ND	ND	ND	85:15	3.3	89:11
227	9556	80.3	-0.7	0.24	0	-0.18	93:7	0	ND
228	9555	80.3	-0.7	0.24	0	-0.18	92:8	13.4	92:8
229	9553	80.3	-0.7	0.24	0	-0.18	93:7	2.7	88:12
230	9550	80.3	-0.7	0.24	0	-0.18	89:11	19.8	ND
231	9917	80.2	-0.8	0.10+	0.00+	0.20+	58:42	21.2	62:38
232	5995	80.2	-0.8	0.14	0	0.04	49:51	11.6	ND
233	9561	80.2	-0.8	0.21	0	-0.13	97:3	0.3	ND
234	9560	80.2	-0.8	0.21	0	-0.13	91:9	1.3	89:11
235	6098	80.2	-0.8	0	0	0.34	87:13	3.1	ND
236	9641	80.10*	-1.10*	0.11*	0.00*	0.17*	65:35	3.3	ND
237	9432	80.1	-0.9	0.28	0	-0.26	91:9	2.8	82:18
238	9436	80.1	-0.9	0.28	0	-0.26	96:4	0	ND
239	6043	80.1	-0.9	0.13	0	0.07	39:61	6.8	ND
240	6037	80.1	-0.9	0.13	0	0.07	41:59	0.8	ND
241	9440	80.1	-0.9	0.28	0	-0.26	95:5	0	ND
242	9444	80.1	-0.9	0.28	0	-0.26	67:33	66.2	ND
243	9446	80.1	-0.9	0.28	0	-0.26	83:17	24.8	ND
244	9447	80.1	-0.9	0.28	0	-0.26	85:15	23.8	ND
245	9638	80.1	-0.9	0.11+	0.00+	0.17+	76:24	16.7	ND
246	9102	80	-1	0.15	0	0.02	93:7	1.5	ND
247	9978	80	-1	0.14+	0.00+	0.05+	99:1	0.6	ND
248	9579	80.00*	-1.20*	0.28*	0.00*	-0.25*	79:21	14.5	ND
249	9575	80	-1	0.28	0	-0.25	89:11	1.4	89:11
250	9982	80	-1	0.14+	0.00+	0.05+	98:2	0.3	ND
251	6137	80	-1	0.16	0	0	92:8	6.5	ND
252	9122	80	-1	0.13	0	0.1	81:19	8	ND
253	6665	80	-1	0.17	0	-0.04	86:14	4	ND
254	5997	80	-1	0.08	0	0.29	47:53	9.1	ND
255	9743	80	-1	0.28	0	-0.25	86:14	1.4	ND
256	9744	80	-1	0.28	0	-0.25	94:6	15.2	79:21
257	9103	80	-1	0.15	0	0.02	95:5	0.7	ND
258	9486	80	-1	0.23	0	-0.17	92:8	0	ND
259	9487	80	-1	0.23	0	-0.17	93:7	2.9	ND
260	9488	80	-1	0.23	0	-0.17	91:9	1.3	ND
261	9489	80	-1	0.23	0	-0.17	88:12	10.8	ND
262	9109	79.9	-1.1	0.16	0	-0.01	85:15	0.6	ND
263	9645	79.90*	-1.30*	0.14*	0.00*	0.05*	88:12	4	88:12
264	9648	79.9	-1.1	0.14+	0.00+	0.05+	70:30	34.2	ND
265	9888	79.9	-1.1	0.14+	0.00+	0.06+	96:4	4.3	82:18
266	9887	79.9	-1.1	0.14+	0.00+	0.06+	96:4	1.1	ND
267	6054	79.9	-1.1	0.24	0	-0.18	67:33	1.8	ND
268	9092	79.9	-1.1	0.16	0	-0.02	97:3	2	ND
269	9091	79.9	-1.1	0.16	0	-0.02	94:6	3.6	96:4
270	9090	79.9	-1.1	0.16	0	-0.02	95:5	9.9	94:6
271	9338	79.9	-1.1	0.24	0	-0.18	89:11	3.4	ND
272	9339	79.9	-1.1	0.24	0	-0.18	58:42	5.5	72:28
273	9116	79.9	-1.1	0.16	0	-0.02	87:13	0	ND
274	9609	79.80*	-1.40*	ND	ND	ND	79:21	9.1	87:13
275	9606	79.80*	-1.40*	ND	ND	ND	59:41	14.3	ND
276	9602	79.80*	-1.40*	ND	ND	ND	82:18	10.2	81:19
277	9107	79.8	-1.2	0.16	0	-0.01	99:1	6.7	98:2
278	9106	79.8	-1.2	0.16	0	-0.01	90:10	0.5	ND
279	9108	79.80*	-1.40*	0.16*	0.00*	-0.01*	93:7	1.3	ND
280	9850	79.8	-1.2	0.15+	0.00+	0.01+	96:4	10.5	96:4
281	9981	79.8	-1.2	0.12+	0.00+	0.10+	96:4	1.7	ND
282	9495	79.8	-1.2	0.24	0	-0.19	93:7	0.1	ND
283	9492	79.8	-1.2	0.24	0	-0.19	76:24	62.6	ND
284	9491	79.8	-1.2	0.24	0	-0.19	70:30	58.7	ND
285	9498	79.8	-1.2	0.24	0	-0.19	79:21	52.3	ND
286	9889	79.8	-1.2	0.05+	0.00+	0.49+	94:6	8.4	87:13

287	9593	79.8	-1.2	ND, low Fab capture	ND, low Fab capture	ND, low Fab capture	73:27	4.7	ND
288	9590	79.8	-1.2	ND, low Fab capture	ND, low Fab capture	ND, low Fab capture	72:28	6.7	ND
289	9594	79.80*	-1.40*	ND	ND	ND	59:41	22.4	ND
290	9598	79.80*	-1.40*	ND	ND	ND	59:41	26	ND
291	9867	79.8	-1.2	0.14+	0.00+	0.06+	95:5	2.1	ND
292	9868	79.8	-1.2	0.14+	0.00+	0.06+	94:6	10.4	87:13
293	9501	79.8	-1.2	0.24	0	-0.19	92:8	0	ND
294	9500	79.8	-1.2	0.24	0	-0.19	89:11	10.2	ND
295	9849	79.8	-1.2	0.15+	0.00+	0.01+	98:2	2.8	ND
296	9392	79.8	-1.2	0.22	0	-0.15	93:7	2.9	ND
297	9394	79.8	-1.2	0.22	0	-0.15	92:8	13.9	91:9
298	9395	79.8	-1.2	0.22	0	-0.15	93:7	1.3	ND
299	9096	79.8	-1.2	0.17	0	-0.04	96:4	4.5	94:6
300	9095	79.8	-1.2	0.17	0	-0.04	94:6	1.2	96:4
301	9094	79.8	-1.2	0.17	0	-0.04	94:6	10	93:7
302	9986	79.80*	-1.40*	ND	ND	ND	47:53	0	ND
303	9376	79.8	-1.2	0.22	0	-0.15	92:8	0.3	ND
304	9471	79.8	-1.2	0.18	0	-0.07	90:10	0	ND
305	9473	79.8	-1.2	0.18	0	-0.07	93:7	0	ND
306	9890	79.8	-1.2	0.05+	0.00+	0.49+	93:7	14.2	82:18
307	9754	79.8	-1.2	0.3	0	-0.28	86:14	13.3	82:18
308	9380	79.8	-1.2	0.22	0	-0.15	92:8	0.7	84:16
309	9384	79.8	-1.2	0.22	0	-0.15	92:8	0	ND
310	9980	79.8	-1.2	0.16+	0.00+	0.00+	97:3	0.1	ND
311	9985	79.8	-1.2	0.12+	0.00+	0.10+	95:5	2.3	ND
312	9984	79.8	-1.2	0.16+	0.00+	0.00+	97:3	0.5	ND
313	9327	79.8	-1.2	0.24	0	-0.19	99:1	0.5	ND
314	9326	79.8	-1.2	0.24	0	-0.19	94:6	0	ND
315	9328	79.80*	-1.40*	0.24*	0.00*	-0.19*	93:7	0	ND
316	9484	79.8	-1.2	0.18	0	-0.07	92:8	0	ND
317	9481	79.8	-1.2	0.18	0	-0.07	91:9	4.5	ND
318	9483	79.8	-1.2	0.18	0	-0.07	90:10	7.4	ND
319	9388	79.8	-1.2	0.22	0	-0.15	92:8	0	ND
320	9451	79.7	-1.3	0.26	0	-0.23	93:7	0	ND
321	9459	79.7	-1.3	0.26	0	-0.23	92:8	1.2	ND
322	9541	79.7	-1.3	0.22	0	-0.15	91:9	0	ND
323	9468	79.7	-1.3	0.18	0	-0.07	82:18	50.6	ND
324	9469	79.7	-1.3	0.18	0	-0.07	82:18	46.8	ND
325	9544	79.7	-1.3	0.22	0	-0.15	92:8	0	ND
326	9463	79.7	-1.3	0.18	0	-0.07	81:19	47.9	ND
327	9460	79.7	-1.3	0.26	0	-0.23	91:9	3.1	ND
328	9461	79.7	-1.3	0.26	0	-0.23	89:11	0	ND
329	9466	79.7	-1.3	0.18	0	-0.07	85:15	50	ND
330	9464	79.7	-1.3	0.18	0	-0.07	93:7	4.4	ND
331	9465	79.7	-1.3	0.18	0	-0.07	93:7	2.9	ND
332	9824	79.7	-1.3	0.15+	0.00+	0.03+	94:6	11.6	93:7
333	9364	79.7	-1.3	0.15	0	0.01	73:27	0	ND
334	9367	79.7	-1.3	0.15	0	0.01	78:22	0	ND
335	9366	79.7	-1.3	0.15	0	0.01	80:20	0	ND
336	9368	79.7	-1.3	0.15	0	0.01	91:9	0	ND
337	9449	79.7	-1.3	0.26	0	-0.23	82:18	0	ND
338	9778	79.7	-1.3	0.12+	0.00+	0.13+	94:6	0.5	ND
339	9542	79.7	-1.3	0.22	0	-0.15	94:6	0	ND
340	9777	79.7	-1.3	0.12+	0.00+	0.13+	97:3	0.1	ND
341	9852	79.6	-1.4	0.15+	0.00+	0.02+	95:5	9.7	89:11
342	9851	79.6	-1.4	0.15+	0.00+	0.02+	91:9	14.4	90:10
343	9130	79.60*	-1.60*	0.15*	0.00*	0.02*	92:8	5.1	ND
344	9131	79.60*	-1.60*	0.15*	0.00*	0.02*	94:6	3.7	ND
345	9152	79.60*	-1.60*	0.16*	0.00*	-0.01*	96:4	2.3	ND

346	9126	79.60*	-1.60*	0.15*	0.00*	0.02*	94:6	2.2	ND
347	9125	79.60*	-1.60*	0.15*	0.00*	0.02*	92:8	2.2	ND
348	9123	79.6	-1.4	0.15	0	0.02	94:6	3.2	ND
349	9684	79.6	-1.4	0.3	0	-0.28	60:40	3.1	ND
350	9683	79.60*	-1.60*	0.30*	0.00*	-0.28*	89:11	6.5	75:25
351	9129	79.60*	-1.60*	0.15*	0.00*	0.02*	94:6	6.4	ND
352	9127	79.60*	-1.60*	0.15*	0.00*	0.02*	94:6	4.3	ND
353	9162	79.60*	-1.60*	0.16*	0.00*	-0.01*	97:3	1.2	ND
354	9160	79.60*	-1.60*	0.16*	0.00*	-0.01*	96:4	3.1	ND
355	9164	79.60*	-1.60*	0.16*	0.00*	-0.01*	97:3	2.6	99:1
356	9150	79.5	-1.4	0.16	0	-0.01	97:3	1.3	37:63
357	9156	79.60*	-1.60*	0.16*	0.00*	-0.01*	96:4	3.5	95:5
358	9154	79.60*	-1.60*	0.16*	0.00*	-0.01*	97:3	2.8	97:3
359	9158	79.60*	-1.60*	0.16*	0.00*	-0.01*	96:4	2.2	ND
360	9426	79.5	-1.5	0.23	0	-0.16	88:12	0	ND
361	9425	79.5	-1.5	0.23	0	-0.16	92:8	0	ND
362	9423	79.5	-1.5	0.23	0	-0.16	93:7	6.3	ND
363	9420	79.5	-1.5	0.23	0	-0.16	90:10	0	ND
364	9979	79.5	-1.5	0.14+	0.00+	0.05+	98:2	0.4	ND
365	9419	79.5	-1.5	0.23	0	-0.16	90:10	0.3	ND
366	9398	79.5	-1.5	0.2	0	-0.12	92:8	1.8	ND
367	9397	79.5	-1.5	0.19	0	-0.08	91:9	3.1	94:6
368	9121	79.5	-1.5	0.13	0	0.08	98:2	3.3	98:2
369	9983	79.5	-1.5	0.14+	0.00+	0.05+	97:3	0.2	ND
370	9750	79.5	-1.5	0.23	0	-0.16	97:3	0	ND
371	9406	79.5	-1.5	0.2	0	-0.12	96:4	0	ND
372	9402	79.5	-1.5	0.2	0	-0.12	90:10	19.1	84:16
373	9830	79.5	-1.5	0.06+	0.00+	0.41+	98:2	2.9	90:10
374	9829	79.5	-1.5	0.06+	0.00+	0.41+	99:1	0.5	ND
375	9120	79.5	-1.5	0.13	0	0.08	53:47	17.4	ND
376	9749	79.5	-1.5	0.23	0	-0.16	87:13	7.1	ND
377	9417	79.5	-1.5	0.2	0	-0.12	73:27	49.1	ND
378	9416	79.5	-1.5	0.2	0	-0.12	91:9	0	ND
379	9414	79.5	-1.5	0.2	0	-0.12	89:11	6.2	94:6
380	9410	79.5	-1.5	0.2	0	-0.12	93:7	3.4	ND
381	9341	79.4	-1.6	0.26	0	-0.22	75:25	4.1	ND
382	9340	79.4	-1.6	0.26	0	-0.22	66:34	1.9	ND
383	9819	79.3	-1.7	0.15+	0.00+	0.03+	97:3	0.4	95:5
384	9564	79.3	-1.7	ND, low Fab capture	ND, low Fab capture	ND, low Fab capture	89:11	3.3	ND
385	9562	79.3	-1.7	ND, low Fab capture	ND, low Fab capture	ND, low Fab capture	78:22	4.8	ND
386	9814	79.2	-1.8	0.16+	0.00+	-0.01+	93:7	4.5	90:10
387	9332	79.2	-1.8	0.25	0	-0.2	86:14	1.4	ND
388	9330	79.2	-1.8	0.25	0	-0.2	79:21	5.2	ND
389	9114	79.1	-1.9	0.14	0	0.04	90:10	0	ND
390	9113	79.1	-1.9	0.14	0	0.04	74:26	0	ND
391	9748	79.1	-1.9	0.36	0	-0.36	99:1	1.6	ND
392	9747	79.1	-1.9	0.36	0	-0.36	89:11	5.3	78:22
393	10550	79	-2	ND, low Fab capture	ND, low Fab capture	ND, low Fab capture	99:1	1.8	99:1
394	9290	79	-2	0.2	0	-0.11	95:5	4.3	95:5
395	9049	79	-2	0.16	0	-0.01	89:11	0.7	ND
396	9827	79	-2	0.17+	0.00+	-0.03+	92:8	6.5	ND
397	9751	79	-2	ND, low Fab capture	ND, low Fab capture	ND, low Fab capture	97:3	0.3	ND
398	9067	79	-2	0.18	0	-0.06	96:4	2.3	ND
399	9279	79.00*	-2.20*	0.20*	0.00*	-0.11*	95:5	3.2	ND
400	9283	79	-2	0.2	0	-0.11	95:5	6.4	98:2

401	9281	79	-2	0.2	0	-0.11	96:4	2.4	ND
402	9286	79	-2	0.2	0	-0.11	97:3	1.9	97:3
403	9287	79	-2	0.2	0	-0.11	95:5	3	ND
404	9284	79	-2	0.2	0	-0.11	96:4	2.7	ND
405	9169	78.8	-2.2	ND, low Fab capture	ND, low Fab capture	ND, low Fab capture	94:6	7.7	ND
406	9168	78.8	-2.2	ND, low Fab capture	ND, low Fab capture	ND, low Fab capture	95:5	26.9	ND
407	9818	78.7	-2.3	0.18+	0.00+	-0.07+	90:10	10.5	94:6
408	9277	78.6	-2.4	0.2	0	-0.12	96:4	2.2	ND
409	9275	78.6	-2.4	0.2	0	-0.12	94:6	2.6	ND
410	9273	78.6	-2.4	0.2	0	-0.12	95:5	1.6	ND
411	9271	78.6	-2.4	0.2	0	-0.12	95:5	1.8	ND
412	9211	78.5	-2.5	0.2	0	-0.11	92:8	3.2	ND
413	9213	78.5	-2.5	0.2	0	-0.11	93:7	0.7	ND
414	9212	78.5	-2.5	0.2	0	-0.11	94:6	1	ND
415	9173	78.5	-2.5	0.25	0	-0.21	91:9	0	ND
416	9174	78.5	-2.5	0.25	0	-0.21	93:7	0	ND
417	9175	78.5	-2.5	0.25	0	-0.21	92:8	2.4	ND
418	9823	78.4	-2.6	0.24+	0.00+	-0.18+	94:6	3.4	97:3
419	9210	78.3	-2.7	ND, low Fab capture	ND, low Fab capture	ND, low Fab capture	92:8	1.4	ND
420	9042	78.3	ND	0.18	0	ND	98:2	2.2	98:2
421	9816	78.3	-2.7	0.19+	0.00+	-0.09+	96:4	2	ND
422	9256	78.3	-2.7	0.26	0	-0.21	95:5	1.6	ND
423	9821	78.3	-2.7	0.07+	0.00+	0.38+	92:8	4.3	ND
424	9826	78.3	-2.7	0.06+	0.00+	0.43+	86:14	3.5	ND
425	9208	78.3	-2.7	ND, low Fab capture	ND, low Fab capture	ND, low Fab capture	92:8	2.9	ND
426	9209	78.3	-2.7	ND, low Fab capture	ND, low Fab capture	ND, low Fab capture	94:6	0.5	ND
427	9250	78.3	-2.7	0.26	0	-0.21	95:5	0.6	ND
428	9253	78.3	-2.7	0.26	0	-0.21	95:5	0.4	ND
429	9252	78.3	-2.7	0.26	0	-0.21	95:5	2	ND
430	9255	78.3	-2.7	0.26	0	-0.21	95:5	0.6	ND
431	9316	78.20*	-3.00*	0.18*	0.00*	-0.07*	88:12	3.5	ND
432	9319	78.20*	-3.00*	0.18*	0.00*	-0.07*	90:10	0.7	ND
433	9298	78.20*	-3.00*	0.21*	0.00*	-0.12*	88:12	0.3	ND
434	9302	78.20*	-3.00*	0.21*	0.00*	-0.12*	89:11	1.3	ND
435	9300	78.20*	-3.00*	0.21*	0.00*	-0.12*	62:38	0	ND
436	9304	78.20*	-3.00*	0.21*	0.00*	-0.12*	87:13	8.4	ND
437	9308	78.20*	-3.00*	0.21*	0.00*	-0.12*	89:11	3	ND
438	9820	78.2	-2.8	0.20+	0.00+	-0.10+	97:3	4.2	ND
439	9320	78.20*	-3.00*	0.18*	0.00*	-0.07*	86:14	7	ND
440	9323	78.20*	-3.00*	0.18*	0.00*	-0.07*	91:9	0.9	ND
441	9247	78.1	-2.9	0.28	0	-0.26	92:8	2	ND
442	9248	78.1	-2.9	0.28	0	-0.26	94:6	1.9	ND
443	9249	78.1	-2.9	0.28	0	-0.26	94:6	0.8	ND
444	9075	78.1	-2.9	0.17	0	-0.03	97:3	1.9	ND
445	9828	78	-3	0.14+	0.00+	0.07+	96:4	0.5	96:4
446	9041	77.8	ND	0.14	0	ND	80:20	3.2	80:20
447	9815	77.8	-3.2	0.16+	0.00+	-0.01+	97:3	9.4	98:2
448	9613	77.8	-3.2	0.12+	0.00+	0.12+	96:4	0.4	ND
449	9170	77.8	-3.2	0.27	0	-0.24	92:8	0	ND
450	9171	77.8	-3.2	0.27	0	-0.24	91:9	0	ND
451	9172	77.8	-3.2	0.27	0	-0.24	93:7	0	ND
452	9825	77.7	-3.3	0.15+	0.00+	0.01+	87:13	26.1	91:9
453	9822	77.7	-3.3	0.11+	0.00+	0.17+	93:7	4.1	ND

454	9734	77.7	-3.3	0.26	0	-0.22	91:9	4.7	88:12
455	9817	77.5	-3.5	0.18+	0.00+	-0.05+	94:6	3.3	ND
456	9064	77.2	-3.8	0.17	0	-0.05	98:2	0.6	ND
457	9905	76.8	-4.2	0.10+	0.00+	0.20+	96:4	0.4	ND
458	9198	76.4	-4.6	0.28	0	-0.25	90:10	4.6	ND
459	9199	76.4	-4.6	0.28	0	-0.25	87:13	2.4	ND
460	9196	76.4	-4.6	0.28	0	-0.25	88:12	0.9	ND
461	9202	76.4	-4.6	0.28	0	-0.25	84:16	2.6	ND
462	9201	76.4	-4.6	0.28	0	-0.25	85:15	1.8	ND
463	9205	76.4	-4.6	0.28	0	-0.25	86:14	5.5	ND
464	9065	76.3	-4.7	0.18	0	-0.05	98:2	0.2	ND
465	9044	75.8	ND	0.18	0	ND	86:14	6	78:22
466	9112	74.8	-6.2	ND, low Fab capture	ND, low Fab capture	ND, low Fab capture	27:73	0	ND
467	9372	74.5	-6.5	0.27	0	-0.24	81:19	3.3	ND
468	9373	74.5	-6.5	0.27	0	-0.24	86:14	3.8	94:6
469	9043	74.1	ND	0.16	0	ND	96:4	0.1	ND
470	9518	ND	ND	0.2	0	-0.1	95:5	3.1	94:6
471	9513	ND	ND	0.26	0	-0.21	92:8	3.4	ND
472	9516	ND	ND	0.26	0	-0.21	94:6	0	ND
473	9515	ND	ND	0.26	0	-0.21	95:5	0	ND
474	9214	ND	ND	0.19	0	-0.08	85:15	5	ND
475	9217	ND	ND	0.19	0	-0.08	82:18	0.1	ND
476	9216	ND	ND	0.19	0	-0.08	79:21	0	ND
477	9219	ND	ND	0.19	0	-0.08	84:16	2.4	ND
478	9358	ND	ND	0.18	0	-0.07	79:21	0	ND
479	9359	ND	ND	0.16	0	-0.01	74:26	0	ND
480	9357	ND	ND	0.18	0	-0.07	80:20	0	ND
481	9351	ND	ND	0.2	0	-0.1	84:16	0	ND
482	9352	ND	ND	0.2	0	-0.1	90:10	1.9	ND
483	9353	ND	ND	0.2	0	-0.1	89:11	1.8	ND
484	9354	ND	ND	0.17	0	-0.04	81:19	0	ND
485	9350	ND	ND	0.2	0	-0.1	82:18	0	ND
486	9269	ND	ND	0.31	0	-0.29	87:13	1.2	ND
487	9266	ND	ND	0.31	0	-0.29	84:16	1.9	ND
488	9267	ND	ND	0.31	0	-0.29	62:38	0	ND
489	9260	ND	ND	0.24	0	-0.19	63:37	0	ND
490	9262	ND	ND	0.24	0	-0.19	85:15	1.1	ND
491	9263	ND	ND	0.24	0	-0.19	88:12	3.3	ND
492	9220	ND	ND	0.19	0	-0.08	81:19	7.6	ND
493	9225	ND	ND	0.16	0	-0.02	83:17	0.1	ND
494	9228	ND	ND	0.16	0	-0.02	76:24	0	ND
495	9229	ND	ND	0.16	0	-0.02	87:13	3.3	ND
496	9185	ND	ND	0.13	0	0.09	69:31	0	ND
497	9349	ND	ND	0.15	0	0.03	86:14	3	ND
498	9348	ND	ND	0.15	0	0.03	82:18	1.3	ND
499	9505	ND	ND	0.26	0	-0.21	94:6	0	ND
500	9503	ND	ND	0.26	0	-0.21	88:12	16.2	ND
501	10548	ND	ND	ND	ND	ND	96:4	3.2	97:3
502	10546	ND	ND	ND	ND	ND	95:5	2.4	ND
503	10547	ND	ND	ND	ND	ND	93:7	1.4	93:7
504	10545	ND	ND	ND	ND	ND	91:9	2.6	88:12
505	9521	ND	ND	0.2	0	-0.1	97:3	2.7	ND
506	9520	ND	ND	0.2	0	-0.1	95:5	0	ND
507	9176	ND	ND	0.22	0	-0.15	83:17	0	ND
508	9178	ND	ND	0.22	0	-0.15	83:17	0	ND
509	9179	ND	ND	0.22	0	-0.15	78:22	0	ND
510	9362	ND	ND	0.16	0	-0.01	80:20	0	ND
511	9270	ND	ND	0.31	0	-0.29	88:12	1.2	ND
512	9237	ND	ND	0.22	0	-0.15	89:11	5.5	ND
513	9236	ND	ND	0.22	0	-0.15	89:11	1.9	ND
514	9234	ND	ND	0.22	0	-0.15	86:14	1.9	ND



515	9239	ND	ND	0.22	0	-0.15	89:11	2.4	ND
516	9243	ND	ND	0.22	0	-0.15	87:13	1.2	ND
517	9240	ND	ND	0.22	0	-0.15	87:13	2.4	ND
518	9538	ND	ND	0.17	0	-0.04	85:15	0	ND
519	9344	ND	ND	0.27	0	-0.23	94:6	5.4	ND
520	9361	ND	ND	0.16	0	-0.01	83:17	0	ND
521	9188	ND	ND	0.13	0	0.09	63:37	0	ND
522	9226	ND	ND	0.16	0	-0.02	67:33	0	ND
523	9181	ND	ND	0.22	0	-0.15	85:15	0	ND
524	9536	ND	ND	0.17	0	-0.04	88:12	0	ND
525	9523	ND	ND	0.2	0	-0.1	93:7	9.8	91:9
526	9526	ND	ND	0.17	0	-0.04	80:20	0	ND
527	9257	ND	ND	0.24	0	-0.19	84:16	10	ND
528	9524	ND	ND	0.2	0	-0.1	95:5	4	ND
529	9259	ND	ND	0.24	0	-0.19	84:16	2.5	ND

\* Indicates estimated values that were derived from other Fab heterodimers that differ only in the presence/absence of the attached L chain tag (HA or FLAG)).

\*\* Values derived from the 333 (H1), 250 (L1), 749 (L2) LCCA experiments.

\*\*\* Values derived from the 333 (H1), 100 (L1), 899 (L2) LCCA experiments.

ND indicates that no data are available.

Table 13a. LCCA performance of the designs that met the LCCA average performance criteria of correctly paired: mispaired Fab heterodimers of 86:14

Cluster	Unique identifier ***	lcca average performance (i.e. $0.5(\ln(r1/f1) + \ln(r2/f2))$ )	H1L1:H1L2 normalized median scalar value $\ln(r1/f1)^*$	H1L1:H1L2 normalized median ratio*	H1L1:H1L2 range of normalized ratios*	H1L1:H1L2 normalized median scalar value $\ln(r1/f1)^{**}$	H1L1:H1L2 normalized median ratio**	H2L2:H2L1 normalized median scalar value $\ln(r2/f2)^*$	H2L2:H2L1 normalized median ratio*	H2L2:H2L1 range of normalized ratios*	H2L2:H2L1 normalized median scalar value $\ln(r2/f2)^{**}$	H2L2:H2L1 normalized median ratio**
1	9134-9521	3.19	2.8	94:6	6.7	NA	NA	3.57	97:3	2.7	NA	NA
1	9123-9521	3.12	2.67	94:6	3.2	NA	NA	3.57	97:3	2.7	NA	NA
1	9150-9523	3.08	3.52	97:3	1.3	-0.52	37:63	2.64	93:7	9.8	2.36	91:9
1	9152-9515	3.065	3.28	96:4	2.3	NA	NA	2.86	95:5	0	NA	NA
1	9154-9394	3.03	3.61	97:3	2.8	3.39	97:3	2.45	92:8	13.9	2.32	91:9
1	9164-9555	3.025	3.64	97:3	2.6	4.37	99:1	2.41	92:8	13.4	2.45	92:8
1	9146-9553	2.915	3.26	96:4	3.1	3.3	96:4	2.57	93:7	2.7	2	88:12
1	9162-9425	2.875	3.34	97:3	1.2	NA	NA	2.41	92:8	0	NA	NA
1	9164-9500	2.875	3.64	97:3	2.6	NA	NA	2.11	89:11	10.2	NA	NA
1	9154-9353	2.85	3.61	97:3	2.8	NA	NA	2.09	89:11	1.8	NA	NA
1	9152-9460	2.815	3.28	96:4	2.3	NA	NA	2.36	91:9	3.1	NA	NA
1	9160-9416	2.805	3.26	96:4	3.1	NA	NA	2.34	91:9	0	NA	NA
1	9136-9513	2.8	3.1	96:4	2.2	NA	NA	2.5	92:8	3.4	NA	NA
1	9136-9459	2.755	3.1	96:4	2.2	NA	NA	2.42	92:8	1.2	NA	NA
1	9144-9423	2.735	2.9	95:5	2.6	NA	NA	2.57	93:7	6.3	NA	NA
1	9158-9483	2.73	3.27	96:4	2.2	NA	NA	2.2	90:10	7.4	NA	NA
1	9142-9414	2.73	3.39	97:3	3.4	3.32	97:3	2.07	89:11	6.2	2.83	94:6
1	9138-9392	2.73	2.95	95:5	4.6	NA	NA	2.53	93:7	2.9	NA	NA
1	9156-9397	2.705	3.11	96:4	3.5	3	95:5	2.3	91:9	3.1	2.73	94:6
1	9140-9481	2.655	2.98	95:5	3.4	NA	NA	2.33	91:9	4.5	NA	NA
1	9131-9553	2.63	2.7	94:6	3.7	NA	NA	2.57	93:7	2.7	NA	NA
1	9164-9446	2.6	3.64	97:3	2.6	NA	NA	1.56	83:17	24.8	NA	NA
1	9126-9392	2.59	2.67	94:6	2.2	NA	NA	2.53	93:7	2.9	NA	NA
1	9138-9352	2.58	2.95	95:5	4.6	NA	NA	2.22	90:10	1.9	NA	NA
1	9127-9481	2.54	2.75	94:6	4.3	NA	NA	2.33	91:9	4.5	NA	NA
1	9130-9423	2.52	2.47	92:8	5.1	NA	NA	2.57	93:7	6.3	NA	NA
1	9158-9538	2.515	3.27	96:4	2.2	NA	NA	1.76	85:15	0	NA	NA
1	9150-9468	2.51	3.52	97:3	1.3	NA	NA	1.5	82:18	50.6	NA	NA

1	9125-9513	2.48	2.46	92:8	2.2	NA	NA	2.5	92:8	3.4	NA	NA
1	9140-9536	2.465	2.98	95:5	3.4	NA	NA	1.95	88:12	0	NA	NA
1	9126-9352	2.44	2.67	94:6	2.2	NA	NA	2.22	90:10	1.9	NA	NA
1	9164-9367	2.44	3.64	97:3	2.6	NA	NA	1.24	78:22	0	NA	NA
1	9125-9459	2.435	2.46	92:8	2.2	NA	NA	2.42	92:8	1.2	NA	NA
1	9142-9357	2.4	3.39	97:3	3.4	NA	NA	1.41	80:20	0	NA	NA
1	9129-9414	2.395	2.72	94:6	6.4	NA	NA	2.07	89:11	6.2	NA	NA
1	9162-9362	2.37	3.34	97:3	1.2	NA	NA	1.4	80:20	0	NA	NA
1	9127-9536	2.35	2.75	94:6	4.3	NA	NA	1.95	88:12	0	NA	NA
1	9146-9366	2.325	3.26	96:4	3.1	NA	NA	1.39	80:20	0	NA	NA
1	9160-9358	2.31	3.26	96:4	3.1	NA	NA	1.35	79:21	0	NA	NA
1	9146-9498	2.3	3.26	96:4	3.1	NA	NA	1.33	79:21	52.3	NA	NA
1	9156-9354	2.265	3.11	96:4	3.5	NA	NA	1.42	81:19	0	NA	NA
1	9134-9466	2.255	2.8	94:6	6.7	NA	NA	1.7	85:15	50	NA	NA
1	9144-9361	2.25	2.9	95:5	2.6	NA	NA	1.6	83:17	0	NA	NA
1	9123-9466	2.185	2.67	94:6	3.2	NA	NA	1.7	85:15	50	NA	NA
1	9129-9357	2.065	2.72	94:6	6.4	NA	NA	1.41	80:20	0	NA	NA
1	9131-9366	2.04	2.7	94:6	3.7	NA	NA	1.39	80:20	0	NA	NA
1	9130-9361	2.035	2.47	92:8	5.1	NA	NA	1.6	83:17	0	NA	NA
1	9131-9498	2.015	2.7	94:6	3.7	NA	NA	1.33	79:21	52.3	NA	NA
1	9146-9444	1.99	3.26	96:4	3.1	NA	NA	0.72	67:33	66.2	NA	NA
2	9279-9518	2.945	3.03	95:5	3.2	NA	NA	2.86	95:5	3.1	NA	NA
2	9286-9402	2.84	3.47	97:3	1.9	3.39	97:3	2.21	90:10	19.1	1.64	84:16
2	9287-9486	2.735	3.03	95:5	3	NA	NA	2.44	92:8	0	NA	NA
2	9283-9380	2.7	2.93	95:5	6.4	3.99	98:2	2.47	92:8	0.7	1.66	84:16
2	9273-9398	2.7	3	95:5	1.6	NA	NA	2.4	92:8	1.8	NA	NA
2	9252-9380	2.67	2.87	95:5	2	NA	NA	2.47	92:8	0.7	NA	NA
2	9323-9440	2.67	2.34	91:9	0.9	NA	NA	2.99	95:5	0	NA	NA
2	9287-9541	2.665	3.03	95:5	3	NA	NA	2.3	91:9	0	NA	NA
2	9271-9376	2.66	2.92	95:5	1.8	NA	NA	2.4	92:8	0.3	NA	NA
2	9284-9471	2.655	3.09	96:4	2.7	NA	NA	2.22	90:10	0	NA	NA
2	9290-9432	2.65	3.04	95:5	4.3	3.02	95:5	2.26	91:9	2.8	1.49	82:18

2	9256-9432	2.645	3.03	95:5	1.6	NA	NA	2.26	91:9	2.8	NA	NA
2	9253-9471	2.63	3.04	95:5	0.4	NA	NA	2.22	90:10	0	NA	NA
2	9302-9406	2.61	2.12	89:11	1.3	NA	NA	3.1	96:4	0	NA	NA
2	9287-9420	2.605	3.03	95:5	3	NA	NA	2.18	90:10	0	NA	NA
2	9308-9436	2.58	2.08	89:11	3	NA	NA	3.08	96:4	0	NA	NA
2	9255-9402	2.575	2.94	95:5	0.6	NA	NA	2.21	90:10	19.1	NA	NA
2	9248-9398	2.56	2.72	94:6	1.9	NA	NA	2.4	92:8	1.8	NA	NA
2	9209-9398	2.545	2.69	94:6	0.5	NA	NA	2.4	92:8	1.8	NA	NA
2	9281-9503	2.525	3.1	96:4	2.4	NA	NA	1.95	88:12	16.2	NA	NA
2	9263-9436	2.51	1.95	88:12	3.3	NA	NA	3.08	96:4	0	NA	NA
2	9275-9419	2.505	2.81	94:6	2.6	NA	NA	2.2	90:10	0.3	NA	NA
2	9212-9402	2.495	2.78	94:6	1	NA	NA	2.21	90:10	19.1	NA	NA
2	9211-9380	2.49	2.51	92:8	3.2	NA	NA	2.47	92:8	0.7	NA	NA
2	9270-9440	2.47	1.95	88:12	1.2	NA	NA	2.99	95:5	0	NA	NA
2	9229-9440	2.465	1.94	87:13	3.3	NA	NA	2.99	95:5	0	NA	NA
2	9250-9503	2.465	2.98	95:5	0.6	NA	NA	1.95	88:12	16.2	NA	NA
2	9290-9546	2.46	3.04	95:5	4.3	3.02	95:5	1.88	87:13	14.2	1.75	85:15
2	9247-9376	2.455	2.51	92:8	2	NA	NA	2.4	92:8	0.3	NA	NA
2	9256-9546	2.455	3.03	95:5	1.6	NA	NA	1.88	87:13	14.2	NA	NA
2	9323-9495	2.455	2.34	91:9	0.9	NA	NA	2.56	93:7	0.1	NA	NA
2	9213-9432	2.45	2.65	93:7	0.7	NA	NA	2.26	91:9	2.8	NA	NA
2	9262-9406	2.44	1.77	85:15	1.1	NA	NA	3.1	96:4	0	NA	NA
2	9181-9406	2.43	1.76	85:15	0	NA	NA	3.1	96:4	0	NA	NA
2	9208-9376	2.415	2.44	92:8	2.9	NA	NA	2.4	92:8	0.3	NA	NA
2	9173-9380	2.4	2.33	91:9	0	NA	NA	2.47	92:8	0.7	NA	NA
2	9170-9376	2.39	2.38	92:8	0	NA	NA	2.4	92:8	0.3	NA	NA
2	9196-9516	2.39	2.02	88:12	0.9	NA	NA	2.76	94:6	0	NA	NA
2	9319-9410	2.385	2.15	90:10	0.7	NA	NA	2.63	93:7	3.4	NA	NA
2	9171-9398	2.38	2.36	91:9	0	NA	NA	2.4	92:8	1.8	NA	NA
2	9219-9406	2.375	1.66	84:16	2.4	NA	NA	3.1	96:4	0	NA	NA
2	9174-9402	2.37	2.53	93:7	0	NA	NA	2.21	90:10	19.1	NA	NA
2	9198-9395	2.365	2.17	90:10	4.6	NA	NA	2.57	93:7	1.3	NA	NA

2	9175-9432	2.345	2.44	92:8	2.4	NA	NA	2.26	91:9	2.8	NA	NA
2	9236-9395	2.33	2.08	89:11	1.9	NA	NA	2.57	93:7	1.3	NA	NA
2	9281-9449	2.325	3.1	96:4	2.4	NA	NA	1.55	82:18	0	NA	NA
2	9234-9516	2.3	1.84	86:14	1.9	NA	NA	2.76	94:6	0	NA	NA
2	9308-9547	2.29	2.08	89:11	3	NA	NA	2.5	92:8	0	NA	NA
2	9304-9542	2.29	1.89	87:13	8.4	NA	NA	2.7	94:6	0	NA	NA
2	9243-9556	2.27	1.93	87:13	1.2	NA	NA	2.61	93:7	0	NA	NA
2	9250-9449	2.265	2.98	95:5	0.6	NA	NA	1.55	82:18	0	NA	NA
2	9213-9546	2.26	2.65	93:7	0.7	NA	NA	1.88	87:13	14.2	NA	NA
2	9269-9410	2.26	1.9	87:13	1.2	NA	NA	2.63	93:7	3.4	NA	NA
2	9237-9484	2.255	2.12	89:11	5.5	NA	NA	2.39	92:8	0	NA	NA
2	9270-9495	2.255	1.95	88:12	1.2	NA	NA	2.56	93:7	0.1	NA	NA
2	9220-9436	2.255	1.44	81:19	7.6	NA	NA	3.08	96:4	0	NA	NA
2	9229-9495	2.25	1.94	87:13	3.3	NA	NA	2.56	93:7	0.1	NA	NA
2	9284-9526	2.25	3.09	96:4	2.7	NA	NA	1.41	80:20	0	NA	NA
2	9279-9463	2.235	3.03	95:5	3.2	NA	NA	1.45	81:19	47.9	NA	NA
2	9304-9487	2.235	1.89	87:13	8.4	NA	NA	2.59	93:7	2.9	NA	NA
2	9323-9550	2.225	2.34	91:9	0.9	NA	NA	2.1	89:11	19.8	NA	NA
2	9214-9505	2.225	1.71	85:15	5	NA	NA	2.74	94:6	0	NA	NA
2	9253-9526	2.225	3.04	95:5	0.4	NA	NA	1.41	80:20	0	NA	NA
2	9263-9547	2.22	1.95	88:12	3.3	NA	NA	2.5	92:8	0	NA	NA
2	9271-9350	2.22	2.92	95:5	1.8	NA	NA	1.52	82:18	0	NA	NA
2	9316-9388	2.215	2	88:12	3.5	NA	NA	2.42	92:8	0	NA	NA
2	9298-9384	2.215	2.01	88:12	0.3	NA	NA	2.41	92:8	0	NA	NA
2	9243-9501	2.2	1.93	87:13	1.2	NA	NA	2.47	92:8	0	NA	NA
2	9257-9505	2.195	1.65	84:16	10	NA	NA	2.74	94:6	0	NA	NA
2	9205-9556	2.195	1.78	86:14	5.5	NA	NA	2.61	93:7	0	NA	NA
2	9176-9505	2.18	1.62	83:17	0	NA	NA	2.74	94:6	0	NA	NA
2	9175-9546	2.155	2.44	92:8	2.4	NA	NA	1.88	87:13	14.2	NA	NA
2	9214-9451	2.15	1.71	85:15	5	NA	NA	2.59	93:7	0	NA	NA
2	9199-9484	2.145	1.9	87:13	2.4	NA	NA	2.39	92:8	0	NA	NA
2	9240-9544	2.135	1.87	87:13	2.4	NA	NA	2.4	92:8	0	NA	NA

2	9205-9501	2.125	1.78	86:14	5.5	NA	NA	2.47	92:8	0	NA	NA
2	9257-9451	2.12	1.65	84:16	10	NA	NA	2.59	93:7	0	NA	NA
2	9243-9368	2.11	1.93	87:13	1.2	NA	NA	2.29	91:9	0	NA	NA
2	9176-9451	2.105	1.62	83:17	0	NA	NA	2.59	93:7	0	NA	NA
2	9196-9461	2.06	2.02	88:12	0.9	NA	NA	2.1	89:11	0	NA	NA
2	9217-9473	2.055	1.52	82:18	0.1	NA	NA	2.59	93:7	0	NA	NA
2	9320-9488	2.05	1.82	86:14	7	NA	NA	2.28	91:9	1.3	NA	NA
2	9266-9388	2.045	1.67	84:16	1.9	NA	NA	2.42	92:8	0	NA	NA
2	9202-9544	2.04	1.68	84:16	2.6	NA	NA	2.4	92:8	0	NA	NA
2	9205-9368	2.035	1.78	86:14	5.5	NA	NA	2.29	91:9	0	NA	NA
2	9259-9384	2.035	1.67	84:16	2.5	NA	NA	2.41	92:8	0	NA	NA
2	9290-9364	2.03	3.04	95:5	4.3	NA	NA	1.02	73:27	0	NA	NA
2	9256-9364	2.025	3.03	95:5	1.6	NA	NA	1.02	73:27	0	NA	NA
2	9270-9550	2.025	1.95	88:12	1.2	NA	NA	2.1	89:11	19.8	NA	NA
2	9229-9550	2.02	1.94	87:13	3.3	NA	NA	2.1	89:11	19.8	NA	NA
2	9247-9350	2.015	2.51	92:8	2	NA	NA	1.52	82:18	0	NA	NA
2	9178-9384	2	1.59	83:17	0	NA	NA	2.41	92:8	0	NA	NA
2	9225-9388	1.99	1.56	83:17	0.1	NA	NA	2.42	92:8	0	NA	NA
2	9208-9350	1.975	2.44	92:8	2.9	NA	NA	1.52	82:18	0	NA	NA
2	9234-9461	1.97	1.84	86:14	1.9	NA	NA	2.1	89:11	0	NA	NA
2	9220-9547	1.965	1.44	81:19	7.6	NA	NA	2.5	92:8	0	NA	NA
2	9290-9491	1.95	3.04	95:5	4.3	NA	NA	0.86	70:30	58.7	NA	NA
2	9170-9350	1.95	2.38	92:8	0	NA	NA	1.52	82:18	0	NA	NA
2	9256-9491	1.945	3.03	95:5	1.6	NA	NA	0.86	70:30	58.7	NA	NA
2	9275-9359	1.94	2.81	94:6	2.6	NA	NA	1.07	74:26	0	NA	NA
2	9179-9473	1.915	1.24	78:22	0	NA	NA	2.59	93:7	0	NA	NA
2	9240-9489	1.915	1.87	87:13	2.4	NA	NA	1.96	88:12	10.8	NA	NA
2	9240-9426	1.91	1.87	87:13	2.4	NA	NA	1.95	88:12	0	NA	NA
2	9228-9410	1.89	1.16	76:24	0	NA	NA	2.63	93:7	3.4	NA	NA
2	9216-9384	1.86	1.31	79:21	0	NA	NA	2.41	92:8	0	NA	NA
2	9298-9351	1.83	2.01	88:12	0.3	NA	NA	1.64	84:16	0	NA	NA
2	9213-9364	1.83	2.65	93:7	0.7	NA	NA	1.02	73:27	0	NA	NA

2	9202-9489	1.82	1.68	84:16	2.6	NA	NA	1.96	88:12	10.8	NA	NA
2	9243-9447	1.815	1.93	87:13	1.2	NA	NA	1.7	85:15	23.8	NA	NA
2	9202-9426	1.815	1.68	84:16	2.6	NA	NA	1.95	88:12	0	NA	NA
3	9338-9748	3.335	4.42	99:1	1.6	NA	NA	2.12	89:11	3.4	NA	NA
3	9372-9748	2.995	4.42	99:1	1.6	NA	NA	1.44	81:19	33	NA	NA
3	6054-9327	2.865	4.81	99:1	0.5	NA	NA	0.72	67:33	1.8	NA	NA
3	9338-9750	2.86	3.6	97:3	0	NA	NA	2.12	89:11	3.4	NA	NA
3	9334-9747	2.795	2.08	89:11	5.3	1.25	78:22	3.51	97:3	2.4	2.98	95:5
3	9121-9373	2.78	3.72	98:2	3.3	3.99	98:2	1.84	86:14	3.8	2.69	94:6
3	9334-9749	2.685	1.86	87:13	7.1	NA	NA	3.51	97:3	2.4	NA	NA
3	9815-9825	2.66	3.43	97:3	9.4	3.69	98:2	1.89	87:13	26.1	2.34	91:9
3	9815-9826	2.625	3.43	97:3	9.4	NA	NA	1.82	86:14	3.5	NA	NA
3	9816-9825	2.535	3.18	96:4	2	NA	NA	1.89	87:13	26.1	NA	NA
3	9372-9750	2.52	3.6	97:3	0	NA	NA	1.44	81:19	33	NA	NA
3	9816-9826	2.5	3.18	96:4	2	NA	NA	1.82	86:14	3.5	NA	NA
3	9107-9339	2.475	4.62	99:1	6.7	3.87	98:2	0.33	58:42	5.5	0.93	72:28
3	9066-9335	2.475	2.52	93:7	2.7	3.06	96:4	2.43	92:8	2.8	2.89	95:5
3	6048-9326	2.415	2.79	94:6	0	NA	NA	2.04	88:12	4	NA	NA
3	9328-9332	2.175	2.53	93:7	0	NA	NA	1.82	86:14	1.4	NA	NA
3	9122-9371	2.035	1.44	81:19	8	NA	NA	2.63	93:7	2	NA	NA
3	9104-9336	2.02	2.23	90:10	1.8	NA	NA	1.8	86:14	1.9	NA	NA
3	9108-9330	1.945	2.54	93:7	1.3	NA	NA	1.35	79:21	5.2	NA	NA
3	9106-9337	1.885	2.16	90:10	0.5	NA	NA	1.6	83:17	2.5	NA	NA
3	9369-9747	1.86	2.08	89:11	5.3	NA	NA	1.64	84:16	56.1	NA	NA
3	9109-9332	1.8	1.77	85:15	0.6	NA	NA	1.82	86:14	1.4	NA	NA
4	9168-9342	3.39	2.99	95:5	26.9	NA	NA	3.51	97:3	3.1	NA	NA
4	9169-9344	2.69	2.67	94:6	7.7	NA	NA	2.71	94:6	5.4	NA	NA
4	9114-9344	2.47	2.23	90:10	0	NA	NA	2.71	94:6	5.4	NA	NA
4	6098-9118	2.4	2.88	95:5	1.9	NA	NA	1.93	87:13	3.1	NA	NA
4	9113-9342	2.28	1.05	74:26	0	NA	NA	3.51	97:3	3.1	NA	NA
4	9117-9374	2.265	3.34	97:3	1.2	NA	NA	1.19	77:23	34.8	NA	NA
4	9119-9375	2.23	3.33	97:3	1.7	3.32	97:3	1.13	76:24	23.2	1.12	75:25

4	9111-9347	2.215	2.3	91:9	4.3	3.67	98:2	2.13	89:11	1.8	2.69	94:6
5	9116-9349	1.89	1.93	87:13	0	NA	NA	1.85	86:14	3	NA	NA
6	9075-9745	3.245	3.43	97:3	1.9	NA	NA	3.05	95:5	0.1	NA	NA
6	9745-9905	3.185	3.05	95:5	0.1	NA	NA	3.31	96:4	0.4	NA	NA
6	9075-9746	3.13	3.43	97:3	1.9	NA	NA	2.83	94:6	0.1	NA	NA
6	9746-9905	3.07	2.83	94:6	0.1	NA	NA	3.31	96:4	0.4	NA	NA
6	9814-9828	2.96	2.66	93:7	4.5	2.16	90:10	3.26	96:4	0.6	3.26	96:4
6	9813-9828	2.895	2.53	93:7	3.6	2.09	89:11	3.26	96:4	0.6	3.26	96:4
6	10547-10549	2.88	2.57	93:7	1.4	2.54	93:7	3.19	96:4	2.9	2.54	93:7
6	10545-10549	2.755	3.19	96:4	2.9	2.54	93:7	2.32	91:9	2.6	2	88:12
6	9814-9824	2.695	2.66	93:7	4.5	2.16	90:10	2.73	94:6	11.6	2.52	93:7
6	10547-10551	2.675	2.57	93:7	1.4	2.54	93:7	2.78	94:6	1.1	2.42	92:8
6	9813-9824	2.63	2.53	93:7	3.6	2.09	89:11	2.73	94:6	11.6	2.52	93:7
6	10545-10551	2.55	2.78	94:6	1.1	2.42	92:8	2.32	91:9	2.6	2	88:12
7	9060-9756	2.89	3.79	98:2	2.7	3.38	97:3	1.99	88:12	0.9	1.92	87:13
7	9054-9060	2.835	1.88	87:13	5	1.85	86:14	3.79	98:2	2.7	3.38	97:3
7	9053-9058	2.685	1.71	85:15	7.6	2.31	91:9	3.66	97:3	2	2.96	95:5
7	9058-9755	2.44	3.66	97:3	2	2.96	95:5	1.22	77:23	3.2	1.39	80:20
8	9820-9823	3.175	3.58	97:3	4.2	NA	NA	2.77	94:6	3.4	NA	NA
8	9819-9823	3.135	3.5	97:3	0.4	2.96	95:5	2.77	94:6	3.4	3.55	97:3
8	9820-9822	3.11	3.58	97:3	4.2	NA	NA	2.64	93:7	4.1	NA	NA
8	9819-9822	3.07	3.5	97:3	0.4	NA	NA	2.64	93:7	4.1	NA	NA
8	9820-9821	3.03	3.58	97:3	4.2	NA	NA	2.48	92:8	4.3	NA	NA
8	9820-9827	3.005	3.58	97:3	4.2	NA	NA	2.43	92:8	6.5	NA	NA
8	9819-9821	2.99	3.5	97:3	0.4	NA	NA	2.48	92:8	4.3	NA	NA
8	9819-9827	2.965	3.5	97:3	0.4	NA	NA	2.43	92:8	6.5	NA	NA
8	9817-9823	2.725	2.68	94:6	3.3	NA	NA	2.77	94:6	3.4	NA	NA
8	9817-9822	2.66	2.68	94:6	3.3	NA	NA	2.64	93:7	4.1	NA	NA
8	9817-9821	2.58	2.68	94:6	3.3	NA	NA	2.48	92:8	4.3	NA	NA
8	9817-9827	2.555	2.68	94:6	3.3	NA	NA	2.43	92:8	6.5	NA	NA
8	9818-9823	2.485	2.2	90:10	10.5	2.71	94:6	2.77	94:6	3.4	3.55	97:3
8	9818-9822	2.42	2.2	90:10	10.5	NA	NA	2.64	93:7	4.1	NA	NA



8	9818-9821	2.34	2.2	90:10	10.5	NA	NA	2.48	92:8	4.3	NA	NA
8	9818-9827	2.315	2.2	90:10	10.5	NA	NA	2.43	92:8	6.5	NA	NA
9	10548-10550	4.01	3.13	96:4	3.2	3.51	97:3	4.89	99:1	1.8	4.59	99:1
9	10548-10552	3.94	3.13	96:4	3.2	3.51	97:3	4.75	99:1	0.1	5	99:1
9	10546-10550	3.93	2.97	95:5	2.4	NA	NA	4.89	99:1	1.8	NA	NA
9	10546-10552	3.86	2.97	95:5	2.4	NA	NA	4.75	99:1	0.1	NA	NA
9	9077-9611	3.73	2.33	91:9	2.1	1.38	80:20	5	99:1	4.6	5	99:1
9	9065-9751	3.61	3.88	98:2	0.2	NA	NA	3.33	97:3	0.3	NA	NA
9	9064-9751	3.5	3.67	98:2	0.6	NA	NA	3.33	97:3	0.3	NA	NA
9	9065-9752	3.415	3.88	98:2	0.2	NA	NA	2.95	95:5	3	NA	NA
9	9078-9612	3.41	2.49	92:8	3.7	1.74	85:15	4.33	99:1	2.7	4.33	99:1
9	9076-9610	3.375	1.21	77:23	5.2	1.5	82:18	5	99:1	1.8	3.75	98:2
9	9064-9752	3.305	3.67	98:2	0.6	NA	NA	2.95	95:5	3	NA	NA
9	9074-9753	2.845	3.62	97:3	1.4	4.29	99:1	2.07	89:11	4.9	1.2	77:23
9	9753-9760	2.83	2.07	89:11	4.9	1.2	77:23	3.59	97:3	2.8	2.86	95:5
9	9074-9754	2.715	3.62	97:3	1.4	4.29	99:1	1.81	86:14	13.3	1.54	82:18
9	9754-9760	2.7	1.81	86:14	13.3	1.54	82:18	3.59	97:3	2.8	2.86	95:5
10	9095-9561	3.2	2.81	94:6	1.2	NA	NA	3.59	97:3	0.3	NA	NA
10	9094-9559	2.995	2.82	94:6	10	NA	NA	3.17	96:4	1.4	NA	NA
10	9099-9564	2.735	3.38	97:3	11.1	NA	NA	2.09	89:11	3.3	NA	NA
10	9096-9564	2.585	3.08	96:4	4.5	NA	NA	2.09	89:11	3.3	NA	NA
10	9091-9560	2.54	2.8	94:6	3.6	3.13	96:4	2.28	91:9	1.3	2.06	89:11
10	9090-9558	2.495	2.88	95:5	9.9	2.69	94:6	2.11	89:11	2.4	2.45	92:8
10	9092-9562	2.435	3.61	97:3	2	NA	NA	1.26	78:22	4.8	NA	NA
10	9098-9562	2.425	3.59	97:3	2.3	NA	NA	1.26	78:22	4.8	NA	NA
10	9092-9571	2.225	3.61	97:3	2	NA	NA	0.84	70:30	10.7	NA	NA
10	9098-9571	2.215	3.59	97:3	2.3	NA	NA	0.84	70:30	10.7	NA	NA
10	9099-9572	2.1	3.38	97:3	11.1	NA	NA	0.82	69:31	8.7	NA	NA
10	9096-9572	1.95	3.08	96:4	4.5	NA	NA	0.82	69:31	8.7	NA	NA
11	9667-9830	3.17	2.29	91:9	8.6	2.18	90:10	4.05	98:2	2.9	2.17	90:10
11	9617-9853	2.865	1.74	85:15	3.3	2.05	89:11	3.99	98:2	2.6	2.89	95:5
11	9682-9740	2.77	2.62	93:7	1.3	2.45	92:8	2.92	95:5	3.3	2.1	89:11

11	9675-9852	2.73	2.46	92:8	15.4	2.45	92:8	3	95:5	9.7	2.13	89:11
11	9671-9810	2.71	1.83	86:14	2.5	1.77	85:15	3.59	97:3	4.9	1.77	85:15
11	9617-9891	2.7	1.74	85:15	3.3	NA	NA	3.65	97:3	0.5	NA	NA
11	9667-9802	2.665	2.29	91:9	8.6	2.18	90:10	3.04	95:5	10.8	1.84	86:14
11	9660-9858	2.665	1.69	84:16	4.8	NA	NA	3.63	97:3	0.8	NA	NA
11	9660-9896	2.64	1.69	84:16	4.8	NA	NA	3.59	97:3	1.6	NA	NA
11	9629-9858	2.635	1.63	84:16	2.6	NA	NA	3.63	97:3	0.8	NA	NA
11	9667-9758	2.62	2.29	91:9	8.6	2.18	90:10	2.95	95:5	17.8	1.66	84:16
11	9629-9896	2.61	1.63	84:16	2.6	NA	NA	3.59	97:3	1.6	NA	NA
11	9675-9812	2.61	2.46	92:8	15.4	2.45	92:8	2.76	94:6	5.3	2.22	90:10
11	9671-9784	2.545	1.83	86:14	2.5	1.77	85:15	3.26	96:4	9.4	2.14	89:11
11	9679-9898	2.53	1.75	85:15	5.6	NA	NA	3.3	96:4	0.3	NA	NA
11	9667-9868	2.525	2.29	91:9	8.6	2.18	90:10	2.76	94:6	10.4	1.9	87:13
11	9663-9838	2.52	2.27	91:9	13.6	1.29	78:22	2.77	94:6	3.5	2.83	94:6
11	9675-9890	2.51	2.46	92:8	15.4	2.45	92:8	2.56	93:7	14.2	1.52	82:18
11	9671-9888	2.5	1.83	86:14	2.5	1.77	85:15	3.17	96:4	4.3	1.55	82:18
11	9617-9787	2.5	1.74	85:15	3.3	2.05	89:11	3.26	96:4	1.4	1.86	87:13
11	9679-9794	2.48	1.75	85:15	5.6	NA	NA	3.21	96:4	0.9	NA	NA
11	9654-9893	2.455	1	73:27	38.5	NA	NA	3.9	98:2	2.3	NA	NA
11	9671-9850	2.445	1.83	86:14	2.5	1.77	85:15	3.06	96:4	10.5	3.08	96:4
11	9675-9786	2.44	2.46	92:8	15.4	2.45	92:8	2.42	92:8	6.7	2.29	91:9
11	9660-9792	2.425	1.69	84:16	4.8	NA	NA	3.17	96:4	1	NA	NA
11	9648-9853	2.415	0.84	70:30	34.2	NA	NA	3.99	98:2	2.6	NA	NA
11	9666-9731	2.405	2.41	92:8	5.1	1.96	88:12	2.4	92:8	3.9	2.49	92:8
11	9049-9759	2.395	2.08	89:11	0.7	NA	NA	2.72	94:6	0	NA	NA
11	9629-9792	2.395	1.63	84:16	2.6	NA	NA	3.17	96:4	1	NA	NA
11	9623-9893	2.345	0.79	69:31	30.5	NA	NA	3.9	98:2	2.3	NA	NA
11	9632-9838	2.335	1.9	87:13	14.8	1.55	82:18	2.77	94:6	3.5	2.83	94:6
11	9654-9855	2.295	1	73:27	38.5	NA	NA	3.59	97:3	0.7	NA	NA
11	9679-9860	2.26	1.75	85:15	5.6	1.59	83:17	2.77	94:6	10.8	2.11	89:11
11	9645-9761	2.255	2	88:12	4	2.02	88:12	2.51	92:8	5.9	2.15	90:10
11	9648-9891	2.25	0.84	70:30	34.2	NA	NA	3.65	97:3	0.5	NA	NA

11	9626-9836	2.25	2.08	89:11	5.8	1.28	78:22	2.42	92:8	5	2.1	89:11
11	9579-9797	2.25	1.31	79:21	14.5	NA	NA	3.17	96:4	2.9	NA	NA
11	9579-9901	2.24	1.31	79:21	14.5	NA	NA	3.16	96:4	1	NA	NA
11	9635-9898	2.22	1.14	76:24	28.6	NA	NA	3.3	96:4	0.3	NA	NA
11	9579-9863	2.21	1.31	79:21	14.5	NA	NA	3.1	96:4	3.9	NA	NA
11	9683-9841	2.205	2.14	89:11	6.5	1.1	75:25	2.27	91:9	2	1.9	87:13
11	9623-9855	2.185	0.79	69:31	30.5	NA	NA	3.59	97:3	0.7	NA	NA
11	9575-9841	2.185	2.1	89:11	1.4	2.09	89:11	2.27	91:9	2	1.9	87:13
11	9635-9794	2.17	1.14	76:24	28.6	NA	NA	3.21	96:4	0.9	NA	NA
11	9606-9893	2.145	0.38	59:41	14.3	NA	NA	3.9	98:2	2.3	NA	NA
11	9614-9761	2.145	1.78	86:14	6.2	1.84	86:14	2.51	92:8	5.9	2.15	90:10
11	9663-9769	2.13	2.27	91:9	13.6	1.29	78:22	1.99	88:12	10.6	2.16	90:10
11	9654-9789	2.09	1	73:27	38.5	NA	NA	3.17	96:4	1.1	NA	NA
11	9626-9767	2.075	2.08	89:11	5.8	1.28	78:22	2.07	89:11	14.7	2.54	93:7
11	9648-9787	2.05	0.84	70:30	34.2	NA	NA	3.26	96:4	1.4	NA	NA
11	9657-9836	2.02	1.62	83:17	33.4	NA	NA	2.42	92:8	5	NA	NA
11	9606-9855	1.985	0.38	59:41	14.3	NA	NA	3.59	97:3	0.7	NA	NA
11	9623-9789	1.98	0.79	69:31	30.5	NA	NA	3.17	96:4	1.1	NA	NA
11	9635-9860	1.95	1.14	76:24	28.6	NA	NA	2.77	94:6	10.8	NA	NA
11	9632-9769	1.945	1.9	87:13	14.8	1.55	82:18	1.99	88:12	10.6	2.16	90:10
11	9641-9797	1.91	0.64	65:35	3.3	NA	NA	3.17	96:4	2.9	NA	NA
11	9641-9901	1.9	0.64	65:35	3.3	NA	NA	3.16	96:4	1	NA	NA
11	9663-9876	1.875	2.27	91:9	13.6	1.29	78:22	1.48	81:19	17.1	1.85	86:14
11	9641-9863	1.87	0.64	65:35	3.3	NA	NA	3.1	96:4	3.9	NA	NA
11	9626-9874	1.85	2.08	89:11	5.8	1.28	78:22	1.62	83:17	6.3	2.14	89:11
11	9657-9767	1.845	1.62	83:17	33.4	NA	NA	2.07	89:11	14.7	NA	NA
11	9684-9797	1.795	0.41	60:40	3.1	NA	NA	3.17	96:4	2.9	NA	NA
12	9587-9735	2.83	2.37	91:9	6.3	1.95	88:12	3.29	96:4	21.1	1.07	74:26
12	9687-9737	2.63	2.06	89:11	5.4	1.86	87:13	3.2	96:4	10	2.63	93:7
12	9696-9782	2.585	1.9	87:13	18.1	NA	NA	3.27	96:4	5.6	NA	NA
12	9696-9848	2.49	1.9	87:13	18.1	2.25	90:10	3.08	96:4	11.8	2.28	91:9
12	9594-9829	2.315	0.37	59:41	22.4	NA	NA	4.26	99:1	0.5	NA	NA

12	9692-9846	2.305	1.62	83:17	5.2	1.33	79:21	2.99	95:5	2	2.05	89:11
12	9696-9886	2.28	1.9	87:13	18.1	NA	NA	2.66	93:7	4.3	NA	NA
12	9696-9808	2.28	1.9	87:13	18.1	2.25	90:10	2.66	93:7	12.7	1.7	85:15
12	9609-9737	2.275	1.35	79:21	9.1	1.92	87:13	3.2	96:4	10	2.63	93:7
12	9978-9986	2.27	-0.14	47:53	0	NA	NA	4.67	99:1	0.6	NA	NA
12	9692-9806	2.16	1.62	83:17	5.2	1.33	79:21	2.7	94:6	0.9	2.28	91:9
12	9688-9844	2.135	1.19	77:23	0.6	NA	NA	3.08	96:4	1.1	NA	NA
12	9688-9804	2.125	1.19	77:23	0.6	NA	NA	3.06	96:4	0.5	NA	NA
12	9602-9889	2.105	1.52	82:18	10.2	1.44	81:19	2.69	94:6	8.4	1.87	87:13
12	9602-9785	2.1	1.52	82:18	10.2	NA	NA	2.68	94:6	0.1	NA	NA
12	9574-9702	2.1	3.31	96:4	1.2	NA	NA	0.89	71:29	5	NA	NA
12	9602-9811	2.09	1.52	82:18	10.2	1.44	81:19	2.66	93:7	6.3	2.44	92:8
12	9692-9780	2.075	1.62	83:17	5.2	NA	NA	2.53	93:7	1	NA	NA
12	9594-9757	2.065	0.37	59:41	22.4	NA	NA	3.76	98:2	3.9	NA	NA
12	9705-9735	2.05	0.81	69:31	0	NA	NA	3.29	96:4	21.1	NA	NA
12	9103-9700	2.045	2.98	95:5	0.7	NA	NA	1.1	75:25	3.1	NA	NA
12	9598-9849	2.03	0.36	59:41	26	NA	NA	3.7	98:2	2.8	NA	NA
12	9720-9733	2.025	1.22	77:23	6.9	1.14	76:24	2.83	94:6	8.2	2.31	91:9
12	9688-9778	2.01	1.19	77:23	0.6	NA	NA	2.83	94:6	0.5	NA	NA
12	9598-9809	2.005	0.36	59:41	26	NA	NA	3.65	97:3	0.3	NA	NA
12	9982-9987	1.995	-0.16	46:54	0	NA	NA	4.15	98:2	0.3	NA	NA
12	9101-9700	1.995	2.9	95:5	0.2	NA	NA	1.1	75:25	3.1	NA	NA
12	9716-9807	1.99	0.28	57:43	0	NA	NA	3.69	98:2	5.6	NA	NA
12	9703-9734	1.985	1.63	84:16	14.8	1.32	79:21	2.34	91:9	4.7	2	88:12
12	9712-9779	1.97	1.03	74:26	13.9	NA	NA	2.91	95:5	2.1	NA	NA
12	9594-9801	1.96	0.37	59:41	22.4	NA	NA	3.54	97:3	1.4	NA	NA
12	9712-9805	1.95	1.03	74:26	13.9	NA	NA	2.87	95:5	2.3	NA	NA
12	9602-9851	1.945	1.52	82:18	10.2	1.44	81:19	2.37	91:9	14.4	2.23	90:10
12	9716-9847	1.94	0.28	57:43	0	NA	NA	3.6	97:3	3.3	NA	NA
12	9979-9986	1.885	-0.14	47:53	0	NA	NA	3.9	98:2	0.4	NA	NA
12	9708-9777	1.885	0.37	59:41	11.3	NA	NA	3.4	97:3	0.1	NA	NA
12	9722-9744	1.88	1.04	74:26	6.4	1.79	86:14	2.72	94:6	15.2	1.33	79:21

12	9712-9845	1.88	1.03	74:26	13.9	1.65	84:16	2.73	94:6	12.8	2.1	89:11
12	9589-9742	1.87	1.77	85:15	1.9	NA	NA	1.96	88:12	2.4	NA	NA
12	9716-9781	1.85	0.28	57:43	0	NA	NA	3.42	97:3	5.2	NA	NA
12	9692-9884	1.795	1.62	83:17	5.2	NA	NA	1.97	88:12	6.3	NA	NA
13	9042-9046	1.99	3.78	98:2	2.2	4.18	98:2	0.2	55:45	11.4	0.2	55:45

\* values were obtained from LCCA experiments conducted with L1:L2 DNA ratio of 1:3 and normalized to L1:L2 DNA ratio of 1:1

\*\* values were obtained from LCCA experiments conducted with L1:L2 DNA ratio of 1:9 and normalized to L1:L2 DNA ratio of 1:1

\*\*\* the "Unique identifier " consists of the unique identifiers for the two constituent LCCAs in either (Set#H1L1L2-Set#H2L2L1) or (Set#H2L2L1-Set#H1L1L2) orientation

Table 13b. Stability and antigen binding assessments of the designs that met the LCCA average performance criteria of correctly paired: mispaired Fab heterodimers of 86:14

Cluster	Unique identifier**	KD of h1l1 Fab heterodimer (nM)	Change in KD of h1l1 Fab heterodimer with respect to wild type $\{-\log(KD\_design) - \log(KD\_wt)\}$	KD of h2l2 Fab heterodimer (nM)	Change in KD of h2l2 Fab heterodimer with respect to wild type $\{-\log(KD\_design) - \log(KD\_wt)\}$	DSF values of h1l1 Fab heterodimer (°C)	DSF values of h2l2 Fab heterodimer (°C)
1	9134-9521	0.16	0	0.2	-0.1	80.3	ND
1	9123-9521	0.15	0.02	0.2	-0.1	79.6	ND
1	9150-9523	0.16	-0.01	0.2	-0.1	79.6	ND
1	9152-9515	0.16*	-0.01*	0.26	-0.21	79.60*	ND
1	9154-9394	0.16*	-0.01*	0.22	-0.15	79.60*	79.8
1	9164-9555	0.16*	-0.01*	0.24	-0.18	79.60*	80.3
1	9146-9553	0.16*	0.00*	0.24	-0.18	80.30*	80.3
1	9162-9425	0.16*	-0.01*	0.23	-0.16	79.60*	79.5
1	9164-9500	0.16*	-0.01*	0.24	-0.19	79.60*	79.8
1	9154-9353	0.16*	-0.01*	0.2	-0.1	79.60*	ND
1	9152-9460	0.16*	-0.01*	0.26	-0.23	79.60*	79.7
1	9160-9416	0.16*	-0.01*	0.2	-0.12	79.60*	79.5
1	9136-9513	0.16*	0.00*	0.26	-0.21	80.30*	ND
1	9136-9459	0.16*	0.00*	0.26	-0.23	80.30*	79.7
1	9144-9423	0.16*	0.00*	0.23	-0.16	80.30*	79.5
1	9158-9483	0.16*	-0.01*	0.18	-0.07	79.60*	79.8
1	9142-9414	0.16*	0.00*	0.2	-0.12	80.30*	79.5
1	9138-9392	0.16*	0.00*	0.22	-0.15	80.30*	79.8
1	9156-9397	0.16*	-0.01*	0.19	-0.08	79.60*	79.5
1	9140-9481	0.16*	0.00*	0.18	-0.07	80.30*	79.8
1	9131-9553	0.15*	0.02*	0.24	-0.18	79.60*	80.3
1	9164-9446	0.16*	-0.01*	0.28	-0.26	79.60*	80.1
1	9126-9392	0.15*	0.02*	0.22	-0.15	79.60*	79.8
1	9138-9352	0.16*	0.00*	0.2	-0.1	80.30*	ND
1	9127-9481	0.15*	0.02*	0.18	-0.07	79.60*	79.8
1	9130-9423	0.15*	0.02*	0.23	-0.16	79.60*	79.5
1	9158-9538	0.16*	-0.01*	0.17	-0.04	79.60*	ND
1	9150-9468	0.16	-0.01	0.18	-0.07	79.6	79.7
1	9125-9513	0.15*	0.02*	0.26	-0.21	79.60*	ND
1	9140-9536	0.16*	0.00*	0.17	-0.04	80.30*	ND
1	9126-9352	0.15*	0.02*	0.2	-0.1	79.60*	ND
1	9164-9367	0.16*	-0.01*	0.15	0.01	79.60*	79.7
1	9125-9459	0.15*	0.02*	0.26	-0.23	79.60*	79.7
1	9142-9357	0.16*	0.00*	0.18	-0.07	80.30*	ND
1	9129-9414	0.15*	0.02*	0.2	-0.12	79.60*	79.5
1	9162-9362	0.16*	-0.01*	0.16	-0.01	79.60*	ND
1	9127-9536	0.15*	0.02*	0.17	-0.04	79.60*	ND
1	9146-9366	0.16*	0.00*	0.15	0.01	80.30*	79.7
1	9160-9358	0.16*	-0.01*	0.18	-0.07	79.60*	ND
1	9146-9498	0.16*	0.00*	0.24	-0.19	80.30*	79.8
1	9156-9354	0.16*	-0.01*	0.17	-0.04	79.60*	ND
1	9134-9466	0.16	0	0.18	-0.07	80.3	79.7
1	9144-9361	0.16*	0.00*	0.16	-0.01	80.30*	ND
1	9123-9466	0.15	0.02	0.18	-0.07	79.6	79.7
1	9129-9357	0.15*	0.02*	0.18	-0.07	79.60*	ND
1	9131-9366	0.15*	0.02*	0.15	0.01	79.60*	79.7
1	9130-9361	0.15*	0.02*	0.16	-0.01	79.60*	ND
1	9131-9498	0.15*	0.02*	0.24	-0.19	79.60*	79.8
1	9146-9444	0.16*	0.00*	0.28	-0.26	80.30*	80.1
2	9279-9518	0.20*	-0.11*	0.2	-0.1	79.00*	ND
2	9286-9402	0.2	-0.11	0.2	-0.12	79	79.5
2	9287-9486	0.2	-0.11	0.23	-0.17	79	80
2	9283-9380	0.2	-0.11	0.22	-0.15	79	79.8

2	9273-9398	0.2	-0.12	0.2	-0.12	78.6	79.5
2	9252-9380	0.26	-0.21	0.22	-0.15	78.3	79.8
2	9323-9440	0.18*	-0.07*	0.28	-0.26	78.20*	80.1
2	9287-9541	0.2	-0.11	0.22	-0.15	79	79.7
2	9271-9376	0.2	-0.12	0.22	-0.15	78.6	79.8
2	9284-9471	0.2	-0.11	0.18	-0.07	79	79.8
2	9290-9432	0.2	-0.11	0.28	-0.26	79	80.1
2	9256-9432	0.26	-0.21	0.28	-0.26	78.3	80.1
2	9253-9471	0.26	-0.21	0.18	-0.07	78.3	79.8
2	9302-9406	0.21*	-0.12*	0.2	-0.12	78.20*	79.5
2	9287-9420	0.2	-0.11	0.23	-0.16	79	79.5
2	9308-9436	0.21*	-0.12*	0.28	-0.26	78.20*	80.1
2	9255-9402	0.26	-0.21	0.2	-0.12	78.3	79.5
2	9248-9398	0.28	-0.26	0.2	-0.12	78.1	79.5
2	9209-9398	ND	ND	0.2	-0.12	78.3	79.5
2	9281-9503	0.2	-0.11	0.26	-0.21	79	ND
2	9263-9436	0.24	-0.19	0.28	-0.26	ND	80.1
2	9275-9419	0.2	-0.12	0.23	-0.16	78.6	79.5
2	9212-9402	0.2	-0.11	0.2	-0.12	78.5	79.5
2	9211-9380	0.2	-0.11	0.22	-0.15	78.5	79.8
2	9270-9440	0.31	-0.29	0.28	-0.26	ND	80.1
2	9229-9440	0.16	-0.02	0.28	-0.26	ND	80.1
2	9250-9503	0.26	-0.21	0.26	-0.21	78.3	ND
2	9290-9546	0.2	-0.11	0.24	-0.18	79	80.3
2	9247-9376	0.28	-0.26	0.22	-0.15	78.1	79.8
2	9256-9546	0.26	-0.21	0.24	-0.18	78.3	80.3
2	9323-9495	0.18*	-0.07*	0.24	-0.19	78.20*	79.8
2	9213-9432	0.2	-0.11	0.28	-0.26	78.5	80.1
2	9262-9406	0.24	-0.19	0.2	-0.12	ND	79.5
2	9181-9406	0.22	-0.15	0.2	-0.12	ND	79.5
2	9208-9376	ND	ND	0.22	-0.15	78.3	79.8
2	9173-9380	0.25	-0.21	0.22	-0.15	78.5	79.8
2	9170-9376	0.27	-0.24	0.22	-0.15	77.8	79.8
2	9196-9516	0.28	-0.25	0.26	-0.21	76.4	ND
2	9319-9410	0.18*	-0.07*	0.2	-0.12	78.20*	79.5
2	9171-9398	0.27	-0.24	0.2	-0.12	77.8	79.5
2	9219-9406	0.19	-0.08	0.2	-0.12	ND	79.5
2	9174-9402	0.25	-0.21	0.2	-0.12	78.5	79.5
2	9198-9395	0.28	-0.25	0.22	-0.15	76.4	79.8
2	9175-9432	0.25	-0.21	0.28	-0.26	78.5	80.1
2	9236-9395	0.22	-0.15	0.22	-0.15	ND	79.8
2	9281-9449	0.2	-0.11	0.26	-0.23	79	79.7
2	9234-9516	0.22	-0.15	0.26	-0.21	ND	ND
2	9308-9547	0.21*	-0.12*	0.24	-0.18	78.20*	80.3
2	9304-9542	0.21*	-0.12*	0.22	-0.15	78.20*	79.7
2	9243-9556	0.22	-0.15	0.24	-0.18	ND	80.3
2	9250-9449	0.26	-0.21	0.26	-0.23	78.3	79.7
2	9213-9546	0.2	-0.11	0.24	-0.18	78.5	80.3
2	9269-9410	0.31	-0.29	0.2	-0.12	ND	79.5
2	9237-9484	0.22	-0.15	0.18	-0.07	ND	79.8
2	9270-9495	0.31	-0.29	0.24	-0.19	ND	79.8
2	9220-9436	0.19	-0.08	0.28	-0.26	ND	80.1
2	9229-9495	0.16	-0.02	0.24	-0.19	ND	79.8
2	9284-9526	0.2	-0.11	0.17	-0.04	79	ND
2	9279-9463	0.20*	-0.11*	0.18	-0.07	79.00*	79.7
2	9304-9487	0.21*	-0.12*	0.23	-0.17	78.20*	80
2	9323-9550	0.18*	-0.07*	0.24	-0.18	78.20*	80.3
2	9214-9505	0.19	-0.08	0.26	-0.21	ND	ND
2	9253-9526	0.26	-0.21	0.17	-0.04	78.3	ND
2	9263-9547	0.24	-0.19	0.24	-0.18	ND	80.3
2	9271-9350	0.2	-0.12	0.2	-0.1	78.6	ND
2	9316-9388	0.18*	-0.07*	0.22	-0.15	78.20*	79.8
2	9298-9384	0.21*	-0.12*	0.22	-0.15	78.20*	79.8

2	9243-9501	0.22	-0.15	0.24	-0.19	ND	79.8
2	9257-9505	0.24	-0.19	0.26	-0.21	ND	ND
2	9205-9556	0.28	-0.25	0.24	-0.18	76.4	80.3
2	9176-9505	0.22	-0.15	0.26	-0.21	ND	ND
2	9175-9546	0.25	-0.21	0.24	-0.18	78.5	80.3
2	9214-9451	0.19	-0.08	0.26	-0.23	ND	79.7
2	9199-9484	0.28	-0.25	0.18	-0.07	76.4	79.8
2	9240-9544	0.22	-0.15	0.22	-0.15	ND	79.7
2	9205-9501	0.28	-0.25	0.24	-0.19	76.4	79.8
2	9257-9451	0.24	-0.19	0.26	-0.23	ND	79.7
2	9243-9368	0.22	-0.15	0.15	0.01	ND	79.7
2	9176-9451	0.22	-0.15	0.26	-0.23	ND	79.7
2	9196-9461	0.28	-0.25	0.26	-0.23	76.4	79.7
2	9217-9473	0.19	-0.08	0.18	-0.07	ND	79.8
2	9320-9488	0.18*	-0.07*	0.23	-0.17	78.20*	80
2	9266-9388	0.31	-0.29	0.22	-0.15	ND	79.8
2	9202-9544	0.28	-0.25	0.22	-0.15	76.4	79.7
2	9205-9368	0.28	-0.25	0.15	0.01	76.4	79.7
2	9259-9384	0.24	-0.19	0.22	-0.15	ND	79.8
2	9290-9364	0.2	-0.11	0.15	0.01	79	79.7
2	9256-9364	0.26	-0.21	0.15	0.01	78.3	79.7
2	9270-9550	0.31	-0.29	0.24	-0.18	ND	80.3
2	9229-9550	0.16	-0.02	0.24	-0.18	ND	80.3
2	9247-9350	0.28	-0.26	0.2	-0.1	78.1	ND
2	9178-9384	0.22	-0.15	0.22	-0.15	ND	79.8
2	9225-9388	0.16	-0.02	0.22	-0.15	ND	79.8
2	9208-9350	ND	ND	0.2	-0.1	78.3	ND
2	9234-9461	0.22	-0.15	0.26	-0.23	ND	79.7
2	9220-9547	0.19	-0.08	0.24	-0.18	ND	80.3
2	9290-9491	0.2	-0.11	0.24	-0.19	79	79.8
2	9170-9350	0.27	-0.24	0.2	-0.1	77.8	ND
2	9256-9491	0.26	-0.21	0.24	-0.19	78.3	79.8
2	9275-9359	0.2	-0.12	0.16	-0.01	78.6	ND
2	9179-9473	0.22	-0.15	0.18	-0.07	ND	79.8
2	9240-9489	0.22	-0.15	0.23	-0.17	ND	80
2	9240-9426	0.22	-0.15	0.23	-0.16	ND	79.5
2	9228-9410	0.16	-0.02	0.2	-0.12	ND	79.5
2	9216-9384	0.19	-0.08	0.22	-0.15	ND	79.8
2	9298-9351	0.21*	-0.12*	0.2	-0.1	78.20*	ND
2	9213-9364	0.2	-0.11	0.15	0.01	78.5	79.7
2	9202-9489	0.28	-0.25	0.23	-0.17	76.4	80
2	9243-9447	0.22	-0.15	0.28	-0.26	ND	80.1
2	9202-9426	0.28	-0.25	0.23	-0.16	76.4	79.5
3	9338-9748	0.36	-0.36	0.24	-0.18	79.1	79.9
3	9372-9748	0.36	-0.36	0.27	-0.24	79.1	74.5
3	6054-9327	0.24	-0.19	0.24	-0.18	79.8	79.9
3	9338-9750	0.23	-0.16	0.24	-0.18	79.5	79.9
3	9334-9747	0.36	-0.36	0.2	-0.1	79.1	80.8
3	9121-9373	0.13	0.08	0.27	-0.24	79.5	74.5
3	9334-9749	0.23	-0.16	0.2	-0.1	79.5	80.8
3	9815-9825	0.16	-0.01	0.15	0.01	77.8	77.7
3	9815-9826	0.16	-0.01	0.06	0.43	77.8	78.3
3	9816-9825	0.19	-0.09	0.15	0.01	78.3	77.7
3	9372-9750	0.23	-0.16	0.27	-0.24	79.5	74.5
3	9816-9826	0.19	-0.09	0.06	0.43	78.3	78.3
3	9107-9339	0.16	-0.01	0.24	-0.18	79.8	79.9
3	9066-9335	0.17	-0.04	0.2	-0.1	81.2	80.8
3	6048-9326	0.24	-0.19	0.2	-0.1	79.8	80.8
3	9328-9332	0.24*	-0.19*	0.25	-0.2	79.80*	79.2
3	9122-9371	0.13	0.1	0.22	-0.14	80	81
3	9104-9336	0.16*	-0.01*	0.2	-0.1	81.40*	80.8
3	9108-9330	0.16*	-0.01*	0.25	-0.2	79.80*	79.2
3	9106-9337	0.16	-0.01	0.2	-0.1	79.8	80.8



3	9369-9747	0.36	-0.36	0.22	-0.14	79.1	81
3	9109-9332	0.16	-0.01	0.25	-0.2	79.9	79.2
4	9168-9342	ND	ND	0.34	-0.34	78.8	80.5
4	9169-9344	ND	ND	0.27	-0.23	78.8	ND
4	9114-9344	0.14	0.04	0.27	-0.23	79.1	ND
4	6098-9118	0.01	-0.28	0	0.34	81.20*	80.2
4	9113-9342	0.14	0.04	0.34	-0.34	79.1	80.5
4	9117-9374	0.17	-0.03	0.23	-0.16	80.8	80.3
4	9119-9375	0.17	-0.03	0.23	-0.16	81.2	80.3
4	9111-9347	0.13	0.09	0.23	-0.16	80.6	80.3
5	9116-9349	0.16	-0.02	0.15	0.03	79.9	ND
6	9075-9745	0.17	-0.03	ND	ND	78.1	81.4
6	9745-9905	ND	ND	0.1	0.2	81.4	76.8
6	9075-9746	0.17	-0.03	0.35	-0.35	78.1	80.5
6	9746-9905	0.35	-0.35	0.1	0.2	80.5	76.8
6	9814-9828	0.16	-0.01	0.14	0.07	79.2	78
6	9813-9828	0.18	-0.05	0.14	0.07	81.3	78
6	10547-10549	ND	ND	0.35	-0.35	ND	80.5
6	10545-10549	0.35	-0.35	ND	ND	80.5	ND
6	9814-9824	0.16	-0.01	0.15	0.03	79.2	79.7
6	10547-10551	ND	ND	ND	ND	ND	81.4
6	9813-9824	0.18	-0.05	0.15	0.03	81.3	79.7
6	10545-10551	ND	ND	ND	ND	81.4	ND
7	9060-9756	0.14	0.04	0.28	-0.26	81	80.4
7	9054-9060	0.14	0.05	0.14	0.04	80.7	81
7	9053-9058	0.14	0.05	0.12	0.12	80.7	80.8
7	9058-9755	0.12	0.12	0.28	-0.26	80.8	80.4
8	9820-9823	0.2	-0.1	0.24	-0.18	78.2	78.4
8	9819-9823	0.15	0.03	0.24	-0.18	79.3	78.4
8	9820-9822	0.2	-0.1	0.11	0.17	78.2	77.7
8	9819-9822	0.15	0.03	0.11	0.17	79.3	77.7
8	9820-9821	0.2	-0.1	0.07	0.38	78.2	78.3
8	9820-9827	0.2	-0.1	0.17	-0.03	78.2	79
8	9819-9821	0.15	0.03	0.07	0.38	79.3	78.3
8	9819-9827	0.15	0.03	0.17	-0.03	79.3	79
8	9817-9823	0.18	-0.05	0.24	-0.18	77.5	78.4
8	9817-9822	0.18	-0.05	0.11	0.17	77.5	77.7
8	9817-9821	0.18	-0.05	0.07	0.38	77.5	78.3
8	9817-9827	0.18	-0.05	0.17	-0.03	77.5	79
8	9818-9823	0.18	-0.07	0.24	-0.18	78.7	78.4
8	9818-9822	0.18	-0.07	0.11	0.17	78.7	77.7
8	9818-9821	0.18	-0.07	0.07	0.38	78.7	78.3
8	9818-9827	0.18	-0.07	0.17	-0.03	78.7	79
9	10548-10550	ND	ND	ND	ND	ND	79
9	10548-10552	ND	ND	0.29	-0.27	ND	80.3
9	10546-10550	ND	ND	ND	ND	ND	79
9	10546-10552	ND	ND	0.29	-0.27	ND	80.3
9	9077-9611	0.15	0.01	0.12	0.12	80.9	81.8
9	9065-9751	0.18	-0.05	ND	ND	76.3	79
9	9064-9751	0.17	-0.05	ND	ND	77.2	79
9	9065-9752	0.18	-0.05	0.29	-0.27	76.3	80.3
9	9078-9612	0.15	0.01	ND	ND	80.9	81.5
9	9076-9610	0.15	0.01	ND	ND	80.9	82.1
9	9064-9752	0.17	-0.05	0.29	-0.27	77.2	80.3
9	9074-9753	0.16	-0.01	ND	ND	82.5	80.5

9	9753-9760	ND	ND	0.32	-0.31	80.5	81.3
9	9074-9754	0.16	-0.01	0.3	-0.28	82.5	79.8
9	9754-9760	0.3	-0.28	0.32	-0.31	79.8	81.3
10	9095-9561	0.17	-0.04	0.21	-0.13	79.8	80.2
10	9094-9559	0.17	-0.04	0.27	-0.24	79.8	80.6
10	9099-9564	0.19	-0.09	ND	ND	81.3	79.3
10	9096-9564	0.17	-0.04	ND	ND	79.8	79.3
10	9091-9560	0.16	-0.02	0.21	-0.13	79.9	80.2
10	9090-9558	0.16	-0.02	0.27	-0.24	79.9	80.6
10	9092-9562	0.16	-0.02	ND	ND	79.9	79.3
10	9098-9562	0.17	-0.03	ND	ND	80.6	79.3
10	9092-9571	0.16	-0.02	0.26	-0.21	79.9	81
10	9098-9571	0.17	-0.03	0.26	-0.21	80.6	81
10	9099-9572	0.19	-0.09	0.26	-0.21	81.3	81
10	9096-9572	0.17	-0.04	0.26	-0.21	79.8	81
11	9667-9830	0.27	-0.23	0.06	0.41	80.4	79.5
11	9617-9853	ND	ND	0.06	0.46	80.30*	80.8
11	9682-9740	0.27	-0.23	0.2	-0.09	80.4	80.5
11	9675-9852	0.27	-0.23	0.15	0.02	80.4	79.6
11	9671-9810	0.27	-0.23	0.14	0.04	80.4	80.7
11	9617-9891	ND	ND	0.07	0.36	80.30*	80.8
11	9667-9802	0.27	-0.23	0.11	0.16	80.4	80.4
11	9660-9858	0.19	-0.08	0.06	0.46	80.5	80.8
11	9660-9896	0.19	-0.08	0.07	0.36	80.5	80.8
11	9629-9858	0.12*	0.12*	0.06	0.46	80.60*	80.8
11	9667-9758	0.27	-0.23	0.29	-0.27	80.4	80.3
11	9629-9896	0.12*	0.12*	0.07	0.36	80.60*	80.8
11	9675-9812	0.27	-0.23	0.16	-0.01	80.4	80.8
11	9671-9784	0.27	-0.23	0.14	0.05	80.4	80.5
11	9679-9898	0.27	-0.23	0.07	0.36	80.4	80.8
11	9667-9868	0.27	-0.23	0.14	0.06	80.4	79.8
11	9663-9838	0.27*	-0.23*	0.13	0.09	80.40*	80.5
11	9675-9890	0.27	-0.23	0.05	0.49	80.4	79.8
11	9671-9888	0.27	-0.23	0.14	0.06	80.4	79.9
11	9617-9787	ND	ND	0.11	0.16	80.30*	81.8
11	9679-9794	0.27	-0.23	0.11	0.16	80.4	81.8
11	9654-9893	0.15	0.02	0.07	0.36	80.4	80.8
11	9671-9850	0.27	-0.23	0.15	0.01	80.4	79.8
11	9675-9786	0.27	-0.23	0.13	0.1	80.4	81
11	9660-9792	0.19	-0.08	0.11	0.16	80.5	81.8
11	9648-9853	0.14	0.05	0.06	0.46	79.9	80.8
11	9666-9731	0.27*	-0.23*	0.28	-0.26	80.40*	81.5
11	9049-9759	0.16	-0.01	0.32	-0.31	79	81.3
11	9629-9792	0.12*	0.12*	0.11	0.16	80.60*	81.8
11	9623-9893	0.06*	0.39*	0.07	0.36	80.40*	80.8
11	9632-9838	0.14	0.04	0.13	0.09	81	80.5
11	9654-9855	0.15	0.02	0.06	0.46	80.4	80.8
11	9679-9860	0.27	-0.23	0.06	0.46	80.4	80.8
11	9645-9761	0.14*	0.05*	0.32	-0.31	79.90*	81.3
11	9648-9891	0.14	0.05	0.07	0.36	79.9	80.8
11	9626-9836	0.12	0.12	0.13	0.09	80.6	80.5
11	9579-9797	0.28*	-0.25*	0.11	0.16	80.00*	81.8
11	9579-9901	0.28*	-0.25*	0.07	0.36	80.00*	80.8
11	9635-9898	0.14*	0.04*	0.07	0.36	81.00*	80.8
11	9579-9863	0.28*	-0.25*	0.06	0.46	80.00*	80.8
11	9683-9841	0.30*	-0.28*	0.13	0.09	79.60*	80.5
11	9623-9855	0.06*	0.39*	0.06	0.46	80.40*	80.8
11	9575-9841	0.28	-0.25	0.13	0.09	80	80.5
11	9635-9794	0.14*	0.04*	0.11	0.16	81.00*	81.8
11	9606-9893	ND	ND	0.07	0.36	79.80*	80.8
11	9614-9761	ND	ND	0.32	-0.31	80.3	81.3
11	9663-9769	0.27*	-0.23*	0.32	-0.31	80.40*	81.3
11	9654-9789	0.15	0.02	0.11	0.16	80.4	81.8

11	9626-9767	0.12	0.12	0.32	-0.31	80.6	81.3
11	9648-9787	0.14	0.05	0.11	0.16	79.9	81.8
11	9657-9836	0.19*	-0.08*	0.13	0.09*	80.50*	80.5
11	9606-9855	ND	ND	0.06	0.46	79.80*	80.8
11	9623-9789	0.06*	0.39*	0.11	0.16	80.40*	81.8
11	9635-9860	0.14*	0.04*	0.06	0.46	81.00*	80.8
11	9632-9769	0.14	0.04	0.32	-0.31	81	81.3
11	9641-9797	0.11*	0.17*	0.11	0.16	80.10*	81.8
11	9641-9901	0.11*	0.17*	0.07	0.36	80.10*	80.8
11	9663-9876	0.27*	-0.23*	0.05	0.51	80.40*	80.4
11	9641-9863	0.11*	0.17*	0.06	0.46	80.10*	80.8
11	9626-9874	0.12	0.12	0.05	0.51	80.6	80.4
11	9657-9767	0.19*	-0.08*	0.32	-0.31	80.50*	81.3
11	9684-9797	0.3	-0.28	0.11	0.16	79.6	81.8
12	9587-9735	0.28	-0.25	0.2	-0.09	80.8	80.5
12	9687-9737	ND	ND	0.2	-0.09	81.3	80.5
12	9696-9782	0.34	-0.34	0.08	0.28	81.6	82.2
12	9696-9848	0.34	-0.34	0.15	0.03	81.6	81.3
12	9594-9829	ND	ND	0.06	0.41	79.80*	79.5
12	9692-9846	0.34	-0.34	0.13	0.09	81.6	82.7
12	9696-9886	0.34	-0.34	0.18	-0.06	81.6	81.4
12	9696-9808	0.34	-0.34	0.17	-0.02	81.6	81.8
12	9609-9737	ND	ND	0.2	-0.09	79.80*	80.5
12	9978-9986	ND	ND	0.14	0.05	79.80*	80
12	9692-9806	0.34	-0.34	0.13	0.07	81.6	82.6
12	9688-9844	0.34	-0.34	0.17	-0.03	81.6	82.3
12	9688-9804	0.34	-0.34	0.11	0.14	81.6	82.2
12	9602-9889	ND	ND	0.05	0.49	79.80*	79.8
12	9602-9785	ND	ND	0.13	0.1	79.80*	81
12	9574-9702	0.27	-0.23	0.34	-0.34	80.8	81.6
12	9602-9811	ND	ND	0.16	-0.01	79.80*	80.8
12	9692-9780	0.34	-0.34	0.16	-0.01	81.6	83
12	9594-9757	ND	ND	0.29	-0.27	79.80*	80.3
12	9705-9735	0.21	-0.12	0.2	-0.09	81.6	80.5
12	9103-9700	0.15	0.02	0.34	-0.34	80	81.6
12	9598-9849	ND	ND	0.15	0.01	79.80*	79.8
12	9720-9733	0.24	-0.19	0.28	-0.25	80.8	81.3
12	9688-9778	0.34	-0.34	0.12	0.13	81.6	79.7
12	9598-9809	ND	ND	0.14	0.04	79.80*	80.7
12	9982-9987	0.11	0.15	0.14	0.05	80.5	80
12	9101-9700	0.12	0.1	0.34	-0.34	81	81.6
12	9716-9807	0.24	-0.19	0.17	-0.02	80.8	81.8
12	9703-9734	0.21*	-0.12*	0.26	-0.22	81.60*	77.7
12	9712-9779	0.24	-0.19	0.16	-0.01	80.8	83
12	9594-9801	ND	ND	0.11	0.16	79.80*	80.4
12	9712-9805	0.24	-0.19	0.13	0.07	80.8	82.6
12	9602-9851	ND	ND	0.15	0.02	79.80*	79.6
12	9716-9847	0.24	-0.19	0.15	0.03	80.8	81.3
12	9979-9986	ND	ND	0.14	0.05	79.80*	79.5
12	9708-9777	0.24	-0.19	0.12	0.13	80.8	79.7
12	9722-9744	0.24	-0.19	0.28	-0.25	80.8	80
12	9712-9845	0.24	-0.19	0.13	0.09	80.8	82.7
12	9589-9742	0.28	-0.25	0.25	-0.21	80.8	80.8
12	9716-9781	0.24	-0.19	0.08	0.28	80.8	82.2
12	9692-9884	0.34	-0.34	ND	ND	81.6	82.3
13	9042-9046	0.18	ND	0.14	0	78.3	81

\* Indicates estimated values that were derived from other Fab heterodimers that differ only in the presence/absence of the attached L chain tag (HA or FLAG).

\*\* the "Unique identifier" consists of the unique identifiers for the two constituent LCCAs in either (Set#H1L1L2 -Set#H2L2L1) or (Set#H2L2L1 -Set#H1L1L2) orientation

Table 14a. LCCA performance of the designs that performed below the LCCA average performance criteria of correctly paired: mispaired Fab heterodimers of 86:14

Related Clusters	Unique identifier ***	lcca average performance (i.e. $0.5(\ln(r1/f1) + \ln(r2/f2))$ )	H1L1:H1L2 normalized median scalar value $\ln(r1/f1)$ *	H1L1:H1L2 normalized median ratio*	H1L1:H1L2 range of normalized ratios*	H1L1:H1L2 normalized median scalar value $\ln(r1/f1)$ **	H1L1:H1L2 normalized median ratio**	H2L2:H2L1 normalized median scalar value $\ln(r2/f2)$ *	H2L2:H2L1 normalized median ratio*	H2L2:H2L1 range of normalized ratios*	H2L2:H2L1 normalized median scalar value $\ln(r2/f2)$ **	H2L2:H2L1 normalized median ratio**
1	9131-9444	1.705	2.7	94:6	3.7	NA	NA	0.72	67:33	66.2	NA	NA
11	9645-9831	1.785	2	88:12	4	NA	NA	1.57	83:17	0	NA	NA
11	9684-9901	1.785	0.41	60:40	3.1	NA	NA	3.16	96:4	1	NA	NA
11	9651-9763	1.77	1.65	84:16	24.7	NA	NA	1.9	87:13	2.4	NA	NA
11	9684-9863	1.755	0.41	60:40	3.1	NA	NA	3.1	96:4	3.9	NA	NA
11	9645-9869	1.755	2	88:12	4	NA	NA	1.51	82:18	7.5	NA	NA
11	9688-9882	1.715	1.19	77:23	0.6	NA	NA	2.24	90:10	3.2	NA	NA
11	9683-9773	1.715	2.14	89:11	6.5	NA	NA	1.29	78:22	5	NA	NA
11	9575-9773	1.695	2.1	89:11	1.4	NA	NA	1.29	78:22	5	NA	NA
11	9638-9841	1.695	1.13	76:24	16.7	NA	NA	2.27	91:9	2	NA	NA
11	9632-9876	1.69	1.9	87:13	14.8	1.55	82:18	1.48	81:19	17.1	1.85	86:14
11	9614-9831	1.675	1.78	86:14	6.2	NA	NA	1.57	83:17	0	NA	NA
11	9588-9741	1.665	1.75	85:15	0	NA	NA	1.58	83:17	0.1	NA	NA
11	9594-9867	1.655	0.37	59:41	22.4	NA	NA	2.94	95:5	2.1	NA	NA
11	9614-9869	1.645	1.78	86:14	6.2	NA	NA	1.51	82:18	7.5	NA	NA
11	9657-9874	1.62	1.62	83:17	33.4	NA	NA	1.62	83:17	6.3	NA	NA
11	9620-9833	1.58	1.68	84:16	10.3	NA	NA	1.48	81:19	0	NA	NA
11	9651-9833	1.56	1.65	84:16	24.7	NA	NA	1.48	81:19	0	NA	NA
11	9620-9871	1.545	1.68	84:16	10.3	NA	NA	1.41	80:20	0	NA	NA
11	9683-9879	1.535	2.14	89:11	6.5	NA	NA	0.93	72:28	5.7	NA	NA
11	9651-9871	1.525	1.65	84:16	24.7	NA	NA	1.41	80:20	0	NA	NA
11	9575-9879	1.515	2.1	89:11	1.4	NA	NA	0.93	72:28	5.7	NA	NA
11	9590-9833	1.22	0.96	72:28	6.7	NA	NA	1.48	81:19	0	NA	NA
11	9638-9773	1.205	1.13	76:24	16.7	NA	NA	1.29	78:22	5	NA	NA
11	9590-9871	1.185	0.96	72:28	6.7	NA	NA	1.41	80:20	0	NA	NA
11	9638-9879	1.025	1.13	76:24	16.7	NA	NA	0.93	72:28	5.7	NA	NA

11, 12	9708-9803	1.75	0.37	59:41	11.3	NA	NA	3.13	96:4	0.6	NA	NA
11, 12	9598-9887	1.745	0.36	59:41	26	NA	NA	3.13	96:4	1.1	NA	NA
11, 12	9708-9843	1.725	0.37	59:41	11.3	NA	NA	3.08	96:4	1.5	NA	NA
11, 12	9716-9885	1.575	0.28	57:43	0	NA	NA	2.87	95:5	2.3	NA	NA
11, 12	9712-9883	1.535	1.03	74:26	13.9	NA	NA	2.04	88:12	2.5	NA	NA
11, 12	9708-9881	1.305	0.37	59:41	11.3	NA	NA	2.24	90:10	0.9	NA	NA
11, 12, 13	9980-9986	1.74	-0.14	47:53	0	NA	NA	3.63	97:3	0.1	NA	NA
11, 12, 13	9984-9987	1.73	-0.16	46:54	0	NA	NA	3.62	97:3	0.5	NA	NA
11, 12, 13	9983-9987	1.675	-0.16	46:54	0	NA	NA	3.51	97:3	0.2	NA	NA
11, 12, 13	9981-9986	1.58	-0.14	47:53	0	NA	NA	3.3	96:4	1.7	NA	NA
11, 12, 13	9585-9734	1.52	0.71	67:33	2	NA	NA	2.34	91:9	4.7	NA	NA
11, 12, 13	9985-9987	1.35	-0.16	46:54	0	NA	NA	2.86	95:5	2.3	NA	NA
12	9573-9725	1.68	3.13	96:4	0.8	NA	NA	0.23	56:44	7.5	NA	NA
12	9721-9737	1.615	0.03	51:49	7.5	NA	NA	3.2	96:4	10	NA	NA
12	9704-9732	1.61	1.06	74:26	0.1	NA	NA	2.17	90:10	5.7	NA	NA
12	9102-9723	1.48	2.54	93:7	1.5	NA	NA	0.42	60:40	10.2	NA	NA
12	9100-9723	1.47	2.52	93:7	1.2	NA	NA	0.42	60:40	10.2	NA	NA
12	9706-9743	1.33	0.82	69:31	0.2	NA	NA	1.84	86:14	1.4	NA	NA
13	9043-9047	1.305	3.12	96:4	0.1	NA	NA	-0.51	38:62	5.2	NA	NA
13	9044-9048	1.19	1.84	86:14	6	1.24	78:22	0.54	63:37	9.3	1.33	79:21
13	6665-6666	1.12	0.4	60:40	2.6	NA	NA	1.85	86:14	4	NA	NA
13	9041-9045	1.005	1.37	80:20	3.2	1.39	80:20	0.64	65:35	4.8	0.07	52:48
13	5933-5957	0.685	0.48	62:38	2.1	NA	NA	0.88	71:29	4.4	NA	NA
13	9052-9917	0.685	1.03	74:26	36.9	2.05	89:11	0.34	58:42	21.2	0.5	62:38
13	9906-9911	0.66	-1.25	22:78	6.3	NA	NA	2.55	93:7	1.5	NA	NA
13	9070-9909	0.58	0.72	67:33	3.3	NA	NA	0.44	61:39	0	NA	NA
13	9068-9907	0.53	0.54	63:37	9.5	NA	NA	0.52	63:37	0	NA	NA
13	9068-9914	0.49	0.54	63:37	9.5	0.45	61:39	0.44	61:39	13.2	0.94	72:28
13	9073-9909	0.49	0.54	63:37	1.9	NA	NA	0.44	61:39	0	NA	NA
13	5995-5998	0.415	0.88	71:29	5	NA	NA	-0.05	49:51	11.6	NA	NA
13	6163-6164	0.395	1.09	75:25	7.4	NA	NA	-0.3	43:57	18.5	NA	NA
13	9071-9907	0.385	0.25	56:44	14	NA	NA	0.52	63:37	0	NA	NA

13	5997-5998	0.375	0.88	71:29	5	NA	NA	-0.13	47:53	9.1	NA	NA
13	9071-9914	0.345	0.25	56:44	14	1.73	85:15	0.44	61:39	13.2	0.94	72:28
13	6042-6043	0.105	-0.44	39:61	6.8	NA	NA	0.66	66:34	5.3	NA	NA
13	6036-6037	-0.005	-0.38	41:59	0.8	NA	NA	0.37	59:41	0.1	NA	NA
13	6037-9566	-0.065	-0.38	41:59	0.8	NA	NA	0.24	56:44	3.6	NA	NA
13	6017-6024	-0.065	-0.01	50:50	0.9	NA	NA	-0.14	47:53	7.1	NA	NA
2	9213-9491	1.75	2.65	93:7	0.7	NA	NA	0.86	70:30	58.7	NA	NA
2	9205-9447	1.74	1.78	86:14	5.5	NA	NA	1.7	85:15	23.8	NA	NA
2	9175-9364	1.725	2.44	92:8	2.4	NA	NA	1.02	73:27	0	NA	NA
2	9259-9351	1.65	1.67	84:16	2.5	NA	NA	1.64	84:16	0	NA	NA
2	9175-9491	1.645	2.44	92:8	2.4	NA	NA	0.86	70:30	58.7	NA	NA
2	9308-9492	1.62	2.08	89:11	3	NA	NA	1.16	76:24	62.6	NA	NA
2	9178-9351	1.615	1.59	83:17	0	NA	NA	1.64	84:16	0	NA	NA
2	9260-9473	1.57	0.55	63:37	0	NA	NA	2.59	93:7	0	NA	NA
2	9239-9417	1.555	2.11	89:11	2.4	NA	NA	1	73:27	49.1	NA	NA
2	9263-9492	1.55	1.95	88:12	3.3	NA	NA	1.16	76:24	62.6	NA	NA
2	9300-9473	1.54	0.49	62:38	0	NA	NA	2.59	93:7	0	NA	NA
2	9216-9351	1.475	1.31	79:21	0	NA	NA	1.64	84:16	0	NA	NA
2	9201-9417	1.365	1.73	85:15	1.8	NA	NA	1	73:27	49.1	NA	NA
2	9220-9492	1.295	1.44	81:19	7.6	NA	NA	1.16	76:24	62.6	NA	NA
3	9369-9749	1.75	1.86	87:13	7.1	NA	NA	1.64	84:16	56.1	NA	NA
3	9120-9370	1.305	0.12	53:47	17.4	NA	NA	2.49	92:8	0.5	NA	NA
4	9112-9346	1.015	-0.97	27:73	0	NA	NA	3	95:5	1.9	NA	NA
5	2950-2951	0.57	0.47	62:38	4.4	NA	NA	0.68	66:34	8.7	NA	NA
5	9051-9063	0.2	0.03	51:49	3.9	0.42	60:40	0.37	59:41	6.1	0.22	55:45
5	9056-9062	-0.06	-0.77	32:68	6.8	0.94	72:28	0.65	66:34	7	1.12	75:25
5	6112-6113	-0.67	-1.92	13:87	9.2	NA	NA	0.58	64:36	1.4	NA	NA
6	9082-9862	1.78	-0.34	42:58	22.9	1.1	75:25	3.9	98:2	8.1	2.53	93:7
6	9082-9900	1.43	-0.34	42:58	22.9	NA	NA	3.2	96:4	2.7	NA	NA
6	6137-6138	1.32	0.23	56:44	5.7	NA	NA	2.4	92:8	6.5	NA	NA
6	6135-6136	0.965	0.07	52:48	2.2	NA	NA	1.87	87:13	0.3	NA	NA
6, 11, 13	9082-9796	1.685	-0.34	42:58	22.9	1.1	75:25	3.71	98:2	10.8	2.03	88:12

9	9590-9763	1.43	0.96	72:28	6.7	NA	NA	1.9	87:13	2.4	NA	NA
9, 11	9620-9763	1.79	1.68	84:16	10.3	1.97	88:12	1.9	87:13	2.4	1.96	88:12
9, 11	9606-9789	1.78	0.38	59:41	14.3	NA	NA	3.17	96:4	1.1	NA	NA
9, 11, 12	9598-9783	1.715	0.36	59:41	26	NA	NA	3.07	96:4	1.4	NA	NA

\* values were obtained from LCCA experiments conducted with L1:L2 DNA ratio of 1:3 and normalized to L1:L2 DNA ratio of 1:1

\*\* values were obtained from LCCA experiments conducted with L1:L2 DNA ratio of 1:9 and normalized to L1:L2 DNA ratio of 1:1

\*\*\* the "Unique identifier" consists of the unique identifiers for the two constituent LCCAs in either (Set#H1L1L2 -Set#H2L2L1) or (Set#H2L2L1-Set#H1L1L2) orientation

Table 44b. Stability and antigen binding assessments of the designs that performed below the i.CCA average performance criteria of correctly paired: mispaired Fab heterodimers of 86.14

Related Clusters	Unique identifier **	KD of h111 Fab heterodimer {nM}	Change in KD of h111 Fab heterodimer with respect to wild type (-log(KD_design) - log(KD_wt))	KD of h212 Fab heterodimer {nM}	Change in KD of h212 Fab heterodimer with respect to wild type (-log(KD_design) - log(KD_wt))	DSF values of h111 Fab heterodimer (°C)	DSF values of h212 Fab heterodimer (°C)
11	9131-9444	0.15*	0.02*	0.28	-0.26	79.60*	80.1
11	9645-9831	0.14*	0.05*	0.13	0.09	79.90*	80.5
11	9684-9901	0.3	-0.28	0.07	0.36	79.6	80.8
11	9651-9763	0.15*	0.02*	0.32	-0.31	80.40*	81.3
11	9684-9863	0.3	-0.28	0.06	0.46	79.6	80.8
11	9645-9869	0.14*	0.05*	0.05	0.51	79.90*	80.4
11	9688-9882	0.34	-0.34	0.11	0.15	81.6	81.8
11	9683-9773	0.30*	-0.28*	0.32	-0.31	79.60*	81.3
11	9575-9773	0.28	-0.25	0.32	-0.31	80	81.3
11	9638-9841	0.11	0.17	0.13	0.09	80.1	80.5
11	9632-9876	0.14	0.04	0.05	0.51	81	80.4
11	9614-9831	ND	ND	0.13	0.09	80.3	80.5
11	9588-9741	0.28	-0.25	0.07	0.34	80.8	81.1
11	9594-9867	ND	ND	0.14	0.06	79.80*	79.8
11	9614-9869	ND	ND	0.05	0.51	80.3	80.4
11	9657-9874	0.19*	-0.08*	0.05	0.51	80.50*	80.4
11	9620-9833	0.06	0.39	0.13	0.09	80.4	80.5
11	9651-9833	0.15*	0.02*	0.13	0.09	80.40*	80.5
11	9620-9871	0.06	0.39	0.05	0.51	80.4	80.4
11	9683-9879	0.30*	-0.28*	0.05	0.51	79.60*	80.4
11	9651-9871	0.15*	0.02*	0.05	0.51	80.40*	80.4
11	9575-9879	0.28	-0.25	0.05	0.51	80	80.4
11	9590-9833	ND	ND	0.13	0.09	79.8	80.5
11	9638-9773	0.11	0.17	0.32	-0.31	80.1	81.3
11	9590-9871	ND	ND	0.05	0.51	79.8	80.4
11	9638-9879	0.11	0.17	0.05	0.51	80.1	80.4
11, 12	9708-9803	0.24	-0.19	0.11	0.14	80.8	82.2
11, 12	9598-9887	ND	ND	0.14	0.06	79.80*	79.9
11, 12	9708-9843	0.24	-0.19	0.17	-0.03	80.8	82.3
11, 12	9716-9885	0.24	-0.19	0.18	-0.06	80.8	81.4
11, 12	9712-9883	0.24	-0.19	ND	ND	80.8	82.3
11, 12	9708-9881	0.24	-0.19	0.11	0.15	80.8	81.8
11, 12, 13	9980-9986	ND	ND	0.16	0	79.80*	79.8



11, 12, 13	9984-9987	0.11		0.15	0.16	0	80.5	79.8
11, 12, 13	9983-9987	0.11		0.15	0.14	0.05	80.5	79.5
11, 12, 13	9981-9986	ND		ND	0.12	0.1	79.80*	79.8
11, 12, 13	9585-9734	0.28*		-0.25*	0.26	-0.22	80.80*	77.7
11, 12, 13	9985-9987	0.11		0.15	0.12	0.1	80.5	79.8
12	9573-9725	0.27		-0.23	0.24	-0.19	80.8	80.8
12	9721-9737	0.24		-0.19	0.2	-0.09	80.8	80.5
12	9704-9732	0.21		-0.12	0.28	-0.25	81.6	81.3
12	9102-9723	0.15		0.02	0.24	-0.19	80	80.8
12	9100-9723	0.12		0.1	0.24	-0.19	81	80.8
12	9706-9743	0.21		-0.12	0.28	-0.25	81.6	80
13	9043-9047	0.16		ND	0.14	0	74.1	81
13	9044-9048	0.18		ND	0.14	0	75.8	81
13	6665-6666	0.16		-0.01	0.17	-0.04	80.9	80
13	9041-9045	0.14		ND	0.14	0	77.8	81
13	5933-5957	0.15		0.03	0.14	0	80.8	81
13	9052-9917	0.14		0.06	0.1	0.2	81.3	80.2
13	9906-9911	0.11		0.14	0.09	0.27	82.5	81
13	9070-9909	0.16		0	0.09	0.27	82.5	81
13	9068-9907	0.13		0.07	0.09	0.27	82.5	81
13	9068-9914	0.13		0.07	0.15	0.01	82.5	82
13	9073-9909	0.14		0.04	0.09	0.27	82.3	81
13	5995-5998	0.14		0.06	0.14	0.04	81.4	80.2
13	6163-6164	0.15		0.02	0.17	-0.04	82.5	80.8
13	9071-9907	0.21		-0.12	0.09	0.27	81.5	81
13	5997-5998	0.14		0.06	0.08	0.29	81.4	80
13	9071-9914	0.21		-0.12	0.15	0.01	81.5	82
13	6042-6043	0.13		0.07	0.11	0.14	80.1	82.1
13	6036-6037	0.13		0.07	0.17	-0.03	80.1	81.4
13	6037-9566	0.13		0.07	0.25	-0.21	80.1	81.8
13	6017-6024	0.15*		0.02*	0.14	0.06	82.50*	81.6
2	9213-9491	0.2		-0.11	0.24	-0.19	78.5	79.8
2	9205-9447	0.28		-0.25	0.28	-0.26	76.4	80.1
2	9175-9364	0.25		-0.21	0.15	0.01	78.5	79.7
2	9259-9351	0.24		-0.19	0.2	-0.1	ND	ND
2	9175-9491	0.25		-0.21	0.24	-0.19	78.5	79.8
2	9308-9492	0.21*		-0.12*	0.24	-0.19	78.20*	79.8
2	9178-9351	0.22		-0.15	0.2	-0.1	ND	ND
2	9260-9473	0.24		-0.19	0.18	-0.07	ND	79.8
2	9259-9417	0.22		-0.15	0.2	-0.12	ND	79.5
2	9263-9492	0.24		-0.19	0.24	-0.19	ND	79.8
2	9300-9473	0.21*		-0.12*	0.18	-0.07	78.20*	79.8

2	9216-9351	0.19	-0.08	0.2	-0.1	ND	ND
2	9201-9417	0.28	-0.25	0.2	-0.12	76.4	79.5
2	9220-9492	0.19	-0.08	0.24	-0.19	ND	79.8
3	9369-9749	0.23	-0.16	0.22	-0.14	79.5	81
3	9120-9370	0.13	0.08	0.22	-0.14	79.5	81
4	9112-9346	ND	ND	0.2	-0.11	74.8	81.6
5	2950-2951	0.13	0.1	0.13	0.08	80.5	80.8
5	9051-9063	0.14	0.06	0.17	-0.02	81.3	81.3
5	9056-9062	0.16	-0.02	0.17	-0.02	81.5	81.3
5	6112-6113	0.13*	0.10*	0.12	0.11	80.50*	83.1
6	9082-9862	0.16	-0.01	0.06	0.46	80.9	80.8
6	9082-9900	0.16	-0.01	0.07	0.36	80.9	80.8
6	6137-6138	0.16	-0.01	0.16	0	80.9	80
6	6135-6136	0.16	-0.01	0.13	0.07	80.9	80.3
6, 11, 13	9082-9796	0.16	-0.01	0.11	0.16	80.9	81.8
9	9590-9763	ND	ND	0.32	-0.31	79.8	81.3
9, 11	9620-9763	0.06	0.39	0.32	-0.31	80.4	81.3
9, 11	9606-9789	ND	ND	0.11	0.16	79.80*	81.8
9, 11, 12	9598-9783	ND	ND	0.14	0.05	79.80*	80.5

\* Indicates estimated values that were derived from other Fab heterodimers that differ only in the presence/absence of the attached L chain tag (HA or FLAG)).

\*\* the "Unique identifier" consists of the unique identifiers for the two constituent LCCAs in either (Set#H1L1L2 -Set#H2L2L1) or (Set#H2L2L1 -Set#H1L1L2) orientation

Table 15. Cluster 1 designs including the representative design

Unique Identifier	H1_mutation*	L1_mutation*	H2_mutation*	L2_mutation*
9134-9521**	L124E_K145T_Q179E	S131K_V133G_S176R	L124R_S186R	V133G_S176D_T178D
9125-9459	L124E_K145M_Q179E	S131K_V133G_S176R	L124R_S186K	Q124E_V133G_S176D_T178D_T180E
9126-9352	L124E_K145M_Q179E	S131K_V133G_S176R	L124R_D146N_Q179K	Q124E_V133G_S176D_T178E_T180E
9129-9357	L124E_K145M_Q179E	S131K_V133G_S176R	L124R_D146N_Q179K	V133G_S176D_T178E
9130-9361	L124E_K145M_Q179E	S131K_V133G_S176R	L124R_D146N_Q179K	V133G_S176D_T178E_T180E
9131-9366	L124E_K145M_Q179E	S131K_V133G_S176R	L124R_D146N_Q179K	V133G_S176D_T180E
9140-9481	L124E_K145T_Q179E	S131K_V133G_S176R	L124R_S186K	V133G_S176D_T178D_T180E
9146-9498	L124E_K145T_Q179E	S131K_V133G_S176R	L124R_S186K	V133G_S176D_T180E
9134-9466	L124E_K145T_Q179E	S131K_V133G_S176R	L124R_S186K	V133G_S176D_T178D
9136-9459	L124E_K145T_Q179E	S131K_V133G_S176R	L124R_S186K	Q124E_V133G_S176D_T178D_T180E
9159-9483	L124E_K145T_Q179E	S131R_V133G_S176R	L124R_S186K	V133G_S176D_T178D_T180E
9164-9500	L124E_K145T_Q179E	S131R_V133G_S176R	L124R_S186K	V133G_S176D_T180E
9150-9468	L124E_K145T_Q179E	S131R_V133G_S176R	L124R_S186K	V133G_S176D_T178D
9152-9460	L124E_K145T_Q179E	S131R_V133G_S176R	L124R_S186K	Q124E_V133G_S176D_T178D_T180E

9140-9536	L124E_K145T_Q179E	S131K_V133G_S176R	L124R_S186R	V133G_S176D_T178D_T180E
9146-9553	L124E_K145T_Q179E	S131K_V133G_S176R	L124R_S186R	V133G_S176D_T180E
9136-9513	L124E_K145T_Q179E	S131K_V133G_S176R	L124R_S186R	Q124E_V133G_S176D_T178D_T180E
9158-9538	L124E_K145T_Q179E	S131R_V133G_S176R	L124R_S186R	V133G_S176D_T178D_T180E
9164-9555	L124E_K145T_Q179E	S131R_V133G_S176R	L124R_S186R	V133G_S176D_T180E
9150-9523	L124E_K145T_Q179E	S131R_V133G_S176R	L124R_S186R	V133G_S176D_T178D
9152-9515	L124E_K145T_Q179E	S131R_V133G_S176R	L124R_S186R	Q124E_V133G_S176D_T178D_T180E
9127-9481	L124E_K145M_Q179E	S131K_V133G_S176R	L124R_S186K	V133G_S176D_T178D_T180E
9131-9498	L124E_K145M_Q179E	S131K_V133G_S176R	L124R_S186K	V133G_S176D_T180E
9123-9466	L124E_K145M_Q179E	S131K_V133G_S176R	L124R_S186K	V133G_S176D_T178D
9127-9536	L124E_K145M_Q179E	S131K_V133G_S176R	L124R_S186R	V133G_S176D_T178D_T180E
9131-9553	L124E_K145M_Q179E	S131K_V133G_S176R	L124R_S186R	V133G_S176D_T180E
9123-9521	L124E_K145M_Q179E	S131K_V133G_S176R	L124R_S186R	V133G_S176D_T178D
9125-9513	L124E_K145M_Q179E	S131K_V133G_S176R	L124R_S186R	Q124E_V133G_S176D_T178D_T180E
9142-9414	L124E_K145T_Q179E	S131K_V133G_S176R	L124R_Q179K	V133G_S176D_T178E

9138-9392	L124E_K145T_Q179E	S131K_V133G_S176R	L124R_Q179K	Q124E_V133G_S176D_T178E_T180E
9144-9423	L124E_K145T_Q179E	S131K_V133G_S176R	L124R_Q179K	V133G_S176D_T178E_T180E
9146-9444	L124E_K145T_Q179E	S131K_V133G_S176R	L124R_Q179K	V133G_S176D_T180E
9160-9416	L124E_K145T_Q179E	S131R_V133G_S176R	L124R_Q179K	V133G_S176D_T178E
9154-9394	L124E_K145T_Q179E	S131R_V133G_S176R	L124R_Q179K	Q124E_V133G_S176D_T178E_T180E
9162-9425	L124E_K145T_Q179E	S131R_V133G_S176R	L124R_Q179K	V133G_S176D_T178E_T180E
9164-9446	L124E_K145T_Q179E	S131R_V133G_S176R	L124R_Q179K	V133G_S176D_T180E
9156-9397	L124E_K145T_Q179E	S131R_V133G_S176R	L124R_Q179K	V133G_Q160E_S176D_T180E
9129-9414	L124E_K145M_Q179E	S131K_V133G_S176R	L124R_Q179K	V133G_S176D_T178E
9126-9392	L124E_K145M_Q179E	S131K_V133G_S176R	L124R_Q179K	Q124E_V133G_S176D_T178E_T180E
9130-9423	L124E_K145M_Q179E	S131K_V133G_S176R	L124R_Q179K	V133G_S176D_T178E_T180E
9142-9357	L124E_K145T_Q179E	S131K_V133G_S176R	L124R_D146N_Q179K	V133G_S176D_T178E
9138-9352	L124E_K145T_Q179E	S131K_V133G_S176R	L124R_D146N_Q179K	Q124E_V133G_S176D_T178E_T180E
9144-9361	L124E_K145T_Q179E	S131K_V133G_S176R	L124R_D146N_Q179K	V133G_S176D_T178E_T180E
9146-9366	L124E_K145T_Q179E	S131K_V133G_S176R	L124R_D146N_Q179K	V133G_S176D_T180E

9160-9358	L124E_K145T_Q179E	S131R_V133G_S176R	L124R_D146N_Q179K	V133G_S176D_T178E
9154-9353	L124E_K145T_Q179E	S131R_V133G_S176R	L124R_D146N_Q179K	Q124E_V133G_S176D_T178E_T180E
9162-9362	L124E_K145T_Q179E	S131R_V133G_S176R	L124R_D146N_Q179K	V133G_S176D_T178E_T180E
9164-9367	L124E_K145T_Q179E	S131R_V133G_S176R	L124R_D146N_Q179K	V133G_S176D_T180E
9156-9354	L124E_K145T_Q179E	S131R_V133G_S176R	L124R_D146N_Q179K	V133G_Q160E_S176D_T180E

\* Kabat numbering

\*\* Representative design

Table 16. Cluster 2 designs including representative designs.

Unique Identifier	H1_mutation*	L1_mutation*	H2_mutation*	L2_mutation*
9286-9402**	L124E_L143E_K145T	Q124K_V133G_S176R	L124R_Q179K	V133G_S176D_T178E
9170-9350	L124E_L143D_K145M	Q124K_V133G_Q160K_S176R	L124R_D146N_Q179K	Q124E_V133G_S176D_T178E_T180E
9170-9376	L124E_L143D_K145M	Q124K_V133G_Q160K_S176R	L124R_Q179K	Q124E_V133G_S176D_T178E_T180E
9171-9398	L124E_L143D_K145M	Q124K_V133G_Q160K_S176R	L124R_Q179K	V133G_S176D_T178E
9173-9380	L124E_L143D_K145M	Q124K_V133G_S176R	L124R_Q179K	Q124E_V133G_S176D_T178E_T180E
9174-9402	L124E_L143D_K145M	Q124K_V133G_S176R	L124R_Q179K	V133G_S176D_T178E
9175-9432	L124E_L143D_K145M	Q124K_V133G_S176R	L124R_Q179K	V133G_S176D_T180E
9178-9384	L124E_L143D_K145M	Q124K_V133G_S176R_T178K	L124R_Q179K	Q124E_V133G_S176D_T178E_T180E
9181-9406	L124E_L143D_K145M	Q124K_V133G_S176R_T178K	L124R_Q179K	V133G_S176D_T178E
9205-9368	L124E_L143D_K145M	V133G_S176R_T178K	L124R_D146N_Q179K	V133G_S176D_T180E
9198-9395	L124E_L143D_K145M	V133G_S176R_T178K	L124R_Q179K	Q124E_V133G_S176D_T178E_T180E
9202-9426	L124E_L143D_K145M	V133G_S176R_T178K	L124R_Q179K	V133G_S176D_T178E_T180E
9208-9350	L124E_L143D_K145T	Q124K_V133G_Q160K_S176R	L124R_D146N_Q179K	Q124E_V133G_S176D_T178E_T180E
9208-9376	L124E_L143D_K145T	Q124K_V133G_Q160K_S176R	L124R_Q179K	Q124E_V133G_S176D_T178E_T180E

9209-9398	L124E_L143D_K145T	Q124K_V133G_Q160K_S176R	L124R_Q179K	V133G_S176D_T178E
9211-9380	L124E_L143D_K145T	Q124K_V133G_S176R	L124R_Q179K	Q124E_V133G_S176D_T178E_T180E
9212-9402	L124E_L143D_K145T	Q124K_V133G_S176R	L124R_Q179K	V133G_S176D_T178E
9213-9432	L124E_L143D_K145T	Q124K_V133G_S176R	L124R_Q179K	V133G_S176D_T180E
9216-9384	L124E_L143D_K145T	Q124K_V133G_S176R_T178K	L124R_Q179K	Q124E_V133G_S176D_T178E_T180E
9219-9406	L124E_L143D_K145T	Q124K_V133G_S176R_T178K	L124R_Q179K	V133G_S176D_T178E
9220-9436	L124E_L143D_K145T	Q124K_V133G_S176R_T178K	L124R_Q179K	V133G_S176D_T180E
9225-9388	L124E_L143D_K145T	Q124K_V133G_S176R_T178R	L124R_Q179K	Q124E_V133G_S176D_T178E_T180E
9228-9410	L124E_L143D_K145T	Q124K_V133G_S176R_T178R	L124R_Q179K	V133G_S176D_T178E
9229-9440	L124E_L143D_K145T	Q124K_V133G_S176R_T178R	L124R_Q179K	V133G_S176D_T180E
9243-9368	L124E_L143D_K145T	V133G_S176R_T178K	L124R_D146N_Q179K	V133G_S176D_T180E
9236-9395	L124E_L143D_K145T	V133G_S176R_T178K	L124R_Q179K	Q124E_V133G_S176D_T178E_T180E
9240-9426	L124E_L143D_K145T	V133G_S176R_T178K	L124R_Q179K	V133G_S176D_T178E_T180E
9243-9447	L124E_L143D_K145T	V133G_S176R_T178K	L124R_Q179K	V133G_S176D_T180E
9247-9350	L124E_L143E_K145M	Q124K_V133G_Q160K_S176R	L124R_D146N_Q179K	Q124E_V133G_S176D_T178E_T180E



9247-9376	L124E_L143E_K145M	Q124K_V133G_Q160K_S176R	L124R_Q179K	Q124E_V133G_S176D_T178E_T180E
9248-9398	L124E_L143E_K145M	Q124K_V133G_Q160K_S176R	L124R_Q179K	V133G_S176D_T178E
9252-9380	L124E_L143E_K145M	Q124K_V133G_S176R	L124R_Q179K	Q124E_V133G_S176D_T178E_T180E
9255-9402	L124E_L143E_K145M	Q124K_V133G_S176R	L124R_Q179K	V133G_S176D_T178E
9256-9432	L124E_L143E_K145M	Q124K_V133G_S176R	L124R_Q179K	V133G_S176D_T180E
9259-9384	L124E_L143E_K145M	Q124K_V133G_S176R_T178K	L124R_Q179K	Q124E_V133G_S176D_T178E_T180E
9262-9406	L124E_L143E_K145M	Q124K_V133G_S176R_T178K	L124R_Q179K	V133G_S176D_T178E
9263-9436	L124E_L143E_K145M	Q124K_V133G_S176R_T178K	L124R_Q179K	V133G_S176D_T180E
9266-9388	L124E_L143E_K145M	Q124K_V133G_S176R_T178R	L124R_Q179K	Q124E_V133G_S176D_T178E_T180E
9269-9410	L124E_L143E_K145M	Q124K_V133G_S176R_T178R	L124R_Q179K	V133G_S176D_T178E
9270-9440	L124E_L143E_K145M	Q124K_V133G_S176R_T178R	L124R_Q179K	V133G_S176D_T180E
9271-9350	L124E_L143E_K145T	Q124K_V133G_Q160K_S176R	L124R_D146N_Q179K	Q124E_V133G_S176D_T178E_T180E
9275-9359	L124E_L143E_K145T	Q124K_V133G_Q160K_S176R	L124R_D146N_Q179K	V133G_S176D_T178E_T180E
9271-9376	L124E_L143E_K145T	Q124K_V133G_Q160K_S176R	L124R_Q179K	Q124E_V133G_S176D_T178E_T180E
9273-9398	L124E_L143E_K145T	Q124K_V133G_Q160K_S176R	L124R_Q179K	V133G_S176D_T178E

9275-9419	L124E_L143E_K145T	Q124K_V133G_Q160K_S176R	L124R_Q179K	V133G_S176D_T178E_T180E
9290-9364	L124E_L143E_K145T	Q124K_V133G_S176R	L124R_D146N_Q179K	V133G_S176D_T180E
9283-9380	L124E_L143E_K145T	Q124K_V133G_S176R	L124R_Q179K	Q124E_V133G_S176D_T178E_T180E
9287-9420	L124E_L143E_K145T	Q124K_V133G_S176R	L124R_Q179K	V133G_S176D_T178E_T180E
9290-9432	L124E_L143E_K145T	Q124K_V133G_S176R	L124R_Q179K	V133G_S176D_T180E
9298-9351	L124E_L143E_K145T	Q124K_V133G_S176R_T178K	L124R_D146N_Q179K	Q124E_V133G_S176D_T178E_T180E
9288-9384	L124E_L143E_K145T	Q124K_V133G_S176R_T178K	L124R_Q179K	Q124E_V133G_S176D_T178E_T180E
9302-9406	L124E_L143E_K145T	Q124K_V133G_S176R_T178K	L124R_Q179K	V133G_S176D_T178E
9308-9436	L124E_L143E_K145T	Q124K_V133G_S176R_T178K	L124R_Q179K	V133G_S176D_T180E
9316-9388	L124E_L143E_K145T	Q124K_V133G_S176R_T178R	L124R_Q179K	Q124E_V133G_S176D_T178E_T180E
9319-9410	L124E_L143E_K145T	Q124K_V133G_S176R_T178R	L124R_Q179K	V133G_S176D_T178E
9323-9440	L124E_L143E_K145T	Q124K_V133G_S176R_T178R	L124R_Q179K	V133G_S176D_T180E
9213-9364	L124E_L143D_K145T	Q124K_V133G_S176R	L124R_D146N_Q179K	V133G_S176D_T180E
9256-9364	L124E_L143E_K145M	Q124K_V133G_S176R	L124R_D146N_Q179K	V133G_S176D_T180E
9275-9518**	L124E_L143E_K145T	Q124K_V133G_S176R	L124R_S186R	V133G_S176D_T178D

9175-9546	L124E_L143D_K145M	Q124K_V133G_S176R	L124R_S186R	V133G_S176D_T180E
9176-9451	L124E_L143D_K145M	Q124K_V133G_S176R_T178K	L124R_S186K	Q124E_V133G_S176D_T178D_T180E
9179-9473	L124E_L143D_K145M	Q124K_V133G_S176R_T178K	L124R_S186K	V133G_S176D_T178D_T180E
9176-9505	L124E_L143D_K145M	Q124K_V133G_S176R_T178K	L124R_S186R	Q124E_V133G_S176D_T178D_T180E
9196-9461	L124E_L143D_K145M	V133G_S176R_T178K	L124R_S186K	Q124E_V133G_S176D_T178D_T180E
9199-9484	L124E_L143D_K145M	V133G_S176R_T178K	L124R_S186K	V133G_S176D_T178D_T180E
9202-9489	L124E_L143D_K145M	V133G_S176R_T178K	L124R_S186K	V133G_S176D_T178E_T180E
9205-9501	L124E_L143D_K145M	V133G_S176R_T178K	L124R_S186K	V133G_S176D_T180E
9196-9516	L124E_L143D_K145M	V133G_S176R_T178K	L124R_S186R	Q124E_V133G_S176D_T178D_T180E
9202-9544	L124E_L143D_K145M	V133G_S176R_T178K	L124R_S186R	V133G_S176D_T178E_T180E
9205-9556	L124E_L143D_K145M	V133G_S176R_T178K	L124R_S186R	V133G_S176D_T180E
9213-9546	L124E_L143D_K145T	Q124K_V133G_S176R	L124R_S186R	V133G_S176D_T180E
9214-9451	L124E_L143D_K145T	Q124K_V133G_S176R_T178K	L124R_S186K	Q124E_V133G_S176D_T178D_T180E
9217-9473	L124E_L143D_K145T	Q124K_V133G_S176R_T178K	L124R_S186K	V133G_S176D_T178D_T180E
9214-9505	L124E_L143D_K145T	Q124K_V133G_S176R_T178K	L124R_S186R	Q124E_V133G_S176D_T178D_T180E

9220-9547	L124E_L143D_K145T	Q124K_V133G_S176R_T178K	L124R_S186R	V133G_S176D_T180E
9229-9495	L124E_L143D_K145T	Q124K_V133G_S176R_T178R	L124R_S186K	V133G_S176D_T180E
9229-9550	L124E_L143D_K145T	Q124K_V133G_S176R_T178R	L124R_S186R	V133G_S176D_T180E
9234-9461	L124E_L143D_K145T	V133G_S176R_T178K	L124R_S186K	Q124E_V133G_S176D_T178D_T180E
9237-9484	L124E_L143D_K145T	V133G_S176R_T178K	L124R_S186K	V133G_S176D_T178D_T180E
9240-9489	L124E_L143D_K145T	V133G_S176R_T178K	L124R_S186K	V133G_S176D_T178E_T180E
9243-9501	L124E_L143D_K145T	V133G_S176R_T178K	L124R_S186K	V133G_S176D_T180E
9234-9516	L124E_L143D_K145T	V133G_S176R_T178K	L124R_S186R	Q124E_V133G_S176D_T178D_T180E
9240-9544	L124E_L143D_K145T	V133G_S176R_T178K	L124R_S186R	V133G_S176D_T178E_T180E
9243-9556	L124E_L143D_K145T	V133G_S176R_T178K	L124R_S186R	V133G_S176D_T180E
9250-9449	L124E_L143E_K145M	Q124K_V133G_S176R	L124R_S186K	Q124E_V133G_S176D_T178D_T180E
9253-9471	L124E_L143E_K145M	Q124K_V133G_S176R	L124R_S186K	V133G_S176D_T178D_T180E
9250-9503	L124E_L143E_K145M	Q124K_V133G_S176R	L124R_S186R	Q124E_V133G_S176D_T178D_T180E
9253-9526	L124E_L143E_K145M	Q124K_V133G_S176R	L124R_S186R	V133G_S176D_T178D_T180E
9256-9546	L124E_L143E_K145M	Q124K_V133G_S176R	L124R_S186R	V133G_S176D_T180E

9257-9451	L124E_L143E_K145M	Q124K_V133G_S176R_T178K	L124R_S186K	Q124E_V133G_S176D_T178D_T180E
9257-9505	L124E_L143E_K145M	Q124K_V133G_S176R_T178K	L124R_S186R	Q124E_V133G_S176D_T178D_T180E
9263-9547	L124E_L143E_K145M	Q124K_V133G_S176R_T178K	L124R_S186R	V133G_S176D_T180E
9270-9495	L124E_L143E_K145M	Q124K_V133G_S176R_T178R	L124R_S186K	V133G_S176D_T180E
9281-9449	L124E_L143E_K145T	Q124K_V133G_S176R	L124R_S186K	Q124E_V133G_S176D_T178D_T180E
9279-9463	L124E_L143E_K145T	Q124K_V133G_S176R	L124R_S186K	V133G_S176D_T178D
9284-9471	L124E_L143E_K145T	Q124K_V133G_S176R	L124R_S186K	V133G_S176D_T178D_T180E
9287-9486	L124E_L143E_K145T	Q124K_V133G_S176R	L124R_S186K	V133G_S176D_T178E_T180E
9290-9491	L124E_L143E_K145T	Q124K_V133G_S176R	L124R_S186K	V133G_S176D_T180E
9281-9503	L124E_L143E_K145T	Q124K_V133G_S176R	L124R_S186R	Q124E_V133G_S176D_T178D_T180E
9284-9526	L124E_L143E_K145T	Q124K_V133G_S176R	L124R_S186R	V133G_S176D_T178D_T180E
9287-9541	L124E_L143E_K145T	Q124K_V133G_S176R	L124R_S186R	V133G_S176D_T178E_T180E
9290-9546	L124E_L143E_K145T	Q124K_V133G_S176R	L124R_S186R	V133G_S176D_T180E
9304-9487	L124E_L143E_K145T	Q124K_V133G_S176R_T178K	L124R_S186K	V133G_S176D_T178E_T180E
9304-9542	L124E_L143E_K145T	Q124K_V133G_S176R_T178K	L124R_S186R	V133G_S176D_T178E_T180E

9308-9547	L124E_L143E_K145T	Q124K_V133G_S176R_T178K	L124R_S186R	V133G_S176D_T180E
9320-9488	L124E_L143E_K145T	Q124K_V133G_S176R_T178R	L124R_S186K	V133G_S176D_T178E_T180E
9323-9495	L124E_L143E_K145T	Q124K_V133G_S176R_T178R	L124R_S186K	V133G_S176D_T180E
9323-9550	L124E_L143E_K145T	Q124K_V133G_S176R_T178R	L124R_S186R	V133G_S176D_T180E
9256-9491	L124E_L143E_K145M	Q124K_V133G_S176R	L124R_S186K	V133G_S176D_T180E
9270-9550	L124E_L143E_K145M	Q124K_V133G_S176R_T178R	L124R_S186R	V133G_S176D_T180E

\* Kabat numbering

\*\* Representative designs

Table 17. Cluster 3 designs including representative designs

Unique Identifier	H1_mutation*	L1_mutation*	H2_mutation*	L2_mutation*
<b>9815-9825**</b>	<b>Q39E_L124E</b>	<b>Q38R_V133G_S176R</b>	<b>Q39R_L124R</b>	<b>Q38E_V133G_S176D</b>
9815-9826	Q39E_L124E	Q38R_V133G_S176R	Q39R_L124R_H172R	Q38E_V133G_S176D
9816-9825	Q39E_L124E_H172R	Q38R_V133G_S176R	Q39R_L124R	Q38E_V133G_S176D
9816-9826	Q39E_L124E_H172R	Q38R_V133G_S176R	Q39R_L124R_H172R	Q38E_V133G_S176D
9747-9334	L45P_L124E	P44F_V133G_S176R	L124R	V133G_S176D
9334-9749	L45P_L124E_H172R	P44F_V133G_S176R	L124R	V133G_S176D
9369-9747	L45P_L124E	P44F_V133G_S176R	L124R_H172R	V133G_S176D
<b>9748-9338**</b>	<b>L45P_L124E</b>	<b>P44F_V133G_S176R</b>	<b>L124R</b>	<b>V133G_S176D_T178D</b>
9372-9748	L45P_L124E	P44F_V133G_S176R	L124R_H172R	V133G_S176D_T178D
9338-9750	L45P_L124E_H172R	P44F_V133G_S176R	L124R	V133G_S176D_T178D
9750-9372	L45P_L124E_H172R	P44F_V133G_S176R	L124R_H172R	V133G_S176D_T178D
<b>9327-6054**</b>	<b>L124E_L143F</b>	<b>V133G_S176R</b>	<b>L124R</b>	<b>V133G_S176D_T178D</b>
9107-9339	L124E	V133G_S176K	L124R	V133G_S176D_T178D
9326-6048	L124E_L143F	V133G_S176R	L124R	V133G_S176D

9328-9332	L124E_L143F	V133G_S176R	L124R	S131E_V133G_S176D
9104-9336	L124E	S131T_V133G_S176R_T178Y	L124R	V133G_S176D
9108-9330	L124E	V133G_S176K	L124R	S131E_V133G_S176D
9106-9337	L124E	V133G_S176K	L124R	V133G_S176D
9109-9332	L124E	V133G_S176R	L124R	S131E_V133G_S176D
9066-9335**	F122C_L124E	Q124C_V133G_S176R	L124R	V133G_S176D
9121-9373**	L124E_H172T	V133G_N137K_S174R_S176R	L124R_H172R	V133G_S176D_T178D
9122-9371	L124E_H172T	V133G_S174R_S176R	L124R_H172R	V133G_S176D

\* Kabat numbering

\*\* Representative designs



Table 18. Cluster 4 designs including representative designs

Unique Identifier	H1_mutation*	L1_mutation*	H2_mutation*	L2_mutation*
<b>9168-9342**</b>	L124E_K228D	S121K_V133G_S176R	L124R_A125R	V133G_S176D
9169-9344	L124E_K228D	S121K_V133G_S176R	L124R_A125R	V133G_S176D_T178D
9114-9344	L124E_A125S_K228D	S121K_V133G_S176R	L124R_A125R	V133G_S176D_T178D
9113-9342	L124E_A125S_K228D	S121K_V133G_S176R	L124R_A125R	V133G_S176D
9111-9347	L124E_A125S_H172R_K228D	S121K_V133G_S176R	L124R_A125R_H172T	V133G_N137K_S174R_S176D
<b>9118-6098**</b>	L124E_H172R	V133G_S176R	L124R_H172T	V133G_S174R_S176D
9117-9374	L124E_H172R	V133G_S176K	L124R_H172T	V133G_N137K_S174R_S176D
9119-9375	L124E_H172R	V133G_S176R	L124R_H172T	V133G_N137K_S174R_S176D

\* Kabat numbering

\*\* Representative designs

Table 19. Cluster 5 designs including the representative design

Unique Identifier	H1_mutation*	L1_mutation*	H2_mutation*	L2_mutation*
9116-9349**	L124E_A139W	F116A_V133G_L135V_S176R	I124R_A139G_V190A	V133G_L135W_S176D

\* Kabat numbering

\*\* Representative design

Table 20. Cluster 6 designs including representative designs

Unique identifier	H1_mutation*	L1_mutation*	H2_mutation*	L2_mutation*
9814-9828**	Q39E_K145T_Q179E	Q38R_S131K	Q39R_S186R	Q38E_Q124E_Q160E_T180E
9813-9828	Q39E_K145T_H172R_Q179E	Q38R_S131K	Q39R_S186R	Q38E_Q124E_Q160E_T180E
9814-9824	Q39E_K145T_Q179E	Q38R_S131K	Q39R_H172R_S186R	Q38E_Q124E_Q160E_T180E
9813-9824	Q39E_K145T_H172R_Q179E	Q38R_S131K	Q39R_H172R_S186R	Q38E_Q124E_Q160E_T180E
9745-9075***	L45P_K145T_H172R_Q179E	P44F_S131K	H172R_S186R	Q38E_Q124E_Q160E_T180E
9075-9746	L45P_K145T_Q179E	P44F_S131K	H172R_S186R	Q38E_Q124E_Q160E_T180E
10547-10549	L45P_K145T_Q179E	P44F_S131K	H172R_S186R	Q124E_Q160E_T180E_C214S
10547-10551	L45P_K145T_H172R_Q179E	P44F_S131K	H172R_S186R	Q124E_Q160E_T180E_C214S
9745-9905	L45P_K145T_H172R_Q179E	P44F_S131K	S186R	Q38E_Q124E_Q160E_T180E
9745-9905	L45P_K145T_Q179E	P44F_S131K	S186R	Q38E_Q124E_Q160E_T180E
10545-10551	L45P_K145T_H172R_Q179E	P44F_S131K	S186R	Q124E_Q160E_T180E_C214S
10545-10549	L45P_K145T_Q179E	P44F_S131K	S186R	Q124E_Q160E_T180E_C214S

\* Kabat numbering

\*\* Representative designs

\*\*\* The representative design is similar to 9745-9075 except that L2 lacks the Q38E substitution.

Table 21. Cluster 7 designs including the representative design

Unique Identifier	H1_mutation*	L1_mutation*	H2_mutation*	L2_mutation*
9060-9756**	A139W_L143E_K145T_Q179E	Q124R_T178R_F116A_L135V	Q179K	Q124E_Q160E_T180E_L135W
9060-9054	A139W_L143E_K145T_Q179E	Q124R_T178R_F116A_L135V	A139G_Q179K_V190A	Q124E_Q160E_T180E_L135W
9058-9053	A139W_L143E_K145T_Q179E	Q124R_F116A_L135V	A139G_Q179K_V190A	Q124E_Q160E_T180E_L135W
9058-9755	A139W_L143E_K145T_Q179E	Q124R_F116A_L135V	Q179K	Q124E_Q160E_T180E_L135W

\* Kabat numbering

\*\* Representative design

Table 22. Cluster 8 designs including the representative design

Unique identifier	H1_mutation*	L1_mutation*	H2_mutation*	L2_mutation*
9820-9823**	Q39E_L143E_K145T_Q179E	Q38R_Q124R_Q160K_T178R	Q39R_H172R_Q179K	Q38E_Q124E_Q160E_T180E
9819-9823	Q39E_L143E_K145T_H172R_Q179E	Q38R_Q124R_Q160K_T178R	Q39R_H172R_Q179K	Q38E_Q124E_Q160E_T180E
9820-9822	Q39E_L143E_K145T_Q179E	Q38R_Q124R_Q160K_T178R	Q39R_D146G_Q179K	Q38E_Q124E_Q160E_T180E
9819-9822	Q39E_L143E_K145T_H172R_Q179E	Q38R_Q124R_Q160K_T178R	Q39R_D146G_Q179K	Q38E_Q124E_Q160E_T180E
9820-9821	Q39E_L143E_K145T_Q179E	Q38R_Q124R_Q160K_T178R	Q39R_D146G_H172R_Q179K	Q38E_Q124E_Q160E_T180E
9820-9827	Q39E_L143E_K145T_Q179E	Q38R_Q124R_Q160K_T178R	Q39R_Q179K	Q38E_Q124E_Q160E_T180E
9819-9821	Q39E_L143E_K145T_H172R_Q179E	Q38R_Q124R_Q160K_T178R	Q39R_D146G_H172R_Q179K	Q38E_Q124E_Q160E_T180E
9819-9827	Q39E_L143E_K145T_H172R_Q179E	Q38R_Q124R_Q160K_T178R	Q39R_Q179K	Q38E_Q124E_Q160E_T180E
9817-9823	Q39E_L143E_K145T	Q38R_Q124R_Q160K_T178R	Q39R_H172R_Q179K	Q38E_Q124E_Q160E_T180E
9817-9822	Q39E_L143E_K145T	Q38R_Q124R_Q160K_T178R	Q39R_D146G_Q179K	Q38E_Q124E_Q160E_T180E
9817-9821	Q39E_L143E_K145T	Q38R_Q124R_Q160K_T178R	Q39R_D146G_H172R_Q179K	Q38E_Q124E_Q160E_T180E
9817-9827	Q39E_L143E_K145T	Q38R_Q124R_Q160K_T178R	Q39R_Q179K	Q38E_Q124E_Q160E_T180E
9818-9823	Q39E_L143E_K145T_H172R	Q38R_Q124R_Q160K_T178R	Q39R_H172R_Q179K	Q38E_Q124E_Q160E_T180E

9818-9822	Q39E_L143E_K145T_H172R	Q38R_Q124R_Q160K_T178R	Q39R_D146G_Q179K	Q38E_Q124E_Q160E_T180E
9818-9821	Q39E_L143E_K145T_H172R	Q38R_Q124R_Q160K_T178R	Q39R_D146G_H172R_Q179K	Q38E_Q124E_Q160E_T180E
9818-9827	Q39E_L143E_K145T_H172R	Q38R_Q124R_Q160K_T178R	Q39R_Q179K	Q38E_Q124E_Q160E_T180E

\* Kabat numbering

\*\* Representative design

Table 23. Cluster 9 designs including representative designs

Unique identifier	H1_mutation*	L1_mutation*	H2_mutation*	L2_mutation*
9751-9065***	L45P_L143E_K145T	P44F_Q124R_Q160K_T178R	D146G_Q179K	Q38E_Q124E_Q160E_T180E
9752-9064	L45P_L143E_K145T_H172R	P44F_Q124R_Q160K_T178R	D146G_H172R_Q179K	Q38E_Q124E_Q160E_T180E
9064-9751	L45P_L143E_K145T	P44F_Q124R_Q160K_T178R	D146G_H172R_Q179K	Q38E_Q124E_Q160E_T180E
9065-9752	L45P_L143E_K145T_H172R	P44F_Q124R_Q160K_T178R	D146G_Q179K	Q38E_Q124E_Q160E_T180E
9753-9074	L45P_L143E_K145T_H172R_Q179E	P44F_Q124R_Q160K_T178R	H172R_Q179K	Q124E_Q160E_T180E
9753-9760	L45P_L143E_K145T_H172R_Q179E	P44F_Q124R_Q160K_T178R	Q179K	Q124E_Q160E_T180E
9754-9760	L45P_L143E_K145T_Q179E	P44F_Q124R_Q160K_T178R	Q179K	Q124E_Q160E_T180E
9074-9754	L45P_L143E_K145T_Q179E	P44F_Q124R_Q160K_T178R	H172R_Q179K	Q124E_Q160E_T180E
10548-10550	L45P_L143E_K145T	P44F_Q124R_Q160K_T178R	D146G_H172R_Q179K	Q124E_Q160E_T180E_C214S
10548-10552	L45P_L143E_K145T_H172R	P44F_Q124R_Q160K_T178R	D146G_H172R_Q179K	Q124E_Q160E_T180E_C214S
10546-10550	L45P_L143E_K145T	P44F_Q124R_Q160K_T178R	D146G_Q179K	Q124E_Q160E_T180E_C214S
10546-10552	L45P_L143E_K145T_H172R	P44F_Q124R_Q160K_T178R	D146G_Q179K	Q124E_Q160E_T180E_C214S
9611-9077**	L143E_K145T_H172R	Q124R_Q160K_T178R	H172T_Q179K	Q124E_Q160E_T180E_N137K_S174R
9612-9078	L143E_K145T_H172R_Q179E	Q124R_T178R	H172T_Q179K	Q124E_Q160E_T180E_N137K_S174R



9610-9076	L143E_K145T_H172R	Q124R	H172T_Q179K	Q124E_Q160E_T180E_N137K_S174R
-----------	-------------------	-------	-------------	-------------------------------

\* Kabat numbering

\*\* Representative designs

\*\*\* The representative design is similar to 9751-9065 except that L2 lacks the Q38E substitution.

Table 24. Cluster 10 designs including representative designs

Unique Identifier	H1_mutation*	L1_mutation*	H2_mutation*	L2_mutation*
9561-9095**	L124W_L143E_K145T_Q179E	Q124R_V133A_S176T_T178R	L124A_L143F_Q179K	Q124E_V133W_S176T_T178L_T180E
9559-9094	L124W_L143E_K145T_Q179E	Q124K_V133A_S176T_T178R	L124A_L143F_Q179K	Q124E_V133W_S176T_T178L_T180E
9564-9099	L124W_L143E_K145T_Q179E	S131K_V133A_S176T_T178L	L124A_Q179K	Q124E_V133W_S176T_T178L_T180E
9564-9096	L124W_L143E_K145T_Q179E	S131K_V133A_S176T_T178L	L124A_L143F_Q179K	Q124E_V133W_S176T_T178L_T180E
9560-9091	L124W_L143E_K145T_Q179E	Q124R_V133A_S176T_T178R	L124A_L143F_Q179K	Q124E_V133W_S176T_T178E_T180E
9558-9090	L124W_L143E_K145T_Q179E	Q124K_V133A_S176T_T178R	L124A_L143F_Q179K	Q124E_V133W_S176T_T178E_T180E
9562-9092	L124W_L143E_K145T_Q179E	S131K_V133A_S176T_T178L	L124A_L143F_Q179K	Q124E_V133W_S176T_T178E_T180E
9562-9086	L124W_L143E_K145T_Q179E	S131K_V133A_S176T_T178L	L124A_Q179K	Q124E_V133W_S176T_T178E_T180E
9571-9092	L124W_L143F_K145T_Q179E	S131K_V133A_S176T_T178L	L124A_L143F_Q179K	Q124E_V133W_S176T_T178E_T180E
9572-9096	L124W_L143F_K145T_Q179E	S131K_V133A_S176T_T178L	L124A_L143F_Q179K	Q124E_V133W_S176T_T178L_T180E
9098-9571	L124W_L143F_K145T_Q179E	S131K_V133A_S176T_T178L	L124A_Q179K	Q124E_V133W_S176T_T178E_T180E
9099-9572	L124W_L143F_K145T_Q179E	S131K_V133A_S176T_T178L	L124A_Q179K	Q124E_V133W_S176T_T178L_T180E

\* Kabat numbering

\*\* Representative design

Table 25. Cluster 11. designs including representative designs

Unique Identifier	H1_mutation*	L1_mutation*	H2_mutation*	L2_mutation*
9049-9759**	A139C_L143E_K145T_Q179E	F116C_Q124R_T178R	Q179K	Q124E_Q160E_T180E
9667-9830**	L143E_K145T_Q179E	Q124R_T178R	S186K	Q124E_T178E_Q160E
9667-9758	L143E_K145T_Q179E	Q124R_T178R	Q179K	Q124E_T178E_Q160E
9667-9802	L143E_K145T_Q179E	Q124R_T178R	Q179R	Q124E_T178E_Q160E
9667-9868	L143E_K145T_Q179E	Q124R_T178R	S186R	Q124E_T178E_Q160E
9671-9784	L143E_K145T_Q179E	Q124R_T178R	Q179K	Q124E_T178E
9671-9810	L143E_K145T_Q179E	Q124R_T178R	Q179R	Q124E_T178E
9671-9850	L143E_K145T_Q179E	Q124R_T178R	S186K	Q124E_T178E
9671-9888	L143E_K145T_Q179E	Q124R_T178R	S186R	Q124E_T178E
9675-9786	L143E_K145T_Q179E	Q124R_T178R	Q179K	Q124E_T178E_T180E
9675-9812	L143E_K145T_Q179E	Q124R_T178R	Q179R	Q124E_T178E_T180E
9675-9852	L143E_K145T_Q179E	Q124R_T178R	S186K	Q124E_T178E_T180E
9675-9890	L143E_K145T_Q179E	Q124R_T178R	S186R	Q124E_T178E_T180E

9579-9797	L143D_K145T_Q179E	T178R	Q179K	Q124E_T180E
9614-9761	L143E_K145T_Q179D	Q124K_T178R	Q179K	Q124E_Q160E_T180E
9617-9787	L143E_K145T_Q179D	Q124K_T178R	Q179K	Q124E_T180E
9623-9789	L143E_K145T_Q179D	Q124R_Q160K_T178R	Q179K	Q124E_T180E
9626-9767	L143E_K145T_Q179D	Q124R_T178K	Q179K	Q124E_Q160E_T180E
9629-9792	L143E_K145T_Q179D	Q124R_T178K	Q179K	Q124E_T180E
9632-9769	L143E_K145T_Q179D	Q124R_T178R	Q179K	Q124E_Q160E_T180E
9635-9794	L143E_K145T_Q179D	Q124R_T178R	Q179K	Q124E_T180E
9641-9797	L143E_K145T_Q179D	T178R	Q179K	Q124E_T180E
9645-9761	L143E_K145T_Q179E	Q124K_T178R	Q179K	Q124E_Q160E_T180E
9648-9787	L143E_K145T_Q179E	Q124K_T178R	Q179K	Q124E_T180E
9654-9789	L143E_K145T_Q179E	Q124R_Q160K_T178R	Q179K	Q124E_T180E
9657-9767	L143E_K145T_Q179E	Q124R_T178K	Q179K	Q124E_Q160E_T180E
9660-9792	L143E_K145T_Q179E	Q124R_T178K	Q179K	Q124E_T180E
9663-9769	L143E_K145T_Q179E	Q124R_T178R	Q179K	Q124E_Q160E_T180E

9679-9794	L143E_K145T_Q179E	Q124R_T178R	Q179K	Q124E_T180E
9684-9797	L143E_K145T_Q179E	T178R	Q179K	Q124E_T180E
9575-9841	L143D_K145T_Q179E	T178R	S186K	Q124E_Q160E_T180E
9579-9863	L143D_K145T_Q179E	T178R	S186K	Q124E_T180E
9579-9901	L143D_K145T_Q179E	T178R	S186R	Q124E_T180E
9617-9853	L143E_K145T_Q179D	Q124K_T178R	S186K	Q124E_T180E
9617-9891	L143E_K145T_Q179D	Q124K_T178R	S186R	Q124E_T180E
9623-9855	L143E_K145T_Q179D	Q124R_Q160K_T178R	S186K	Q124E_T180E
9623-9893	L143E_K145T_Q179D	Q124R_Q160K_T178R	S186R	Q124E_T180E
9626-9836	L143E_K145T_Q179D	Q124R_T178K	S186K	Q124E_Q160E_T180E
9626-9874	L143E_K145T_Q179D	Q124R_T178K	S186R	Q124E_Q160E_T180E
9629-9858	L143E_K145T_Q179D	Q124R_T178K	S186K	Q124E_T180E
9629-9896	L143E_K145T_Q179D	Q124R_T178K	S186R	Q124E_T180E
9632-9838	L143E_K145T_Q179D	Q124R_T178R	S186K	Q124E_Q160E_T180E
9635-9850	L143E_K145T_Q179D	Q124R_T178R	S186K	Q124E_T180E

9635-9898	L143E_K145T_Q179D	Q124R_T178R	S186R	Q124E_T180E
9641-9863	L143E_K145T_Q179D	T178R	S186K	Q124E_T180E
9641-9901	L143E_K145T_Q179D	T178R	S186R	Q124E_T180E
9648-9855	L143E_K145T_Q179E	Q124K_T178R	S186K	Q124E_T180E
9648-9891	L143E_K145T_Q179E	Q124K_T178R	S186R	Q124E_T180E
9654-9855	L143E_K145T_Q179E	Q124R_Q160K_T178R	S186K	Q124E_T180E
9654-9893	L143E_K145T_Q179E	Q124R_Q160K_T178R	S186R	Q124E_T180E
9657-9836	L143E_K145T_Q179E	Q124R_T178K	S186K	Q124E_Q160E_T180E
9660-9858	L143E_K145T_Q179E	Q124R_T178K	S186K	Q124E_T180E
9660-9896	L143E_K145T_Q179E	Q124R_T178K	S186R	Q124E_T180E
9663-9838	L143E_K145T_Q179E	Q124R_T178R	S186K	Q124E_Q160E_T180E
9663-9876	L143E_K145T_Q179E	Q124R_T178R	S186R	Q124E_Q160E_T180E
9679-9860	L143E_K145T_Q179E	Q124R_T178R	S186K	Q124E_T180E
9679-9898	L143E_K145T_Q179E	Q124R_T178R	S186R	Q124E_T180E
9683-9841	L143E_K145T_Q179E	T178R	S186K	Q124E_Q160E_T180E

9606-9855	L143E_K145T	Q124R_Q160K_T178R	S186K	Q124E_T180E
9606-9893	L143E_K145T	Q124R_Q160K_T178R	S186R	Q124E_T180E
9682-9740**	L143E_K145T_Q179E	Q124R_T178R	L143R	Q124E_V133E
9666-9731	L143E_K145T_Q179E	Q124R_T178R	L143K	Q124E_V133D

\* Kabat numbering

\*\* Representative designs

Table 26. Cluster 12 designs including representative designs

Unique Identifier	H1_mutation*	L1_mutation*	H2_mutation*	L2_mutation*
9696-9848**	L143E_K145T_Q179E_S188L	Q124R_T178R	S186K	Q124E_S176L_T180E
9696-9782	L143E_K145T_Q179E_S188L	Q124R_T178R	Q179K	Q124E_S176L_T180E
9696-9886	L143E_K145T_Q179E_S188L	Q124R_T178R	S186R	Q124E_S176L_T180E
9696-9808	L143E_K145T_Q179E_S188L	Q124R_T178R	Q179R	Q124E_S176L_T180E
9702-9574	L143E_K145T_Q179E_S188L	Q124R_T178R	L143A_Q179K	Q124E_V133Y_T180E
9700-9103	L143E_K145T_Q179E_S188L	Q124R_T178R	L124A_S186K	Q124E_V133W_T180E
9700-9101	L143E_K145T_Q179E_S188L	Q124R_T178R	L124A_Q179K	Q124E_V133W_T180E
9716-9807	L143E_K145T_S188L	Q124R_Q160K_T178R	Q179R	Q124E_S176L_T180E
9716-9847	L143E_K145T_S188L	Q124R_Q160K_T178R	S186K	Q124E_S176L_T180E
9716-9781	L143E_K145T_S188L	Q124R_Q160K_T178R	Q179K	Q124E_S176L_T180E
9692-9846**	L143E_K145T_Q179E_S188L	Q124R_T178R	S186K	Q124E_S131T_T178Y_T180E
9692-9806	L143E_K145T_Q179E_S188L	Q124R_T178R	Q179R	Q124E_S131T_T178Y_T180E
9688-9844	L143E_K145T_Q179E_S188L	Q124R_T178R	S186K	Q124E_S131T_T178F_T180E



9688-9804	L143E_K145T_Q179E_S188L	Q124R_T178R	Q179R	Q124E_S131T_T178F_T180E
9692-9780	L143E_K145T_Q179E_S188L	Q124R_T178R	Q179K	Q124E_S131T_T178Y_T180E
9688-9778	L143E_K145T_Q179E_S188L	Q124R_T178R	Q179K	Q124E_S131T_T178F_T180E
9712-9779	L143E_K145T_S188L	Q124R_Q160K_T178R	Q179K	Q124E_S131T_T178Y_T180E
9712-9805	L143E_K145T_S188L	Q124R_Q160K_T178R	Q179R	Q124E_S131T_T178Y_T180E
9708-9777	L143E_K145T_S188L	Q124R_Q160K_T178R	Q179K	Q124E_S131T_T178F_T180E
9712-9845	L143E_K145T_S188L	Q124R_Q160K_T178R	S186K	Q124E_S131T_T178Y_T180E
9692-9884	L143E_K145T_Q179E_S188L	Q124R_T178R	S186R	Q124E_S131T_T178Y_T180E
9594-9829	L143E_K145T	Q124R_Q160K_T178R	S186K	Q124E_T178E_Q160E
9602-9889	L143E_K145T	Q124R_Q160K_T178R	S186R	Q124E_T178E_T180E
9602-9785	L143E_K145T	Q124R_Q160K_T178R	Q179K	Q124E_T178E_T180E
9602-9811	L143E_K145T	Q124R_Q160K_T178R	Q179R	Q124E_T178E_T180E
9594-9757	L143E_K145T	Q124R_Q160K_T178R	Q179K	Q124E_T178E_Q160E
9598-9849	L143E_K145T	Q124R_Q160K_T178R	S186K	Q124E_T178E
9598-9809	L143E_K145T	Q124R_Q160K_T178R	Q179R	Q124E_T178E

9594-9801	L143E_K145T	Q124R_Q160K_T178R	Q179R	Q124E_T178E_Q160E
9602-9851	L143E_K145T	Q124R_Q160K_T178R	S186K	Q124E_T178E_T180E
9986-9978**	L143E_K145T	Q124R_Q160K_T178R	S186K	S131E
9987-9982	L143E_K145T	Q124R_T178R	S186K	S131E
9986-9979	L143E_K145T	Q124R_Q160K_T178R	Q179K	S131E
9587-9735**	L143E_K145T	Q124R	L143R	Q124E_V133E
9609-9737	L143E_K145T	Q124R_Q160K_T178R	L143R	Q124E_V133E
9589-9742	L143E_K145T	Q124R	L143R	Q124E_V133E_Q160M
9687-9737	L143E_K145T_Q179E_S188L	Q124R_Q160K_T178R	L143R	Q124E_V133E
9705-9735	L143E_K145T_S188L	Q124R	L143R	Q124E_V133E
9720-9733	L143E_K145T_S188L	Q124R_Q160K_T178R	L143K	Q124E_V133D_S176L
9703-9734	L143E_K145T_S188L	Q124R	L143K_D146G	Q124E_V133D
9722-9744	L143E_K145T_S188L	Q124R_Q160K_T178R	L143R	Q124E_V133E_S176L

\* Kabat numbering

\*\* Representative designs

Table 27. Cluster 13 designs including representative designs

Unique Identifier	H1_mutation*	L1_mutation*	H2_mutation*	L2_mutation*
9042-9046	F122C_C233S	Q124C_C214S	WT	WT

Table 28a. SMCA unique identifiers for the trastuzumab/cetuximab bispecific system

SMCA unique identifiers	H1L1 Ab	H2L2 Ab	H1*	L1*	H2*	L2*
3519_1	Trastuzumab	Cetuximab	L45P_K145T_H172R_Q179E	P44F_S131K	H172R_S186R	Q124E_Q160E_T180E
3519_2	Cetuximab	Trastuzumab	L45P_K145T_H172R_Q179E	P44F_S131K	H172R_S186R	Q124E_Q160E_T180E
3522_1	Trastuzumab	Cetuximab	L45P_L143E_K145T	P44F_Q124R_Q160K_T178R	D146G_Q179K	Q124E_Q160E_T180E
3522_2	Cetuximab	Trastuzumab	L45P_L143E_K145T	P44F_Q124R_Q160K_T178R	D146G_Q179K	Q124E_Q160E_T180E
9049-9759_1	Trastuzumab	Cetuximab	A139C_L143E_K145T_Q179E	F116C_Q124R_T178R	Q179K	Q124E_Q160E_T180E
9049-9759_2	Cetuximab	Trastuzumab	A139C_L143E_K145T_Q179E	F116C_Q124R_T178R	Q179K	Q124E_Q160E_T180E
9060-9756_1	Cetuximab	Trastuzumab	A139W_L143E_K145T_Q179E	F116A_Q124R_L135V_T178R	Q179K	Q124E_L135W_Q160E_T180E
9060-9756_2	Trastuzumab	Cetuximab	A139W_L143E_K145T_Q179E	F116A_Q124R_L135V_T178R	Q179K	Q124E_L135W_Q160E_T180E
9066-9335_1	Cetuximab	Trastuzumab	F122C_L124E	Q124C_V133G_S176R	L124R	V133G_S176D
9066-9335_2	Trastuzumab	Cetuximab	F122C_L124E	Q124C_V133G_S176R	L124R	V133G_S176D
9116-9349_1	Cetuximab	Trastuzumab	L124E_A139W	F116A_V133G_L135V_S176R	L124R_A139G_V190A	V133G_L135W_S176D
9116-9349_2	Trastuzumab	Cetuximab	L124E_A139W	F116A_V133G_L135V_S176R	L124R_A139G_V190A	V133G_L135W_S176D
9118-6098_1	Cetuximab	Trastuzumab	L124E_H172R	V133G_S176R	L124R_H172T	V133G_S174R_S176D
9118-6098_2	Trastuzumab	Cetuximab	L124E_H172R	V133G_S176R	L124R_H172T	V133G_S174R_S176D
9121-9373_1	Cetuximab	Trastuzumab	L124E_H172T	V133G_N137K_S174R_S176R	L124R_H172R	V133G_S176D_T178D
9121-9373_2	Trastuzumab	Cetuximab	L124E_H172T	V133G_N137K_S174R_S176R	L124R_H172R	V133G_S176D_T178D
9134-9521_1	Trastuzumab	Cetuximab	L124E_K145T_Q179E	S131K_V133G_S176R	L124R_S186R	V133G_S176D_T178D
9134-9521_2	Cetuximab	Trastuzumab	L124E_K145T_Q179E	S131K_V133G_S176R	L124R_S186R	V133G_S176D_T178D
9168-9342_1	Trastuzumab	Cetuximab	L124E_K28D	S121K_V133G_S176R	L124R_A125R	V133G_S176D
9168-9342_2	Cetuximab	Trastuzumab	L124E_K28D	S121K_V133G_S176R	L124R_A125R	V133G_S176D
9279-9518_1	Cetuximab	Trastuzumab	L124E_L143E_K145T	Q124K_V133G_S176R	L124R_S186R	V133G_S176D_T178D
9279-9518_2	Trastuzumab	Cetuximab	L124E_L143E_K145T	Q124K_V133G_S176R	L124R_S186R	V133G_S176D_T178D
9286-9402_1	Cetuximab	Trastuzumab	L124E_L143E_K145T	Q124K_V133G_S176R	L124R_Q179K	V133G_S176D_T178E
9286-9402_2	Trastuzumab	Cetuximab	L124E_L143E_K145T	Q124K_V133G_S176R	L124R_Q179K	V133G_S176D_T178E
9327-6054_1	Cetuximab	Trastuzumab	L124E_L143F	V133G_S176R	L124R	V133G_S176D_T178D
9327-6054_2	Trastuzumab	Cetuximab	L124E_L143F	V133G_S176R	L124R	V133G_S176D_T178D
9561-9095_1	Cetuximab	Trastuzumab	L124W_L143E_K145T_Q179E	Q124R_V133A_S176T_T178R	L124A_L143F_Q179K	Q124E_V133W_S176T_T178L_T180E
9561-9095_2	Trastuzumab	Cetuximab	L124W_L143E_K145T_Q179E	Q124R_V133A_S176T_T178R	L124A_L143F_Q179K	Q124E_V133W_S176T_T178L_T180E
9587-9735_1	Cetuximab	Cetuximab	L143E_K145T	Q124R	L143R	Q124E_V133E
9587-9735_2	Trastuzumab	Trastuzumab	L143E_K145T	Q124R	L143R	Q124E_V133E
9611-9077_1	Cetuximab	Trastuzumab	L143E_K145T_H172R	Q124R_Q160K_T178R	H172T_Q179K	Q124E_N137K_Q160E_S174R_T180E
9611-9077_2	Trastuzumab	Cetuximab	L143E_K145T_H172R	Q124R_Q160K_T178R	H172T_Q179K	Q124E_N137K_Q160E_S174R_T180E
9667-9830_1	Trastuzumab	Cetuximab	L143E_K145T_Q179E	Q124R_T178R	S186K	Q124E_Q160E_T178E
9667-9830_2	Cetuximab	Trastuzumab	L143E_K145T_Q179E	Q124R_T178R	S186K	Q124E_Q160E_T178E
9682-9740_1	Trastuzumab	Cetuximab	L143E_K145T_Q179E	Q124R_T178R	L143R	Q124E_V133E
9682-9740_2	Cetuximab	Trastuzumab	L143E_K145T_Q179E	Q124R_T178R	L143R	Q124E_V133E
9692-9846_1	Trastuzumab	Cetuximab	L143E_K145T_Q179E_S188L	Q124R_T178R	S186K	Q124E_S131T_T178Y_T180E

9692-9846_2	Cetuximab	Trastuzumab	L143E_K145T_Q179E_S188L	Q124R_T178R	S186K	Q124E_S131T_T178Y_T180E
9696-9848_1	Trastuzumab	Cetuximab	L143E_K145T_Q179E_S188L	Q124R_T178R	S186K	Q124E_S176L_T180E
9696-9848_2	Cetuximab	Trastuzumab	L143E_K145T_Q179E_S188L	Q124R_T178R	S186K	Q124E_S176L_T180E
9748-9338_1	Cetuximab	Trastuzumab	L45P_L124E	P44F_V133G_S176R	L124R	V133G_S176D_T178D
9748-9338_2	Trastuzumab	Cetuximab	L45P_L124E	P44F_V133G_S176R	L124R	V133G_S176D_T178D
9814-9828_1	Trastuzumab	Cetuximab	Q39E_K145T_Q179E	Q38R_S131K	Q39R_S186R	Q38E_Q124E_Q160E_T180E
9814-9828_2	Cetuximab	Trastuzumab	Q39E_K145T_Q179E	Q38R_S131K	Q39R_S186R	Q38E_Q124E_Q160E_T180E
9815-9825_1	Cetuximab	Trastuzumab	Q39E_L124E	Q38R_V133G_S176R	Q39R_L124R	Q38E_V133G_S176D
9815-9825_2	Trastuzumab	Cetuximab	Q39E_L124E	Q38R_V133G_S176R	Q39R_L124R	Q38E_V133G_S176D
9820-9823_1	Cetuximab	Trastuzumab	Q39E_L143E_K145T_Q179E	Q38R_Q124R_Q160K_T178R	Q39R_H172R_Q179K	Q38E_Q124E_Q160E_T180E
9820-9823_2	Trastuzumab	Cetuximab	Q39E_L143E_K145T_Q179E	Q38R_Q124R_Q160K_T178R	Q39R_H172R_Q179K	Q38E_Q124E_Q160E_T180E
9986-9978_1	Trastuzumab	Cetuximab	L143E_K145T	Q124R_Q160K_T178R	S186K	S131E
9986-9978_2	Cetuximab	Trastuzumab	L143E_K145T	Q124R_Q160K_T178R	S186K	S131E

\* Kabat numbering. Note that the WT residues refer to the D3H44 system.

Table 28b. SMCA unique identifiers for the D3H44/cetuximab bispecific system

SMCA unique identifiers	H1L1 Ab	H2L2 Ab	H1*	L1*	H2*	L2*
3519_1	Cetuximab	D3H44	L45P_K145T_H172R_Q179E	P44F_S131K	H172R_S186R	Q124E_Q160E_T180E
3519_2	D3H44	Cetuximab	L45P_K145T_H172R_Q179E	P44F_S131K	H172R_S186R	Q124E_Q160E_T180E
3522_1	Cetuximab	D3H44	L45P_L143E_K145T	P44F_Q124R_Q160K_T178R	D146G_Q179K	Q124E_Q160E_T180E
3522_2	D3H44	Cetuximab	L45P_L143E_K145T	P44F_Q124R_Q160K_T178R	D146G_Q179K	Q124E_Q160E_T180E
9049-9759_1	Cetuximab	D3H44	A139C_L143E_K145T_Q179E	F116C_Q124R_T178R	Q179K	Q124E_Q160E_T180E
9049-9759_2	D3H44	Cetuximab	A139C_L143E_K145T_Q179E	F116C_Q124R_T178R	Q179K	Q124E_Q160E_T180E
9060-9756_1	Cetuximab	D3H44	A139W_L143E_K145T_Q179E	F116A_Q124R_L135V_T178R	Q179K	Q124E_L135W_Q160E_T180E
9060-9756_2	D3H44	Cetuximab	A139W_L143E_K145T_Q179E	F116A_Q124R_L135V_T178R	Q179K	Q124E_L135W_Q160E_T180E
9066-9335_1	Cetuximab	D3H44	F122C_L124E	Q124C_V133G_S176R	L124R	V133G_S176D
9066-9335_2	D3H44	Cetuximab	F122C_L124E	Q124C_V133G_S176R	L124R	V133G_S176D
9116-9349_1	Cetuximab	D3H44	L124E_A139W	F116A_V133G_L135V_S176R	L124R_A139G_V190A	V133G_L135W_S176D
9116-9349_2	D3H44	Cetuximab	L124E_A139W	F116A_V133G_L135V_S176R	L124R_A139G_V190A	V133G_L135W_S176D
9118-6098_1	Cetuximab	D3H44	L124E_H172R	V133G_S176R	L124R_H172T	V133G_S174R_S176D
9118-6098_2	D3H44	Cetuximab	L124E_H172R	V133G_S176R	L124R_H172T	V133G_S174R_S176D
9121-9373_1	Cetuximab	D3H44	L124E_H172T	V133G_N137K_S174R_S176R	L124R_H172R	V133G_S176D_T178D
9121-9373_2	D3H44	Cetuximab	L124E_H172T	V133G_N137K_S174R_S176R	L124R_H172R	V133G_S176D_T178D
9134-9521_1	Cetuximab	D3H44	L124E_K145T_Q179E	S131K_V133G_S176R	L124R_S186R	V133G_S176D_T178D
9134-9521_2	D3H44	Cetuximab	L124E_K145T_Q179E	S131K_V133G_S176R	L124R_S186R	V133G_S176D_T178D
9168-9342_1	Cetuximab	D3H44	L124E_K228D	S121K_V133G_S176R	L124R_A125R	V133G_S176D
9168-9342_2	D3H44	Cetuximab	L124E_K228D	S121K_V133G_S176R	L124R_A125R	V133G_S176D
9279-9518_1	Cetuximab	D3H44	L124E_L143E_K145T	Q124K_V133G_S176R	L124R_S186R	V133G_S176D_T178D
9279-9518_2	D3H44	Cetuximab	L124E_L143E_K145T	Q124K_V133G_S176R	L124R_S186R	V133G_S176D_T178D
9286-9402_1	Cetuximab	D3H44	L124E_L143E_K145T	Q124K_V133G_S176R	L124R_Q179K	V133G_S176D_T178E
9286-9402_2	D3H44	Cetuximab	L124E_L143E_K145T	Q124K_V133G_S176R	L124R_Q179K	V133G_S176D_T178E
9327-6054_1	Cetuximab	D3H44	L124E_L143F	V133G_S176R	L124R	V133G_S176D_T178D
9327-6054_2	D3H44	Cetuximab	L124E_L143F	V133G_S176R	L124R	V133G_S176D_T178D
9561-9095_1	Cetuximab	D3H44	L124W_L143E_K145T_Q179E	Q124R_V133A_S176T_T178R	L124A_L143F_Q179K	Q124E_V133W_S176T_T178L_T180E
9561-9095_2	D3H44	Cetuximab	L124W_L143E_K145T_Q179E	Q124R_V133A_S176T_T178R	L124A_L143F_Q179K	Q124E_V133W_S176T_T178L_T180E
9587-9735_1	Cetuximab	D3H44	L143E_K145T	Q124R	L143R	Q124E_V133E
9587-9735_2	D3H44	Cetuximab	L143E_K145T	Q124R	L143R	Q124E_V133E
9611-9077_1	Cetuximab	D3H44	L143E_K145T_H172R	Q124R_Q160K_T178R	H172T_Q179K	Q124E_N137K_Q160E_S174R_T180E
9611-9077_2	D3H44	Cetuximab	L143E_K145T_H172R	Q124R_Q160K_T178R	H172T_Q179K	Q124E_N137K_Q160E_S174R_T180E
9667-9830_1	Cetuximab	D3H44	L143E_K145T_Q179E	Q124R_T178R	S186K	Q124E_Q160E_T178E
9667-9830_2	D3H44	Cetuximab	L143E_K145T_Q179E	Q124R_T178R	S186K	Q124E_Q160E_T178E
9682-9740_1	Cetuximab	D3H44	L143E_K145T_Q179E	Q124R_T178R	L143R	Q124E_V133E
9682-9740_2	D3H44	Cetuximab	L143E_K145T_Q179E	Q124R_T178R	L143R	Q124E_V133E
9692-9846_1	Cetuximab	D3H44	L143E_K145T_Q179E_S188L	Q124R_T178R	S186K	Q124E_S131T_T178Y_T180E

9692-9846_2	D3H44	Cetuximab	L143E_K145T_Q179E_S188L	Q124R_T178R	S186K	Q124E_S131T_T178Y_T180E
9696-9848_1	Cetuximab	D3H44	L143E_K145T_Q179E_S188L	Q124R_T178R	S186K	Q124E_S176L_T180E
9696-9848_2	D3H44	Cetuximab	L143E_K145T_Q179E_S188L	Q124R_T178R	S186K	Q124E_S176L_T180E
9748-9338_1	D3H44	Cetuximab	L45P_L124E	P44F_V133G_S176R	L124R	V133G_S176D_T178D
9748-9338_2	Cetuximab	D3H44	L45P_L124E	P44F_V133G_S176R	L124R	V133G_S176D_T178D
9814-9828_1	Cetuximab	D3H44	Q39E_K145T_Q179E	Q38R_S131K	Q39R_S186R	Q38E_Q124E_Q160E_T180E
9814-9828_2	D3H44	Cetuximab	Q39E_K145T_Q179E	Q38R_S131K	Q39R_S186R	Q38E_Q124E_Q160E_T180E
9815-9825_1	D3H44	Cetuximab	Q39E_L124E	Q38R_V133G_S176R	Q39R_L124R	Q38E_V133G_S176D
9815-9825_2	Cetuximab	D3H44	Q39E_L124E	Q38R_V133G_S176R	Q39R_L124R	Q38E_V133G_S176D
9820-9823_1	D3H44	Cetuximab	Q39E_L143E_K145T_Q179E	Q38R_Q124R_Q160K_T178R	Q39R_H172R_Q179K	Q38E_Q124E_Q160E_T180E
9820-9823_2	Cetuximab	D3H44	Q39E_L143E_K145T_Q179E	Q38R_Q124R_Q160K_T178R	Q39R_H172R_Q179K	Q38E_Q124E_Q160E_T180E
9986-9978_1	Cetuximab	D3H44	L143E_K145T	Q124R_Q160K_T178R	S186K	S131E
9986-9978_2	D3H44	Cetuximab	L143E_K145T	Q124R_Q160K_T178R	S186K	S131E

\* Kabat numbering. Note that the WT residues refer to the D3H44 system.

Table 28c. SMCA unique identifiers for the D3H44/trastuzumab bispecific system

SMCA unique identifiers	H1L1 Ab	H2L2 Ab	H1*	L1*	H2*	L2*
3519_1	Trastuzumab	D3H44	L45P_K145T_H172R_Q179E	P44F_S131K	H172R_S186R	Q124E_Q160E_T180E
3522_1	Trastuzumab	D3H44	L45P_L143E_K145T	P44F_Q124R_Q160K_T178R	D146G_Q179K	Q124E_Q160E_T180E
9049-9759_1	Trastuzumab	D3H44	A139C_L143E_K145T_Q179E	F116C_Q124R_T178R	Q179K	Q124E_Q160E_T180E
9060-9756_1	Trastuzumab	Trastuzumab	A139W_L143E_K145T_Q179E	F116A_Q124R_L135V_T178R	Q179K	Q124E_L135W_Q160E_T180E
9066-9335_1	D3H44	Trastuzumab	F122C_L124E	Q124C_V133G_S176R	L124R	V133G_S176D
9116-9349_1	D3H44	Trastuzumab	L124E_A139W	F116A_V133G_L135V_S176R	L124R_A139G_V190A	V133G_L135W_S176D
9118-6098_1	D3H44	Trastuzumab	L124E_H172R	V133G_S176R	L124R_H172T	V133G_S174R_S176D
9121-9373_1	D3H44	Trastuzumab	L124E_H172T	V133G_N137K_S174R_S176R	L124R_H172R	V133G_S176D_T178D
9134-9521_1	Trastuzumab	D3H44	L124E_K145T_Q179E	S131K_V133G_S176R	L124R_S186R	V133G_S176D_T178D
9168-9342_1	Trastuzumab	D3H44	L124E_K228D	S121K_V133G_S176R	L124R_A125R	V133G_S176D
9279-9518_1	D3H44	Trastuzumab	L124E_L143E_K145T	Q124K_V133G_S176R	L124R_S186R	V133G_S176D_T178D
9286-9402_1	D3H44	Trastuzumab	L124E_L143E_K145T	Q124K_V133G_S176R	L124R_Q179K	V133G_S176D_T178E
9327-6054_1	D3H44	Trastuzumab	L124E_L143F	V133G_S176R	L124R	V133G_S176D_T178D
9561-9095_1	D3H44	Trastuzumab	L124W_L143E_K145T_Q179E	Q124R_V133A_S176T_T178R	L124A_L143F_Q179K	Q124E_V133W_S176T_T178L_T180E
9567-9735_1	Trastuzumab	D3H44	L143E_K145T	Q124R	L143R	Q124E_V133E
9611-9077_1	D3H44	Trastuzumab	L143E_K145T_H172R	Q124R_Q160K_T178R	H172T_Q179K	Q124E_N137K_Q160E_S174R_T180E
9667-9830_1	Trastuzumab	D3H44	L143E_K145T_Q179E	Q124R_T178R	S186K	Q124E_Q160E_T178E
9682-9740_1	Trastuzumab	D3H44	L143E_K145T_Q179E	Q124R_T178R	L143R	Q124E_V133E
9692-9846_1	Trastuzumab	D3H44	L143E_K145T_Q179E_S188L	Q124R_T178R	S186K	Q124E_S131T_T178Y_T180E
9696-9848_1	Trastuzumab	D3H44	L143E_K145T_Q179E_S188L	Q124R_T178R	S186K	Q124E_S176L_T180E
9748-9338_1	D3H44	Trastuzumab	L45P_L124E	P44F_V133G_S176R	L124R	V133G_S176D_T178D
9814-9828_1	Trastuzumab	D3H44	Q39E_K145T_Q179E	Q38R_S131K	Q39R_S186R	Q38E_Q124E_Q160E_T180E
9815-9825_1	D3H44	Trastuzumab	Q39E_L124E	Q38R_V133G_S176R	Q39R_L124R	Q38E_V133G_S176D
9820-9823_1	D3H44	Trastuzumab	Q39E_L143E_K145T_Q179E	Q38R_Q124R_Q160K_T178R	Q39R_H172R_Q179K	Q38E_Q124E_Q160E_T180E
9986-9978_1	Trastuzumab	D3H44	L143E_K145T	Q124R_Q160K_T178R	S186K	S131E

\* Kabat numbering. Note that the WT residues refer to the D3H44 system.











9561-9095_1	10	41	47.7	100	73.6	47.9	11.6	44.4	0	0	0	0	0	0	0	0	0	0	0	48.3	1.8	2.3	0	3.3
9121-9373_1	3	10	50.5	100	72.4	48.9	12.6	41.9	0	0	0	0	0	0	0	0	0	0	0	43.8	8.6	5.7	0	0
9116-9349_1	5	6	46.8	100	68.9	44.9	14.1***	34.4	0	0	0	0	0	0	0	0	0	0	0	42.2	11.6	10	0	1.8
9696-9848_1	12	50	100	88	92.8	86.5	57.1	75.6	0.0	0.0	0.0	0.0	0.0	0.0	0.0	0.0	0.0	0.0	0.0	0.0	1.9	0.0	1.8	8.8
9692-9846_1	12	51	100	85	91.4	85.0	55.6	74.9	0.0	0.0	0.0	0.0	0.0	0.0	0.0	0.0	0.0	0.0	0.0	0.0	1.9	0.0	2.5	7.4
9986-9978_1	12	49	100	91	95.6	90.7	61.3	86.0	0.0	0.0	0.0	0.0	0.0	0.0	0.0	0.0	0.0	0.0	0.0	0.0	1.5	0.0	0.0	3.7

\* % considering full Ab species only

\*\* % considering all species

\*\*\* estimated change in % of H1:H2:L1:L2 with respect to wild type

Table 29c. LC-MS pairing data and post pA yields (mg/L) for the heterodimeric antibodies from the trastuzumab (H1L1)/ cetuximab (H2L2) bispecific system

SMCA unique identifier	Cluster	Post pA yield (mg/L A280)	% H1L1 Pairing (over all H1 species)	Change in % H1L1 Pairing (over all H1 species) with respect to wild type	% H2L2 Pairing (over all H2 species)	Change in % H2L2 Pairing (over all H2 species) with respect to wild type	% H1L1 and % H2L2 Pairing (over all species)	H1+ H2+ L1+ L2*	H1+ H1+ L1+ L2**	H1+ H1+ L1+ L2**	H1+ H1+ L1+ L2**	H2+ H2+ L1+ L2**	H2+ H2+ L1+ L2**	H1+ H1+ L1+ L2**	H1+ H1+ L1+ L2**	H1+ H1+ L1+ L2**	H1+ H1+ L1+ L2**	H2+ H2+ L1+ L2**	H2+ H2+ L1+ L2**	H1+ H1+ L1+ L2**	H1+ H1+ L1+ L2**	H2+ H2+ L1+ L2**	H2+ H2+ L1+ L2**	H1+ H1+ L1+ L2**	H1+ H1+ L1+ L2**	H2+ H2+ L1+ L2**	H2+ H2+ L1+ L2**			
9561-9095_2	10	16	100	6.8	100	39.2	100	H1+ H2+ L1+ L2*	H1+ H1+ L1+ L2**	H1+ H1+ L1+ L2**	H1+ H1+ L1+ L2**	H2+ H2+ L1+ L2**	H2+ H2+ L1+ L2**	H1+ H1+ L1+ L2**	H1+ H1+ L1+ L2**	H2+ H2+ L1+ L2**	H2+ H2+ L1+ L2**	H1+ H1+ L1+ L2**	H1+ H1+ L1+ L2**	H2+ H2+ L1+ L2**	H2+ H2+ L1+ L2**	H1+ H1+ L1+ L2**	H1+ H1+ L1+ L2**	H2+ H2+ L1+ L2**	H2+ H2+ L1+ L2**	H1+ H1+ L1+ L2**	H1+ H1+ L1+ L2**	H2+ H2+ L1+ L2**	H2+ H2+ L1+ L2**	
9561-9095_1	10	52	100	2.7***	58.1	33.0***	85.3	53.6 4.3	4.3	0	0	0	0	0	0	0	0	0	0	0	0	0	0	0	0	0	0	0	0	0
9327-6054_1	3	2	98.3	1	91.3	68.5	95.4	74.8 0	0	0	0	0	0	0	0	0	0	0	0	0	0	0	0	0	0	0	0	0	0	0
9327-6054_2	3	8	100	6.8	2.4	-58.4	55.1	2.1 0	0	0	0	0	0	0	0	0	0	0	0	0	0	0	0	0	0	0	0	0	0	0
9168-9342_1	4	36	98.5	1.2***	100	74.9***	98.3	13.4 13.8	13.8	0	0	0	0	0	0	0	0	0	0	0	0	0	0	0	0	0	0	0	0	0
9168-9342_2	4	7	100	6	7.5	-22.1	30	1.8 0	0	0	0	0	0	0	0	0	0	0	0	0	0	0	0	0	0	0	0	0	0	0
9118-6098_1	4	15	100	6	42.2	12.7	87	19 3.1	3.1	0	0	0	0	0	0	0	0	0	0	0	0	0	0	0	0	0	0	0	0	0
9118-6098_2	4	12	100	6.8	15.5	-45.3	50.2	9.9 0	0	0	0	0	0	0	0	0	0	0	0	0	0	0	0	0	0	0	0	0	0	0
9121-9373_2	3	8	100	2.7***	100	74.9***	100	21.7 6.7	6.7	0	0	0	0	0	0	0	0	0	0	0	0	0	0	0	0	0	0	0	0	0
9121-9373_1	3	2	100	6	44	14.4	76.2	34.6 0	0	0	0	0	0	0	0	0	0	0	0	0	0	0	0	0	0	0	0	0	0	0
9116-9349_2	5	2	100	6	79.8	50.3	98	14.6 2.5	2.5	0	0	0	0	0	0	0	0	0	0	0	0	0	0	0	0	0	0	0	0	0
9116-9349_1	5	1	100	2.7***	42.1	17.0***	89.4	15.2 1.5	1.5	0	0	0	0	0	0	0	0	0	0	0	0	0	0	0	0	0	0	0	0	0
9134-9521_2	1	2	100	6	98.8	69.3	99.4	44.3 0	0	0	0	0	0	0	0	0	0	0	0	0	0	0	0	0	0	0	0	0	0	0
9134-9521_1	1	35	100	2.7***	62.5	37.4***	99.3	2 17.8	17.8	0	0	0	0	0	0	0	0	0	0	0	0	0	0	0	0	0	0	0	0	0
9279-9518_2	2	5	100	6.8	33.5	-27.3	87.1	13 3.3	3.3	0	0	0	0	0	0	0	0	0	0	0	0	0	0	0	0	0	0	0	0	0
9286-9402_1	2	11	100	6	100	70.5	100	3.3 7.7	7.7	0	0	0	0	0	0	0	0	0	0	0	0	0	0	0	0	0	0	0	0	0

9286-9402_2	2	8	100	6.8	97.3	36.5	98.7	92.8	37.3	61.8	0	0	0	0	0	0	0	0	0	2.7	0	0	0	30.7
9814-9828_1	6	12	96.4	-0.9***	100	74.9***	96	65.9	39.5***	22.2	11.5	0	0	0	0	0	0	0	0	0	62.3	4	0	0
9814-9828_2	6	16	100	6	18.2	-11.4	35.5	17.9	-8.5	8	0	0	3.2	0	0	0	0	0	0	33.3	0	0	0	44.10.8
9815-9825_1	3	4	100	6	41.5	11.9	68.2	39.8	13.4	34.4	0	0	0	0	0	0	0	0	0	52	0	0	0	5.8
9815-9825_2	3	5	100	2.7***	17.6	-7.5***	64.3	15.8	-10.6***	12.7	0	0	0	0	0	0	0	0	0	67.9	0	0	0	1.9
9748-9338_1	3	1	98.7	4.7	67.7	38.2	93.4	61.5	35.1	23.6	1.7	0	0	0	0	0	0	0	0	11.9	1.3	61.5	0	0
9748-9338_2	3	7	100	2.7***	4.1	-21.0***	54.8	4.4	-22.0***	3.7	0	0	0	0	0	0	0	0	0	81.4	0	10.4	0	4.4
9667-9830_1	11	20	98.5	5.3	100	39.2	99.1	87	31.5	41.9	4.6	0	0	0	0	0	0	0	0	0	1.6	51.8	0	0
9667-9830_2	11	14	100	6	33.3	3.7	55.2	30.7	4.3	19.5	0	0	1.1	0	0	0	0	0	0	42.9	0	0	0	22.14.3
9692-9845_1	12	40	82.3	-10.9	100	39.2	84.9	73.4	17.9	37.1	5.4	2.3	0	0	0	0	0	0	0	0	5.8	38.4	11	0
9692-9845_2	12	25	100	2.7	19.3	-3.5	45	19.1	-1.5	12.5	0	0	2.3	0	0	0	0	0	0	50.5	0	0	0	27.7.3
9696-9848_1	12	40	88.3	-4.9	100	39.2	91.3	76.4	20.9	42.8	4.6	1.9	0	0	0	0	0	0	0	0	6.7	40.1	3.8	0
9696-9848_2	12	24	100	2.7	40.9	18.1	59.1	41.7	21.1	26.3	0	0	1.1	0	0	0	0	0	0	35.6	0	0	0	22
9978_1	12	37	85.9	-7.3	100	39.2	89	73.2	17.7	39	5.9	2	0	0	0	0	0	0	0	0	6.4	39.9	6.8	0
9978_2	12	24	100	6	6.2	-23.4	34.1	5	-21.4	3.1	0	0	4.4	0	0	0	0	0	0	55.3	0	0	0	33.3.4
9611-9077_1	9	28	100	6	NaN	NaN	100	0	-26.4	0	17.3	0	0	0	0	0	0	0	0	0	0	82.7	0	0
9611-9077_2	9	17	100	6.8	91.8	31	94	88.8	33.3	54.8	0	0	0	0	0	0	0	0	0	2.2	4.7	0	0	3.6
9060-9755_2	7	15	100	6.8	100	39.2	99.9	100	44.5	84.7	0	0	0	0	0	0	0	0	0	0	0	10.6	0	0
9060-9755_1	7	41	100	2.7***	96.7	71.6***	98.6	93.9	67.5***	77.2	2.4	0	0	0	0	0	0	0	0	2.6	0	17.7	0	0
9587-9735_1	12	38	93.9	0.7	95.2	34.4	94.7	69.3	13.8	34.2	8.6	1.5	0	0	0	0	0	0	0	1.9	3.2	48.6	2	0
9587-9735_2	12	17	100	6	21.1	-8.4	40.8	18.7	-7.7	9.9	0	0	3.5	1.1	0	0	0	0	0	38.4	0	0	0	36

9682-9740_1	11	31	100	6.8	100	39.2	100	79.1	23.6	36.5	9.7	0	0	0	0	0	0	0	0	53.8	0	0	0	0
9682-9740_2	11	15	100	6	39.7	10.2	56	35.9	9.5	19.3	0	0	0	1.6	1.5	0	31.4	0	0	0	0	26.1	20.2	0
9049-9759_1	11	24	100	6.8	100	39.2	100	100	44.5	84.2	0	0	0	0	0	0	0	0	0	13.5	0	0	0	2.3
9049-9759_2	11	23	100	2.7	25.8	3	79	23.7	3.1	14.6	5	0	0	0	0	0	42	0	0	38.4	0	0	0	0
9066-9335_2	3	4	100	6.8	97	36.2	98.5	92.9	37.4	62.6	0	0	0	0	3.1	1.7	0	0	0	2.3	0	0	0	30.4
9066-9335_1	3	2	100	6	29.5	-0.1	84.8	28.5	2.1	12.7	1.6	0	0	0	0	0	30.3	0	0	55.4	0	0	0	0
3522_1	9	37	100	6.8	100	39.2	100	97.7	42.2	79.7	1.9	0	0	0	0	0	0	0	0	16.1	0	0	0	2.4
3522_2	9	14	98.8	4.8	9.1	-20.5	76.8	5.6	-20.8	3.1	7.6	0	0	0	0	0	43	1.3	0	43.9	0	0	0	1.1
3519_1	6	25	99	1.7***	96.2	71.1***	98.3	87.4	61.0***	57.2	4.9	0	0	0	0	0	2.4	1	0	31.9	0	0	0	2.6
3519_2	6	14	100	6	2.9	-26.7	35.1	2.6	-23.8	1.8	0	0	0	1.9	0	0	64.3	0	0	0	0	0	30.1	1.2
9820-9823_2	8	12	100	2.7***	100	74.9***	100	100	73.6***	84.5	0	0	0	0	0	0	0	0	0	9.9	0	0	0	5.6
9820-9823_1	8	31	100	6	52.3	22.7	83.1	51	24.6	37.1	1.9	0	0	0	0	0	33.8	0	0	27.2	0	0	0	0

\* % considering full Ab species only

\*\* % considering all species

\*\*\* estimated change with respect to wild type





Table 30b. LC-MS pairing of the heterodimeric antibodies from the D3H44 (H1L1)/trastuzumab (H2L2) bispecific system following preparative SEC

SMCA unique identifier	Cluster	Post pA yield (mg/L A280)	% H1L1 pairing (over all H1 species)	% H2L2 pairing (over all H2 species)	% H1L1 and H2L2 pairing (over all species)	H1+H2 +L1+L2 *	H1+H1 +L1+L2 **	H1+H1 +L2+L2 **	H2+H2 +L1+L1 **	H2+H2 +L1+L2 **	H2+H2 +L2+L2 **	H1+H2 +L1+L1 **	H1+H2 +L2+L2 **	H1+H1 +L1+L1 **	H1+H1 +L2+L2 **	H1+H2 +L1+L1 **	H1+H2 +L2+L2 **	H1+H1 +L1+L1 **	H1+H1 +L2+L2 **	H2+H2 +L1+L1 **	H2+H2 +L2+L2 **	H1+H2 +L1+L1 **	H1+H2 +L2+L2 **	H1+H1 +L1+L1 **	H1+H1 +L2+L2 **	H2+H2 +L1+L1 **	H2+H2 +L2+L2 **		
3522_1	9	61	100	97	98.7	83.1	0	0	0	0	0	2.6	0	12.4	0	0	2.6	0	0	0	0	0	0	0	0	0	0	0	0
3519_1	6	53	100	97.5	98.3	79.8	0	0	0	0	0	1.4	0	1.3	0	0	1.4	0	0	0	0	0	0	0	0	0	0	0	0
9748-9338_1	3	10	95.6	96.1	96	85.3	0	0	0	1.1	0	2.7	4.3	4.8	0	0	2.7	4.3	0	0	0	0	0	0	0	0	0	0	0

\* % considering full Ab species only

\*\* % considering all species

\*\*\* estimated change in % of H1:H2:L1:L2 with respect to wild type



Table 31a. Biophysical characterization (antigen binding, thermal stability, UPLC-SEC) of selected designs from the D3H44/traastuzumab system

SMCA unique identifier	Cluster	KD (TF) (M)* KD from mAb construct= 1.02E-11	KD (HER2) (M)* KD from WT one armed antibody = 1.12E-09	DSC (°C) with Fab Tms reported. D3H44 Fab Tm from homodimeric antibody=79°C. Traastuzumab Fab Tm from homodimeric antibody =81°C.	UPLC-SEC (% heterodimer)
NA	WT	Low Response/no binding	Low Response/no binding	81, 81	99.69
NA	WT	Low Response/no binding	8.88E-10	79, 81	99.91
NA	WT	Low Response/no binding	Low Response/no binding	79, 81	100
9279-9518_1	2	2.20E-11	1.54E-09	70, 76	99.95
9815-9825_1	3	3.97E-11	6.98E-10	70, 76	93.1
9748-9338_1	3	2.78E-11	4.80E-10	71, 77	100
9060-9756_1	7	1.72E-11 (1.73-1.73E-11)	9.39E-10 (1.04-0.83E-09)	72, 79	99.6
9682-9740_1	11	8.50E-12	Low Response/no binding	72, 79	99.4
9049-9759_1	11	7.22E-12	Low Response/no binding	72, 79	100
3522_1	9	8.42E-12	Low Response/no binding	79	99.88
3519_1	6	1.61E-11	1.66E-09	72, 81	98.98
9820-9823_1	8	4.65E-11 (5.25-4.07E-11)	7.16E-10 (7.58-6.74E-10)	71, 76	99.68

\* KD values reported are either a single measurement or the average of 2 measurements. The range is indicated in parentheses.

Table 31b. Biophysical characterization (antigen binding, thermal stability, UPLC-SEC) of selected designs from the D3H44/cetuximab system

SMCA unique identifier	Cluster	KD (TF) (M)* KD from WT mAb construct= 1.02E-11	KD (EGFR) (M)* KD from WT one armed antibody= 4.94E-10	DSC (°C). D3H44 Fab Tm from homodimeric antibody= 79°C. Cetuximab Fab Tm from one armed antibody= 72°C.	UPLC-SEC (% heterodimer)
NA	WT	3.62E-11	3.94E-10	72, 79	100
NA	WT	7.93E-12	5.39E-10	71, 80	100
NA	WT	1.40E-11	3.96E-10	71, 79	100
NA	WT	6.33E-12	4.00E-10	71, 79	100
9561-9095_2	10	1.07E-11	4.57E-10	71, 77	99.86
9168-9342_1	4	1.27E-11	2.05E-10	70, 78	93.7
9118-6098_1	4	1.76E-11	4.90E-10	70, 78	100
9121-9373_1	3	1.14E-11	4.35E-10	71, 78	99.6
9121-9373_2	3	9.09E-12	3.18E-10	69, 78	100
9279-9518_2	2	1.06E-11	3.14E-10	70, 78	96
9286-9402_1	2	8.26E-12 (7.9-8.63E-12)	4.18E-10 (4.28-4.09E-10)	71, 78	100
9815-9825_1	3	1.84E-11	5.09E-10	69, 78	100
9815-9825_2	3	1.01E-11	3.70E-10	68, 75	100
9667-9830_1	11	1.31E-11 (1.75-0.8E-11)	2.55E-10 (3.24-1.88E-10)	70, 78	99.86
9667-9830_2	11	1.35E-11	4.55E-10	71, 78	99.54
9611-9077_1	9	1.71E-11	4.55E-10	71, 78	87.16
9060-9756_2	7	1.17E-11	6.43E-10	72, 78	100
9682-9740_1	11	1.22E-11	2.16E-10	70, 78	92
9682-9740_2	11	9.99E-12	6.23E-10	72, 78	99.9
9049-9759_1	11	9.33E-12	6.23E-10	70, 79	100
9066-9335_1	3	4.04E-12	4.46E-10	72, 79	100
9066-9335_2	3	8.41E-12	3.10E-10	70, 78	100
3522_1	9	7.75E-12	2.69E-10	70, 78	99.1
3519_1	6	1.15E-11	2.63E-10	71, 78	99.76
9820-9823_2	8	1.40E-11	2.49E-10	69, 76	100
9820-9823_1	8	1.33E-11 (1.34-1.33E-11)	2.65E-10 (2.47-2.84 E-10)	70, 78	99.77

\* KD values reported are either a single measurement or the average of 2 measurements. The range is indicated in parentheses.

Table 31c. Biophysical characterization (antigen binding, thermal stability, UPLC-SEC) of selected designs from the trastuzumab/cetuximab system

SMCA unique identifier	Cluster	KD (HER2) (M)* KD from WT one armed antibody= 1.12E-09	KD (EGFR) (M)* KD from one armed antibody= 4.94E-10	DSC (°C). Tm values refer to Fab transitions unless otherwise indicated. Tm values qualified with a (?) indicate a new peak not observed in WT. Cetuximab Fab Tm from one armed antibody=72°C. Trastuzumab Fab Tm from homodimeric antibody= 81°C.	UPLC-SEC (% heterodimer)
NA	WT	Low Response/no binding	4.79E-10	71, 81	100
NA	WT	2.36E-10	1.87E-10	71, 81	100
NA	WT	2.04E-10	2.03E-10	71, 81	100
9286-9402_2	2	Low Response/no binding	5.93E-10	71, 80	92.8
9327-6054_1	3	8.18E-10 (8.18E-10-ND)	5.4E-10 (5.24-5.59E-10)	ND**	100
3519_1	6	9.78E-10	4.07E-10	71, 78	99.1
9060-9756_2	7	Low Response/no binding	6.25E-10	71, 81	100
9820-9823_2	8	7.52E-10	5.09E-10	70, 78	100
9611-9077_2	9	Low Response/no binding	4.71E-10	60(?), 71, 81	97.07
3522_1	9	Low Response/no binding	3.95E-10	71, 78	98.97
9561-9095_2	10	Low Response/no binding	4.17E-10	71, 81	99.39
9682-9740_1	11	Low Response/no binding	4.72E-10	72, 81	96.2
9049-9759_1	11	Low Response/no binding	4.77E-10	72, 79	100
9696-9848_1	12	Low Response/no binding	4.49E-10	71, 81	99.3

\* KD values reported are either a single measurement or the average of 2 measurements. The range is indicated in parentheses.

\*\* ND = Not Determined

Table 32a. Effect of DNA titration ratio on the percentage of antibody species, as assessed by LC-M5, of the wild-type D3H44/trastuzumab system. H1 and L1 refer to D3H44 heavy and light chains, respectively. H2 and L2 refer to trastuzumab heavy and light chains, respectively.

H1:H2:L1:L2 DNA ratio	H1+H2+L1+L2 2 (%)	H1+H1+L1+L1 1 (%)	H1+H1+L1+L1 2 (%)	H2+H2+L1+L1 1 (%)	H2+H2+L1+L1 2 (%)	H1+H2+L1+L1 1 (%)	H2+H2+L2+L1 2 (%)	H1+H2+L1+L1 2 (%)	H1+H2+L2+L1 2 (%)	H1+L1 (%)	H1+L2 (%)	H2+L1 (%)	H2+L2 (%)
15:15:53:17	22.8	0.0	0.0	0.0	0.0	0.0	0.0	1.6	59.5	1.9	8.8	1.7	3.8
8:22:53:17	16.4	0.0	0.0	0.0	0.0	0.0	2.9	0.0	45.7	0.0	1.3	10.4	23.3
22:8:53:17	13.3	0.0	3.2	0.0	0.0	0.0	0.0	1.5	28.4	5.9	46.5	0.0	1.2
15:15:35:35	8.9	0.0	0.0	0.0	0.0	0.0	1.5	0.0	74.0	0.0	11.6	0.0	4.0
8:22:35:35	6.1	0.0	0.0	0.0	0.0	0.0	3.1	0.0	51.4	0.0	2.2	5.5	31.8
22:8:35:35	5.6	0.0	4.8	0.0	0.0	0.0	0.0	0.0	48.9	1.3	39.4	0.0	0.0
15:15:17:53	4.1	0.0	0.0	0.0	0.0	0.0	0.0	0.0	82.8	0.0	9.2	0.0	3.9
8:22:17:53	2.8	0.0	0.0	0.0	0.0	0.0	4.6	0.0	54.3	0.0	2.4	2.4	33.5
22:8:17:53	2.7	0.0	4.2	0.0	0.0	0.0	0.0	0.0	51.0	0.0	42.2	0.0	0.0
H1:H2:L1:L2 DNA ratio	H1+H1+L1+L1 1 (%)	H1+H1+L1+L1 2 (%)	H2+H2+L1+L1 1 (%)	H2+H2+L1+L1 2 (%)	H1+H2+L1+L1 1 (%)	H1+H2+L1+L1 2 (%)	H1+H2+L2+L1 1 (%)	H1+H2+L2+L1 2 (%)	H1+L1 (%)	H1+L2 (%)	H2+L1 (%)	H2+L2 (%)	Half Ab (sum %)
15:15:53:17	0.0	0.0	0.0	0.0	0.0	0.0	1.6	59.5	1.9	8.8	1.7	3.8	16.2
8:22:53:17	0.0	0.0	0.0	2.9	0.0	0.0	0.0	45.7	0.0	1.3	10.4	23.3	35.0
22:8:53:17	0.0	3.2	0.0	0.0	0.0	0.0	1.5	28.4	5.9	46.5	0.0	1.2	53.6
15:15:35:35	0.0	0.0	0.0	1.5	0.0	0.0	0.0	74.0	0.0	11.6	0.0	4.0	15.6
8:22:35:35	0.0	0.0	0.0	3.1	0.0	0.0	0.0	51.4	0.0	2.2	5.5	31.8	39.5
22:8:35:35	0.0	4.8	0.0	0.0	0.0	0.0	0.0	48.9	1.3	39.4	0.0	0.0	40.7
15:15:17:53	0.0	0.0	0.0	0.0	0.0	0.0	0.0	82.8	0.0	9.2	0.0	3.9	13.1
8:22:17:53	0.0	0.0	0.0	4.6	0.0	0.0	0.0	54.3	0.0	2.4	2.4	33.5	38.3
22:8:17:53	0.0	4.2	0.0	0.0	0.0	0.0	0.0	51.0	0.0	42.2	0.0	0.0	42.2

Table 32b. Effect of DNA titration ratio on the percentage of antibody species, as assessed by LC-MS, of the wild-type D3H44/cetuximab system. H1 and L1 refer to D3H44 heavy and light chains, respectively. H2 and L2 refer to cetuximab heavy and light chains, respectively.

H1:L2:L1:L2 DNA ratio	H1+H2+L1+L2 (%)	H1+H1+L1+L1 (%)	H1+H1+L1+L2 (%)	H1+H1+L2+L2 (%)	H2+H2+L1+L1 (%)	H2+H2+L1+L2 (%)	H2+H2+L2+L2 (%)	H1+H2+L1+L1 (%)	H1+H2+L2+L2 (%)	H1+L1 (%)	H1+L2 (%)	H2+L1 (%)	H2+L2 (%)	Half Ab (sum %)
15:15:53:17	45.6	0.0	0.0	0.0	0.0	0.0	0.0	0.0	39.2	4.5	6.7	0.0	4.1	15.3
8:22:33:17	37.9	0.0	0.0	0.0	0.0	0.0	0.0	0.0	30.6	0.0	0.0	1.6	29.9	31.5
15:15:35:35	23.5	0.0	0.0	0.0	0.0	0.0	0.0	0.0	54.1	4.5	14.9	0.0	2.9	22.3
8:22:35:35	19.9	0.0	0.0	0.0	0.0	0.0	0.0	0.0	43.9	0.0	0.0	0.0	36.2	36.2
8:22:17:53	15.6	0.0	0.0	0.0	0.0	0.0	0.0	0.0	54.0	0.0	1.4	0.0	29.0	30.4
22:8:53:17	15.5	3.6	5.2	3.2	0.0	0.0	0.0	0.0	19.5	23.7	29.3	0.0	0.0	53.0
22:8:35:35	13.4	1.3	4.3	5.3	0.0	0.0	0.0	0.0	31.4	1.7	42.6	0.0	0.0	44.3
15:15:17:53	10.2	0.0	0.0	2.1	0.0	0.0	0.0	0.0	39.5	5.1	30.1	0.0	13.0	48.2
22:8:17:53	7.2	0.0	2.3	5.4	0.0	0.0	0.0	0.0	30.4	10.3	44.5	0.0	0.0	54.8



Table 32c. Effect of DNA titration ratio on the percentage of antibody species, as assessed by LC-MS, of the wild-type trastuzumab/cetuximab system. H1 and L1 refer to trastuzumab heavy and light chains, respectively. H2 and L2 refer to cetuximab heavy and light chains, respectively.

H1:L2:L1:L2 DNA ratio	H1+H2+L1+L2 (%)	H1+H1+L1+L1 (%)	H1+H1+L1+L2 (%)	H1+H1+L2+L2 (%)	H2+H2+L1+L1 (%)	H2+H2+L1+L2 (%)	H2+H2+L2+L2 (%)	H1+H2+L1+L1 (%)	H1+H2+L2+L2 (%)	H1+L1 (%)	H1+L2 (%)	H2+L1 (%)	H2+L2 (%)	Half Ab (sum %)
15:15:17:53	42.1	0.0	0.0	0.0	0.0	0.0	0.0	35.2	3.9	9.8	1.3	4.3	3.4	18.8
15:15:35:35	28.2	0.0	0.0	0.0	0.0	0.0	0.0	58.1	0.0	6.5	0.0	5.2	1.9	13.7
8:22:17:53	24.7	0.0	0.0	0.0	0.0	0.0	0.0	28.2	1.9	0.0	0.0	22.3	23.0	45.3
22:8:17:53	20.5	5.3	0.0	0.0	0.0	0.0	0.0	13.7	3.2	49.1	8.2	0.0	0.0	57.3
15:15:53:17	19.7	0.0	0.0	0.0	0.0	0.0	0.0	63.8	0.0	8.7	0.0	6.5	1.4	16.6
8:22:35:35	15.2	0.0	0.0	0.0	0.0	0.0	1.5	37.7	0.0	0.0	0.0	31.1	14.5	45.6
22:8:35:35	14.4	8.3	0.0	0.0	0.0	0.0	0.0	28.1	0.0	47.7	1.4	0.0	0.0	49.1
22:8:53:17	10.3	9.7	0.0	0.0	0.0	0.0	0.0	30.7	0.0	49.3	0.0	0.0	0.0	49.3
8:22:53:17	10.3	0.0	0.0	0.0	0.0	0.0	2.2	39.1	0.0	0.0	0.0	36.6	11.8	48.4



\*\* % considering all species



Table 33c. LC-MS pairing for the wild type antibody constructs from the trastuzumab (H1L1)/ cetuximab (H2L2) bispecific system

Tag	Post PA yield (ng/L A280)	% H1L1 Pairing (over all H1 species)	% H2L2 Pairing (over all H2 species)	% H1L1 and % H2L2 Pairing (over all species)	H1+H2 +L1+L2 *	Change in % of H1:H2:L1:L2 with respect to median wild type*	H1+H1 +L1+L1 **	H1+H1 +L1+L2 **	H1+H1 +L2+L2 **	H2+H2 +L1+L1 **	H2+H2 +L1+L2 **	H2+H2 +L2+L2 **	H1+H2 +L1+L1 **	H1+H2 +L2+L2 **	H1+ H1+L1 **	H1+ H1+L2 **	H1+ H2+L1 **	H1+ H2+L2 **	H1+ H1+L1+L2 ***	H1+ H1+L2+L2 ***	H1+ H2+L1+L2 ***	H1+ H2+L2+L2 ***	H2+ H1+L1+L2 ***	H2+ H1+L2+L2 ***	H2+ H2+L1+L2 ***	H2+ H2+L2+L2 ***	
FLAG on trastuzumab LC	19	92.7	60.3	76.8	55.5	0	0	0	0	0	0	0	30.6	4.5	12	2.3	3.5	3.3									
FLAG on trastuzumab LC	22	91.8	60.8	76.8	55.3	-0.2	0	0	0	0	0	0	29.1	5.1	14.2	2.5	3.5	3.2									
FLAG on trastuzumab LC	19	93.1	60.1	76.3	55.5	0	0	0	0	0	0	0	30.8	4.7	10.5	1.6	4.2	3.8									
FLAG on cetuximab LC	19	92.2	29.6	61.3	25.8	-0.6	0	0	0	0	0	0	56.6	3.2	8.8	4.1	4.8	1.8									
FLAG on cetuximab LC	20	92.6	29.4	61	25.9	-0.5	0	0	0	0	0	0	57.2	3.3	8	3.6	5.1	1.6									
FLAG on cetuximab LC	15	94	24.6	60.9	23.9	-2.5	0	0	0	0	0	0	60.4	1.6	10.5	4.2	3.9	0									
HA on cetuximab LC	18	97.3	21.5	59.9	19.4	-1.2	0	0	0	0	0	0	66.4	1.1	7.7	1.4	5	2.1									
HA on cetuximab LC	22	97.3	22.5	59.8	20.2	-0.4	0	0	0	0	0	0	65.4	1.2	7.1	1.3	5.7	2.5									
HA on cetuximab LC	20	98.4	18.7	59.7	18	-2.6	0	0	0	0	0	0	68.1	0	8.8	1.5	4.9	1.9									

\* % considering full Ab species only

\*\* % considering all species

Table 34. Stabilizing mutations in Fab heterodimers

Chain including the stabilizing mutation (H for heavy chain; L for light chain)	Stabilizing mutation	dTm (°C, i.e. Tm of Fab with stabilizing mutation - Tm of Fab lacking the stabilizing mutation)	H1L1 of LCCA Set # (including stabilizing mutation)**	H1 mutation (of Fab with stabilizing mutation)	L1 mutation (of Fab with stabilizing mutation)*	H1L1 of LCCA Set # (lacking stabilizing mutation)**	H1 (of Fab lacking stabilizing mutation)*	L1 (of Fab lacking stabilizing mutation)*
H	Q39R	1.6	9824	Q39R_H172R_S186R	Q38E_Q124E_Q160E_T180E	9075	H172R_S186R	Q38E_Q124E_Q160E_T180E
H	Q39R	1.4	9822	Q39R_D146G_Q179K	Q38E_Q124E_Q160E_T180E	9065	D146G_Q179K	Q38E_Q124E_Q160E_T180E
H	Q39R	1.2	9828	Q39R_S186R	Q38E_Q124E_Q160E_T180E	9905	S186R	Q38E_Q124E_Q160E_T180E
H	Q39R	1.1	9821	Q39R_D146G_H172R_Q179K	Q38E_Q124E_Q160E_T180E	9064	D146G_H172R_Q179K	Q38E_Q124E_Q160E_T180E
H	V190F	1.0	9912 9913 9914	S188L_V190F	WT	9907 9909 9911	S188L	WT
H	H172R	2.1	9813	Q39E_K145T_H172R_Q179E	Q38R_S131K	9814	Q39E_K145T_Q179E	Q38R_S131K
H	H172R	2.0	9611	L143E_K145T_H172R	Q124R_Q160K_T178R	9590 9593 9594 9598 9602 9606 9609 9986	L143E_K145T	Q124R_Q160K_T178R
H	H172R	1.7	9824	Q39R_H172R_S186R	Q38E_Q124E_Q160E_T180E	9928	Q39R_S186R	Q38E_Q124E_Q160E_T180E
H	H172R	1.5	NA	H172R	WT	9045 9046 9047 9048	WT	WT
H	H172R	1.5	9111	L124E_A125S_H172R_K228D	S121K_V133G_S176R	9113 9114	L124E_A125S_K228D	S121K_V133G_S176R
H	H172R	1.3	9075	H172R_S186R	Q38E_Q124E_Q160E_T180E	9905	S186R	Q38E_Q124E_Q160E_T180E
H	H172R	1.3	10552 9752	L45P_L143E_K145T_H172R	P44F_Q124R_Q160K_T178R	10550 9751	L45P_L143E_K145T	P44F_Q124R_Q160K_T178R
H	H172R	1.3	9118 9119	L124E_H172R	V133G_S176R	9109 9110	L124E	V133G_S176R
H	H172R	1.3	9610	L143E_K145T_H172R	Q124R	9585 9587 9588 9589	L143E_K145T	Q124R
H	H172R	1.2	NA	H172R	WT	9045 9046 9047 9048	WT	WT
H	H172R	1.2	9074	H172R_Q179K	Q124E_Q160E_T180E	9759 9760 9761 9763 9766 9767 9769 9771 9772 9773	Q179K	Q124E_Q160E_T180E
H	H172R	1.2	9818	Q39E_L143E_K145T_H172R	Q38R_Q124R_Q160K_T178R	9817	Q39E_L143E_K145T	Q38R_Q124R_Q160K_T178R
H	H172R	1.1	9346	L124R_A125R_H172R	V133G_S176D	9342	L124R_A125R	V133G_S176D
H	H172R	1.1	9612	L143E_K145T_H172R_Q179E	Q124R_T178R	9663 9666 9667 9671 9675 9679 9682 9989	L143E_K145T_Q179E	Q124R_T178R
H	H172R	1.1	9819	Q39E_L143E_K145T_H172R_Q179E	Q38R_Q124R_Q160K_T178R	9820	Q39E_L143E_K145T_Q179E	Q38R_Q124R_Q160K_T178R
H	H172R	1.0	9117	L124E_H172R	V133S_S176K	9106 9107 9108	L124E	V133G_S176K
H	H172R	0.9	9064	D146G_H172R_Q179K	Q38E_Q124E_Q160E_T180E	9065	D146G_Q179K	Q38E_Q124E_Q160E_T180E
H	H172R	0.9	10551 9745	L45P_K145T_H172R_Q179E	P44F_S131K	10549 9746	L45P_K145T_Q179E	P44F_S131K
H	H172R	0.7	9753	L45P_L143E_K145T_H172R_Q179E	P44F_Q124R_Q160K_T178R	9754	L45P_L143E_K145T_Q179E	P44F_Q124R_Q160K_T178R
H	H172R	0.6	9821	Q39R_D146G_H172R_Q179K	Q38E_Q124E_Q160E_T180E	9822	Q39R_D146G_Q179K	Q38E_Q124E_Q160E_T180E
H	H172R	0.6	9826	Q39R_L124R_H172R	Q38E_V133G_S176D	9825	Q39R_L124R	Q38E_V133G_S176D
H	H172R	0.5	9816	Q39E_L124E_H172R	Q38R_V133G_S176R	9815	Q39E_L124E	Q38R_V133G_S176R

H	H172R	0.4	9749 9750	L145P L124E H172R	P44F V133G S176R	9747 9748	L145P L124E	P44F V133G S176R
H	Q179E	0.8	9754	L145P L143E_K145T_Q179E	P44F_Q124R_Q160K_T178R	10550 9751	L145P L143E_K145T	P44F_Q124R_Q160K_T178R
H	Q179E	0.7	9820	Q39E_L143E_K145T_Q179E	Q38R_Q124R_Q160K_T178R	9817	Q39E_L143E_K145T	Q38R_Q124R_Q160K_T178R
H	Q179E	0.6	9819	Q39E_L143E_K145T_H172R_Q179E	Q38R_Q124R_Q160K_T178R	9818	Q39E_L143E_K145T_H172R	Q38R_Q124R_Q160K_T178R
H	Q179E	0.6	9651 9654 9988	L143E_K145T_Q179E	Q124R_Q160K_T178R	9590 9593 9594 9598 9602 9606 9609 9986	L143E_K145T	Q124R_Q160K_T178R
H	Q179E	0.5	9687	L143E_K145T_Q179E_S188L	Q124R_Q160K_T178R	9707 9708 9712 9716 9720 9721 9722 9723 9725	L143E_K145T_S188L	Q124R_Q160K_T178R
H	Q179D	0.6	9620 9623	L143E_K145T_Q179D	Q124R_Q160K_T178R	9590 9593 9594 9598 9602 9606 9609 9986	L143E_K145T	Q124R_Q160K_T178R
H	Q179D	0.5	9614 9617	L143E_K145T_Q179D	Q124K_T178R	NA	L143E_K145T	Q124K_T178R
H	Q179D	0.5	9632 9635	L143E_K145T_Q179D	Q124R_T178R	9987	L143E_K145T	Q124R_T178R
H	S188L	1.2	9688 9692 9696 9700 9702	L143E_K145T_Q179E_S188L	Q124R_T178R	9663 9666 9667 9671 9675 9679 9682 9989	L143E_K145T_Q179E	Q124R_T178R
H	S188L	1.0	9707 9708 9712 9716 9720 9721 9722 9723 9725	L143E_K145T_S188L	Q124R_Q160K_T178R	9590 9593 9594 9598 9602 9606 9609 9986	L143E_K145T	Q124R_Q160K_T178R
H	S188L	0.9	9687	L143E_K145T_Q179E_S188L	Q124R_Q160K_T178R	9651 9654 9988	L143E_K145T_Q179E	Q124R_Q160K_T178R
H	S188L	0.8	9703 9704 9705 9706	L143E_K145T_S188L	Q124R	9585 9587 9588 9589	L143E_K145T	Q124R
H	S188L	0.4	9644	L143E_K145T_Q179D_S188L	Q124R_Q160K_T178R	9620 9623	L143E_K145T_Q179D	Q124R_Q160K_T178R
H	A125R	0.6	9346	L124R_A125R_H172R	V133G_S176D	9369 9370 9371	L124R_H172R	V133G_S176D
H	A125R	0.4	NA	A125R	WT	9045 9046 9047 9048	WT	WT
H	L143F	0.4	9566 9567	L124W_L143F	V133A	NA	L124W	V133A
L	Q124R	0.9	9632 9635	L143E_K145T_Q179D	Q124R_T178R	9638 9641	L143E_K145T_Q179D	T178R
L	Q124R	0.8	9663 9666 9667 9671 9675 9679 9682 9989	L143E_K145T_Q179E	Q124R_T178R	9683 9684	L143E_K145T_Q179E	T178R
L	Q160F	0.6	9741	L143R	Q124E_V133E_Q160F	9735 9737 9740	L143R	Q124E_V133E
L	S176L	1.0	9055 9056 9057	A139G_V190A	L135W_S176L	NA	A139G_V190A	L135W
L	S176L	0.6	9885 9886	S186R	Q124E_S176L_T180E	9891 9893 9896 9898 9900 9901	S186R	Q124E_T180E
L	S176L	0.5	9847 9848	S186K	Q124E_S176L_T180E	9853 9855 9858 9860 9862 9863	S186K	Q124E_T180E
L	S176L	0.4	9781 9782	Q179K	Q124E_S176L_T180E	9787 9789 9792 9794 9796 9797	Q179K	Q124E_T180E
L	Q124E	0.5	9891 9893 9896 9898 9900 9901	S186R	Q124E_T180E	NA	S186R	T180E
L	Q124E	0.4	9869 9871 9874 9876 9878 9879	S186R	Q124E_Q160E_T180E	NA	S186R	Q160E_T180E

L	T180E	0.5	9785 9786	Q179K	Q124E T178E T180E	9783 9784	Q179K	Q124E T178E
---	-------	-----	-----------	-------	-------------------	-----------	-------	-------------

\*WT refers to wild type

\*\* NA refers to not applicable due to no corresponding LCCA set #.









		A280)	species )	(over all H1 species) with respect to wild type	species )	(over all H2 species) with respect to wild type	(over all species )	with respect to wild type*															
D3H44/ cetuximab	9327- 6054_1	3	100.0	36.1	100.0	2.0	100.0	92.5	32.5	44.2	3.6	0.0	0.0	0.0	0.0	0.0	0.0	0.0	52.3	0.0	0.0	0.0	0.0
D3H44/ trastuzumab	9327- 6054_1	3	96.1	55.5	84.1	-8.9	90.1	79.9	43.5	79.0	0.0	0.0	0.0	1.6	0.0	14.4	3.8	1.2	0.0	0.0	0.0	0.0	0.0
trastuzumab/ cetuximab	9327- 6054_1	3	98.3	1.0	91.3	68.5	95.4	89.1	68.5	74.8	0.0	0.0	0.0	0.0	0.0	7.6	1.6	12.7	0.0	0.0	0.0	0.0	3.3
D3H44/ cetuximab	9815- 9825_1	3	100.0	38.1	100.0	2.0	100.0	100.0	40.0	89.4	0.0	0.0	0.0	0.0	0.0	0.0	0.0	7.6	0.0	0.0	0.0	0.0	3.0
D3H44/ cetuximab	9815- 9825_2	3	100.0	43.3***	100.0	1.6***	100.0	100.0	42.1** *	86.0	0.0	0.0	0.0	0.0	0.0	0.0	0.0	7.4	0.0	0.0	0.0	0.0	6.6
D3H44/ trastuzumab	9815- 9825_1	3	76.4	35.8	100.0	7.0	85.3	77.5	41.2	61.8	0.0	0.0	0.0	0.0	0.0	0.0	17.9	14.6	5.7	0.0	0.0	0.0	
trastuzumab/ cetuximab	9815- 9825_1	3	100.0	6.0	41.5	11.9	68.2	39.8	13.4	34.4	0.0	0.0	0.0	0.0	0.0	52.0	0.0	1.2	0.0	0.0	0.0	5.8	
D3H44/ cetuximab	9587- 9735_1	12	100.0	43.3***	100.0	1.6***	99.9	96.8	38.9** *	71.2	0.0	0.0	0.0	0.0	2.3	0.0	0.0	0.0	0.0	0.0	0.0	0.0	26.4
D3H44/ cetuximab	9587- 9735_2	12	91.5	29.6	100.0	2.0	92.0	73.9	13.9	39.2	10.7	1.0	0.0	0.0	0.0	0.0	2.1	40.5	6.4	0.0	0.0	0.0	
D3H44/ trastuzumab	9587- 9735_1	12	89.2	51.9	88.7	-2.1	87.3	80.6	51.2	59.6	0.0	0.0	0.0	0.0	1.5	6.4	6.5	2.4	1.8	4.6	1.7.3	0.0	
trastuzumab/ cetuximab	9587- 9735_1	12	93.9	0.7	95.2	34.4	94.7	69.3	13.8	34.2	8.6	1.5	0.0	0.0	0.0	1.9	3.2	48.6	2.0	0.0	0.0	0.0	
D3H44/ cetuximab	3522_1	9	100.0	43.3***	100.0	1.6***	100.0	89.6	31.7** *	53.4	6.2	0.0	0.0	0.0	0.0	0.0	0.0	40.4	0.0	0.0	0.0	0.0	
D3H44/ cetuximab	3522_2	9	88.1	26.2	100.0	2.0	95.8	84.6	24.5	58.2	0.0	0.0	0.0	0.0	2.5	0.0	8.1	1.8	0.0	0.0	0.0	29.3	
D3H44/ trastuzumab	3522_1	9	100.0	62.7	94.8	4.0	98.0	91.6	62.2	74.0	2.8	0.0	0.0	1.1	0.0	3.0	0.0	19.2	0.0	0.0	0.0	0.0	
trastuzumab/ cetuximab	3522_1	9	100.0	6.8	100.0	39.2	100.0	97.7	42.2	79.7	1.9	0.0	0.0	0.0	0.0	0.0	0.0	16.1	0.0	0.0	0.0	2.4	
D3H44/ cetuximab	3519_1	6	100.0	43.3***	98.3	-0.1***	99.2	96.6	38.7** *	80.4	1.2	0.0	0.0	1.6	0.0	0.0	0.0	8.4	0.0	0.0	0.0	8.4	
D3H44/ cetuximab	3519_2	6	75.5	13.6	100.0	2.0	82.8	67.2	7.2	42.1	4.0	2.2	0.0	0.0	0.0	0.0	14.4	26.4	9.0	0.0	0.0	2.0	
D3H44/ trastuzumab	3519_1	6	100.0	62.7	96.3	5.5	97.2	92.9	63.5	65.1	0.0	0.0	0.0	0.0	3.3	1.7	0.0	2.1	0.0	0.0	2.0	2.5.8	



**CLAIMS**

We Claim:

1. An isolated antigen binding polypeptide construct comprising at least a first heterodimer and a second heterodimer,

the first heterodimer comprising a first immunoglobulin heavy chain polypeptide sequence (H1), and a first immunoglobulin light chain polypeptide sequence (L1); and the second heterodimer comprising a second immunoglobulin heavy chain polypeptide sequence (H2), and a second immunoglobulin light chain polypeptide sequence (L2), wherein at least one of the H1 or L1 sequences of the first heterodimer is distinct from the corresponding H2 or L2 sequence of the second heterodimer, and wherein

H1 and H2 each comprise at least a heavy chain variable domain ( $V_H$  domain) and a heavy chain constant domain ( $C_{H1}$  domain);

L1 and L2 each comprise at least a light chain variable domain ( $V_L$  domain) and a light chain constant domain ( $C_L$  domain); and

at least one of H1, H2, L1, and L2 comprises at least one amino acid modification, wherein H1 preferentially pairs with L1 as compared to L2 and H2 preferentially pairs with L2 as compared to L1; or

H1, H2, L1, and L2 comprise a set of amino acid modifications, wherein H1 preferentially pairs with L1 as compared to L2 and H2 preferentially pairs with L2 as compared to L1;

wherein the thermal stability of the Fab region as measured by the melting temperature ( $T_m$ ) of at least one of the first and second heterodimers is within about 0, 1, 2, 3, 4, 5, 6, 7, 8, 9, or 10°C of the  $T_m$  of the corresponding heterodimer without the at least one amino acid modification or set of amino acid modifications.

2. The construct of claim 1, wherein

(i) H1 and/or H2 comprises at least one or a set of amino acid modifications at L124, K145, D146, Q179, and S186, and

(ii) L1 and/or L2 comprises at least one or a set of amino acid modifications at Q124, S131, V133, Q160, S176, T178, and T180.

3. The construct of claim 2, wherein

(i) H1 and/or H2 comprises at least one or a set of amino acid modifications selected from L124R, L124E, K145M, K145T, D146N, Q179E, Q179K, S186R, and S186K, and

(ii) L1 and/or L2 comprises at least one or a set of amino acid modifications selected from Q124E, S131R, S131K, V133G, Q160E, S176R, S176D, T178D, T178E, and T180E.

4. The construct of claim 3, wherein:

H1 comprises amino acid modifications selected from the group consisting of L124E, K145M, K145T, and Q179E, or a combination thereof;

L1 comprises amino acid modifications selected from the group consisting of S131R, S131K, V133G, and S176R, or a combination thereof;

H2 comprises amino acid modifications selected from the group consisting of L124R, D146N, Q179K, S186R, and S186K, or a combination thereof; and

L2 comprises amino acid modifications selected from the group consisting of Q124E, V133G, Q160E, S176D, T178D, T178E, and T180E, or a combination thereof.

5. The construct of claim 4, wherein:

H1 comprises the amino acid modifications L124E, K145T, and Q179E;

L1 comprises the amino acid modifications S131K, V133G, and S176R;

H2 comprises the amino acid modifications L124R and S186R; and

L2 comprises the amino acid modifications V133G, S176D, and T178D.

6. The construct of claim 1, wherein

(i) H1 and/or H2 comprises at least one or a set of amino acid modifications at L124, L143, K145, D146, Q179, and S186; and

(ii) L1 and/or L2 comprises at least one or a set of amino acid modifications at Q124, V133, Q160, S176, T178, and T180.

7. The construct of claim 6, wherein

(i) H1 and/or H2 comprises at least one or a set of amino acid modifications selected from L124E, L124R, L143E, L143D, K145T, K145M, D146N, Q179K, S186R, and S186K; and

(ii) L1 and/or L2 comprises at least one or a set of amino acid modifications selected from Q124K, Q124E, V133G, Q160K, S176R, S176D, T178E, T178K, T178R, T178D, and T180E.

8. The construct of claim 7, wherein:

H1 comprises amino acid modifications selected from the group consisting of L124E, L143E, L143D, K145T, and K145M, or combinations thereof;

L1 comprises amino acid modifications selected from the group consisting of Q124K, V133G, Q160K, S176R, T178K, and T178R, or combinations thereof;

H2 comprises amino acid modifications selected from the group consisting of L124R, D146N, Q179K, S186R, and S186K, or combinations thereof; and

L2 comprises amino acid modifications selected from the group consisting of Q124E, V133G, S176D, T178E, T178D, and T180E, or combinations thereof.

9. The construct of claim 8, wherein:

H1 comprises the amino acid modifications L124E, L143E, and K145T;



L1 comprises the amino acid modifications Q124K, V133G, and S176R;

H2 comprises the amino acid modifications L124R and Q179K; and

L2 comprises the amino acid modifications V133G, S176D, and T178E.

10. The construct of claim 8, wherein:

H1 comprises the amino acid modifications L124E, L143E, and K145T;

L1 comprises the amino acid modifications Q124K, V133G, and S176R;

H2 comprises the amino acid modifications L124R and S186R; and

L2 comprises the amino acid modifications V133G, S176D, and T178D.

11. The construct of claim 1, wherein

(i) H1 and/or H2 comprises at least one or a set of amino acid modifications at Q39, L45, L124, L143, F122, and H172, and

(ii) L1 and/or L2 comprises at least one or a set of amino acid modifications at Q38, P44, Q124, S131, V133, N137, S174, S176, and T178.

12. The construct of claim 11, wherein

(i) H1 and/or H2 comprises at least one or a set of amino acid modifications selected from Q39E, Q39R, L45P, F122C, L124E, L124R, L143F, H172T, and H172R; and

(ii) L1 and/or L2 comprises at least one or a set of amino acid modifications selected from Q38R, Q38E, P44F, Q124C, S131T, S131E, V133G, N137K, S174R, S176R, S176K, S176D, T178Y, and T178D.

13. The construct of claim 12, wherein

H1 comprises amino acid modifications selected from the group consisting of Q39E, L45P, F122C, L124E, L143F, H172T, and H172R or combinations thereof;

L1 comprises amino acid modifications selected from the group consisting of Q38R, P44F, Q124C, S131T, V133G, N137K, S174R, S176R, S176K, and T178Y, or combinations thereof;

H2 comprises amino acid modifications selected from the group consisting of Q39R, L124R, and H172R, or combinations thereof; and

L2 comprises amino acid modifications selected from the group consisting of Q38E, S131E, V133G, S176D, and T178D, or combinations thereof.

14. The construct of claim 13, wherein:

H1 comprises the amino acid modifications Q39E and L124E;

L1 comprises the amino acid modifications Q38R, V133G, and S176R;

H2 comprises the amino acid modifications Q39R and L124R; and

L2 comprises the amino acid modifications Q38E, V133G, and S176D.

15. The construct of claim 13, wherein:

H1 comprises the amino acid modifications L45P and L124E;

L1 comprises the amino acid modifications P44F, V133G, and S176R;

H2 comprises the amino acid modification L124R; and

L2 comprises the amino acid modifications V133G, S176D, and T178D.

16. The construct of claim 13, wherein:

H1 comprises the amino acid modifications L124E and L143F;

L1 comprises the amino acid modifications V133G, and S176R;

H2 comprises the amino acid modification L124R; and

L2 comprises the amino acid modifications V133G, S176D, and T178D.

17. The construct of claim 13, wherein:

H1 comprises the amino acid modifications F122C and L124E;

L1 comprises the amino acid modifications Q124C, V133G, and S176R;

H2 comprises the amino acid modification L124R; and

L2 comprises the amino acid modifications V133G and S176D.

18. The construct of claim 13, wherein:

H1 comprises the amino acid modifications L124E and H172T;

L1 comprises the amino acid modifications V133G, N137K, S174R, and S176R;

H2 comprises the amino acid modification L124R and H172R; and

L2 comprises the amino acid modifications V133G, S176D, and T178D.

19. The construct of claim 1, wherein

(i) H1 and/or H2 comprises at least one or a set of amino acid modifications at L124, A125, H172, and K228, and

(ii) L1 and/or L2 comprises at least one or a set of amino acid modifications at S121, V133, N137, S174, S176, and T178.

20. The construct of claim 19, wherein

(i) H1 and/or H2 comprises at least one or a set of amino acid modifications selected from L124E, L124R, A125S, A125R, H172R, H172T, and K228D; and

(ii) L1 and/or L2 comprises at least one or a set of amino acid modifications selected from S121K, V133G, N137K, S174R, S176K, S176R, S176D, and T178D.

21. The construct of claim 20, wherein

H1 comprises amino acid modifications selected from the group consisting of L124E, A125S, H172R, and K228D or combinations thereof;

L1 comprises amino acid modifications selected from the group consisting of S121K, V133G, and S176R, or combinations thereof;

H2 comprises amino acid modifications selected from the group consisting of L124R, A125R, and H172T, or combinations thereof; and

L2 comprises amino acid modifications selected from the group consisting of V133G, N137K, S174R, S176D, and T178D, or combinations thereof.

22. The construct of claim 21, wherein:

H1 comprises the amino acid modifications L124E and K228D;

L1 comprises the amino acid modifications S121K, V133G, and S176R;

H2 comprises the amino acid modifications L124R and A125R; and

L2 comprises the amino acid modifications V133G and S176D.

23. The construct of claim 21, wherein:

H1 comprises the amino acid modifications L124E and H172R;

L1 comprises the amino acid modifications V133G and S176R;

H2 comprises the amino acid modifications L124R and H172T; and

L2 comprises the amino acid modifications V133G, S174R, and S176D.

24. The construct of claim 1, wherein

(i) H1 and/or H2 comprises at least one or a set of amino acid modifications at L124, A139, and V190, and

(ii) L1 and/or L2 comprises at least one or a set of amino acid modifications at F116, V133, L135, and S176.

25. The construct of claim 24, wherein

(i) H1 and/or H2 comprises at least one or a set of amino acid modifications selected from L124E, L124R, A139W, A139G, and V190A; and

(ii) L1 and/or L2 comprises at least one or a set of amino acid modifications selected from F116A, V133G, L135V, L135W, S176R, and S176D.

26. The construct of claim 25, wherein

H1 comprises amino acid modifications selected from the group consisting of L124E and A139W, or combinations thereof;

L1 comprises amino acid modifications selected from the group consisting of F116A, V133G, L135V, and S176R, or combinations thereof;

H2 comprises amino acid modifications selected from the group consisting of L124R, A139G, and V190A, or combinations thereof; and

L2 comprises amino acid modifications selected from the group consisting of V133G, L135W, and S176D, or combinations thereof.

27. The construct of claim 26, wherein:

H1 comprises the amino acid modifications L124E and A139W;

L1 comprises the amino acid modifications F116A, V133G, L135V, and S176R;

H2 comprises the amino acid modifications L124R, A139G, and V190A; and

L2 comprises the amino acid modifications V133G, L135W, and S176D.

28. The construct of claim 1, wherein

(i) H1 and/or H2 comprises at least one or a set of amino acid modifications at Q39, L45, K145, H172, Q179 and S186, and

(ii) L1 and/or L2 comprises at least one or a set of amino acid modifications at Q38, P44, Q124, S131, Q160, T180 and C214.

29. The construct of claim 28, wherein

(i) H1 and/or H2 comprises at least one or a set of amino acid modifications selected from Q39E, Q39R, L45P, K145T, H172R, Q179E and S186R; and

(ii) L1 and/or L2 comprises at least one or a set of amino acid modifications selected from Q38R, Q38E, P44F, Q124E, S131K, Q160E, T180E and C214S.

30. The construct of claim 29, wherein

H1 comprises amino acid modifications selected from the group consisting of Q39E, L45P, K145T, H172R, and Q179E, or combinations thereof;

L1 comprises amino acid modifications selected from the group consisting of Q38R, P44F, and S131K, or combinations thereof;

H2 comprises amino acid modifications selected from the group consisting of Q39R, H172R, and S186R, or combinations thereof; and

L2 comprises amino acid modifications selected from the group consisting of Q38E, Q124E, Q160E, T180E and C214S, or combinations thereof.

31. The construct of claim 30, wherein:

H1 comprises the amino acid modifications Q39E, K145T, and Q179E;

L1 comprises the amino acid modifications Q38R and S131K;

H2 comprises the amino acid modifications Q39R and S186R; and

L2 comprises the amino acid modifications Q38E, Q124E, Q160E, and T180E.

32. The construct of claim 30, wherein:

H1 comprises the amino acid modifications L45P, K145T, H172R, and Q179E;

L1 comprises the amino acid modifications P44F and S131K;

H2 comprises the amino acid modifications H172R and S186R; and

L2 comprises the amino acid modifications Q124E, Q160E, and T180E.

33. The construct of claim 1, wherein

(i) H1 and/or H2 comprises at least one or a set of amino acid modifications at A139, L143, K145, Q179 and V190, and

(ii) L1 and/or L2 comprises at least one or a set of amino acid modifications at F116, Q124, L135, Q160, T178, and T180.

34. The construct of claim 33, wherein

(i) H1 and/or H2 comprises at least one or a set of amino acid modifications selected from A139W, A139G, L143E, K145T, Q179E, Q179K, and V190A; and

(ii) L1 and/or L2 comprises at least one or a set of amino acid modifications selected from F116A, Q124R, Q124E, L135V, L135W, Q160E, T178R, and T180E.

35. The construct of claim 34, wherein

H1 comprises amino acid modifications selected from the group consisting of A139W, L143E, K145T, and Q179E, or combinations thereof;

L1 comprises amino acid modifications selected from the group consisting of F116A, Q124R, L135V, and T178R, or combinations thereof;

H2 comprises amino acid modifications selected from the group consisting of A139G, Q179K, and V190A, or combinations thereof; and

L2 comprises amino acid modifications selected from the group consisting of Q124E, L135W, Q160E, and T180E, or combinations thereof.

36. The construct of claim 35 wherein:

H1 comprises the amino acid modifications A139W, L143E, K145T, and Q179E;

L1 comprises the amino acid modifications F116A, Q124R, L135V, and T178R;

H2 comprises the amino acid modification Q179K; and

L2 comprises the amino acid modifications Q124E, L135W, Q160E, and T180E.

37. The construct of claim 1, wherein

(i) H1 and/or H2 comprises at least one or a set of amino acid modifications at Q39, L143, K145, D146, H172, and Q179, and

(ii) L1 and/or L2 comprises at least one or a set of amino acid modifications at Q38, Q124, Q160, T178, and T180.

38. The construct of claim 37, wherein

(i) H1 and/or H2 comprises at least one or a set of amino acid modifications selected from Q39E, Q39R, L143E, K145T, D146G, H172R, Q179E, and Q179K; and

(ii) L1 and/or L2 comprises at least one or a set of amino acid modifications selected from Q38R, Q38E, Q124R, Q124E, Q160K, Q160E, T178R, and T180E.

39. The construct of claim 38, wherein

H1 comprises amino acid modifications selected from the group consisting of Q39E, L143E, K145T, H172R, and Q179E, or combinations thereof;



L1 comprises amino acid modifications selected from the group consisting of Q38R, Q124R, Q160K, and T178R, or combinations thereof;

H2 comprises amino acid modifications selected from the group consisting of Q39R, H172R, and Q179K, or combinations thereof; and

L2 comprises amino acid modifications selected from the group consisting of Q38E, Q124E, D146G, Q160E, and T180E, or combinations thereof.

40. The construct of claim 39, wherein:

H1 comprises the amino acid modifications Q39E, L143E, K145T, and Q179E;

L1 comprises the amino acid modifications Q38R, Q124R, Q160K, and T178R;

H2 comprises the amino acid modifications Q39R, H172R, and Q179K; and

L2 comprises the amino acid modifications Q38E, Q124E, Q160E, and T180E.

41. The construct of claim 1, wherein

(i) H1 and/or H2 comprises at least one or a set of amino acid modifications at L45, L143, K145, D146, H172, and Q179, and

(ii) L1 and/or L2 comprises at least one or a set of amino acid modifications at Q38, P44, Q124, N137, Q160, S174, T178, T180, and C214.

42. The construct of claim 41, wherein

(i) H1 and/or H2 comprises at least one or a set of amino acid modifications selected from L45P, L143E, K145T, D146G, H172R, H172T, Q179E, and Q179K; and

(ii) L1 and/or L2 comprises at least one or a set of amino acid modifications selected from Q38E, P44F, Q124R, Q124E, N137K, Q160K, Q160E, S174R, T178R, T180E, and C214S.

43. The construct of claim 42, wherein

H1 comprises amino acid modifications selected from the group consisting of L45P, L143E, K145T, H172R, and Q179E, or combinations thereof;

L1 comprises amino acid modifications selected from the group consisting of P44F, Q124R, Q160K, and T178R, or combinations thereof;

H2 comprises amino acid modifications selected from the group consisting of D146G, H172R, H172T, and Q179K, or combinations thereof; and

L2 comprises amino acid modifications selected from the group consisting of Q38E, Q124E, N137K, Q160E, S174R, T180E, and C214S, or combinations thereof.

44. The construct of claim 43, wherein:

H1 comprises the amino acid modifications L45P, L143E, and K145T;

L1 comprises the amino acid modifications P44F, Q124R, Q160K, and T178R;

H2 comprises the amino acid modifications D146G and Q179K; and

L2 comprises the amino acid modifications Q38E, Q124E, Q160E, and T180E.

45. The construct of claim 43, wherein:

H1 comprises the amino acid modifications L143E, K145T, and H172R;

L1 comprises the amino acid modifications Q124R, Q160K, and T178R;

H2 comprises the amino acid modifications H172T and Q179K; and

L2 comprises the amino acid modifications Q124E, Q160E, N137K, S174R, and T180E.

46. The construct of claim 1, wherein

(i) H1 and/or H2 comprises at least one or a set of amino acid modifications at L124, L143, K145, and Q179, and

(ii) L1 and/or L2 comprises at least one or a set of amino acid modifications at Q124, S131, V133, S176, T178, and T180.

47. The construct of claim 46, wherein

(i) H1 and/or H2 comprises at least one or a set of amino acid modifications selected from L124W, L124A, L143E, L143F, K145T, Q179E, and Q179K; and

(ii) L1 and/or L2 comprises at least one or a set of amino acid modifications selected from Q124R, Q124K, Q124E, S131K, V133A, V133W, S176T, T178R, T178L, T178E, and T180E.

48. The construct of claim 47, wherein

H1 comprises amino acid modifications selected from the group consisting of L124W, L143E, K145T, and Q179E, or combinations thereof;

L1 comprises amino acid modifications selected from the group consisting of Q124R, Q124K, S131K, V133A, S176T, T178R, and T178L, or combinations thereof;

H2 comprises amino acid modifications selected from the group consisting of L124A, L143F, and Q179K, or combinations thereof; and

L2 comprises amino acid modifications selected from the group consisting of Q124E, V133W, S176T, T178L, T178E, and T180E, or combinations thereof.

49. The construct of claim 48, wherein:

H1 comprises the amino acid modifications L124W, L143E, K145T, and Q179E;

L1 comprises the amino acid modifications Q124R, V133A, S176T, and T178R;

H2 comprises the amino acid modifications L124A, L143F, and Q179K; and

L2 comprises the amino acid modifications Q124E, V133W, S176T, T178L, and T180E.

50. The construct of claim 1, wherein

(i) H1 and/or H2 comprises at least one or a set of amino acid modifications at A139, L143, K145, Q179, and S186, and

(ii) L1 and/or L2 comprises at least one or a set of amino acid modifications at F116, Q124, V133, Q160, T178, and T180.

51. The construct of claim 50, wherein

(i) H1 and/or H2 comprises at least one or a set of amino acid modifications selected from A139C, L143E, L143D, L143R, L143K, K145T, Q179E, Q179D, Q179R, Q179K, S186K, S186R; and

(ii) L1 and/or L2 comprises at least one or a set of amino acid modifications selected from F116C, Q124R, Q124K, Q124E, V133E, V133D, Q160K, Q160E, T178R, T178K, T178E, and T180E.

52. The construct of claim 51, wherein

H1 comprises amino acid modifications selected from the group consisting of A139C, L143E, L143D, K145T, Q179E, and Q179D, or combinations thereof;

L1 comprises amino acid modifications selected from the group consisting of F116C, Q124R, Q124K, Q160K, T178R, and T178K, or combinations thereof;

H2 comprises amino acid modifications selected from the group consisting of L143R, L143K, Q179R, Q179K, S186K, and S186R, or combinations thereof; and

L2 comprises amino acid modifications selected from the group consisting of Q124E, V133E, V133D, Q160E, T178E, and T180E, or combinations thereof.

53. The construct of claim 52, wherein:

H1 comprises the amino acid modifications A139C, L143E, K145T, and Q179E;

L1 comprises the amino acid modifications F116C, Q124R, and T178R;

H2 comprises the amino acid modification Q179K; and

L2 comprises the amino acid modifications Q124E, Q160E, and T180E.

54. The construct of claim 52, wherein:

H1 comprises the amino acid modifications L143E, K145T, and Q179E;

L1 comprises the amino acid modifications Q124R and T178R;

H2 comprises the amino acid modification S186K; and

L2 comprises the amino acid modifications Q124E, Q160E, and T178E.

55. The construct of claim 52, wherein:

H1 comprises the amino acid modifications L143E, K145T, and Q179E;

L1 comprises the amino acid modifications Q124R and T178R;

H2 comprises the amino acid modification L143R; and

L2 comprises the amino acid modifications Q124E and V133E.

56. The construct of claim 1, wherein

(i) H1 and/or H2 comprises at least one or a set of amino acid modifications at L124, L143, K145, D146, Q179, S186, and S188, and

(ii) L1 and/or L2 comprises at least one or a set of amino acid modifications at Q124, S131, V133, Q160, S176, T178, and T180.

57. The construct of claim 56, wherein

(i) H1 and/or H2 comprises at least one or a set of amino acid modifications selected from L124A, L143A, L143R, L143E, L143K, K145T, D146G, Q179R, Q179E, Q179K, S186R, S186K, and S188L; and

(ii) L1 and/or L2 comprises at least one or a set of amino acid modifications selected from Q124R, Q124E, S131E, S131T, V133Y, V133W, V133E, V133D, Q160E, Q160K, Q160M, S176L, T178R, T178E, T178F, T178Y, and T180E.

58. The construct of claim 57, wherein

H1 comprises amino acid modifications selected from the group consisting of L143E, K145T, Q179E, and S188L, or combinations thereof;

L1 comprises amino acid modifications selected from the group consisting of Q124R, Q160K, and T178R, or combinations thereof;

H2 comprises amino acid modifications selected from the group consisting of L124A, L143A, L143R, L143K, D146G, Q179R, Q179K, S186R, and S186K, or combinations thereof; and

L2 comprises amino acid modifications selected from the group consisting of Q124E, S131E, S131T, V133Y, V133W, V133E, V133D, Q160E, Q160M, S176L, T178E, T178F, T178Y, and T180E, or combinations thereof.

59. The construct of claim 58, wherein:

H1 comprises the amino acid modifications L143E, K145T, Q179E, and S188L;

L1 comprises the amino acid modifications Q124R and T178R;

H2 comprises the amino acid modification S186K; and

L2 comprises the amino acid modifications Q124E, S176L, and T180E.

60. The construct of claim 58, wherein:

H1 comprises the amino acid modifications L143E, K145T, Q179E, and S188L;

L1 comprises the amino acid modifications Q124R and T178R;

H2 comprises the amino acid modification S186K; and

L2 comprises the amino acid modifications Q124E, S131T, T178Y, and T180E.

61. The construct of claim 58, wherein:

H1 comprises the amino acid modifications L143E and K145T;

L1 comprises the amino acid modifications Q124R, Q160K, and T178R;

H2 comprises the amino acid modification S186K; and

L2 comprises the amino acid modifications S131E.

62. The construct of claim 58, wherein:

H1 comprises the amino acid modifications L143E and K145T;

L1 comprises the amino acid modification Q124R;

H2 comprises the amino acid modification L143R; and

L2 comprises the amino acid modifications Q124E and V133E.

63. The construct of claim 1, wherein

(i) H1 comprises at least one or a set of amino acid modifications at F122 and C233, and

(ii) L1 comprises at least one or a set of amino acid modifications at Q124 and C214.

64. The construct of claim 63, wherein

(i) H1 comprises at least one or a set of amino acid modifications selected from F122C and C233S; and

(ii) L1 comprises at least one or a set of amino acid modifications selected from Q124C and C214S.

65. The construct of claim 64, wherein

H1 comprises amino acid modifications selected from the group consisting of F122C and C233S, or combinations thereof;

L1 comprises amino acid modifications selected from the group consisting of Q124C and C214S, or combinations thereof;

H2 comprises a wild-type or unmodified amino acid sequence; and

L2 comprises a wild-type or unmodified amino acid sequence.

66. The construct of claim 65, wherein:

H1 comprises the amino acid modifications F122C and C233S;

L1 comprises the amino acid modifications Q124C and C214S;

H2 comprises a wild-type or unmodified amino acid sequence; and

L2 comprises a wild-type or unmodified amino acid sequence.

67. The construct of any one of the preceding claims, wherein H1 pairs preferentially with L1 as compared to L2, and H2 pairs preferentially with L2 as compared to L1, when H1, H2, L1 and L2 are co-expressed in a cell or a mammalian cell, or when H1, H2, L1 and L2 are co-expressed in a cell-free expression system, or when H1, H2, L1 and L2 are co-produced, or when H1, H2, L1 and L2 are co-produced via a redox production method.

68. The construct of any one of the preceding claims, wherein at least one of H1, H2, L1 and L2 comprises at least one amino acid modification of a VH and/or VL domain and/or at least one amino acid modification of a CH1 and/or CL domain such that H1 pairs preferentially with L1 as compared to L2, and/or H2 pairs preferentially with L2 as compared to L1.



69. The construct of any one of the preceding claims, wherein if H1 comprises at least one amino acid modification in the CH1 domain, then at least one of L1 and L2 comprise at least one amino acid modification in the CL domain; and/or if H1 comprises at least one amino acid modification in the VH domain, then at least one of L1 and L2 comprise at least one amino acid modification in the VL domain; or wherein if H2 comprises at least one amino acid modification in the CH1 domain, then at least one of L1 and L2 comprise at least one amino acid modification in the CL domain; and/or if H2 comprises at least one amino acid modification in the VH domain, then at least one of L1 and L2 comprise at least one amino acid modification in the VL domain.

70. The construct of any one of the preceding claims, wherein H1, L1, H2, and/or L2 comprises at least 1, 2, 3, 4, 5, 6, 7, 8, 9, or 10 amino acid mutations in the Fab region.

71. The construct according to any one of the preceding claims, wherein at least one of H1, H2, L1 and L2 comprises at least 2, 3, 4, 5, 6, 7, 8, 9, or 10 amino acid modifications of at least one constant domain and/or at least one variable domain.

72. The construct according to any one of the preceding claims, wherein when both L1 and L2 are co-expressed with at least one of H1 and H2, the relative pairing of the at least one of H1-L1 and H2-L2 heterodimer pair to that of the respective corresponding H1-L2 or H2-L1 heterodimer pair is greater than 50, 51, 52, 53, 54, 55, 56, 57, 58, 59, 60, 61, 62, 63, 64, 65, 66, 67, 68, 69, 70, 71, 72, 73, 74, 75, 76, 77, 78, 79, 80, 81, 82, 83, 84, 85, 86, 87, 88, 89, 90, 91, 92, 93, 94, 95, 96, 97, 98, or 99%, and wherein the relative pairing of the modified H1-L1 or H2-L2 heterodimer pair is greater than the respective relative pairing observed in the corresponding H1-L1 or H2-L2 heterodimer pair without the at least one amino acid modification.

73. The construct of any one of the preceding claims, wherein the thermal stability of the Fab region of at least one of the first and second heterodimers is within about 0, 1, 2, or 3°C of the  $T_m$  of the corresponding heterodimer without the at least one amino acid modification or set of amino acid modifications.

74. The construct according to any one of the preceding claims, wherein the affinity of each heterodimer for the antigen to which it binds is within about 1, 2, 3, 4, 5, 6, 7, 8, 9, 10, 20, 25, 30, 35, 40, 45, or 50-fold of the affinity of the respective unmodified heterodimer for the same antigen as measured by surface plasmon resonance (SPR) or FACS.

75. The construct according to any one of the preceding claims, wherein  
at least one of H1 and L1 comprises at least one domain comprising at least one amino acid modification resulting in greater steric complementarity of amino acids when H1 pairs with L1 as compared to L2; or

wherein at least one of H2 and L2 comprises at least one domain comprising at least one amino acid modification resulting in greater steric complementarity of amino acids when H2 pairs with L2 as compared to L1; or

wherein at least one of H1 and L1 comprises at least one domain comprising at least one amino acid modification resulting in greater electrostatic complementarity between charged amino acids when H1 pairs with L1 as compared to L2; or

wherein at least one of H2 and L2 comprises at least one domain comprising at least one amino acid modification resulting in greater electrostatic complementarity between charged amino acids when H2 pairs with L2 as compared to L1; or

wherein at least one of H1 and L1 comprises at least one domain comprising at least one amino acid modification resulting in greater steric and electrostatic complementarity of amino acids when H1 pairs with L1 as compared to L2; or

wherein at least one of H2 and L2 comprises at least one domain comprising at least one amino acid modification resulting in greater steric and electrostatic complementarity of amino acids when H2 pairs with L2 as compared to L1; or

wherein at least one of H1 and L1 comprises at least one domain comprising at least one amino acid modification resulting in a covalent bond between H1 and L1; or

wherein at least one of H2 and L2 comprises at least one domain comprising at least one amino acid modification resulting in a covalent bond between H2 and L2.

76. The construct according to any one of the preceding claims, wherein H1, H2, L1, and L2 comprise a set of amino acid modifications selected from the group consisting of the unique identifier design sets shown in Table 5 – 6, 15 – 27, or 28a – 28c.

77. The construct of any one of the preceding claims, wherein the construct further comprises an Fc comprising a first CH3 sequence and a second CH3 sequence, wherein the first CH3 sequence is coupled, with or without one or more linkers, to the first heterodimer and the second CH3 sequence is coupled, with or without one or more linkers to the second heterodimer.

78. The construct of claim 77, wherein the Fc is a human Fc, a human IgG1 Fc, a human IgA Fc, a human IgG Fc, a human IgD Fc, a human IgE Fc, a human IgM Fc, a human IgG2 Fc, a human IgG3 Fc, or a human IgG4 Fc.

79. The construct of claims 77 or 78, wherein the Fc is a heterodimeric Fc.

80. The construct of any one of claims 77-79, wherein the Fc comprises one or more modifications in at least one of the CH3 sequences.

81. The construct of any one of claims 77-80, wherein the dimerized CH3 sequences have a melting temperature ( $T_m$ ) as measured by DSF of about 68, 69, 70, 71, 72, 73, 74, 75, 76, 77, 77.5, 78, 79, 80, 81, 82, 83, 84, or 85°C or higher.

82. The construct of any one of claims 77-81, wherein the Fc is a heterodimer formed with a purity greater than about 75, 76, 77, 78, 79, 80, 81, 82, 83, 84, 85, 86, 87, 88, 89, 90, 91, 92, 93, 94, 95, 96, 97, 98, or 99% when produced; or wherein the Fc is a heterodimer formed with a purity greater than about 75, 76, 77, 78, 79, 80, 81, 82, 83, 84, 85, 86, 87, 88, 89, 90, 91, 92, 93, 94, 95, 96, 97, 98, or 99% when expressed or when expressed via a single cell.

83. The construct of any one of claims 77-82, wherein the Fc comprises one or more modifications in at least one of the CH3 sequences that promote the formation of a heterodimeric Fc with stability comparable to a wild-type homodimeric Fc.

84. The construct of any one of claims 78-84, wherein the Fc comprises:

i) a heterodimeric IgG1 Fc having the modifications L351Y\_F405A\_Y407V in the first Fc polypeptide, and the modifications T366L\_K392M\_T394W in the second Fc polypeptide;

ii) a heterodimeric IgG1 Fc having the modifications L351Y\_F405A\_Y407V in the first Fc polypeptide, and the modifications T366L\_K392L\_T394W in the second Fc polypeptide;

iii) a heterodimeric IgG1 Fc having the modifications T350V\_L351Y\_F405A\_Y407V in the first Fc polypeptide, and the modifications T350V\_T366L\_K392L\_T394W in the second Fc polypeptide;

iv) a heterodimeric IgG1 Fc having the modifications T350V\_L351Y\_F405A\_Y407V in the first Fc polypeptide, and the modifications T350V\_T366L\_K392M\_T394W in the second Fc polypeptide; or

v) a heterodimeric IgG1 Fc having the modifications T350V\_L351Y\_S400E\_F405A\_Y407V in the first Fc polypeptide, and the modifications T350V\_T366L\_N390R\_K392M\_T394W in the second Fc polypeptide.

85. The construct of any one of claims 77-84, wherein the Fc further comprises at least one CH2 sequence.

86. The construct of claim 85, wherein the CH2 sequence(s) of the Fc comprises one or more modifications.

87. The construct of any one of claims 77-86, wherein the Fc comprises one or more modifications to promote selective binding of Fc-gamma receptors.

88. The construct according to any one of claims 77-87, wherein the Fc is coupled to the heterodimers by one or more linkers, or wherein the Fc is coupled to H1 and H2 by one or more linkers.

89. The construct of claim 88, wherein the one or more linkers are one or more polypeptide linkers.

90. The construct of claim 88, wherein the one or more linkers comprises one or more antibody hinge regions.

91. The construct of claim 88, wherein the one or more linkers comprises one or more IgG1 hinge regions.

92. The construct of any one of claims 88-91, wherein the one or more linkers comprise one or more modifications.

93. The construct of claim 92, wherein the one or more modifications promote selective binding of Fc-gamma receptors.

94. The construct according to any one of the preceding claims, wherein the at least one amino acid modification is at least one amino acid mutation or wherein the at least one amino acid modification is at least one amino acid substitution.

95. The construct according to any one of the preceding claims, wherein the sequences of each of H1, H2, L1, and L2 are derived from human sequences.

96. The construct according to any one of the preceding claims, wherein the construct is multispecific or bispecific.

97. The construct according to any one of the preceding claims, wherein the construct is multivalent or bivalent.

98. An isolated polynucleotide or set of isolated polynucleotides comprising at least one sequence that encodes the construct of any one of the preceding claims.

99. The isolated polynucleotide or set of isolated polynucleotides of claim 98, wherein the polynucleotide or set of polynucleotides is cDNA.

100. A vector or set of vectors comprising one or more of the polynucleotides or sets of polynucleotides according to claim 98 or 99.

101. The vector or set of vectors according to claim 100, which is selected from the group consisting of a plasmid, a multi-cistronic vector, a viral vector, a non-episomal mammalian vector, an expression vector, and a recombinant expression vector.

102. An isolated cell comprising a polynucleotide or set of polynucleotides according to claim 98 or 99, or a vector or set of vectors of claims 100 or 101.

103. The isolated cell according to claim 102, wherein the cell is a yeast cell, a bacterial cell, a hybridoma, a Chinese Hamster Ovary (CHO) cell, or a HEK293 cell.

104. A pharmaceutical composition comprising the construct of any one of the preceding claims and a pharmaceutically acceptable carrier.

105. The pharmaceutical composition according to claim 104, further comprising one or more substances selected from the group consisting of a buffer, an antioxidant, a low molecular weight molecule, a drug, a protein, an amino acid, a carbohydrate, a lipid, a chelating agent, a stabilizer, and an excipient.

106. Use of the construct according to any one of claims 1 - 96 or the pharmaceutical composition according to claims 104 or 105 for the treatment of a disease or disorder in a subject or in the manufacture of a medicine.

107. A method of treatment of a subject having a disease or disorder comprising administering to the subject a construct according to any one of claims 1 - 96 or a pharmaceutical composition according to claims 104 or 105.

108. A method of obtaining the construct according to any one of claims 1-96 from a host cell culture, the method comprising the steps of:

(a) obtaining a host cell culture comprising at least one host cell comprising one or more nucleic acid sequences encoding the construct; and

(b) recovering the construct from the host cell culture.

109. A method of obtaining the construct according to any one of claims 1-96, comprising the steps of:

(a) obtaining H1, L1, H2, and L2;

(b) allowing H1 to pair preferentially with L1 as compared to L2 and H2 to pair preferentially with L2 as compared to L1; and

(c) obtaining the construct.

110. A method of preparing the construct according to any one of claims 1 to 96 comprising:

a. Obtaining a polynucleotide or set of polynucleotides encoding at least one construct;

b. Determining the optimal ratios of each of the polynucleotide or set of polynucleotides for introduction into at least one host cell, wherein the optimal ratios are determined by assessing the amount of H1-L1 and H2-L2 heterodimer pairs formed upon expression of H1, L1, H2, and L2 as compared to mispaired H1-L2 and H2-L1 heterodimer pairs formed upon expression of H1, L1, H2, and L2;

c. Selecting a preferred optimal ratio, wherein transfection of at least one host cell with the preferred optimal ratio of the polynucleotide or set of polynucleotides results in expression of the construct;

d. Transfecting the at least one host cell with the optimal ratio of the polynucleotide or set of polynucleotides; and

e. Culturing the at least one host cell to express the construct.

111. The method of claim 110, wherein selecting the optimal ratio is assessed by transfection in a transient transfection system.

112. The method of claims 110 or 111, wherein transfection of the at least one host cell with the preferred optimal ratio of the polynucleotide or set of polynucleotides results in optimal expression of the construct.

113. The method of any one of claims 110-112, wherein the construct comprises an Fc comprising at least two CH3 sequences, wherein the Fc is coupled, with or without one or more linkers, to the first heterodimer and the second heterodimer.

114. The method of claim 113, wherein the Fc is a heterodimer, optionally comprising one or more amino acid modifications.

115. A computer-readable storage medium storing  
a dataset comprising data representing complementary mutations in a first heterodimer comprising a first immunoglobulin heavy chain polypeptide sequence (H1) and a first immunoglobulin light chain polypeptide sequence (L1); and a second heterodimer comprising a second immunoglobulin heavy chain polypeptide sequence (H2) and a second immunoglobulin light chain polypeptide sequence (L2), wherein H1 and H2 each comprise at least a heavy chain variable domain (VH domain) and a heavy chain constant domain (CH1 domain); wherein L1 and L2 each comprise at least a light chain variable domain (VL domain) and a light chain constant domain (CL domain), and wherein the dataset of complementary mutations comprises data representing those mutations listed in Tables 4 – 6, 15 – 27, 28a – 28c or a subset of those mutations.

116. A method of producing a bi-specific antigen binding polypeptide construct, said bi-specific construct comprising a first heterodimer comprising a first immunoglobulin heavy chain polypeptide sequence (H1), and a first immunoglobulin light chain polypeptide sequence (L1) from a first mono-specific antigen binding polypeptide; and a second heterodimer comprising a second immunoglobulin heavy chain polypeptide sequence (H2), and a second immunoglobulin light chain polypeptide sequence (L2) from a second mono-specific antigen binding polypeptide, wherein H1 and H2 each comprise at least a heavy chain variable domain (VH domain) and a heavy chain constant domain (CH1 domain); wherein L1 and L2



each comprise at least a light chain variable domain (VL domain) and a light chain constant domain (CL domain), the method comprising:

- a. introducing one or more complementary mutations from the dataset of claim 115 into the first heterodimer and/or the second heterodimer; and
- b. co-expressing the first heterodimer and the second heterodimer in at least one host cell to produce an expression product comprising the bi-specific construct.

117. The method of claim 116, further comprising determining the amount of the bi-specific construct in the expression product relative to other polypeptide products to select a preferred subset of complementary mutations.

118. The method of claims 116 or 117 wherein the bi-specific construct is produced with a purity of greater than 70% compared to the other polypeptide products.

119. The method of any one of claims 116-118, further comprising the step of adding additional amino acid modifications to at least one of H1, H2, L1, or L2 to increase the purity of the bi-specific construct compared to the other polypeptide products.

120. The method of any one of claims 116-119, wherein the construct comprises an Fc comprising at least two CH3 sequences, wherein the Fc is coupled, with or without one or more linkers, to the first heterodimer and the second heterodimer.

121. The method of claim 120, wherein the Fc is a heterodimer, optionally comprising one or more amino acid modifications.

122. The method of any one of claims 116-121, wherein the antigen binding polypeptide is an antibody, a single chain monoclonal antibody, a Fab, or a single chain Fab.

123. A method of preparing the isolated antigen binding polypeptide construct according to any one of claims 1 to 96 comprising expressing H1, H2, L1, and L2 in at least one expression system to produce an expression product; characterizing the expression product; and selecting the expression system wherein more than 90% of the expression product is the isolated antigen binding polypeptide construct.

124. The construct of claim 1, wherein the amino acid modifications are selected from SMCA designs 9561-9095\_\_1, 9561-9095\_\_2, 9121-9373\_\_1, 9121-9373\_\_2, 9116-9349\_\_1, 9116-9349\_\_2, 9134-9521\_\_1, 9134-9521\_\_2, 9286-9402\_\_1, 9286-9402\_\_2, 9667-9830\_\_1, 9667-9830\_\_2, 9696-9848\_\_1, 9696-9848\_\_2, 9060-9756\_\_1, 9060-9756\_\_2, 9682-9740\_\_1, 9682-9740\_\_2, 9049-9759\_\_1, 9049-9759\_\_2, 9820-9823\_\_1, and 9820-9823\_\_2 of Table 35a.

125. The construct of claim 1, wherein the amino acid modifications are selected from SMCA designs 9327-6054\_\_1, 9815-9825\_\_1, 9815-9825\_\_2, 9587-9735\_\_1, 9587-9735\_\_2, 3522\_\_1, 3522\_\_2, 3519\_\_1, and 3519\_\_2 of Table 35b.

## AMENDED CLAIMS

received by the International Bureau on 30 October 2015 (30.10.2015)

1. An isolated antigen binding polypeptide construct comprising at least a first heterodimer and a second heterodimer,

the first heterodimer comprising a first immunoglobulin heavy chain polypeptide sequence (H1), and a first immunoglobulin light chain polypeptide sequence (L1); and the second heterodimer comprising a second immunoglobulin heavy chain polypeptide sequence (H2), and a second immunoglobulin light chain polypeptide sequence (L2), wherein at least one of the H1 or L1 sequences of the first heterodimer is distinct from the corresponding H2 or L2 sequence of the second heterodimer, and wherein

H1 and H2 each comprise at least a heavy chain variable domain ( $V_H$  domain) and a heavy chain constant domain ( $C_{H1}$  domain);

L1 and L2 each comprise at least a light chain variable domain ( $V_L$  domain) and a light chain constant domain ( $C_L$  domain); and

at least one of H1, H2, L1, and L2 comprises at least one amino acid modification, wherein H1 preferentially pairs with L1 as compared to L2 and H2 preferentially pairs with L2 as compared to L1; or

H1, H2, L1, and L2 comprise a set of amino acid modifications, wherein H1 preferentially pairs with L1 as compared to L2 and H2 preferentially pairs with L2 as compared to L1;

wherein the thermal stability of the Fab region as measured by the melting temperature ( $T_m$ ) of at least one of the first and second heterodimers is within about 0, 1, 2, 3, 4, 5, 6, 7, 8, 9, or 10°C of the  $T_m$  of the corresponding heterodimer without the at least one amino acid modification or set of amino acid modifications.

2. The construct of claim 1, wherein

(i) H1 and/or H2 comprises at least one or a set of amino acid modifications at L124, K145, D146, Q179, and S186, and

(ii) L1 and/or L2 comprises at least one or a set of amino acid modifications at Q124, S131, V133, Q160, S176, T178, and T180.

3. The construct of claim 2, wherein

(i) H1 and/or H2 comprises at least one or a set of amino acid modifications selected from L124R, L124E, K145M, K145T, D146N, Q179E, Q179K, S186R, and S186K, and

(ii) L1 and/or L2 comprises at least one or a set of amino acid modifications selected from Q124E, S131R, S131K, V133G, Q160E, S176R, S176D, T178D, T178E, and T180E.

4. The construct of claim 3, wherein:

H1 comprises amino acid modifications selected from the group consisting of L124E, K145M, K145T, and Q179E, or a combination thereof;

L1 comprises amino acid modifications selected from the group consisting of S131R, S131K, V133G, and S176R, or a combination thereof;

H2 comprises amino acid modifications selected from the group consisting of L124R, D146N, Q179K, S186R, and S186K, or a combination thereof; and

L2 comprises amino acid modifications selected from the group consisting of Q124E, V133G, Q160E, S176D, T178D, T178E, and T180E, or a combination thereof.

5. The construct of claim 4, wherein:

H1 comprises the amino acid modifications L124E, K145T, and Q179E;

L1 comprises the amino acid modifications S131K, V133G, and S176R;

H2 comprises the amino acid modifications L124R and S186R; and

L2 comprises the amino acid modifications V133G, S176D, and T178D.

6. The construct of claim 1, wherein

(i) H1 and/or H2 comprises at least one or a set of amino acid modifications at L124, L143, K145, D146, Q179, and S186; and

(ii) L1 and/or L2 comprises at least one or a set of amino acid modifications at Q124, V133, Q160, S176, T178, and T180.

7. The construct of claim 6, wherein

(i) H1 and/or H2 comprises at least one or a set of amino acid modifications selected from L124E, L124R, L143E, L143D, K145T, K145M, D146N, Q179K, S186R, and S186K; and

(ii) L1 and/or L2 comprises at least one or a set of amino acid modifications selected from Q124K, Q124E, V133G, Q160K, S176R, S176D, T178E, T178K, T178R, T178D, and T180E.

8. The construct of claim 7, wherein:

H1 comprises amino acid modifications selected from the group consisting of L124E, L143E, L143D, K145T, and K145M, or combinations thereof;

L1 comprises amino acid modifications selected from the group consisting of Q124K, V133G, Q160K, S176R, T178K, and T178R, or combinations thereof;

H2 comprises amino acid modifications selected from the group consisting of L124R, D146N, Q179K, S186R, and S186K, or combinations thereof; and

L2 comprises amino acid modifications selected from the group consisting of Q124E, V133G, S176D, T178E, T178D, and T180E, or combinations thereof.

9. The construct of claim 8, wherein:

H1 comprises the amino acid modifications L124E, L143E, and K145T;

L1 comprises the amino acid modifications Q124K, V133G, and S176R;

H2 comprises the amino acid modifications L124R and Q179K; and

L2 comprises the amino acid modifications V133G, S176D, and T178E.

10. The construct of claim 8, wherein:

H1 comprises the amino acid modifications L124E, L143E, and K145T;

L1 comprises the amino acid modifications Q124K, V133G, and S176R;

H2 comprises the amino acid modifications L124R and S186R; and

L2 comprises the amino acid modifications V133G, S176D, and T178D.

11. The construct of claim 1, wherein

(i) H1 and/or H2 comprises at least one or a set of amino acid modifications at Q39, L45, L124, L143, F122, and H172, and

(ii) L1 and/or L2 comprises at least one or a set of amino acid modifications at Q38, P44, Q124, S131, V133, N137, S174, S176, and T178.

12. The construct of claim 11, wherein

(i) H1 and/or H2 comprises at least one or a set of amino acid modifications selected from Q39E, Q39R, L45P, F122C, L124E, L124R, L143F, H172T, and H172R; and

(ii) L1 and/or L2 comprises at least one or a set of amino acid modifications selected from Q38R, Q38E, P44F, Q124C, S131T, S131E, V133G, N137K, S174R, S176R, S176K, S176D, T178Y, and T178D.

13. The construct of claim 12, wherein

H1 comprises amino acid modifications selected from the group consisting of Q39E, L45P, F122C, L124E, L143F, H172T, and H172R or combinations thereof;

L1 comprises amino acid modifications selected from the group consisting of Q38R, P44F, Q124C, S131T, V133G, N137K, S174R, S176R, S176K, and T178Y, or combinations thereof;

H2 comprises amino acid modifications selected from the group consisting of Q39R, L124R, and H172R, or combinations thereof; and

L2 comprises amino acid modifications selected from the group consisting of Q38E, S131E, V133G, S176D, and T178D, or combinations thereof.

14. The construct of claim 13, wherein:

H1 comprises the amino acid modifications Q39E and L124E;

L1 comprises the amino acid modifications Q38R, V133G, and S176R;

H2 comprises the amino acid modifications Q39R and L124R; and

L2 comprises the amino acid modifications Q38E, V133G, and S176D.

15. The construct of claim 13, wherein:

H1 comprises the amino acid modifications L45P and L124E;

L1 comprises the amino acid modifications P44F, V133G, and S176R;

H2 comprises the amino acid modification L124R; and

L2 comprises the amino acid modifications V133G, S176D, and T178D.

16. The construct of claim 13, wherein:

H1 comprises the amino acid modifications L124E and L143F;

L1 comprises the amino acid modifications V133G, and S176R;

H2 comprises the amino acid modification L124R; and

L2 comprises the amino acid modifications V133G, S176D, and T178D.

17. The construct of claim 13, wherein:

H1 comprises the amino acid modifications F122C and L124E;

L1 comprises the amino acid modifications Q124C, V133G, and S176R;

H2 comprises the amino acid modification L124R; and

L2 comprises the amino acid modifications V133G and S176D.

18. The construct of claim 13, wherein:

H1 comprises the amino acid modifications L124E and H172T;

L1 comprises the amino acid modifications V133G, N137K, S174R, and S176R;

H2 comprises the amino acid modification L124R and H172R; and

L2 comprises the amino acid modifications V133G, S176D, and T178D.

19. The construct of claim 1, wherein

(i) H1 and/or H2 comprises at least one or a set of amino acid modifications at L124, A125, H172, and K228, and

(ii) L1 and/or L2 comprises at least one or a set of amino acid modifications at S121, V133, N137, S174, S176, and T178.

20. The construct of claim 19, wherein



(i) H1 and/or H2 comprises at least one or a set of amino acid modifications selected from L124E, L124R, A125S, A125R, H172R, H172T, and K228D; and

(ii) L1 and/or L2 comprises at least one or a set of amino acid modifications selected from S121K, V133G, N137K, S174R, S176K, S176R, S176D, and T178D.

21. The construct of claim 20, wherein

H1 comprises amino acid modifications selected from the group consisting of L124E, A125S, H172R, and K228D or combinations thereof;

L1 comprises amino acid modifications selected from the group consisting of S121K, V133G, and S176R, or combinations thereof;

H2 comprises amino acid modifications selected from the group consisting of L124R, A125R, and H172T, or combinations thereof; and

L2 comprises amino acid modifications selected from the group consisting of V133G, N137K, S174R, S176D, and T178D, or combinations thereof.

22. The construct of claim 21, wherein:

H1 comprises the amino acid modifications L124E and K228D;

L1 comprises the amino acid modifications S121K, V133G, and S176R;

H2 comprises the amino acid modifications L124R and A125R; and

L2 comprises the amino acid modifications V133G and S176D.

23. The construct of claim 21, wherein:

H1 comprises the amino acid modifications L124E and H172R;

L1 comprises the amino acid modifications V133G and S176R;

H2 comprises the amino acid modifications L124R and H172T; and

L2 comprises the amino acid modifications V133G, S174R, and S176D.

24. The construct of claim 1, wherein

(i) H1 and/or H2 comprises at least one or a set of amino acid modifications at L124, A139, and V190, and

(ii) L1 and/or L2 comprises at least one or a set of amino acid modifications at F116, V133, L135, and S176.

25. The construct of claim 24, wherein

(i) H1 and/or H2 comprises at least one or a set of amino acid modifications selected from L124E, L124R, A139W, A139G, and V190A; and

(ii) L1 and/or L2 comprises at least one or a set of amino acid modifications selected from F116A, V133G, L135V, L135W, S176R, and S176D.

26. The construct of claim 25, wherein

H1 comprises amino acid modifications selected from the group consisting of L124E and A139W, or combinations thereof;

L1 comprises amino acid modifications selected from the group consisting of F116A, V133G, L135V, and S176R, or combinations thereof;

H2 comprises amino acid modifications selected from the group consisting of L124R, A139G, and V190A, or combinations thereof; and

L2 comprises amino acid modifications selected from the group consisting of V133G, L135W, and S176D, or combinations thereof.

27. The construct of claim 26, wherein:

H1 comprises the amino acid modifications L124E and A139W;

L1 comprises the amino acid modifications F116A, V133G, L135V, and S176R;

H2 comprises the amino acid modifications L124R, A139G, and V190A; and

L2 comprises the amino acid modifications V133G, L135W, and S176D.

28. The construct of claim 1, wherein

(i) H1 and/or H2 comprises at least one or a set of amino acid modifications at Q39, L45, K145, H172, Q179 and S186, and

(ii) L1 and/or L2 comprises at least one or a set of amino acid modifications at Q38, P44, Q124, S131, Q160, T180 and C214.

29. The construct of claim 28, wherein

(i) H1 and/or H2 comprises at least one or a set of amino acid modifications selected from Q39E, Q39R, L45P, K145T, H172R, Q179E and S186R; and

(ii) L1 and/or L2 comprises at least one or a set of amino acid modifications selected from Q38R, Q38E, P44F, Q124E, S131K, Q160E, T180E and C214S.

30. The construct of claim 29, wherein

H1 comprises amino acid modifications selected from the group consisting of Q39E, L45P, K145T, H172R, and Q179E, or combinations thereof;

L1 comprises amino acid modifications selected from the group consisting of Q38R, P44F, and S131K, or combinations thereof;

H2 comprises amino acid modifications selected from the group consisting of Q39R, H172R, and S186R, or combinations thereof; and

L2 comprises amino acid modifications selected from the group consisting of Q38E, Q124E, Q160E, T180E and C214S, or combinations thereof.

31. The construct of claim 30, wherein:

H1 comprises the amino acid modifications Q39E, K145T, and Q179E;

L1 comprises the amino acid modifications Q38R and S131K;

H2 comprises the amino acid modifications Q39R and S186R; and

L2 comprises the amino acid modifications Q38E, Q124E, Q160E, and T180E.

32. The construct of claim 30, wherein:

H1 comprises the amino acid modifications L45P, K145T, H172R, and Q179E;

L1 comprises the amino acid modifications P44F and S131K;

H2 comprises the amino acid modifications H172R and S186R; and

L2 comprises the amino acid modifications Q124E, Q160E, and T180E.

33. The construct of claim 1, wherein

(i) H1 and/or H2 comprises at least one or a set of amino acid modifications at A139, L143, K145, Q179 and V190, and

(ii) L1 and/or L2 comprises at least one or a set of amino acid modifications at F116, Q124, L135, Q160, T178, and T180.

34. The construct of claim 33, wherein

(i) H1 and/or H2 comprises at least one or a set of amino acid modifications selected from A139W, A139G, L143E, K145T, Q179E, Q179K, and V190A; and

(ii) L1 and/or L2 comprises at least one or a set of amino acid modifications selected from F116A, Q124R, Q124E, L135V, L135W, Q160E, T178R, and T180E.

35. The construct of claim 34, wherein

H1 comprises amino acid modifications selected from the group consisting of A139W, L143E, K145T, and Q179E, or combinations thereof;

L1 comprises amino acid modifications selected from the group consisting of F116A, Q124R, L135V, and T178R, or combinations thereof;

H2 comprises amino acid modifications selected from the group consisting of A139G, Q179K, and V190A, or combinations thereof; and

L2 comprises amino acid modifications selected from the group consisting of Q124E, L135W, Q160E, and T180E, or combinations thereof.

36. The construct of claim 35 wherein:

H1 comprises the amino acid modifications A139W, L143E, K145T, and Q179E;

L1 comprises the amino acid modifications F116A, Q124R, L135V, and T178R;

H2 comprises the amino acid modification Q179K; and

L2 comprises the amino acid modifications Q124E, L135W, Q160E, and T180E.

37. The construct of claim 1, wherein

(i) H1 and/or H2 comprises at least one or a set of amino acid modifications at Q39, L143, K145, D146, H172, and Q179, and

(ii) L1 and/or L2 comprises at least one or a set of amino acid modifications at Q38, Q124, Q160, T178, and T180.

38. The construct of claim 37, wherein

(i) H1 and/or H2 comprises at least one or a set of amino acid modifications selected from Q39E, Q39R, L143E, K145T, D146G, H172R, Q179E, and Q179K; and

(ii) L1 and/or L2 comprises at least one or a set of amino acid modifications selected from Q38R, Q38E, Q124R, Q124E, Q160K, Q160E, T178R, and T180E.

39. The construct of claim 38, wherein

H1 comprises amino acid modifications selected from the group consisting of Q39E, L143E, K145T, H172R, and Q179E, or combinations thereof;

L1 comprises amino acid modifications selected from the group consisting of Q38R, Q124R, Q160K, and T178R, or combinations thereof;

H2 comprises amino acid modifications selected from the group consisting of Q39R, H172R, and Q179K, or combinations thereof; and

L2 comprises amino acid modifications selected from the group consisting of Q38E, Q124E, D146G, Q160E, and T180E, or combinations thereof.

40. The construct of claim 39, wherein:

H1 comprises the amino acid modifications Q39E, L143E, K145T, and Q179E;

L1 comprises the amino acid modifications Q38R, Q124R, Q160K, and T178R;

H2 comprises the amino acid modifications Q39R, H172R, and Q179K; and

L2 comprises the amino acid modifications Q38E, Q124E, Q160E, and T180E.

41. The construct of claim 1, wherein

(i) H1 and/or H2 comprises at least one or a set of amino acid modifications at L45, L143, K145, D146, H172, and Q179, and

(ii) L1 and/or L2 comprises at least one or a set of amino acid modifications at Q38, P44, Q124, N137, Q160, S174, T178, T180, and C214.

42. The construct of claim 41, wherein

(i) H1 and/or H2 comprises at least one or a set of amino acid modifications selected from L45P, L143E, K145T, D146G, H172R, H172T, Q179E, and Q179K; and

(ii) L1 and/or L2 comprises at least one or a set of amino acid modifications selected from Q38E, P44F, Q124R, Q124E, N137K, Q160K, Q160E, S174R, T178R, T180E, and C214S.

43. The construct of claim 42, wherein

H1 comprises amino acid modifications selected from the group consisting of L45P, L143E, K145T, H172R, and Q179E, or combinations thereof;

L1 comprises amino acid modifications selected from the group consisting of P44F, Q124R, Q160K, and T178R, or combinations thereof;

H2 comprises amino acid modifications selected from the group consisting of D146G, H172R, H172T, and Q179K, or combinations thereof; and

L2 comprises amino acid modifications selected from the group consisting of Q38E, Q124E, N137K, Q160E, S174R, T180E, and C214S, or combinations thereof.

44. The construct of claim 43, wherein:

H1 comprises the amino acid modifications L45P, L143E, and K145T;

L1 comprises the amino acid modifications P44F, Q124R, Q160K, and T178R;

H2 comprises the amino acid modifications D146G and Q179K; and

L2 comprises the amino acid modifications Q38E, Q124E, Q160E, and T180E.

45. The construct of claim 43, wherein:

H1 comprises the amino acid modifications L143E, K145T, and H172R;

L1 comprises the amino acid modifications Q124R, Q160K, and T178R;

H2 comprises the amino acid modifications H172T and Q179K; and

L2 comprises the amino acid modifications Q124E, Q160E, N137K, S174R, and T180E.

46. The construct of claim 1, wherein

(i) H1 and/or H2 comprises at least one or a set of amino acid modifications at L124, L143, K145, and Q179, and

(ii) L1 and/or L2 comprises at least one or a set of amino acid modifications at Q124, S131, V133, S176, T178, and T180.

47. The construct of claim 46, wherein

(i) H1 and/or H2 comprises at least one or a set of amino acid modifications selected from L124W, L124A, L143E, L143F, K145T, Q179E, and Q179K; and

(ii) L1 and/or L2 comprises at least one or a set of amino acid modifications selected from Q124R, Q124K, Q124E, S131K, V133A, V133W, S176T, T178R, T178L, T178E, and T180E.

48. The construct of claim 47, wherein

H1 comprises amino acid modifications selected from the group consisting of L124W, L143E, K145T, and Q179E, or combinations thereof;

L1 comprises amino acid modifications selected from the group consisting of Q124R, Q124K, S131K, V133A, S176T, T178R, and T178L, or combinations thereof;



H2 comprises amino acid modifications selected from the group consisting of L124A, L143F, and Q179K, or combinations thereof; and

L2 comprises amino acid modifications selected from the group consisting of Q124E, V133W, S176T, T178L, T178E, and T180E, or combinations thereof.

49. The construct of claim 48, wherein:

H1 comprises the amino acid modifications L124W, L143E, K145T, and Q179E;

L1 comprises the amino acid modifications Q124R, V133A, S176T, and T178R;

H2 comprises the amino acid modifications L124A, L143F, and Q179K; and

L2 comprises the amino acid modifications Q124E, V133W, S176T, T178L, and T180E.

50. The construct of claim 1, wherein

(i) H1 and/or H2 comprises at least one or a set of amino acid modifications at A139, L143, K145, Q179, and S186, and

(ii) L1 and/or L2 comprises at least one or a set of amino acid modifications at F116, Q124, V133, Q160, T178, and T180.

51. The construct of claim 50, wherein

(i) H1 and/or H2 comprises at least one or a set of amino acid modifications selected from A139C, L143E, L143D, L143R, L143K, K145T, Q179E, Q179D, Q179R, Q179K, S186K, S186R; and

(ii) L1 and/or L2 comprises at least one or a set of amino acid modifications selected from F116C, Q124R, Q124K, Q124E, V133E, V133D, Q160K, Q160E, T178R, T178K, T178E, and T180E.

52. The construct of claim 51, wherein

H1 comprises amino acid modifications selected from the group consisting of A139C, L143E, L143D, K145T, Q179E, and Q179D, or combinations thereof;

L1 comprises amino acid modifications selected from the group consisting of F116C, Q124R, Q124K, Q160K, T178R, and T178K, or combinations thereof;

H2 comprises amino acid modifications selected from the group consisting of L143R, L143K, Q179R, Q179K, S186K, and S186R, or combinations thereof; and

L2 comprises amino acid modifications selected from the group consisting of Q124E, V133E, V133D, Q160E, T178E, and T180E, or combinations thereof.

53. The construct of claim 52, wherein:

H1 comprises the amino acid modifications A139C, L143E, K145T, and Q179E;

L1 comprises the amino acid modifications F116C, Q124R, and T178R;

H2 comprises the amino acid modification Q179K; and

L2 comprises the amino acid modifications Q124E, Q160E, and T180E.

54. The construct of claim 52, wherein:

H1 comprises the amino acid modifications L143E, K145T, and Q179E;

L1 comprises the amino acid modifications Q124R and T178R;

H2 comprises the amino acid modification S186K; and

L2 comprises the amino acid modifications Q124E, Q160E, and T178E.

55. The construct of claim 52, wherein:

H1 comprises the amino acid modifications L143E, K145T, and Q179E;

L1 comprises the amino acid modifications Q124R and T178R;

H2 comprises the amino acid modification L143R; and

L2 comprises the amino acid modifications Q124E and V133E.

56. The construct of claim 1, wherein

(i) H1 and/or H2 comprises at least one or a set of amino acid modifications at L124, L143, K145, D146, Q179, S186, and S188, and

(ii) L1 and/or L2 comprises at least one or a set of amino acid modifications at Q124, S131, V133, Q160, S176, T178, and T180.

57. The construct of claim 56, wherein

(i) H1 and/or H2 comprises at least one or a set of amino acid modifications selected from L124A, L143A, L143R, L143E, L143K, K145T, D146G, Q179R, Q179E, Q179K, S186R, S186K, and S188L; and

(ii) L1 and/or L2 comprises at least one or a set of amino acid modifications selected from Q124R, Q124E, S131E, S131T, V133Y, V133W, V133E, V133D, Q160E, Q160K, Q160M, S176L, T178R, T178E, T178F, T178Y, and T180E.

58. The construct of claim 57, wherein

H1 comprises amino acid modifications selected from the group consisting of L143E, K145T, Q179E, and S188L, or combinations thereof;

L1 comprises amino acid modifications selected from the group consisting of Q124R, Q160K, and T178R, or combinations thereof;

H2 comprises amino acid modifications selected from the group consisting of L124A, L143A, L143R, L143K, D146G, Q179R, Q179K, S186R, and S186K, or combinations thereof; and

L2 comprises amino acid modifications selected from the group consisting of Q124E, S131E, S131T, V133Y, V133W, V133E, V133D, Q160E, Q160M, S176L, T178E, T178F, T178Y, and T180E, or combinations thereof.

59. The construct of claim 58, wherein:

H1 comprises the amino acid modifications L143E, K145T, Q179E, and S188L;

L1 comprises the amino acid modifications Q124R and T178R;

H2 comprises the amino acid modification S186K; and

L2 comprises the amino acid modifications Q124E, S176L, and T180E.

60. The construct of claim 58, wherein:

H1 comprises the amino acid modifications L143E, K145T, Q179E, and S188L;

L1 comprises the amino acid modifications Q124R and T178R;

H2 comprises the amino acid modification S186K; and

L2 comprises the amino acid modifications Q124E, S131T, T178Y, and T180E.

61. The construct of claim 58, wherein:

H1 comprises the amino acid modifications L143E and K145T;

L1 comprises the amino acid modifications Q124R, Q160K, and T178R;

H2 comprises the amino acid modification S186K; and

L2 comprises the amino acid modifications S131E.

62. The construct of claim 58, wherein:

H1 comprises the amino acid modifications L143E and K145T;

L1 comprises the amino acid modification Q124R;

H2 comprises the amino acid modification L143R; and

L2 comprises the amino acid modifications Q124E and V133E.

63. The construct of claim 1, wherein

(i) H1 comprises at least one or a set of amino acid modifications at F122 and C233, and

(ii) L1 comprises at least one or a set of amino acid modifications at Q124 and C214.

64. The construct of claim 63, wherein

(i) H1 comprises at least one or a set of amino acid modifications selected from F122C and C233S; and

(ii) L1 comprises at least one or a set of amino acid modifications selected from Q124C and C214S.

65. The construct of claim 64, wherein

H1 comprises amino acid modifications selected from the group consisting of F122C and C233S, or combinations thereof;

L1 comprises amino acid modifications selected from the group consisting of Q124C and C214S, or combinations thereof;

H2 comprises a wild-type or unmodified amino acid sequence; and

L2 comprises a wild-type or unmodified amino acid sequence.

66. The construct of claim 65, wherein:

H1 comprises the amino acid modifications F122C and C233S;

L1 comprises the amino acid modifications Q124C and C214S;

H2 comprises a wild-type or unmodified amino acid sequence; and

L2 comprises a wild-type or unmodified amino acid sequence.

67. The construct of any one of the preceding claims, wherein H1 pairs preferentially with L1 as compared to L2, and H2 pairs preferentially with L2 as compared to L1, when H1, H2, L1 and L2 are co-expressed in a cell or a mammalian cell, or when H1, H2, L1 and L2 are co-expressed in a cell-free expression system, or when H1, H2, L1 and L2 are co-produced, or when H1, H2, L1 and L2 are co-produced via a redox production method.

68. The construct of any one of the preceding claims, wherein at least one of H1, H2, L1 and L2 comprises at least one amino acid modification of a VH and/or VL domain and/or at least one amino acid modification of a CH1 and/or CL domain such that H1 pairs preferentially with L1 as compared to L2, and/or H2 pairs preferentially with L2 as compared to L1.

69. The construct of any one of the preceding claims, wherein if H1 comprises at least one amino acid modification in the CH1 domain, then at least one of L1 and L2 comprise at least one amino acid modification in the CL domain; and/or if H1 comprises at least one amino acid modification in the VH domain, then at least one of L1 and L2 comprise at least one amino acid modification in the VL domain; or wherein if H2 comprises at least one amino acid modification in the CH1 domain, then at least one of L1 and L2 comprise at least one amino acid modification in the CL domain; and/or if H2 comprises at least one amino acid modification in the VH domain, then at least one of L1 and L2 comprise at least one amino acid modification in the VL domain.

70. The construct of any one of the preceding claims, wherein H1, L1, H2, and/or L2 comprises at least 1, 2, 3, 4, 5, 6, 7, 8, 9, or 10 amino acid mutations in the Fab region.

71. The construct according to any one of the preceding claims, wherein at least one of H1, H2, L1 and L2 comprises at least 2, 3, 4, 5, 6, 7, 8, 9, or 10 amino acid modifications of at least one constant domain and/or at least one variable domain.

72. The construct according to any one of the preceding claims, wherein when both L1 and L2 are co-expressed with at least one of H1 and H2, the relative pairing of the at least one of H1-L1 and H2-L2 heterodimer pair to that of the respective corresponding H1-L2 or H2-L1 heterodimer pair is greater than 50, 51, 52, 53, 54, 55, 56, 57, 58, 59, 60, 61, 62, 63, 64, 65, 66, 67, 68, 69, 70, 71, 72, 73, 74, 75, 76, 77, 78, 79, 80, 81, 82, 83, 84, 85, 86, 87, 88, 89, 90, 91, 92, 93, 94, 95, 96, 97, 98, or 99%, and wherein the relative pairing of the modified H1-L1 or H2-L2 heterodimer pair is greater than the respective relative pairing observed in the corresponding H1-L1 or H2-L2 heterodimer pair without the at least one amino acid modification.

73. The construct of any one of the preceding claims, wherein the thermal stability of the Fab region of at least one of the first and second heterodimers is within about 0, 1, 2, or 3°C of the T<sub>m</sub> of the corresponding heterodimer without the at least one amino acid modification or set of amino acid modifications.

74. The construct according to any one of the preceding claims, wherein the affinity of each heterodimer for the antigen to which it binds is within about 1, 2, 3, 4, 5, 6, 7, 8, 9, 10, 20, 25, 30, 35, 40, 45, or 50-fold of the affinity of the respective unmodified heterodimer for the same antigen as measured by surface plasmon resonance (SPR) or FACS.

75. The construct according to any one of the preceding claims, wherein at least one of H1 and L1 comprises at least one domain comprising at least one amino acid modification resulting in greater steric complementarity of amino acids when H1 pairs with L1 as compared to L2; or

wherein at least one of H2 and L2 comprises at least one domain comprising at least one amino acid modification resulting in greater steric complementarity of amino acids when H2 pairs with L2 as compared to L1; or

wherein at least one of H1 and L1 comprises at least one domain comprising at least one amino acid modification resulting in greater electrostatic complementarity between charged amino acids when H1 pairs with L1 as compared to L2; or

wherein at least one of H2 and L2 comprises at least one domain comprising at least one amino acid modification resulting in greater electrostatic complementarity between charged amino acids when H2 pairs with L2 as compared to L1; or

wherein at least one of H1 and L1 comprises at least one domain comprising at least one amino acid modification resulting in greater steric and electrostatic complementarity of amino acids when H1 pairs with L1 as compared to L2; or

wherein at least one of H2 and L2 comprises at least one domain comprising at least one amino acid modification resulting in greater steric and electrostatic complementarity of amino acids when H2 pairs with L2 as compared to L1; or

wherein at least one of H1 and L1 comprises at least one domain comprising at least one amino acid modification resulting in a covalent bond between H1 and L1; or

wherein at least one of H2 and L2 comprises at least one domain comprising at least one amino acid modification resulting in a covalent bond between H2 and L2.

76. The construct according to any one of the preceding claims, wherein H1, H2, L1, and L2 comprise a set of amino acid modifications selected from the group consisting of the unique identifier design sets shown in Table 5 – 6, 15 – 27, or 28a – 28c.

77. The construct of any one of the preceding claims, wherein the construct further comprises an Fc comprising a first CH3 sequence and a second CH3 sequence, wherein the first CH3 sequence is coupled, with or without one or more linkers, to the first heterodimer



and the second CH3 sequence is coupled, with or without one or more linkers to the second heterodimer.

78. The construct of claim 77, wherein the Fc is a human Fc, a human IgG1 Fc, a human IgA Fc, a human IgG Fc, a human IgD Fc, a human IgE Fc, a human IgM Fc, a human IgG2 Fc, a human IgG3 Fc, or a human IgG4 Fc.

79. The construct of claims 77 or 78, wherein the Fc is a heterodimeric Fc.

80. The construct of any one of claims 77-79, wherein the Fc comprises one or more modifications in at least one of the CH3 sequences.

81. The construct of any one of claims 77-80, wherein the dimerized CH3 sequences have a melting temperature ( $T_m$ ) as measured by DSF of about 68, 69, 70, 71, 72, 73, 74, 75, 76, 77, 77.5, 78, 79, 80, 81, 82, 83, 84, or 85°C or higher.

82. The construct of any one of claims 77-81, wherein the Fc is a heterodimer formed with a purity greater than about 75, 76, 77, 78, 79, 80, 81, 82, 83, 84, 85, 86, 87, 88, 89, 90, 91, 92, 93, 94, 95, 96, 97, 98, or 99% when produced; or wherein the Fc is a heterodimer formed with a purity greater than about 75, 76, 77, 78, 79, 80, 81, 82, 83, 84, 85, 86, 87, 88, 89, 90, 91, 92, 93, 94, 95, 96, 97, 98, or 99% when expressed or when expressed via a single cell.

83. The construct of any one of claims 77-82, wherein the Fc comprises one or more modifications in at least one of the CH3 sequences that promote the formation of a heterodimeric Fc with stability comparable to a wild-type homodimeric Fc.

84. The construct of any one of claims 78-84, wherein the Fc comprises:

i) a heterodimeric IgG1 Fc having the modifications L351Y\_F405A\_Y407V in the first Fc polypeptide, and the modifications T366L\_K392M\_T394W in the second Fc polypeptide;

ii) a heterodimeric IgG1 Fc having the modifications L351Y\_F405A\_Y407V in the first Fc polypeptide, and the modifications T366L\_K392L\_T394W in the second Fc polypeptide;

iii) a heterodimeric IgG1 Fc having the modifications T350V\_L351Y\_F405A\_Y407V in the first Fc polypeptide, and the modifications T350V\_T366L\_K392L\_T394W in the second Fc polypeptide;

iv) a heterodimeric IgG1 Fc having the modifications T350V\_L351Y\_F405A\_Y407V in the first Fc polypeptide, and the modifications T350V\_T366L\_K392M\_T394W in the second Fc polypeptide; or

v) a heterodimeric IgG1 Fc having the modifications T350V\_L351Y\_S400E\_F405A\_Y407V in the first Fc polypeptide, and the modifications T350V\_T366L\_N390R\_K392M\_T394W in the second Fc polypeptide.

85. The construct of any one of claims 77-84, wherein the Fc further comprises at least one CH2 sequence.

86. The construct of claim 85, wherein the CH2 sequence(s) of the Fc comprises one or more modifications.

87. The construct of any one of claims 77-86, wherein the Fc comprises one or more modifications to promote selective binding of Fc-gamma receptors.

88. The construct according to any one of claims 77-87, wherein the Fc is coupled to the heterodimers by one or more linkers, or wherein the Fc is coupled to H1 and H2 by one or more linkers.

89. The construct of claim 88, wherein the one or more linkers are one or more polypeptide linkers.

90. The construct of claim 88, wherein the one or more linkers comprises one or more antibody hinge regions.

91. The construct of claim 88, wherein the one or more linkers comprises one or more IgG1 hinge regions.
92. The construct of any one of claims 88-91, wherein the one or more linkers comprise one or more modifications.
93. The construct of claim 92, wherein the one or more modifications promote selective binding of Fc-gamma receptors.
94. The construct according to any one of the preceding claims, wherein the at least one amino acid modification is at least one amino acid mutation or wherein the at least one amino acid modification is at least one amino acid substitution.
95. The construct according to any one of the preceding claims, wherein the sequences of each of H1, H2, L1, and L2 are derived from human sequences.
96. The construct according to any one of the preceding claims, wherein the construct is multispecific or bispecific.
97. The construct according to any one of the preceding claims, wherein the construct is multivalent or bivalent.
98. An isolated polynucleotide or set of isolated polynucleotides comprising at least one sequence that encodes the construct of any one of the preceding claims.
99. The isolated polynucleotide or set of isolated polynucleotides of claim 98, wherein the polynucleotide or set of polynucleotides is cDNA.
100. A vector or set of vectors comprising one or more of the polynucleotides or sets of polynucleotides according to claim 98 or 99.

101. The vector or set of vectors according to claim 100, which is selected from the group consisting of a plasmid, a multi-cistronic vector, a viral vector, a non-episomal mammalian vector, an expression vector, and a recombinant expression vector.

102. An isolated cell comprising a polynucleotide or set of polynucleotides according to claim 98 or 99, or a vector or set of vectors of claims 100 or 101.

103. The isolated cell according to claim 102, wherein the cell is a yeast cell, a bacterial cell, a hybridoma, a Chinese Hamster Ovary (CHO) cell, or a HEK293 cell.

104. A pharmaceutical composition comprising the construct of any one of the preceding claims and a pharmaceutically acceptable carrier.

105. The pharmaceutical composition according to claim 104, further comprising one or more substances selected from the group consisting of a buffer, an antioxidant, a low molecular weight molecule, a drug, a protein, an amino acid, a carbohydrate, a lipid, a chelating agent, a stabilizer, and an excipient.

106. Use of the construct according to any one of claims 1 - 96 or the pharmaceutical composition according to claims 104 or 105 for the treatment of a disease or disorder in a subject or in the manufacture of a medicine.

107. A method of treatment of a subject having a disease or disorder comprising administering to the subject a construct according to any one of claims 1 - 96 or a pharmaceutical composition according to claims 104 or 105.

108. A method of obtaining the construct according to any one of claims 1-96 from a host cell culture, the method comprising the steps of:

(a) obtaining a host cell culture comprising at least one host cell comprising one or more nucleic acid sequences encoding the construct; and

(b) recovering the construct from the host cell culture.

109. A method of obtaining the construct according to any one of claims 1-96, comprising the steps of:

(a) obtaining H1, L1, H2, and L2;

(b) allowing H1 to pair preferentially with L1 as compared to L2 and H2 to pair preferentially with L2 as compared to L1; and

(c) obtaining the construct.

110. A method of preparing the construct according to any one of claims 1 to 96 comprising:

a. Obtaining a polynucleotide or set of polynucleotides encoding at least one construct;

b. Determining the optimal ratios of each of the polynucleotide or set of polynucleotides for introduction into at least one host cell, wherein the optimal ratios are determined by assessing the amount of H1-L1 and H2-L2 heterodimer pairs formed upon expression of H1, L1, H2, and L2 as compared to mispaired H1-L2 and H2-L1 heterodimer pairs formed upon expression of H1, L1, H2, and L2;

c. Selecting a preferred optimal ratio, wherein transfection of at least one host cell with the preferred optimal ratio of the polynucleotide or set of polynucleotides results in expression of the construct;

d. Transfecting the at least one host cell with the optimal ratio of the polynucleotide or set of polynucleotides; and

e. Culturing the at least one host cell to express the construct.

111. The method of claim 110, wherein selecting the optimal ratio is assessed by transfection in a transient transfection system.

112. The method of claims 110 or 111, wherein transfection of the at least one host cell with the preferred optimal ratio of the polynucleotide or set of polynucleotides results in optimal expression of the construct.

113. The method of any one of claims 110-112, wherein the construct comprises an Fc comprising at least two CH3 sequences, wherein the Fc is coupled, with or without one or more linkers, to the first heterodimer and the second heterodimer.

114. The method of claim 113, wherein the Fc is a heterodimer, optionally comprising one or more amino acid modifications.

115. A computer-readable storage medium storing  
a dataset comprising data representing complementary mutations in a first heterodimer comprising a first immunoglobulin heavy chain polypeptide sequence (H1) and a first immunoglobulin light chain polypeptide sequence (L1); and a second heterodimer comprising a second immunoglobulin heavy chain polypeptide sequence (H2) and a second immunoglobulin light chain polypeptide sequence (L2), wherein H1 and H2 each comprise at least a heavy chain variable domain (VH domain) and a heavy chain constant domain (CH1 domain); wherein L1 and L2 each comprise at least a light chain variable domain (VL domain) and a light chain constant domain (CL domain), and wherein the dataset of complementary mutations comprises data representing those mutations listed in Tables 4 – 6, 15 – 27, 28a – 28c or a subset of those mutations.

116. A method of producing a bi-specific antigen binding polypeptide construct, said bi-specific construct comprising a first heterodimer comprising a first immunoglobulin heavy chain polypeptide sequence (H1), and a first immunoglobulin light chain polypeptide sequence (L1) from a first mono-specific antigen binding polypeptide; and a second heterodimer comprising a second immunoglobulin heavy chain polypeptide sequence (H2), and a second immunoglobulin light chain polypeptide sequence (L2) from a second mono-specific antigen binding polypeptide, wherein H1 and H2 each comprise at least a heavy chain variable

domain (VH domain) and a heavy chain constant domain (CH1 domain); wherein L1 and L2 each comprise at least a light chain variable domain (VL domain) and a light chain constant domain (CL domain), the method comprising:

a. introducing one or more complementary mutations from the dataset of claim 115 into the first heterodimer and/or the second heterodimer; and

b. co-expressing the first heterodimer and the second heterodimer in at least one host cell to produce an expression product comprising the bi-specific construct.

117. The method of claim 116, further comprising determining the amount of the bi-specific construct in the expression product relative to other polypeptide products to select a preferred subset of complementary mutations.

118. The method of claims 116 or 117 wherein the bi-specific construct is produced with a purity of greater than 70% compared to the other polypeptide products.

119. The method of any one of claims 116-118, further comprising the step of adding additional amino acid modifications to at least one of H1, H2, L1, or L2 to increase the purity of the bi-specific construct compared to the other polypeptide products.

120. The method of any one of claims 116-119, wherein the construct comprises an Fc comprising at least two CH3 sequences, wherein the Fc is coupled, with or without one or more linkers, to the first heterodimer and the second heterodimer.

121. The method of claim 120, wherein the Fc is a heterodimer, optionally comprising one or more amino acid modifications.

122. The method of any one of claims 116-121, wherein the antigen binding polypeptide is an antibody, a single chain monoclonal antibody, a Fab, or a single chain Fab.

123. A method of preparing the isolated antigen binding polypeptide construct according to any one of claims 1 to 96 comprising expressing H1, H2, L1, and L2 in at least one expression system to produce an expression product; characterizing the expression product; and selecting the expression system wherein more than 90% of the expression product is the isolated antigen binding polypeptide construct.

124. The construct of claim 1, wherein the amino acid modifications are selected from SMCA designs corresponding to unique identifiers

9561-9095\_1, 9561-9095\_2, where H1 comprises L124W, L143E, K145T, and Q179E, L1 comprises Q124R, V133A, S176T, and T178R, H2 comprises L124A, L143F, and Q179K, and L2 comprises Q124E, V133W, S176T, T178L, and T180E;

9121-9373\_1, 9121-9373\_2, where H1 comprises L124E and H172T, L1 comprises V133G, N137K, S174R, and S176R, H2 comprises L124R and H172R, and L2 comprises V133G, S176D, and T178D;

9116-9349\_1, 9116-9349\_2, where H1 comprises L124E and A139W, L1 comprises F116A, V133G, L135V and S176R, H2 comprises L124R, A139G and V190A, and L2 comprises V133G, L135W and S176D;

9134-9521\_1, 9134-9521\_2, where H1 comprises L124E, K145T and Q179E, L1 comprises S131K, V133G and S176R, H2 comprises L124R and S186R, and L2 comprises V133G, S176D and T178D;

9286-9402\_1, 9286-9402\_2, where H1 comprises L124E, L143E and K145T, L1 comprises Q124K, V133G and S176R, H2 comprises L124R and Q179K, and L2 comprises V133G, S176D and T178E;

9667-9830\_1, 9667-9830\_2, where H1 comprises L143E, K145T and Q179E, L1 comprises Q124R and T178R, H2 comprises S186K, and L2 comprises Q124E, Q160E and T178E;



9696-9848\_1, 9696-9848\_2, where H1 comprises L143E, K145T, Q179E and S188L, L1 comprises Q124R and T178R, H2 comprises S186K, and L2 comprises Q124E, S176L and T180E;

9060-9756\_1, 9060-9756\_2, where H1 comprises A139W, L143E, K145T and Q179E, L1 comprises F116A, Q124R, L135V and T178R, H2 comprises Q179K, and L2 comprises Q124E, L135W, Q160E and T180E;

9682-9740\_1, 9682-9740\_2, where H1 comprises L143E, K145T and Q179E, L1 comprises Q124R and T178R, H2 comprises L143R, and L2 comprises Q124E and V133E;

9049-9759\_1, 9049-9759\_2, where H1 comprises A139C, L143E, K145T and Q179E, L1 comprises F116C, Q124R and T178R, H2 comprises Q179K, and L2 comprises Q124E, Q160E and T180E; and

9820-9823\_1, 9820-9823\_2 where H1 comprises Q39E, L143E, K145T and Q179E, L1 comprises Q38R, Q124R, Q160K and T178R, H2 comprises Q39R, H172R and Q179K, and L2 comprises Q38E, Q124E, Q160E and T180E,

of Table 35a.

125. The construct of claim 1, wherein the amino acid modifications are selected from SMCA designs corresponding to unique identifiers

9327-6054\_1, where H1 comprises L124E and L143F, L1 comprises V133G and S176R, H2 comprises L124R, and L2 comprises V133G, S176D and T178D;

9815-9825\_1, 9815-9825\_2, where H1 comprises Q39E and L124E, L1 comprises Q38R, V133G and S176R, H2 comprises Q39R and L124R, and L2 comprises Q38E, V133G and S176D;

9587-9735\_1, 9587-9735\_2, where H1 comprises L143E and K145T, L1 comprises Q124R, H2 comprises L143R, and L2 comprises Q124E and V133E;

3522\_1, 3522\_2, where H1 comprises L45P, L143E and K145T, L1 comprises P44F, Q124R, Q160K and T178R, H2 comprises D146G and Q179K, and L2 comprises Q124E, Q160E and T180E; and

3519\_1, 3519\_2, where H1 comprises L45P, K145T, H172R and Q179E, L1 comprises P44F and S131K, H2 comprises H172R and S186R, and L2 comprises Q124E, Q160E and T180E,

of Table 35b.

126. The construct of claim 1, wherein the amino acid modifications are selected from SMCA designs corresponding to unique identifiers

9060-9756, where H1 comprises A139W, L143E, K145T and Q179E, L1 comprises F116A, Q124R, L135V and T178R, H2 comprises Q179K, and L2 comprises Q124E, L135W, Q160E and T180E;

9820-9823, where H1 comprises Q39E, L143E, K145T and Q179E, L1 comprises Q38R, Q124R, Q160K and T178R, H2 comprises Q39R, H172R and Q179K, and L2 comprises Q38E, Q124E, Q160E and T180E,

3519, where H1 comprises L45P, K145T, H172R and Q179E, L1 comprises P44F and S131K, H2 comprises H172R and S186R, and L2 comprises Q124E, Q160E and T180E,

9049-9759, where H1 comprises A139C, L143E, K145T and Q179E, L1 comprises F116C, Q124R and T178R, H2 comprises Q179K, and L2 comprises Q124E, Q160E and T180E;

3522, where H1 comprises L45P, L143E and K145T, L1 comprises P44F, Q124R, Q160K and T178R, H2 comprises D146G and Q179K, and L2 comprises Q124E, Q160E and T180E;

9696-9848, where H1 comprises L143E, K145T, Q179E and S188L, L1 comprises Q124R and T178R, H2 comprises S186K, and L2 comprises Q124E, S176L and T180E;

9692-9846, where H1 comprises L143E, K145T, Q179E and S188L, L1 comprises Q124R and T178R, H2 comprises S186K, and L2 comprises Q124E, S131T, T178Y and T180E;

9986-9978, where H1 comprises L143E and K145T, L1 comprises Q124R, Q160K and T178R, H2 comprises S186K, and L2 comprises S131E, and

9667-9830, where H1 comprises L143E, K145T and Q179E, L1 comprises Q124R and T178R, H2 comprises S186K, and L2 comprises Q124E, Q160E and T178E.

127. The construct of claim 1, wherein the amino acid modifications are selected from SMCA designs corresponding to unique identifiers

9587-9735, where H1 comprises L143E and K145T, L1 comprises Q124R, H2 comprises L143R, and L2 comprises Q124E and V133E;

9561-9095, where H1 comprises L124W, L143E, K145T, and Q179E, L1 comprises Q124R, V133A, S176T, and T178R, H2 comprises L124A, L143F, and Q179K, and L2 comprises Q124E, V133W, S176T, T178L, and T180E;

9611-9077, where H1 comprises L143E, K145T and H172R, L1 comprises Q124R, Q160K and T178R, H2 comprises H172T and Q179K, and L2 comprises Q124E, N137K, Q160E, S174R and T180E;

9168-9342, where H1 comprises L124E and K228D, L1 comprises S121K, V133G and S176R, H2 comprises L124R and A125R, and L2 comprises V133G and S176D;

9164-9555, where H1 comprises L124E, K145T and Q179E, L1 comprises S131R, V133G and S176R, H2 comprises L124R and S186R, and L2 comprises V133G, S176D and T180E;

9279-9518, where H1 comprises L124E, L143E and K145T, L1 comprises Q124K, V133G and S176R, H2 comprises L124R and S186R, and L2 comprises V133G, S176D and T178D;

9290-9432, where H1 comprises L124E, L143E and K145T, L1 comprises Q124K, V133G and S176R, H2 comprises L124R and Q179K, and L2 comprises V133G, S176D and T180E;

9142-9414, where H1 comprises L124E, K145T and Q179E, L1 comprises S131K, V133G and S176R, H2 comprises L124R and Q179K, and L2 comprises V133G, S176D and T178E;

9060-9756, where H1 comprises A139W, L143E, K145T and Q179E, L1 comprises F116A, Q124R, L135V and T178R, H2 comprises Q179K, and L2 comprises Q124E, L135W, Q160E and T180E;

9121-9373, where H1 comprises L124E and H172T, L1 comprises V133G, N137K, S174R, and S176R, H2 comprises L124R and H172R, and L2 comprises V133G, S176D, and T178D;

9066-9335, where H1 comprises F122C and L124E, L1 comprises Q124C, V133G and S176R, H2 comprises L124R, and L2 comprises V133G and S176D;

9820-9823, where H1 comprises Q39E, L143E, K145T and Q179E, L1 comprises Q38R, Q124R, Q160K and T178R, H2 comprises Q39R, H172R and Q179K, and L2 comprises Q38E, Q124E, Q160E and T180E;

9814-9828, where H1 comprises Q39E, K145T and Q179E, L1 comprises Q38R and S131K, H2 comprises Q39R and S186R, and L2 comprises Q38E, Q124E, Q160E and T180E;

9696-9848, where H1 comprises L143E, K145T, Q179E and S188L, L1 comprises Q124R and T178R, H2 comprises S186K, and L2 comprises Q124E, S176L and T180E;

9667-9830, where H1 comprises L143E, K145T and Q179E, L1 comprises Q124R and T178R, H2 comprises S186K, and L2 comprises Q124E, Q160E and T178E;

9986-9978, where H1 comprises L143E and K145T, L1 comprises Q124R, Q160K and T178R, H2 comprises S186K, and L2 comprises S131E;

3522, where H1 comprises L45P, L143E and K145T, L1 comprises P44F, Q124R, Q160K and T178R, H2 comprises D146G and Q179K, and L2 comprises Q124E, Q160E and T180E, and

3519, where H1 comprises L45P, K145T, H172R and Q179E, L1 comprises P44F and S131K, H2 comprises H172R and S186R, and L2 comprises Q124E, Q160E and T180E.

Claims 124 and 125 have been amended to recite the specific amino acid substitutions corresponding to the unique identifiers listed in these claims. Support for these amendments may be found in the application as filed, for example, in Table 5.

Claims 126 and 127 have been added. Support for these new claims may also be found in the application as filed, for example, in Table 5.







FIG. 1C

VL ( $\lambda$ banda)

	FR1	CDR1	FR2	CDR2	FR3	CDR3
D3H44	DIQMTQSPSSLSASVGRVTITC * * * * * * * * * *	R-AS-RDIKS-YLN * * * * * * *	WYQQKPKAPKVLII * * * * * * * * * *	YATS-----LAE * * * * * *	GVPSRFSGSQ--SNTDYTLTITSSLQPEDFATYYC * * * * * * * * * *	LQRCSEF----- * * * * * *
VLII	QSVLTQPPS-VSEAPRQRTIISC * * * * * * * * * *	SGSS-SNIGNNAVN * * * * * * * * * *	WYQQLPKGKAPKLLII * * * * * * * * * *	YDDL-----LPS * * * * * * * * * *	GVSDRFSGSK--SNTSASLAIISGLQSEDEADYYC * * * * * * * * * *	AAWDPSLNG--- * * * * * * * * * *
VLIII	SYELTQPPS-VSVPQGTASITC * * * * * * * * * *	SGDK---LGDKYAC * * * * * * * * * *	WYQQKPKGQSPVLVI * * * * * * * * * *	EVSK-----RPS * * * * * * * * * *	GVSDRFSGSK--SNTASLTVSGLQAEDEADYYC * * * * * * * * * *	SSYAGSNFN--- * * * * * * * * * *
VLIV	LPVLTQPPS-ASALLGASIKLTC * * * * * * * * * *	TLSS--EHSYTIIE * * * * * * * * * *	WYQCRPGRSPQYIMK * * * * * * * * * *	QDSK-----RPS * * * * * * * * * *	GIEPRFSSN--SNTATLTIISGLQAEDEADYYC * * * * * * * * * *	QAWDSTA--- * * * * * * * * * *
VLV	QPVLTPPS-VSASFGESARLTC * * * * * * * * * *	TLPFDINVGSYNII * * * * * * * * * *	WYQCKPGRPPRVLII * * * * * * * * * *	VKSDGSH-SKGD * * * * * * * * * *	GIEPRFMSS--SGADRYLTFISGLQSEDEADYYC * * * * * * * * * *	GESHTIDSSQVG * * * * * * * * * *
VLVI	NFMELTQPHS-VSEPKIVTISC * * * * * * * * * *	TRSS-GSIAISNIVQ * * * * * * * * * *	WYQCRPSSPTTVII * * * * * * * * * *	YYSDSK-GQGS * * * * * * * * * *	GVPSRFSGSKDASANTGILLISGLQSEDEADYYC * * * * * * * * * *	MIWPSNAS--- * * * * * * * * * *
VLVII	QTVVTPPS-LTVSPQGTITLTC * * * * * * * * * *	ASSTQAVTISGYVFN * * * * * * * * * *	WYQCKPQAPRALLI * * * * * * * * * *	EDNQ-----RPS * * * * * * * * * *	GVSDRFSSGIDSSNSASLTIISGLKTEDEADYYC * * * * * * * * * *	QSYDSSN--- * * * * * * * * * *
VLIX	QVLTQPPS-FVSFPGGTIVLTC * * * * * * * * * *	GLSSGSYVTSYVPS * * * * * * * * * *	WYQQTPGQAPRLLI * * * * * * * * * *	STNT-----RPS * * * * * * * * * *	WTEARFSGSLIG--CKAALTLISGLQSEDEADYYC * * * * * * * * * *	LLYYGGAQ--- * * * * * * * * * *
VLX	QAGLTQPPS-VSKGLRQTATLTC * * * * * * * * * *	TLGNS-RNVGNCQQA * * * * * * * * * *	WYQQRPKGPRFVMR * * * * * * * * * *	VGTGGIVGSKGD * * * * * * * * * *	GVSDRFSGSILG--NKAALTIISGLQAEDEADYYC * * * * * * * * * *	VLYMGSGI--- * * * * * * * * * *

CDR3

D3H44	WTFGQTKVEIK * * * * *
IGLJ1*01	YVFGTCTKVTVL
IGLJ2*01	VVFGGQTKLTVL
IGLJ3*01	VVFGGQTKLTVL
IGLJ4*01	FVFGGQTLIIL
IGLJ5*01	WVFGEGTETVL
IGLJ6*01	NVFGSCTKVTVL
IGLJ7*01	AVFGGQTLTVL





FIG. 2

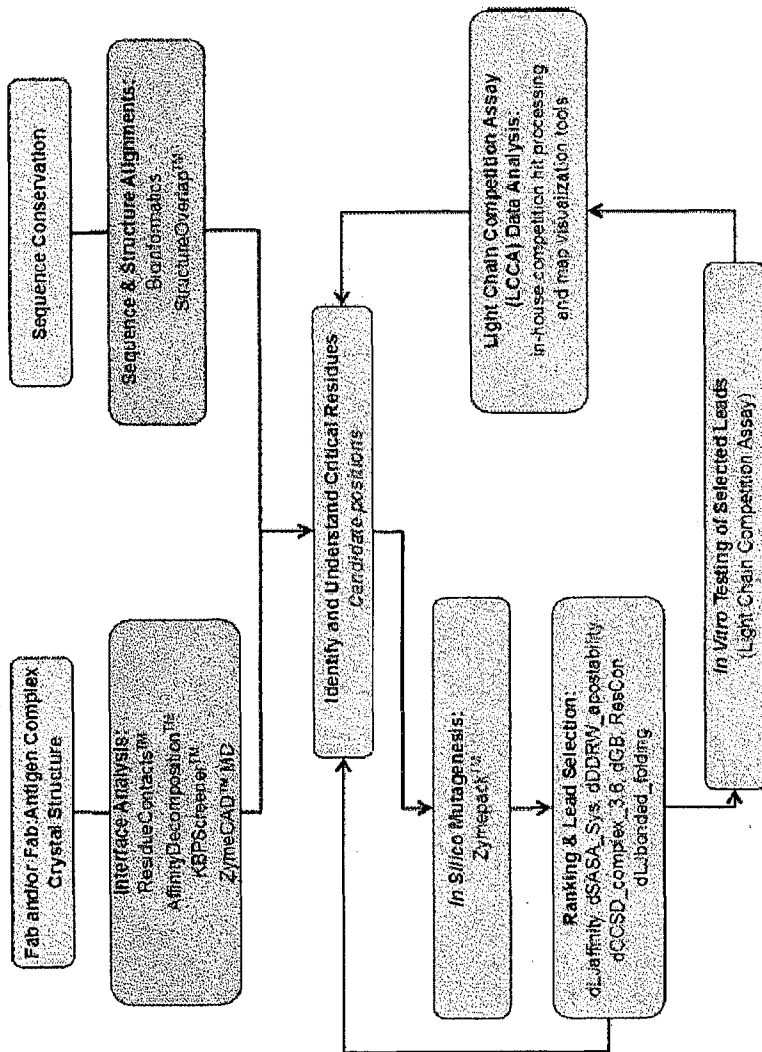

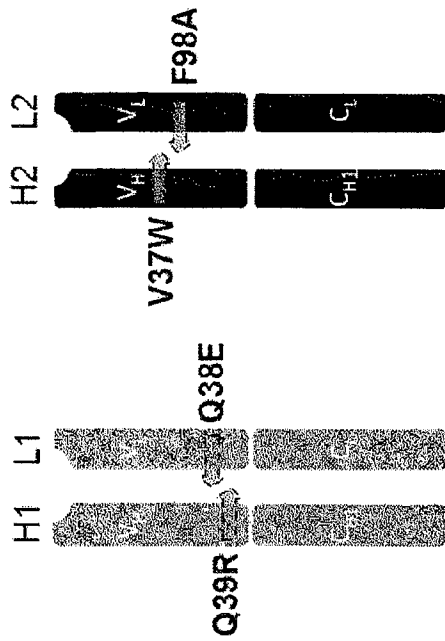
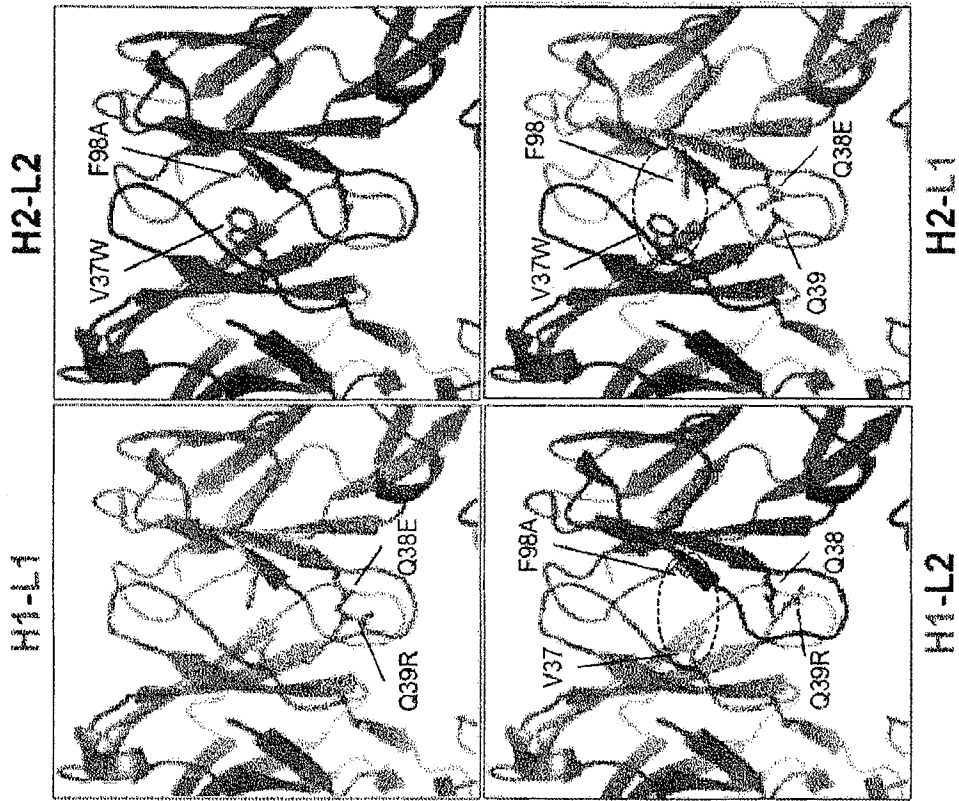

FIG. 3

FIG. 4

**Assay Requirements:**

**Engineering Goal:**  $H1-L1 + H2-L2 + H1-L2 + H2-L1$



Quantification of

**Assay Requirement:**  $H1-L1 : H1-L2 \text{ and } H2-L2 : H2-L1$   
ratios



Separate Quantification of

- Simplified Assay:**
1.  $H1 + L1 + L2 \Rightarrow H1-L1 + H1-L2$
  2.  $H2 + L2 + L1 \Rightarrow H2-L2 + H2-L1$

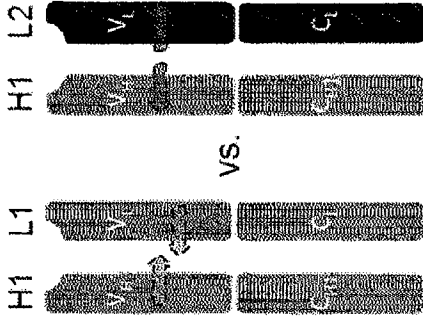

9/27

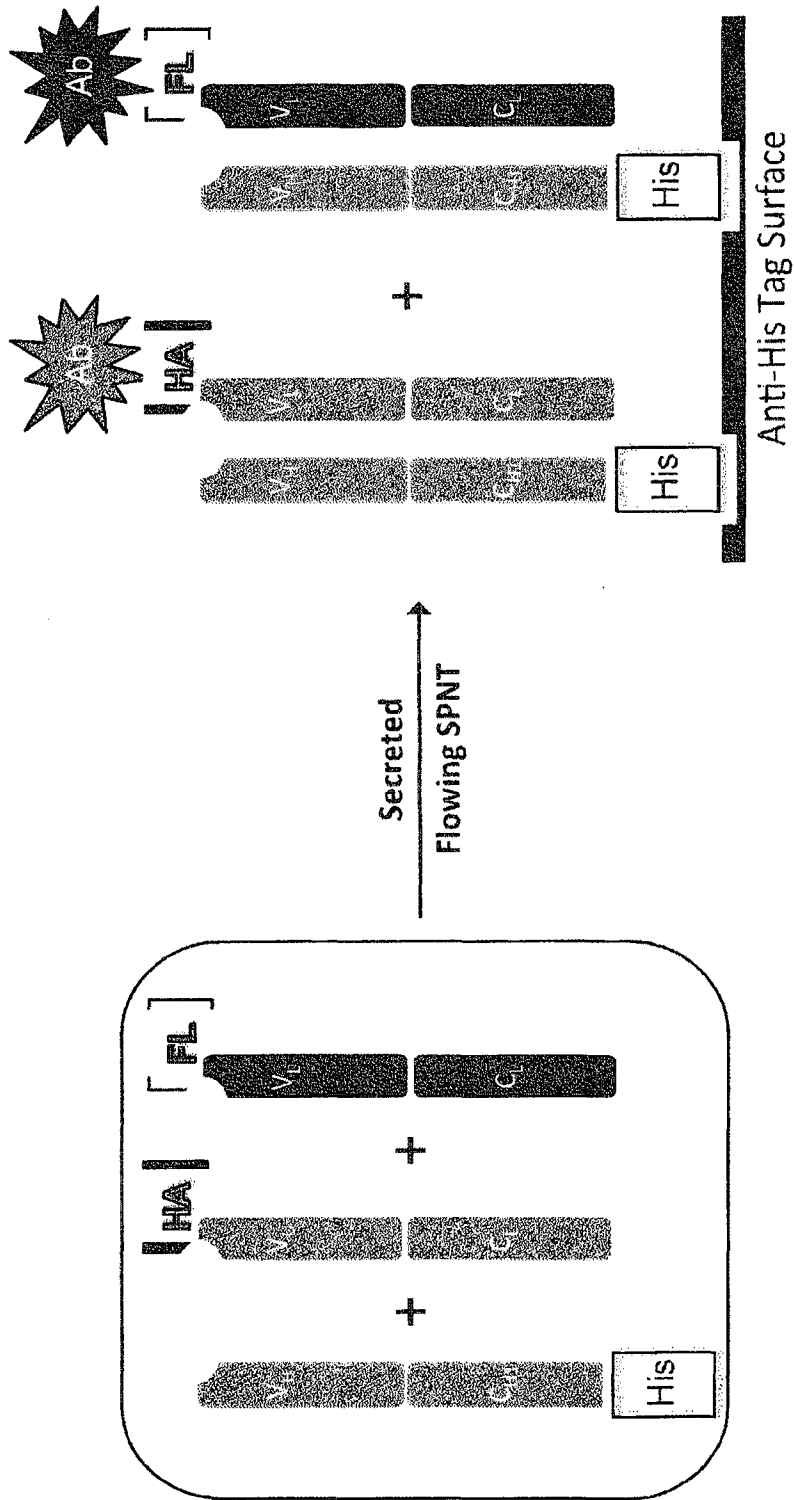
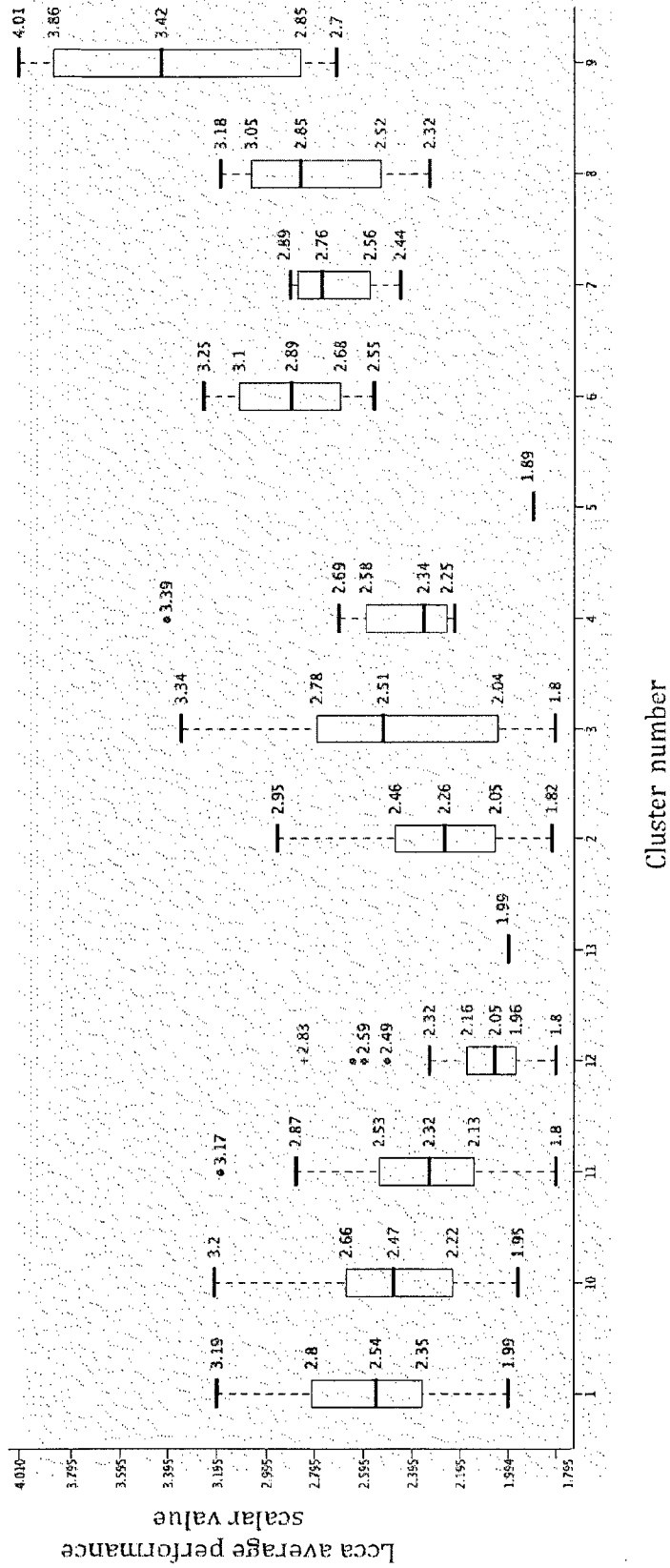

FIG. 5

10/27

FIG. 6





11/27

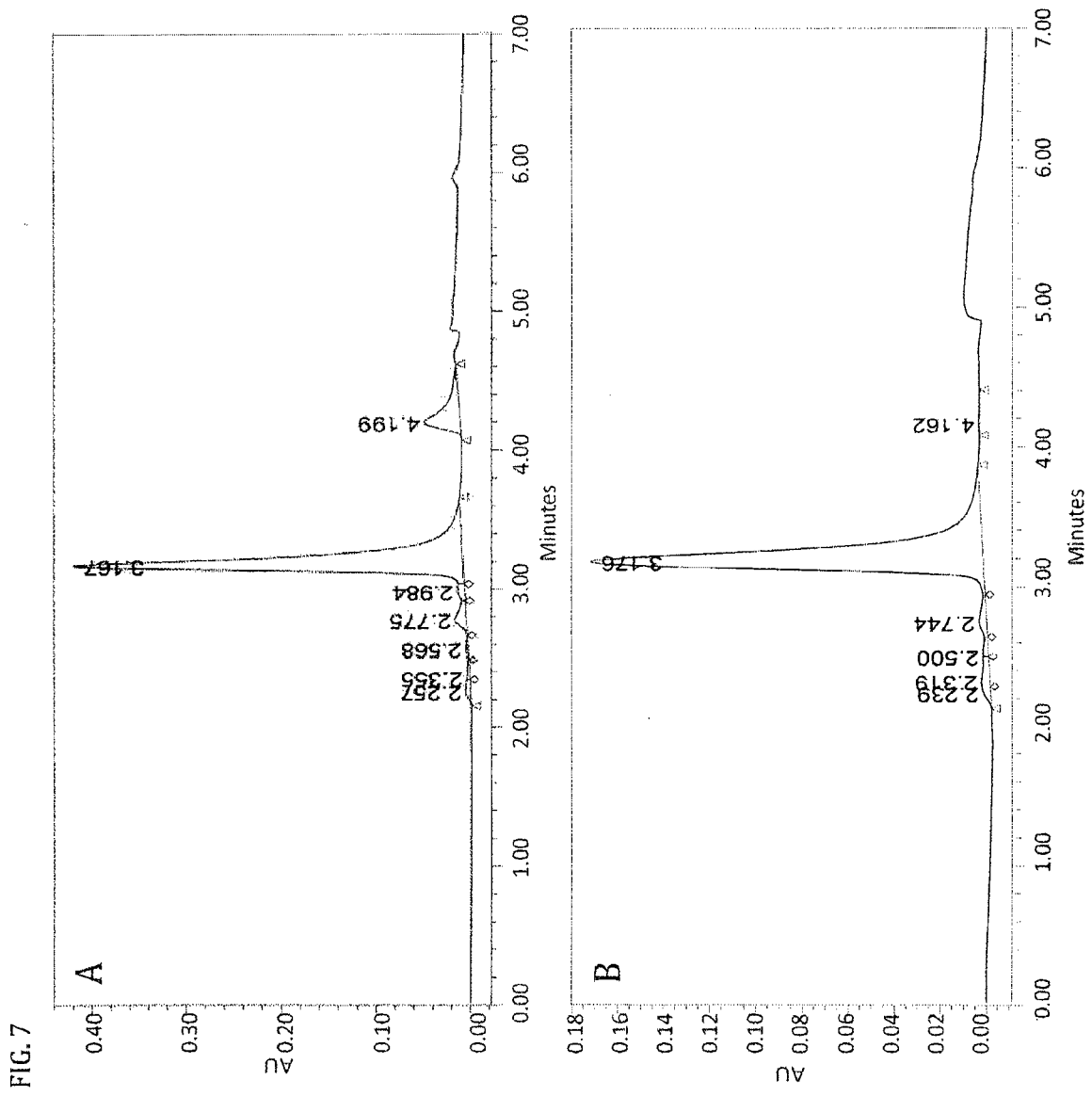

FIG. 8

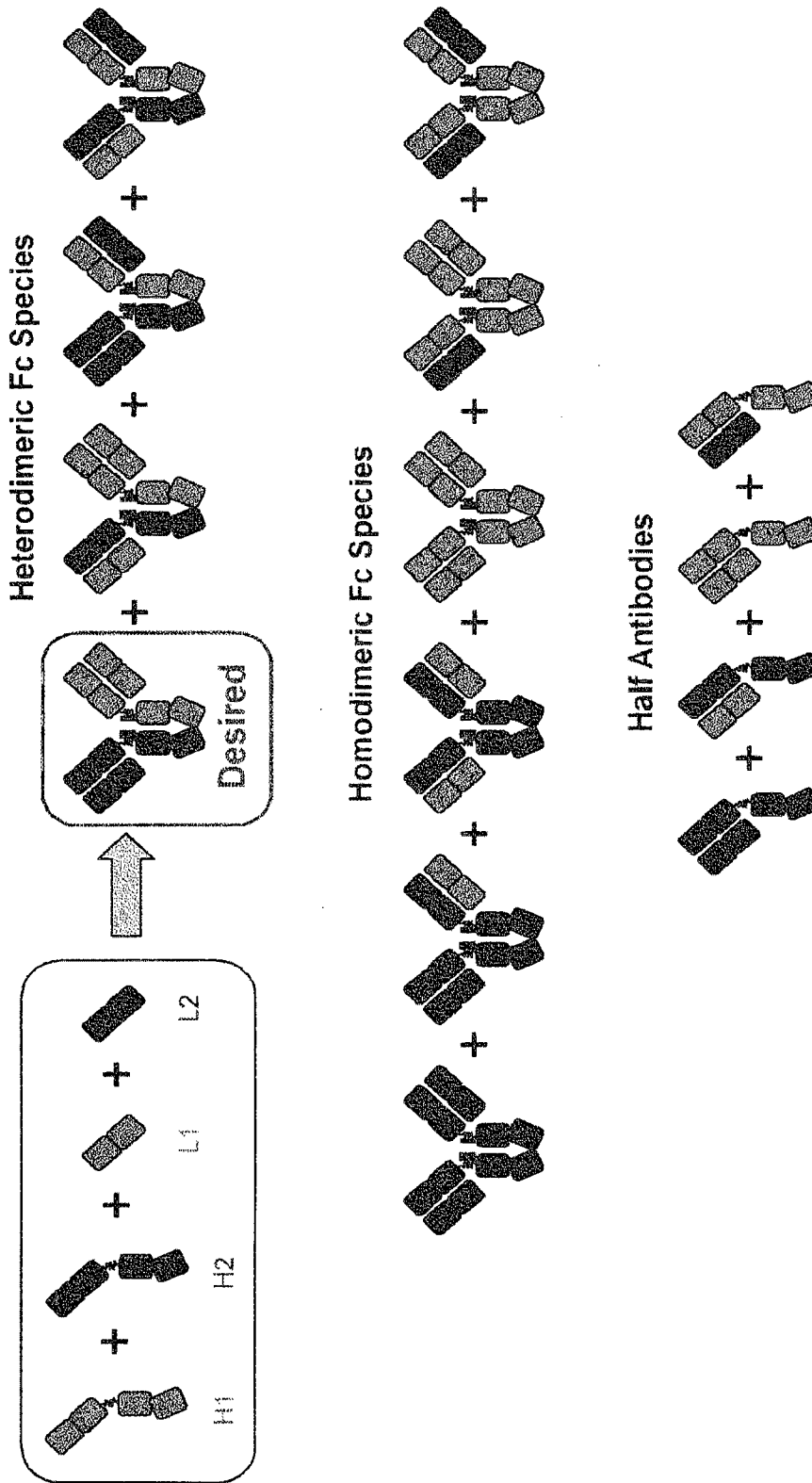
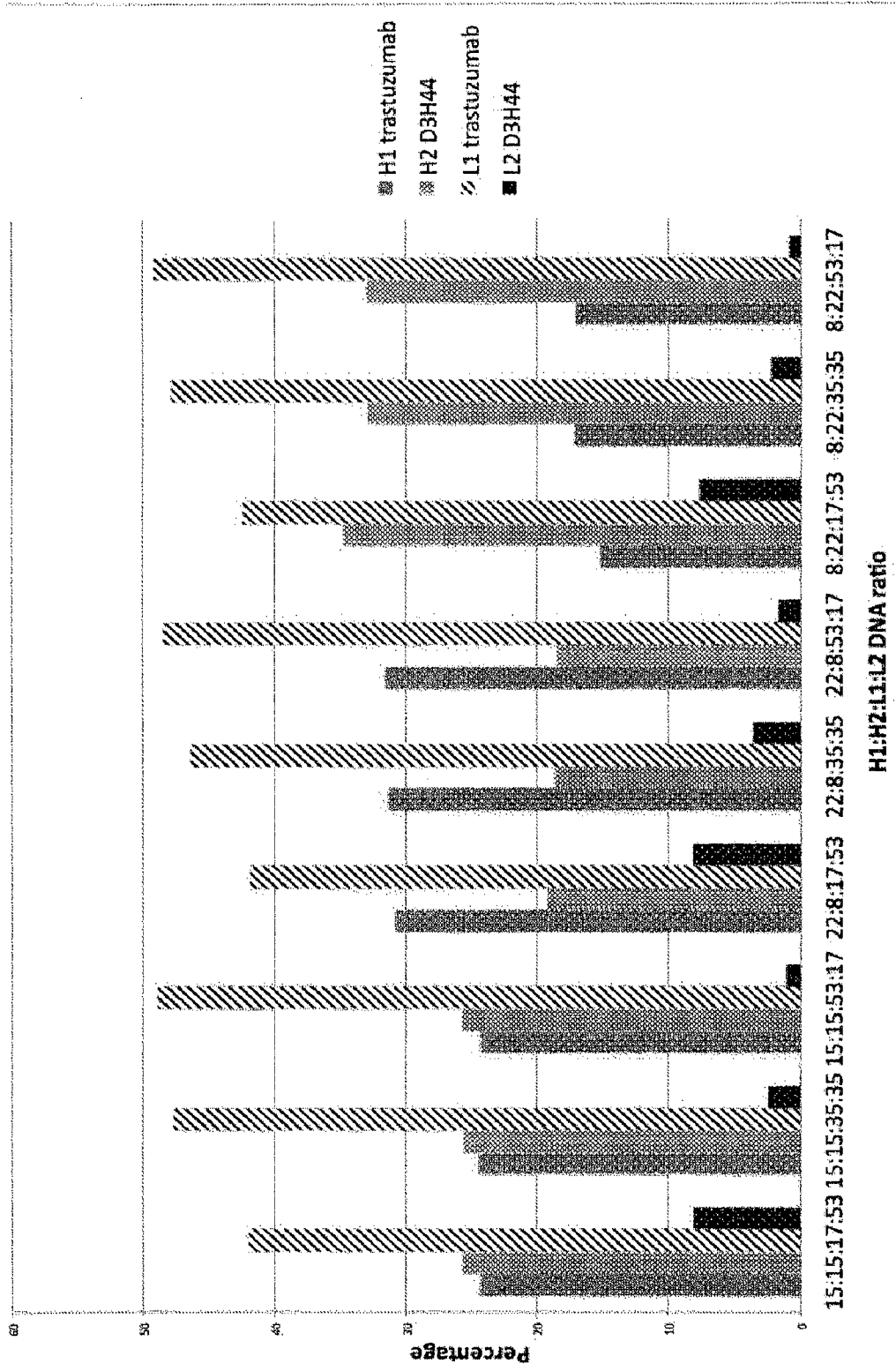
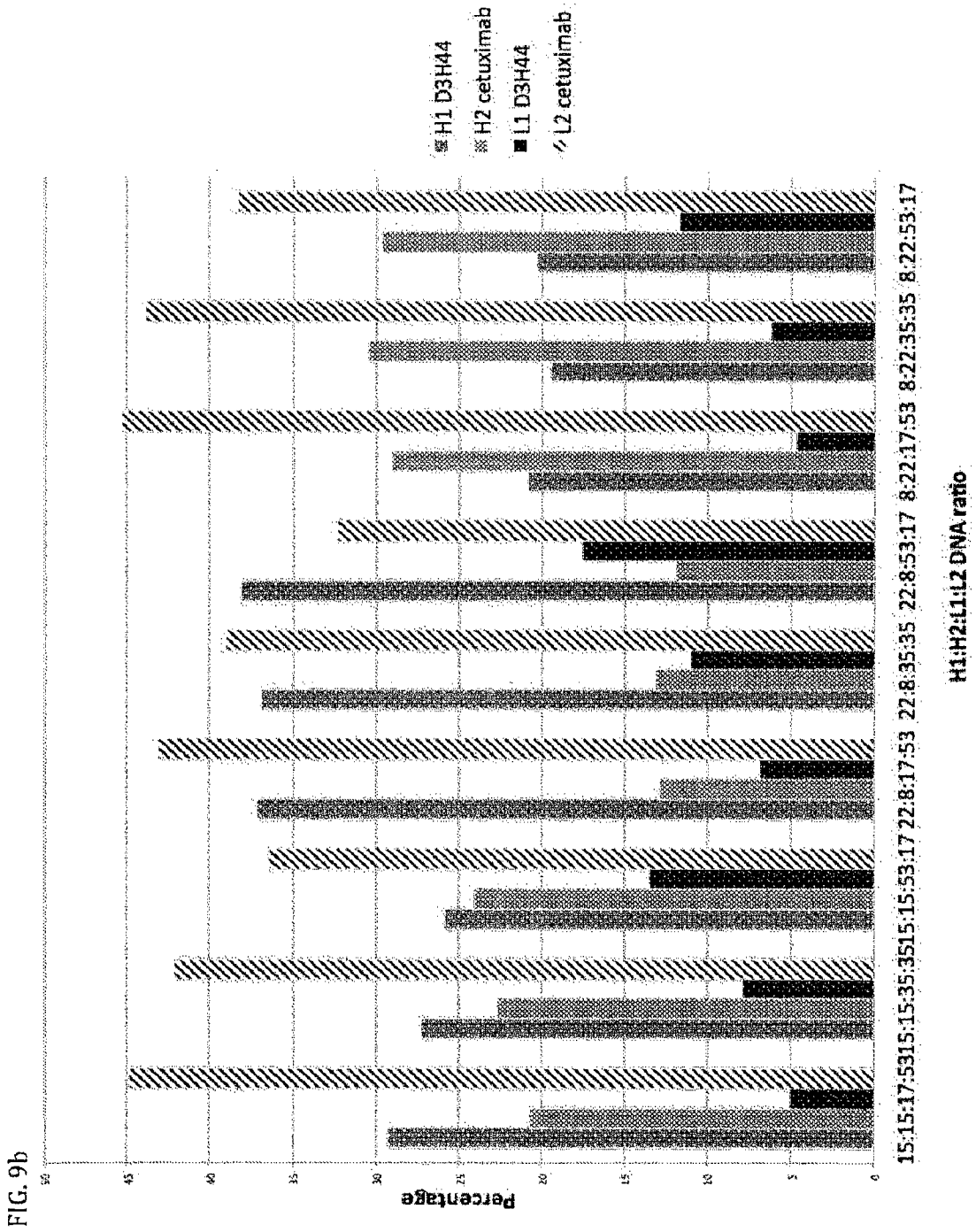

FIG. 9a





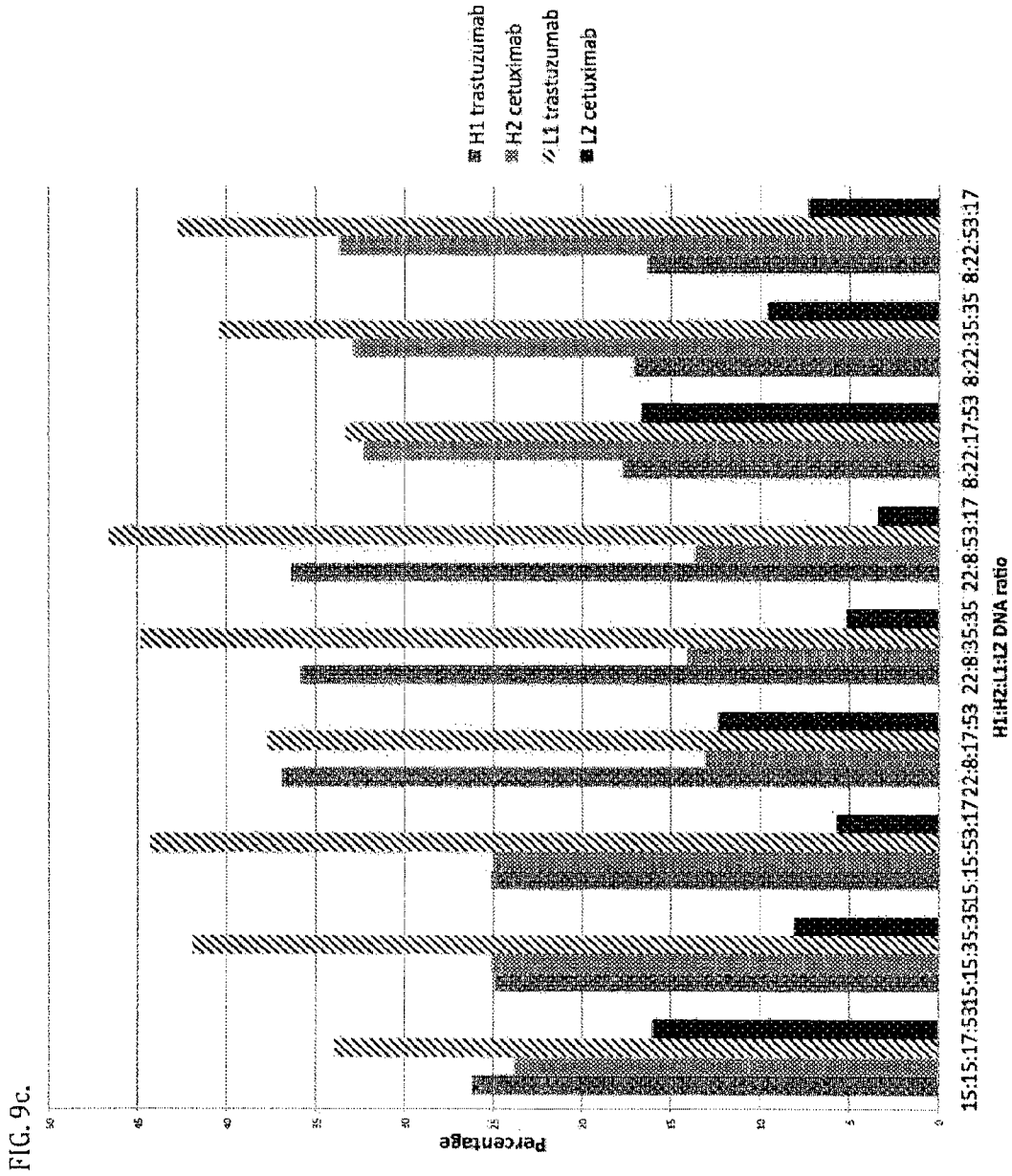
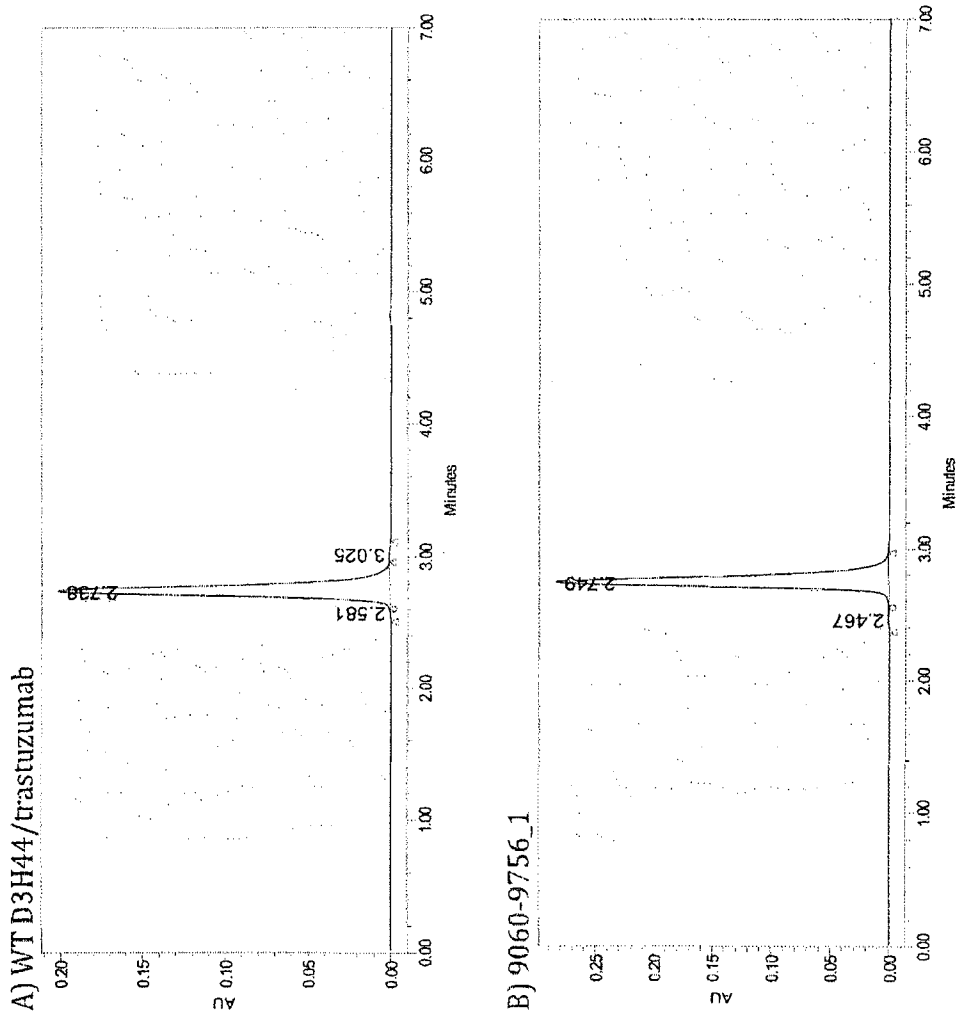
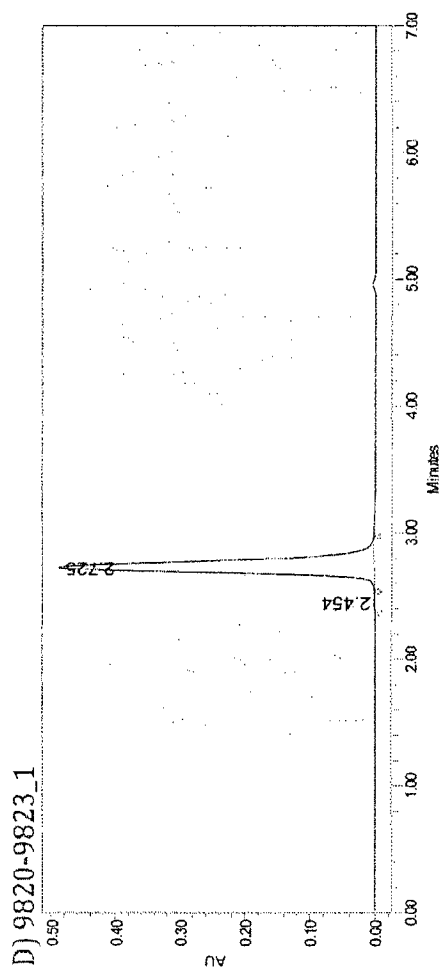
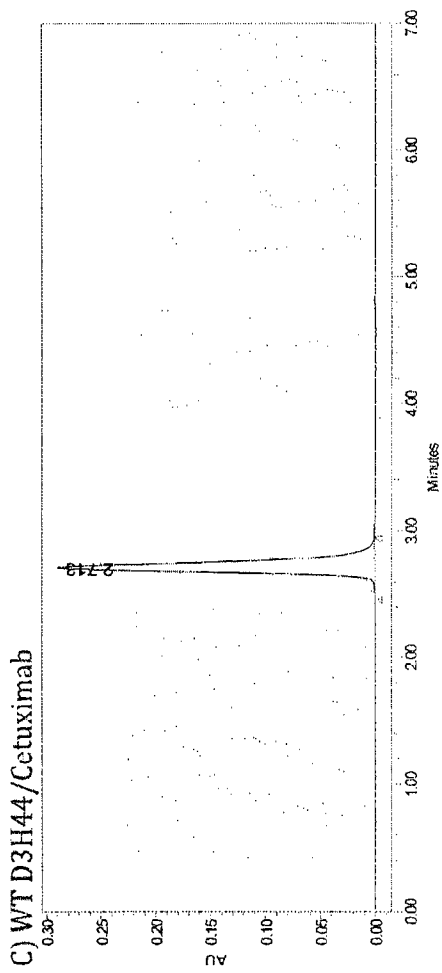
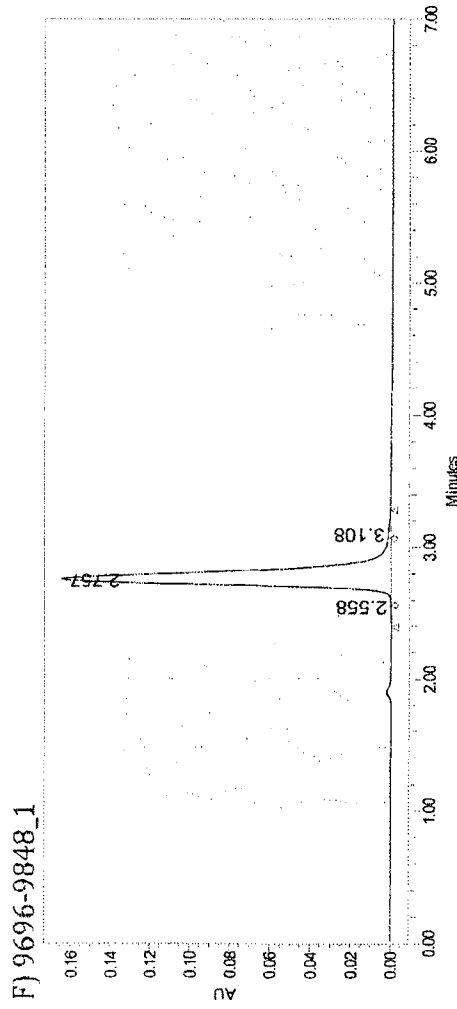
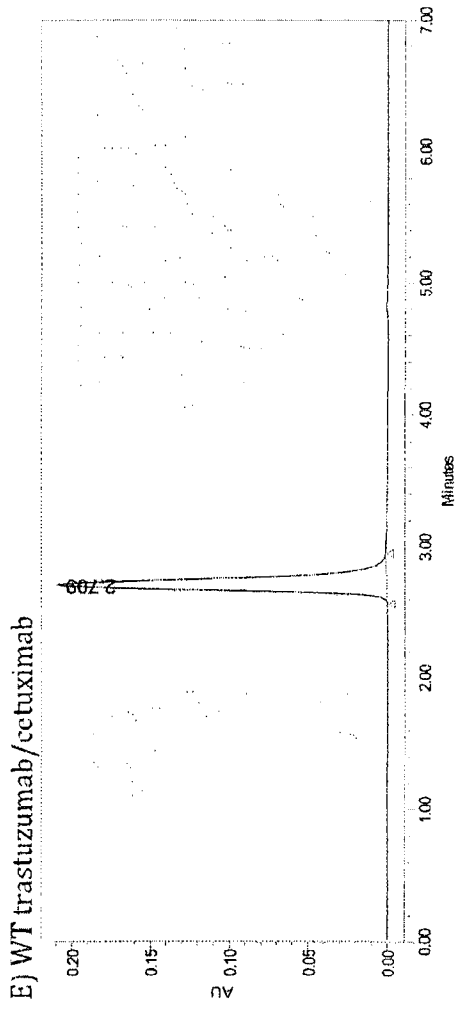

FIG. 10.









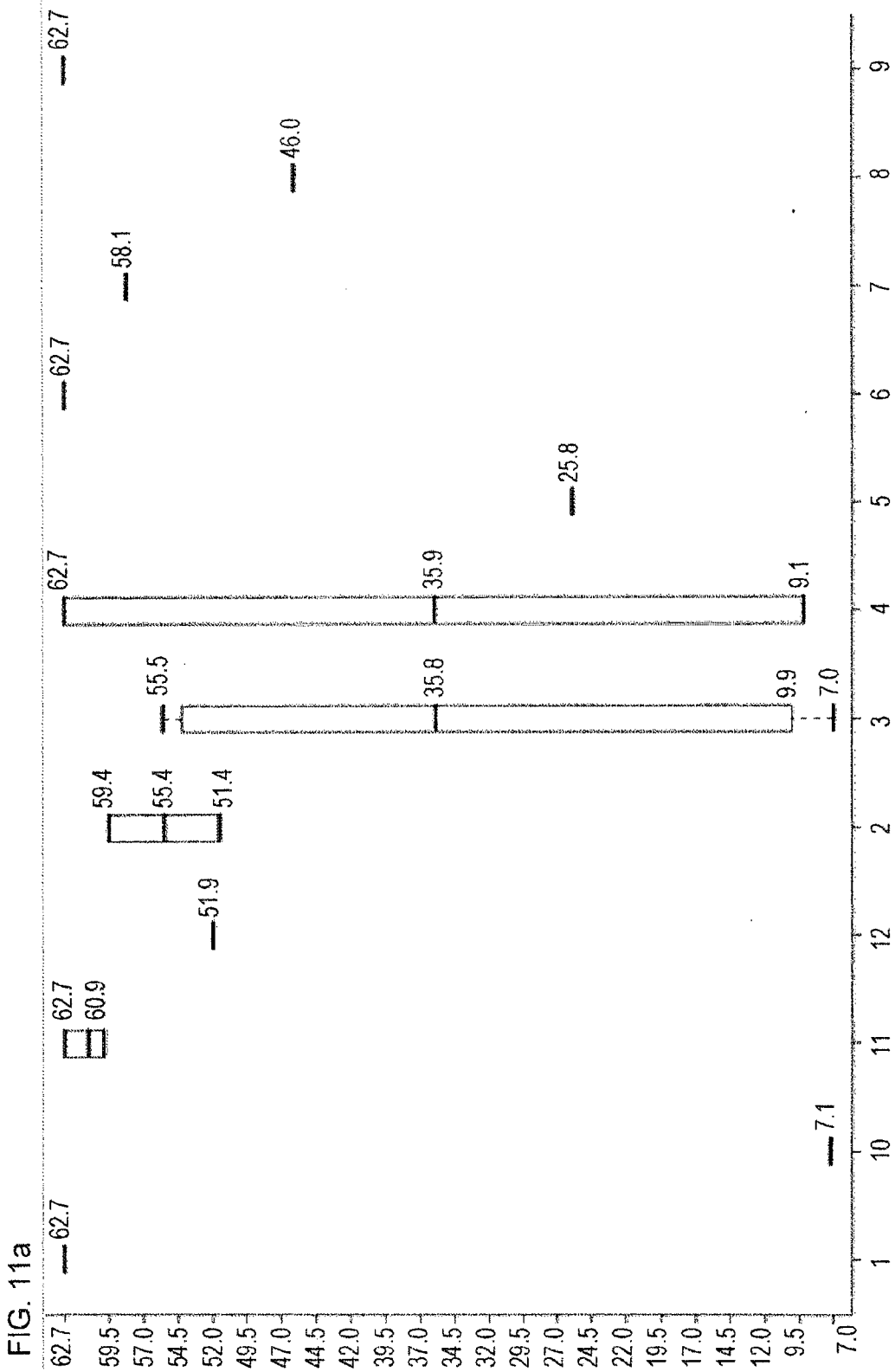
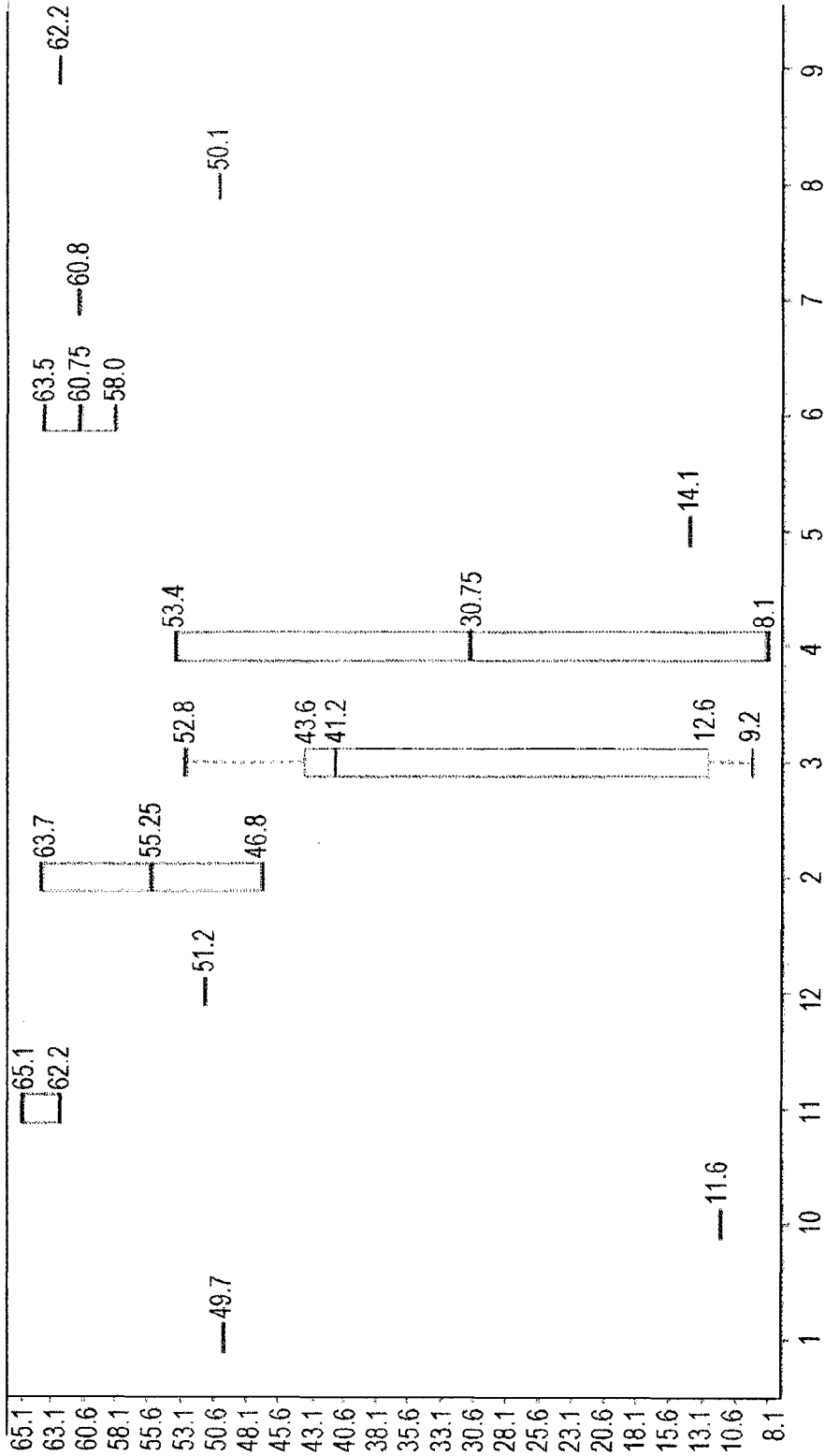
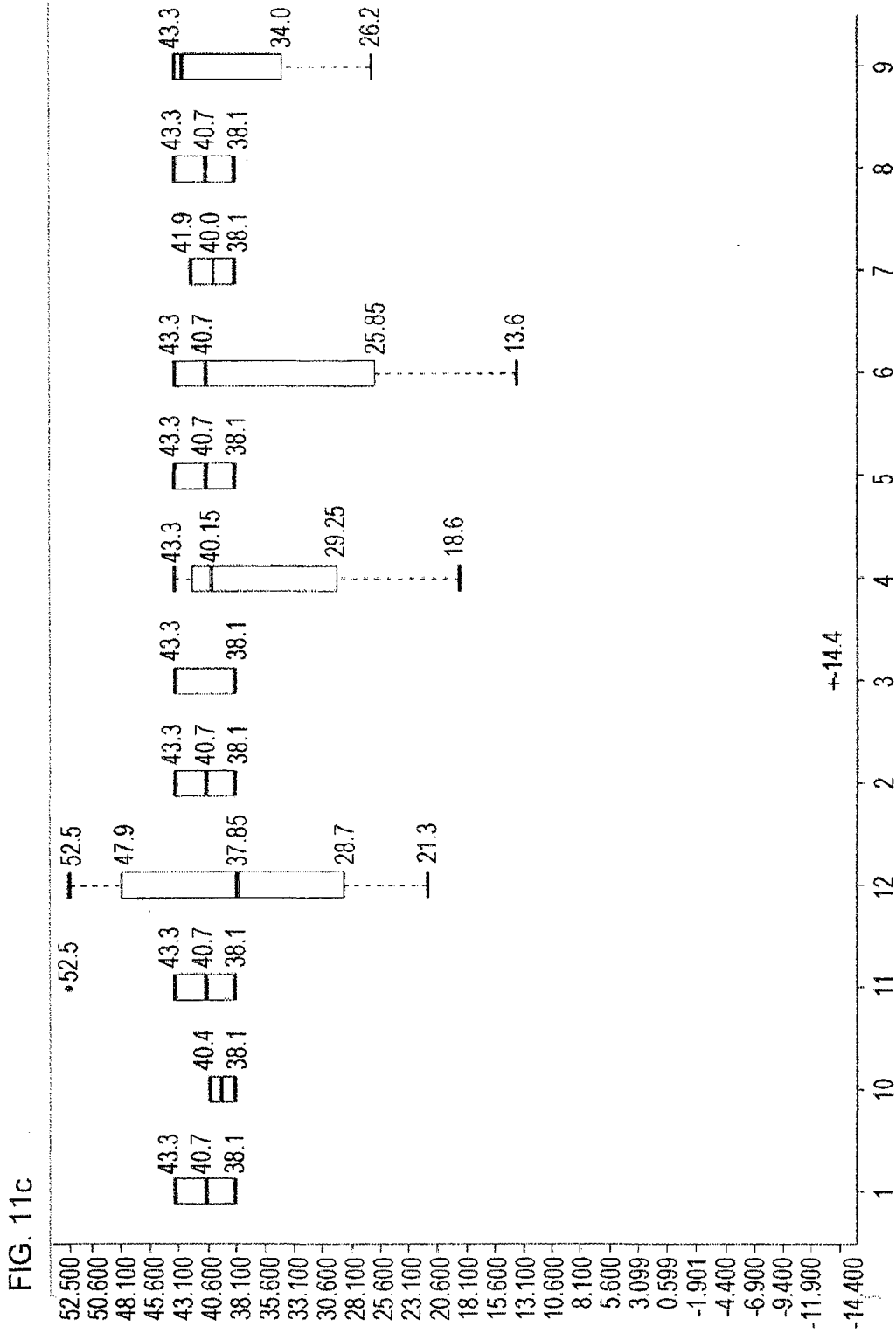

FIG. 11b





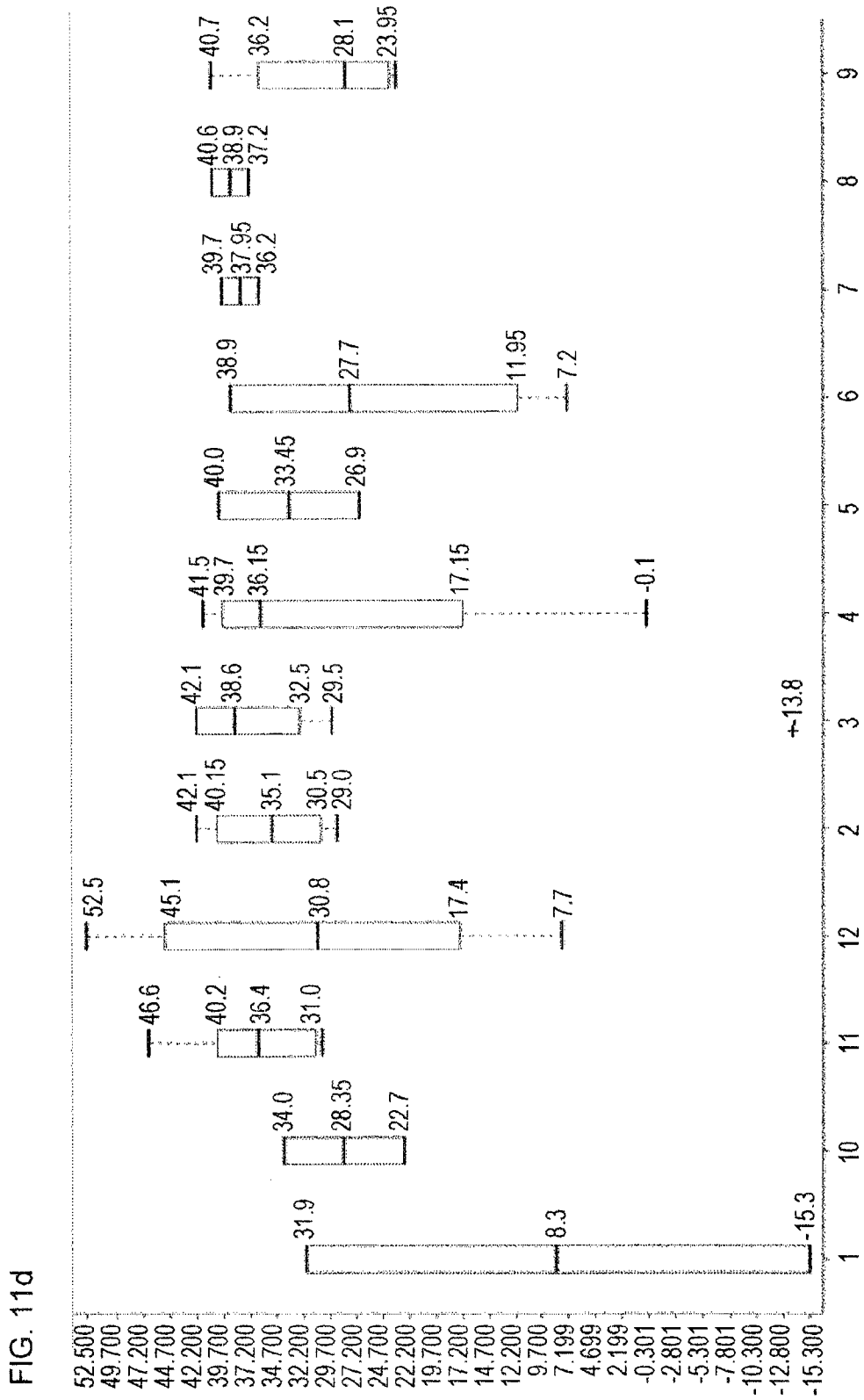

FIG. 11e

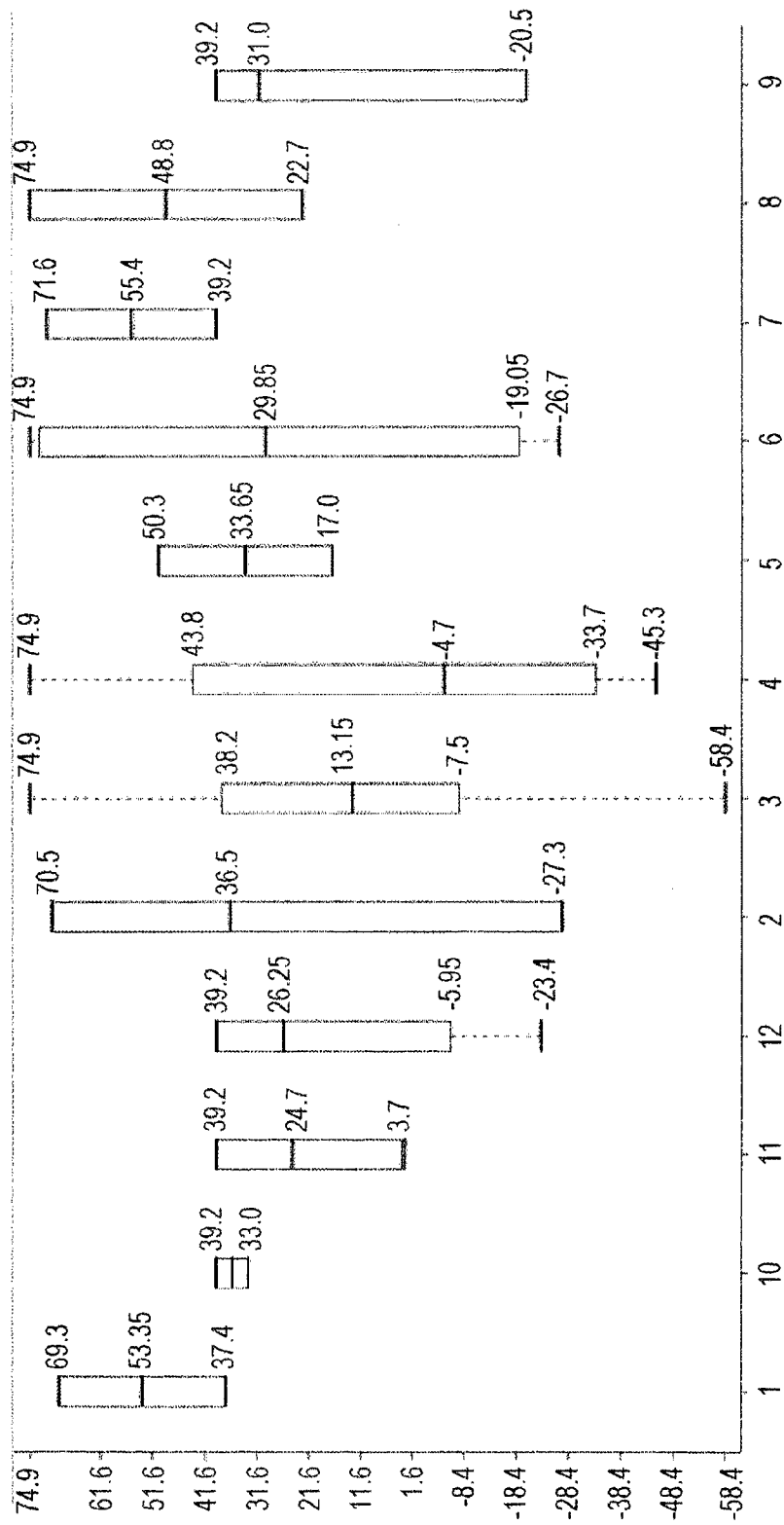

FIG. 11f

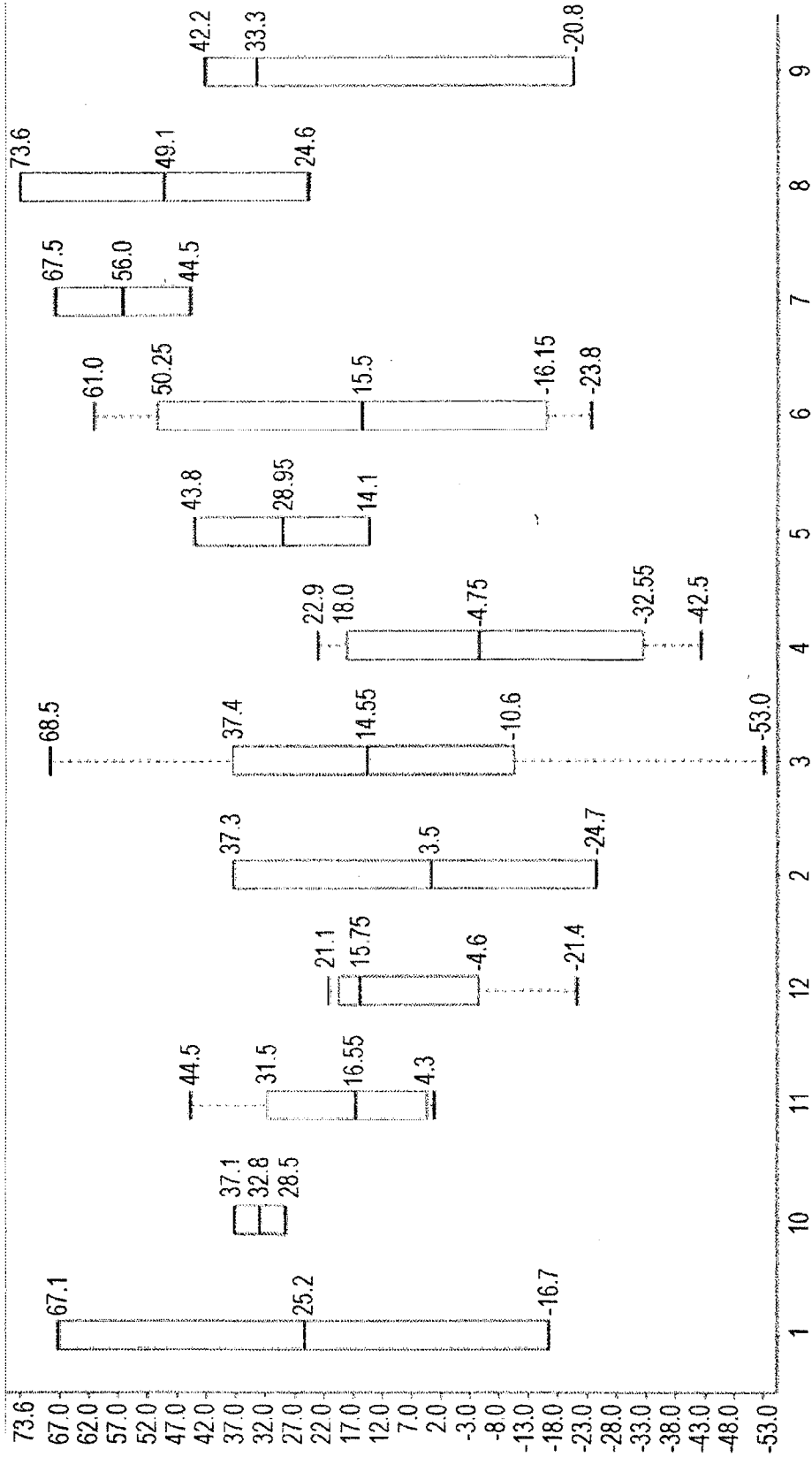

FIG. 11g

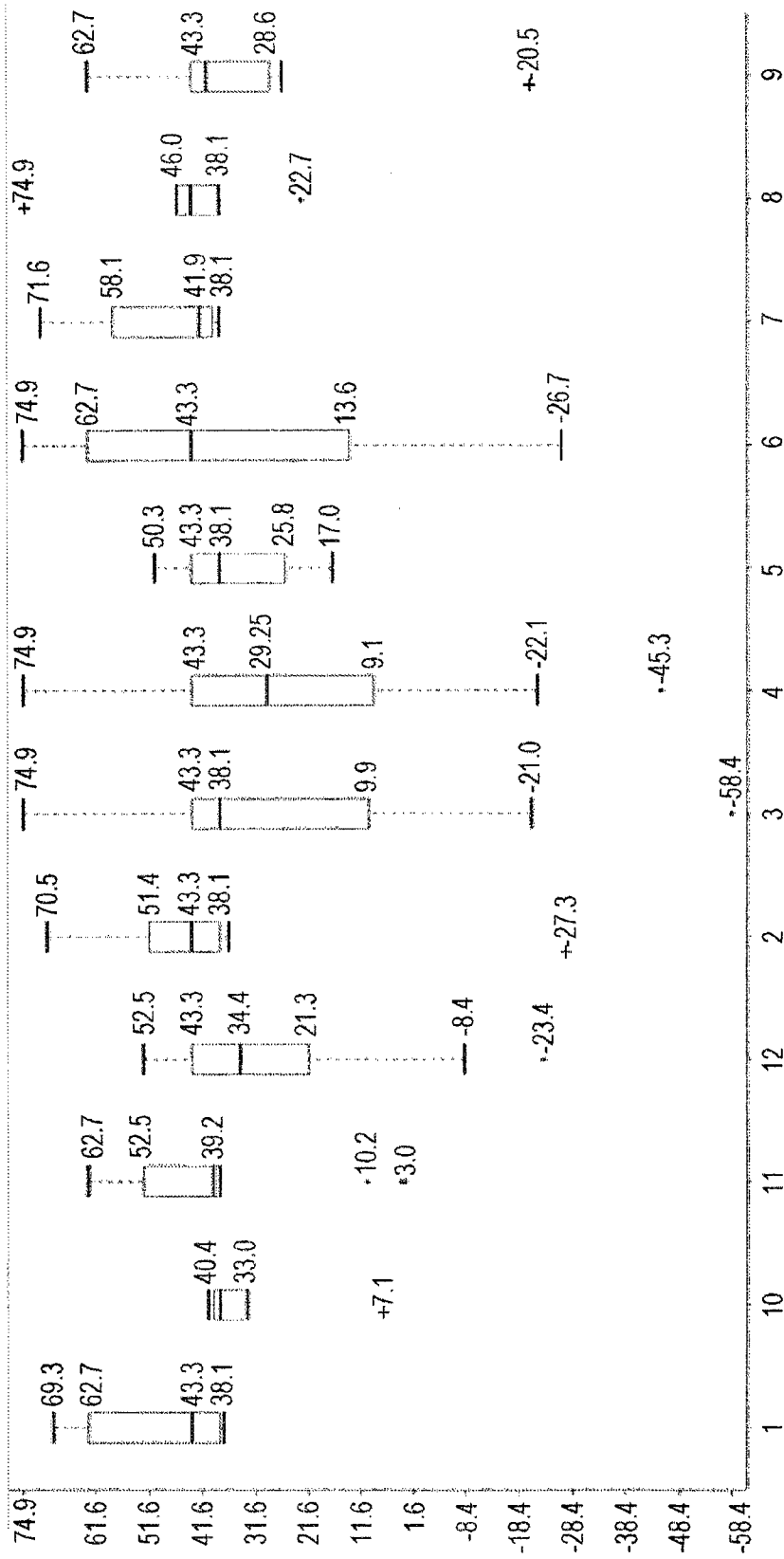

FIG. 11h

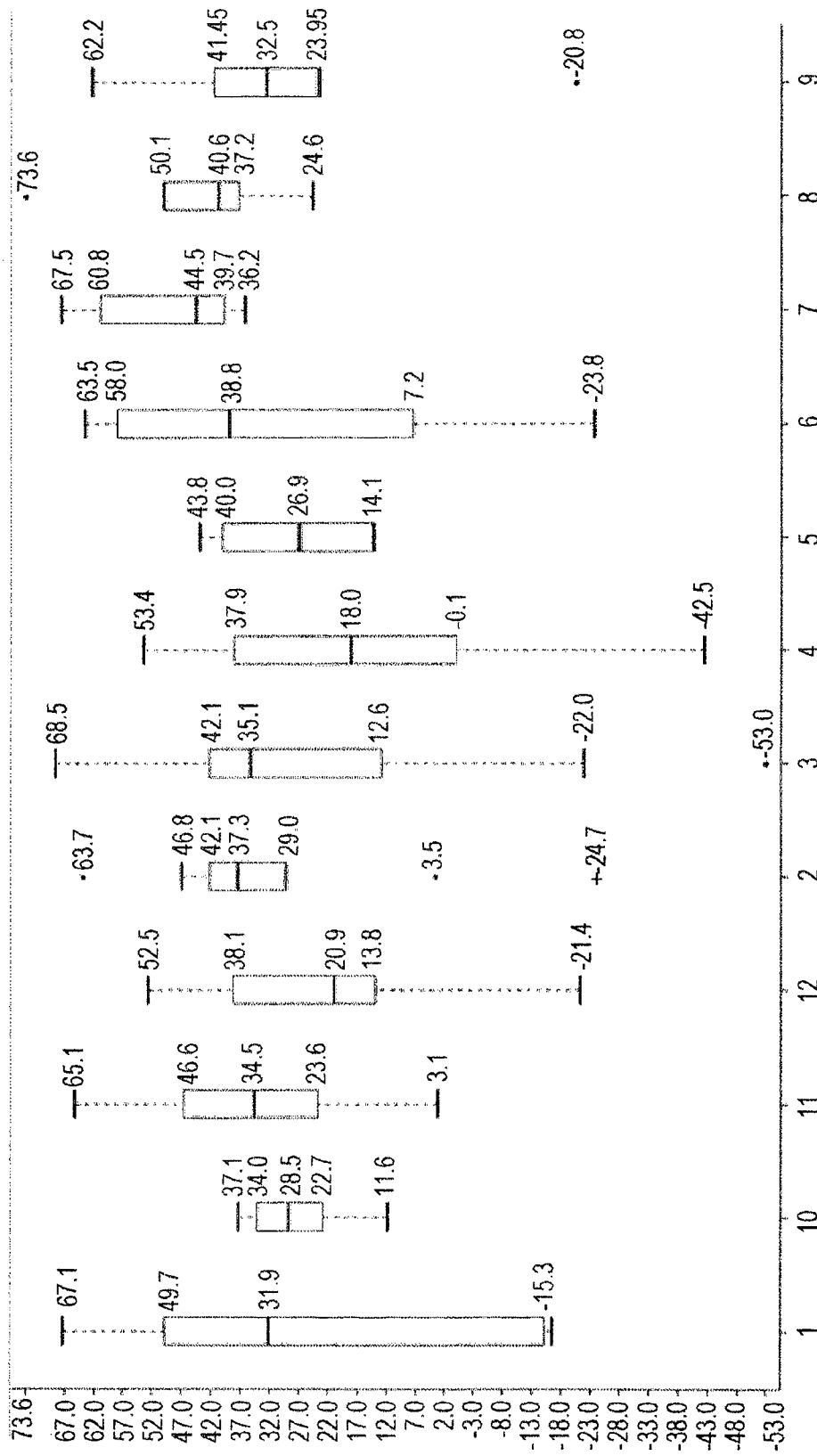
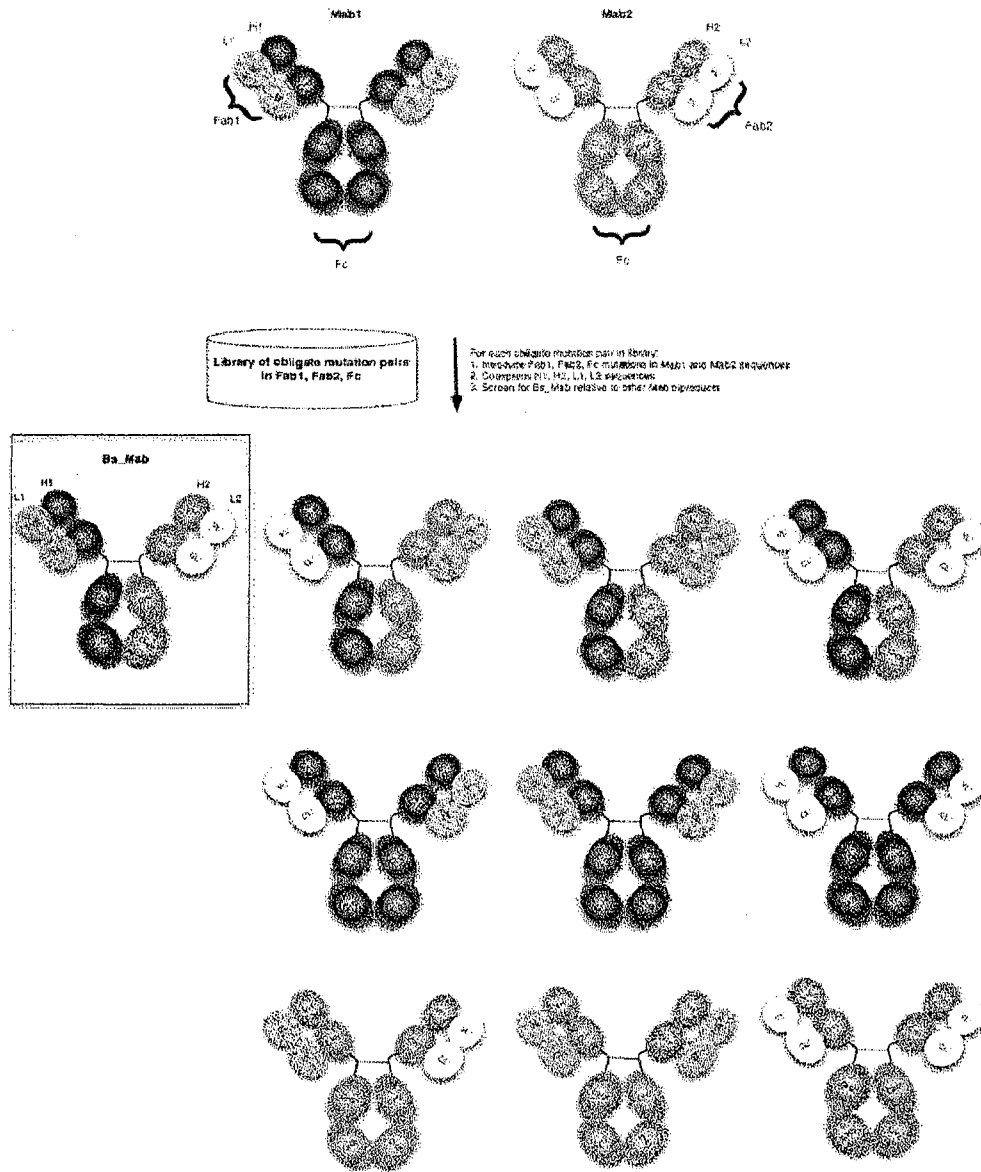



FIG. 12



## INTERNATIONAL SEARCH REPORT

International application No.

**PCT/IB2015/054107**

A. CLASSIFICATION OF SUBJECT MATTER IPC: <i>C07K 16/46</i> (2006.01), <i>A61K 39/395</i> (2006.01), <i>C07K 16/00</i> (2006.01), <i>C12N 15/13</i> (2006.01), <i>G06F 19/10</i> (2011.01)		
B. FIELDS SEARCHED		
Minimum documentation searched (classification system followed by classification symbols) IPC: <i>C07K 16/46</i> (2006.01), <i>A61K 39/395</i> (2006.01), <i>C07K 16/00</i> (2006.01), <i>C12N 15/13</i> (2006.01), <i>G06F 19/10</i> (2011.01)		
Documentation searched other than minimum documentation to the extent that such documents are included in the fields searched		
Electronic database(s) consulted during the international search (name of database(s) and, where practicable, search terms used) Databases: Questel Orbit, Canadian Patent Database, Scopus and Google Scholar. Keywords: bispecific, heterodimer*, antibod*, antigen, immunoglobulin, IgG, heavy chain, light chain, mutat* and modif*.		
C. DOCUMENTS CONSIDERED TO BE RELEVANT		
Category*	Citation of document, with indication, where appropriate, of the relevant passages	Relevant to claim No.
X Y	LEWIS, S.M. et al. "Generation of bispecific IgG antibodies by structural-based design of an orthogonal Fab interface" NATURE BIOTECHNOLOGY. 26 January 2014 (26-01-2014). Advanced online publication. doi:10.1038/nbt.2797, ISSN (electronic):1546-1696. *Entire document; Supplemental Table 5*	1-106 and 108-125 1-106 and 108-125
X	US 2009/0182127 A1 (KJAERGAARD, K. et al.) 16 July 2009 (16-07-2009). *Entire document; Table 1, on page 3*	1
Y	SPRETER VON KREUDENSTEIN, T. et al. "Protein engineering and the use of molecular modeling and simulation: The case of heterodimeric Fc engineering", METHODS. 06 November 2013 (06-11-2013). Advanced online publication. doi: 10.1016/j.ymeth.2013.10.016 ISSN (electronic): 1095-9130. *Entire document*	1-106 and 108-125
<input checked="" type="checkbox"/> Further documents are listed in the continuation of Box C. <input checked="" type="checkbox"/> See patent family annex.		
* "A" "E" "L" "O" "P"	Special categories of cited documents: document defining the general state of the art which is not considered to be of particular relevance earlier application or patent but published on or after the international filing date document which may throw doubts on priority claim(s) or which is cited to establish the publication date of another citation or other special reason (as specified) document referring to an oral disclosure, use, exhibition or other means document published prior to the international filing date but later than the priority date claimed	"T" later document published after the international filing date or priority date and not in conflict with the application but cited to understand the principle or theory underlying the invention "X" document of particular relevance; the claimed invention cannot be considered novel or cannot be considered to involve an inventive step when the document is taken alone "Y" document of particular relevance; the claimed invention cannot be considered to involve an inventive step when the document is combined with one or more other such documents, such combination being obvious to a person skilled in the art "&" document member of the same patent family
Date of the actual completion of the international search 13 August 2015 (13-08-2015)		Date of mailing of the international search report 01 September 2015 (01-09-2015)
Name and mailing address of the ISA/CA Canadian Intellectual Property Office Place du Portage I, C114 - 1st Floor, Box PCT 50 Victoria Street Gatineau, Quebec K1A 0C9 Facsimile No.: 001-819-953-2476		Authorized officer  Maria Mill (819) 994-4227

## INTERNATIONAL SEARCH REPORT

International application No.

**PCT/IB2015/054107**

C (Continuation). DOCUMENTS CONSIDERED TO BE RELEVANT		
Category*	Citation of document, with indication, where appropriate, of the relevant passages	Relevant to claim No.
X,P	WO 2014/082179 A1 (COOPER, A.L. et al.) 05 June 2014 (05-06-2014). *Entire document; Table 30, on page 252-266*	1-106 and 108-125
A	KLEIN, C. et al. "Progress in overcoming the chain association issue in bispecific heterodimeric IgG antibodies", MABS. November/December 2012 (11/12-2012). Vol.4, No.6, Pages 653-663. ISSN (print): 1942-0870. *Entire document*	1-106 and 108-125

## INTERNATIONAL SEARCH REPORT

International application No.

**PCT/IB2015/054107****Box No. II Observations where certain claims were found unsearchable (Continuation of item 2 of the first sheet)**

This international search report has not been established in respect of certain claims under Article 17(2)(a) for the following reasons:

1.  Claim Nos.: 107  
because they relate to subject matter not required to be searched by this Authority, namely:  
Claim 107 is directed to a method for treatment of the human or animal body by surgery or therapy, which the International Searching Authority is not required to search under Rule 39.1(iv) of the PCT. However, this Authority has carried out a search based on the alleged effect or purpose/use of the product defined in claim 107.
2.  Claim Nos.:  
because they relate to parts of the international application that do not comply with the prescribed requirements to such an extent that no meaningful international search can be carried out, specifically:
3.  Claim Nos.:  
because they are dependent claims and are not drafted in accordance with the second and third sentences of Rule 6.4(a).

**Box No. III Observations where unity of invention is lacking (Continuation of item 3 of first sheet)**

This International Searching Authority found multiple inventions in this international application, as follows:

See extra sheet.

1.  As all required additional search fees were timely paid by the applicant, this international search report covers all searchable claims.
2.  As all searchable claims could be searched without effort justifying additional fees, this Authority did not invite payment of additional fees.
3.  As only some of the required additional search fees were timely paid by the applicant, this international search report covers only those claims for which fees were paid, specifically claim Nos.:
4.  No required additional search fees were timely paid by the applicant. Consequently, this international search report is restricted to the invention first mentioned in the claims; it is covered by claim Nos.:

**Remark on Protest**

- The additional search fees were accompanied by the applicant's protest and, where applicable, the payment of a protest fee.
- The additional search fees were accompanied by the applicant's protest but the applicable protest fee was not paid within the time limit specified in the invitation.
- No protest accompanied the payment of additional search fees.

Continuation of Box No. III

The claims are directed to a plurality of inventive concepts as follows:

Groups A to L – All claims of Groups A to L are directed to an isolated antigen binding polypeptide construct comprising at least two heterodimers, each heterodimer comprising an immunoglobulin heavy and an immunoglobulin light chain polypeptide, wherein at least one of the heavy or light chain polypeptides has at least one amino acid modification such that it preferentially pairs with its corresponding heavy or light chain polypeptide and wherein the thermal stability of the Fab region is within about 0-10°C T<sub>M</sub> compared to the heterodimer without modification(s); polynucleotides encoding said construct; vectors comprising said polynucleotides; cells comprising said polynucleotides or vectors, pharmaceuticals comprising said constructs and the use thereof; methods of obtaining and preparing said construct; and a computer-readable storage medium storing data related to said construct.

Groups A to L differ in that the construct comprises different combinations of amino acid modifications as follows:

Group A - Claims 1 and 67-125 (partially) and claims 2-5 (completely) - the construct wherein (i) H1 and/or H2 comprises at least one or a set of amino acid modifications at L124, K145, D146, Q179 and S186, and (ii) L1 and/or L2 comprises at least one or a set of amino acid modifications at Q124, S131, V133, Q160, S176, T178, and T180;

Group B - Claims 1 and 67-125 (partially) and claims 6-10 (completely) - the construct wherein (i) H1 and/or H2 comprises at least one or a set of amino acid modifications at L124, L143, K145, D146, Q179 and S186, and (ii) L1 and/or L2 comprises at least one or a set of amino acid modifications at Q124, V133, Q160, S176, T178, and T180;

Group C - Claims 1 and 67-125 (partially) and claims 11-18 (completely) the construct wherein (i) H1 and/or H2 comprises at least one or a set of amino acid modifications at Q39, L45, L124, L143, F122 and H172, and (ii) L1 and/or L2 comprises at least one or a set of amino acid modifications at Q38, P44, Q124, S131, V133, N137, S176 and T178;

Group D - Claims 1 and 67-125 (partially) and claims 19-27 (completely) the construct wherein wherein (i) H1 and/or H2 comprises at least one or a set of amino acid modifications at L124, A125, H172 and K228, and (ii) L1 and/or L2 comprises at least one or a set of amino acid modifications at S121, V133, N137, S174, S176 and T178;

Group E - Claims 1 and 67-125 (partially) and claims 28-32 (completely) the construct wherein (i) H1 and/or H2 comprises at least one or a set of amino acid modifications at Q39, L45, K145, H172, Q179 and S186, and (ii) L1 and/or L2 comprises at least one or a set of amino acid modifications at Q38, P44, Q124, S131, Q160, T180 and C214;

Group F - Claims 1 and 67-125 (partially) and claims 33-36 (completely) the construct wherein (i) H1 and/or H2 comprises at least one or a set of amino acid modifications at A139, L143, K145, Q179 and V190, and (ii) L1 and/or L2 comprises at least one or a set of amino acid modifications at F116, Q124, L135, Q160, T178, and T180 ;

Group G - Claims 1 and 67-125 (partially) and claims 37-40 (completely) the construct wherein (i) H1 and/or H2 comprises at least one or a set of amino acid modifications at Q39, L143, K145, D146, H172 and Q179, and (ii) L1 and/or L2 comprises at least one or a set of amino acid modifications at Q38, Q124, Q160, T178, and T180;

Group H - Claims 1 and 67-125 (partially) and claims 41-45 (completely) the construct wherein (i) H1 and/or H2 comprises at least one or a set of amino acid modifications at L45, L143, K145, D146, H172 and Q179, and (ii) L1 and/or L2 comprises at least one or a set of amino acid modifications at Q39, P44, Q124, N137, Q160, S176, T178, T180 and C214;

Group I - Claims 1 and 67-125 (partially) and claims 46-49 (completely) the construct wherein (i) H1 and/or H2 comprises at least one or a set of amino acid modifications at L124, L143, K145 and Q179, and (ii) L1 and/or L2 comprises at least one or a set of amino acid modifications at Q124, S131, V133, S176, T178 and T180;

Group J - Claims 1 and 67-125 (partially) and claims 50-55 (completely) the construct wherein (i) H1 and/or H2 comprises at least one or a set of amino acid modifications at A139, L143, K145, Q179 and S186, and (ii) L1 and/or L2 comprises at least one or a set of amino acid modifications at F116, Q124, V133, Q160, T178 and T180;

Continued in extra sheet

INTERNATIONAL SEARCH REPORT

International application No.  
**PCT/IB2015/054107**

Continuation of extra sheet

Group K - Claims 1 and 67-125 (partially) and claims 56-62 (completely) the construct wherein (i) H1 and/or H2 comprises at least one or a set of amino acid modifications at L124, L143, K145, D146, Q179, S186 and S188, and (ii) L1 and/or L2 comprises at least one or a set of amino acid modifications at Q124, S131, V133, Q160, S176, T178, and T180; and

Group L - Claims 1 and 67-125 (partially) and claims 63-66 (completely) the construct wherein (i) H1 and/or H2 comprises at least one or a set of amino acid modifications at F122 and C233, and (ii) L1 and/or L2 comprises at least one or a set of amino acid modifications at Q124 and C214.

The claims must be limited to one inventive concept as set out in Rule 13 of the PCT.

Claims 1-125 lack unity *a posteriori*. Unity of invention exists only when there is a technical relationship among the claimed inventions involving one or more of the same or corresponding special technical features (those technical features that define a contribution which each of the inventions considered as a whole, makes over the prior art). D1 discloses an isolated antigen binding polypeptide construct comprising at least two heterodimers, each heterodimer comprising an immunoglobulin heavy and an immunoglobulin light chain polypeptide, wherein at least one of the heavy or light chain polypeptides has at least one amino acid modification such that it preferentially pairs with its corresponding heavy or light chain polypeptide and wherein the thermal stability of the Fab region is within about 0-10°C T<sub>M</sub> compared to the heterodimer without modification. Therefore, isolated antigen binding polypeptide constructs that comprise at least one amino acid modification in the heavy and light chain polypeptides such that preferential pairing occurs, is known in the prior art and each construct having different combinations of amino acid modifications is considered a separate group.

**INTERNATIONAL SEARCH REPORT**  
Information on patent family members

International application No.

**PCT/IB2015/054107**

Patent Document Cited in Search Report	Publication Date	Patent Family Member(s)	Publication Date
US2009182127A1	16 July 2009 (16-07-2009)	US2009182127A1 EP2035456A1 JP2009541275A WO2007147901A1	16 July 2009 (16-07-2009) 18 March 2009 (18-03-2009) 26 November 2009 (26-11-2009) 27 December 2007 (27-12-2007)
WO2014082179A1	05 June 2014 (05-06-2014)	WO2014082179A1 AU2013351888A1 CA2893562A1 US2014200331A1	05 June 2014 (05-06-2014) 04 June 2015 (04-06-2015) 05 June 2014 (05-06-2014) 17 July 2014 (17-07-2014)