

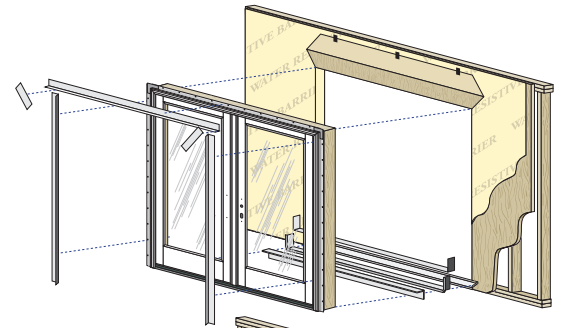

**PELLA INSTALLATION INSTRUCTIONS
IMPACT RESISTANT HINGED PATIO DOORS WITH NAIL FIN OR HINGED PATIO DOORS
WITH ENDURA CLAD EXTERIOR TRIM AND NAIL FIN**

THE FOLLOWING INSTALLATION METHODS ARE INCLUDED IN THIS BOOKLET:

New Construction Installation After Building Wrap for Nail Fin Hinged Doors



New Construction Installation Before Building Wrap for Nail Fin Hinged Doors

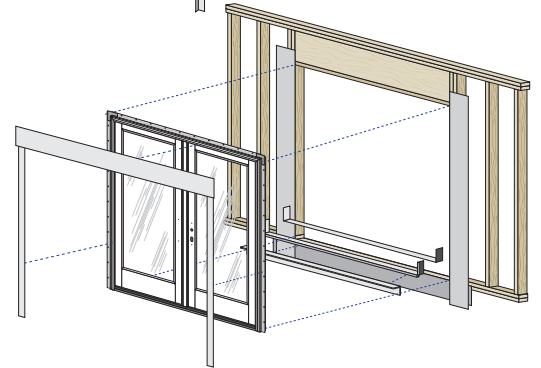

New Construction Installation with Water Resistant Sheathing for Nail Fin Hinged Doors

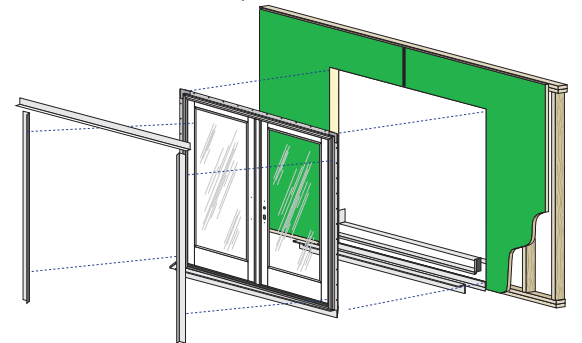

New Construction Installation in Masonry Construction for Nail Fin Hinged Doors

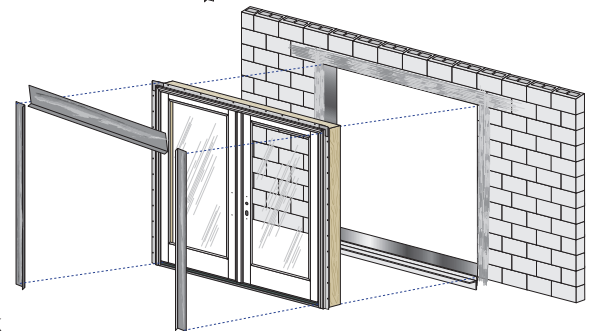

Full Frame Replacement after Brickmould/trim Removal or Siding cut-back for Nail Fin Hinged Doors

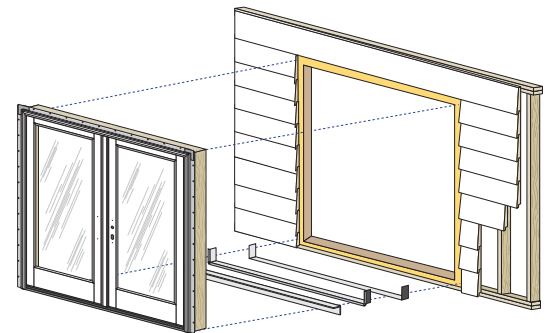

These instructions were developed and tested for use with wall systems designed to manage water. *These instructions are not to be used with any other construction methods or door frame types.* Installation instructions for use with other construction methods or frame types may be obtained from Pella® Corporation, your local Pella retailer or www.installpella.com. Building designs, construction methods, building materials, and site conditions unique to your project may require an installation method different from these instructions and/or additional care. Determining the appropriate installation method is the responsibility of you, your architect, or construction professional.



BY PURCHASING, INSTALLING OR USING PELLA PRODUCTS (INCLUDES PELLA GOODS AND PELLA SERVICES), YOU AGREED TO THE TERMS OF THE LIMITED WARRANTY AND YOU AND PELLA FURTHER AGREE TO ARBITRATE DISPUTES ARISING OUT OF OR RELATING TO PELLA PRODUCTS, AND YOU WAIVE ANY RIGHT TO PARTICIPATE IN A CLASS ACTION RELATED TO PELLA PRODUCTS unless you notify Pella of your decision to opt out of the Arbitration Agreement no later than ninety (90) calendar days from the date you purchased or otherwise took ownership of Your Pella Goods. Opting out of the Arbitration Agreement will not affect the coverage provided by any applicable limited warranty pertaining to Your Pella Products. For opt out information and additional details please read the Limited Warranty and Arbitration Agreement for your Pella Products at www.Pella.com/arbitration.

IMPORTANT SAFETY AND PRODUCT INFORMATION – DOORS

Safety Alert Symbol Reference: These symbols are intended to alert you to potential injury hazards and information. Obey all safety messages.

COULD

Result in:



COULD

Result in:



COULD

Result in:



COULD

Result in:



To ensure safety and security and help prevent property damage, including possible damage to your window or door, close and lock windows and doors any time they are not being used for venting on a nice day, and particularly during high winds or rain.



Many doors in older homes are painted with lead-based paint. Removal of old doors may disturb this paint. Proper precautions must be taken to minimize exposure to dust and debris. Consult state or local authorities and/or go to www.epa.gov/lead for more information.

NOTICE

Pella products must be stored in an upright, level position not exposed to weather. The storage must be ventilated and provide protection from direct sunlight and excessive temperature.

IMPORTANT NOTICE

Because all construction must anticipate some water infiltration, it is important that the wall system be designed and constructed to properly manage moisture. Pella Corporation is not responsible for claims or damages caused by anticipated and unanticipated

water infiltration; deficiencies in building design, construction and maintenance; failure to install Pella products in accordance with Pella's installation instructions; or the use of Pella products in wall systems which do not allow for proper management of moisture within the wall systems. The determination of the suitability of all building components, including the use of Pella products, as well as the design and installation of flashing and sealing systems are the responsibility of the Buyer or User, the architect, contractor, installer, or other construction professional and are not the responsibility of Pella.

Pella products should not be used in barrier wall systems which do not allow for proper management of moisture within the wall systems, such as barrier Exterior Insulation and Finish Systems (EIFS) (also known as synthetic stucco) or other non-water managed systems. Except in the states of California, New Mexico, Arizona, Nevada, Utah and Colorado, Pella makes no warranty of any kind on and assumes no responsibility for Pella windows and doors installed in barrier wall systems. In the states listed above, the installation of Pella Products in barrier wall or similar systems must be in accordance with Pella's installation instructions. Product modifications that are not approved by Pella Corporation will void the warranty.

CARE AND MAINTENANCE: Refer to the Pella Owner's Manual. Visit www.pella.com or your local retailer for more information.

CLEANING INSTRUCTIONS: Refer to the Pella Owner's Manual for comprehensive maintenance and cleaning information. Visit www.pella.com or your local retailer for more information.

NOTICE

DO NOT apply any other types of film to the glass. Doing so could void product warranty.

NOTICE

DO NOT use abrasives. DO NOT scrape or use tools that might damage the surface.

NOTICE

DO NOT use inappropriate solvents or brickwash or cleaning chemicals. If you do, permanent damage can result and the product failure, loss or damage would not be covered by the Limited Warranty.

FINISHING INSTRUCTIONS (WOOD PATIO DOORS AND FIBERGLASS ENTRY DOORS): Paint or finish immediately after installation.

If products cannot be finished immediately, cover with clear plastic to protect from dirt, damage and moisture. Remove any construction residue before finishing. Sand all wood surfaces lightly with 180 grit or finer sandpaper. DO NOT use steel wool. BE CAREFUL NOT TO SCRATCH THE GLASS. Remove sanding dust. Pella products must be finished according to these instructions; failure to follow these instructions voids the Limited Warranty. Finishing panel edges is optional for Patio Doors.

NOTICE

To maintain proper product performance do not paint, finish or remove the weatherstripping, mohair dust pads, gaskets or vinyl parts. Air and water leakage will result if these parts are removed. After finishing, allow venting Doors and doors to dry completely before closing them. If paint, stain or finish gets on the weatherstripping, wipe it off immediately with a damp cloth.

Panel Cleaning and Prep Instructions for Unfinished or Primed Panels: Dry wipe dust from doors gently. Examine door for possible smudges or fingerprints made from normal handling or construction. To remove smudges, lightly wipe surface with warm water. DO NOT sand surface of fiberglass panel. Scuff sand with light grade sand paper or abrasive pad (220 grit or higher). Rinse surface with mineral spirits for fiberglass panels and warm water for steel panels. Let door and sidelight surfaces dry completely before applying finish. Finish the door panels as soon as possible after installation.

STAINING FIBERGLASS PANELS OR UNFINISHED INTERIOR FRAME MEMBERS: Fiberglass door and sidelight panels may be stained with a gel stain if a wood look is desired. Pella offers stain kits in a variety of colors. Apply and finish per the stain kit manufacturer's instruction. Ensure that all exposed panel edges are finished to minimize the chance of damage.

Unprimed interior frame parts may be stained with wood stains and should be finished with a minimum of two coats of a clear polyurethane finish. DO NOT bridge the top coat between the outer edge of the glazing frame and the door panel.

Note: The fiberglass base color tone will vary. This variance is normal and will not impact the stain color of the door.

PAINTING INSTRUCTIONS: Wood door frame exteriors, premium steel door panels and sidelights are factory primed. Wood doors require painting immediately after installation. The factory applied primer is not intended for long term exterior exposure. Sand all un-primed interior wood surfaces lightly with 180 grit or finer sandpaper before priming and painting. Fiberglass door and sidelight panels do not require priming. Use two coats of a 100% latex paint that has a good blocking resistance. On units with glass, do not bridge paint between the outer edges of the glazing frame and the door panel. On fiberglass products, brush the paint in the same direction as the simulated wood grain. For entry doors, ensure that all exposed panel edges are finished to minimize the chance of panel damage. Finishing panel edges is optional for Patio Doors.

Pella Corporation is not responsible for interior paint and stain finish imperfections for any product that is not factory-applied by Pella Corporation. For additional information on finishing see the Pella Owner's Manual or go to www.pella.com.

NOTICE

The use of unapproved finishes, solvents or cleaning chemicals may cause adverse reactions with door materials. Pella will not be responsible for problems caused by the use of unapproved materials. If in doubt, contact your local retailer or representative.

EXTERIOR FINISH OF EXISTING FRAME (POCKET REPLACEMENT): It is the responsibility of the homeowner, contractor or installer to ensure any exposed unfinished wood is covered or finished. Possible methods include, however are not limited to, covering with aluminum coil stock or painting.



FULL FRAME REMOVAL WHEN PREPARING TO INSTALL A NEW NAIL FIN DOOR



This method of Full Frame Removal involves removing the sash and entire frame of the existing door from the wall. The resulting opening is the original rough opening. The existing door nailing fins are usually nailed to the studs in frame construction with siding, brick veneer or other exterior material applied over the fin on the outside. The interior may have a drywall return from the wall to the door frame.

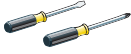

Many doors in older homes are painted with lead-based paint. Removal of old doors may disturb this paint. Proper precautions must be taken to minimize exposure to dust and debris. Consult state or local authorities for more information and/or go to www.epa.gov/lead for more information.

TOOLS REQUIRED:

- Utility knife 
- Phillips and Standard screwdrivers 

- Pry bar 
- Circular saw 

- Hammer 
- Putty knife 

REMEMBER TO USE APPROPRIATE PERSONAL PROTECTIVE EQUIPMENT.

EXISTING WOOD BRICKMOULD FRAME DOOR

A. Score paint or varnish between the interior trim and the wall with a sharp utility knife.

Note: This will minimize the damage to the interior wall and trim.

B. Remove the interior trim. Using a pry bar and block of wood, remove the interior trim from all four sides of the door including the stool at the bottom of the door. If the interior trim is being reused, pull the nails out through the back side of the board with nipper pliers.

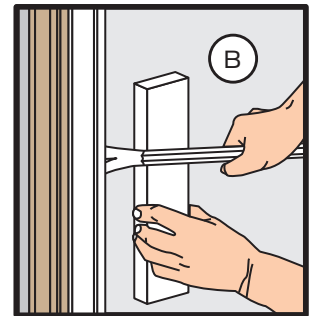

C. Cut the exterior sealant line between the exterior brickmould or trim and the exterior siding or wall cladding.

D. Remove the panels (if necessary) to make the door lighter.

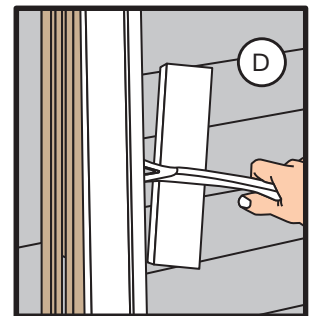

E. Remove the exterior brickmould or flat trim using a pry bar and block of wood.



Some doors may come out of the opening as the exterior trim is removed.

F. Remove the door frame using a pry bar if necessary.

EXISTING NAIL FIN DOOR REMOVAL

PANEL REMOVAL

A. Remove the panels (if necessary) to make the door lighter.

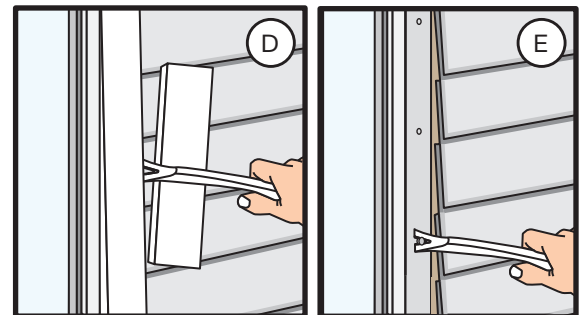

DOOR WITH EXTERIOR TRIM

B. Remove the existing exterior trim (if applicable). Use a block of wood to protect the exterior wall material. Use a pry bar to remove the existing exterior trim.

C. Remove the nails or screws attaching the door nailing fin to the wall.

D. Remove the door from the opening.

DOOR WITH NO EXTERIOR TRIM

E. Use a reciprocating saw to cut through sealant line and the nailing fin.

OR

F. Remove siding or cut back the siding a minimum of 3" or far enough to expose the nailing fin. Remove the fasteners attaching the door to the wall.

Note: When cutting back the siding, set the saw blade depth 1/8" less than the thickness of the siding. Break the cut ends of the siding off after sawing. DO NOT cut through the existing building wrap.

G. Remove the door from the wall.

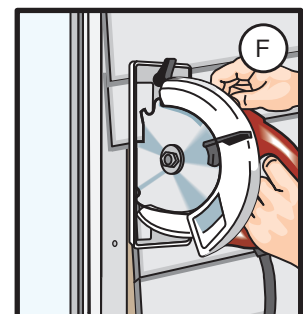









Consult with local providers and authorities to recycle or properly dispose of old door components.



PREPARING FOR HINGED DOOR INSTALLATION WITH NAIL FIN





YOU WILL NEED TO SUPPLY:

- Moisture resistant shims/spacers (12 to 20) 
- 1-1/2" galvanized roofing nails (1/4 lb.) 
- #10 x 3-1/2" corrosion resistant wood screws (Performance Upgrade & Impact-Resistant) 
- Masonry screws for concrete applications (Minimum of 3/16" diameter x 3") 
- Closed cell foam backer rod/sealant backer (21 to 30 ft.) 
- Pella® SmartFlash™ foil backed butyl window and door flashing tape or equivalent 
- Pella Window and Door Installation Sealant or equivalent high quality, multi-purpose sealant 
- Low Expansion, low pressure polyurethane insulating window and door foam sealant DO NOT use high pressure or latex foams 
- Sill pan (optional) 6-5/8" x (Rough Opening Width +2)
- Pella aluminum sill support or wood blocking
- Interior trim and/or jamb extensions (15 to 40 ft.)

INSTALLATION CLIP OPTION:

- 6" or 8" installation clips 
- #6 x 5/8" corrosion resistant flat head wood screws
- #8 x 1-1/2" corrosion resistant screws or 3/16" x 1-1/2" masonry screws

TOOLS REQUIRED:

- Tape measure 
- Level 
- Square 
- Hammer 
- Stapler 
- Sealant Gun 
- Scissors or utility knife 
- Tin Snips 
- Screwdrivers 
- (#2 Phillips with 8" shaft and small flat blade)
- T20 Torx Wrench 
- Drill 
- Drill Bits 13/64" and 1/8" and masonry bit for concrete applications 

INSTALLATION WILL REQUIRE (2) OR MORE PERSONS FOR SAFETY REASONS.

Store doors in upright position, out of direct sunlight.

ROUGH OPENING VERIFICATION

A. Confirm the opening is plumb and level.

NOTICE It is critical the bottom is level and it does not slope to the interior or exterior.

B. Remove dirt, oil or debris from the opening and surrounding wall surfaces.

C. Confirm the door will fit the opening. Measure all four sides of the opening to make sure it is 1/2" to 3/4" larger than the door in both width and 1/2" larger in height. Measure the width and height in several places to ensure the header or studs are not bowed.

NOTICE 1-1/2" or more of solid wood blocking is required around the perimeter of the opening. Fix any problems with the rough opening before proceeding.

NOTICE It is important to consider the door's exposure to weather, the exterior landing surface type and its proximity to the door sill, and to confirm impervious exterior surfaces properly slope away from the door prior to continuing with installation.

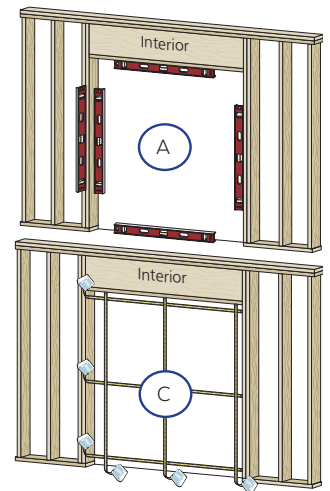

PREPARE THE DOOR FOR INSTALLATION

- A. Remove plastic wrap and cardboard packaging from the door. DO NOT open the door until it is securely fastened. DO NOT cut the strap that goes from the lock holes to the sill of the door (if applicable).
- B. Inspect the product for any damage such as cracks, dents or scratches. DO NOT install damaged products.
- C. Fold out installation fin to 90° (units with fold up fin only). Be careful not to remove or tear the fin corners.

Note: If the fin is not at 90°, the door will not line up correctly on the interior.

- D. Curved Units with Fins: Install clips on wood with non-structural flex fins or pre-drill holes for frame screws. See nail fin anchor instructions at the end of this booklet.

Units with wide EnduraClad Exterior trim and narrow fins with NO pre-punched holes: Install clips or pre-drill holes for frame screws.

See nail fin anchor instruction at the end of this booklet.

Additional preparation may be required for performance upgrade, impact resistant products or to comply with local building code requirements. See advanced performance or Impact-Resistant anchor schedule.

E. Read the entire instruction before proceeding.

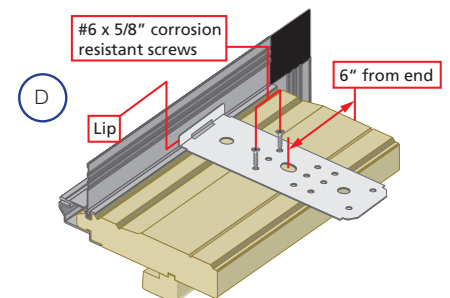
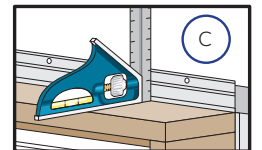

These instructions were developed and tested for use with wall systems designed to manage water. *These instructions are not to be used with any other construction methods or door frame types.* Installation instructions for use with other construction methods or frame types may be obtained from Pella® Corporation, your local Pella retailer or www.installpella.com. Building designs, construction methods, building materials, and site conditions unique to your project may require an installation method different from these instructions and/or additional care. Determining the appropriate installation method is the responsibility of you, your architect, or construction professional.



BY PURCHASING, INSTALLING OR USING PELLA PRODUCTS (INCLUDES PELLA GOODS AND PELLA SERVICES), YOU AGREED TO THE TERMS OF THE LIMITED WARRANTY AND YOU AND PELLA FURTHER AGREE TO ARBITRATE DISPUTES ARISING OUT OF OR RELATING TO PELLA PRODUCTS, AND YOU WAIVE ANY RIGHT TO PARTICIPATE IN A CLASS ACTION RELATED TO PELLA PRODUCTS unless you notify Pella of your decision to opt out of the Arbitration Agreement no later than ninety (90) calendar days from the date you purchased or otherwise took ownership of Your Pella Goods. Opting out of the Arbitration Agreement will not affect the coverage provided by any applicable limited warranty pertaining to Your Pella Products. For opt out information and additional details please read the Limited Warranty and Arbitration Agreement for your Pella Products at www.Pella.com/arbitration.

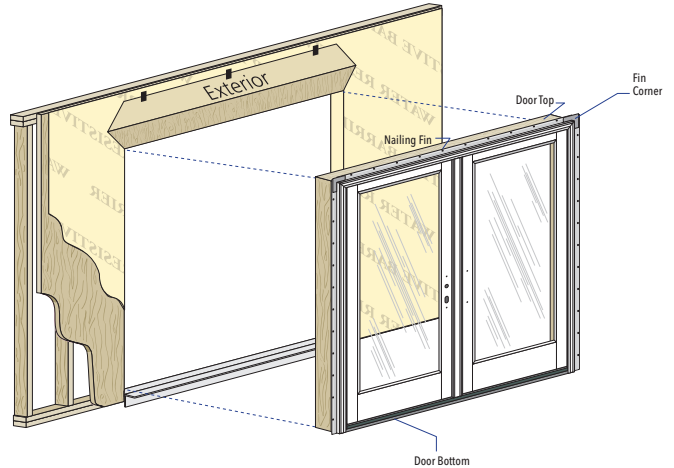
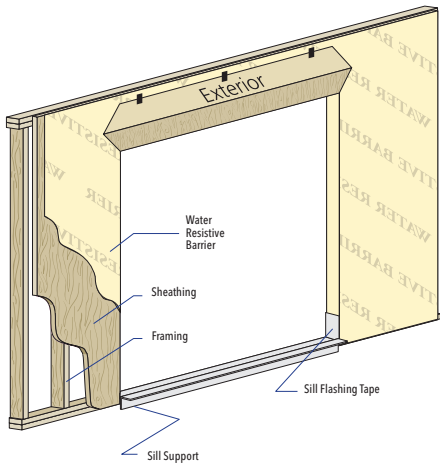

1 PREPARE THE OPENING

Refer to the nail fin installation preparation section at the beginning of this booklet.

A. Cut the building wrap.

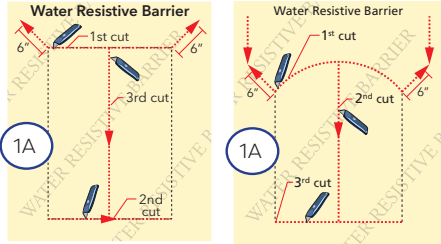

B. Fold the building wrap in at the jambs and staple it in place. Fold the top flap up and temporarily fasten with flashing tape.

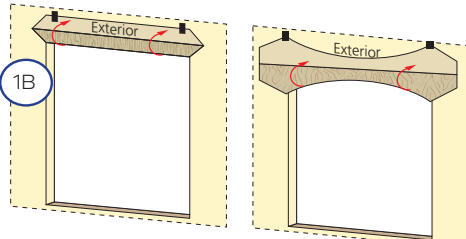

If using an optional sill pan, refer to the sill pan instruction page at the end of this booklet.

C. Cut 2 pieces of flashing tape 12" longer than opening width.

D. Apply sill flashing tape #1 at the sill extending 1" to the exterior and 6" up each jamb.

E. Cut 1" wide tabs at each corner by tearing the foil 1/2" each way from corner.

F. Apply sill flashing tape #2 overlapping tape #1 by 1" minimum.

Note: For In-Swing Doors with frame depth greater than 5", add a third piece of flashing tape so it comes within 1/4" of the interior of the door frame.

Note: Press all tape down firmly.

G. Attach a Pella aluminum sill support or wood blocking flush with the opening sill.

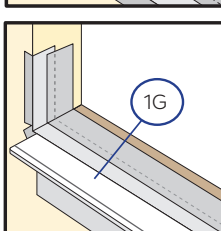
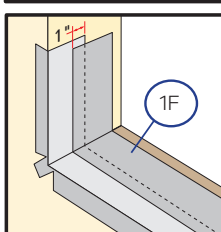
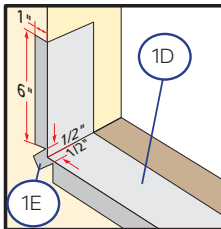

2 SETTING AND FASTENING THE DOOR

A. Place three 3/8" beads of sealant across the opening sill. Place the interior-most bead 1/2" from where the interior of the door sill will remain after installation. Continue this bead up the sill pan lip, if applicable.

Place a second bead beginning from the interior bead 1/2" from each side, out to the exterior of the framing and along the opening. Leave 2" voids 4" from the corner and at the center. Place a third bead where the exterior of the door sill will remain after installation.

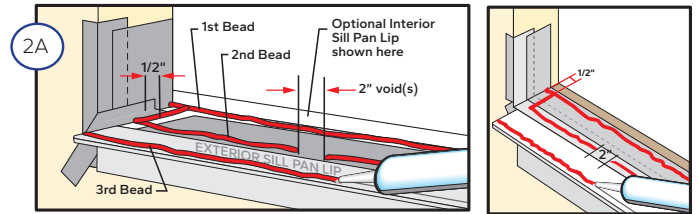

B. Center the bottom of the door in the opening and tilt the door into position. Do not slide the door into the opening. Sliding will damage the sealant lines.

Check the hinge jambs for plumb and confirm there is room for shimming between the jambs and opening on each side.

C. Drive two fasteners, one near each end of the top nailing fin. (See nail fin anchor instructions at the end of this booklet)

D. Plumb and square the door. Place shims at each hinge and lock strike. Keep shims 1/2" short of door frame depth. Insert additional shims starting 6" from the bottom as needed to keep jambs straight and panel reveals even on all four sides.

Note: Additional shims are required at screw locations for advanced performance, impact resistant units and combinations. See the nail fin anchor instructions at the end of this booklet.

E. Check the door placement by measuring from the interior surface of the door frame or jamb extension to the interior surface of the wall for consistency. If the dimensions are not equal, confirm the fins are folded fully to 90° (if applicable).

F. Finish driving fasteners into the nailing fin. Refer to the nail fin anchor instructions at the end of this booklet.

G. Check door operation.

Carefully open the door(s) and remove the shipping spacers (check under the door panel(s)). Use the construction handle to operate the panel(s). To operate flushbolts, see the instruction label on the astragal strike (if applicable).

Note: Adjust shims to correct any issues with plumb, square, operation or reveal.

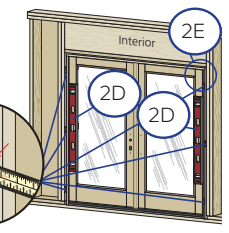
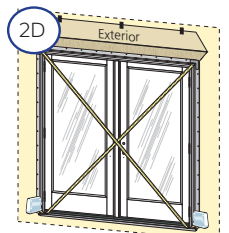
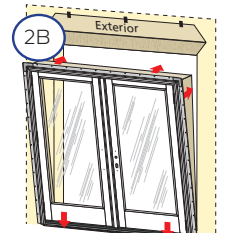

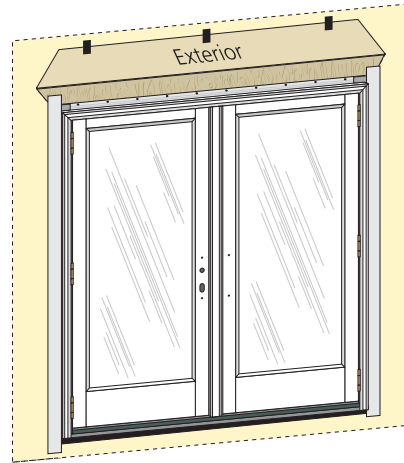
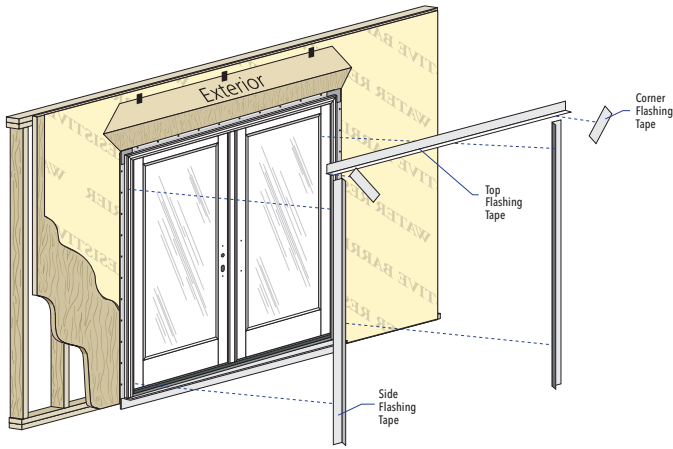

2 SETTING AND FASTENING THE DOOR CONTINUED

- H. **Pre-drill and drive screws at hinges, head and sill strikes or jamb strikes, threshold or low-profile sill and frames.** See the nail fin anchor instructions at the end of this booklet.
- I. **Open and close the door to check operation.** Make sure the door will latch correctly. If there are problems with operation adjust the shims and hinges (see below) and confirm the door frame is plumb, level and square and the gap between the door panel(s) and frame is consistent.
- J. **Adjustable hinges can be used to move the panel(s).** Turn the center screw with a T20 Torx wrench clockwise (+) to move the panel away from the frame or counter-clockwise (-) to move the panel toward the frame. A 3/4 turn provides approximately 5/32" adjustment.

Do not adjust the hinges if the top and bottom hinge screws are loose.

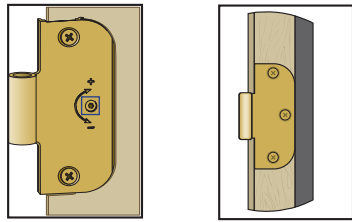

Adjustable Hinge Non-Adjustable Hinge

- K. **Doors without adjustable hinges have plastic shims behind the hinges;** remove shims to move the panel toward the frame. Additional shims may be added to move the panel away from the frame.

3 INTEGRATING WITH THE BUILDING WRAP

Note: For fold-up or slide-in fins, seal the fin to frame joint by either applying flashing tape 1/2" onto the frame, or sealing the joint with installation sealant after placing flashing tape.

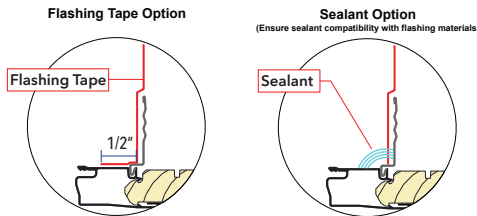

- A. **Apply straight side flashing tape.** Cut two pieces of flashing tape 4" taller than straight sides. Apply tape over the fin and onto weather resistive barrier. Extend tape 2" above and below straight sides.

Doors with angle top transoms or curved tops: On the short side, do not allow the side tape to extend higher than what the top tape will cover.

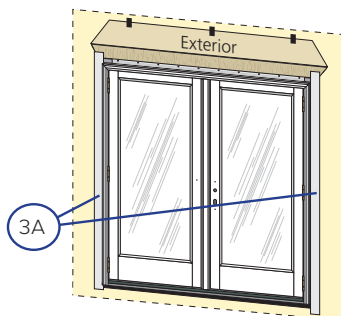

- B. **Apply top flashing tape.**

Rectangular Units: Cut one piece of flashing tape to extend 1" past both side flashing tapes.

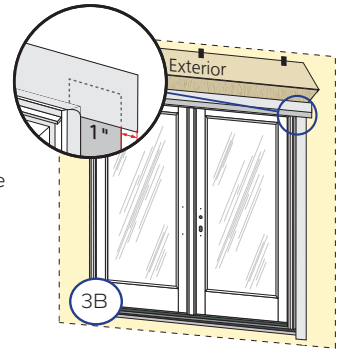

Curved Top Units: Using several short pieces, start taping from the sides of the door working towards the peak. Cut each piece short enough so each piece overlaps the previous piece. Tighter curved frames will require shorter pieces of tape.

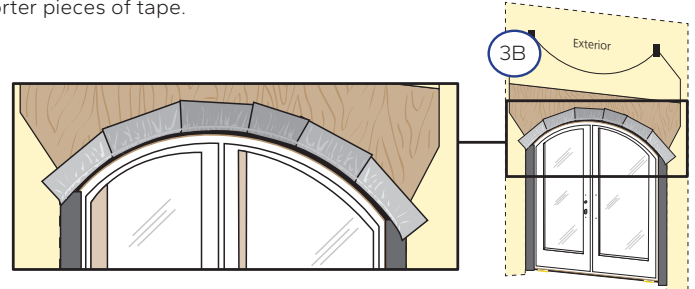

- C. **Fold down top flap** of weather resistive barrier.
- D. **Apply flashing tape to top diagonal cuts.** Cut pieces of flashing tape at least 1" longer than each diagonal cut. Lap tape 1" past end of cut onto weather barrier. Overlap multiple pieces of tape by 1" when necessary.

Note: PRESS ALL FLASHING TAPE DOWN FIRMLY.

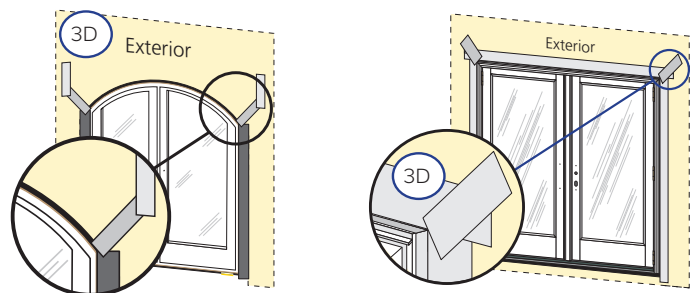

- E. **Install interior sealant.** Refer to the interior sealant instructions at the end of this booklet.
- F. **Install head flashing,** properly incorporating it with the siding and building wrap according to applicable code requirements.
- G. **Install exterior sealant.** (After wall cladding is installed) Refer to the exterior sealant instructions at the end of this booklet.

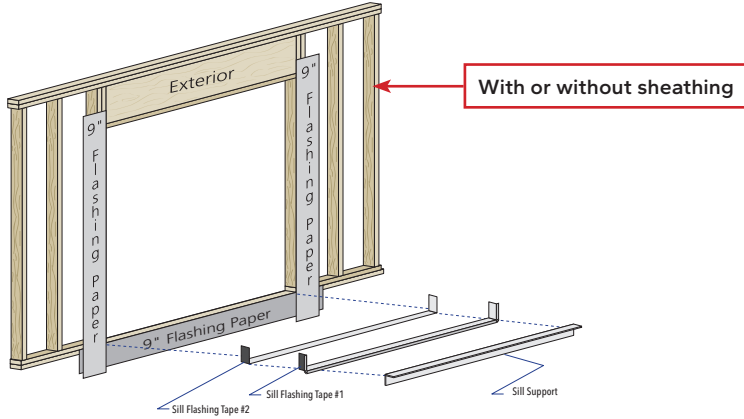

1 PREPARE THE OPENING

Refer to the nail fin installation preparation section at the beginning of this booklet.

A. **Apply flashing paper at the bottom.** Cut one piece of 9" minimum width flashing paper 18" longer than the width of the opening. Staple it flush with the top of the sill plate.

Note: bottom flashing paper is not required on concrete floors.

B. **Apply flashing paper to the sides.** Cut 2 pieces of 9" minimum width flashing paper 18" longer than the longest straight side of the opening. Center the flashing paper with the opening height and staple one piece flush with the inside edge on both sides.

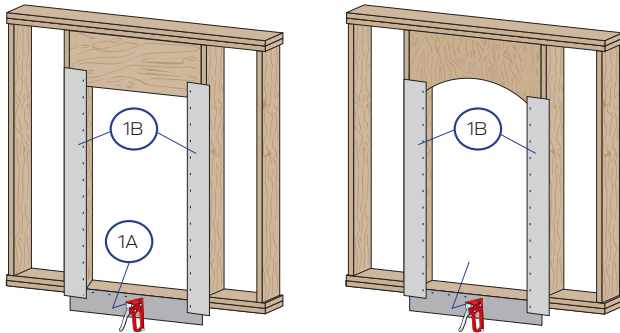

If using an optional sill pan, refer to the sill pan instruction page at the end of this booklet.

C. **Cut 2 pieces of flashing tape 12" longer than opening width.**

D. **Apply sill flashing tape #1** at the sill extending 1" to the exterior and 6" up each jamb.

E. **Cut 1" wide tabs at each corner** by tearing the foil 1/2" each way from corner.

F. **Apply sill flashing tape #2** overlapping tape #1 by 1" minimum.

Note: Press all tape down firmly.

G. **Attach a Pella aluminum sill support** or wood blocking flush with the opening sill.

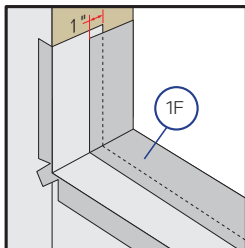
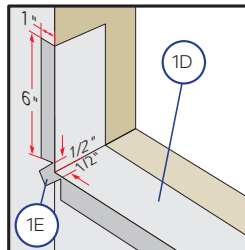
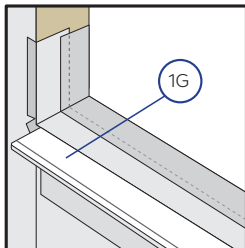

2 SETTING AND FASTENING THE DOOR

A. **Place three 3/8" beads of sealant across the opening sill.** Place the interior-most bead 1/2" from where the interior of the door sill will remain after installation. Continue this bead up the sill pan lip, if applicable.

Place a second bead beginning from the interior bead 1/2" from each side, out to the exterior of the framing and along the opening. Leave 2" voids 4" from the corner and at the center. Place a third bead where the exterior of the door sill will remain after installation.

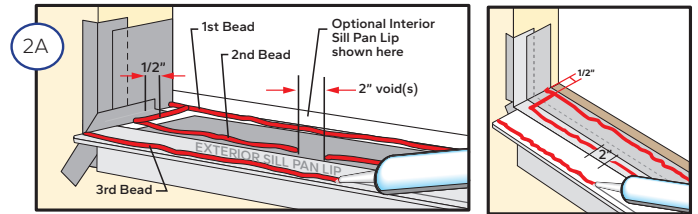

B. **Center the bottom of the door in the opening** and tilt the door into position. Do not slide the door into the opening. Sliding will damage the sealant lines.

Check the hinge jambs for plumb and confirm there is room for shimming between the jambs and opening on each side.

C. **Drive two fasteners,** one near each end of the top nailing fin. (See nail fin anchor instructions at the end of this booklet)

D. **Plumb and square the door.** Place shims at each hinge and lock strike. Keep shims 1/2" short of door frame depth. Insert additional shims starting 6" from the bottom as needed to keep jambs straight and panel reveals even on all four sides.

Note: Additional shims are required at screw locations for advanced performance, impact resistant units and combinations. See the nail fin anchor instructions at the end of this booklet.

E. **Check the door placement by measuring** from the interior surface of the door frame or jamb extension to the interior surface of the wall for consistency. If the dimensions are not equal, confirm the fins are folded fully to 90° (if applicable).

F. **Finish driving fasteners** into the nailing fin. Refer to the nail fin anchor instructions at the end of this booklet.

G. **Check door operation.**

Carefully open the door(s) and remove the shipping spacers (check under the door panel(s)). Use the construction handle to operate the panel(s).

To operate flushbolts, see the instruction label on the astragal strike (if applicable).

Note: Adjust shims to correct any issues with plumb, square, operation or reveal.

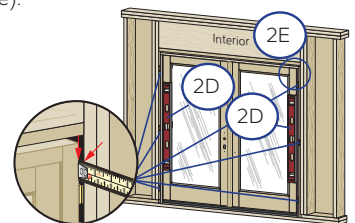
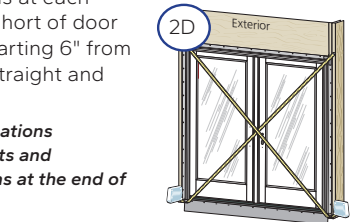
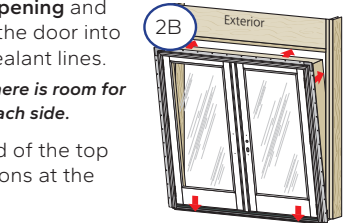

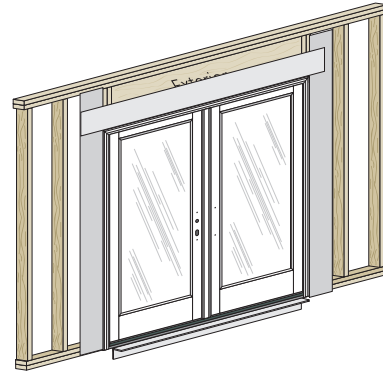
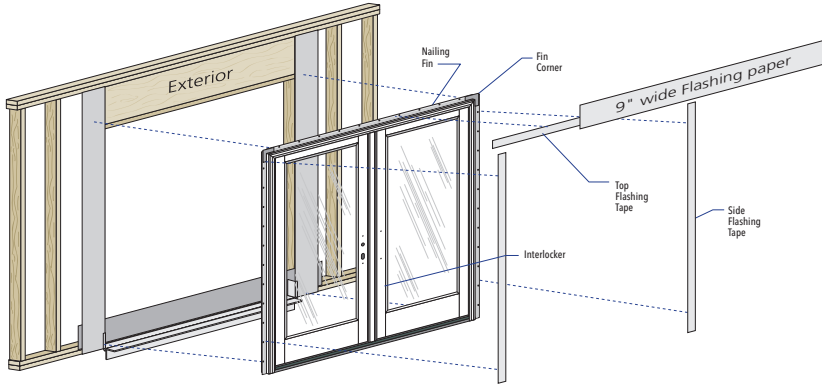

2 SETTING AND FASTENING THE DOOR (CONTINUED)

- H. **Pre-drill and drive screws at hinges, head and sill strikes or jamb strikes, threshold or low-profile sill and frames.** See the nail fin anchor instructions at the end of this booklet.
- I. **Open and close the door to check operation.** Make sure the door will latch correctly. If there are problems with operation adjust the shims and hinges (see below) and confirm the door frame is plumb, level and square and the gap between the door panel(s) and frame is consistent.
- J. **Adjustable hinges can be used to move the panel(s).** Turn the center screw with a T20 Torx wrench clockwise (+) to move the panel away from the frame or counter-clockwise (-) to move the panel toward the frame. A 3/4 turn provides approximately 5/32" adjustment.

Do not adjust the hinges if the top and bottom hinge screws are loose.

- K. **Doors without adjustable hinges have plastic shims behind the hinges;** remove shims to move the panel toward the frame. Additional shims may be added to move the panel away from the frame.

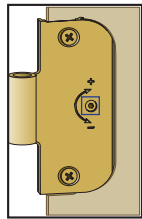

Adjustable Hinge

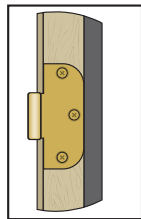

Non-Adjustable Hinge

3 INTEGRATING WITH THE BUILDING WRAP

Note: For fold-up or slide-in fins, seal the fin to frame joint by either applying flashing tape 1/2" onto the frame, or sealing the joint with installation sealant after placing flashing tape.

Flashing Tape Option

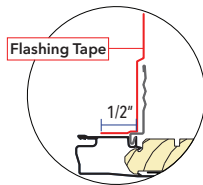

Sealant Option

(Ensure sealant compatibility with flashing materials)

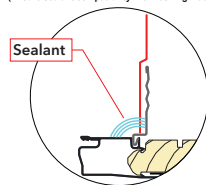

- A. **Apply straight side flashing tape.** Cut two pieces of flashing tape 4" taller than straight sides. Apply tape over the fin and onto weather resistive barrier. Extend tape 2" above and below straight sides.

Doors with angle top transoms or curved tops: On the short side, do not allow the side tape to extend higher than what the top tape will cover.

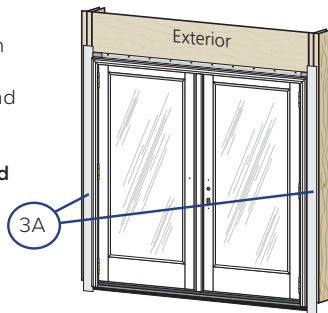

- B. **Apply top flashing tape.**

Rectangular Units: Cut one piece of flashing tape to extend 1" past both side flashing tapes.

Curved Top Units: Using several short pieces, start taping from the sides of the door working towards the peak. Cut each piece short enough so each piece overlaps the previous piece. Tighter curved frames will require shorter pieces of tape.

NOTE: PRESS ALL FLASHING TAPE DOWN FIRMLY.

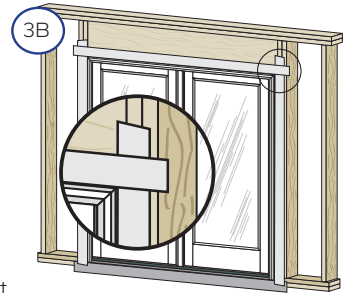

- C. **Apply top flashing paper.**

Rectangular doors: Cut one piece of 9" minimum width flashing paper 21" longer than the door width. Center it above the door and flush with the top. Staple it to the header.

Shaped Doors: Cut one piece of flashing paper long enough to overlap the side flashing paper by 2" on each side. Cut the bottom of the paper to match the shape of the door (curved only). Center it above the door and flush with the top. Staple it to the header. Ensure the top of the side flashing paper is completely covered by the top flashing paper on each side. Apply multiple pieces of top flashing paper if necessary overlapping them 6" in watershed fashion.

NOTE: When apply building paper to the wall, ensure the sill flashing paper overlaps the building paper to create a watershed effect.

- D. **Install interior sealant.** Refer to the interior sealant instructions at the end of this booklet.
- H. **Install head flashing,** properly incorporating it with the siding and building wrap according to applicable code requirements.
- I. **Install exterior sealant** (after wall cladding is installed). Refer to the exterior sealant instructions at the end of this booklet.

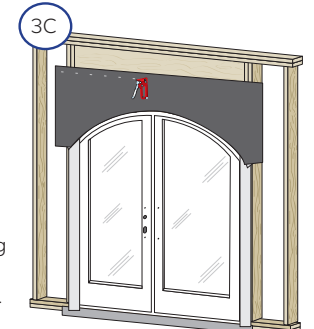
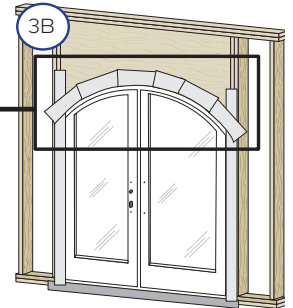
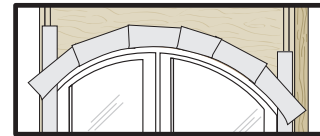

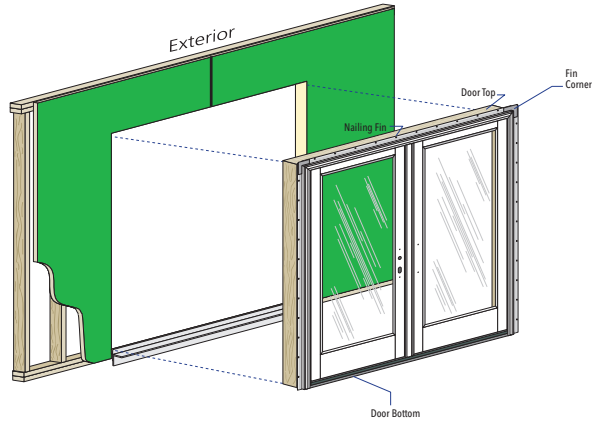
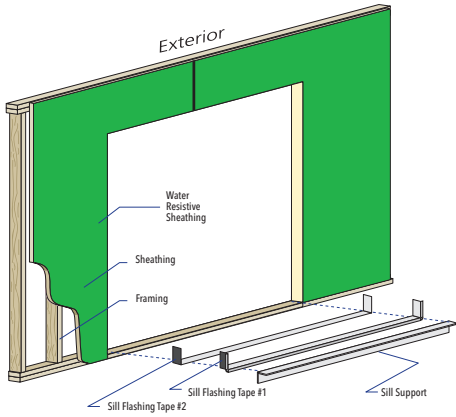

1 PREPARE THE OPENING

Refer to the nail fin installation preparation section at the beginning of this booklet.

A. **Inspect the joints of the water resistant sheathing.** Joints must be sealed according to the sheathing manufacturer's instructions. Pella Corporation assumes no responsibility for the design, quality or durability of the sheathing system or its joints. Taped joints intersecting with the bottom or sides of the opening must have tape installed before beginning installation.

If using an optional sill pan, refer to the sill pan instruction page at the end of this booklet.

B. **Cut 2 pieces of flashing tape 12" longer than opening width.**

C. **Apply sill flashing tape #1** at the sill extending 2" to the exterior and 6" up each jamb.

D. **Cut 1" wide tabs** at each corner by tearing the foil 1/2" each way from corner.

E. **Apply sill flashing tape #2** overlapping tape #1 by 1" minimum.

Note: For In-Swing Doors with frame depth greater than 5", add a third piece of flashing tape so it comes within 1/4" of the interior of the door frame.

F. **Cut 2 pieces of flashing tape** equal to the height of each side of the opening.

G. **Apply one piece on each jamb** starting 1" from the exterior of the framing, over the edge of the sheathing and onto the surface of the sheathing.

IMPORTANT: Use a roller to firmly press all flashing tape down until the texture of the sheathing can be seen through the tape.

H. **Attach a Pella aluminum sill support** or wood blocking flush with the opening sill.

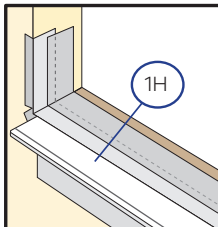
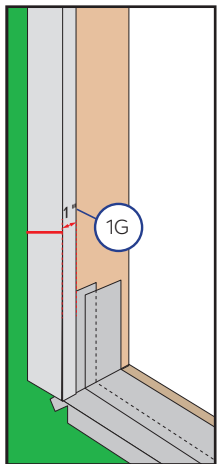
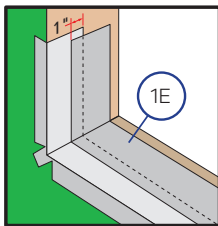
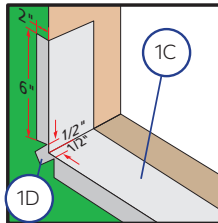

2 SETTING AND FASTENING THE DOOR

A. **Place three 3/8" beads of sealant** across the opening sill. Place the interior-most bead 1/2" from where the interior of the door sill will remain after installation. Continue this bead up the sill pan lip, if applicable.

Place a second bead beginning from the interior bead 1/2" from each side, out to the exterior of the framing and along the opening. Leave 2" voids 4" from the corner and at the center. Place a third bead where the exterior of the door sill will remain after installation.

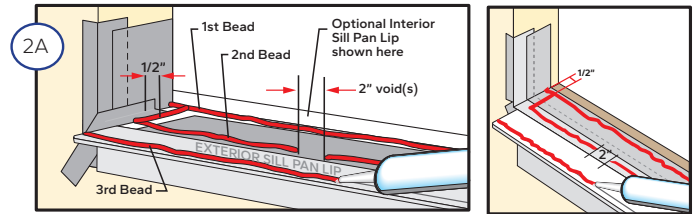

B. **Center the bottom of the door in the opening** and tilt the door into position. Do not slide the door into the opening. Sliding will damage the sealant lines.

Check the hinge jambs for plumb and confirm there is room for shimming between the jambs and opening on each side.

C. **Drive two fasteners,** one near each end of the top nailing fin. (See nail fin anchor instructions at the end of this booklet)

D. **Plumb and square the door.** Place shims at each hinge and lock strike. Keep shims 1/2" short of door frame depth. Insert additional shims starting 6" from the bottom as needed to keep jambs straight and panel reveals even on all four sides.

Note: Additional shims are required at screw locations for advanced performance, impact resistant units and combinations. See the nail fin anchor instructions at the end of this booklet.

E. **Check the door placement by measuring** from the interior surface of the door frame or jamb extension to the interior surface of the wall for consistency. If the dimensions are not equal, confirm the fins are folded fully to 90° (if applicable).

F. **Finish driving fasteners** into the nailing fin. Refer to the nail fin anchor instructions at the end of this booklet.

G. **Check door operation.**

Carefully open the door(s) and remove the shipping spacers (check under the door panel(s)). Use the construction handle to operate the panel(s).

To operate flushbolts, see the instruction label on the astragal strike (if applicable).

Note: Adjust shims to correct any issues with plumb, square, operation or reveal.

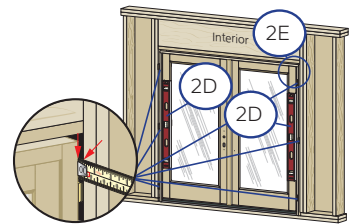
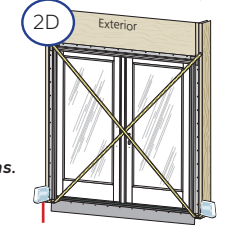
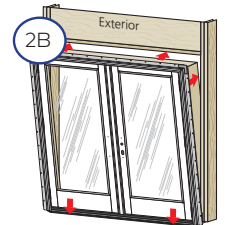



NEW CONSTRUCTION INSTALLATION WITH NAIL FIN OVER WATER RESISTANT SHEATHING (CONTINUED)

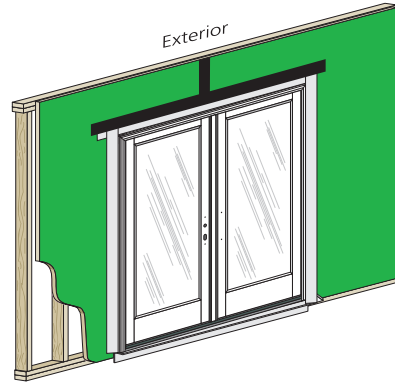
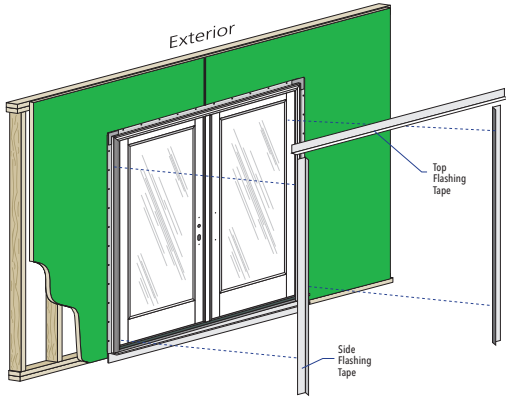

2 SETTING AND FASTENING THE DOOR (CONTINUED)

- H. **Pre-drill and drive screws at hinges, head and sill strikes or jamb strikes, threshold or low-profile sill and frames.** See the nail fin anchor instructions at the end of this booklet.
- I. **Open and close the door to check operation.** Make sure the door will latch correctly. If there are problems with operation adjust the shims and hinges (see below) and confirm the door frame is plumb, level and square and the gap between the door panel(s) and frame is consistent.
- J. **Adjustable hinges can be used to move the panel(s).** Turn the center screw with a T20 Torx wrench clockwise (+) to move the panel away from the frame or counter-clockwise (-) to move the panel toward the frame. A 3/4 turn provides approximately 5/32" adjustment.

Do not adjust the hinges if the top and bottom hinge screws are loose.

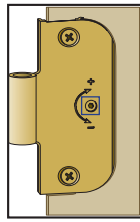

Adjustable Hinge

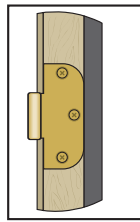

Non-Adjustable Hinge

- K. **Doors without adjustable hinges have plastic shims behind the hinges;** remove shims to move the panel toward the frame. Additional shims may be added to move the panel away from the frame.

3 INTEGRATING WITH THE BUILDING WRAP

Note: For fold-up or slide-in fins, seal the fin to frame joint by either applying flashing tape 1/2" onto the frame, or sealing the joint with installation sealant after placing flashing tape.

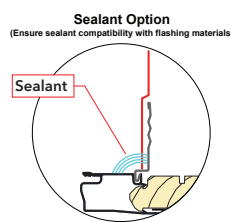
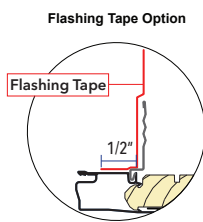

- A. **Apply straight side flashing tape.** Cut two pieces of flashing tape 4" taller than straight sides. Apply tape over the fin and onto weather resistive barrier. Extend tape 2" above and below straight sides.

Doors with angle top transoms or curved tops: On the short side, do not allow the side tape to extend higher than what the top tape will cover.

- B. **Apply top flashing tape.**

Rectangular Units: Cut one piece of flashing tape to extend 1" past both side flashing tapes.

Curved Top Units: Using several short pieces, start taping from the sides of the door working towards the peak. Cut each piece short enough so each piece overlaps the previous piece. Tighter curved frames will require shorter pieces of tape.

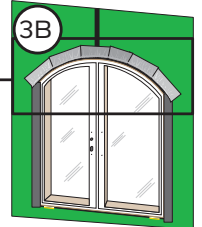
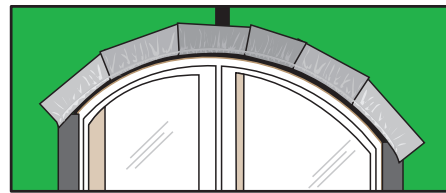
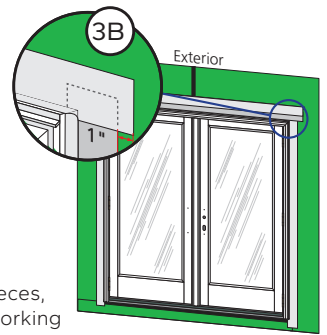

- C. **Apply a second layer of sheathing manufacturer's joint sealant tape.** Cut one piece so it will extend 1" past the first layer of flashing tape on each side. Overlap the first layer of tape by 1" to create a water shed effect.
- D. **Apply sheathing manufacturer's joint sealant tape** to any joints intersecting with the top of the opening, overlapping the head sealant tape in accordance with the manufacturer's instructions.

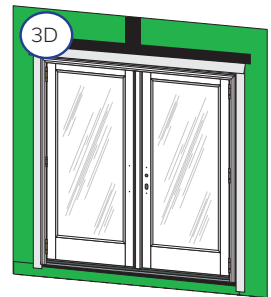
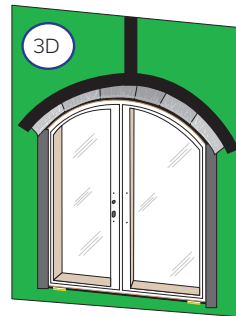

IMPORTANT: Use a roller to firmly press all flashing tape down until the texture of the sheathing can be seen through the tape.

- E. **Install interior sealant.** Refer to the interior sealant instructions at the end of this booklet.
- F. **Install head flashing,** properly incorporating it with the siding and sheathing according to applicable code requirements.
- G. **Install exterior sealant.** (After wall cladding is installed) Refer to the exterior sealant instructions at the end of this booklet.



NEW CONSTRUCTION INSTALLATION INTO MASONRY CONSTRUCTION
FOR THE INSTALLATION OF NEW NAIL FIN DOORS INTO MASONRY OPENINGS WITH WOOD BUCKS

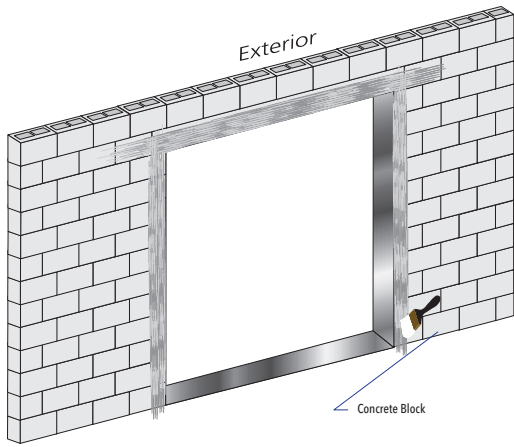

1 PREPARE THE OPENING

Refer to the nail fin installation preparation section at the beginning of this booklet.

A. **Apply water resistant coating.** Extend the coating into the opening on all four sides and onto the wall surface at least 9". The water resistant coating may be a self-adhered sheet membrane (SASM) or a liquid applied flashing. Ensure continuity between the water resistant coating in the opening and the rest of the wall surface. SASM's must be overlapped in a water shed fashion. Apply all water resistant coatings according to the manufacturer's directions.

Note: Allow liquid flashing to dry according to the manufacturer's recommendations.

B. **Apply 2 beads of sealant** to the masonry opening where the wood buck will be attached.

Note: Ensure the sealant is compatible with the water resistant coating.

C. **Pre-drill and fasten the treated wood buck** to the masonry opening using code-approved fasteners and spacing.

D. **Apply water resistant coating (optional)** over the wood buck and onto the masonry opening. If using liquid applied flashing, allow it to dry according to the manufacturer's recommendations before proceeding.

E. **Attach a Pella aluminum sill support** or wood blocking flush with the opening sill.

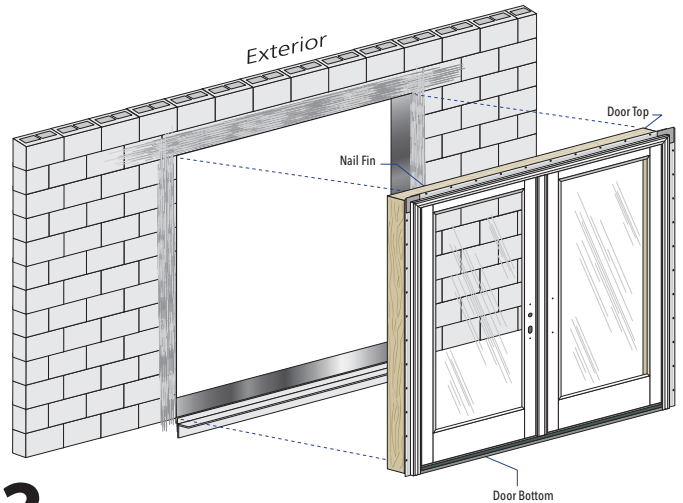
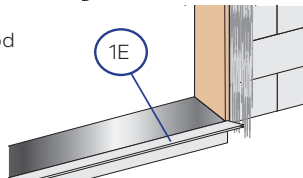
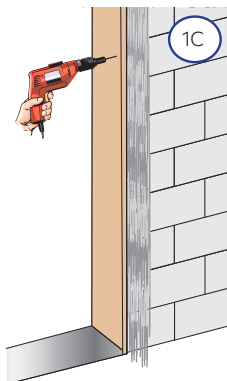
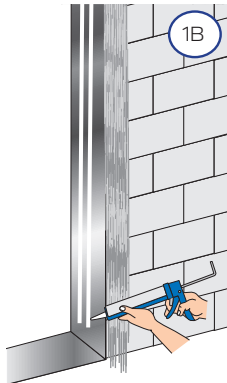

2 SETTING AND FASTENING THE DOOR

A. **Place three 3/8" beads of sealant** across the opening sill. Place the interior-most bead 1/2" from where the interior of the door sill will remain after installation. Continue this bead up the sill pan lip, if applicable.

Place a second bead beginning from the interior bead 1/2" from each side, out to the exterior of the framing and along the opening. Leave 2" voids 4" from the corner and at the center. Place a third bead where the exterior of the door sill will remain after installation.

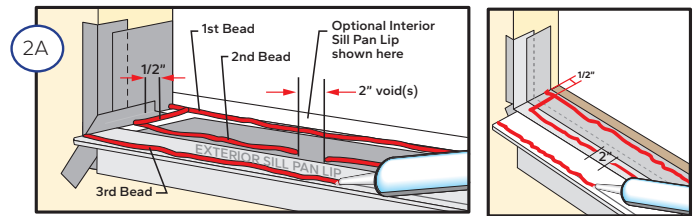

B. **Center the bottom of the door in the opening** and tilt the door into position. Do not slide the door into the opening. Sliding will damage the sealant lines.

Check the hinge jambs for plumb and confirm there is room for shimming between the jambs and opening on each side.

C. **Drive two fasteners,** one near each end of the top nailing fin. (See nail fin anchor instructions at the end of this booklet)

D. **Plumb and square the door.** Place shims at each hinge and lock strike. Keep shims 1/2" short of door frame depth. Insert additional shims starting 6" from the bottom as needed to keep jambs straight and panel reveals even on all four sides.

Note: Additional shims are required at screw locations for advanced performance, impact resistant units and combinations. See the nail fin anchor instructions at the end of this booklet.

E. **Check the door placement by measuring** from the interior surface of the door frame or jamb extension to the interior surface of the wall for consistency. If the dimensions are not equal, confirm the fins are folded fully to 90° (if applicable).

F. **Finish driving fasteners** into the nailing fin. Refer to the nail fin anchor instructions at the end of this booklet.

G. **Check door operation.**

Carefully open the door(s) and remove the shipping spacers (check under the door panel(s)). Use the construction handle to operate the panel(s).

To operate flushbolts, see the instruction label on the astragal strike (if applicable).

Note: Adjust shims to correct any issues with plumb, square, operation or reveal.

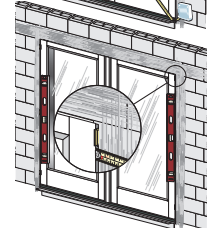
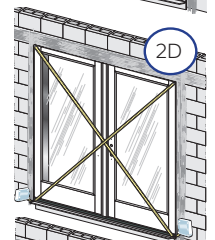
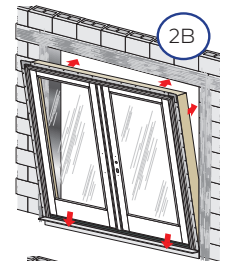



NEW CONSTRUCTION INSTALLATION INTO MASONRY CONSTRUCTION (CONTINUED)
FOR THE INSTALLATION OF NEW NAIL FIN DOORS INTO MASONRY OPENINGS WITH WOOD BUCKS

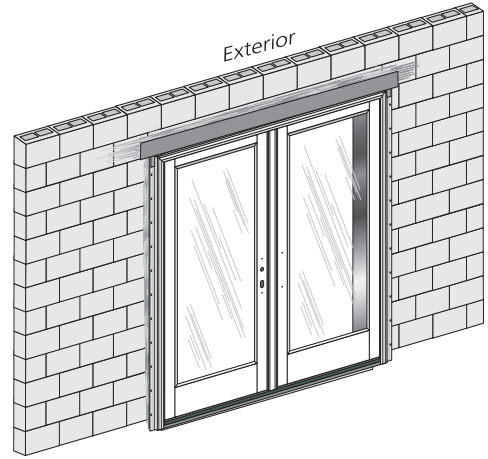
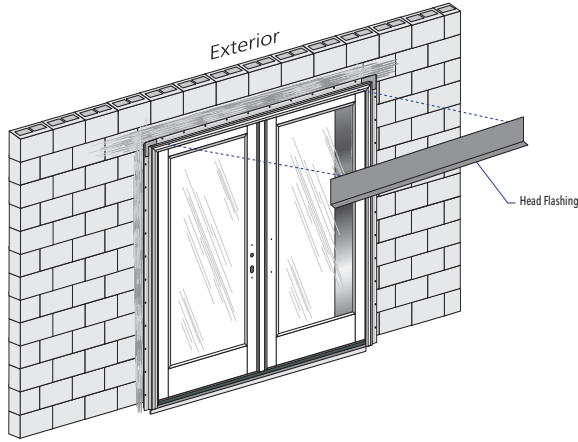

2 SETTING AND FASTENING THE DOOR (CONTINUED)

H. **Pre-drill and drive screws at hinges, head and sill strikes or jamb strikes, threshold or low-profile sill and frames.** See the nail fin anchor instructions at the end of this booklet.

I. **Open and close the door to check operation.** Make sure the door will latch correctly. If there are problems with operation adjust the shims and hinges (see below) and confirm the door frame is plumb, level and square and the gap between the door panel(s) and frame is consistent.

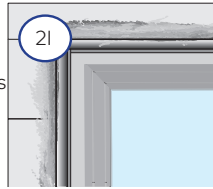

J. **Adjustable hinges can be used to move the panel(s).** Turn the center screw with a T20 Torx wrench clockwise (+) to move the panel away from the frame or counter-clockwise (-) to move the panel toward the frame. A 3/4 turn provides approximately 5/32" adjustment.

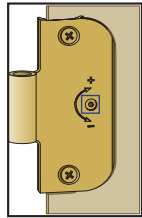

Adjustable Hinge

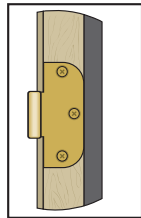

Non-Adjustable Hinge

Do not adjust the hinges if the top and bottom hinge screws are loose.

K. **Doors without adjustable hinges have plastic shims behind the hinges;** remove shims to move the panel toward the frame. Additional shims may be added to move the panel away from the frame.

3 INTEGRATING WITH THE BUILDING WRAP

Note: For fold-up or slide-in fins, seal the fin to frame joint by either applying flashing tape 1/2" onto the frame, or sealing the joint with installation sealant after placing flashing tape.

If liquid applied flashing was used to prepare the opening, apply it over the nail fin at jambs and head at this time according to the manufacturer's instructions. Leave the sill nailing fin uncovered. If the opening was prepared using SASM, follow steps C-D.

A. **Apply straight side flashing tape.** Cut two pieces of flashing tape 4" taller than straight sides. Apply tape over the fin and onto weather resistive barrier. Extend tape 2" above and below straight sides. **Doors with angle top transoms or curved tops:** On the short side, do not allow the side tape to extend higher than what the top tape will cover.

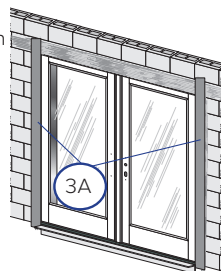
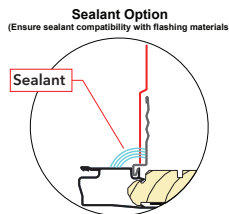
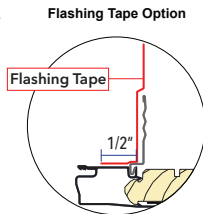

B. **Apply top flashing tape.**

Rectangular Units: Cut one piece of flashing tape to extend 1" past both side flashing tapes.

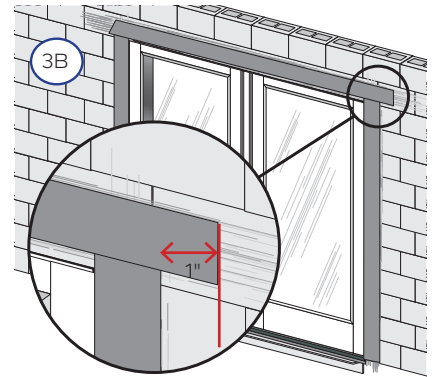

Curved Top Units: Using several short pieces, start taping from the sides of the door working towards the peak. Cut each piece short enough so each piece overlaps the previous piece. Tighter curved frames will require shorter pieces of tape.

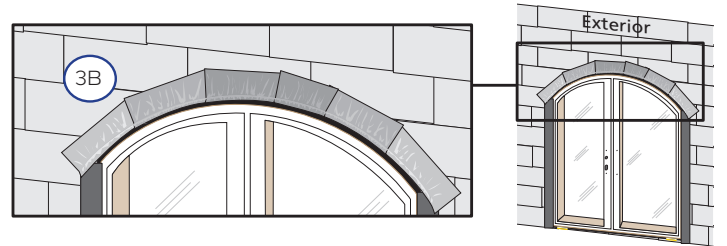

Note: PRESS ALL FLASHING TAPE DOWN FIRMLY.

Apply SASM or liquid applied water management system in watershed fashion with head flashing and in accordance with manufacturer's recommendations.

C. **Install interior sealant.** Refer to the interior sealant instructions at the end of this booklet.

D. **Install head flashing,** properly incorporating it with the siding and water management system according to applicable code requirements.

E. **Install exterior sealant.** (After wall cladding is installed) Refer to the exterior sealant instructions at the end of this booklet.

Note: Frame curved portions of rough opening to support door and wind loads (if applicable).



FULL FRAME REPLACEMENT WITH NAIL FIN

INSTALLATION OF NEW NAIL FIN DOORS AFTER THE REMOVAL OF EXISTING DOORS AND THE SURROUNDING TRIM OR SIDING

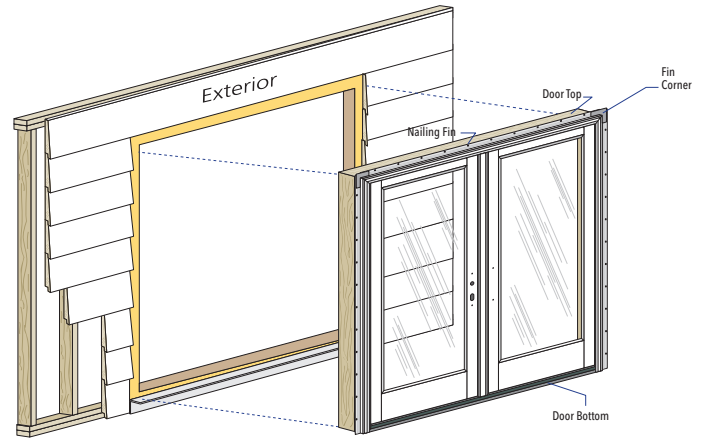
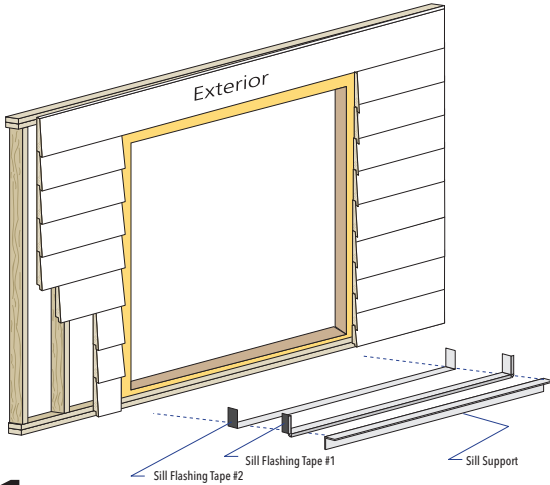

1 PREPARE THE OPENING

Refer to the existing frame removal instruction and nail fin installation preparation sections at the beginning of this booklet.

A. Repair the wall surface around the opening (if necessary) by installing new blocking flush with the surface of the existing sheathing and/or repairing the existing building wrap with flashing tape.

B. Cut 2 pieces of flashing tape 12" longer than opening width.

C. Apply sill flashing tape #1 extending far enough onto the wall surface to overlap the building wrap 1" or onto the top edge of the siding and 6" up each jamb.

D. Cut 1" wide tabs at each corner by tearing the foil 1/2" each way from corner.

E. Apply sill flashing tape #2 overlapping tape #1 by 1" minimum.

If existing building wrap is folded into the opening at the jambs, skip to step 1H.

F. Cut 2 pieces of flashing tape. Make one equal to the height of each side of the opening.

G. Apply one piece on each jamb starting 1" from the exterior of the framing, over the edge of the sheathing and onto the surface of the sheathing.

Note: PRESS ALL FLASHING TAPE DOWN FIRMLY.

H. Attach a Pella aluminum sill support or wood blocking flush with the opening sill.

I. Apply a continuous, 3/8" tall bead of sealant 1/2" from the edge of the opening at the sides and top only. Do NOT apply sealant at the sill. This step may be omitted if there will be at least 3" of wall surface between the edge of the door frame and the siding after installation.

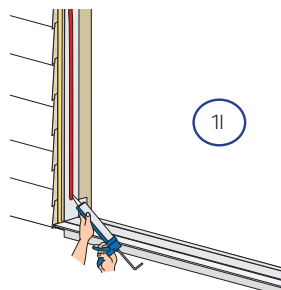
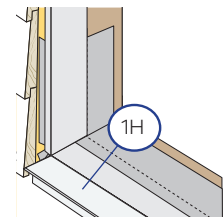
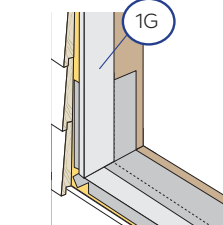
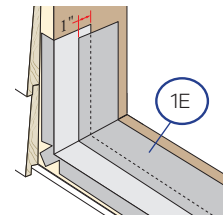
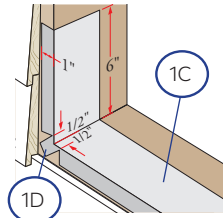

2 SETTING AND FASTENING THE DOOR

A. Place three 3/8" beads of sealant across the opening sill. Place the interior-most bead 1/2" from where the interior of the door sill will remain after installation. Continue this bead up the sill pan lip, if applicable.

Place a second bead beginning from the interior bead 1/2" from each side, out to the exterior of the framing and along the opening. Leave 2" voids 4" from the corner and at the center. Place a third bead where the exterior of the door sill will remain after installation.

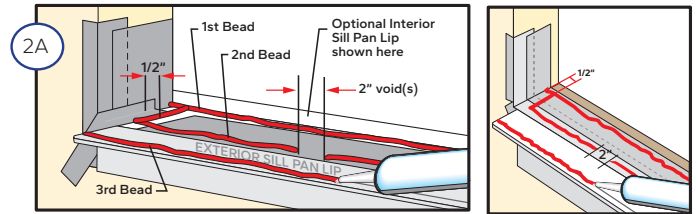

B. Center the bottom of the door in the opening and tilt the door into position. Do not slide the door into the opening. Sliding will damage the sealant lines.

Check the hinge jambs for plumb and confirm there is room for shimming between the jambs and opening on each side.

C. Drive two fasteners, one near each end of the top nailing fin. (See nail fin anchor instructions at the end of this booklet)

D. Plumb and square the door. Place shims at each hinge and lock strike. Keep shims 1/2" short of door frame depth. Insert additional shims starting 6" from the bottom as needed to keep jambs straight and panel reveals even on all four sides.

Note: Additional shims are required at screw locations for advanced performance, impact resistant units and combinations. See the nail fin anchor instructions at the end of this booklet.

E. Check the door placement by measuring from the interior surface of the door frame or jamb extension to the interior surface of the wall for consistency. If the dimensions are not equal, confirm the fins are folded fully to 90° (if applicable).

F. Finish driving fasteners into the nailing fin. Refer to the nail fin anchor instructions at the end of this booklet.

G. Check door operation.

Carefully open the door(s) and remove the shipping spacers (check under the door panel(s)). Use the construction handle to operate the panel(s).

To operate flushbolts, see the instruction label on the astragal strike (if applicable).

Note: Adjust shims to correct any issues with plumb, square, operation or reveal.

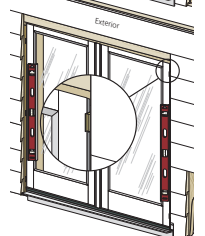
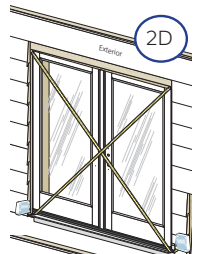
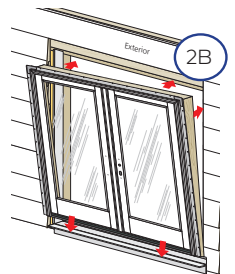



FULL FRAME REPLACEMENT WITH NAIL FIN (CONTINUED)

INSTALLATION OF NEW NAIL FIN DOORS AFTER THE REMOVAL OF EXISTING DOORS AND THE SURROUNDING TRIM OR SIDING

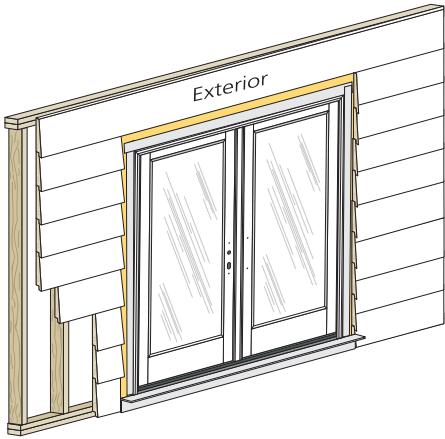

2 SETTING AND FASTENING THE DOOR (CONTINUED)

- H. **Pre-drill and drive screws at hinges, head and sill strikes or jamb strikes, threshold or low-profile sill and frames.** See the nail fin anchor instructions at the end of this booklet.
- I. **Open and close the door to check operation.** Make sure the door will latch correctly. If there are problems with operation adjust the shims and hinges (see below) and confirm the door frame is plumb, level and square and the gap between the door panel(s) and frame is consistent.
- J. **Adjustable hinges can be used to move the panel(s).** Turn the center screw with a T20 Torx wrench clockwise (+) to move the panel away from the frame or counter-clockwise (-) to move the panel toward the frame. A 3/4 turn provides approximately 5/32" adjustment.

Do not adjust the hinges if the top and bottom hinge screws are loose.

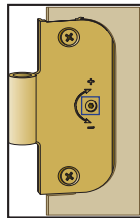

Adjustable Hinge

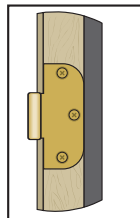

Non-Adjustable Hinge

- K. **Doors without adjustable hinges have plastic shims behind the hinges;** remove shims to move the panel toward the frame. Additional shims may be added to move the panel away from the frame.

3 INTEGRATING WITH THE BUILDING WRAP

Note: For fold-up or slide-in fins, seal the fin to frame joint by either applying flashing tape 1/2" onto the frame, or sealing the joint with installation sealant after placing flashing tape.

Flashing Tape Option

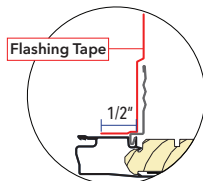

Sealant Option
(Ensure sealant compatibility with flashing materials)

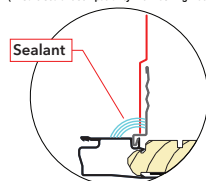

- A. **Apply straight side flashing tape.** Cut two pieces of flashing tape 4" taller than straight sides. Apply tape over the fin and onto weather resistive barrier. Extend tape 2" above and below straight sides.

Doors with angle top transoms or curved tops: On the short side, do not allow the side tape to extend higher than what the top tape will cover.

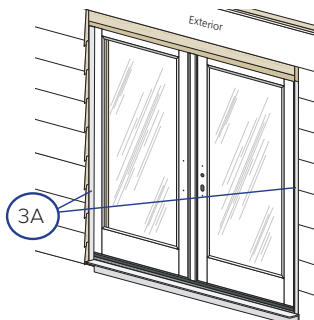

- B. **Apply top flashing tape.**

Rectangular Units: Cut one piece of flashing tape to extend 1" past both side flashing tapes.

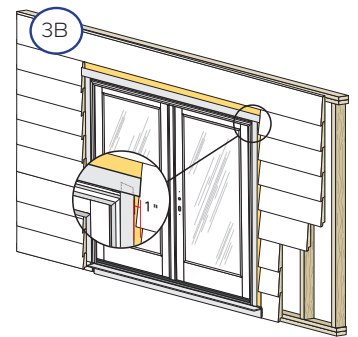

Curved Top Units: Using several short pieces, start taping from the sides of the door working towards the peak. Cut each piece short enough so each piece overlaps the previous piece. Tighter curved frames will require shorter pieces of tape.

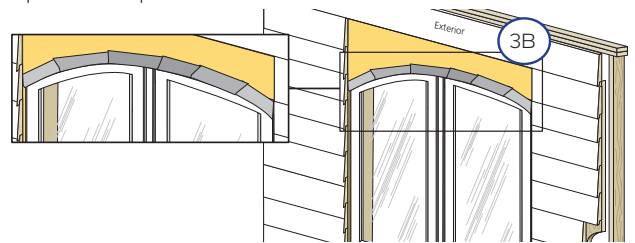

- C. **Install interior sealant.** Refer to the interior sealant instructions at the end of this booklet.
- D. **Install head flashing,** properly incorporating it with the siding and building wrap according to applicable code requirements.
- E. **Install exterior sealant.** (After wall cladding is installed) Refer to the exterior sealant instructions at the end of this booklet.
- F. **Install blocking for frame expander support or solid trim** at this time, if applicable.
- G. **Install frame expander and receptor** (if applicable). See separate instructions.

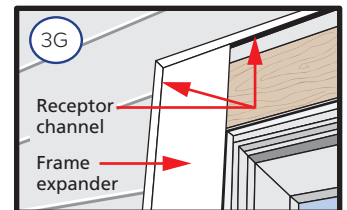



ANCHOR INSTRUCTIONS - ADVANCED PERFORMANCE ARCHITECT SERIES® AND IMPACT-RESISTANT ARCHITECT SERIES® PATIO DOORS

Pella® Impact-Resistant Products have been tested in accordance with the large missile impact testing requirements of ASTM E 1886 and ASTM E 1996. Pella Impact-Resistant Products are neither hurricane proof nor are they shatter proof. Severe wind and rain may produce temporary conditions which exceed product performance standards. When these units are subjected to intense storms or extreme conditions, which exceed the intended design pressures, air, water and flying debris infiltration may occur.

Advanced performance and Impact-Resistant require the use of installation clips or screws through the frame. The use of fins or brickmould is optional and will not affect anchorage requirements. Local building codes may have additional anchoring requirements.

Note: Refer to Florida Product Approval Instructions, when applicable.

Anchor Location	Venting	Anchor Type		Instructions	Illustration	
		Wood	Masonry			
Head and Jamb Nail Fin	Any	2" 11 Ga. Roofing Nail	NA	Every pre-punched hole		
Head	Strike	Active/Fixed 1-Panel Vent	(1) #8 x 3" stainless steel (provided)		Remove temporary strike screw(s) and place a dab of sealant in each hole before installing the new screws.	A
		Active/Passive	(3) #8 x 3" stainless steel (provided)		Remove temporary strike screw(s) and place a dab of sealant in each hole before installing the new screws.	A
	Frame	Vent	#8 x 3" corrosion resistant (provided)		For Doors ordered with no lock/no bore, Place 1 screw in each pre-drilled hole (if present).	F, H
	Frame-Screws	Fixed or Vent	#10 x 3-1/2" corrosion resistant	3/16" x 3" Masonry Screw	See Illustrations	F, H
	Frame-Clips	Fixed or Vent	(2) #8 x 1-1/4" corrosion resistant	3/16" x 1-1/2" Masonry Screw	See illustrations for spacing, secure clip to frame using (2) #6 x 5/8" corrosion resistant screws	E, F
	Frame	Door/Sidelight Combinations	#10 x 3" corrosion resistant	3/16" Masonry Screw	Pre-drill and install screws 3" and 6" on each side of each mullion end.	F, H
Jambs	Strike	Vent	#8 x 3" (provided)		Shim between the frame and rough opening at the strike.	D
	Hinges	Out-Swing	#12 x 2-1/2" corrosion resistant (provided)		Pre-drill and drive screws into rough opening or sidelight.	B
		In-Swing	#8 x 3" corrosion resistant (provided)		Pre-drill and drive screws into rough opening or sidelight.	B
	Frame-Screws	Fixed or Vent	#10 x 3-1/2" corrosion resistant	3/16" x 3" Masonry Screw	See Illustrations	F, G
	Frame-Clips	Fixed or Vent	(2) #8 x 1-1/4" corrosion resistant	3/16" x 1-1/2" Masonry Screw	See illustrations for spacing, secure clip to frame using (2) #6 x 5/8" corrosion resistant screws	E, F
Sill	Threshold	Vent	#10 x 3-1/2" corrosion resistant	3/16" x 3" Masonry Screw	Remove temporary screws before installing new screws	C
	Strike	Active/Fixed 1-Panel Vent	(1) #8 x 3" stainless steel (provided)		Remove temporary strike screw(s) and place a dab of sealant in each hole before installing the new screws.	A
		Active/Passive	(3) #8 x 3" stainless steel (provided)		Remove temporary strike screw(s) and place a dab of sealant in each hole before installing the new screws.	A
	Low Profile	Vent	#8 x 3" corrosion resistant (provided)	3/16" x 2" Masonry Screw	For doors with standard locks, install tubs per instruction included with sill strike package	C, F, H
	Threshold	Door/Sidelight Combinations	#10 x 3" corrosion resistant	3/16" Masonry Screw	Pre-drill and install screws 3" and 6" on each side of each mullion end.	C, F, H

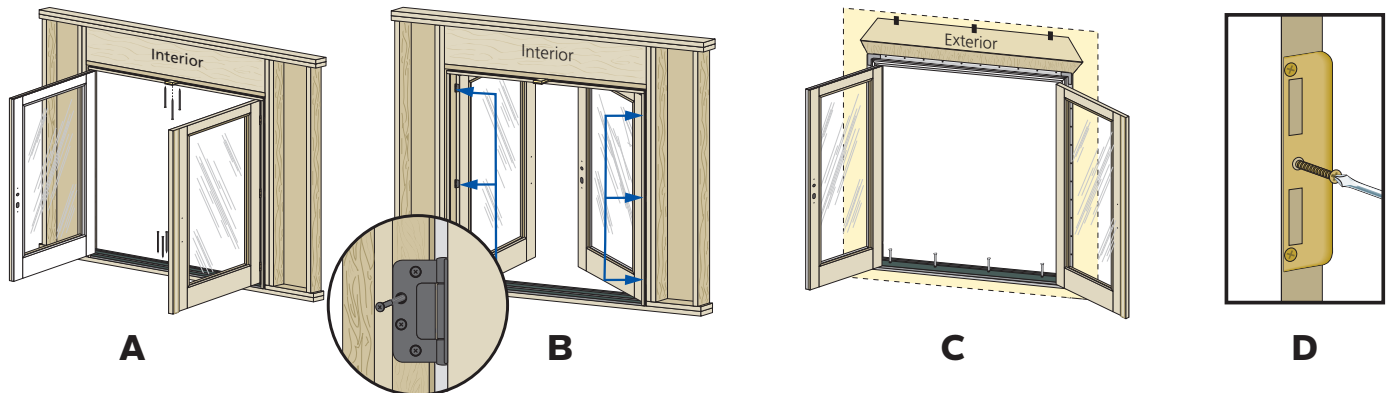

ILLUSTRATIONS CONTINUED ON NEXT PAGE



ANCHOR INSTRUCTIONS - ADVANCED PERFORMANCE ARCHITECT SERIES® AND IMPACT-RESISTANT ARCHITECT SERIES® PATIO DOORS

Pella® Impact-Resistant Products have been tested in accordance with the large missile impact testing requirements of ASTM E 1886 and ASTM E 1996. Pella Impact-Resistant Products are neither hurricane proof nor are they shatter proof. Severe wind and rain may produce temporary conditions which exceed product performance standards. When these units are subjected to intense storms or extreme conditions, which exceed the intended design pressures, air, water and flying debris infiltration may occur.

Advanced performance and Impact-Resistant require the use of installation clips or screws through the frame. The use of fins or brickmould is optional and will not affect anchorage requirements. Local building codes may have additional anchoring requirements.

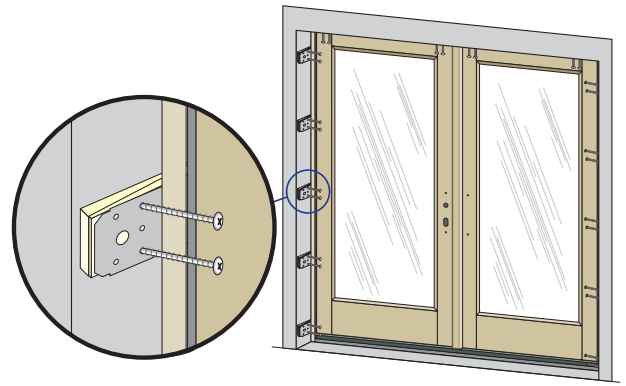

E

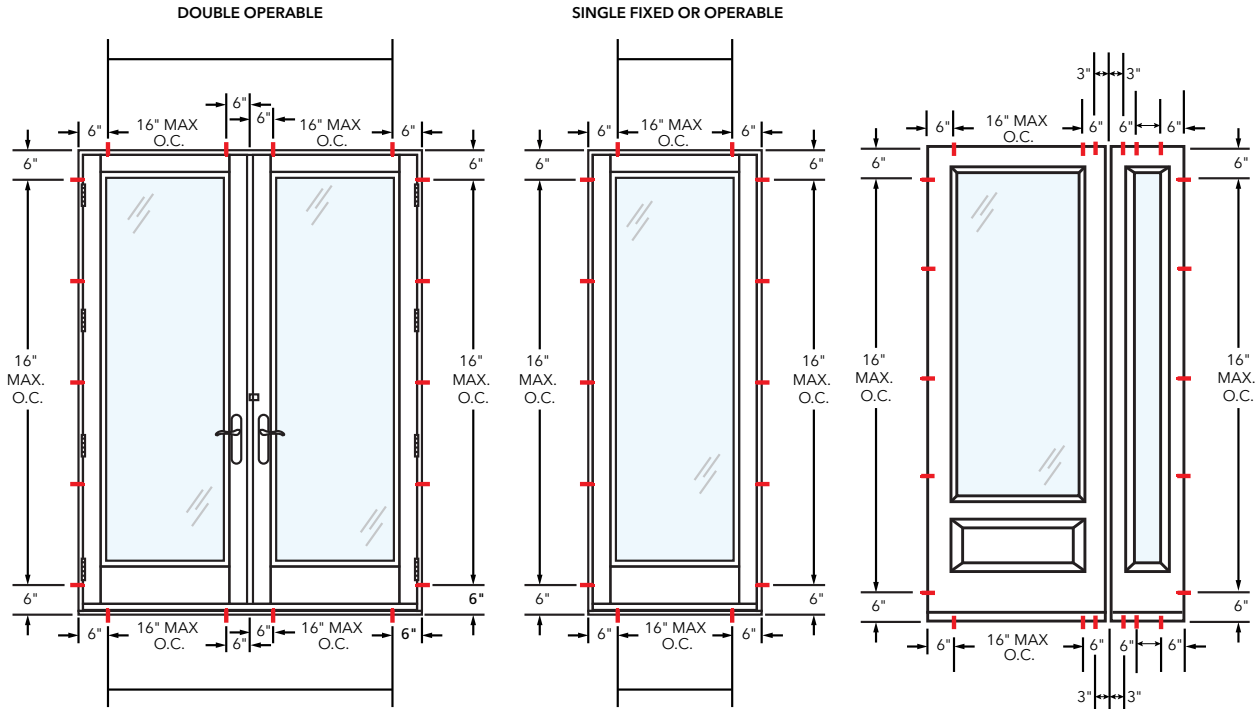

F

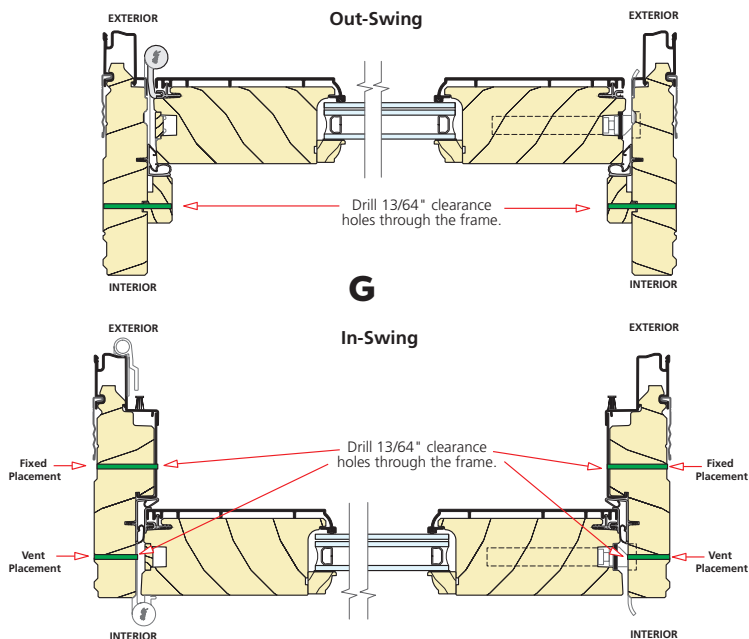

G

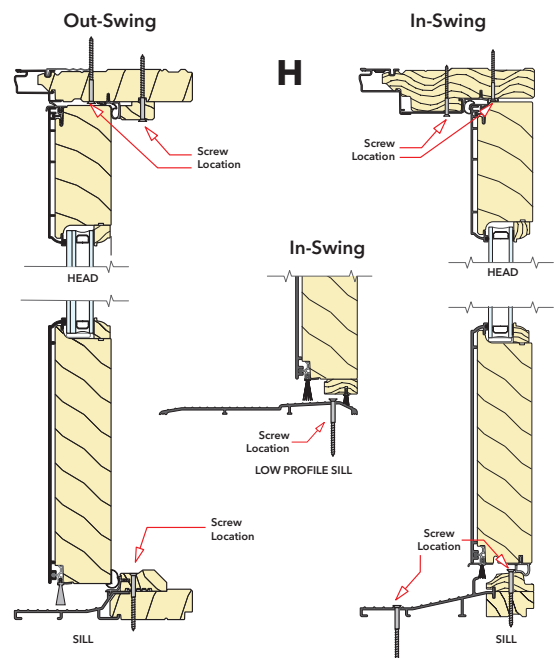

H



Interior Sealant Instructions

CAUTION: Continuous backer rod (as necessary) and a high quality, low-odor interior sealant such as Pella Window and Door Installation Sealant (or equivalent) is recommended for commercial or high performance installations to create the continuous interior seal. Follow the directions on the cartridge. For standard performance or products with factory applied jamb extensions, use low pressure polyurethane insulating foams. Follow the directions on the can. Do not use high pressure or latex foams. Fiberglass batt or similar insulation is not recommended as it can absorb water and does not act as an air seal.

- A. Insert the nozzle or straw between the rough opening and door frame from the interior. Use a pliers (if necessary) to compress the end of a straw tube to allow it to fit in tight openings.
- B. Place a 1" deep bead of foam approximately 1" from the interior of the frame to allow for expansion. DO NOT fill the entire depth of the rough opening cavity.

Note: Apply foam between the frame and rough opening, NOT between jamb extensions and the rough opening.

- C. Re-Check door operation and remove remaining shipping spacers after foam installation. Excess foam may be removed with a serrated knife after it cures.
- D. To ensure a continuous interior seal, apply sealant over or around any shims or clips interrupting the foam seal.
- E. Place a continuous bead of sealant across the inner sill at the intersection of the door sill and subfloor. Continue the sealant 6" up each jamb and connect with the foam seal.

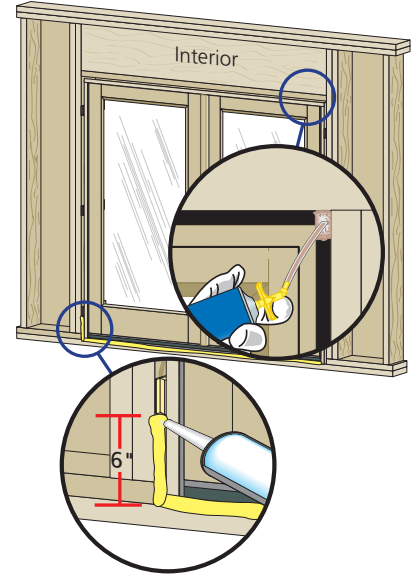

Exterior Sealant Instructions

CAUTION: Use a high quality, multi-purpose exterior sealant such as Pella Window and Door Installation Sealant. Follow the directions on the cartridge.

When applying siding, brick veneer, flashing, or other exterior finish materials, leave adequate space between the door frame and the material for sealant application of sealant.

- A. Insert backer rod 3/8" deep in the space around the door. Backer rod adds shape and controls the depth of the sealant line.
- B. Apply a continuous bead of sealant to the entire perimeter of the door.

NOTICE For sill pans designed to drain moisture directly to the exterior, voids in the exterior seal may be required.

- C. Shape, tool and clean excess sealant. When finished, the sealant should be the shape of an hourglass.

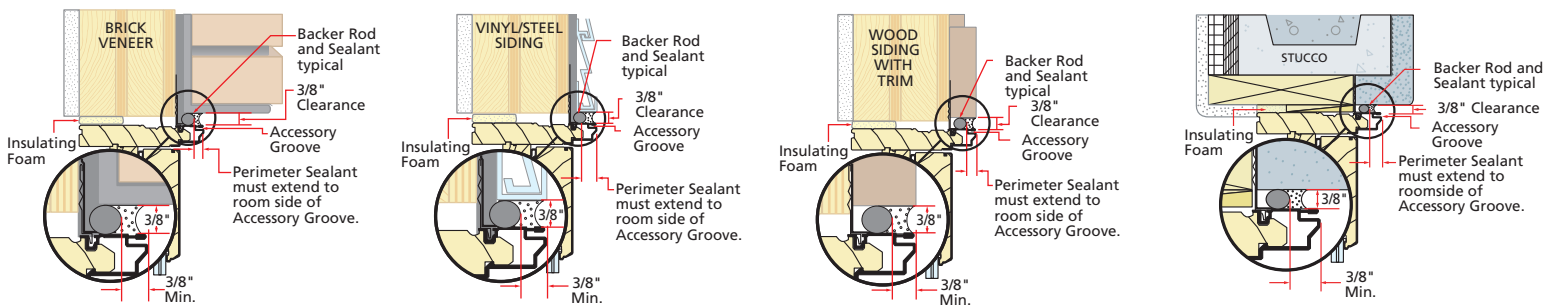
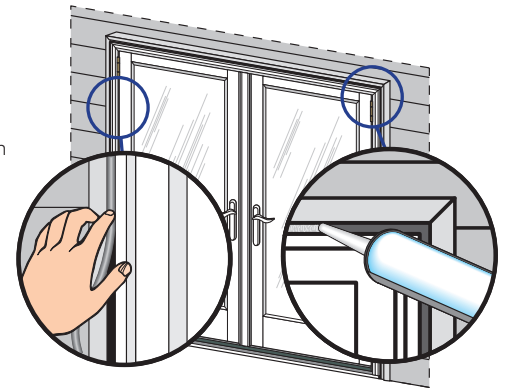

TROUBLESHOOTING - Adjustable Strike Latching Issues

Issue 1:
Door is difficult to latch. Remove the strike and adjustable strike shim then reinstall the strike.

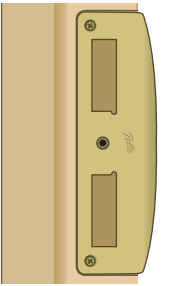

Issue 2:
Door needs to close more tightly against the weather-strip. Remove the strike and adjustable strike shim. Remove the tabs from the adjustable strike shim and install so that the thicker side is visible at the strike edge. Reinstall the strike.

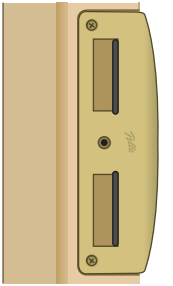
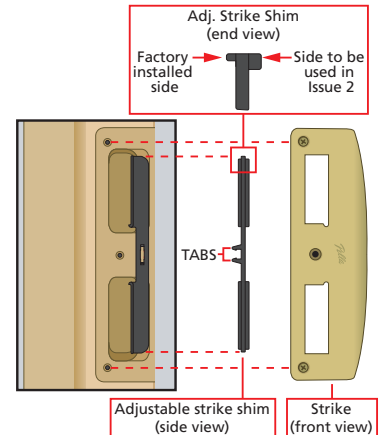

OPTIONAL SILL PAN INSTRUCTIONS

NOTICE The method of pan construction, flashing, and sealant application may vary depending on the design of the opening sill and exterior landing surface conditions. It is important to consider the exposure to weather, the exterior landing surface's proximity to the door sill, and to confirm impervious exterior surfaces properly slope away from the door.

A. **Cut the sill pan** to the width of the rough opening plus 2".

Note: The 2" added onto the rough opening width is for a 1" bend on each end.

B. **Make a 1" cut** in each fold at both end of the sill pan.

Note: These cuts will allow the edges of the sill pan to be bent.

Note: 4-5/8" wide for Out-Swing and In-Swing for 4-9/16" wall condition. For other wall conditions, measure wall depth and add 1/16".

C. **Cut 1" off each end** of the interior sill pan lip.

D. **Bend each end** of the center panel up.

E. **Install the sill pan** by sliding into place until the exterior sill pan lip is flush with the exterior of the rough opening.

F. **Apply sill flashing tape.** Cut a piece of flashing tape 2" longer than the opening width. Apply at the bottom of the opening, covering the exterior sill pan lip as shown.

Note: If applicable, apply spray adhesive to building felt prior to applying the flashing tape.

G. **Cut a piece of flashing tape** to the width of the opening. Install tape to the sill pan and overlap the flashing tape from step 1F by 1". If needed add a second or third piece of flashing tape until the sill pan is covered to the interior sill pan lip.

Note: The purpose of this tape is to seal the sill screws when installing the door.

H. **Cut two 9" pieces of flashing tape** with a 1" x 3" tab at the bottom, on opposite corners as shown.

I. **Apply the tabbed 9" pieces of flashing tape.** The tape is applied so 2" will cover the inside of the rough opening and lap over the side flange of the sill pan. The 1" x 3" tab laps over the bottom flashing tape as shown.

J. **Cut two 6" pieces of flashing tape** and apply to each side of the rough opening, overlapping the first piece by 1" and lapping the bottom over the side flange of the sill pan as shown.

K. **Cut two pieces of flashing tape 1-1/2" x 6"** and apply to the bottom corners of the opening by beginning in the corner of the sill pan, with 3/4" of the tape applied to the sill pan and 3/4" of the tape applied to the side flange. The remainder of the tape is to be at a 45 degree angle onto the exterior.

L. **Attach the aluminum sill support** or wood blocking to the exterior of the box plate to support the edge of the door sill. Place the sill support flush with the subfloor.

