

THE FOLLOWING INSTALLATION METHODS ARE INCLUDED IN THIS BOOKLET:

New Construction Installation After Building Wrap for Nail Fin Windows

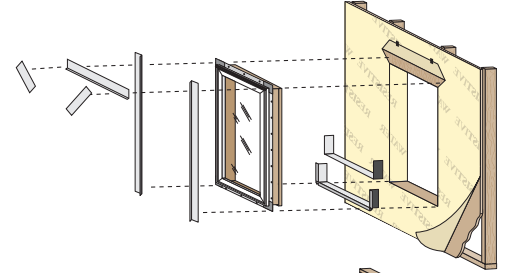

New Construction Installation Before Building Wrap for Nail Fin Windows

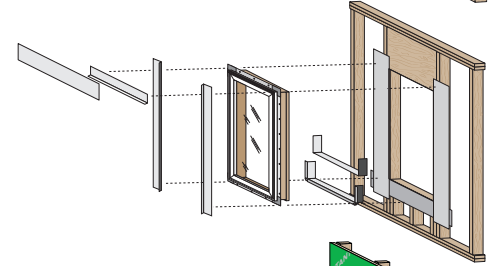

New Construction Installation with Water Resistant Sheathing for Nail Fin Windows

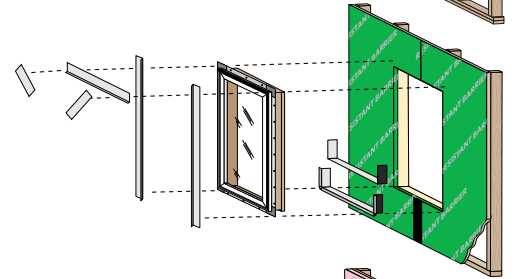

New Construction Installation with Nail Fin over 1-1/2" - 2" Continuous Exterior Insulation Using Rough Opening Support Brackets. (Patent Pending)

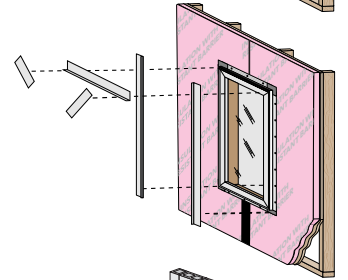

New Construction Installation in Masonry Construction for Nail Fin Windows

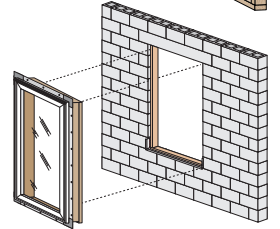

Full Frame Replacement after Brickmould/trim Removal or Siding cut-back for Nail Fin Windows

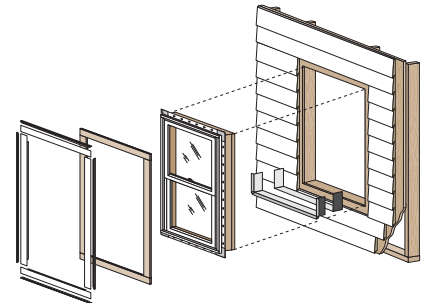

These instructions were developed and tested for use with wall systems designed to manage water. These instructions are not to be used with any other construction methods or window frame types. Installation instructions for use with other construction methods or frame types may be obtained from Pella Corporation, your local Pella® retailer or www.installpella.com. Building designs, construction methods, building materials, and site conditions unique to your project may require an installation method different from these instructions and/or additional care. Determining the appropriate installation method is the responsibility of you, your architect, or construction professional.



BY PURCHASING, INSTALLING OR USING PELLA PRODUCTS (INCLUDES PELLA GOODS AND PELLA SERVICES), YOU AGREED TO THE TERMS OF THE LIMITED WARRANTY AND YOU AND PELLA FURTHER AGREE TO ARBITRATE DISPUTES ARISING OUT OF OR RELATING TO PELLA PRODUCTS, AND YOU WAIVE ANY RIGHT TO PARTICIPATE IN A CLASS ACTION RELATED TO PELLA PRODUCTS unless you notify Pella of your decision to opt out of the Arbitration Agreement no later than ninety (90) calendar days from the date you purchased or otherwise took ownership of Your Pella Goods. Opting out of the Arbitration Agreement will not affect the coverage provided by any applicable limited warranty pertaining to Your Pella Products. For opt out information and additional details please read the Limited Warranty and Arbitration Agreement for your Pella Products at www.Pella.com/arbitration.



CAUTION: Many windows in older homes are painted with lead-based paint. Removal of old windows may disturb this paint. Proper precautions must be taken to minimize exposure to dust and debris. Consult state or local authorities and/or go to www.epa.gov/lead for more information.



WARNING: To ensure safety and security and help prevent property damage, including possible damage to your window or door, close and lock windows and doors any time they are not being used for venting on a nice day, and particularly during high winds or rain.

Important Notice

Because all construction must anticipate some water infiltration, it is important that the wall system be designed and constructed to properly manage moisture. Pella Corporation is not responsible for claims or damages caused by anticipated and unanticipated water infiltration; deficiencies in building design, construction and maintenance; failure to install Pella products in accordance with Pella's installation instructions; or the use of Pella products in wall systems which do not allow for proper management of moisture within the wall systems. The determination of the suitability of all building components, including the use of Pella products, as well as the design and installation of flashing and sealing systems are the responsibility of the Buyer or User, the architect, contractor, installer, or other construction professional and are not the responsibility of Pella.

Pella products should not be used in barrier wall systems which do not allow for proper management of moisture within the wall systems, such as barrier Exterior Insulation and Finish Systems (EIFS) (also known as synthetic stucco) or other non-water managed systems. Except in the states of California, New Mexico, Arizona, Nevada, Utah and Colorado, Pella makes no warranty of any kind on and assumes no responsibility for Pella windows and doors installed in barrier wall systems. In the states listed above, the installation of Pella Products in barrier wall or similar systems must be in accordance with Pella's installation instructions. Product modifications that are not approved by Pella Corporation will void the warranty.

Care and Maintenance

Care and maintenance information is available by contacting your local Pella retailer. This information is also available at www.pella.com.

Cleaning Instructions

GLASS: Remove any protective film and labels and clean the glass, using a soft, clean, grit-free cloth and mild soap or detergent. Be sure to remove all liquid by wiping dry or use a clean squeegee.

FACTORY FINISHED PRODUCT: Pella product that has been prefinished with stain or paint from the factory requires no additional finishing. Clean the surface with mild soap and water.

PELLA® ALUMINUM CLAD OR IMPERVIA FRAMES: The interior and exterior frame and sash are protected with a tough factory finish. Clean this surface with mild soap and water. Stubborn stains and deposits may be removed with mineral spirits. **DO NOT** use abrasives. **DO NOT** scrape or use tools that might damage the surface.

ENCOMPASS BY PELLA®, PELLA® 150 SERIES AND PELLA® 250 SERIES WINDOWS FRAMES: The vinyl frame may be cleaned using the same method as the glass. For stubborn dirt, a "non-abrasive" cleaner such as Bon-Ami® or Soft Scrub® may be used. Do not use solvents such as mineral spirits, toluene, xylene, naphtha or muriatic acid as they can dull the finish, soften the vinyl and/or cause failure of the insulated unit seal. Do not use Isopropyl Alcohol on laminated surfaces as it will damage the finish. Keep door tracks clear of dirt and debris. Keep weep holes open and clear of obstructions.

DO NOT use abrasives. **DO NOT** scrape or use tools that might damage the surface.

Notice: **DO NOT** use inappropriate solvents or brickwash or cleaning chemicals. If you do, permanent damage can result and the product failure, loss or damage would not be covered by the Limited Warranty.

Interior Finish (Wood Windows)

Paint or finish immediately after installation.

If products cannot be finished immediately, cover with clear plastic to protect from dirt, damage and moisture. Remove any construction residue before finishing. Sand all wood surfaces lightly with 180 grit or finer sandpaper. **DO NOT** use steel wool. **BE CAREFUL NOT TO SCRATCH THE GLASS.** Remove sanding dust. Pella products must be finished per the below instructions; failure to follow these instructions voids the Limited Warranty.

Note: To maintain proper product performance do not paint, finish or remove the weatherstripping, mohair dust pads, gaskets or vinyl parts. Air and water leakage will result if these parts are removed. After finishing, allow venting windows and doors to dry completely before closing them. If paint, stain or finish gets on the weatherstripping, wipe it off immediately with a damp cloth.

Window Cleaning and Prep Instructions for Unfinished or Primed windows: Dry wipe dust from windows gently. Examine window for possible smudges or fingerprints made from normal handling or construction. To remove smudges, lightly wipe surface with warm water. Scuff sand with light grade sand paper or abrasive pad (220 grit or higher). Rinse surface with warm water. Let window surfaces dry completely before applying finish.

Finish the windows as soon as possible after installation.

- On casement and awnings, it is optional to paint, stain or finish the vertical and horizontal sash edges.
- On single-hungs and double-hungs, do not paint, stain or finish the vertical sash edges, any finish on the vertical sash edges may cause the sash to stick; it is optional to paint, stain or finish the horizontal sash edges.

Pella Corporation is not responsible for interior paint and stain finish imperfections for any product that is not factory-applied by Pella Corporation. For additional information on finishing see the Pella Owner's Manual or go to www.pella.com.

The use of unapproved finishes, solvents or cleaning chemicals may cause adverse reactions with door materials. Pella will not be responsible for problems caused by the use of unapproved materials. If in doubt, contact your local retailer or representative.

Exterior Finish of Existing Frame (Pocket Replacement)

It is the responsibility of the homeowner, contractor or installer to ensure any exposed unfinished wood is covered or finished. Possible methods include, however are not limited to, covering with aluminum coil stock or painting.

For Casement Hardware Installation go to: www.installpella.com/trimaccessory/hardware



FULL FRAME REMOVAL WHEN PREPARING TO INSTALL A NEW NAIL FIN WINDOW

This method of Full Frame Removal involves removing the sash and entire frame of the existing window from the wall. The resulting opening is the original rough opening. The existing window nailing fins are usually nailed to the studs in frame construction with siding, brick veneer or other exterior material applied over the fin on the outside. The interior may have a drywall return from the wall to the window frame.

CAUTION: Many windows in older homes are painted with lead-based paint. Removal of old windows may disturb this paint. Proper precautions must be taken to minimize exposure to dust and debris. Consult state or local authorities and/or go to www.epa.gov/lead for more information.

TOOLS REQUIRED:

- Utility knife 
- Phillips and Standard screwdrivers 
- Pry bar 
- Circular saw 
- Hammer 
- Putty knife 

REMEMBER TO USE APPROPRIATE PERSONAL PROTECTIVE EQUIPMENT.

EXISTING WOOD BRICKMOULD FRAME WINDOW

- Score paint or varnish between the interior trim and the wall with a sharp utility knife.
NOTE: This will minimize the damage to the interior wall and trim.
- Remove the interior trim. Using a pry bar and block of wood, remove the interior trim from all four sides of the window including the stool at the bottom of the window. If the interior trim is being reused, pull the nails out through the back side of the board with nipper pliers.
- Cut the exterior sealant line between the exterior brickmould or trim and the exterior siding or wall cladding.
- Remove the exterior brickmould or flat trim using a pry bar and block of wood.
Caution: Some windows may come out of the opening as the exterior trim is removed.
- Remove the window frame using a pry bar if necessary.

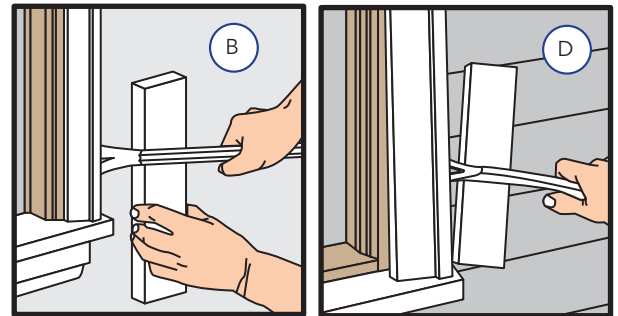

EXISTING NAIL FIN WINDOW REMOVAL

Sash Removal:

- Remove the vent sash and screen from the old window.
- Remove the fixed sash. In some cases, there are screws holding in the fixed sash. Remove the screws and take out the fixed sash.
NOTE: There may be a need to break the caulking free from around the fixed sash before it can be removed.
- Remove the division bar by unscrewing the fasteners holding it to the frame. If the screws are not accessible, then use a hacksaw to cut the division bar off at the head and sill flush with the old window frame.

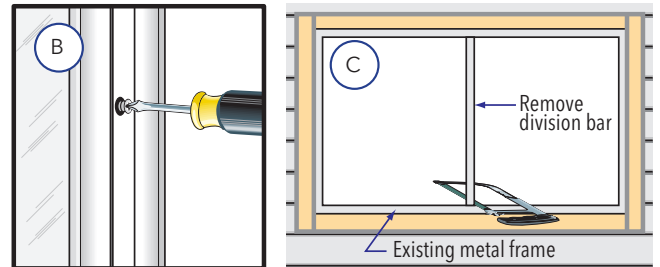

WINDOW WITH EXTERIOR TRIM

- Remove the existing exterior trim (if applicable). Use a block of wood to protect the exterior wall material. Use a pry bar to remove the existing exterior trim.
- Remove the nails or screws attaching the window nailing fin to the wall.
- Remove the window from the opening.

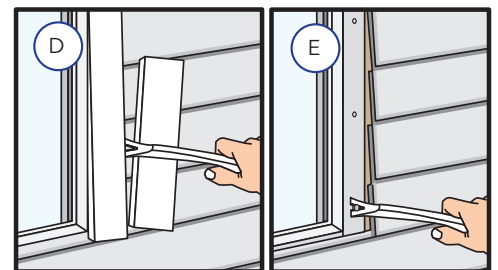

WINDOW WITH NO EXTERIOR TRIM

- Use a reciprocating saw to cut through sealant line and the nailing fin.
OR
- Remove siding or cut back the siding a minimum of 3" or far enough to expose the nailing fin. Remove the fasteners attaching the window to the wall.
NOTE: When cutting back the siding, set the saw blade depth 1/8" less than the thickness of the siding. Break the cut ends of the siding off after sawing. DO NOT cut through the existing building wrap.
- Remove the window from the wall.

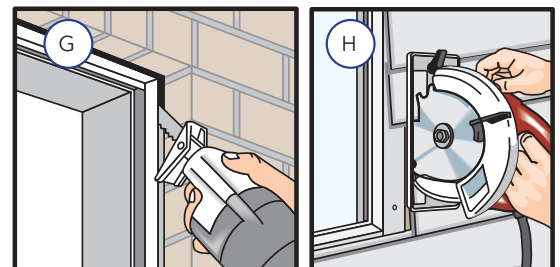







Consult with local providers and authorities to recycle or properly dispose of old window components.













PREPARING FOR NAIL FIN WINDOW INSTALLATION

YOU WILL NEED TO SUPPLY:

- Moisture resistant shims/spacers 
- Fasteners (see nail fin anchor instructions and tables at the end of this booklet) 
- Closed cell foam backer rod/sealant backer 
- Pella® SmartFlash™ foil backed butyl window and door flashing tape or equivalent 
- Low expansion, low pressure polyurethane insulating window and door foam sealant. DO NOT use high pressure or latex foams. 
- Pella Window and Door Installation Sealant or equivalent high quality, multi-purpose sealant 

TOOLS REQUIRED:

- Tape measure 
- Level 
- Square 
- Hammer 
- Stapler 
- Scissors or utility knife 
- Small flat blade screwdriver 
- Sealant Gun 
- Screw Gun with a Phillips Driver bit 
- Drill with 1/8", 5/32", 3/16" and 3/8" drill bits 
- 1/8" Allen wrench 

Other construction materials may be required. Read and understand the instructions and inspect the wall conditions before you begin.

INSTALLATION WILL REQUIRE (2) OR MORE PERSONS FOR SAFETY REASONS.

Store windows in upright position, out of direct sunlight.

ROUGH OPENING VERIFICATION

- Confirm the opening is plumb and level.
NOTE: It is critical the bottom is level and it does not slope to the interior.
- Remove dirt, oil or debris from the opening and surrounding wall surfaces.
- Confirm the window will fit the opening. Measure all four sides of the opening to make sure it is 1/2" to 3/4" larger than the window in both width and height. On larger openings measure the width and height in several places to ensure the header or studs are not bowed.
NOTE: 1-1/2" or more of solid wood blocking is typically required around the perimeter of the opening. Fix any problems with the rough opening before proceeding.
NOTE: For product with Flat Casing, measure all four sides of the opening to make sure it is 1-1/2" to 1-3/4" larger than the window in both width and height.
- For continuous exterior insulation panels up to 1" thick, utilize standard installation methods. For insulating panels 1.5" to 2" thick, Rough Opening Support Brackets or solid wood blocking is required.

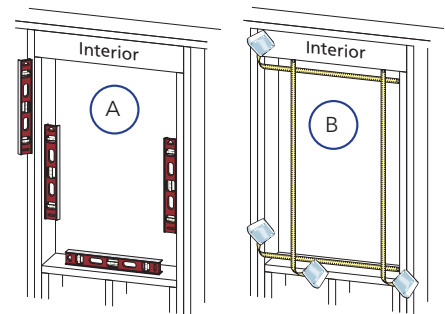

PREPARE THE WINDOW FOR INSTALLATION

- Remove plastic wrap and cardboard packaging from window. DO NOT cut checkrail bands (if present) or remove plastic or foam shipping spacers located between the window sash and frame. DO NOT open the window until it is securely fastened.
- Inspect the product for any damage such as cracks, dents or scratches. DO NOT install damaged windows.
- Remove screens and hardware (if necessary). Label them and set them aside in a protected area.
Windows with Half Screens: From the exterior, pull one side of the screen near the shipping clips until the clips disengage from the frame. Rotate the shipping clips toward the exterior of the screen until they snap free from the screen.
Half screens of some vinyl windows can be removed from the interior.
- Fold out installation fin to 90° (units with fold up fin only).
Be careful not to remove or tear the fin corners.
NOTE: If the fin is not at 90°, the window will not line up correctly on the interior.

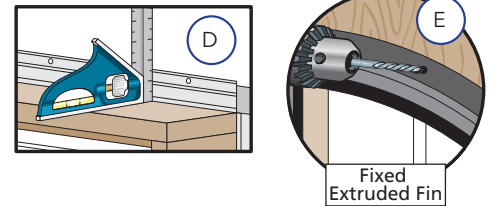
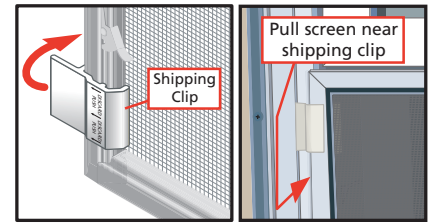

- Units with painted head drip cap fin and no pre-punched holes: Pre-drill holes through the fin (refer to the anchor page for spacing)
Curved top units with flexible fins: Prepare the window frame for attachment by pilot drilling through the frame or securing installation clips (refer to the anchor page).
Units with EnduraClad Exterior trim and narrow fins with NO pre-punched holes: Install clips or pre-drill holes for frame screws.
See the anchor instruction pages at the end of this booklet.
Additional preparation may be required for performance upgrade, impact-resistant products or to comply with local building code requirements.
- Read the entire instruction before proceeding.

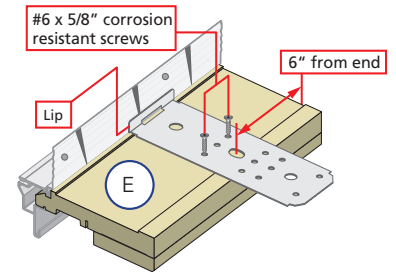

These instructions were developed and tested for use with wall systems designed to manage water. These instructions are not to be used with any other construction methods or window frame types. Installation instructions for use with other construction methods or frame types may be obtained from Pella Corporation, your local Pella® retailer or www.installpella.com. Building designs, construction methods, building materials, and site conditions unique to your project may require an installation method different from these instructions and/or additional care. Determining the appropriate installation method is the responsibility of you, your architect, or construction professional.



BY PURCHASING, INSTALLING OR USING PELLA PRODUCTS (INCLUDES PELLA GOODS AND PELLA SERVICES), YOU AGREED TO THE TERMS OF THE LIMITED WARRANTY AND YOU AND PELLA FURTHER AGREE TO ARBITRATE DISPUTES ARISING OUT OF OR RELATING TO PELLA PRODUCTS, AND YOU WAIVE ANY RIGHT TO PARTICIPATE IN A CLASS ACTION RELATED TO PELLA PRODUCTS unless you notify Pella of your decision to opt out of the Arbitration Agreement no later than ninety (90) calendar days from the date you purchased or otherwise took ownership of Your Pella Goods. Opting out of the Arbitration Agreement will not affect the coverage provided by any applicable limited warranty pertaining to Your Pella Products. For opt out information and additional details please read the Limited Warranty and Arbitration Agreement for your Pella Products at www.Pella.com/arbitration.

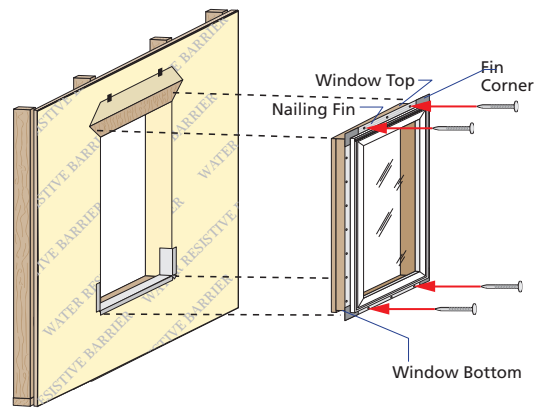
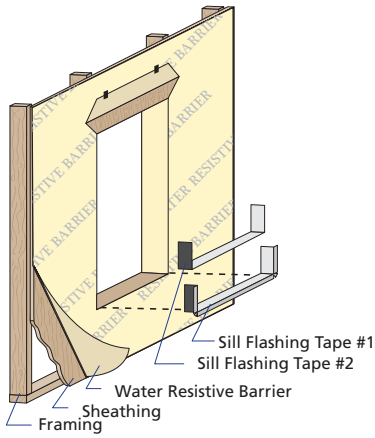

1 PREPARE THE OPENING

Refer to the nail fin installation preparation section at the beginning of this booklet.

A. Cut the building wrap.

Refer to the diagram for other window shapes on the next page.

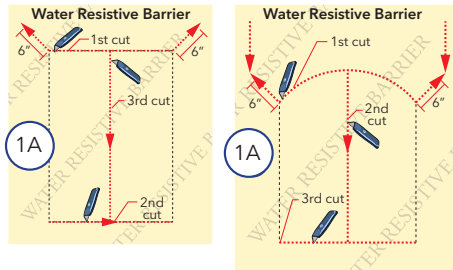

B. Fold the building wrap in at the jambs and staple it in place. Fold the top flap up and temporarily fasten with flashing tape.

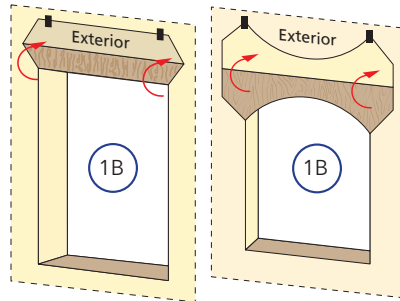

C. Cut 2 pieces of flashing tape 12" longer than opening width.

D. Apply sill flashing tape #1 at the sill extending 1" to the exterior and 6" up each jamb.

E. Cut 1" wide tabs at each corner by tearing the foil 1/2" each way from corner.

F. Apply sill flashing tape #2 overlapping tape #1 by 1" minimum.

NOTE: Press all tape down firmly.

G. Install and level sill shims. Place 1" wide x 1/4" to 3/8" thick shims 1/2" from each side. Keep shims back 1/2" from interior face of window. Place additional shims under each mullion and sliding window interlocker.

For vinyl windows, add shims so maximum spacing is 18".

H. Attach shims to prevent movement after they are level.

NOTE: Improper placement of shims may result in bowing the bottom of the window.

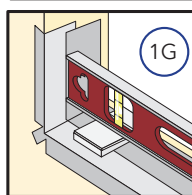
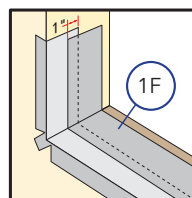
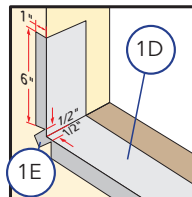

2 SETTING AND FASTENING THE WINDOW

A. Insert the window into the opening on the sill spacers. Center the window between jambs.

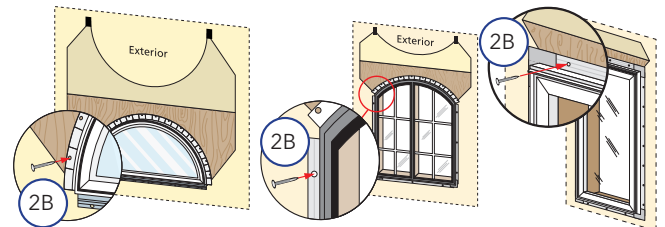

B. Drive two fasteners, one near each end of the top nailing fin. (See nail fin anchor instructions at the end of this booklet)

C. Plumb and square the window using shims at the locations shown. Adjust shims to plumb and square the window. Keep shims 1/2" short of window frame depth.

NOTE: DO NOT shim above the window. Additional shims are required at screw locations for large units and combinations. See the nail fin anchor instructions at the end of this booklet.

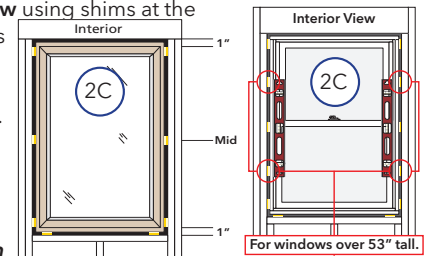

D. Check the window placement by measuring from the interior surface of the window frame or jamb extension to the interior surface of the wall for consistency. If the dimensions are not equal, confirm the fins are folded fully to 90° (if applicable).

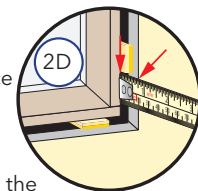

E. Drive two fasteners, one near each end of the sill nailing fin.

F. Check window operation.

Vent Awning and Casement: Refer to applicable hardware instructions. Unlock and open the window to remove the shipping spacers. Open and close the window to test for proper operation.

Double-Hung: Cut the checkrail bands (if applicable) and remove shipping spacers. Open, close and tilt the sashes to test for proper operation. Check for equal sash to frame reveal from top to bottom.

NOTE: Adjust shims to correct any issues with plumb, square, operation or reveal. If necessary, secure window frame to ensure window placement and sash to frame reveal is maintained.

G. Close and lock the window.

H. Finish driving fasteners into the nailing fin. Refer to the nail fin anchor instructions at the end of this booklet.



NEW CONSTRUCTION INSTALLATION WITH NAIL FIN AFTER BUILDING WRAP (CONTINUED)

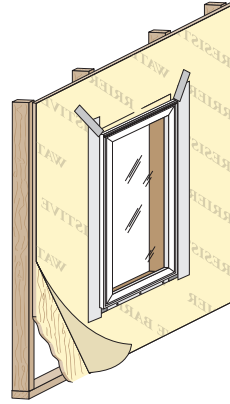
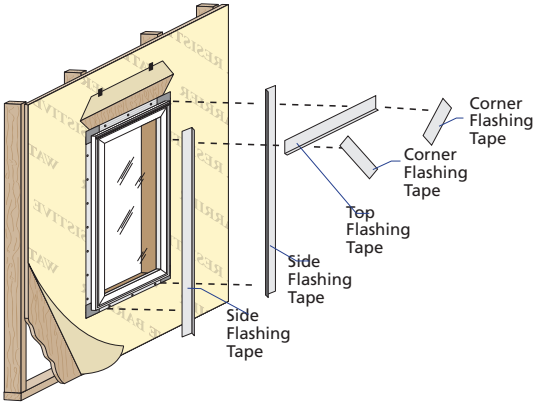

3 INTEGRATING WITH THE BUILDING WRAP

NOTE: For fold-up or slide-in fins, seal the fin to frame joint by either applying flashing tape 1/2" onto the frame, or sealing the joint with installation sealant after placing flashing tape.

Flashing Tape Option

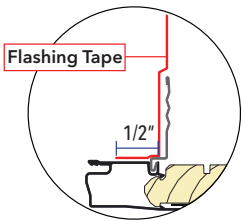

Sealant Option

(Ensure sealant compatibility with flashing materials)

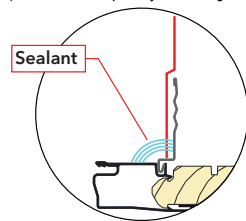

Curved and angle top units without pre-applied fin corners:

A. Cut four 1-1/2" long pieces of flashing tape.

Apply one to each end of sill fin to extend it 1-1/2" past each jamb.

Apply one to the bottom end of each jamb fin beginning 1-1/2" from the end of the fin and lapping over the first piece of flashing tape.

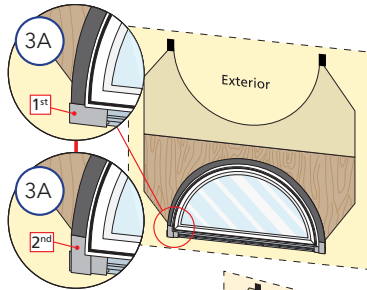

B. Apply straight side flashing tape. Cut two pieces of flashing tape 4" taller than straight sides. Apply tape over the fin and onto weather resistive barrier. Extend tape 2" above and below straight sides.

Angle top Units: On the short side, do not allow the side tape to extend higher than what the top tape will cover.

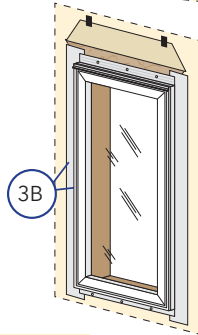

Building Wrap Cutting Patterns for Window Shapes:

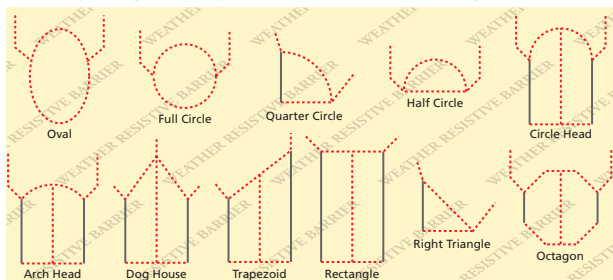

C. Apply top flashing tape.

Rectangular Units: Cut one piece of flashing tape to extend 1" past both side flashing tapes.

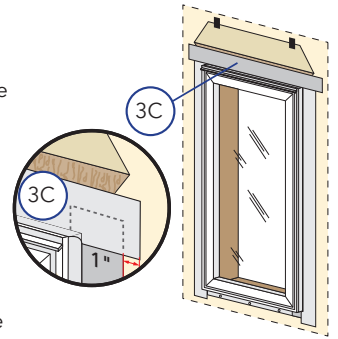

Curved Top Units: Using several short pieces, start taping from the sides of the window working towards the peak. Cut each piece short enough so each piece overlaps the previous piece. Tighter curved frames will require shorter pieces of tape.

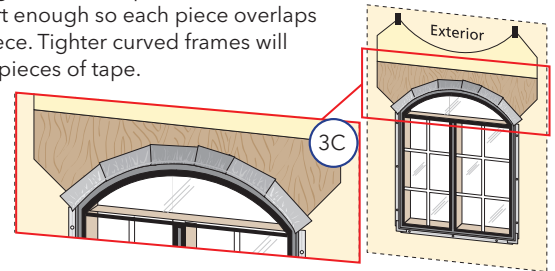

NOTE: DO NOT tape over bottom nailing fin.

D. Fold down top flap of weather resistive barrier.

E. Apply flashing tape to top diagonal cuts. Cut pieces of flashing tape at least 1" longer than each diagonal cut. Lap tape 1" past end of cut onto weather barrier. Overlap multiple pieces of tape by 1" when necessary.

NOTE: PRESS ALL FLASHING TAPE DOWN FIRMLY.

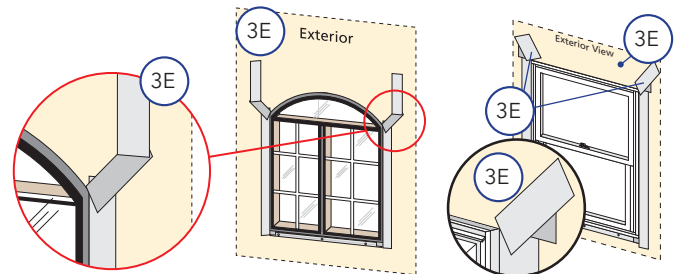

F. Install interior sealant. Refer to the interior sealant instructions at the end of this booklet.

G. Install head flashing, properly incorporating it with the siding and building wrap according to applicable code requirements.

H. Install exterior sealant. (After wall cladding is installed) Refer to the exterior sealant instructions at the end of this booklet.

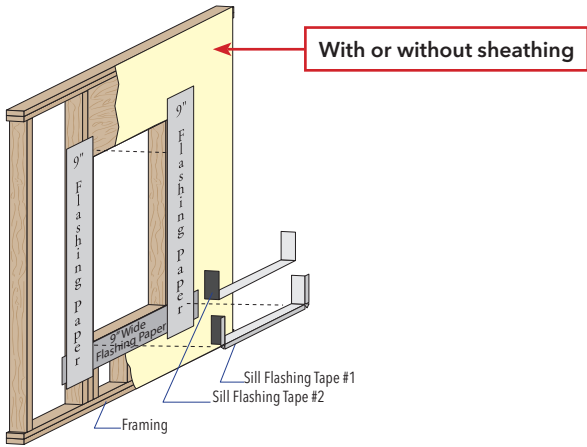

1 PREPARE THE OPENING

Refer to the nail fin installation preparation section at the beginning of this booklet.

- A. **Apply flashing paper at the bottom.** Cut one piece of 9" minimum width flashing paper 18" longer than the width of the opening. Staple it flush with the top of the sill plate.
- B. **Apply flashing paper to the sides.** Cut 2 pieces of 9" minimum width flashing paper 18" longer than the longest straight side of the opening. Center the flashing paper with the opening height and staple one piece flush with the inside edge on both sides.

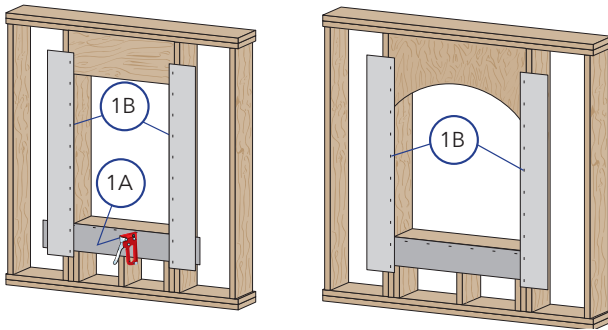

- C. **Cut 2 pieces of flashing tape 12" longer than opening width.**
- D. **Apply sill flashing tape #1** at the sill extending 1" to the exterior and 6" up each jamb.
- E. **Cut 1" wide tabs at each corner** by tearing the foil 1/2" each way from corner.
- F. **Apply sill flashing tape #2** overlapping tape #1 by 1" minimum.

NOTE: Press all tape down firmly.

- G. **Install and level sill shims.** Place 1" wide x 1/4" to 3/8" thick shims 1/2" from each side. Place additional shims under each mullion and sliding window interlocker. For vinyl windows, add shims so maximum spacing is 18".

- H. **Attach shims to prevent movement** after they are level.

NOTE: Improper placement of shims may result in bowing the bottom of the window.

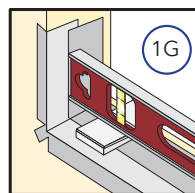
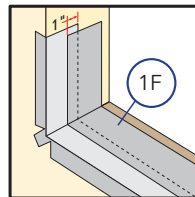
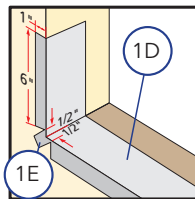

2 SETTING AND FASTENING THE WINDOW

- A. **Insert the window into the opening** on the sill spacers. Center the window between jambs.
- B. **Drive two fasteners**, one near each end of the top nailing fin. (See nail fin anchor instructions at the end of this booklet).

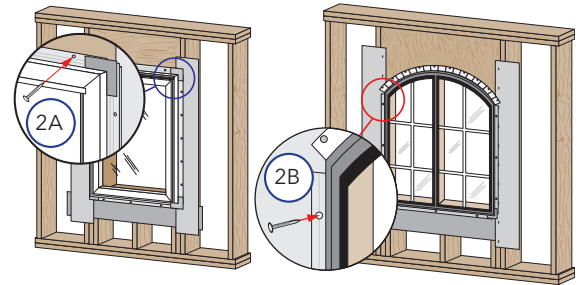

- C. **Plumb and square the window** using shims at the locations shown. Adjust shims to plumb and square the window. Keep shims 1/2" short of window frame depth.

NOTE: DO NOT shim above the window. Additional shims are required at screw locations for large units and combinations. See the nail fin anchor instructions at the end of this booklet.

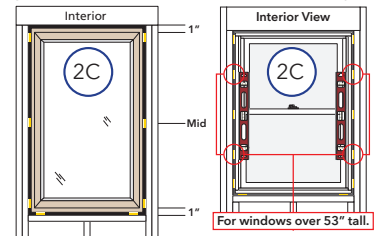

- D. **Check the window placement** by measuring from the interior surface of the window frame or jamb extension to the interior surface of the wall for consistency. If the dimensions are not equal, confirm the fins are folded fully to 90° (if applicable).

- E. **Drive two fasteners**, one near each end of the sill nailing fin.
- F. **Check window operation.**

Vent Awning and Casement: Refer to applicable hardware instructions. Unlock and open the window to remove the shipping spacers. Open and close the window to test for proper operation.

Double-Hung: Cut the checkrail bands (if applicable) and remove shipping spacers. Open, close and tilt the sashes to test for proper operation. Check for equal sash to frame reveal from top to bottom.

NOTE: Adjust shims to correct any issues with plumb, square, operation or reveal. If necessary, secure window frame to ensure window placement and sash to frame reveal is maintained.

- G. **Close and lock the window.**

- H. **Finish driving fasteners into the nailing fin.** Refer to the nail fin anchor instructions at the end of this booklet.

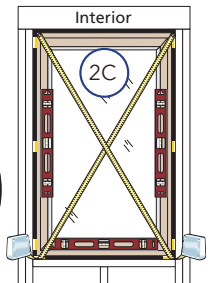
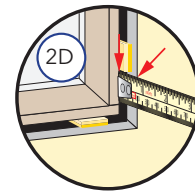



NEW CONSTRUCTION INSTALLATION WITH NAIL FIN BEFORE BUILDING WRAP (CONTINUED)

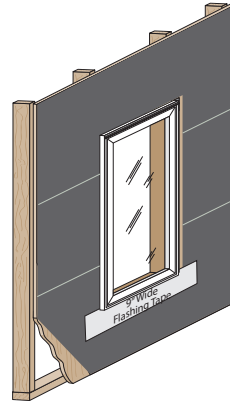
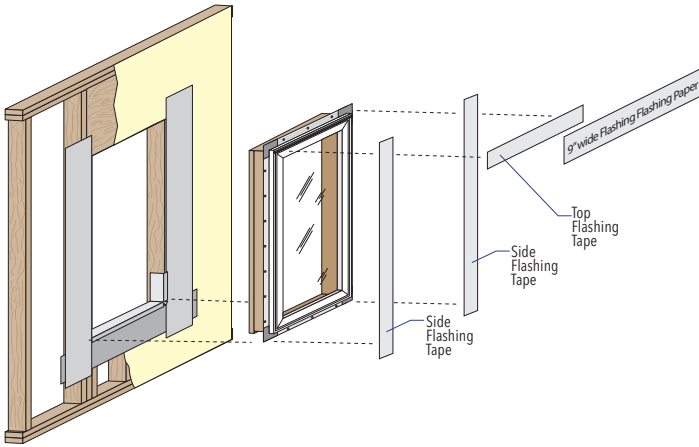

3 INTEGRATING WITH THE FLASHING PAPER

NOTE: For fold-up or slide-in fins, seal the fin to frame joint by either applying flashing tape 1/2" onto the frame, or sealing the joint with installation sealant after placing flashing tape.

Flashing Tape Option

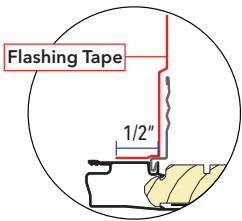

Sealant Option

(Ensure sealant compatibility with flashing materials)

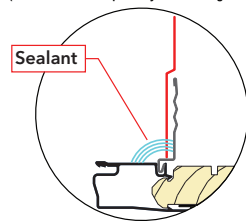

Curved and angle top units without pre-applied fin corners:

A. Cut four 1-1/2" long pieces of flashing tape.

Apply one to each end of sill fin to extend it 1-1/2" past each jamb.

Apply one to the bottom end of each jamb fin beginning 1-1/2" from the end of the fin and lapping over the first piece of flashing tape.

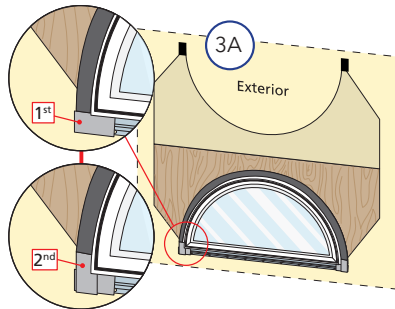

B. Apply straight side flashing tape. Cut two pieces of flashing tape 4" taller than straight sides. Apply tape over the fin and onto the flashing paper. Extend tape 2" above and below straight sides.

Angle top Units: On the short side, do not allow the side tape to extend higher than what the top tape will cover.

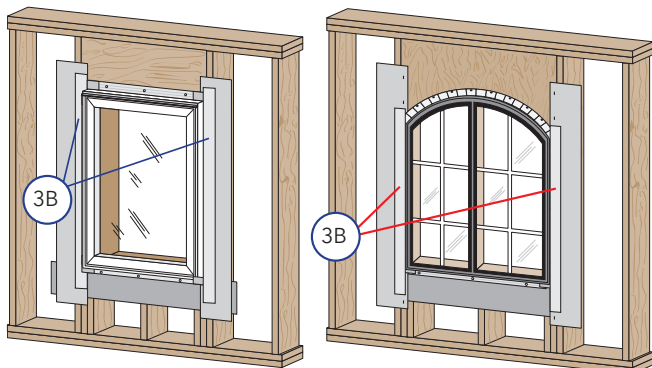

C. Apply top flashing tape.

Rectangular Units: Cut one piece of flashing tape to extend 1" past both side flashing tapes.

Curved Top Units: Using several short pieces, start taping from the sides of the window working towards the peak. Cut each piece short enough so each piece overlaps the previous piece. Tighter curved frames will require shorter pieces of tape.

NOTE: Press all flashing tape down firmly.

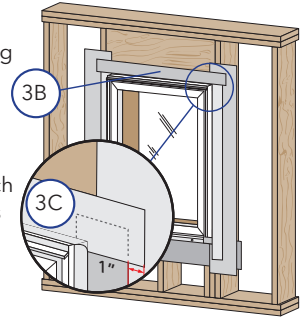

NOTE: DO NOT tape over bottom nailing fin.

D. Apply top flashing paper.

Rectangular windows: Cut one piece of 9" minimum width flashing paper 21" longer than the window width. Center it above the window and flush with the top. Staple it to the header.

Shaped windows: Cut one piece of flashing paper long enough to overlap the side flashing paper by 2" on each side. Cut the bottom of the paper to match the shape of the window (curved only). Center it above the window and flush with the top. Staple to the header. Ensure the top of the side flashing paper is completely covered by the top flashing paper on each side. Apply multiple pieces of top flashing paper if necessary, overlapping them 6" in watershed fashion.

NOTE: When apply building paper to the wall, ensure the sill flashing paper overlaps the building paper to create a watershed effect.

E. Install interior sealant. Refer to the interior sealant instructions at the end of this booklet.
F. Install head flashing, properly incorporating it with the siding and building wrap according to applicable code requirements.

G. Install exterior sealant. (After wall cladding is installed) Refer to the exterior sealant instructions at the end of this booklet.

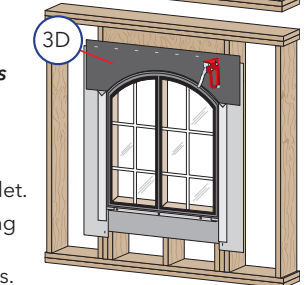
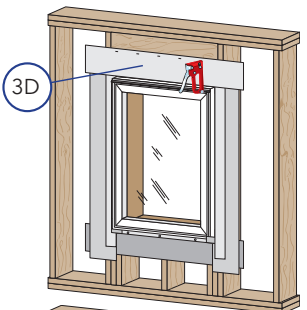
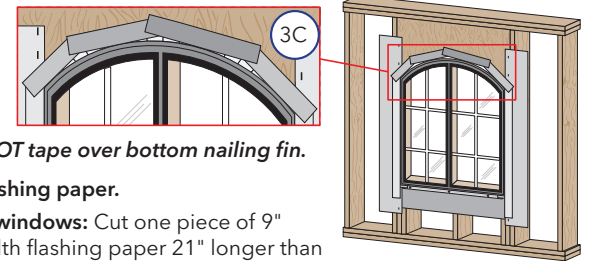

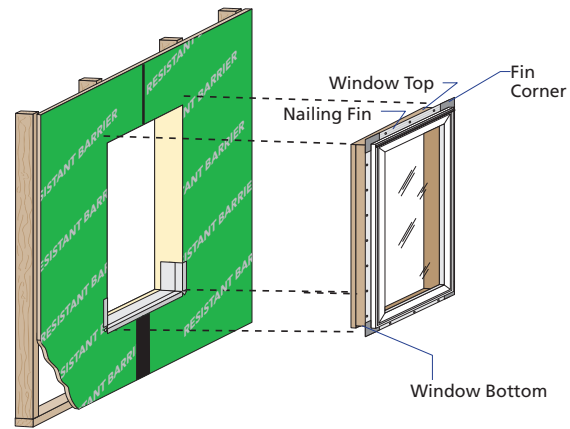
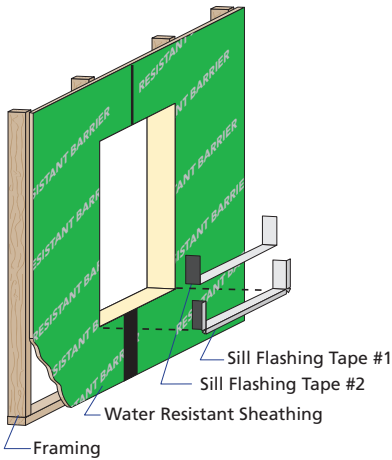

1 PREPARE THE OPENING

Refer to the nail fin installation preparation section at the beginning of this booklet.

- A. **Inspect the joints of the water resistant sheathing.** Joints must be sealed according to the sheathing manufacturer's instructions. Pella Corporation assumes no responsibility for the design, quality or durability of the sheathing system or its joints. Taped joints intersecting with the bottom or sides of the opening must have tape installed before beginning installation.
- B. **Cut 2 pieces of flashing tape 12" longer than opening width.**
- C. **Apply sill flashing tape #1** at the sill extending 2" to the exterior and 6" up each jamb.
- D. **Cut 1" wide tabs** at each corner by tearing the foil 1/2" each way from corner.
- E. **Apply sill flashing tape #2** overlapping tape #1 by 1" minimum.
- F. **Cut 2 pieces of flashing tape.** Make one equal to the height of each side of the opening.
- G. **Apply one piece on each jamb extending 1" onto the surface of the sheathing, over the edge of the sheathing and into the opening.**
- H. **Apply a second piece on each jamb overlapping the first piece by 1".**
IMPORTANT: Use a roller to firmly press all flashing tape down until the texture of the sheathing can be seen through the tape.
- I. **Install and level sill shims.** Place 1" wide x 1/4" to 3/8" thick shims 1/2" from each side. Keep shims back 1/2" from interior face of window. Place additional shims under each mullion and sliding window interlocker.
For vinyl windows, add shims so maximum spacing is 18".
- J. **Attach shims to prevent movement after they are level.**
NOTE: Improper placement of shims may result in bowing the bottom of the window.

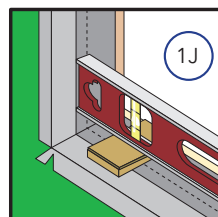
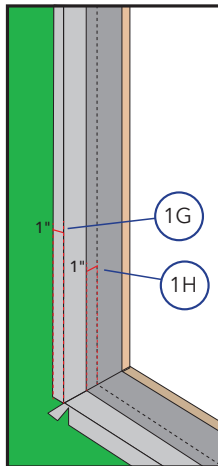
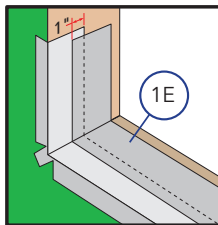
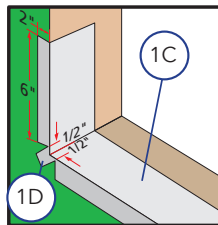

2 SETTING AND FASTENING THE WINDOW

- A. **Insert the window into the opening** on the sill spacers. Center the window between jambs.

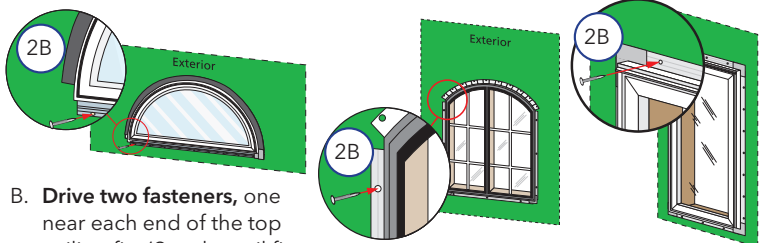

- B. **Drive two fasteners, one near each end of the top nailing fin.** (See the nail fin anchor instructions at the end of this booklet.)

- C. **Plumb and square the window** using shims at the locations shown. Adjust shims to plumb and square the window. Keep shims 1/2" short of window frame depth.
NOTE: DO NOT shim above the window. Additional shims are required at screw locations for large units and combinations. See the anchor schedule at the end of this booklet.

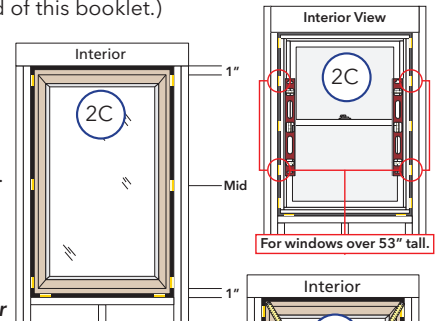

- D. **Check the window placement** by measuring from the interior surface of the window frame or jamb extension to the interior surface of the wall for consistency. If the dimensions are not equal, confirm the fins are folded fully to 90° (if applicable).

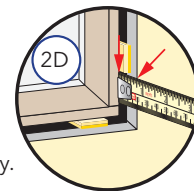

- E. **Drive two fasteners** one near each end of the sill nailing fin.
- F. **Check window operation.**
Vent Awning and Casement: Refer to applicable hardware instructions. Unlock and open the window to remove the shipping spacers. Open and close the window to test for proper operation.
Double-Hung: Cut the checkrail bands (if applicable) and remove shipping spacers. Open, close and tilt the sashes to test for proper operation. Check for equal sash to frame reveal from top to bottom.
NOTE: Adjust shims to correct any issues with plumb, square, operation or reveal. If necessary, secure window frame to ensure window placement and sash to frame reveal is maintained.

- G. **Close and lock the window.**
- H. **Finish driving fasteners into the nailing fin.** Refer to the nail fin anchor instructions at the end of this booklet.



NEW CONSTRUCTION INSTALLATION WITH NAIL FIN OVER WATER RESISTANT SHEATHING (CONTINUED)

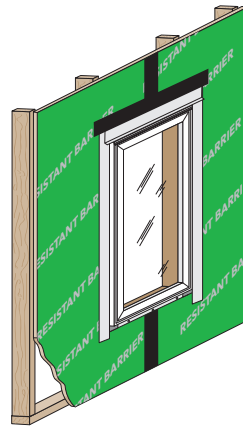
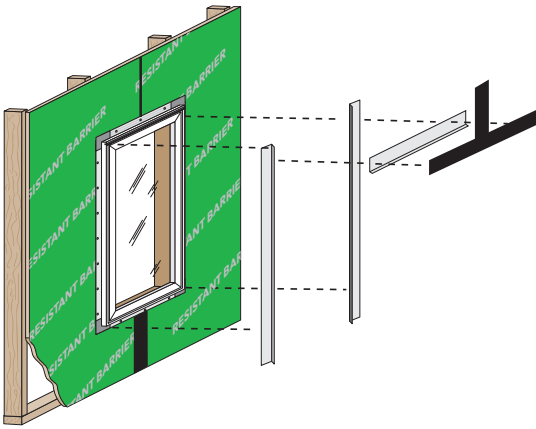

3 SEALING TO THE SHEATHING

NOTE: For fold-up or slide-in fins, seal the fin to frame joint by either applying flashing tape 1/2" onto the frame, or sealing the joint with installation sealant after placing flashing tape.

Flashing Tape Option

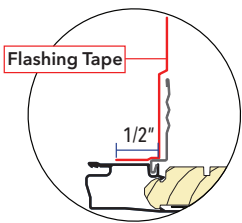

Sealant Option

(Ensure sealant compatibility with flashing materials)

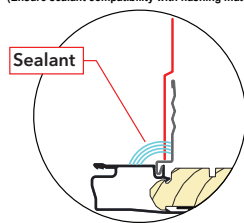

Curved and angle top units without pre-applied fin corners:

A. Cut four 1-1/2" long pieces of flashing tape.

Apply one to each end of sill fin to extend it 1-1/2" past each jamb.

Apply one to the bottom end of each jamb fin beginning 1-1/2" from the end of the fin and lapping over the first piece of flashing tape.

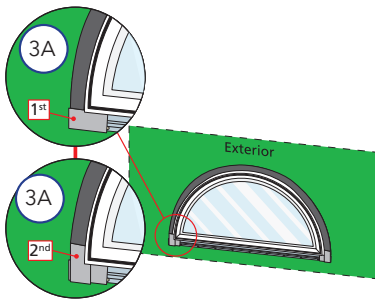

B. Apply straight side flashing tape. Cut two pieces of flashing tape 4" taller than straight sides. Apply tape over the fin and onto weather resistive barrier. Extend tape 2" above and below straight sides.

Angle top Units: On the short side, do not allow the side tape to extend higher than what the top tape will cover.

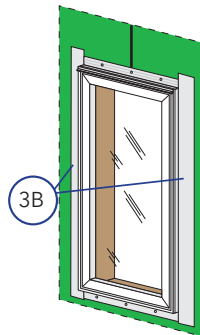

C. Apply top flashing tape.

Rectangular Units: Cut one piece of flashing tape to extend 1" past both side flashing tapes.

Curved Top Units: Using several short pieces, start taping from the sides of the window working towards the peak. Cut each piece short enough so each piece overlaps the previous piece. Tighter curved frames will require shorter pieces of tape.

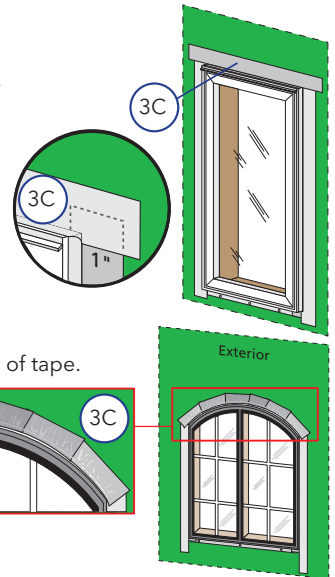

NOTE: DO NOT tape over bottom nailing fin.

D. Apply a second layer of sheathing manufacturer's joint sealant tape. Cut one piece so it will extend 1" past the first layer of flashing tape on each side. Overlap the first layer of tape by 1" to create a water shed effect.

E. Apply sheathing manufacturer's joint sealant tape to any joints intersecting with the top of the opening, overlapping the head sealant tape in accordance with the manufacturer's instructions.

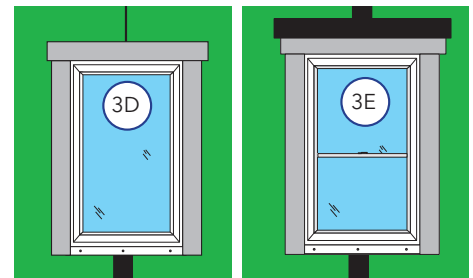

IMPORTANT: Use a roller to firmly press all flashing tape down until the texture of the sheathing can be seen through the tape.

F. Install interior sealant. Refer to the interior sealant instructions at the end of this booklet.

G. Install head flashing, properly incorporating it with the siding and sheathing according to applicable code requirements.

H. Install exterior sealant. (After wall cladding is installed) Refer to the exterior sealant instructions at the end of this booklet.



NEW CONSTRUCTION INSTALLATION WITH NAIL FIN OVER 1-1/2"-2" THICK CONTINUOUS EXTERIOR INSULATION USING ROUGH OPENING SUPPORT BRACKETS (PATENT PENDING)

Contact Pella Corporation or your local Pella retailer for additional information regarding this installation accessory.

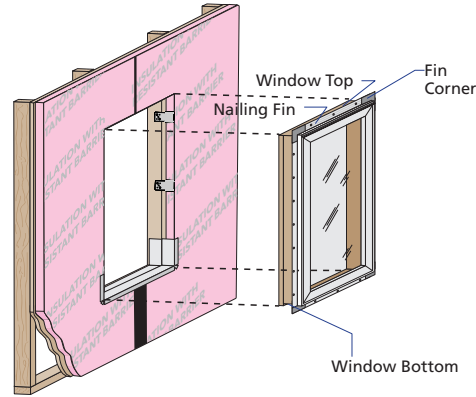
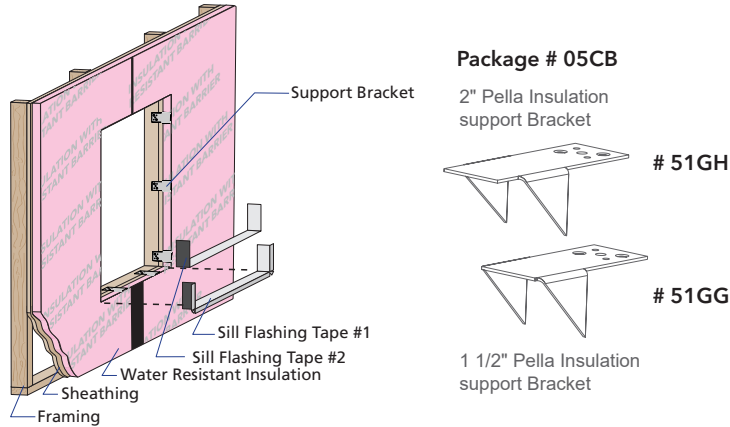

1 PREPARE THE OPENING

Refer to the nail fin installation preparation section at the beginning of this booklet.

- A. **Inspect the joints of the water resistant exterior insulation.** The insulation must be fastened and sealed according to the insulation manufacturer's instructions. Pella Corporation assumes no responsibility for the design, quality or durability of the exterior insulation system or its joints. Taped joints intersecting with the bottom or sides of the opening must have tape installed before beginning window installation.
- B. **Insert the Rough Opening Support Brackets** by pressing the support bracket into the edge of the insulation panel. Insure that the bracket is tight against the wall system's sheathing or rough opening framing.

Support brackets are required at each shim location:

 - Sill: 1/2" from each bottom corner.
 - Jambs: Refer to Step 2C.

Place additional support brackets at each mullion or interlocker.

Refer to the anchor schedule at the end of the booklet for all additional shim and support bracket locations.

For vinyl insulation, add support brackets so maximum spacing is 18" along the sill.

NOTE: No support brackets are required above the window.
- C. **Fasten the support bracket to the rough opening framing.**
 - For wood framing, use either two roofing nails or two #6 or #8 screws with minimum 1-1/2" embedment. Stagger the fasteners.
 - For light gauge steel framing, use one #10 or two #8 self-drilling / tapping screws.
 - For concrete or masonry, use one 3/16" masonry screw with 1-1/4" minimum embedment.
- D. **Cut 6" pieces of flashing tape and apply tape over each support bracket,** covering each bracket completely.
- E. **Cut 2 pieces of flashing tape 12" longer than the opening width.**
- F. **Apply sill flashing tape #1** at the sill extending 2" to the exterior and 6" up each jamb.
- G. **Cut 1" wide tabs** at each corner by tearing the foil 1/2" each way from corner.
- H. **Apply sill flashing tape #2** overlapping tape #1 by 1" minimum.
- I. **Cut 4 pieces of flashing tape** equal to the height of the opening.
- J. **Apply one piece on each jamb** extending 1" onto the surface of the insulating panel, over the edge of the panel and into the opening.
- K. **Apply a second piece on each jamb** overlapping the first piece by 1". Press tape down firmly.
- L. **Install and level sill shims.** Place 1" wide x 1/4" to 3/8" thick shims onto each rough opening support bracket on the sill. Keep shims back 1/2" from interior face of the window.
- M. **Use flashing tape to attach shims** to prevent movement after they are level.

NOTE: Improper placement of shims may result in bowing the bottom of the window.

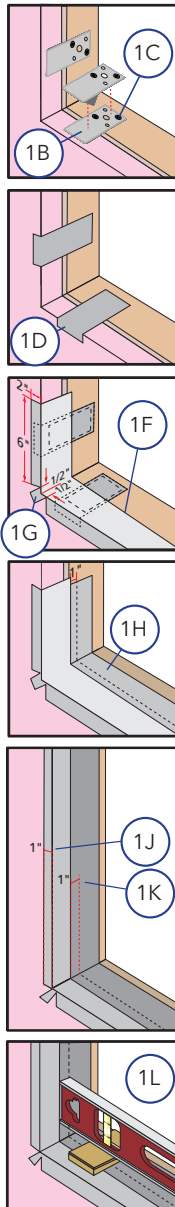

2 SETTING AND FASTENING THE WINDOW

- A. **Insert the window into the opening** on the sill spacers. Center the window between jambs.
- B. **Drive two fasteners,** one near each end of the top nailing fin. (Longer fasteners required, see the nail fin anchor instructions at the end of this booklet.)
- C. **Plumb and square the window** using shims at the locations shown. Adjust shims to plumb and square the window. Keep shims 1/2" short of window frame depth.

NOTE: DO NOT shim above the window. Additional shims are required at screw locations for large units and combinations. See the anchor schedule at the end of this booklet.
- D. **Check the window placement** by measuring from the interior surface of the window frame or jamb extension to the interior surface of the wall for consistency. If the dimensions are not equal, confirm the fins are folded fully to 90° (if applicable).
- E. **Drive two fasteners** one near each end of the sill nailing fin.
- F. **Check window operation.**

Vent Awning and Casement: Refer to applicable hardware instructions. Unlock and open the window to remove the shipping spacers. Open and close the window to test for proper operation.

Double-Hung: Cut the checkrail bands (if applicable) and remove shipping spacers. Open, close and tilt the sashes to test for proper operation. Check for equal sash to frame reveal from top to bottom.

NOTE: Adjust shims to correct any issues with plumb, square, operation or reveal. If necessary, secure window frame to ensure window placement and sash to frame reveal is maintained.
- G. **Close and lock the window.**
- H. **Finish driving fasteners into the nailing fin.** Do not over-drive fasteners. Refer to the nail fin anchor instructions at the end of this booklet.

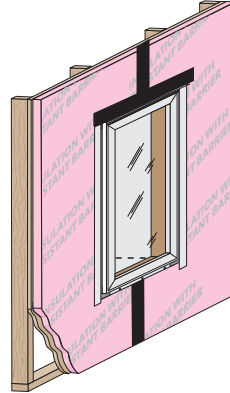
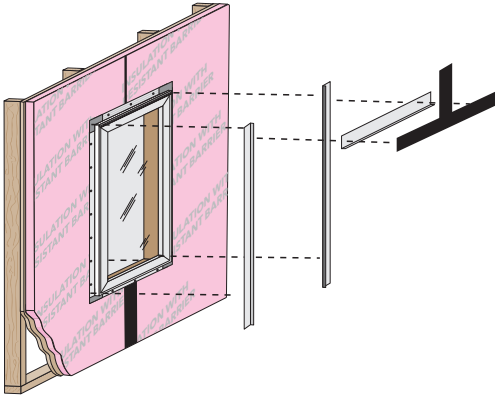

3 SEALING TO THE INSULATION

NOTE: For fold-up or slide-in fins, seal the fin to frame joint by either applying flashing tape 1/2" onto the frame, or sealing the joint with installation sealant after placing flashing tape.

Flashing Tape Option

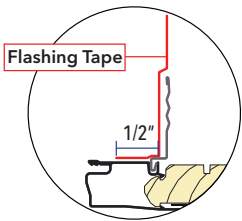

Sealant Option

(Ensure sealant compatibility with flashing materials)

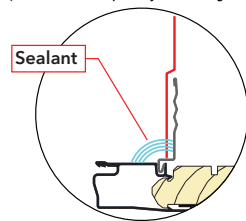

Curved and angle top units without pre-applied fin corners:

A. Cut four 1-1/2" long pieces of flashing tape.

Apply one to each end of sill fin to extend it 1-1/2" past each jamb.

Apply one to the bottom end of each jamb fin beginning 1-1/2" from the end of the fin and lapping over the first piece of flashing tape.

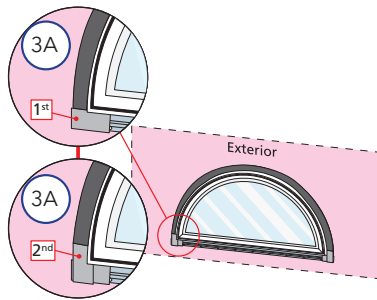

B. Apply straight side flashing tape. Cut two pieces of flashing tape 4" taller than straight sides. Apply tape over the fin and onto weather resistive barrier. Extend tape 2" above and below straight sides.
Angle top Units: On the short side, do not allow the side tape to extend higher than what the top tape will cover.

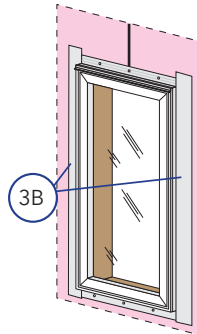

C. Apply top flashing tape.

Rectangular Units: Cut one piece of flashing tape to extend 1" past both side flashing tapes.

Curved Top Units: Using several short pieces, start taping from the sides of the window working towards the peak. Cut each piece short enough so each piece overlaps the previous piece. Tighter curved frames will require shorter pieces of tape.

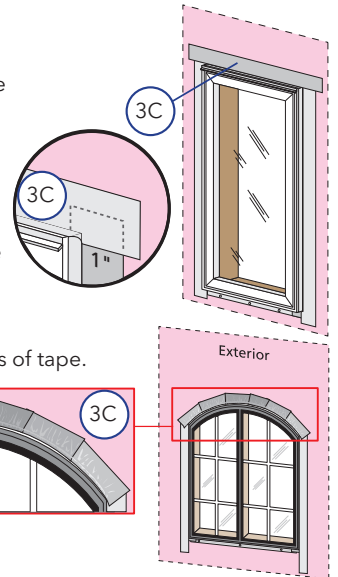

NOTE: DO NOT tape over bottom nailing fin.

D. Apply a second layer of insulation manufacturer's joint sealant tape. Cut one piece so it will extend 1" past the first layer of flashing tape on each side. Overlap the first layer of tape by 1" to create a water shed effect.

E. Apply insulation manufacturer's joint sealant tape to any joints intersecting with the top of the opening, overlapping the head sealant tape in accordance with the manufacturer's instructions.

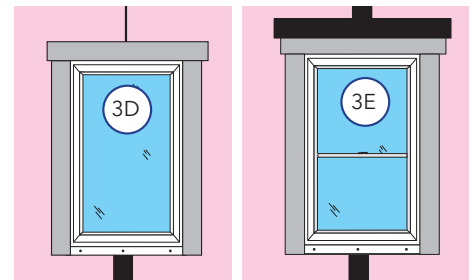

IMPORTANT: Use a roller to firmly press all flashing tape.

F. Install interior sealant. Refer to the interior sealant instructions at the end of this booklet.

G. Install head flashing, properly incorporating it with the siding and sheathing according to applicable code requirements.

H. Install exterior sealant. (After wall cladding is installed) Refer to the exterior sealant instructions at the end of this booklet.



NEW CONSTRUCTION INSTALLATION INTO MASONRY CONSTRUCTION

FOR THE INSTALLATION OF NEW NAIL FIN WINDOWS INTO MASONRY OPENINGS WITH WOOD BUCKS

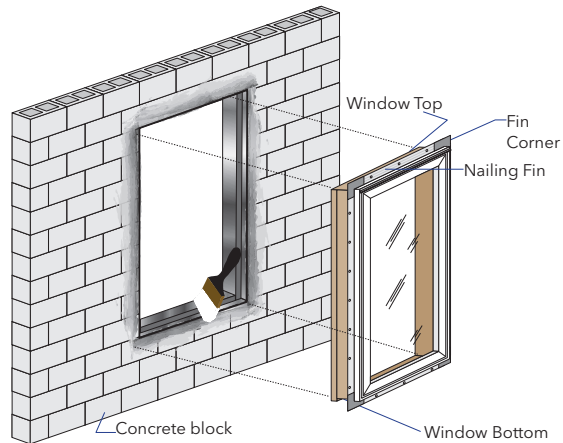
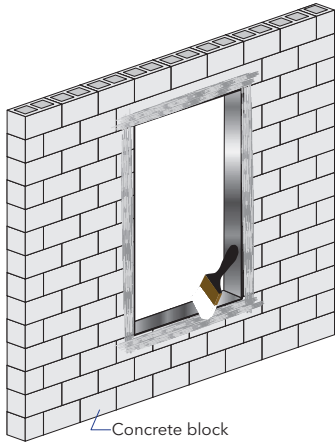

1 PREPARE THE OPENING

Refer to the nail fin installation preparation section at the beginning of this booklet.

- A. **Apply water resistant coating.** Extend the coating into the opening on all four sides and onto the wall surface at least 9". The water resistant coating may be a self-adhered sheet membrane (SASM) or a liquid applied flashing. Ensure continuity between the water resistant coating in the opening and the rest of the wall surface. SASM's must be overlapped in a water shed fashion. Apply all water resistant coatings according to the manufacturer's directions.

NOTE: Allow liquid flashing to dry according to the manufacturer's recommendations.

- B. **Apply 2 beads of sealant** to the masonry opening where the wood buck will be attached.

NOTE: Ensure the sealant is compatible with the water resistant coating.

- C. **Pre-drill and fasten the treated wood buck** to the masonry opening using code-approved fasteners and spacing.

- D. **Apply water resistant coating (optional)** over the wood buck and onto the masonry opening. If using liquid applied flashing, allow it to dry according to the manufacturer's recommendations before proceeding.

- E. **Install and level sill shims.** Place 1" wide x 1/4" to 3/8" thick shims 1/2" from each side. Keep shims back 1/2" from interior face of window. Place additional shims under each mullion and sliding window interlocker.

For vinyl windows, add shims so maximum spacing is 18".

- F. **Attach shims to prevent movement** after they are level.

NOTE: Improper placement of shims may result in bowing the bottom of the window.

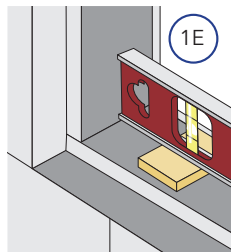
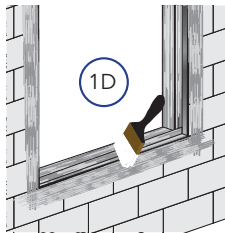
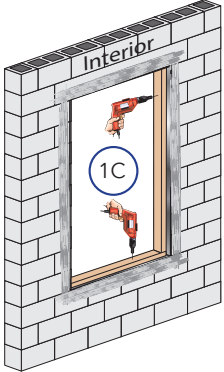
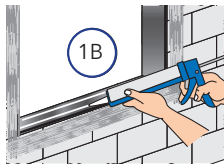
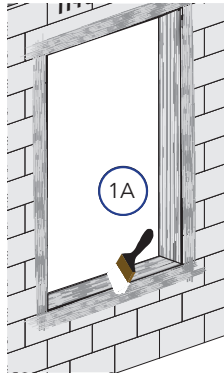

2 SETTING AND FASTENING THE WINDOW

- A. **Insert the window into the opening** on the sill spacers. Center the window between jambs.

- B. **Drive two fasteners**, one near each end of the top nailing fin. See the anchor schedule at the end of this booklet for fastener requirements.

- C. **Plumb and square the window** using shims at the locations shown. Adjust shims to plumb and square the window. Keep shims 1/2" short of window frame depth.

NOTE: DO NOT shim above the window. Additional shims are required at screw locations for large units and combinations. See the nail fin anchor instructions at the end of this booklet.

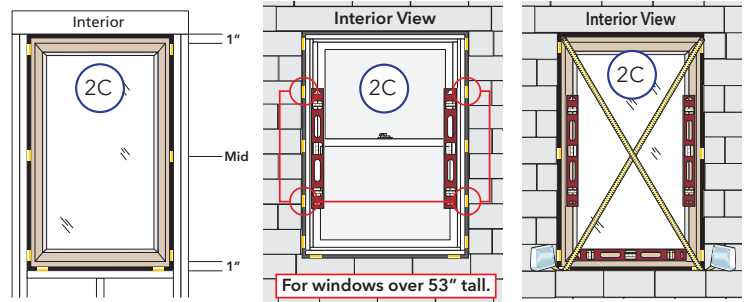

- D. **Check the window placement by measuring** from the interior surface of the window frame or jamb extension to the interior surface of the wall for consistency. If the dimensions are not equal, confirm the fins are folded fully to 90° (if applicable).

- E. **Drive two fasteners** one near each end of the sill nailing fin.

- F. **Check window operation.**

Vent Awning and Casement: Refer to applicable hardware instructions. Unlock and open the window to remove the shipping spacers. Open and close the window to test for proper operation.

Double-Hung: Cut the checkrail bands (if applicable) and remove shipping spacers. Open, close and tilt the sashes to test for proper operation. Check for equal sash to frame reveal from top to bottom.

NOTE: Adjust shims to correct any issues with plumb, square, operation or reveal. If necessary, secure window frame to ensure window placement and sash to frame reveal is maintained.

- G. **Close and lock the window.**

- H. **Finish driving fasteners into the nailing fin.** Refer to the nail fin anchor instructions at the end of this booklet.

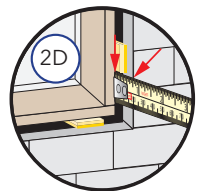
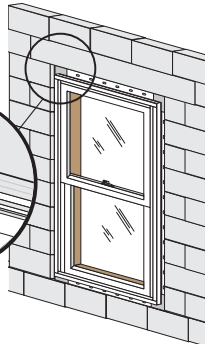



NEW CONSTRUCTION INSTALLATION INTO MASONRY CONSTRUCTION (CONTINUED)

FOR THE INSTALLATION OF NEW NAIL FIN WINDOWS INTO MASONRY OPENINGS WITH WOOD BUCKS

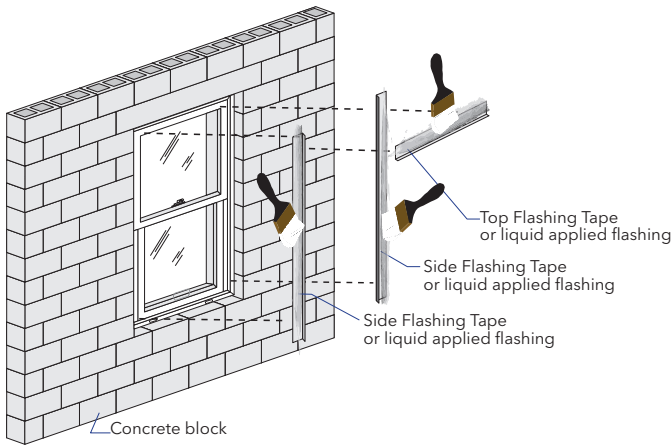

3 SEALING THE TOP AND SIDE NAILING FINS

NOTE: For fold-up or slide-in fins, seal the fin to frame joint by either applying flashing tape 1/2" onto the frame, or sealing the joint with installation sealant after placing flashing tape.

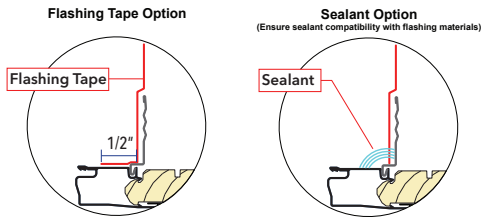

Curved and angle top units without pre-applied fin corners:

A. Cut four 1-1/2" long pieces of flashing tape.

Apply one to each end of sill fin to extend it 1-1/2" past each jamb.

B. Apply one to the bottom end of each jamb fin beginning 1-1/2" from the end of the fin and lapping over the first piece of flashing tape.

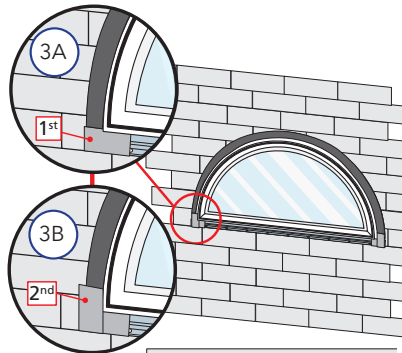

If liquid applied flashing was used to prepare the opening, apply it over the nail fin at jambs and head at this time according to the manufacturer's instructions. Leave the sill nailing fin uncovered. Skip to step 3E.

If the opening was prepared using SASM, follow steps C-D.

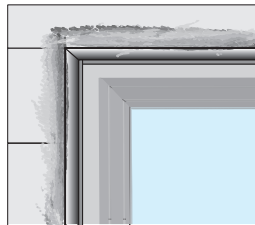

C. Apply straight side flashing tape. Cut two pieces of flashing tape 4" taller than straight sides. Apply tape over the fin and onto liquid applied flashing or SASM. Extend tape 2" above and below straight sides.

Angle top Units: On the short side, do not allow the side tape to extend higher than what the top tape will cover.

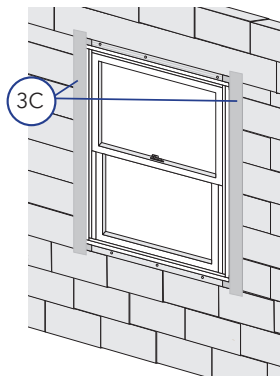

D. Apply top flashing tape.

Rectangular Units: Cut one piece of flashing tape to extend 1" past both side flashing tapes.

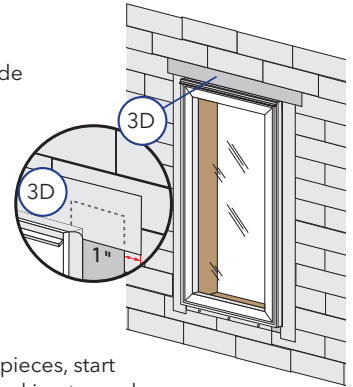

Curved Top Units: Using several short pieces, start taping from the sides of the window working towards the peak. Cut each piece short enough so each piece overlaps the previous piece. Tighter curved frames will require shorter pieces of tape.

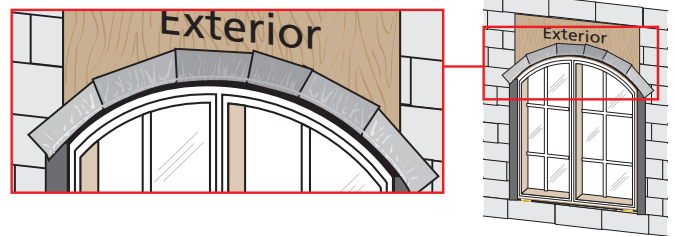

NOTE: Insert shims under the sill nailing fin to ensure the nail fin does not seal to the liquid applied flashing.

NOTE: DO NOT tape over bottom nailing fin.

NOTE: Press all flashing tape down firmly.

Apply SASM or liquid applied water management system in watershed fashion with head flashing and in accordance with manufacturer's recommendations.

E. Install interior sealant. Refer to the interior sealant instructions at the end of this booklet.

F. Install head flashing, properly incorporating it with the siding and water management system according to applicable code requirements.

G. Install exterior sealant. (After wall cladding is installed) Refer to the exterior sealant instructions at the end of this booklet.

NOTE: Frame curved portions of rough opening to support window and wind loads (if applicable).



FULL FRAME REPLACEMENT WITH NAIL FIN

INSTALLATION OF NEW NAIL FIN WINDOWS AFTER THE REMOVAL OF EXISTING WINDOWS AND THE SURROUNDING TRIM OR SIDING

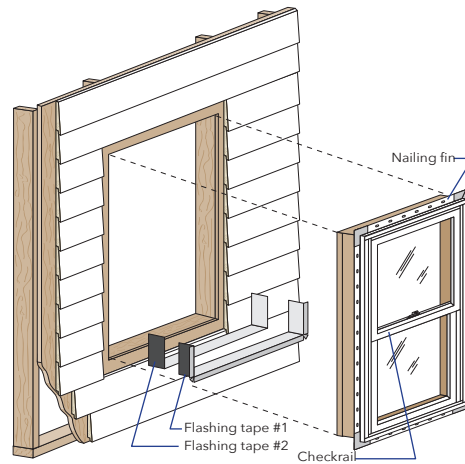
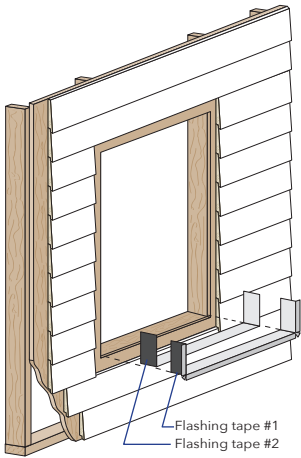

1 PREPARE THE OPENING

Refer to the existing frame removal instruction and nail fin installation preparation sections at the beginning of this booklet.

- A. Repair the wall surface around the opening (if necessary) by installing new blocking flush with the surface of the existing sheathing and/or repairing the existing building wrap with flashing tape.
 - B. Cut 2 pieces of flashing tape 12" longer than opening width.
 - C. Apply sill flashing tape #1 extending far enough onto the wall surface to overlap the building wrap 1" or onto the top edge of the siding and 6" up each jamb.
 - D. Cut 1" wide tabs at each corner by tearing the foil 1/2" each way from corner.
 - E. Apply sill flashing tape #2 overlapping tape #1 by 1" minimum.
- If existing building wrap is folded into the opening at the jambs, skip to step 1H.
- F. Cut 2 pieces of flashing tape. Make one equal to the height of each side of the opening.
 - G. Apply one piece on each jamb starting 1" from the exterior of the framing, over the edge of the sheathing and onto the surface of the sheathing.
- NOTE: Press all flashing tape down firmly.**

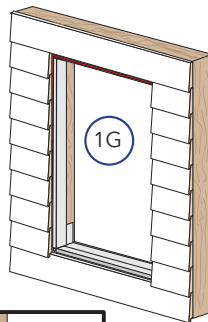
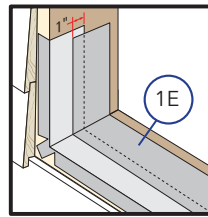
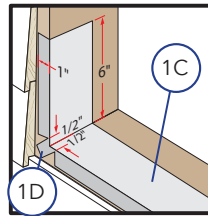

- H. Install and level sill shims. Place 1" wide x 1/4" to 3/8" thick shims 1/2" from each side. Keep shims back from interior face of window. Place additional shims under each mullion and sliding window interlocker.

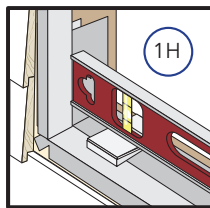

- I. Attach shims to prevent movement after they are level.

NOTE: Improper placement of shims may result in bowing the bottom of the window.

- J. Apply a continuous, 3/8" tall bead of sealant 1/2" from the edge of the opening at the sides and top only. Do NOT apply sealant at the sill. This step may be omitted if there will be at least 3" of wall surface between the edge of the window frame and the siding after installation.

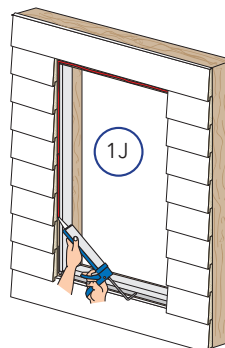

2 SETTING AND FASTENING THE WINDOW

- A. Insert the window into the opening on the sill spacers. Center the window between jambs.
- B. Drive two fasteners, one near each end of the top nailing fin. See the nail fin anchor instructions at the end of this booklet for fastener requirements.
- C. Plumb and square the window using shims at the locations shown. Adjust shims to plumb and square the window. Keep shims 1/2" short of window frame depth.

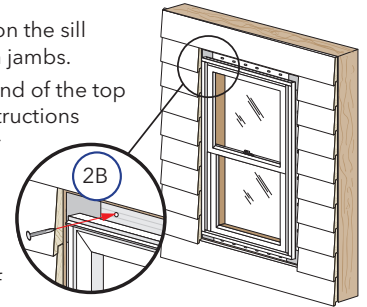

NOTE: DO NOT shim above the window. Additional shims are required at screw locations for large units and combinations. See the nail fin anchor instructions at the end of this booklet.

- D. Check the window placement by measuring from the interior surface of the window frame or jamb extension to the interior surface of the wall for consistency. If the dimensions are not equal, confirm the fins are folded fully to 90° (if applicable).

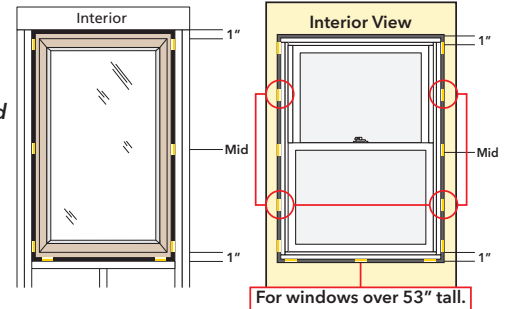

- E. Drive two fasteners one near each end of the sill nailing fin.

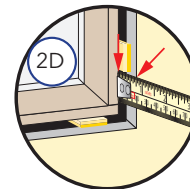

- F. Check window operation.

Vent Awning and Casement: Refer to applicable hardware instructions. Unlock and open the window to remove the shipping spacers. Open and close the window to test for proper operation.

Double-Hung: Cut the checkrail bands (if applicable) and remove shipping spacers. Open, close and tilt the sashes to test for proper operation. Check for equal sash to frame reveal from top to bottom.

NOTE: Adjust shims to correct any issues with plumb, square, operation or reveal. If necessary, secure window frame to ensure window placement and sash to frame reveal is maintained.

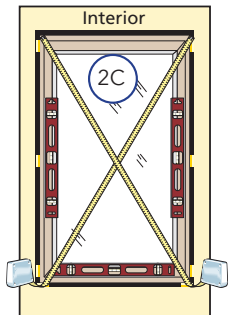

- G. Close and lock the window.

- H. Finish driving fasteners into the nailing fin. Refer to the nail fin anchor instructions at the end of this booklet.



FULL FRAME REPLACEMENT WITH NAIL FIN (CONTINUED)

INSTALLATION OF NEW NAIL FIN WINDOWS AFTER THE REMOVAL OF EXISTING WINDOWS AND THE SURROUNDING TRIM OR SIDING

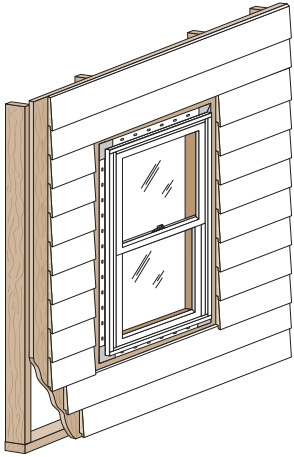

3 SEALING THE TOP AND SIDE NAILING FINS

NOTE: For fold-up or slide-in fins, seal the fin to frame joint by either applying flashing tape 1/2" onto the frame, or sealing the joint with installation sealant after placing flashing tape.

Flashing Tape Option

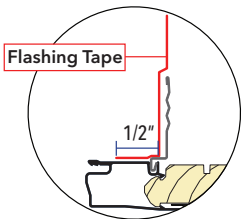

Sealant Option

(Ensure sealant compatibility with flashing materials)

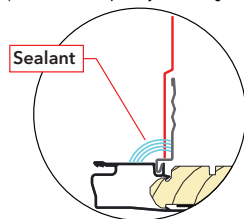

Curved and angle top units without pre-applied fin corners:

A. Cut four 1-1/2" long pieces of flashing tape.

Apply one to each end of sill fin to extend it 1-1/2" past each jamb.

Apply one to the bottom end of each jamb fin beginning 1-1/2" from the end of the fin and lapping over the first piece of flashing tape.

If there is less than 3" between the window frame and the siding, skip to step 3C.

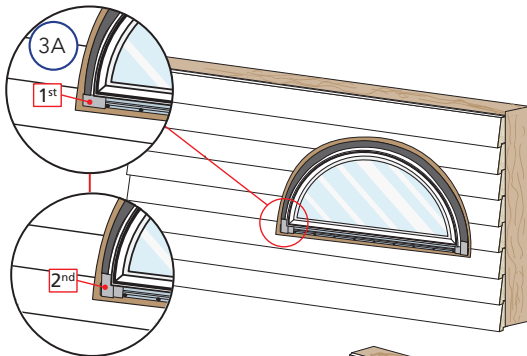

B. Apply straight side flashing tape. Cut two pieces of flashing tape 4" taller than straight sides. Apply tape over the fin and onto weather resistive barrier. Extend tape 2" above and below straight sides.

Angle top units: On the short side, do not allow the side tape to extend higher than what the top tape will cover.

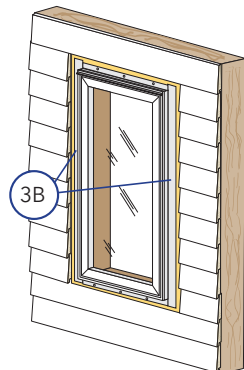

C. Apply top flashing tape.

Rectangular Units: Cut one piece of flashing tape to extend 1" past both side flashing tapes.

Curved Top Units: Using several short pieces, start taping from the sides of the window working towards the peak. Cut each piece short enough so each piece overlaps the previous piece. Tighter curved frames will require shorter pieces of tape.

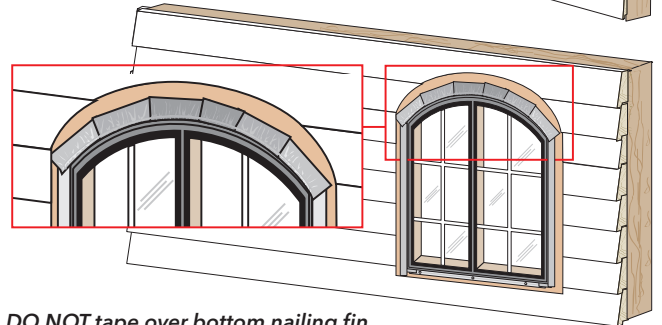
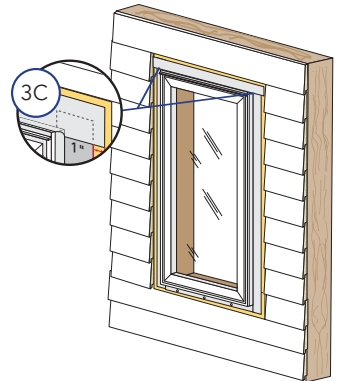

NOTE: DO NOT tape over bottom nailing fin.

NOTE: Press all flashing tape down firmly.

- D. **Install head flashing if none exists**, properly incorporating it with the siding and building wrap according to applicable code requirements.
- E. **Install blocking for frame expander** support or solid trim at this time, if applicable.
- F. **Install interior sealant.** Refer to the interior sealant instructions at the end of this booklet.
- G. **Install exterior sealant.** Refer to the exterior sealant instructions at the end of this booklet.
- H. **Install frame expander and receptor** (if applicable). See separate instructions.

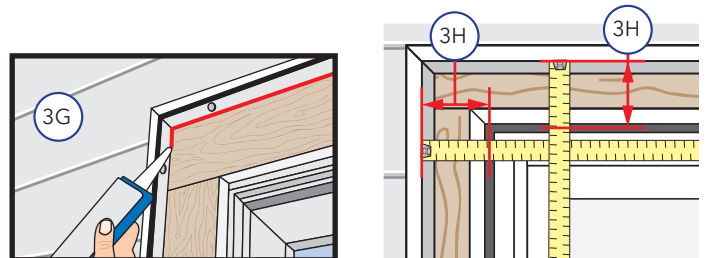



NAIL FIN WINDOW ANCHOR INSTRUCTIONS

Note: Standard performance only. Additional anchoring may be required for performance upgrade, impact-resistant products or to comply with local building code requirements.

PLACE FASTENERS AT THE LOCATIONS INDICATED:

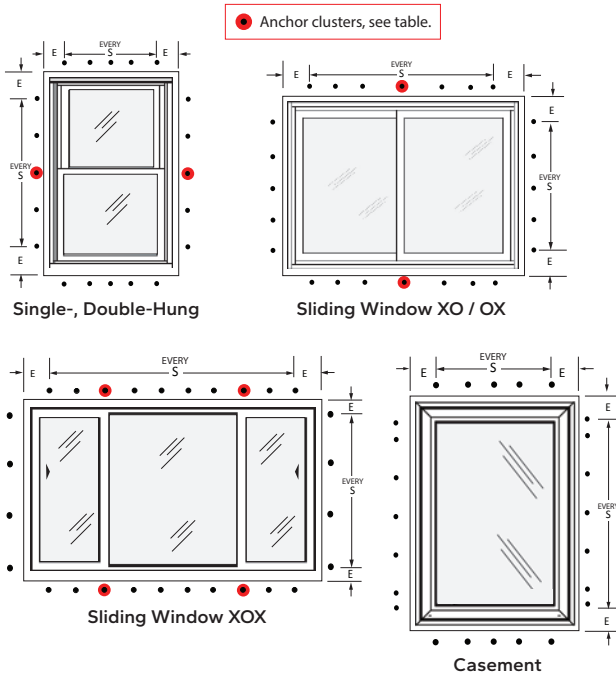

NAIL FIN ANCHOR CLUSTERS (IF APPLICABLE):

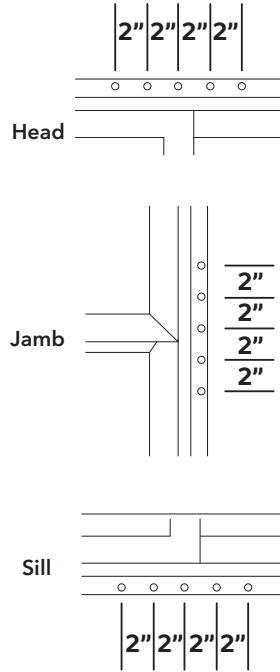

THROUGH FRAME ANCHOR CLUSTERS (PERFORMANCE UPGRADE DH ONLY):

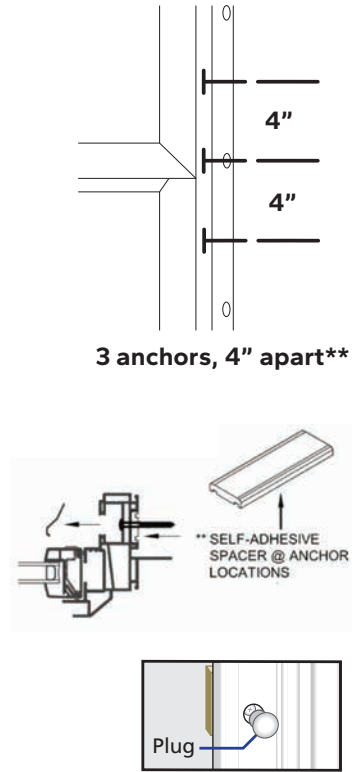

ENCOMPASS BY PELLA® / PELLA® 150 SERIES / PELLA® 250 SERIES WINDOWS

Product	PG Rating	Edge Spacing (E)	Max. Intermediate Spacing (S)	Anchor Type		Special Notes
				Wood *		
ENCOMPASS, 150 SERIES	All Windows and Composites	≤35	Every other Pre-Punched Hole	2" 11 Ga. Roofing Nail or #8 x 2" screw		(5) fin anchors, 2-3" apart at ends of integral mullion (if applicable).
	Performance Upgrade SH	50	Every Pre-Punched Hole	#8 x 2" Screw with Washer		(1) additional fin anchor, center at ends of checkrail. (5) fin anchors, 2-3" apart at ends of integral mullion (if applicable).
	Performance Upgrade DH					(3) #10 x 2" screws through frame at check rail ends, 4" apart at ends of integral mulls (if applicable). **
250 SERIES	All Windows and Composites	≤35	Every other Pre-Punched Hole	1.5" 11 Ga. Roofing Nail or #8 x 2" Screw		Only DH >71.5 tall: (5) fin anchors, 2-3" apart at ends of checkrail.
	Performance Upgrade SH/SW	50	Every Pre-Punched Hole	#8 x 2" Screw with Washer		(5) fin anchors, 2-3" apart at ends of checkrails or interlockers.
	Performance Upgrade DH					(3) #10 x 2" screws through frame at checkrail ends, 4" apart. (5) fin anchors, 2-3" apart at ends of integral mulls (if applicable). **
	CM/AW/FX					(5) fin anchors, 2-3 apart at ends of integral mulls (if applicable)
	Windows with Flat Casing	≤20	Every other Pre-Punched Hole	1.5" 11 Ga. Roofing Nail or #8 x 2" Screw		(5) fin anchors, 2-3" apart at ends of all checkrails, interlockers, or integral mullions.
	Combinations	≤35	Every other Pre-Punched Hole			(5) fin anchors, 2-3" apart at ends of 1/2" Structural Mulls OR (4) #10 x 2" screws through 1" Structural Mullion end anchors.***
Combinations	> 35	Every Pre-Punched Hole		#8 x 2" Screw with Washer		

IMPORTANT: For installations over continuous exterior insulation, the anchor length must be increased by the thickness of the insulating panels.

* For light gauge steel framing, use #10 self-drilling modified truss head screws with 3 thread min embedment.

** High Performance Frame Fillers (self-adhesive spacers) are required at each jamb anchor location.

NOTE: Do not over-drive fasteners, but allow for movement of building materials.

*** Refer to the supplemental instruction included with the unit for securing mullion end anchors (if applicable). End anchor quantity depended upon project design pressure requirements.

When screws are used in the nail fin and PG >35, a 1" fender washer is required at each screw anchor location.

Fastening requirements are applicable to J-channel frame types.



NAIL FIN WINDOW ANCHOR INSTRUCTIONS (CONTINUED)

Note: Standard performance only. Additional anchoring may be required for performance upgrade, impact-resistant products or to comply with local building code requirements.

PELLA® IMPERVIA, ARCHITECT SERIES® (850) AND PELLA® LIFESTYLE SERIES NAIL FIN ANCHOR SPACING INSTRUCTIONS

Units with Pella EnduraClad exterior trim with narrow fins and no pre-punched holes must be anchored with frame screws or installation clips. The fins are for flashing purposes only.

Product	PG Rating	Max Frame Width (inches)	Max Frame Height (inches)	Edge Spacing (E)	Max. Intermediate Spacing (S)	Anchor Type	Frame Anchors
						Wood *	
Impervia Windows	All	Any	Any	3"	7"	2" 11 Ga. Roofing Nail	None
Impervia Direct Set	All	Any	Any	Every pre-punched hole		2" 11 Ga Roofing Nail	>50 sq. ft. requires screw through frame or clip anchors in addition to nail fin fasteners. Refer to block frame anchor instructions for further details. (See Illustration below.) 40-50 sq. ft. see note below.
Architect Series & Lifestyle Series Clad Wood CM, AW or FX Windows	All	73"	73"	Every Pre-Punched		2" 11 Ga. Roofing Nail	None
	All	>73"	>73"	Every Pre-Punched Hole		2" 11 Ga. Roofing Nail	#10 x 3-1/2" Screws at 1/3 points along head and jambs
Architect Series & Lifestyle Series SH or DH Windows	All	Any	Any	Every Pre-Punched Hole		2" 11 Ga. Roofing Nail	None
Monumental DH	All	<54	<96	Every Pre-Punched Hole		1-1/2" 11 Ga. Roofing Nail	Refer to the next page for units larger than 54 x 96
Clad wood Direct Set	<PG60	Any	Any	Every Pre-Punched Hole		2" 11 Ga. Roofing Nail	See note below
Clad Wood Curved Windows with Flexible Fin	All	Any	Any	Every Pre-Punched Hole		(2) #6 x 1-1/2" screw per clip	Must be anchored with frame screws or installation clips. Refer to next page for anchoring instructions.
Clad Wood Curved Windows with Rigid Fin	All	Any	Any	6"	12"	2" 11 Ga. Roofing Nail	None

IMPORTANT: For installations over continuous exterior insulation, the anchor length must be increased by the thickness of the insulating panels.

* = For light gauge steel framing, use #10 self-drilling modified truss head screws.

NOTE: Do not over-drive fasteners in vinyl fins, but allow for movement of building materials.

Impervia Direct Set 40-50 Sq. Ft. use #10 x 3" screws required on longest edge spaced 6" from each end and on center. For integral mullion units, screws required 6" from the center of the mull on each side.

Refer to the supplemental instruction included with the unit for securing mullion end anchors (if applicable). Clad wood direct set windows achieve PG50 up to 60" x 60" with standard anchoring. Larger sizes achieve PG40. Refer to advanced performance/impact-resistant instructions for other options.

EXAMPLE ANCHOR TYPES

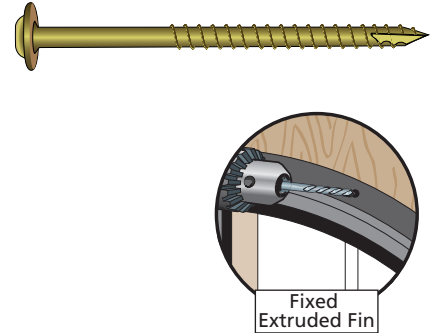
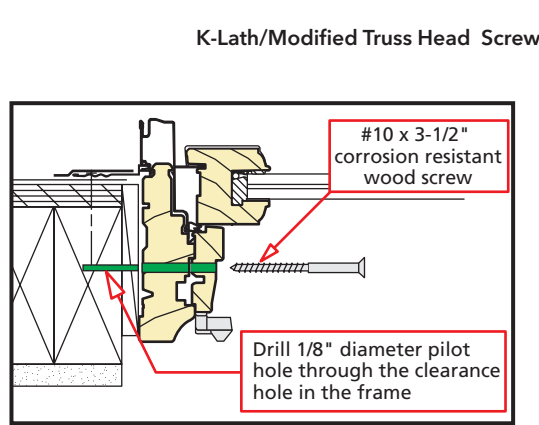
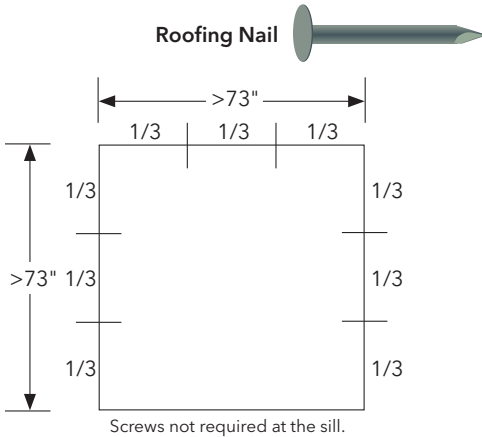

Add installation clips or frame anchor screws for vent and fixed clad-wood casements over 73".

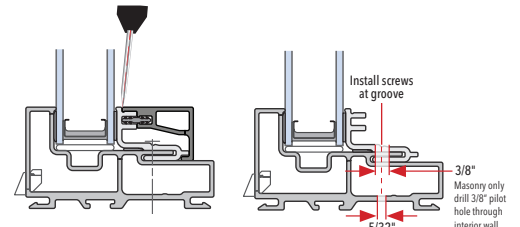
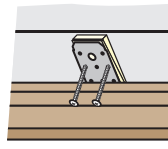
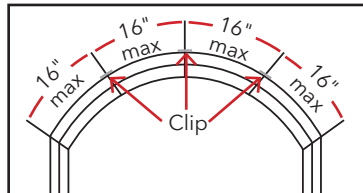
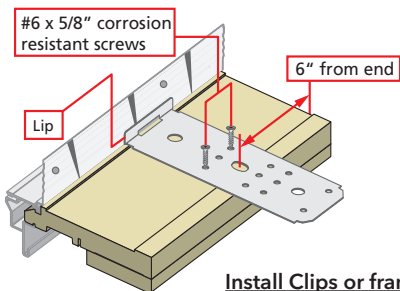

Install Clips or frame screws for windows with non-structural curved flex fins.

****Use putty knife; insert where indicated and slide cover to interior.



UNITS WITH WIDE PELLA® ENDURACLAD® EXTERIOR TRIM WITH NARROW FINNS AND NO PRE-PUNCHED HOLES ANCHOR INSTRUCTIONS AND MONUMENTAL HUNG > 54" X 96"

Note: Standard performance only. Additional anchoring may be required for performance upgrade, impact-resistant products or to comply with local building code requirements.

Units with narrow fins and NO pre-punched holes must be anchored using frame screws or installation clips. These fins are for flashing purposes only.

Units installed over continuous exterior insulation must be anchored using installation clips

PLACE FRAME SCREWS OR CLIPS AT THE LOCATIONS INDICATED

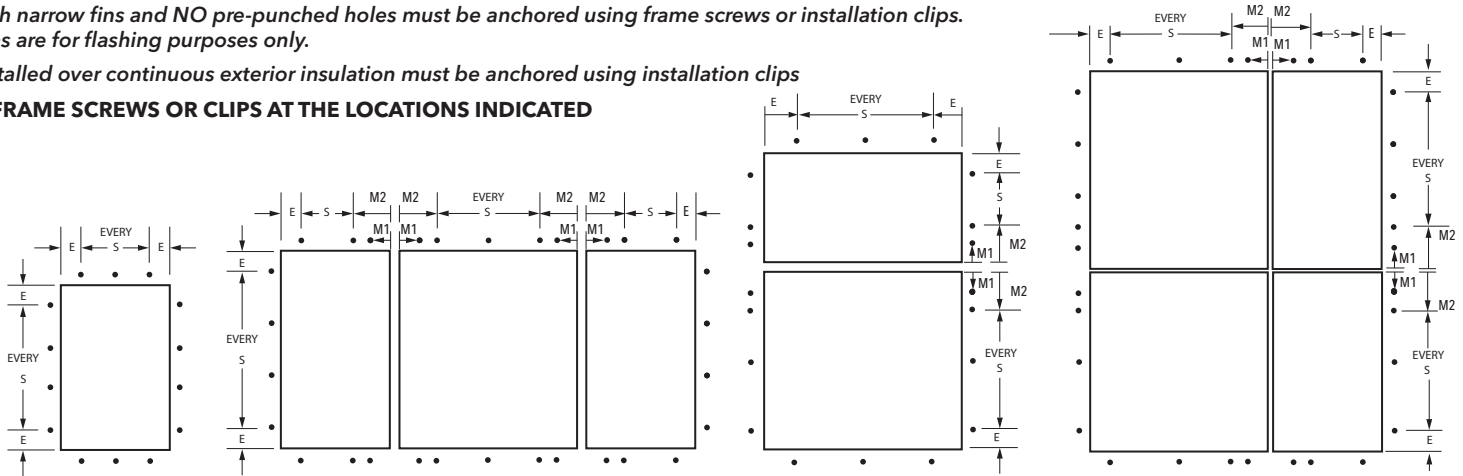

ARCHITECT SERIES® (850) AND PELLA® LIFESTYLE SERIES WINDOW ANCHOR SPACING INSTRUCTIONS

Product	Edge Spacing (E)	Max. Intermediate Spacing (S)	First Mullion Anchor (M1)	Second Mullion Anchor (M2)	Fastener	Special Notes
					Wood **	
Casement/Awning	6"	16"	3"*	6"	#8 x 3" Finish Screw	
Double- or Single- Hung	6"	16"	3"*	6"	#8 x 3" Finish Screw	For windows with integrated Rolscreen® retractable screen, drive jamb screws at each factory pre-punched hole in the jamb liner. Add fasteners as necessary, driving the head past flush of the jamb liner. Avoid Rolscreen components in the head and sill.
Fixed Frame	6"	16"	3"*	6"	#8 x 3" Finish Screw	
Monumental DH > 54" x 96"	6" (head)	16" (head)	3" *	6" *	#8 x 3" Screw	Remove sashes and jamb liners. Drive 1 screw through each jamb liner support clip (top, bottom, checkrail and center of each sash). Drive 2 additional screws through the frame (or secure clips) 3" above and below the checkrail on each jamb. Drive additional screws through the frame (or secure clips) centered between each jamb liner support clip.

* M1 anchor required if design pressure exceeds 20 psf.

** For light gauge steel framing, use #10 self-drilling/self-tapping screws; For concrete or masonry, use 3/16" masonry screws with 1-1/4" minimum embedment.

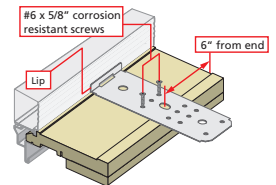
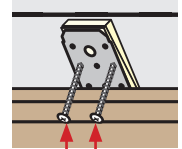

1/8" Pilot Hole Locations

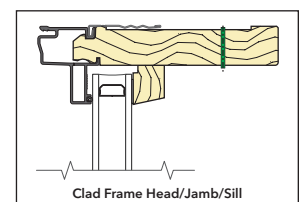
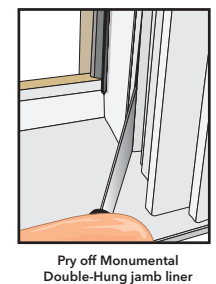
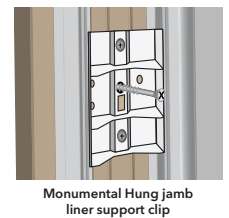
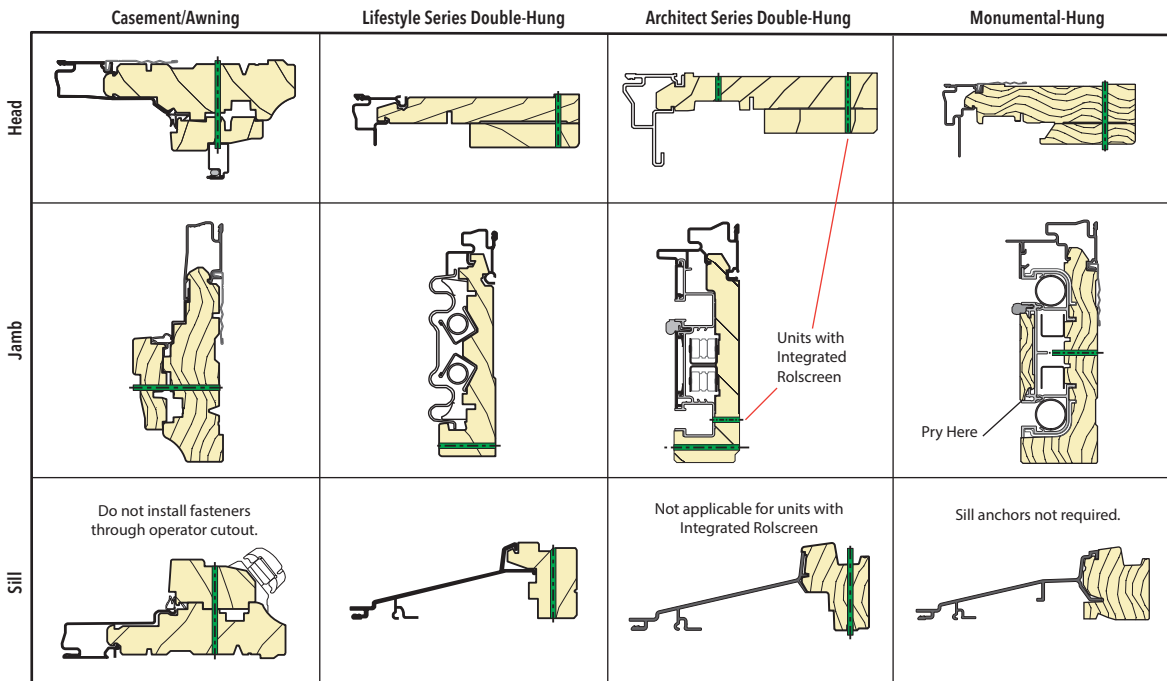



Interior Sealant Instructions

CAUTION: Continuous backer rod (as necessary) and a high quality, low-odor interior sealant such as Pella Window and Door Installation Sealant (or equivalent) is recommended for commercial or high performance installations to create the continuous interior seal. Follow the directions on the cartridge. For standard performance or products with factory applied jamb extensions, use low pressure polyurethane insulating foams. Follow the directions on the can. Do not use high pressure or latex foams. Fiberglass batt or similar insulation is not recommended as it can absorb water and does not act as an air seal.

- A. Insert the nozzle or straw between the rough opening and window frame from the interior. Use a pliers (if necessary) to compress the end of a straw tube to allow it to fit in tight openings.
- B. Place a 1" deep bead of foam approximately 1" from the interior of the frame to allow for expansion. DO NOT fill the entire depth of the rough opening cavity.

NOTE: Apply foam between the frame and rough opening, NOT between jamb extensions and the rough opening.
- C. Re-Check window operation and remove remaining shipping spacers after foam installation. Excess foam may be removed with a serrated knife after it cures.
- D. To ensure a continuous interior seal, apply sealant over or around any shims or clips interrupting the foam seal.

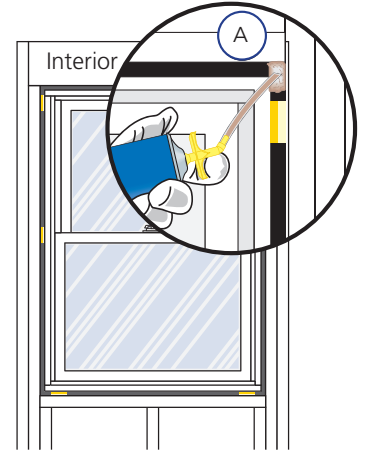

Exterior Sealant Instructions

CAUTION: Use a high quality, multi-purpose exterior sealant such as Pella Window and Door Installation Sealant. Follow the directions on the cartridge.

When applying siding, brick veneer, flashing, or other exterior finish materials, leave adequate space between the window frame and the material for sealant application.

- A. Insert backer rod 3/8" deep in the space around the window. Backer rod adds shape and controls the depth of the sealant line.
- B. Apply a continuous bead of sealant to the entire perimeter of the window. Do not block weep holes or weep hoods with sealant.
- C. Shape, tool and clean excess sealant. When finished, the sealant should be the shape of an hourglass.

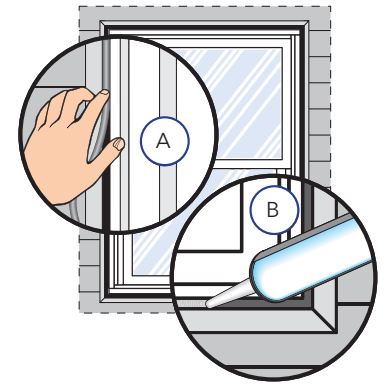

NOTE: The siding details below apply to windows without a J-mould as part of the frame. The J-mould frame is only intended for vinyl or metal sidings where the siding is extended behind the J-mould portion of the frame. The J-mould should be removed and replaced with backer rod and sealant with all other siding or trim types.

