

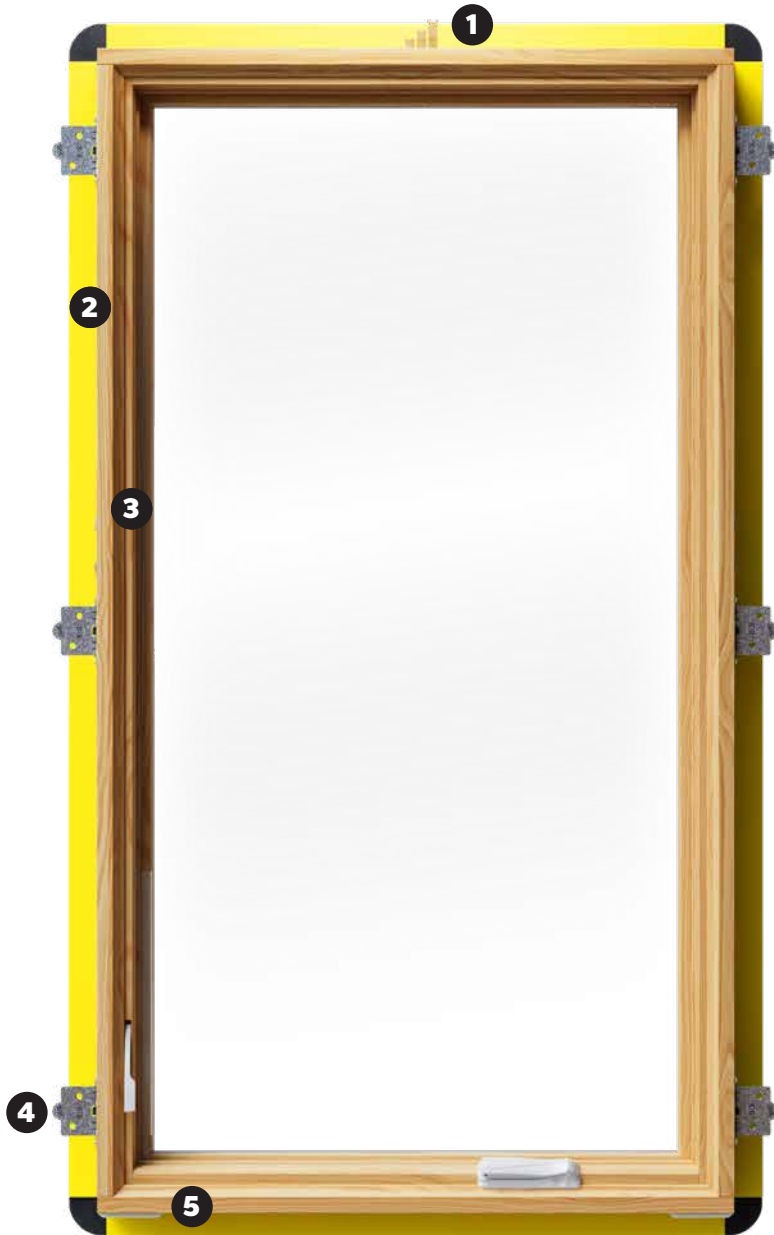

Pella® Steady Set™ Interior Installation System

Steady Set™ Components

INTERIOR VIEW



1 Head Stabilizer

DESIGNED TO ENGAGE WITH THE HEADER OF THE ROUGH OPENING TO HELP TEMPORARILY STABILIZE THE UNIT.



2 Flashing Fin

A POP-UP YELLOW EXTERIOR FIN CAN BE EASILY DEPLOYED AFTER THE WINDOW IS SET FOR INTEGRATION WITH THE EXTERIOR WEATHER BARRIER.



3 Shim Guide

THE SHIM GUIDE (IF APPLICABLE) COMES PRE-ATTACHED TO THE JAMBS OF THE UNIT AND ASSISTS THE INSTALLER BY HELPING TO HOLD SHIMS IN THE CORRECT LOCATION.



4 Installation Bracket

THE BRACKETS COME PRE-ATTACHED TO THE UNIT AND SIMPLY NEED TO BE CLICKED INTO THE RECEIVER TO BE INSTALL READY.



5 Sill Shims

PRE-APPLIED SILL SHIMS RAISE THE UNIT 1/4" OFF THE SILL ENSURING SPACE FOR FOAM OR SEALANT.

These instructions were developed and tested for use with wall systems designed to manage water. These instructions are not to be used with any other construction methods or window frame types. Installation instructions for use with other construction methods or frame types may be obtained from Pella Corporation, your local Pella® retailer or www.installpella.com. Building designs, construction methods, building materials, and site conditions unique to your project may require an installation method different from these instructions and/or additional care. Determining the appropriate installation method is the responsibility of you, your architect, or construction professional.



BY PURCHASING, INSTALLING OR USING PELLA PRODUCTS (INCLUDES PELLA GOODS AND PELLA SERVICES), YOU AGREED TO THE TERMS OF THE LIMITED WARRANTY AND YOU AND PELLA FURTHER AGREE TO ARBITRATE DISPUTES ARISING OUT OF OR RELATING TO PELLA PRODUCTS, AND YOU WAIVE ANY RIGHT TO PARTICIPATE IN A CLASS ACTION RELATED TO PELLA PRODUCTS unless you notify Pella of your decision to opt out of the Arbitration Agreement no later than ninety (90) calendar days from the date you purchased or otherwise took ownership of Your Pella Goods. Opting out of the Arbitration Agreement will not affect the coverage provided by any applicable limited warranty pertaining to Your Pella Products. For opt out information and additional details please read the Limited Warranty and Arbitration Agreement for your Pella Products at www.Pella.com/arbitration.



IMPORTANT SAFETY AND PRODUCT INFORMATION – WINDOW

Safety Alert Symbol Reference: These symbols are intended to alert you to potential injury hazards and information.

Obey all safety messages.

COULD

Result in:



COULD

Result in:



COULD

Result in:



COULD

Result in:



To ensure safety and security and help prevent property damage, including possible damage to your window or door, close and lock windows and doors any time they are not being used for venting on a nice day, and particularly during high winds or rain. Ensure all windows and doors are properly fastened to the wall structure according to the product anchor instructions. It is the responsibility of the Buyer or User, the architect, contractor, installer, or other construction professional to ensure the appropriate windows and doors are chosen for the project and the wall construction is designed to resist all loads in accordance with local building code requirements.



Many windows and doors in older homes are painted with lead-based paint. Removal of old windows and doors may disturb this paint. Proper precautions must be taken to minimize exposure to dust and debris. Consult state or local authorities and/or go to www.epa.gov/lead for more information.

NOTICE

Pella products must be stored in an upright, level position not exposed to weather. The storage must be ventilated and provide protection from direct sunlight and excessive temperature.

IMPORTANT NOTICE

Because all construction must anticipate some water infiltration, it is important that the wall system be designed and constructed to properly manage moisture. Pella Corporation is not responsible for claims or damages caused by anticipated and unanticipated water infiltration; deficiencies in building design, construction and maintenance; failure to install Pella products in accordance with Pella's installation instructions; or the use of Pella products in wall systems which do not allow for proper management of moisture within the wall systems. The determination of the suitability of all building components, including the use of Pella products, as well as the design and installation of flashing and sealing systems are the responsibility of the Buyer or User, the architect, contractor, installer, or other construction professional and are not the responsibility of Pella.

Pella products should not be used in barrier wall systems which do not allow for proper management of moisture within the wall systems, such as barrier Exterior Insulation and Finish Systems (EIFS) (also known as synthetic stucco) or other non-water managed systems. Except in the states of California, New Mexico, Arizona, Nevada, Utah and Colorado, Pella makes no warranty of any kind on and assumes no responsibility for Pella windows and doors installed in barrier wall systems. In the states listed above, the installation of Pella Products in barrier wall or similar systems must be in accordance with Pella's installation instructions. Product modifications that are not approved by Pella Corporation will void the warranty.

CARE AND MAINTENANCE: Refer to the Pella Owner's Manual. Visit www.pella.com or your local retailer for more information.

CLEANING INSTRUCTIONS: Refer to the Pella Owner's Manual for comprehensive maintenance and cleaning information. Visit www.pella.com or your local retailer for more information.

GLASS: Remove any protective film and labels and clean the glass, using a soft, clean, grit-free cloth and mild soap or detergent. Be sure to remove all liquid by wiping dry or use a clean squeegee.

NOTICE

DO NOT apply any other types of film to the glass. Doing so could void product warranty.

NOTICE

Do not use solvents such as mineral spirits, toluene, xylene, naphtha or muriatic acid as they can dull the finish, soften the vinyl and/or cause failure of the insulated unit seal.

NOTICE

Do not use Isopropyl Alcohol on laminated surfaces as it will damage the finish. Keep door tracks clear of dirt and debris. Keep weep holes open and clear of obstructions.

NOTICE

DO NOT use abrasives. DO NOT scrape or use tools that might damage the surface.

NOTICE

DO NOT use inappropriate solvents or brickwash or cleaning chemicals. If you do, permanent damage can result and the product failure, loss or damage would not be covered by the Limited Warranty.

INTERIOR FINISH (WOOD WINDOWS)

Paint or finish immediately after installation.

If products must be stored or cannot be finished immediately, cover with clear plastic to protect from dirt, damage and moisture. Remove any construction residue before finishing. Sand all wood surfaces lightly with 180 grit or finer sandpaper. DO NOT use steel wool. BE CAREFUL NOT TO SCRATCH THE GLASS. Remove sanding dust. Pella products must be finished per the below instructions; failure to follow these instructions voids the Limited Warranty.

Note: To maintain proper product performance do not paint, finish or remove the weatherstripping, mohair dust pads, gaskets or vinyl parts. Air and water leakage will result if these parts are removed. After finishing, allow venting windows and doors to dry completely before closing them. If paint, stain or finish gets on the weatherstripping, wipe it off immediately with a damp cloth.

WINDOW CLEANING AND PREP INSTRUCTIONS FOR UNFINISHED OR PRIMED WINDOWS: Dry wipe dust from windows gently. Examine window for possible smudges or fingerprints made from normal handling or construction. To remove smudges, lightly wipe surface with warm water. Scuff sand with light grade sand paper or abrasive pad (220 grit or higher). Rinse surface with warm water. Let window surfaces dry completely before applying finish.

- On casement and awnings, it is optional to paint, stain or finish the vertical and horizontal sash edges.
- On single-hungs and double-hungs, do not paint, stain or finish the vertical sash edges, any finish on the vertical sash edges may cause the sash to stick; it is optional to paint, stain or finish the horizontal sash edges.







Pella Corporation is not responsible for interior paint and stain finish imperfections for any product that is not factory-applied by Pella Corporation. For additional information on finishing see the Pella Owner's Manual or go to www.pella.com.

The use of unapproved finishes, solvents or cleaning chemicals may cause adverse reactions with door materials. Pella will not be responsible for problems caused by the use of unapproved materials. If in doubt, contact your local retailer or representative.













PREPARING FOR STEADY SET™ WINDOW INSTALLATION

MATERIALS REQUIRED:

- Moisture resistant shims/spacers 
- Fasteners (See anchor instructions and tables at the end of this booklet.)
- Closed cell foam backer rod/sealant backer 
- Pella® SmartFlash™ foil backed butyl window and door flashing tape  or equivalent 
- Low expansion, low pressure polyurethane insulating window and door foam sealant. **DO NOT** use high pressure or latex foams. 
- Pella Window and Door Installation Sealant or equivalent high quality, multi-purpose sealant 

TOOLS REQUIRED:

- Tape measure 
- Level 
- Square 
- Hammer 
- Stapler 
- Air shim 
- Small pry bar 
- Scissors or utility knife 
- Small flat blade screwdriver 
- Sealant gun 
- Screw gun with a Phillips driver bit 
- Drill with 1/8", 5/32", 3/16" & 3/8" drill bits

Other construction materials may be required. Read and understand the instructions and inspect the wall conditions before you begin.

WARNING Installation may require (2) or more persons for safety reasons.

ROUGH OPENING VERIFICATION

A. Confirm the opening is plumb and level.

NOTICE It is critical the bottom is level and it does not slope to the interior.

B. Remove dirt, oil or debris from the opening and surrounding wall surfaces.

C. Confirm the window will fit the opening. Measure all four sides of the opening to make sure it is 3/4" to 1" larger than the window in both width and height. On larger openings measure the width and height in several places to ensure the header or studs are not bowed.

NOTICE 1-1/2" or more of solid wood blocking is typically required around the perimeter of the opening. Fix any problems with the rough opening before proceeding.

D. For continuous exterior insulation panels up to 1" thick, utilize standard installation methods. For insulating panels 1.5" to 2" thick, Pella Rough Opening Support Brackets or solid wood blocking is recommended. For insulated panel assemblies greater than 2.5" thick, wood blocking is required.

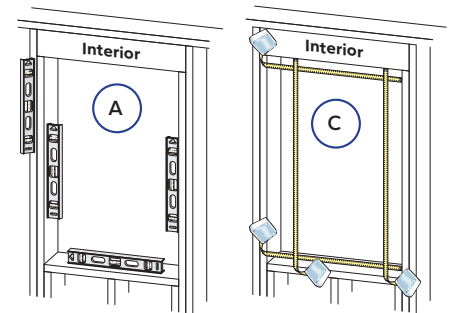
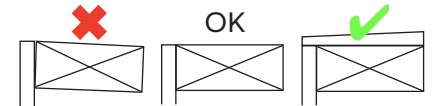

PREPARE THE WINDOW FOR INSTALLATION

CAUTION Some components have sharp edges that may cause lacerations. Wear gloves or take care when unpackaging the window.

E. Remove plastic wrap and cardboard packaging from window. DO NOT cut checkrail bands (if present) or remove plastic or foam shipping spacers located between the window sash and frame. DO NOT open the window until it is securely fastened.

IMPORTANT DO NOT remove the fin cover at this time.

F. Inspect the product for any damage such as cracks, dents or scratches. DO NOT install damaged windows.

G. Remove screens and hardware (if necessary). Label them and set them aside in a protected area.

H. Confirm Steady Set Brackets are correct for the application.

- The 2x4 Bracket is designed for 2x4 wall construction with 7/16" exterior sheathing.
- The 2x6 Bracket is designed for traditional 2x6 or 2x4 wall construction with 7/16" exterior sheathing. For use in 2x4 wall construction a portion of the bracket must be removed. Bend and break at the coin line, if necessary.

Note: The 2x4 and 2x6 Brackets can accommodate up to ~5/8" exterior sheathing thicknesses due to the flexible portion of the flashing fin, however exterior window frame projection would reduce by ~1/8".

- Other Wall Construction depths: An Adjustable Bracket is required. Refer to the supplemental instructions at the end of this booklet or the instructions provided with the Adjustable Brackets.

I. Engage the Steady Set Brackets. The brackets arrive on the window either stowed in a shipping orientation in each Receiver, or in a skin card attached to the window corner(s). Remove the brackets and insert into each Receiver. They must audibly click and be fully engaged with the Receiver Catch Arm.

NOTICE If necessary to remove a bracket after it has been clicked into the receiver, gently lift the receiver catch arm with a flat head screwdriver to allow removal. Take care to not over-bend the catch arm. Over-bending the catch arm may not allow the catch arm to re-engage the brackets.

Note: Any brackets on the bottom of the window can be removed and reinserted after window is partially set into the opening.

WARNING Brackets must fully engage the receiver. If receiver catch arm has been bent or damaged, attempt to correct the bend by lightly tapping catch arm flat with a hammer. If the catch arm still does not engage the brackets, refer to the anchor page for alternative window attachment methods or replace the receiver.

See the anchor instruction pages at the end of this booklet. Additional preparation may be required for the performance upgrade, impact-resistant products or to comply with local building code requirements.

J. Read the entire instruction before proceeding.

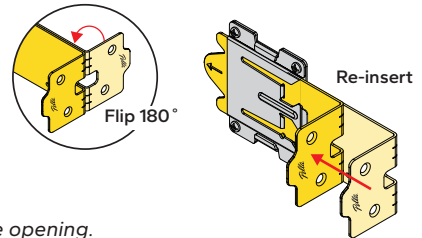
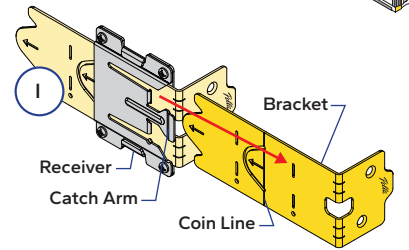
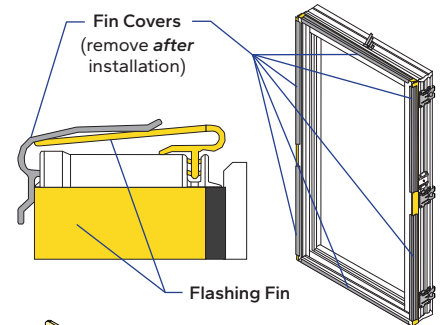



NEW CONSTRUCTION STEADY SET™ WINDOW INTERIOR INSTALLATION AFTER BUILDING WRAP

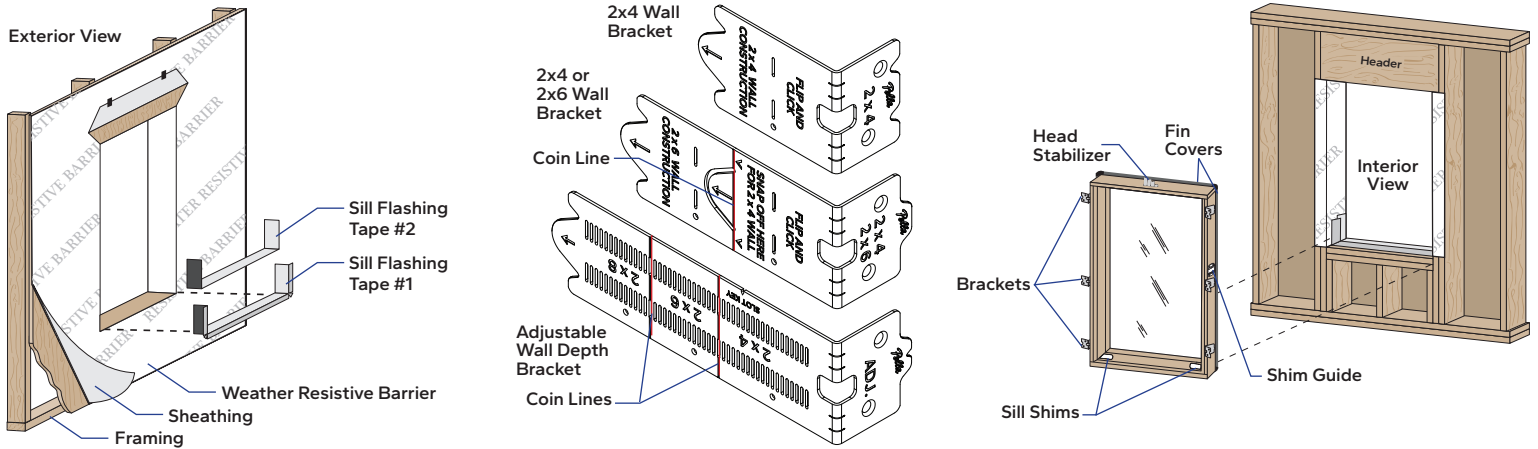

1 PREPARE THE OPENING

Refer to the installation preparation section at the beginning of this booklet.

- Cut the weather resistive barrier.
- Fold the weather resistive barrier in at the jambs and staple it in place. Fold the top flap up and temporarily fasten with flashing tape.

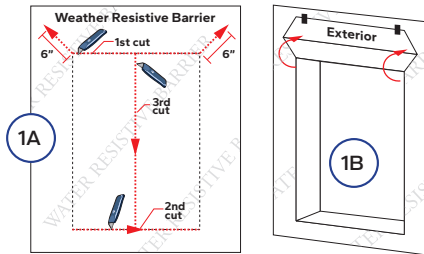

Note: A box cut pattern is also acceptable, provided flashing tape is used on each side adhered 1" onto the weather barrier and wrapped into the opening.

- Cut 2 pieces of flashing tape 12" longer than opening width.
- Apply sill flashing tape #1 at the sill extending 1" to the exterior and 6" up each jamb.
- Cut 1" wide tabs at each corner by tearing the foil 1/2" each way from corner. Add a small patch of tape if necessary to ensure the opening corners are sealed and protected.
- Apply sill flashing tape #2 overlapping tape #1 by 1" minimum.

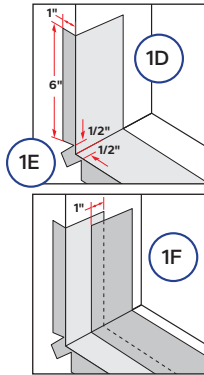

NOTICE Press all tape down firmly.

2 PREPARE THE WINDOW

- Remove packaging from the window.

IMPORTANT DO NOT remove the fin covers.

IMPORTANT Verify brackets match wall construction depth.

- Engage the brackets into the receivers. Refer to page 3, *Prepare the Window For Installation*, for additional information

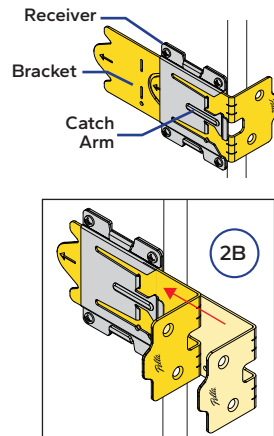

WARNING Verify brackets have fully engaged the receiver. Each should audibly click when engaged. DO NOT continue to step 3 until top and side brackets are engaged.

3 SETTING AND FASTENING THE WINDOW

- Insert the window into the opening. From the interior, set the window and push it towards the exterior until the brackets set flat against the inside of the wall.

IMPORTANT Verify head stabilizer engages the header.

Note: There may be some resistance from the head stabilizer as it engages the opening header.

NOTICE If removal of window from opening is required, lift window and slide bottom of window towards the interior.

CAUTION Never leave a window unattended. Head stabilizer does not fully secure window in the rough opening and may not engage header in all conditions.

- Center the window within the opening.

- Level the window sill. If necessary, place shim under appropriate pre-attached sill shim on the window sill. Place additional shims under each vertical mullion or between the pre-attached sill shims as necessary to straighten window sills.

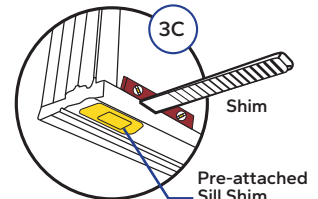

NOTICE Improper placement of shims may result in bowing the bottom of the window.

- Attach two bottom brackets. Drive two (2) #8 x 1-1/2" flat head screws through the bracket and into the wood framing to anchor the window.

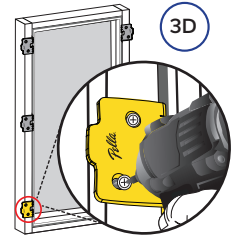

- Level and plumb the window jambs. Add shims or use an airbag as necessary to create an even sash-to-frame reveal and hold window level and square. Measure diagonally to verify.

Double Hungs: Shim at each end of the checkrail.

NOTICE DO NOT shim above the window. Additional shims may be required at screw locations for large units and combinations. Refer to anchor instructions near the end of this booklet.

- Attach remaining brackets. Drive two (2) screws through each remaining bracket and into the wood framing. Refer to the anchor instructions near the end of this booklet.

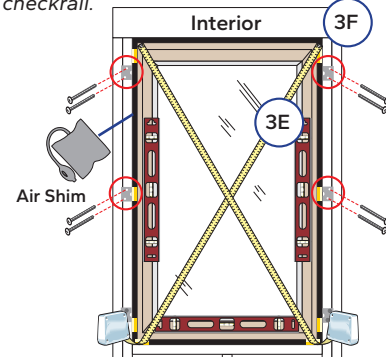

WARNING All brackets must be properly anchored to the wall structure before leaving window unattended.



NEW CONSTRUCTION STEADY SET™ WINDOW INTERIOR INSTALLATION AFTER BUILDING WRAP (CONTINUED)

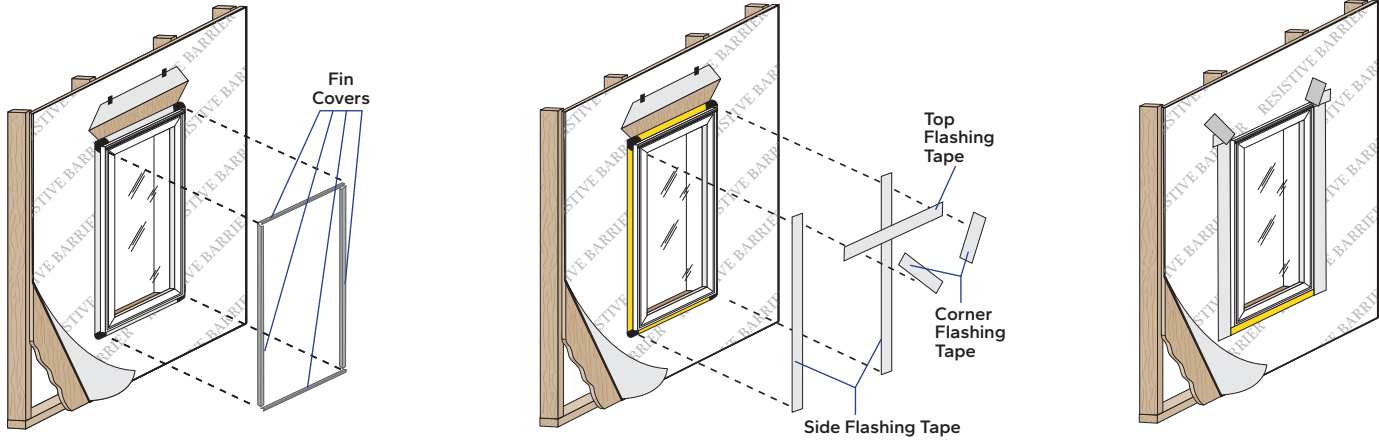

3 SETTING AND FASTENING THE WINDOW CONTINUED

G. Check window operation.

Vent Awning and Casement: Refer to applicable hardware instructions. Unlock and open the window to remove the shipping spacers. Open and close the window to test for proper operation.

Double-Hung: Cut the checkrail bands (if applicable) and remove shipping spacers. Open, close, and tilt the sashes to test for proper operation. Check for equal sash-to-frame reveal from top to bottom.

Note: For Double Hung windows ≥ 37", a sill straightening clip is provided. Bring the clip to the exterior to assist with straightening the sill, if necessary.

IMPORTANT Adjust shims to correct any issues with plumb, square, operation or reveal. If necessary, secure window frame to ensure window placement and sash-to-frame reveal is maintained.

4 INTEGRATING THE BUILDING WRAP

A. **Straighten the frame** (if necessary). From the exterior, create an even sash to frame reveal by inserting a shim into the shim receiver pre-attached near the center of the window jamb on the window frame (if applicable).

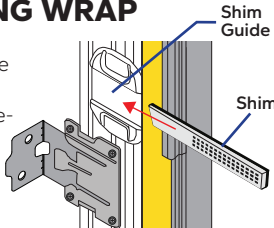

B. **Remove the fin covers.** Ensure the flashing fin folds out against the weather resistive barrier.

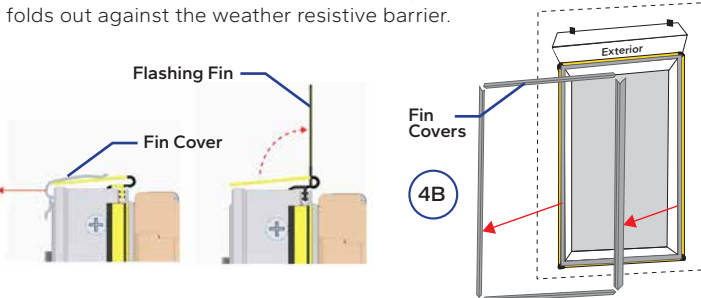

For DH units ≥ 37": Use the sill straightening clip (if necessary) to hold the sill straight. Insert into the sill channel and secure the sill straight with the provided screws.

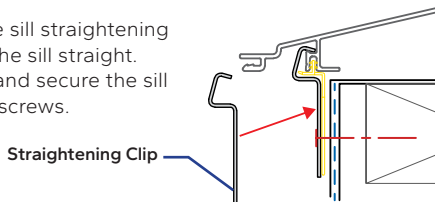

NOTICE Check the flashing fin and fin covers for damage. Add flashing tape if necessary to repair damaged fins or fin corners.

Note: Using sealant behind the head and jamb fins is optional.

4 INTEGRATING THE BUILDING WRAP CONTINUED

C. **Apply straight side flashing tape.** Cut two pieces of flashing tape 4" taller than straight sides. Apply tape over the fin and onto the weather resistive barrier. Extend tape 2" above and below straight sides.

Angle top units: On the short side, do not allow the side tape to extend higher than what the top tape will cover.

NOTICE DO NOT apply continuous sealant under the sill fin. DO NOT apply flashing tape over the sill fin.

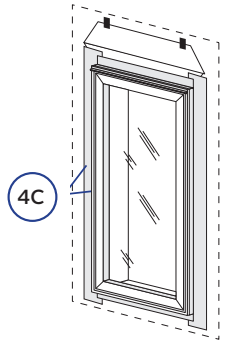

D. **Apply top flashing tape.**

Cut one piece of flashing tape to extend 1" past both side flashing tapes.

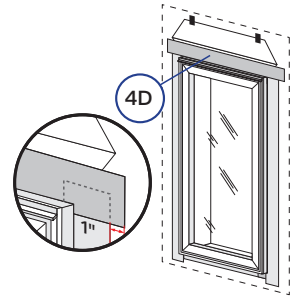

E. **Fold down the top flap** of the weather resistive barrier.

Note: Refer to the weather resistive barrier manufacturer's instructions, if taping or otherwise adhering the bottom edge of the top flap is recommended, or options regarding integration of head drip caps or head wall flashings required per step H.

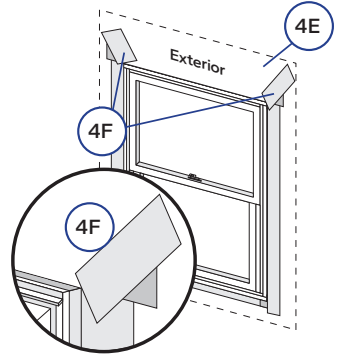

F. **Apply flashing tape to top diagonal cuts.** Cut pieces of flashing tape at least 1" longer than each diagonal cut. Overlap tape 1" past end of cut onto weather barrier. Overlap multiple pieces of tape by 1" when necessary.

NOTICE Press all flashing tape down firmly.

G. **Install interior sealant.** Refer to interior sealant instructions at the end of this booklet.

H. **Install head wall flashing,** properly incorporating it with the wall cladding and weather resistive barrier according to applicable code requirements.

I. **Install exterior sealant** (after wall cladding is installed). Refer to the exterior sealant instructions at the end of this booklet.

Note: Refer to wall cladding manufacturer's instructions.



INTERIOR WINDOW ANCHOR INSTRUCTIONS

Note: Standard performance only. Additional anchoring may be required for performance upgrade, impact-resistant products or to comply with local building code requirements.

Pella® Reserve and Lifestyle Series Steady Set™ Anchor Instructions

Product Type	PG*	Max. Frame Width	Max. Frame Height	Anchor Type		Special Notes	Diagram Reference
				Wood			
Casement / Awning / Fixed Sash in Frame	≤50	73"	73"	(2) #8 x 1-1/2" Flat Head Wood Screws per Bracket			A
		>73"	>73"		Add #10 x 3-1/2" screws through frame or installation clips at one-third points along the head and jambs.	A.1	
Simulated- / Single- / Double-Hung	≤50	All	All		Shim appropriately at the checkrails for optimum performance.	B	
Direct Set	≤50	60"	60"		Add #10 x 3-1/2" screws through frame or installation clips at one-third points along the head and jambs.	D	
	≤40	>60"	>60"		Add #10 x 3-1/2" screws through frame or installation clips 6" from corners and 16" on center.	D.1	
	>50	All	All		Add #10 x 3-1/2" screws through frame or installation clips 6" from corners and 16" on center.	D.2	
Combinations with Standard Joining / Reinforcement Plate Mullions	≤50	96"	96"	Each provided bracket is sufficient to carry up to 200 lbs of mullion end load. Add screws through frame or installation clips as indicated in diagram E if mullion end load exceeds the provided brackets and their carrying capacity.	E		
Combinations 1/2" Aluminum / Wood Spread Mullions	≤50	144"	144"				

* Product PG may vary based on ordered glass type or frame size. Confirm project requirements with local structural engineer or consult your local Pella representative.

Note: For any receiver catch arm that does not click into the L brackets, supplement the L bracket attachment with (2) #8x3-1/2" trim screws through the frame or attach a standard installation clip above or below the receiver.

1/8" Pilot Hole Locations, when required per special notes above

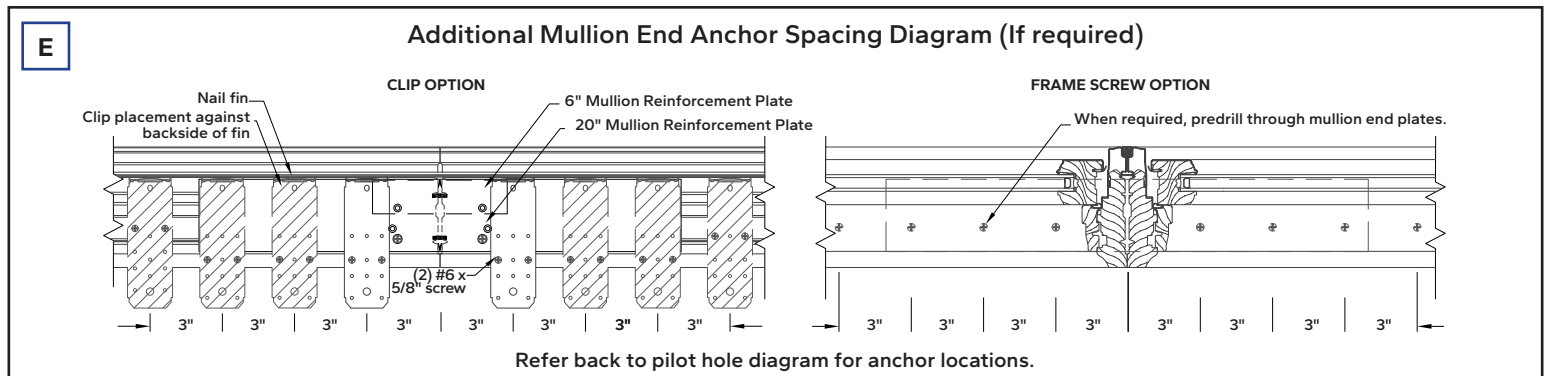
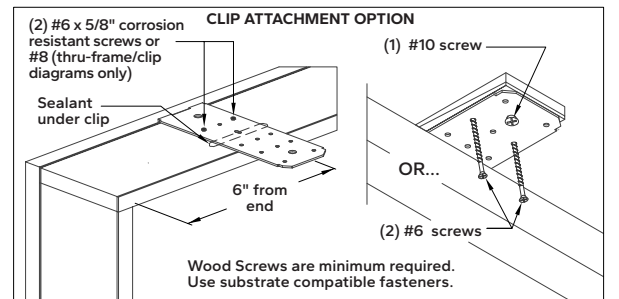
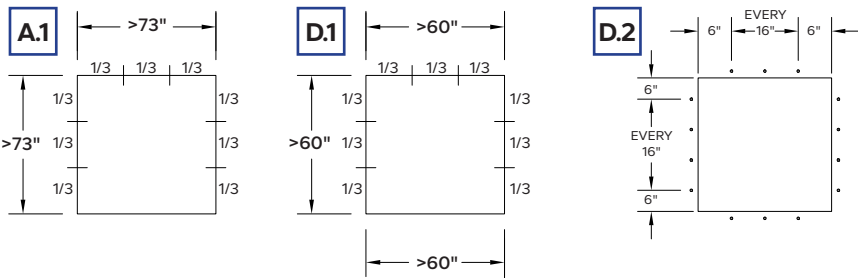
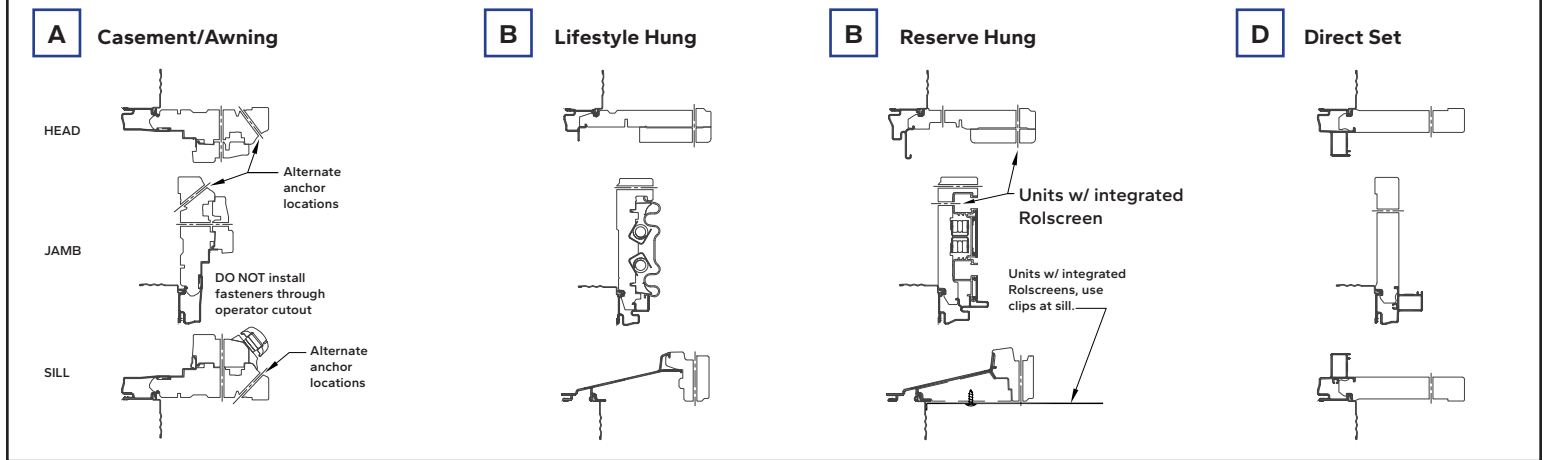



Interior Sealant Instructions

NOTICE Continuous backer rod (as necessary) and a high quality, low-odor interior sealant such as Pella Window and Door Installation Sealant (or equivalent) is recommended for commercial or high performance installations to create the continuous interior seal. Follow the directions on the cartridge. For standard performance or products with factory applied jamb extensions, use low pressure polyurethane insulating foams. Follow the directions on the can. Do not use high pressure or latex foams. Fiberglass batt or similar insulation is not recommended as it can absorb water and does not act as an air seal.

A. **Insert the nozzle or straw** between the rough opening and window frame from the interior. Use pliers (if necessary) to compress the end of a straw tube to allow it to fit in tight openings or extend beyond factory applied jamb extensions.

B. **Place a 1" deep bead of foam** approximately 1" from the interior of the frame to allow for expansion.

NOTICE DO NOT fill the entire depth of the rough opening cavity. Leave exterior one-third (1/3) of cavity open. Apply foam between the frame and rough opening flashing materials, NOT between jamb extensions and the rough opening.

Note: For products with Steady Set™ anchorage brackets, inject foam within and around brackets.

C. **Re-check window operation** and remove remaining shipping spacers after foam installation. Excess foam may be removed with a serrated knife after it cures.

D. **To ensure a continuous interior seal**, apply sealant over or around any shims, installation brackets, or Steady Set brackets interrupting the foam seal.

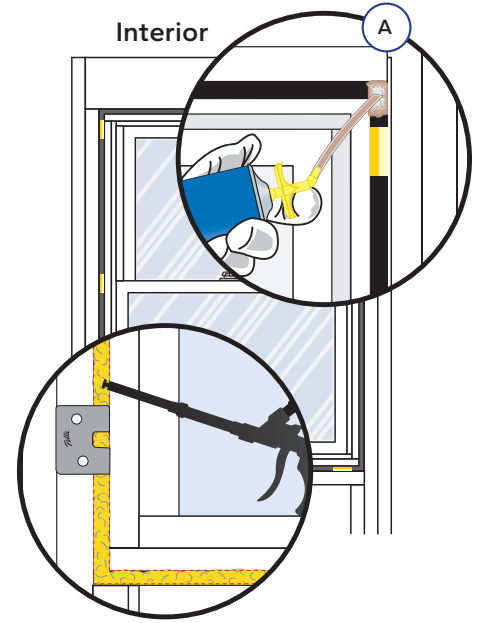

Exterior Sealant Instructions

NOTICE Use a high quality, multi-purpose exterior sealant such as Pella Window and Door Installation Sealant. Follow the directions on the cartridge.

When applying wall cladding exterior finish materials, leave adequate space between the window frame and the material for application of sealant.

A. **Insert backer rod 3/8" deep** in the space around the window. Backer rod adds shape and controls the depth of the sealant line.

B. **Apply a continuous bead of sealant** to the entire perimeter of the window.

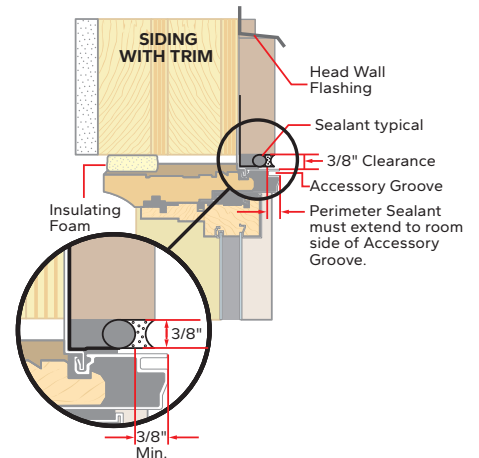
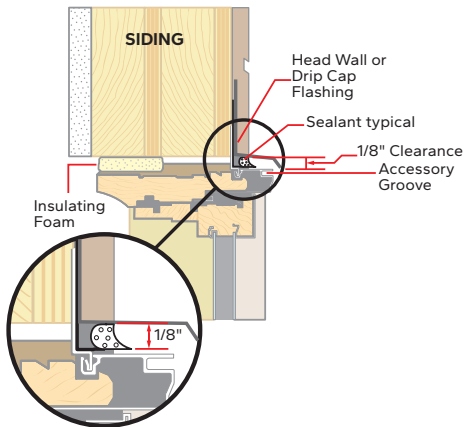
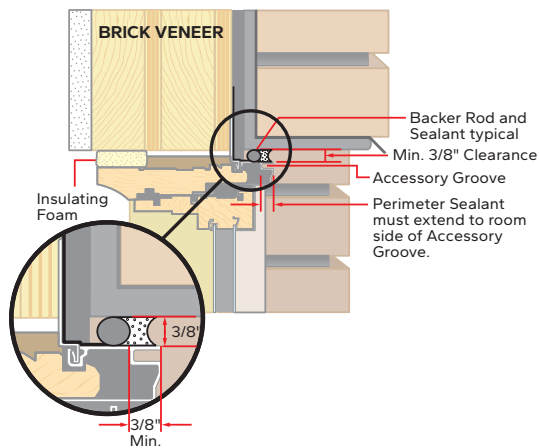
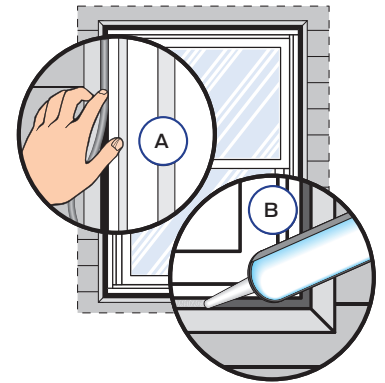

C. **Shape, tool and clean excess sealant.** When finished, the sealant should be the shape of an hourglass.





Pella® Steady Set™ Adjustable Flip and Click Bracket Instructions

TOOLS REQUIRED:

- Marker 
- Framing square or level 
- Flat head screwdriver or small pry bar 

Pella's Steady Set Interior Installation method is designed to install windows from the interior of the structure. The Flip and Click L-Brackets are designed to insert and click into each of the receivers pre-attached on the window frame, locate the window at the necessary projection within the wall assembly, and anchor the window to the wall structure. There are brackets designed for 2x4 and 2x6 wall construction with 7/16" exterior sheathing. The adjustable brackets are designed for varying wall constructions ranging from 3-1/2" to 8-3/4".

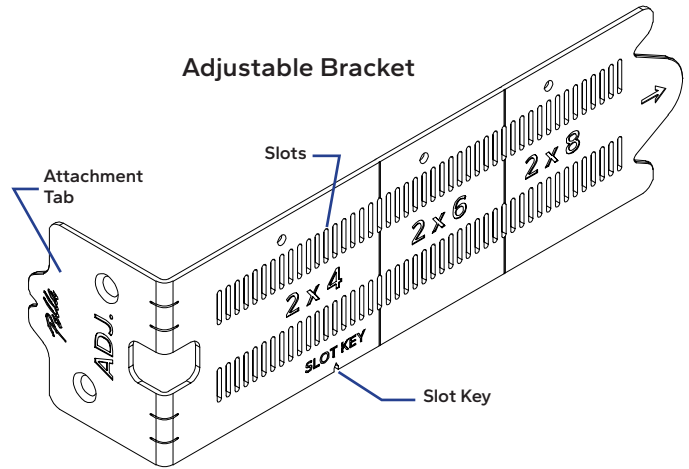

ADJUSTABLE BRACKET DIAGRAM

- A. The adjustable bracket contains 46 pairs of slots spaced at 1/8" increments.** The slots will engage the bracket receiver catch arm tabs. Select or mark the appropriate slot (refer to the instructions on the following page) necessary for the project application.
- B. The three (3) holes in the bracket align with slots that are for 2x4, 2x6, and 2x8 applications** with exterior 7/16" sheathing and interior 1/2" drywall (drywall thickness applicable if ordered with factory applied jamb extensions). The hole aligns with a notch in the receiver base, for a quick-select option for traditional or more typical wall construction depths.

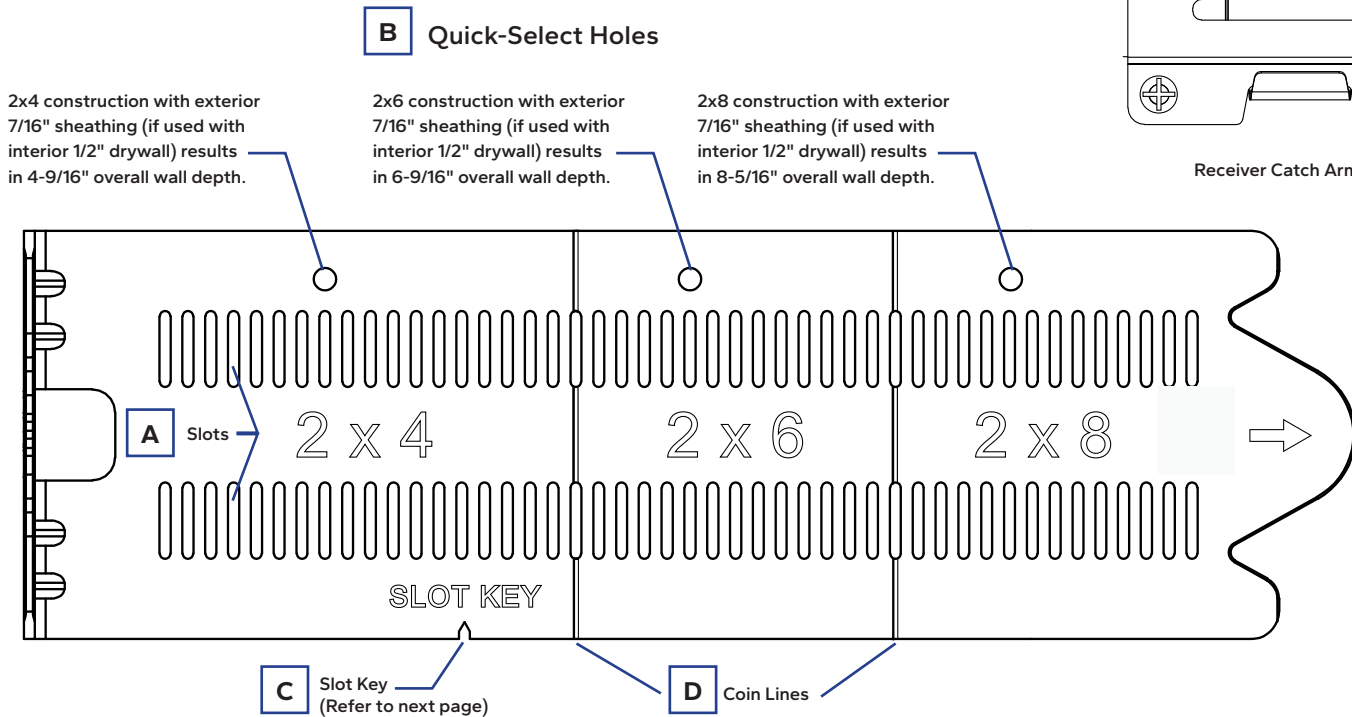
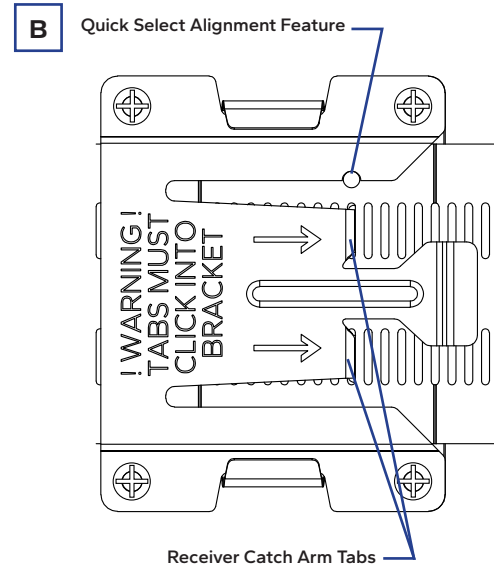

- C. The Slot Key allows the installer to use a bracket as a gauge device** to find the appropriate slot to mark on the brackets to be used for window attachment and anchoring (refer to the instructions on the following page).
- D. The two (2) coin lines allow for the bracket to be shortened for narrower wall depths.** Bend to break the bracket at the first coin line to the right of the slot (for the above bracket orientation) if required.



PELLA® STEADY SET™ – ADJUSTABLE FLIP AND CLICK BRACKET INSTRUCTIONS (CONTINUED)

HOW TO SELECT THE APPROPRIATE SLOT TO CLICK INTO RECEIVER

1. **Hold one (1) bracket**, which will be used as a gauge bracket, with the attachment tab held tight to the exterior of the wall. This should be the exterior plane of the wall that the flashing fin will be flashed and integrated with (typically the weather resistive barrier).
2. **Place another bracket**, which will be the window anchor bracket inserted later into the receiver for installation of the window, flipped 180 degrees and directly below the first bracket, with the attachment tab held tight to the interior of the wall structure. This is the interior plane of the wall that the adjustable bracket will be anchored to (typically the interior surface of the wall studs).
3. **While ensuring both tabs are held tight to each side of the wall**, mark the lower window anchor bracket slots that align with the Slot Key on the upper gauge bracket. **The marked slots on the lower bracket will be the the slots that should engage the receiver's catch arm.**

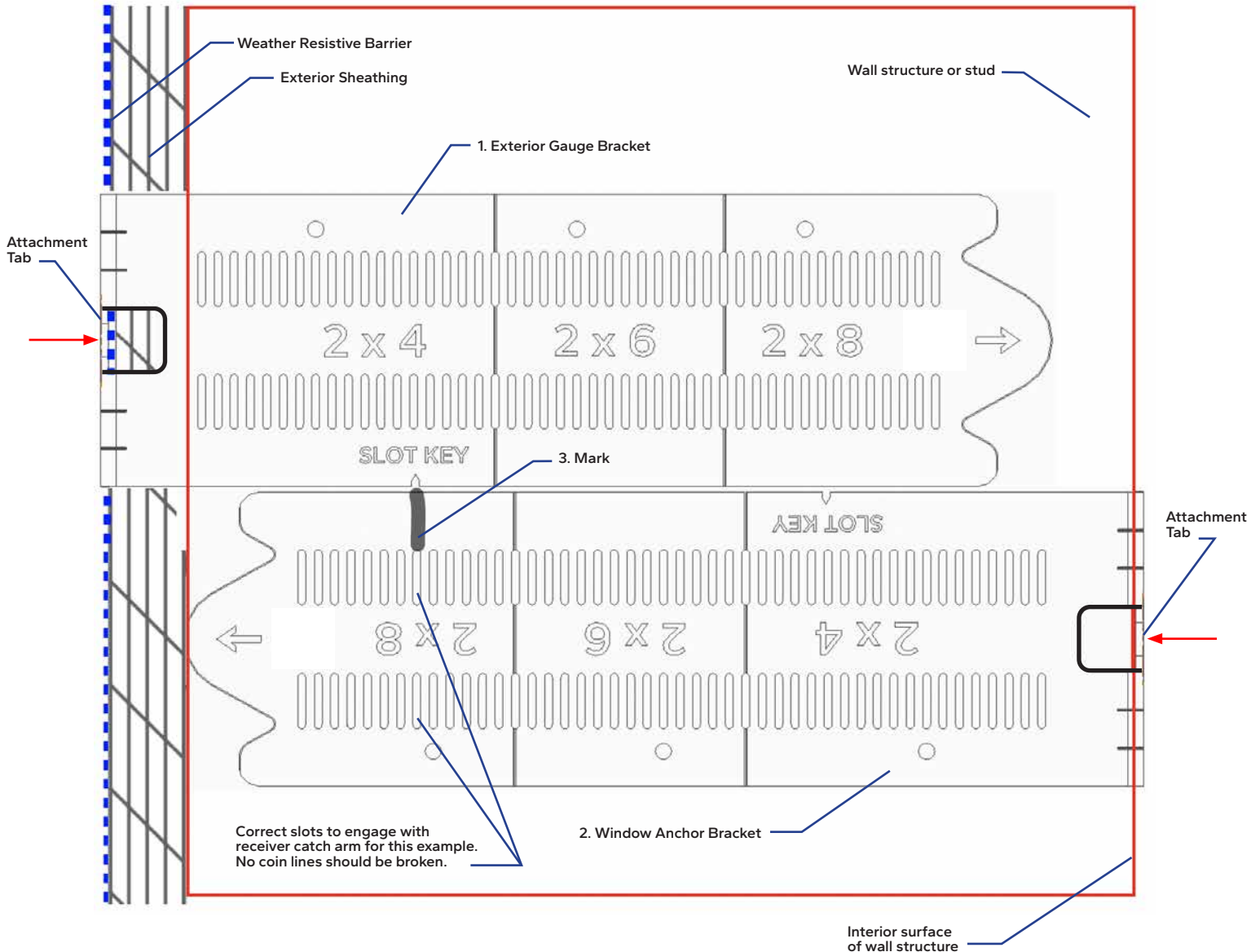



PELLA® STEADY SET™ – ADJUSTABLE FLIP AND CLICK BRACKET INSTRUCTIONS (CONTINUED)

4. **Transpose the mark to the other side of the bracket**, and mark the additional window anchor brackets necessary to complete one window install. This will allow the mark to be visible while inserting into the receiver and aligning with the receiver catch arm tabs. **TIP:** Align all bracket tabs and use a straight edge (level or framing square) to mark multiple brackets at once.

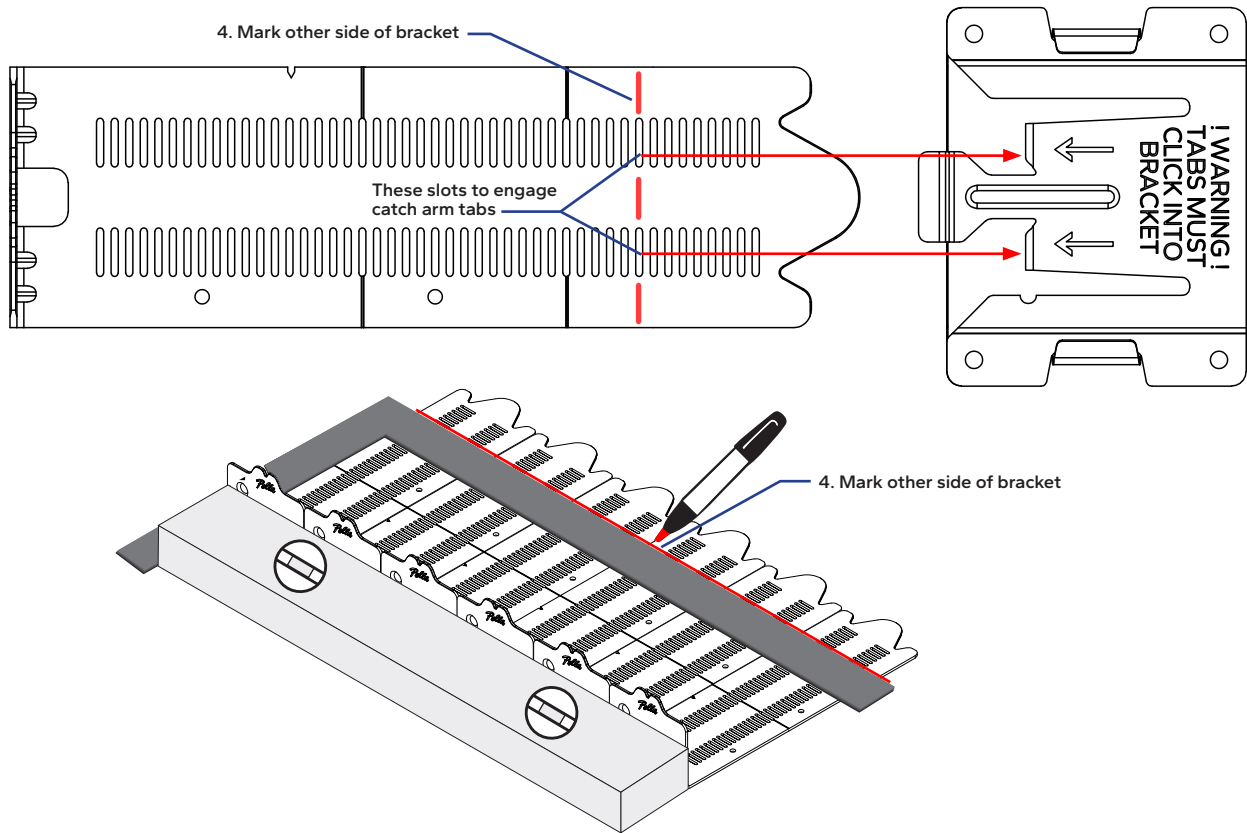

5. **Engage each bracket with the corresponding receiver catch arm tabs.**

TIP: Use a flat head screwdriver or small pry bar. Slide under the receiver catch arm and slightly twist. This helps to hold the receiver catch arm up, while selecting the appropriate slots. Take care to not over-bend or lift the catch arm tab farther than necessary, or it will not click down to properly engage the bracket slots.

6. **Install the window.** Refer to the Quick Start Guide on the glass or the installation booklet for Steady Set window installation instructions.

- A) Check for the correct interior reveal (it should match the expected drywall thickness if factory jamb extended, or measure from inside of window frame to inside of wall structure).

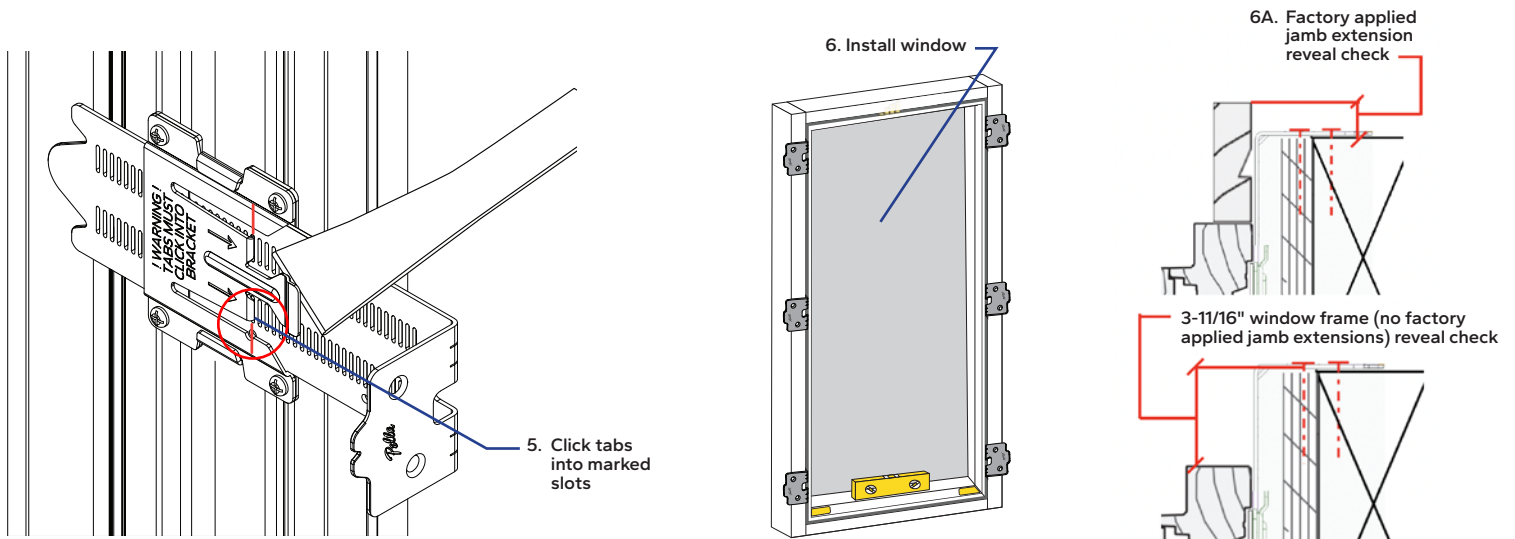

- B) Ensure the exterior flashing fin is correctly able to be integrated with the weather barrier.

Example Installation Details

2x4 Recessed Buck within 2x6 Wall Structure

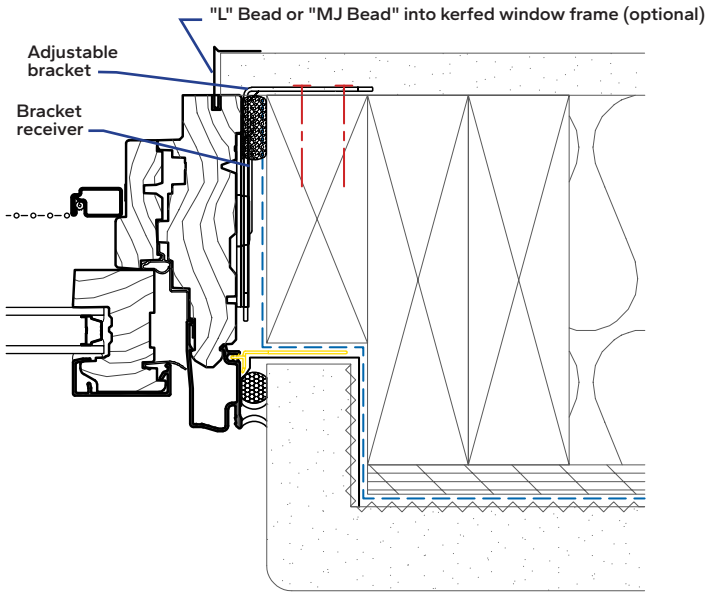

2x4 with Zip R6 Insulated Sheathing

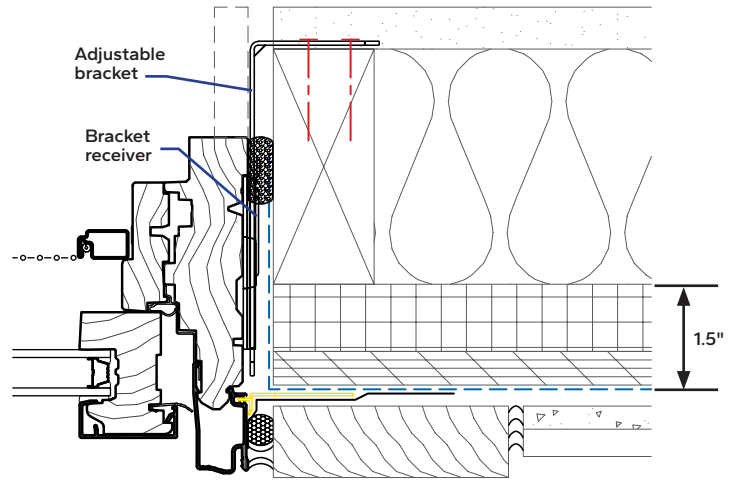

2x6 with Zip R9 and Zip 7/16" Sheathing Returned into Opening

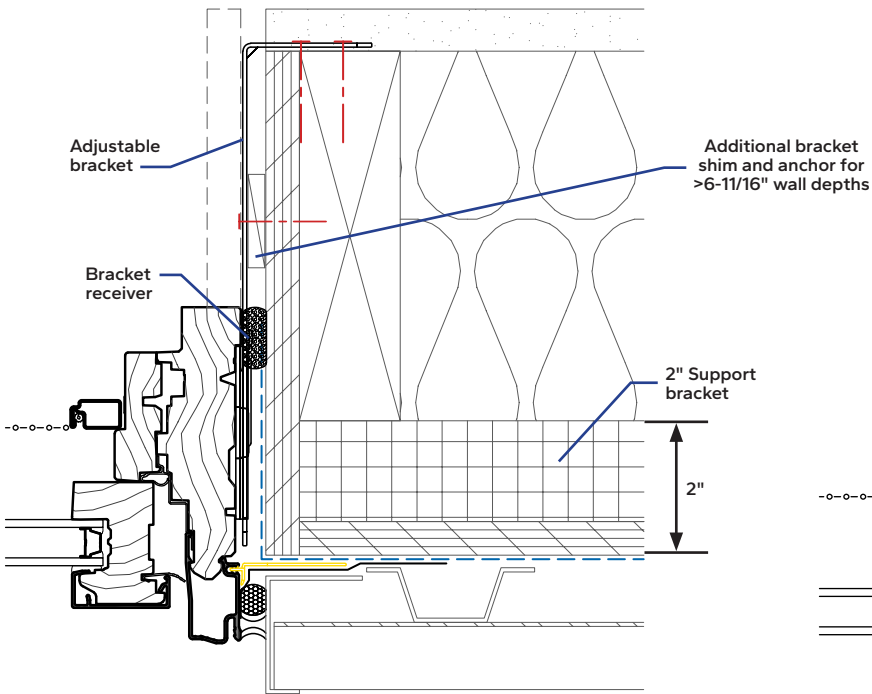

Wood Buck in Masonry Construction

