



CAUTION: Many windows in older homes are painted with lead-based paint. Removal of old windows may disturb this paint. Proper precautions must be taken to minimize exposure to dust and debris. Consult state or local authorities and/or go to www.epa.gov/lead for more information.



WARNING: To ensure safety and security and help prevent property damage, including possible damage to your window or door, close and lock windows and doors any time they are not being used for venting on a nice day, and particularly during high winds or rain.

Important Notice

Because all construction must anticipate some water infiltration, it is important that the wall system be designed and constructed to properly manage moisture. Pella Corporation is not responsible for claims or damages caused by anticipated and unanticipated water infiltration; deficiencies in building design, construction and maintenance; failure to install Pella products in accordance with Pella's installation instructions; or the use of Pella products in wall systems which do not allow for proper management of moisture within the wall systems. The determination of the suitability of all building components, including the use of Pella products, as well as the design and installation of flashing and sealing systems are the responsibility of the Buyer or User, the architect, contractor, installer, or other construction professional and are not the responsibility of Pella.

Pella products should not be used in barrier wall systems which do not allow for proper management of moisture within the wall systems, such as barrier Exterior Insulation and Finish Systems (EIFS) (also known as synthetic stucco) or other non-water managed systems. Except in the states of California, New Mexico, Arizona, Nevada, Utah and Colorado, Pella makes no warranty of any kind on and assumes no responsibility for Pella windows and doors installed in barrier wall systems. In the states listed above, the installation of Pella Products in barrier wall or similar systems must be in accordance with Pella's installation instructions. Product modifications that are not approved by Pella Corporation will void the warranty.

Care and Maintenance

Care and maintenance information is available by contacting your local Pella retailer. This information is also available at www.pella.com.

Cleaning Instructions

GLASS: Remove any protective film and labels and clean the glass, using a soft, clean, grit-free cloth and mild soap or detergent. Be sure to remove all liquid by wiping dry or use a clean squeegee.

FACTORY FINISHED PRODUCT: Pella product that has been prefinished with stain or paint from the factory requires no additional finishing. Clean the surface with mild soap and water.

PELLA® ALUMINUM CLAD OR IMPERVIA FRAMES: The interior and exterior frame and sash are protected with a tough factory finish. Clean this surface with mild soap and water. Stubborn stains and deposits may be removed with mineral spirits. **DO NOT** use abrasives. **DO NOT** scrape or use tools that might damage the surface.

ENCOMPASS BY PELLA®, PELLA® 150 SERIES AND PELLA® 250 SERIES WINDOWS FRAMES: The vinyl frame may be cleaned using the same method as the glass. For stubborn dirt, a "non-abrasive" cleaner such as Bon-Ami® or Soft Scrub® may be used. Do not use solvents such as mineral spirits, toluene, xylene, naphtha or muriatic acid as they can dull the finish, soften the vinyl and/or cause failure of the insulated unit seal. Do not use Isopropyl Alcohol on laminated surfaces as it will damage the finish. Keep door tracks clear of dirt and debris. Keep weep holes open and clear of obstructions.

DO NOT use abrasives. **DO NOT** scrape or use tools that might damage the surface.

Notice: **DO NOT** use inappropriate solvents or brickwash or cleaning chemicals. If you do, permanent damage can result and the product failure, loss or damage would not be covered by the Limited Warranty.

Interior Finish (Wood Windows)

Paint or finish immediately after installation.

If products cannot be finished immediately, cover with clear plastic to protect from dirt, damage and moisture. Remove any construction residue before finishing. Sand all wood surfaces lightly with 180 grit or finer sandpaper. **DO NOT** use steel wool. **BE CAREFUL NOT TO SCRATCH THE GLASS.** Remove sanding dust. Pella products must be finished per the below instructions; failure to follow these instructions voids the Limited Warranty.

Note: To maintain proper product performance do not paint, finish or remove the weatherstripping, mohair dust pads, gaskets or vinyl parts. Air and water leakage will result if these parts are removed. After finishing, allow venting windows and doors to dry completely before closing them. If paint, stain or finish gets on the weatherstripping, wipe it off immediately with a damp cloth.

Window Cleaning and Prep Instructions for Unfinished or Primed windows: Dry wipe dust from windows gently. Examine window for possible smudges or fingerprints made from normal handling or construction. To remove smudges, lightly wipe surface with warm water. Scuff sand with light grade sand paper or abrasive pad (220 grit or higher). Rinse surface with warm water. Let window surfaces dry completely before applying finish.

Finish the windows as soon as possible after installation.

- On casement and awnings, it is optional to paint, stain or finish the vertical and horizontal sash edges.
- On single-hungs and double-hungs, do not paint, stain or finish the vertical sash edges, any finish on the vertical sash edges may cause the sash to stick; it is optional to paint, stain or finish the horizontal sash edges.

Pella Corporation is not responsible for interior paint and stain finish imperfections for any product that is not factory-applied by Pella Corporation. For additional information on finishing see the Pella Owner's Manual or go to www.pella.com.

The use of unapproved finishes, solvents or cleaning chemicals may cause adverse reactions with door materials. Pella will not be responsible for problems caused by the use of unapproved materials. If in doubt, contact your local retailer or representative.

Exterior Finish of Existing Frame (Pocket Replacement)







It is the responsibility of the homeowner, contractor or installer to ensure any exposed unfinished wood is covered or finished. Possible methods include, however are not limited to, covering with aluminum coil stock or painting.

For Casement Hardware Installation go to: www.installpella.com/trimaccessory/hardware













PREPARING FOR NAIL FIN WINDOW INSTALLATION

YOU WILL NEED TO SUPPLY:

- Moisture resistant shims/spacers 
- Fasteners (see nail fin anchor instructions and tables at the end of this booklet) 
- Closed cell foam backer rod/sealant backer 
- Pella® SmartFlash™ foil backed butyl window and door flashing tape or equivalent 
- Low expansion, low pressure polyurethane insulating window and door foam sealant. DO NOT use high pressure or latex foams. 
- Pella Window and Door Installation Sealant or equivalent high quality, multi-purpose sealant 

TOOLS REQUIRED:

- Tape measure 
- Level 
- Square 
- Hammer 
- Stapler 
- Scissors or utility knife 
- Small flat blade screwdriver 
- Sealant Gun 
- Screw Gun with a Phillips Driver bit 
- Drill with 1/8", 5/32", 3/16" and 3/8" drill bits 
- 1/8" Allen wrench 

Other construction materials may be required. Read and understand the instructions and inspect the wall conditions before you begin.

INSTALLATION WILL REQUIRE (2) OR MORE PERSONS FOR SAFETY REASONS.

Store windows in upright position, out of direct sunlight.

ROUGH OPENING VERIFICATION

- Confirm the opening is plumb and level.

NOTE: It is critical the bottom is level and it does not slope to the interior.
- Remove dirt, oil or debris from the opening and surrounding wall surfaces.
- Confirm the window will fit the opening. Measure all four sides of the opening to make sure it is 1/2" to 3/4" larger than the window in both width and height. On larger openings measure the width and height in several places to ensure the header or studs are not bowed.

NOTE: 1-1/2" or more of solid wood blocking is typically required around the perimeter of the opening. Fix any problems with the rough opening before proceeding.
- For continuous exterior insulation panels up to 1" thick, utilize standard installation methods. For insulating panels 1.5" to 2" thick, Rough Opening Support Brackets or solid wood blocking is required.

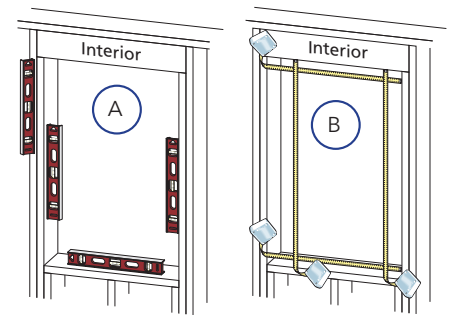

PREPARE THE WINDOW FOR INSTALLATION

- Remove plastic wrap and cardboard packaging from window. DO NOT cut checkrail bands (if present) or remove plastic or foam shipping spacers located between the window sash and frame. DO NOT open the window until it is securely fastened.
- Inspect the product for any damage such as cracks, dents or scratches. DO NOT install damaged windows.
- Remove screens and hardware (if necessary). Label them and set them aside in a protected area.

Windows with Half Screens: From the exterior, pull one side of the screen near the shipping clips until the clips disengage from the frame. Rotate the shipping clips toward the exterior of the screen until they snap free from the screen.

Half screens of some vinyl windows can be removed from the interior.
- Fold out installation fin to 90° (units with fold up fin only). Be careful not to remove or tear the fin corners.

NOTE: If the fin is not at 90°, the window will not line up correctly on the interior.
- Units with painted head drip cap fin and no pre-punched holes: Pre-drill holes through the fin (refer to the anchor page for spacing)

Curved top units with flexible fins: Prepare the window frame for attachment by pilot drilling through the frame or securing installation clips (refer to the anchor page).

Units with EnduraClad Exterior trim and narrow fins with NO pre-punched holes: Install clips or pre-drill holes for frame screws.

See the anchor instruction pages at the end of this booklet.

Additional preparation may be required for performance upgrade, impact-resistant products or to comply with local building code requirements.
- Read the entire instruction before proceeding.

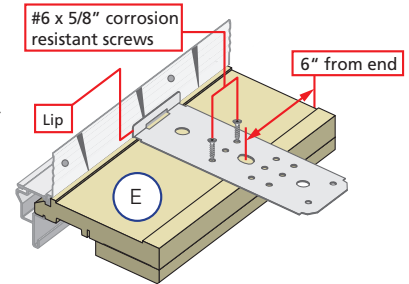
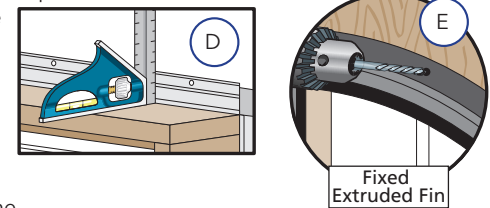
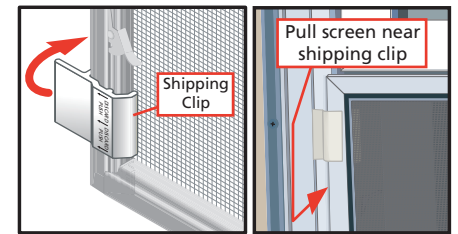

These instructions were developed and tested for use with wall systems designed to manage water. These instructions are not to be used with any other construction methods or window frame types. Installation instructions for use with other construction methods or frame types may be obtained from Pella Corporation, your local Pella® retailer or www.installpella.com. Building designs, construction methods, building materials, and site conditions unique to your project may require an installation method different from these instructions and/or additional care. Determining the appropriate installation method is the responsibility of you, your architect, or construction professional.



BY PURCHASING, INSTALLING OR USING PELLA PRODUCTS (INCLUDES PELLA GOODS AND PELLA SERVICES), YOU AGREED TO THE TERMS OF THE LIMITED WARRANTY AND YOU AND PELLA FURTHER AGREE TO ARBITRATE DISPUTES ARISING OUT OF OR RELATING TO PELLA PRODUCTS, AND YOU WAIVE ANY RIGHT TO PARTICIPATE IN A CLASS ACTION RELATED TO PELLA PRODUCTS unless you notify Pella of your decision to opt out of the Arbitration Agreement no later than ninety (90) calendar days from the date you purchased or otherwise took ownership of Your Pella Goods. Opting out of the Arbitration Agreement will not affect the coverage provided by any applicable limited warranty pertaining to Your Pella Products. For opt out information and additional details please read the Limited Warranty and Arbitration Agreement for your Pella Products at www.Pella.com/arbitration.

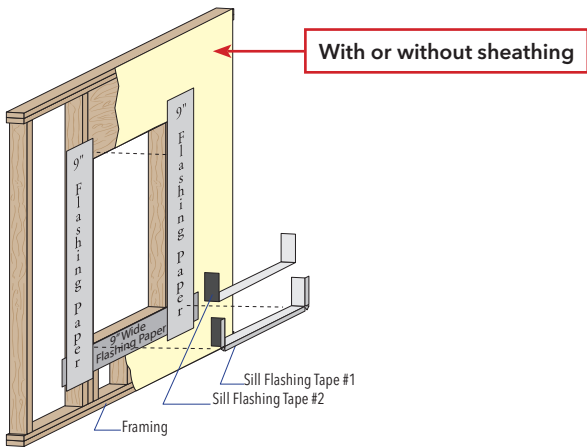

1 PREPARE THE OPENING

Refer to the nail fin installation preparation section at the beginning of this booklet.

- A. **Apply flashing paper at the bottom.** Cut one piece of 9" minimum width flashing paper 18" longer than the width of the opening. Staple it flush with the top of the sill plate.
- B. **Apply flashing paper to the sides.** Cut 2 pieces of 9" minimum width flashing paper 18" longer than the longest straight side of the opening. Center the flashing paper with the opening height and staple one piece flush with the inside edge on both sides.

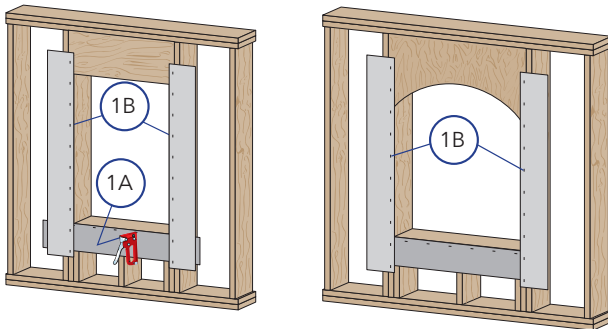

- C. **Cut 2 pieces of flashing tape 12" longer than opening width.**
- D. **Apply sill flashing tape #1** at the sill extending 1" to the exterior and 6" up each jamb.
- E. **Cut 1" wide tabs at each corner** by tearing the foil 1/2" each way from corner.
- F. **Apply sill flashing tape #2** overlapping tape #1 by 1" minimum.
NOTE: Press all tape down firmly.
- G. **Install and level sill shims.** Place 1" wide x 1/4" to 3/8" thick shims 1/2" from each side. Place additional shims under each mullion and sliding window interlocker. For vinyl windows, add shims so maximum spacing is 18".
- H. **Attach shims to prevent movement** after they are level.
NOTE: Improper placement of shims may result in bowing the bottom of the window.

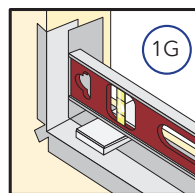
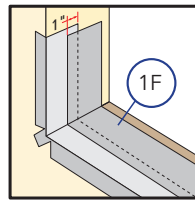
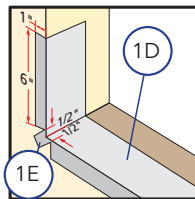

2 SETTING AND FASTENING THE WINDOW

- A. **Insert the window into the opening** on the sill spacers. Center the window between jambs.
- B. **Drive two fasteners**, one near each end of the top nailing fin. (See nail fin anchor instructions at the end of this booklet).

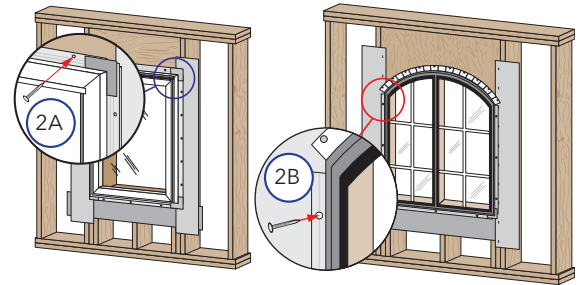

- C. **Plumb and square the window** using shims at the locations shown. Adjust shims to plumb and square the window. Keep shims 1/2" short of window frame depth.

NOTE: DO NOT shim above the window. Additional shims are required at screw locations for large units and combinations. See the nail fin anchor instructions at the end of this booklet.

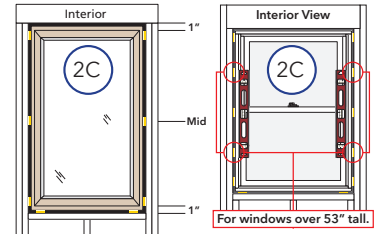

- D. **Check the window placement** by measuring from the interior surface of the window frame or jamb extension to the interior surface of the wall for consistency. If the dimensions are not equal, confirm the fins are folded fully to 90° (if applicable).

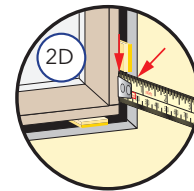

- E. **Drive two fasteners**, one near each end of the sill nailing fin.
- F. **Check window operation.**

Vent Awning and Casement: Refer to applicable hardware instructions. Unlock and open the window to remove the shipping spacers. Open and close the window to test for proper operation.

Double-Hung: Cut the checkrail bands (if applicable) and remove shipping spacers. Open, close and tilt the sashes to test for proper operation. Check for equal sash to frame reveal from top to bottom.

NOTE: Adjust shims to correct any issues with plumb, square, operation or reveal. If necessary, secure window frame to ensure window placement and sash to frame reveal is maintained.

- G. **Close and lock the window.**
- H. **Finish driving fasteners into the nailing fin.** Refer to the nail fin anchor instructions at the end of this booklet.



NEW CONSTRUCTION INSTALLATION WITH NAIL FIN BEFORE BUILDING WRAP (CONTINUED)

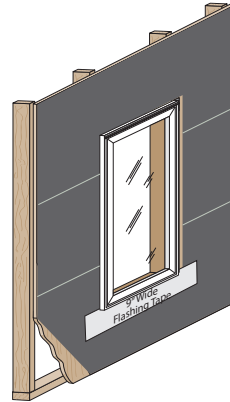
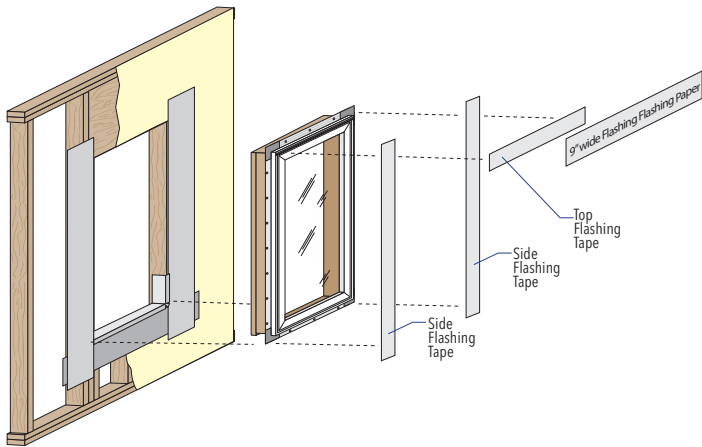

3 INTEGRATING WITH THE FLASHING PAPER

NOTE: For fold-up or slide-in fins, seal the fin to frame joint by either applying flashing tape 1/2" onto the frame, or sealing the joint with installation sealant after placing flashing tape.

Flashing Tape Option

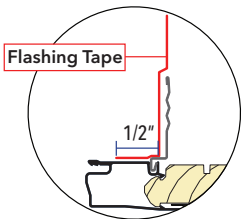

Sealant Option

(Ensure sealant compatibility with flashing materials)

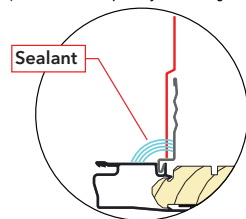

Curved and angle top units without pre-applied fin corners:

A. Cut four 1-1/2" long pieces of flashing tape.

Apply one to each end of sill fin to extend it 1-1/2" past each jamb.

Apply one to the bottom end of each jamb fin beginning 1-1/2" from the end of the fin and lapping over the first piece of flashing tape.

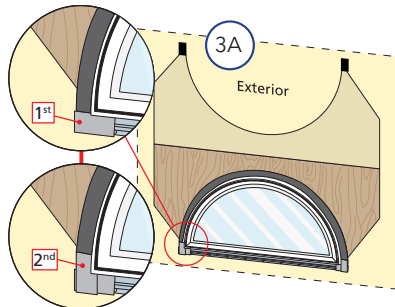

B. Apply straight side flashing tape. Cut two pieces of flashing tape 4" taller than straight sides. Apply tape over the fin and onto the flashing paper. Extend tape 2" above and below straight sides.

Angle top Units: On the short side, do not allow the side tape to extend higher than what the top tape will cover.

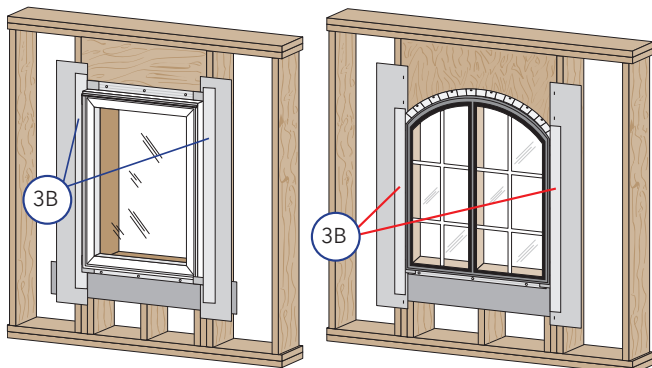

C. Apply top flashing tape.

Rectangular Units: Cut one piece of flashing tape to extend 1" past both side flashing tapes.

Curved Top Units: Using several short pieces, start taping from the sides of the window working towards the peak. Cut each piece short enough so each piece overlaps the previous piece. Tighter curved frames will require shorter pieces of tape.

NOTE: Press all flashing tape down firmly.

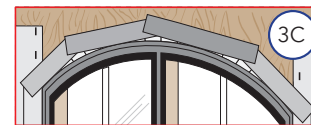
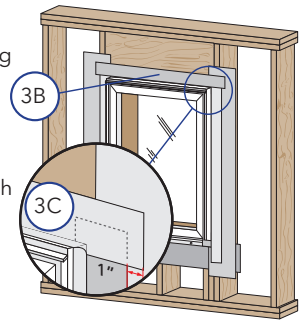

NOTE: DO NOT tape over bottom nailing fin.

D. Apply top flashing paper.

Rectangular windows: Cut one piece of 9" minimum width flashing paper 21" longer than the window width. Center it above the window and flush with the top. Staple it to the header.

Shaped windows: Cut one piece of flashing paper long enough to overlap the side flashing paper by 2" on each side. Cut the bottom of the paper to match the shape of the window (curved only). Center it above the window and flush with the top. Staple to the header. Ensure the top of the side flashing paper is completely covered by the top flashing paper on each side. Apply multiple pieces of top flashing paper if necessary, overlapping them 6" in watershed fashion.

NOTE: When apply building paper to the wall, ensure the sill flashing paper overlaps the building paper to create a watershed effect.

E. Install interior sealant. Refer to the interior sealant instructions at the end of this booklet.
F. Install head flashing, properly incorporating it with the siding and building wrap according to applicable code requirements.

G. Install exterior sealant. (After wall cladding is installed) Refer to the exterior sealant instructions at the end of this booklet.

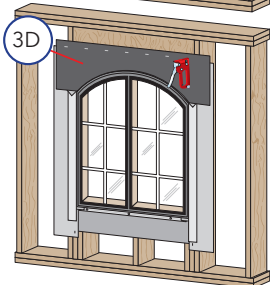
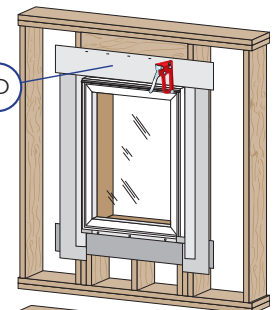
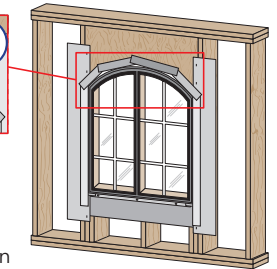



ADVANCED PERFORMANCE AND IMPACT-RESISTANT

Pella® Impact-Resistant Products have been tested in accordance with the large missile impact testing requirements of ASTM E 1886 and ASTM E 1996. Pella Impact-Resistant Products are neither hurricane proof nor are they shatter proof. Severe wind and rain may produce temporary conditions which exceed product performance standards. When these units are subjected to intense storms or extreme conditions, which exceed the intended design pressures, air, water and flying debris infiltration may occur.

Advanced performance and Impact-Resistant require the use of installation clips or screws through the frame. The use of fins or EnduraClad Exterior Trim is optional and will not affect anchorage requirements. Local building codes may have additional anchoring requirements.

Refer to FPAS installation instructions when applicable.

PLACE FRAME SCREWS OR CLIPS AT THE LOCATIONS INDICATED

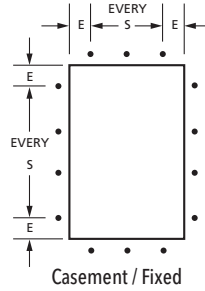

ARCHITECT SERIES® (850), IMPACT-RESISTANT WINDOW ANCHOR SPACING INSTRUCTIONS

Product	Edge Spacing (E)	Max. Intermediate Spacing (S)	Fastener	Special Notes
			Wood *	
Casement / Awning	4"	15"	#10 x 3-1/2"	
Fixed Frame	6"	10"	#10 x 3-1/2"	PG 90 up to 60" x 60". Larger sizes are PG 60

* For concrete or masonry, use 3/16" masonry screws with 1-1/4" minimum embedment. Refer to the supplemental instruction included with the unit for securing mullion end anchors (if applicable).

CASEMENT / AWNING OR FIXED FRAME

Installation Clip Attachment

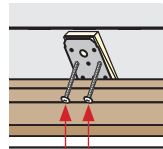
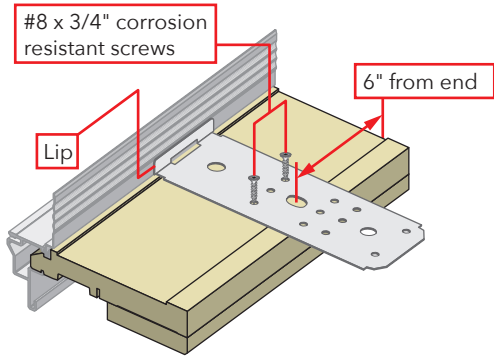

PILOT HOLE LOCATIONS AND SIZES FOR FRAME SCREWS

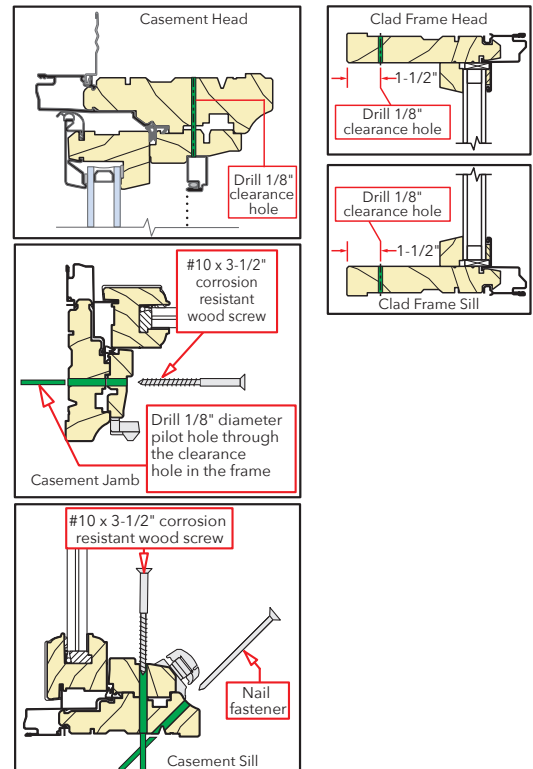



ADVANCED PERFORMANCE AND IMPACT-RESISTANT

Pella® Impact-Resistant Products have been tested in accordance with the large missile impact testing requirements of ASTM E 1886 and ASTM E 1996. Pella Impact-Resistant Products are neither hurricane proof nor are they shatter proof. Severe wind and rain may produce temporary conditions which exceed product performance standards. When these units are subjected to intense storms or extreme conditions, which exceed the intended design pressures, air, water and flying debris infiltration may occur.

Advanced performance and Impact-Resistant require the use of installation clips or screws through the frame. The use of fins or EnduraClad Exterior Trim is optional and will not affect anchorage requirements. Local building codes may have additional anchoring requirements.

Refer to FPAS installation instructions when applicable.

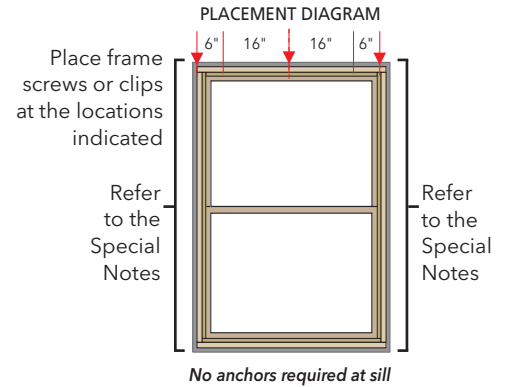

ARCHITECT SERIES® (850), IMPACT-RESISTANT WINDOW ANCHOR SPACING INSTRUCTIONS

Product	Edge Spacing (E)	Max. Intermediate Spacing (S)	Fastener	Special Notes
			Wood *	
Double, Single or Simulated Hung	6" (Head)	16" (Head)	#8 x 3"	Remove sashes and jamb covers. Drive 1 screw through each jamb liner support clip (top, bottom, checkrail and center of each sash). Drive 2 additional screws (or secure clips) 3" above and below the checkrail on each jamb. Drive additional screws (or secure clips) centered between each jamb liner support clip.

* For concrete or masonry, use 3/16" masonry screws with 1-1/4" minimum embedment. Refer to the supplemental instruction included with the unit for securing mullion end anchors (if applicable).

- Simulated-hung only:** Remove the simulated-hung lock by removing the four screws from each lock.
- Remove the lower sash.** Raise the sash 6" or more and locate the two finger slides on the lower sash check rail. At the same time, slide each toward the center of the sash to disengage the wash lock stops and pull the sash towards the room side. The sash will tilt from the bottom.
- With the sash parallel to the floor,** lift one side of the lower sash until the terminal is removed from the balance shoe. Continue to lift the sash up until the terminal is released from the opposite side of the sash and can be removed from the shoe. Lift the sash up and out of the window frame. Repeat for both sashes. Set the sash in a safe location.
- Gently pry out the bottom of the jamb** insert and remove it completely.
- Shim behind each anchor location on both jambs.**
- Drill pilot holes through** the window frame into the rough opening. Install screws.



Finger slides are located on the top, back side of the lower sash.

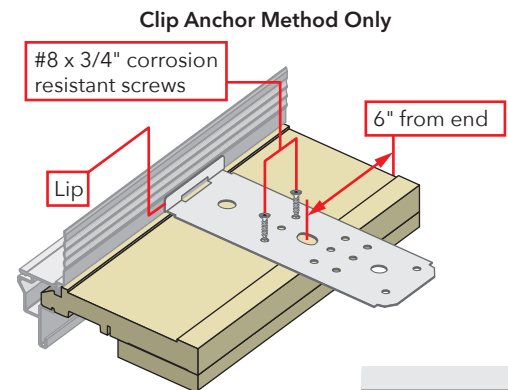
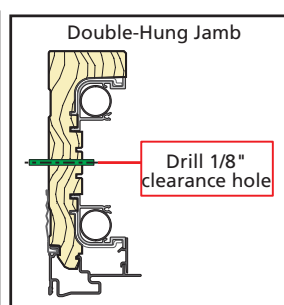
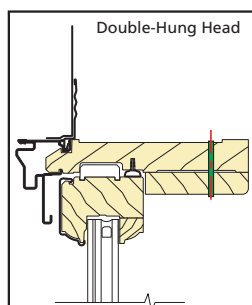
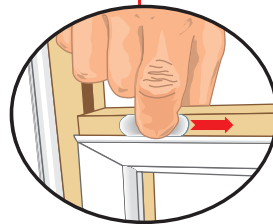

Clip option: Use clips in place of screws through frame. Screws are still required at jamb liner support clips.

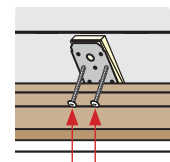

(2) #6 x 1-1/2" screws through clip into rough opening

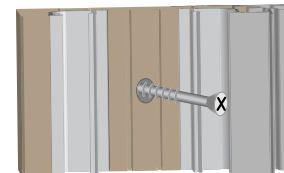

Screws through jamb

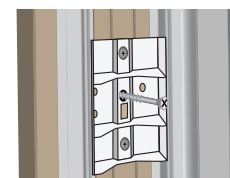

Monumental Hung jamb liner support clip



ADVANCED PERFORMANCE AND IMPACT-RESISTANT

Pella® Impact-Resistant Products have been tested in accordance with the large missile impact testing requirements of ASTM E 1886 and ASTM E 1996. Pella Impact-Resistant Products are neither hurricane proof nor are they shatter proof. Severe wind and rain may produce temporary conditions which exceed product performance standards. When these units are subjected to intense storms or extreme conditions, which exceed the intended design pressures, air, water and flying debris infiltration may occur.

Refer to FPAS installation instructions when applicable.

PELLA® IMPERVIA® SERIES

Product	Edge Spacing (E)	Max. Intermediate Spacing (S)	Fasteners*	Special Notes
Casement / Awning Vent and Fixed	6"	15"	#8 x 2" Pan Head (provided)	
Direct Set	6"	15"	#10 x 3" Pan Head (provided)	Install screws at pre-marked locations after removing interior frame covers (see below).

Units with Impact-Resistant glass for projects located in wind-borne debris regions must be anchored with frame screws or installation clips. The fin fastening (if applicable) is optional for flashing purposes.

Use factory pre-drilled holes and provided screws, if present.

*For concrete or masonry, use 3/16" masonry screws with 1-1/4" minimum embedment.

Clip Anchor Method Only

Slide clips into the frame groove and locate per the anchor spacing instructions. Use a small piece of flashing tape to hold the clips in place.

(2) # 8 x 1-1/4" screws through clip into rough opening

NOTE: Not applicable for windows with nail fin.

Screw through Frame -- Pilot Hole Location

Casement/Awning**

Direct Set***

** If an interior frame cover has a "Quick Release Band" around the cover, pull the band to help remove the cover.

*** Use putty knife; insert where indicated and slide cover to interior for removal.

PELLA® DEFENDER SERIES AND HURRICANESHIELD SERIES

Install / Frame Type	Edge Spacing (E)	Max. Intermediate Spacing (S)	Meeting Rail / Integral Mullion (M)	Special Notes
Fin	4"	8"	Varies*	Use factory pre-drilled holes, if present. Additional screws through frame may be required*.
Flange / Non Flange	6"	Varies*		

*Refer to the Florida Product Approval documents for fastener type and locations.

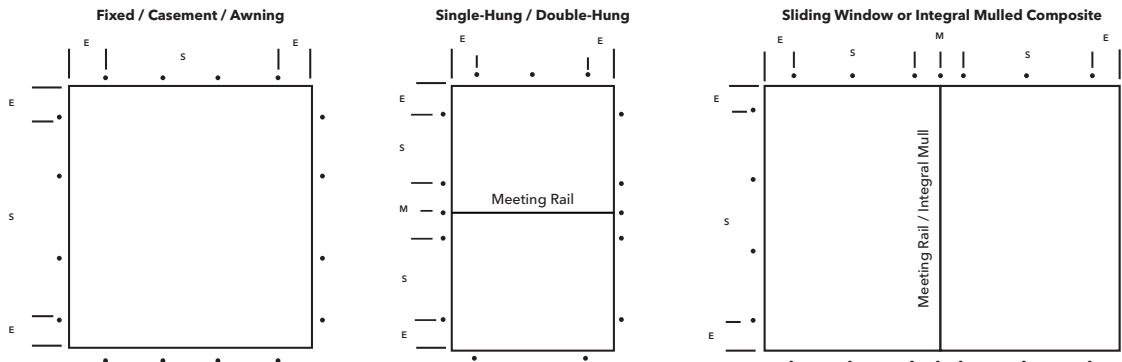

Sill fasteners may not be required*



Interior Sealant Instructions

CAUTION: Continuous backer rod (as necessary) and a high quality, low-odor interior sealant such as Pella Window and Door Installation Sealant (or equivalent) is recommended for commercial or high performance installations to create the continuous interior seal. Follow the directions on the cartridge. For standard performance or products with factory applied jamb extensions, use low pressure polyurethane insulating foams. Follow the directions on the can. Do not use high pressure or latex foams. Fiberglass batt or similar insulation is not recommended as it can absorb water and does not act as an air seal.

- A. Insert the nozzle or straw between the rough opening and window frame from the interior. Use a pliers (if necessary) to compress the end of a straw tube to allow it to fit in tight openings.
- B. Place a 1" deep bead of foam approximately 1" from the interior of the frame to allow for expansion. DO NOT fill the entire depth of the rough opening cavity.

NOTE: Apply foam between the frame and rough opening, NOT between jamb extensions and the rough opening.
- C. Re-Check window operation and remove remaining shipping spacers after foam installation. Excess foam may be removed with a serrated knife after it cures.
- D. To ensure a continuous interior seal, apply sealant over or around any shims or clips interrupting the foam seal.

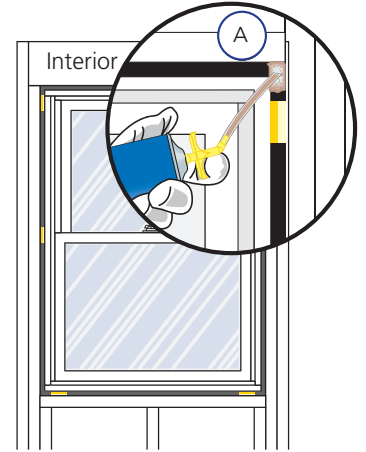

Exterior Sealant Instructions

CAUTION: Use a high quality, multi-purpose exterior sealant such as Pella Window and Door Installation Sealant. Follow the directions on the cartridge.

When applying siding, brick veneer, flashing, or other exterior finish materials, leave adequate space between the window frame and the material for sealant application.

- A. Insert backer rod 3/8" deep in the space around the window. Backer rod adds shape and controls the depth of the sealant line.
- B. Apply a continuous bead of sealant to the entire perimeter of the window. Do not block weep holes or weep hoods with sealant.
- C. Shape, tool and clean excess sealant. When finished, the sealant should be the shape of an hourglass.

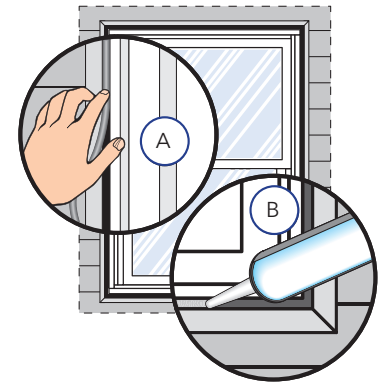

NOTE: The siding details below apply to windows without a J-mould as part of the frame. The J-mould frame is only intended for vinyl or metal sidings where the siding is extended behind the J-mould portion of the frame. The J-mould should be removed and replaced with backer rod and sealant with all other siding or trim types.

