

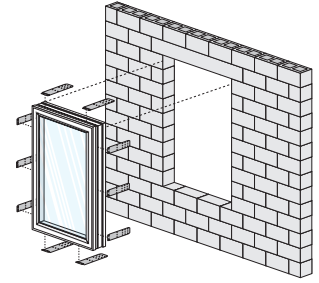

THE FOLLOWING INSTALLATION METHODS ARE INCLUDED IN THIS BOOKLET:

New Construction Installation in Masonry Construction for Block Frame Windows



Pocket Replacement from the Exterior for Block Frame Windows

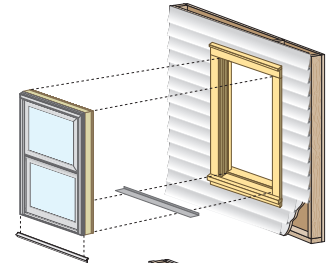

Pocket Replacement from the Interior for Renovation or Precision-Fit Windows

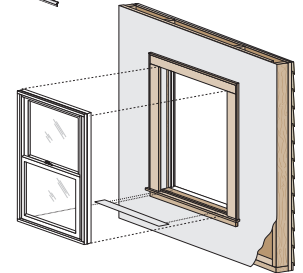

Pocket Replacement into Wood Casement Frames for Block Frame Windows

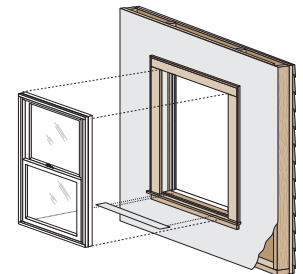

Full Frame Replacement without Disturbing Brick or Siding for Block Frame Windows

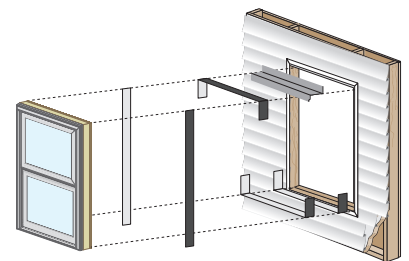

Full Frame Replacement in Masonry Construction with Stucco for Block Frame Windows

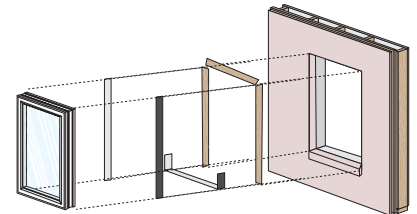

These instructions were developed and tested for use with wall systems designed to manage water. **These instructions are not to be used with any other construction methods or window frame types.** Installation instructions for use with other construction methods or frame types may be obtained from Pella Corporation, your local Pella® retailer or www.installpella.com. Building designs, construction methods, building materials, and site conditions unique to your project may require an installation method different from these instructions and/or additional care. Determining the appropriate installation method is the responsibility of you, your architect, or construction professional.



BY PURCHASING, INSTALLING OR USING PELLA PRODUCTS (INCLUDES PELLA GOODS AND PELLA SERVICES), YOU AGREED TO THE TERMS OF THE LIMITED WARRANTY AND YOU AND PELLA FURTHER AGREE TO ARBITRATE DISPUTES ARISING OUT OF OR RELATING TO PELLA PRODUCTS, AND YOU WAIVE ANY RIGHT TO PARTICIPATE IN A CLASS ACTION RELATED TO PELLA PRODUCTS unless you notify Pella of your decision to opt out of the Arbitration Agreement no later than ninety (90) calendar days from the date you purchased or otherwise took ownership of Your Pella Goods. Opting out of the Arbitration Agreement will not affect the coverage provided by any applicable limited warranty pertaining to Your Pella Products. For opt out information and additional details please read the Limited Warranty and Arbitration Agreement for your Pella Products at www.Pella.com/arbitration.



IMPORTANT SAFETY AND PRODUCT INFORMATION – WINDOW

CAUTION: Many windows in older homes are painted with lead-based paint. Removal of old windows may disturb this paint. Proper precautions must be taken to minimize exposure to dust and debris. Consult state or local authorities and/or go to www.epa.gov/lead for more information.

WARNING: To ensure safety and security and help prevent property damage, including possible damage to your window or door, close and lock windows and doors any time they are not being used for venting on a nice day, and particularly during high winds or rain.

IMPORTANT NOTICE

Because all construction must anticipate some water infiltration, it is important that the wall system be designed and constructed to properly manage moisture. Pella Corporation is not responsible for claims or damages caused by anticipated and unanticipated water infiltration; deficiencies in building design, construction and maintenance; failure to install Pella products in accordance with Pella's installation instructions; or the use of Pella products in wall systems which do not allow for proper management of moisture within the wall systems. The determination of the suitability of all building components, including the use of Pella products, as well as the design and installation of flashing and sealing systems are the responsibility of the Buyer or User, the architect, contractor, installer, or other construction professional and are not the responsibility of Pella.

Pella products should not be used in barrier wall systems which do not allow for proper management of moisture within the wall systems, such as barrier Exterior Insulation and Finish Systems (EIFS) (also known as synthetic stucco) or other non-water managed systems. Except in the states of California, New Mexico, Arizona, Nevada, Utah and Colorado, Pella makes no warranty of any kind on and assumes no responsibility for Pella windows and doors installed in barrier wall systems. In the states listed above, the installation of Pella Products in barrier wall or similar systems must be in accordance with Pella's installation instructions. Product modifications that are not approved by Pella Corporation will void the warranty.

Care and Maintenance

Care and maintenance information is available by contacting your local Pella retailer. This information is also available at www.pella.com.

Cleaning Instructions

GLASS—Remove any protective film and labels and clean the glass, using a soft, clean, grit-free cloth and mild soap or detergent. Be sure to remove all liquid by wiping dry or use a clean squeegee.

FACTORY FINISHED PRODUCT: Pella product that has been prefinished with stain or paint from the factory requires no additional finishing. Clean the surface with mild soap and water.

PELLA® ALUMINUM CLAD OR IMPERVIA FRAMES: The interior and exterior frame and sash are protected with a tough factory finish. Clean this surface with mild soap and water. Stubborn stains and deposits may be removed with mineral spirits. **DO NOT** use abrasives. **DO NOT** scrape or use tools that might damage the surface.

ENCOMPASS BY PELLA®, PELLA® 150 SERIES AND PELLA® 250 SERIES WINDOWS FRAMES: The vinyl frame may be cleaned using the same method as the glass. For stubborn dirt, a "non-abrasive" cleaner such as Bon-Ami® or Soft Scrub® may be used. Do not use solvents such as mineral spirits, toluene, xylene, naphtha or muriatic acid as they can dull the finish, soften the vinyl and/or cause failure of the insulated unit seal. Do not use Isopropyl Alcohol on laminated surfaces as it will damage the finish. Keep door tracks clear of dirt and debris. Keep weep holes open and clear of obstructions.

DO NOT use abrasives. **DO NOT** scrape or use tools that might damage the surface.

Notice: **DO NOT** use inappropriate solvents or brickwash or cleaning chemicals. If you do, permanent damage can result and the product failure, loss or damage would not be covered by the Limited Warranty.

Interior Finish (Wood Windows)

Paint or finish immediately after installation.

If products cannot be finished immediately, cover with clear plastic to protect from dirt, damage and moisture. Remove any construction residue before finishing. Sand all wood surfaces lightly with 180 grit or finer sandpaper. **DO NOT** use steel wool. **BE CAREFUL NOT TO SCRATCH THE GLASS.** Remove sanding dust. Pella products must be finished per the below instructions; failure to follow these instructions voids the Limited Warranty.

NOTE: *To maintain proper product performance do not paint, finish or remove the weatherstripping, mohair dust pads, gaskets or vinyl parts. Air and water leakage will result if these parts are removed. After finishing, allow venting windows and doors to dry completely before closing them. If paint, stain or finish gets on the weatherstripping, wipe it off immediately with a damp cloth.*

Window Cleaning and Prep Instructions for Unfinished or Primed windows: Dry wipe dust from windows gently. Examine window for possible smudges or fingerprints made from normal handling or construction. To remove smudges, lightly wipe surface with warm water. Scuff sand with light grade sand paper or abrasive pad (220 grit or higher). Rinse surface with warm water. Let window surfaces dry completely before applying finish.

Finish the windows as soon as possible after installation.

- On casement and awnings, it is optional to paint, stain or finish the vertical and horizontal sash edges.
- On single-hungs and double-hungs, do not paint, stain or finish the vertical sash edges, any finish on the vertical sash edges may cause the sash to stick; it is optional to paint, stain or finish the horizontal sash edges.

Pella Corporation is not responsible for interior paint and stain finish imperfections for any product that is not factory-applied by Pella Corporation. For additional information on finishing see the Pella Owner's Manual or go to www.pella.com.

The use of unapproved finishes, solvents or cleaning chemicals may cause adverse reactions with door materials. Pella will not be responsible for problems caused by the use of unapproved materials. If in doubt, contact your local retailer or representative.

Exterior Finish of Existing Frame (Pocket Replacement)

It is the responsibility of the homeowner, contractor or installer to ensure any exposed unfinished wood is covered or finished. Possible methods include, however are not limited to, covering with aluminum coil stock or painting.

For Casement Hardware Installation go to: www.installpella.com/trimaccessory/hardware.









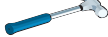

FULL FRAME REMOVAL WHEN PREPARING TO INSTALL A NEW BLOCK FRAME AND RENOVATION® / PRECISION FIT® WINDOWS

This method of Full Frame Removal involves removing the sash and entire frame of the existing window from the wall. The resulting opening is the original rough opening. The existing window nailing fins are usually nailed to the studs in frame construction with siding, brick veneer or other exterior material applied over the fin on the outside. The interior may have a drywall return from the wall to the window frame.

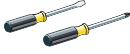
CAUTION: Many windows in older homes are painted with lead-based paint. Removal of old windows may disturb this paint. Proper precautions must be taken to minimize exposure to dust and debris. Consult state or local authorities and/or go to www.epa.gov/lead for more information.

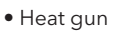
TOOLS REQUIRED:

- Utility knife 
- Pry bar 
- Hammer 
- Deglazing wheel 
- Phillips and Standard screwdrivers 
- Reciprocating saw 
- Putty knife 
- Heat gun 
- Angle Grinder with cutting wheel 

REMEMBER TO USE APPROPRIATE PERSONAL PROTECTIVE EQUIPMENT. APPLY ADHESIVE FILM OR DUCT TAPE TO THE GLASS TO PREVENT BREAKAGE.

- A. **Score the paint or varnish** between the interior trim and the wall or between the drywall return and the window frame to minimize damage.
- B. **Remove the interior trim.**

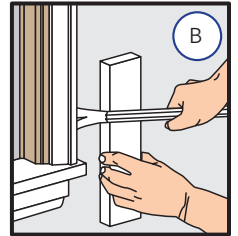

To collapse aluminum frames follow steps C-M.

To cut vinyl, clad wood, or aluminum frames out of the opening, see steps M and N.

- C. **Score the sealant** or paint between the exterior siding or brick and the window frame.
- D. **Remove the screen and vent sash** from the old window. If it is not removable, see steps G-I.
- E. **Remove the division bar** by removing the screws at the ends or cutting it with a reciprocating saw.
- F. **Remove the other sash/panel.** Remove any screws holding the fixed sash. Slide and lift out of the channel (sliding windows) or tilt and release from the balance assembly (hung windows).

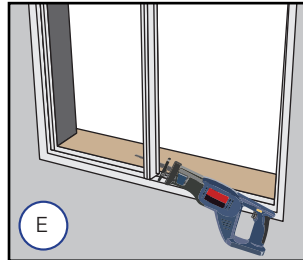

If the sashes are not removable or the glass is sealed to the frame:

- G. **Remove the glazing bead** using a putty knife or small pry bar.
- H. **For single pane windows with divided lights (grids):** Use an angle grinder with a cut-off wheel to cut the end of the bars where they intersect with the sash or frame. This will allow the window glass to be removed more quickly.
- I. **Heat the glazing seal** using an electric heat gun.

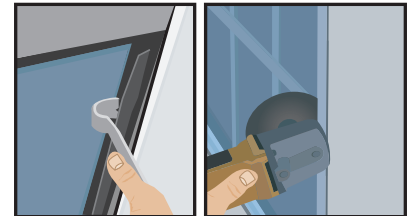

- J. **While applying heat,** press a de-glazing wheel between the glass and sash or frame. Continue around the perimeter of the sash or panel. Apply light, constant pressure to separate the glass from the sash or frame. Dispose or recycle the glass properly.

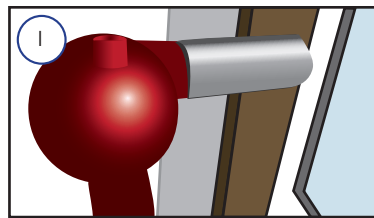

- NOTE: Wear appropriate personal protective equipment and keep the heat source away from flammable materials.**
- K. **Pry the frame away from the brick or siding.** Use a block of wood under the pry bar to protect interior or exterior finishes. Dispose or recycle the frame materials properly.
- L. **Cut through the frame** using a reciprocating saw.

Cutting out vinyl, clad wood or aluminum frames:



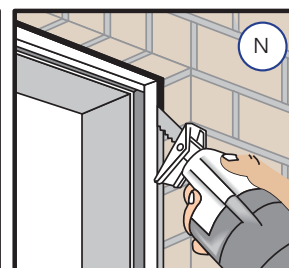
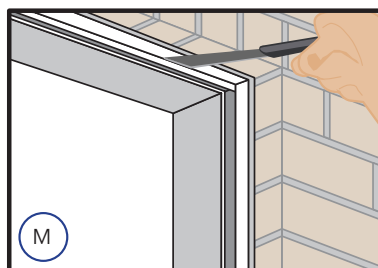

- M. **Temporarily pry any head flashing up** to avoid damaging or cutting it.
- N. **Cut through the sealant line** and nailing fin on all four sides using a reciprocating saw. Ensure the blade does not penetrate the interior where damage can occur to the drywall.













Consult with local providers and authorities to recycle or properly dispose of old window components.



YOU WILL NEED TO SUPPLY:

- Moisture resistant shims/spacers 
- Fasteners (see nail fin anchor instructions and tables at the end of this booklet)
- Closed cell foam backer rod/sealant backer 
- Pella® SmartFlash™ foil backed butyl window and door flashing tape or equivalent 
- Low expansion, low pressure polyurethane insulating window and door foam sealant. **DO NOT** use high pressure or latex foams. 
- Pella Window and Door Installation Sealant or equivalent high quality, multi-purpose sealant 

TOOLS REQUIRED:

- Tape measure 
- Level 
- Square 
- Hammer 
- Stapler 
- Scissors or utility knife 
- Small flat blade screwdriver 
- Sealant Gun 
- Screw Gun with a Phillips Driver bit 
- Drill with 1/8", 5/32", 3/16" & 3/8" drill bits
- 1/8" Allen wrench 

Other construction materials may be required. Read and understand the instructions and inspect the wall conditions before you begin.

Store windows in upright position, out of direct sunlight.

TWO OR MORE PEOPLE WILL BE REQUIRED FOR THE WINDOW INSTALLATION.

1 PREPARING FOR INSTALLATION

- Remove plastic wrap and cardboard packaging from the window.** On laminate units, remove protective film from parts. Do not cut checkrail bands (if present) or remove plastic or foam shipping spacers located between the window sash and frame. **DO NOT** open the window until it is securely fastened.
- Inspect the product for any damage** such as cracks, dents or scratches. **DO NOT** install damaged windows.
- Remove screens and hardware** (if necessary). Label them and set aside in a protected area.

Windows with Half Screens:

From the exterior, pull one side of the screen near the shipping clips until the clips disengage from the frame. Rotate the shipping clips toward the exterior of the screen until they snap free from the screen.

Half screens of some vinyl windows can be removed from the interior.

Before Installation, remove dirt and debris from all surfaces of the opening.

- Read the entire instruction before proceeding.**

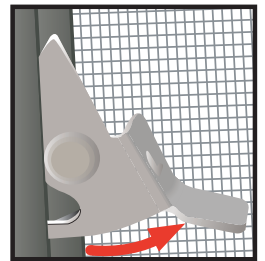

BY PURCHASING, INSTALLING OR USING PELLA PRODUCTS (INCLUDES PELLA GOODS AND PELLA SERVICES), YOU AGREED TO THE TERMS OF THE LIMITED WARRANTY AND YOU AND PELLA FURTHER AGREE TO ARBITRATE DISPUTES ARISING OUT OF OR RELATING TO PELLA PRODUCTS, AND YOU WAIVE ANY RIGHT TO PARTICIPATE IN A CLASS ACTION RELATED TO PELLA PRODUCTS unless you notify Pella of your decision to opt out of the Arbitration Agreement no later than ninety (90) calendar days from the date you purchased or otherwise took ownership of Your Pella Goods. Opting out of the Arbitration Agreement will not affect the coverage provided by any applicable limited warranty pertaining to Your Pella Products. For opt out information and additional details please read the Limited Warranty and Arbitration Agreement for your Pella Products at www.Pella.com/arbitration.



NEW CONSTRUCTION INSTALLATION IN MASONRY CONSTRUCTION FOR BLOCK FRAME WINDOWS
FOR THE INSTALLATION OF NEW BLOCK FRAME WINDOWS INTO MASONRY OPENINGS

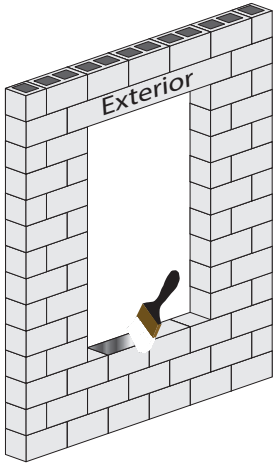

1 PREPARE THE OPENING

REMEMBER TO USE APPROPRIATE PERSONAL PROTECTIVE EQUIPMENT.

- A. **Clean the opening.** Ensure it is dry and free from dirt, oil and debris.
- B. **Apply water resistant coating** to the masonry. Extend the coating into the opening on all four sides. The water resistant coating may be a self-adhered sheet membrane (SASM) or a liquid applied flashing. Ensure continuity between the water resistant coating in the opening and the rest of the wall surface. SASM 's must be overlapped in a water shed fashion. Apply all water resistant coatings according to the manufacturer's directions.

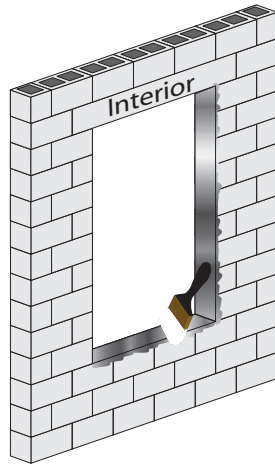

- B. **Measure the width and height of the opening.** The new window must be at least 1/2" to 3/4" smaller than this measurement.
- C. **Confirm the opening is plumb, level and square.**
- D. **Measure and mark the opening** where the interior of the new window will be placed. Consider the size of wall cavity (if applicable) and 3/4" overlap onto the brick veneer or finished wall materials for exterior perimeter sealant.

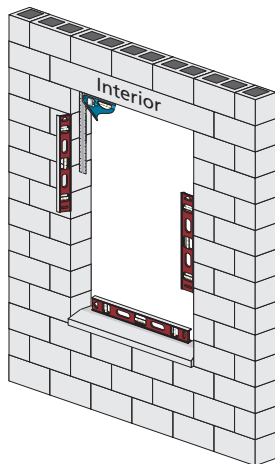
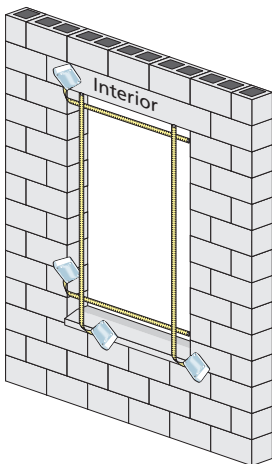

1 PREPARE THE OPENING (Continued)

- E. **Install and level sill shims.** Place 1" wide x 1/4" to 3/8" thick shims 1/2" from each side. Keep shims back 1/2" from interior face of window. Place additional shims under each mullion and sliding window interlocker. For vinyl windows, add shims so maximum spacing is 18".
- F. **Attach or set shims in adhesive sealant** to prevent movement after they are level.

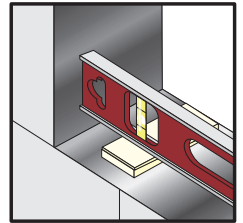

NOTE: Improper placement of shims may result in bowing the bottom of the window.

2 PREPARE THE WINDOW
FRAME SCREW INSTALLATION

- A. **Drill pilot holes** (if necessary) in the new window frame. *See the anchoring instructions at the end of this booklet.*

NOTE: WHERE POSSIBLE, USE FRAME SCREWS (NOT CLIPS) AT THE SILL TO AVOID PENETRATING THE INTERIOR SEAL.



NEW CONSTRUCTION INSTALLATION IN MASONRY CONSTRUCTION FOR BLOCK FRAME WINDOWS
FOR THE INSTALLATION OF NEW BLOCK FRAME WINDOWS INTO MASONRY OPENINGS

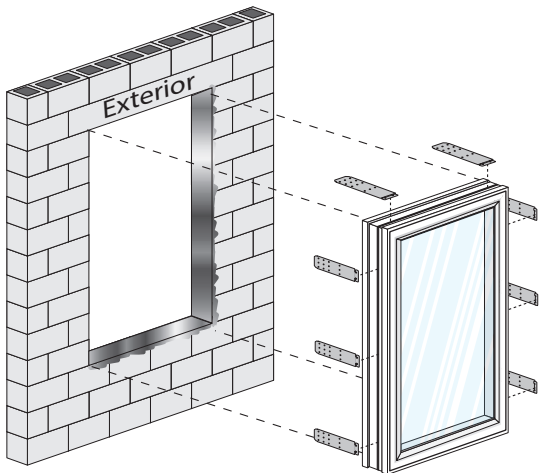

2 PREPARE THE WINDOW (Continued)

CLIP INSTALLATION

C. Pre-bend clips if anchors will be installed into the interior wall surface.

D. Secure clips to the window frame:

Pella® Impervia®:

E. Slide clips into the frame grooves. See the anchor spacing instructions at the end of this booklet.

F. Secure the clips to the frame. Use a small piece of flashing tape to prevent the clips from sliding out of place (Pella Impervia®).

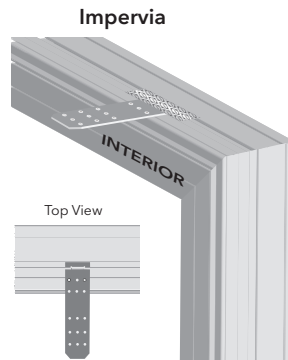

Architect Series® (850) and Pella® Lifestyle Dual-Pane Series:

G. Install the clips into the fin grooves. Start one corner of the clip in the fin groove. Tap the corner into the fin groove with a hammer, then continue to tap the other corner until the clip is locked into the groove.

H. Secure the clips to the frame. Drive one #8 x 5/8" screw through the slotted hole in the center of the clip.

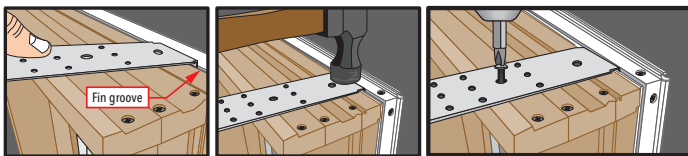

Alternatively, it is acceptable to use two #6 x 5/8" screws through the clip with the clip on its back and not engaged in the fin groove.

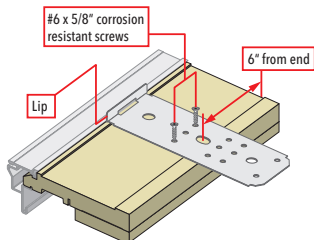

3 SET AND FASTEN THE WINDOW

A. Insert the window in the opening. Check to make sure the distance from the interior of the new window to the interior of the wall is consistent all around the window.

B. Place sealant under each clip

C. Place shims and begin driving screws at each predrilled hole in the window frame or through each clip. Install masonry screws at least 2" from wall edge.

Add additional shims at the ends of meeting rails and as necessary to ensure even reveal between the frame and sashes.

Refer to the anchoring instructions at the end of this booklet.

NOTE: Keep shims 1/2" from the interior surface of the window to allow for a continuous interior seal and 1/2" from the exterior surface of the window to allow for exterior backer rod and sealant.

D. Check window operation.

Vent Awning and Casement: Refer to applicable hardware instructions. Unlock and open the window to remove the shipping spacers. Open and close the window to test for proper operation.

Double-Hung: Cut the checkrail bands (if applicable) and remove shipping spacers. Open, close and tilt the sashes to test for proper operation. Check for equal sash to frame reveal from top to bottom.

E. Check for plumb, level, and square.

Make any necessary adjustments to shims and finish installing frame screws or clip anchors.

F. Adjust the screw jacks (if applicable) with a screwdriver. Turn clockwise to move the frame toward the sash.

Tilt the lower sash inward to locate the jamb jacks in the interior balance channel near the checkrail.

G. Install interior sealant. Refer to the interior sealant instructions at the end of this booklet. Use additional sealant around clips to prevent air and water infiltration.

H. Install exterior sealant between the window frame and the finished wall material. Refer to the exterior sealant instructions at the end of this booklet.

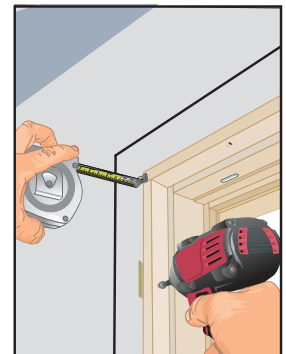
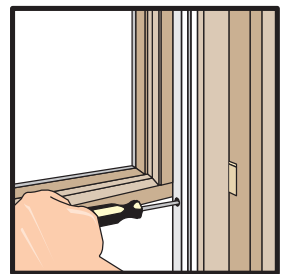
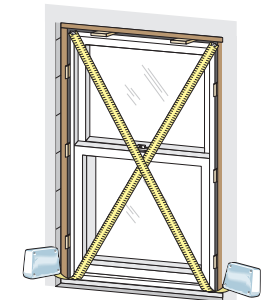



POCKET REPLACEMENT FROM THE EXTERIOR FOR BLOCK FRAME WINDOWS

INSTALLING NEW BLOCK FRAME WINDOWS IN EXISTING WOOD DOUBLE-HUNG OR SINGLE-HUNG WINDOWS

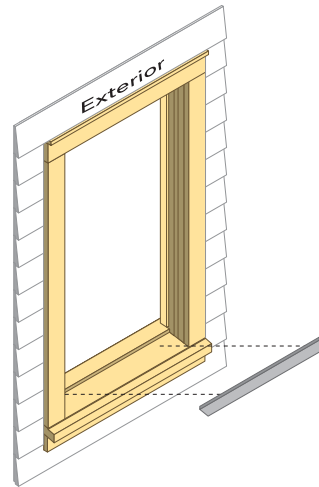
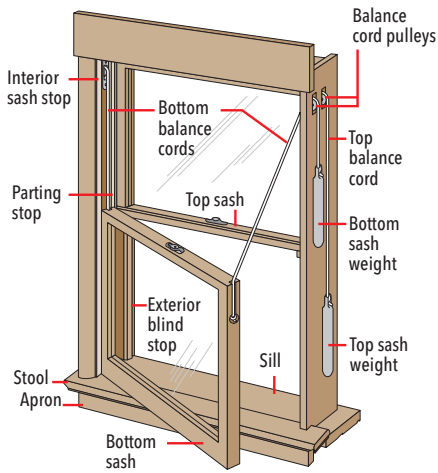

1 REMOVE THE EXISTING SASHES

CAUTION: Many windows in older homes are painted with lead-based paint. Removal of old windows may disturb this paint. Proper precautions must be taken to minimize exposure to dust and debris. Consult state or local authorities for more information.

REMEMBER TO USE APPROPRIATE PERSONAL PROTECTIVE EQUIPMENT.

- Measure the width and height of the pocket opening.** The new window must be 1/2" to 3/4" smaller than this measurement.
- Unlock the window.** If the sashes are painted shut, use a high-speed oscillating tool or a utility knife to cut the joint between the sashes and frame stops until the sashes are free.

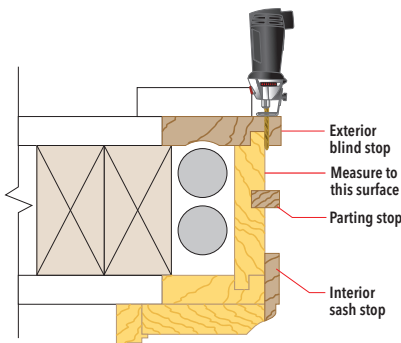

- Remove the exterior stops** at the head and jambs using a chisel, reciprocating saw, roto-tool or equivalent. Cut them flush with the side of the frame.
- Carefully remove the upper sash** and dispose of it properly.

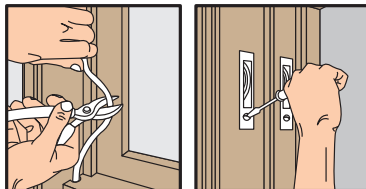

For older existing windows with weight pocket and pulley balances, cut the cords, letting the weights fall and remove the pulleys.

For windows with vinyl or aluminum jamb liners, tilt or twist the sash and release it from the balance assembly.

- Remove the head and jamb parting stops** (if applicable) by pulling or prying them out of the frame.
- Carefully remove the lower sash.**
- Remove any remaining jamb liner material** (if applicable).
Caution: Some balances are spring-loaded.
- Insulate the weight chamber** (if desired).

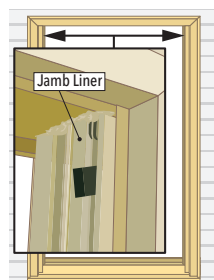
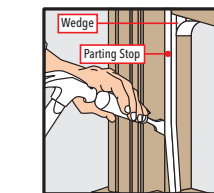

2 PREPARE THE OPENING

- Inspect the existing window frame.** Repair or replace any deteriorated parts.
- Clean the opening** of any dirt, debris or excess old paint.
Note: if using aluminum coil exterior trim, apply it now.
- Apply flashing tape to the sill.** Cut one piece of tape the same length as the sill. Extend the tape up the vertical leg of the stool. Work the tape into the corner and press firmly to adhere the tape. Lap the tape over any coil trim at the sill.
- Apply sealant over any gaps** in the corners of the existing frame.
- Check the sill for level** or for bowing.
- Install and level sill shims only if necessary to correct for bowing of the sill.** Place 1" wide x 1/4" to 3/8" thick shims 1/2" from each side. Place additional shims under each mullion and sliding window interlocker.
For vinyl windows, add shims so maximum spacing is 18".
- Attach shims to prevent movement** after they are level.
NOTE: Improper placement of shims may result in bowing the bottom of the window.

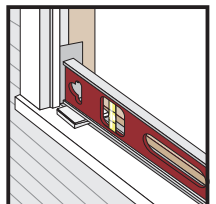
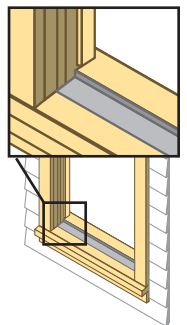

3 PREPARE THE WINDOW

See next page for Sill Adapter illustrations.

- Drill pilot holes** (if necessary) in the new window frame.
See anchoring instructions at the end of this booklet.
- Dry fit the window** in the opening.
- Measure** the distance from the bottom of the window to the existing sill. Remove the window from the opening.
- Trim the sill adapter to the correct height** (if applicable). Use a sharp utility knife to score the sill adapter along the groove. Bend and break off the excess sill adapter material.
- Install the sill adapter.** Cut it to length and notch it (if necessary).
- Dry fit the window a second time** to ensure a proper fit. Remove the window from the opening.
- Create 1/4" weep holes (Vinyl products only).** Drill or notch a weep hole 1" from each end of the sill adapter.

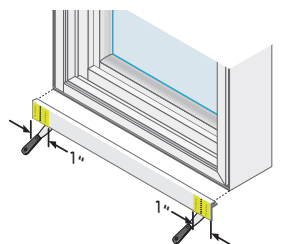
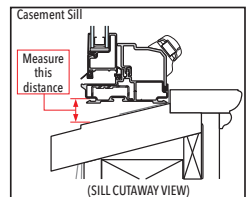



POCKET REPLACEMENT FROM THE EXTERIOR FOR BLOCK FRAME WINDOWS
INSTALLING NEW BLOCK FRAME WINDOWS IN EXISTING WOOD DOUBLE-HUNG OR SINGLE-HUNG WINDOWS

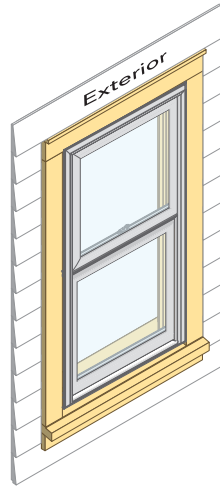
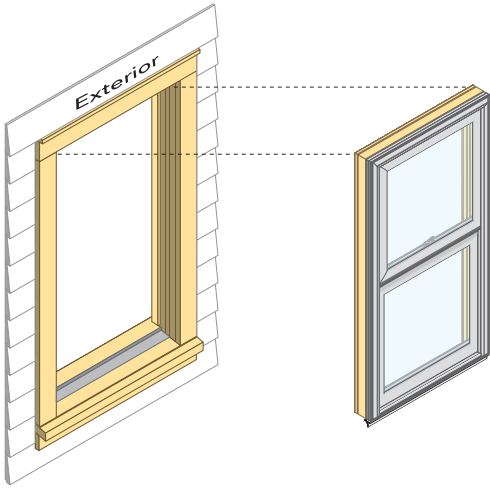

3 PREPARE THE WINDOW (Continued)

Architect Series® (850) and Pella® Lifestyle Series Dual-Pane

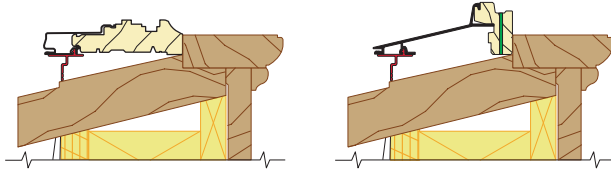

Pella® Impervia®

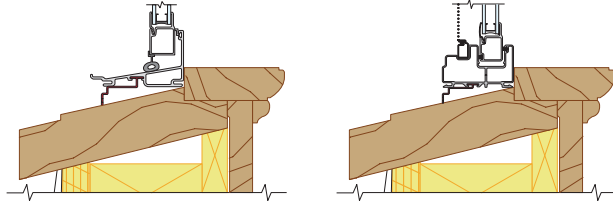

Casements and Fixed Windows:

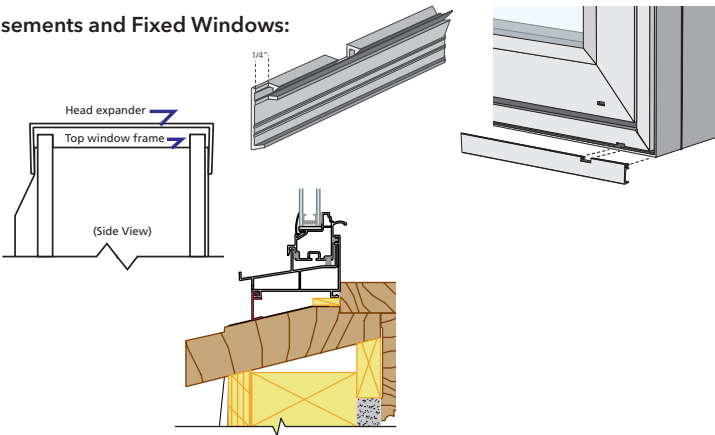

4 SET AND FASTEN THE WINDOW

A. **Apply a 3/8" bead of sealant** where the existing stool meets the existing window sill. Additionally, place sealant at the ends of the flashing tape, making sure to connect with the stool sealant.

B. **Apply a 3/8" bead of sealant** at the exterior surface of the interior head and jamb stops. Connect this bead of sealant to the sealant line on the stool.

C. **Insert the window in the opening.** Check to make sure the window rests against the interior stops and is making contact with the sealant.

D. **Place shims and begin driving screws** at each predrilled hole in the window frame.

Add additional shims at the ends of meeting rails and as necessary to ensure even reveal between the frame and sashes.

Refer to the anchoring instructions at the end of this booklet.

Ensure the window frame remains fully embedded in sealant.

NOTE: Keep shims 1/2" from the exterior surface of the window to allow for backer rod and sealant.

E. **Check window operation.**

Vent Awning and Casement: Refer to applicable hardware instructions. Unlock and open the window to remove the shipping spacers. Open and close the window to test for proper operation.

Double-Hung: Cut the checkrail bands (if applicable) and remove shipping spacers. Open, close and tilt the sashes to test for proper operation. Check for equal sash to frame reveal from top to bottom.

F. **Check for plumb, level, and square.** Make any necessary adjustments to shims and finish installing frame screws.

G. **Adjust the screw jacks** (if applicable) with a screwdriver. Turn clockwise to move the frame toward the sash.

Tilt the lower sash inward to locate the jamb jacks in the interior balance channel near the checkrail.

H. **Install interior sealant from the exterior.** Refer to the interior sealant instructions at the end of this booklet.

I. **Install exterior sealant.** Refer to the exterior sealant instructions at the end of this booklet.

J. **Install exterior frame expanders** at this time (if necessary).

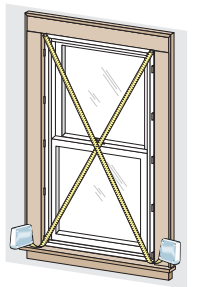
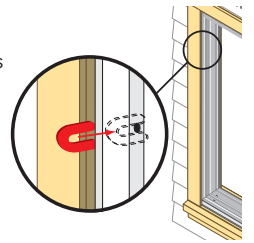
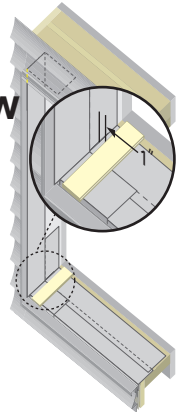



POCKET REPLACEMENT FROM THE INTERIOR FOR RENOVATION OR PRECISION-FIT WINDOWS
INSTALLING NEW RENOVATION OR PRECISION FIT WINDOWS IN EXISTING WOOD DOUBLE-HUNG OR SINGLE-HUNG WINDOWS

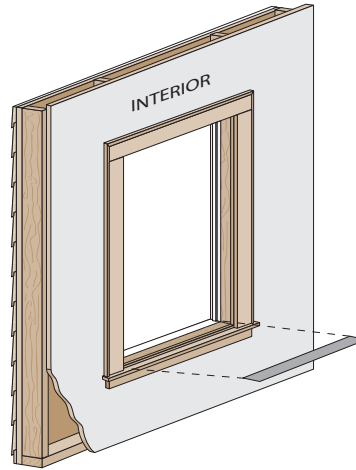
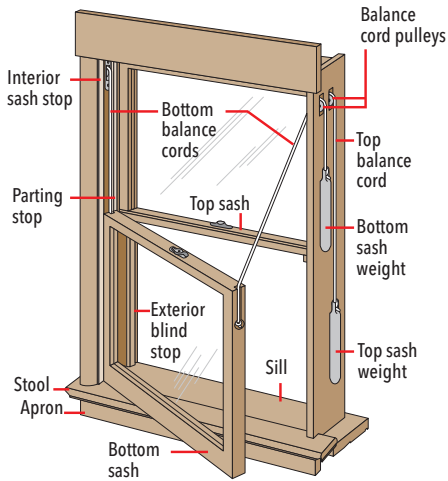

1 REMOVE THE EXISTING SASHES

CAUTION: Many windows in older homes are painted with lead-based paint. Removal of old windows may disturb this paint. Proper precautions must be taken to minimize exposure to dust and debris. Consult state or local authorities for more information.

REMEMBER TO USE APPROPRIATE PERSONAL PROTECTIVE EQUIPMENT.

A. Measure the width and height of the pocket opening. The new window must be 1/2" to 3/4" smaller than this measurement.

NOTE: A head expander (available for vinyl units) can increase the new window frame height by 3/8". If more than 3/8" height adjustment is needed, install a continuous shim at the sill or order a taller window.

B. Unlock the window. If the sashes are painted shut, use a high-speed oscillating tool or a utility knife to cut the joint between the sashes and frame stops until the sashes are free.

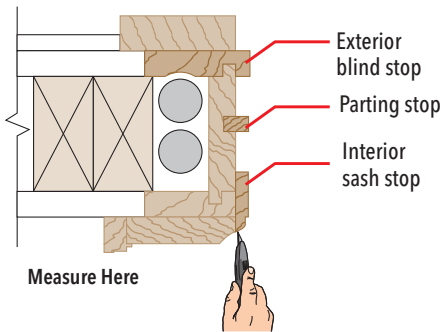

C. Score paint or varnish along interior sash stops with a sharp utility knife. Remove the interior sash stops at jambs (sides) and head (top) using a putty knife and pry bar.

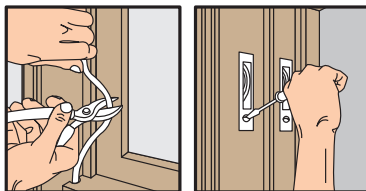

D. Cut the balance cords on the bottom sash and lift out the sash and dispose of it properly. Allow weights to fall to the bottom of the weight pocket.

E. Remove the head and jamb parting stops (if applicable) by pulling or prying them out of the frame. If a wedge block is holding the upper sash in place, remove it with a hammer and chisel.

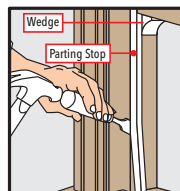

F. Lower the top sash and cut the balance cords. Remove the top sash and dispose of it properly.

G. Remove the balance chord pulleys.

H. Remove any remaining jamb liner material (if applicable).

I. Insulate the weight chamber (if desired).

2 PREPARE THE OPENING

A. Inspect the existing window frame. Repair or replace any deteriorated parts.

B. Clean the opening of any dirt, debris or excess old paint. **Note:** if using aluminum coil exterior trim, apply it now.

C. Apply flashing tape to the sill. Cut one piece of tape the same length as the sill. Extend the tape up the vertical leg of the stool. Work the tape into the corner and press firmly to adhere the tape. Lap the tape over any coil trim at the sill.

D. Check the sill for level or for bowing.

E. Install and level sill shims. Place 1" wide x 1/4" to 3/8" thick shims 1/2" from each side. Keep shims back 1/2" from interior face of window. Place additional shims under each mullion and sliding window interlocker.

For vinyl windows, add shims so maximum spacing is 18".

F. Attach shims to prevent movement after they are level.

NOTE: Improper placement of shims may result in bowing the bottom of the window.

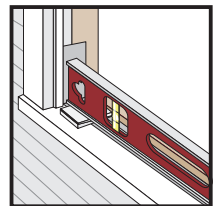
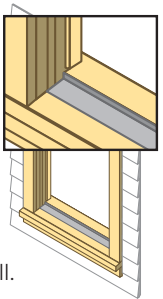

3 PREPARE THE WINDOW

A. Drill pilot holes (if necessary) in the new window frame.

B. Install the head adapter (if necessary). Do not extend it more than 3/8" above the top of the window frame.

See anchoring instructions at the end of this booklet.

C. Dry fit the window in the opening.

D. Measure the distance from the bottom of the window to the existing sill. Remove the window from the opening.

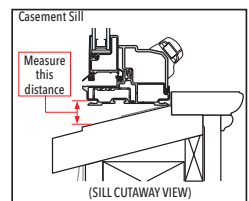

E. Install the sill adapter. Cut it to length and notch it (if necessary).

F. Trim the sill adapter to the correct height (if applicable). Use a sharp utility knife to score the sill adapter along the groove. Bend and break off the excess sill adapter material.

NOTE: Architect Series (850) double-hung windows have adjustable sill adapters for slopes of 13 degrees or more. Remove this sill adapter if the slope is less than 13 degrees.

G. Dry fit the window a second time to ensure a proper fit. Remove the window from the opening.

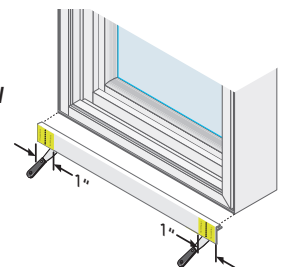

H. Create 1/4" weep holes (Vinyl products only). Drill or notch a weep hole 1" from each end of the sill adapter.

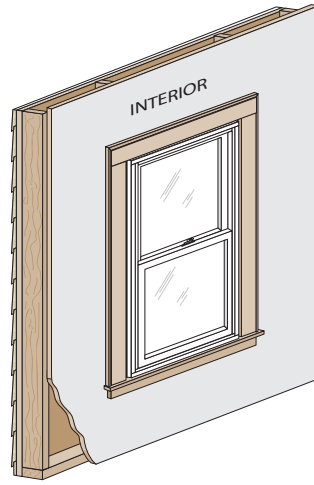
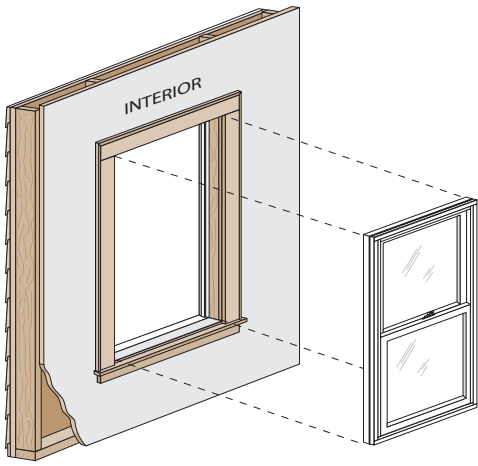

3 PREPARE THE WINDOW (Continued)

Architect Series® (850) and Precision Fit

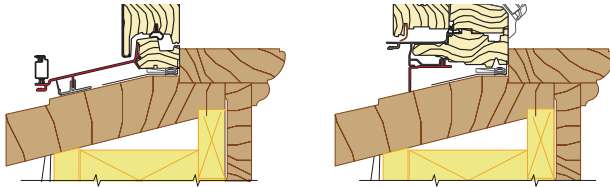

Pella® Impervia®

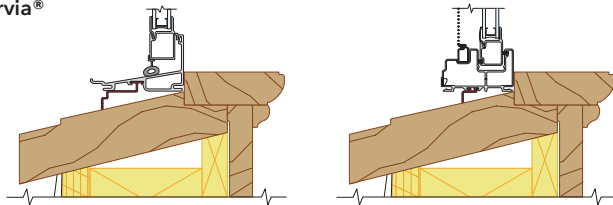

Casements and Fixed Windows:

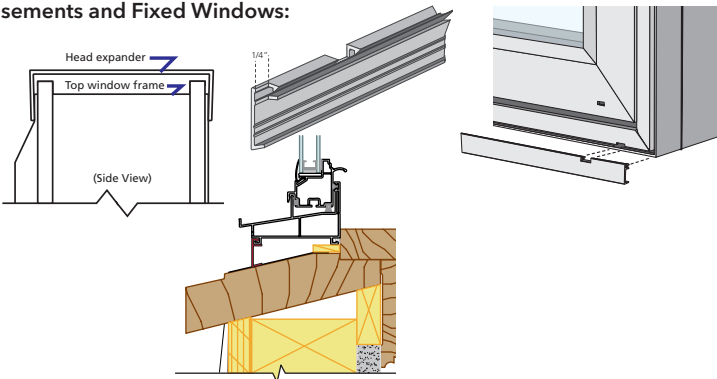

4 SET AND FASTEN THE WINDOW

- Apply a 3/8" continuous bead of sealant to the interior face of the existing blind stops at the head and both jambs.
- Place a bead of sealant where the existing stool meets the existing window sill.
- Place a bead of sealant at the end of the flashing tape, connecting the sealant beads.
- Insert the window in the opening. Check to make sure the window rests against the exterior stops at head and jambs and is making contact with the sealant.

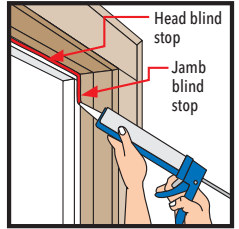

- Place shims and begin driving screws at each predrilled hole in the window frame. Add additional shims at the ends of meeting rails and as necessary to ensure even reveal between the frame and sashes.

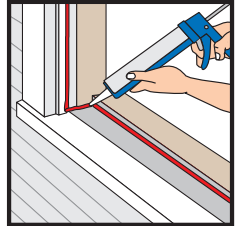

Refer to the anchoring instructions at the end of this booklet.

Ensure the window frame remains fully embedded in sealant.

NOTE: Keep shims 1/2" from the interior surface of the window to allow for a continuous interior seal.

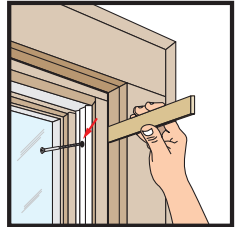

- Check window operation.

Vent Awning and Casement: Refer to applicable hardware instructions. Unlock and open the window to remove the shipping spacers. Open and close the window to test for proper operation.

Double-Hung: Cut the checkrail bands (if applicable) and remove shipping spacers. Open, close and tilt the sashes to test for proper operation. Check for equal sash to frame reveal from top to bottom.

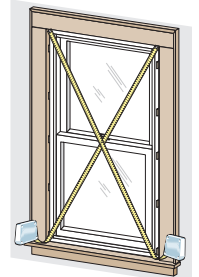

- Check for plumb, level, and square. Make any necessary adjustments to shims and finish installing frame screws.
- Adjust the screw jacks (if applicable) with a screwdriver. Turn clockwise to move the frame toward the sash. Tilt the lower sash inward to locate the jamb jacks in the interior balance channel near the checkrail.

- Install interior sealant. Refer to the interior sealant instructions at the end of this booklet.
- Install exterior sealant. Refer to the exterior sealant instructions at the end of this booklet.
- Install exterior frame expanders at this time (if necessary).



- Re-install interior stops.



POCKET REPLACEMENT INTO WOOD CASEMENT FRAMES FOR BLOCK FRAME WINDOWS
FOR THE INSTALLATION OF NEW BLOCK FRAME WINDOWS INTO EXISTING WOOD CASEMENT FRAMES

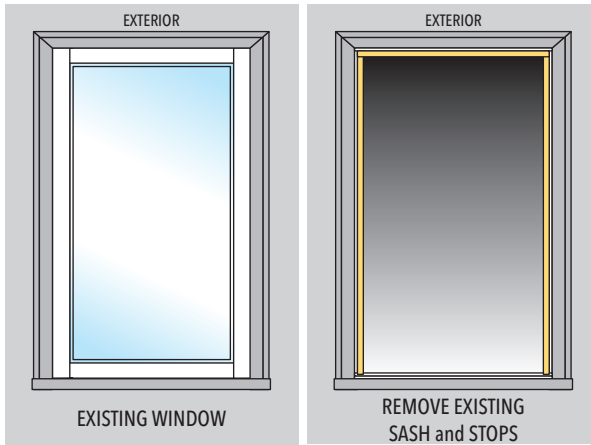

1 REMOVE THE EXISTING SASHES

CAUTION: Many windows in older homes are painted with lead-based paint. Removal of old windows may disturb this paint. Proper precautions must be taken to minimize exposure to dust and debris. Consult state or local authorities for more information.

REMEMBER TO USE APPROPRIATE PERSONAL PROTECTIVE EQUIPMENT.

- A. **Open the existing window** and measure the width and height of the opening which will remain after the frame stops are removed. The new window must be 1/2" to 3/4" smaller than this measurement.

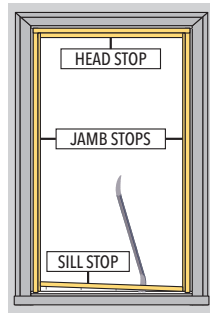
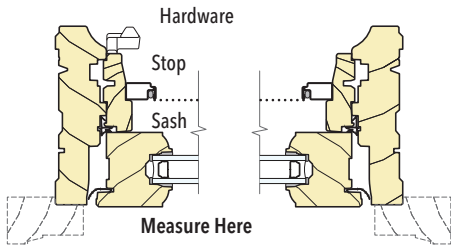

- B. **Remove the existing sash** by removing the screws attaching the sash to the hinges and operating hardware. This will vary by manufacturer of the existing window.
- C. **Remove head, jamb and sill stops** with a pry-bar. Pry between the frame and stops from the exterior to avoid damaging the interior trim.
- D. **Remove any remaining hardware** from the existing frame by removing any remaining screws.

For single windows or factory mullioned combinations being installed into existing, wood exterior, multi-wide openings, follow steps E-G to remove the mullion and secure the existing frame.

DO NOT follow these steps for metal or vinyl clad existing windows.

- E. **Drill 1/8" clearance holes** through the existing frame 6" from each existing mullion at the head and sill.
- F. **Drive #8x3" flat head wood screws** into each pre-drilled hole to secure the existing frame.
- G. **Cut the existing mullion** at each end using a reciprocating saw and dispose of it properly.

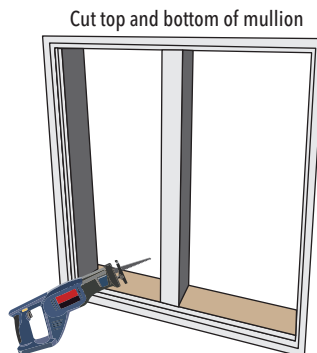

2 PREPARE THE OPENING

- A. **Inspect the existing window frame.** Repair or replace any deteriorated parts.
- B. **Clean the opening** of any dirt, debris or excess old paint

Note: if using aluminum coil exterior trim, apply it now.

- C. **Apply flashing tape to the sill.** Cut on piece of tape 12" longer than the sill. Extend the tape 6" up each jamb. Lap the tape over any coil trim at the sill.
- D. **Check the sill for level or for bowing.**
- E. **Install and level sill shims.** Place 1" wide x 1/4" to 3/8" thick shims 1/2" from each side. Keep shims back 1/2" from interior face of window. Place additional shims under each mullion and sliding window interlocker.

For vinyl windows, add shims so maximum spacing is 18".

- F. **Attach shims to prevent movement** after they are level.

NOTE: Improper placement of shims may result in bowing the bottom of the window.

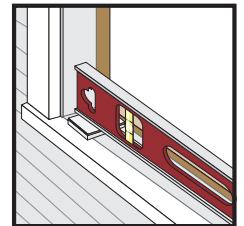
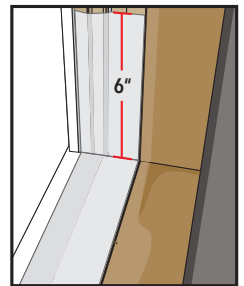

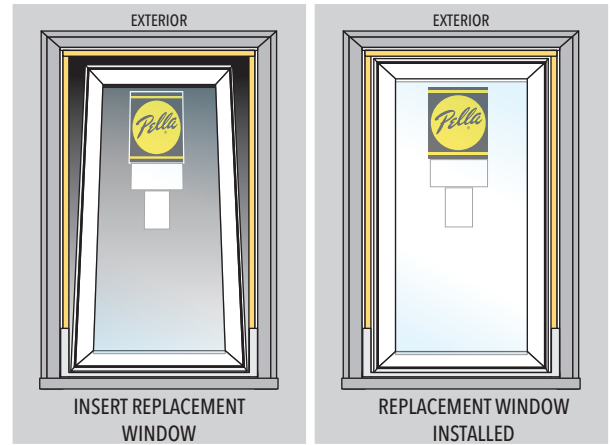

3 PREPARE THE WINDOW

- A. Drill pilot holes (if necessary) in the new window frame.
See the screw spacing instructions at the end of this booklet.
- B. Dry fit the window in the opening.

This space intentionally left blank.

4 SET AND FASTEN THE WINDOW

- A. **Insert the window in the opening.** Check to make sure the distance from the interior of the new window to the interior of the existing window is consistent all around the window.
- B. **Place shims and begin driving screws** at each predrilled hole in the window frame. Add additional shims at the ends of meeting rails and as necessary to ensure even reveal between the frame and sashes.
Refer to the anchoring instructions at the end of this booklet.

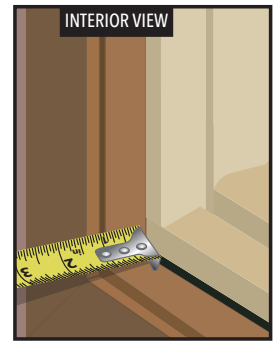

NOTE: *Keep shims 1/2" from the interior surface of the window to allow for a continuous interior seal and 1/2" from the exterior surface of the window to allow for exterior backer rod and sealant.*

- C. **Check window operation.**
Vent Awning and Casement: Refer to applicable hardware instructions. Unlock and open the window to remove the shipping spacers. Open and close the window to test for proper operation.

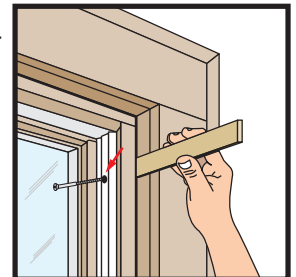

Double-Hung: Cut the checkrail bands (if applicable) and remove shipping spacers. Open, close and tilt the sashes to test for proper operation. Check for equal sash to frame reveal from top to bottom.

- D. **Check for plumb, level, and square.** Make any necessary adjustments to shims and finish installing frame screws.
- E. **Adjust the screw jacks** (if applicable) with a screwdriver. Turn clockwise to move the frame toward the sash.
 Tilt the lower sash inward to locate the jamb jacks in the interior balance channel near the checkrail.

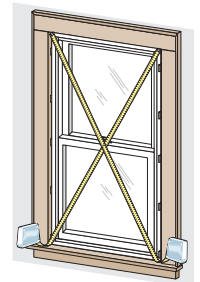

- F. **Install interior sealant.** Refer to the interior sealant instructions at the end of this booklet.
- G. **Install exterior sealant.** Refer to the exterior sealant instructions at the end of this booklet.
- H. **Install exterior frame expanders** at this time (if applicable).
- I. **Install interior trim to cover** the space between the new window frame and the old window frame.

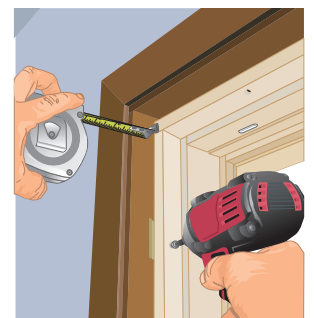



FULL FRAME REPLACEMENT WITHOUT DISTURBING BRICK OR SIDING FOR BLOCK FRAME WINDOWS
FOR USE IN BRICK OR SIDING WITH TRIM/J-TRIM AFTER THE COMPLETE REMOVAL OF A NAIL FIN WINDOW

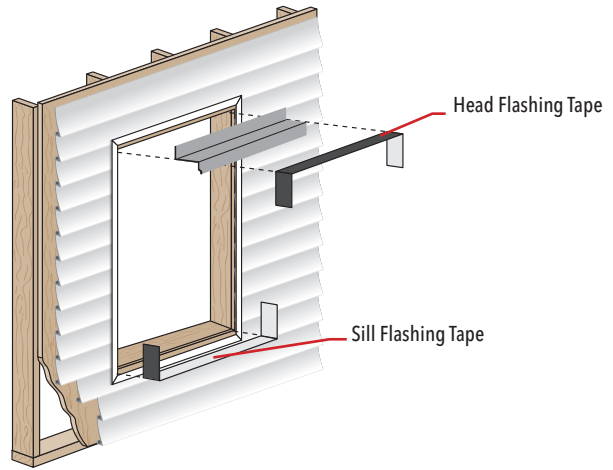
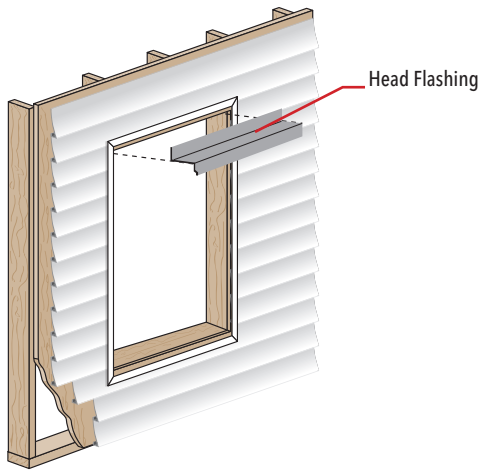

1 PREPARE THE OPENING

Refer to the full frame removal instructions at the beginning of this booklet.

- A. Measure the width and height of the opening in the brick or siding (A). The window must be at least 1/2" smaller in width and height.
- B. Measure width and height of the opening in the wood framing or masonry (B). The window must be at least 1/2" smaller in width and height.

If the interior trim or return materials have been removed, skip to step 2A.

- C. Measure the width and height of the opening in the drywall return/stool (C) (if applicable).
- D. Measure the depth from the drywall to the exterior of the siding (if applicable). Compare this to the new window frame depth.

If the window is larger than the drywall return opening (C) and has a frame depth less than (D), it can typically be installed against the exterior edge of the drywall return. If the frame depth is larger than D, cut the drywall back with a utility knife and straight edge enough to allow the window to fit within the (D) depth. Note: Interior shades/blinds may have to be moved to the interior.

If the window is smaller than the drywall return opening, add treated blocking to the opening until the opening is approx. 1/2" larger in width and height than the window (see steps 3H-3L).

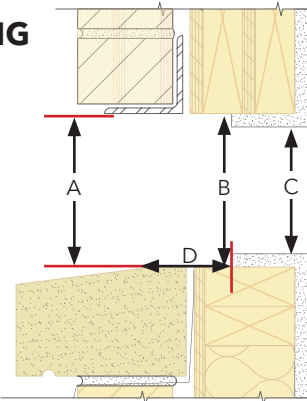

2 FLASH THE OPENING (Continued)

No Building Wrap

- D. Prepare head flashing with no up-turned leg by cutting it the same width as the brick/siding opening. The head flashing should not extend past the interior of the window frame.
- E. Apply (2) 3/16" beads of sealant. One at the interior edge of the flashing and one along the exterior edge of the sheathing.
- F. Apply a 3/16" bead of sealant at each corner connecting the two beads from step 2E.
- G. Secure the flashing to the opening over the sealant using roofing nails or corrosion resistant pan head screws at 12" max. spacing.

Important: The flashing must slope to the exterior.

Flashing may be installed before blocking at head (if required).

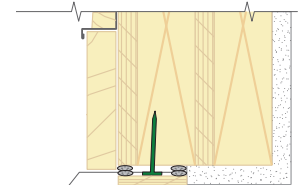
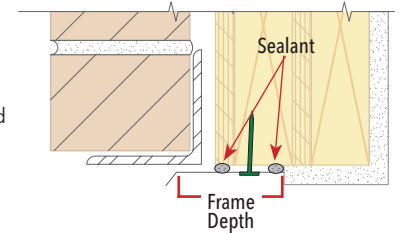

"Z" shaped flashing may be appropriate for some applications.

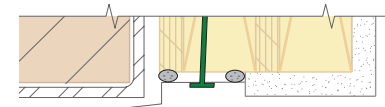

2 FLASH THE OPENING

Note: If there is an existing, functioning head flashing or if the opening is directly below a soffit or overhang, skip to step 3.

If building wrap exists at the head of the opening follow steps 2A-2C. If no building wrap exists, skip to step 2D.

- A. Prepare a head flashing with upturned leg by cutting it the same width as the brick/siding opening.
- B. Pry the top (head) j-channel/siding away from the sheathing enough so the head flashing can be slid under the house wrap.
- C. Insert the head flashing behind the brick/siding and behind the house wrap.

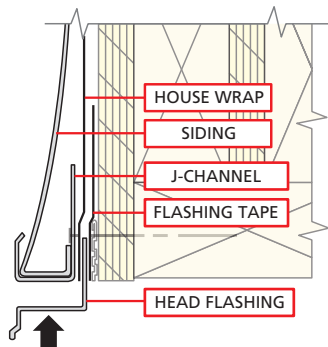

3 SEAL THE OPENING

- A. Clean the siding J-channel/trim or brick and rough opening thoroughly.
- B. Apply a 3/8" bead of sealant (or enough to cover the area) between the j-channel/trim and the sheathing at jambs (siding only). If a head flashing with upturned leg was used, seal between the back of the flashing and the sheathing at the head. Tool the sealant at head and/or jambs with a putty knife to press the sealant into the opening.
- C. Place a 3/8" bead of sealant at each corner of the opening.
- D. Apply flashing tape over the sealant at the head if a flashing with upturned leg was used. Extend the flashing tape 6" down each jamb. Cover the exterior surface of the drywall (if applicable).

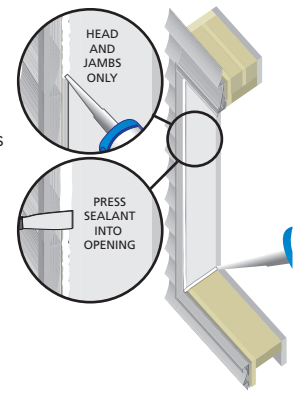



FULL FRAME REPLACEMENT WITHOUT DISTURBING BRICK OR SIDING FOR BLOCK FRAME WINDOWS

FOR USE IN BRICK OR SIDING WITH TRIM/J-TRIM AFTER THE COMPLETE REMOVAL OF A NAIL FIN WINDOW

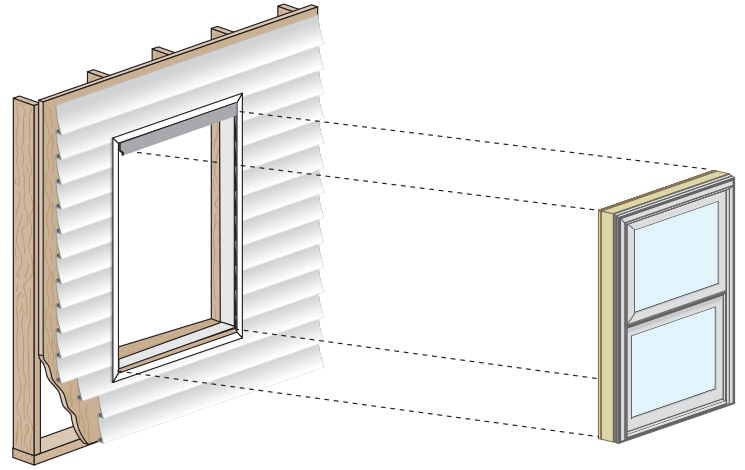
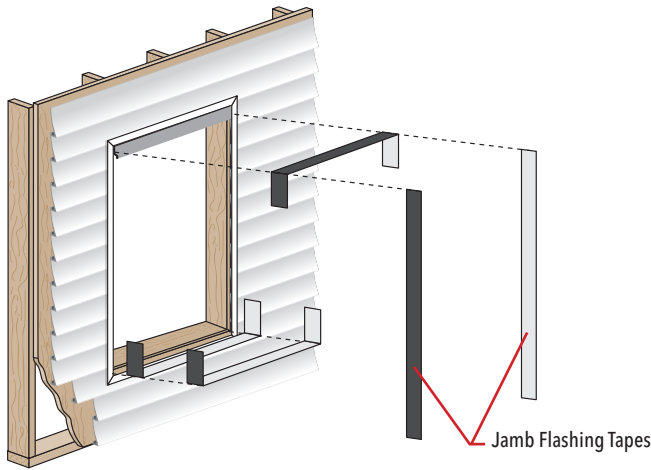

3 SEAL THE OPENING (Continued)

- E. Apply flashing tape at the sill, folding it behind the brick or siding onto the surface of the building wrap (if applicable) and up each jamb 6". Apply up the exterior edge of the drywall. If 2 pieces of flashing tape are required, apply the 2nd so it overlaps the first by 1".
- F. For brick, apply low expansion foam at the jamb to seal between the back of the brick and the sheathing.
- G. For siding, apply flashing tape at each jamb extending 3" onto the head and sill. Cover the exterior edge of the drywall (if applicable) and extend the tape over the sealant onto the side of the trim or j-trim.

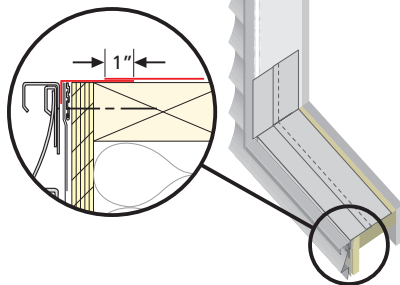

NOTE: The jamb flashing tape may also be used on brick. Apply sealant to the brick before application.

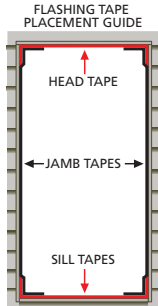
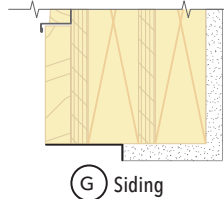
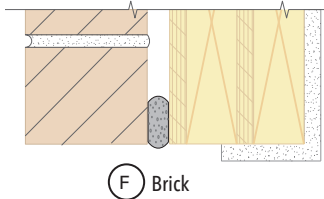

If the window is smaller than the drywall return opening, add treated blocking to the opening until the opening is approx. 1/2" larger in width and height than the window (see steps H-L).

- H. Cut treated blocking equal to the width and height (B) dimensions as necessary.
- I. Rip the treated blocking to a width less than (D). The width may be reduced to fit behind brick/siding or head flashing (see step 2).
- J. Apply (2) 3/16" beads of sealant. One just to the exterior of the drywall return and one along the exterior edge of the sheathing.
- K. Apply a 3/16" bead of sealant at each corner connecting the 2 beads from step 1J.

- L. Secure the treated blocking to the opening over the sealant using 2" corrosion resistant screws at 16" max. spacing.

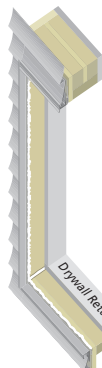
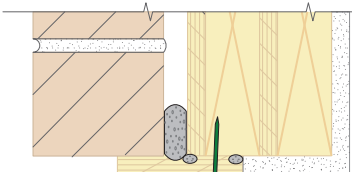

4 SET AND FASTEN THE WINDOW

- A. Install and level sill shims. Place 1" wide x 1/4" to 3/8" thick shims 1/2" from each side. Keep shims back 1/2" from interior and exterior face of window. Place additional shims under each mullion and sliding window interlocker. For vinyl windows, add shims so maximum spacing is 18".
- B. Attach shims to prevent movement after they are level. **NOTE: Improper placement of shims may result in bowing the bottom of the window.**
- C. Drill pilot holes in the window frame (if they are not factory pre-drilled). Refer to the anchor and shim spacing instructions at the end of this booklet.

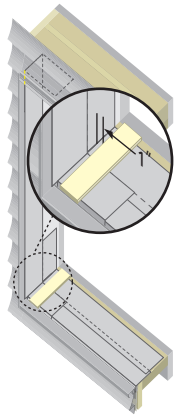

For windows being installed against the exterior of the drywall return, follow steps 4D and E.

- D. Secure drywall return installation clips using #8x 2-1/2" flat head screws at the jambs so they will align with each pilot hole in the window frame. These clips provide secure attachment when frame screws will not penetrate the framing or treated blocking.

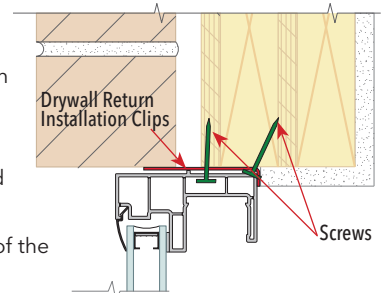

- E. Apply sealant to the exterior edge of the drywall return on all four sides.
- F. Insert the window into the opening on the sill shims. Check to make sure the window rests against the drywall and is making contact with the sealant (if applicable).
- G. Place shims and begin driving screws at each predrilled hole in the window frame. When screwing into drywall return installation clips, use the screws from the clip package. Add additional shims at the ends of meeting rails and as necessary to ensure even reveal between the frame and sashes.

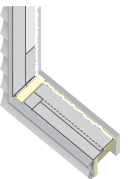

Refer to the anchoring instructions at the end of this booklet.

NOTE: Keeps shims 1/2" from the exterior surface of the window to allow for backer rod and sealant.

- H. Check for plumb, level, square and window operation. Make any necessary adjustments to shims and finish installing frame screws.
- I. Install interior sealant. Refer to the interior sealant instructions at the end of this booklet.
- J. Install exterior sealant. Refer to the exterior sealant instructions at the end of this booklet.
- K. Install interior and exterior trim (if necessary).

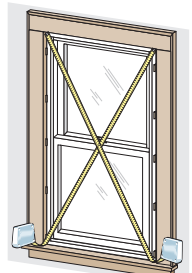



FULL FRAME REPLACEMENT IN MASONRY CONSTRUCTION WITH STUCCO FOR BLOCK FRAME WINDOWS

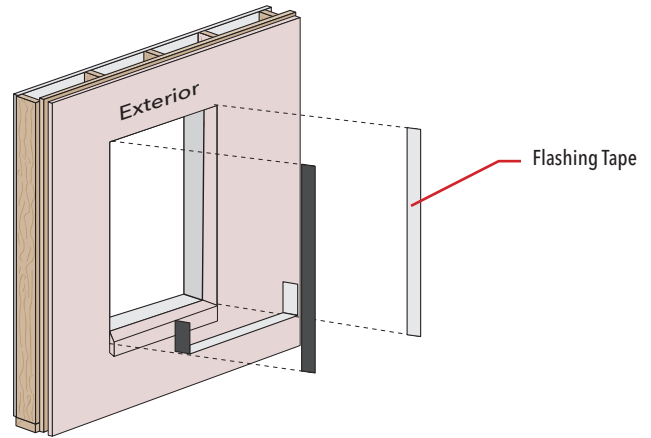
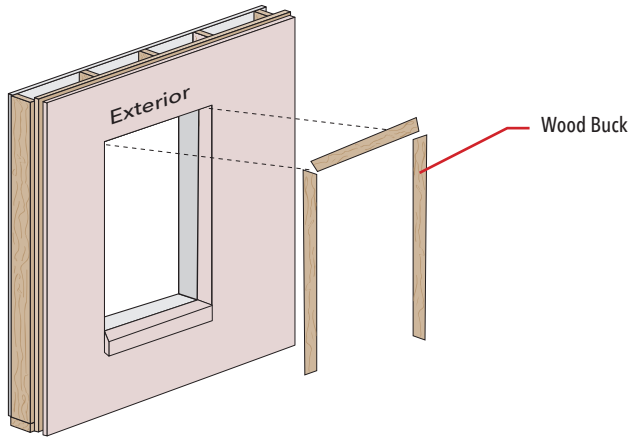

1 PREPARE THE OPENING

Refer to the full frame removal instruction at the beginning of this booklet.

- A. **Measure the width and height of the opening.**
The window must be approximately 1/2" smaller in width and height.
If replacing a wood buck, trim back any finish materials to accommodate the new wood buck.

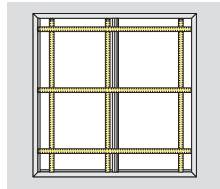

- B. **Apply 2 beads of sealant** to the masonry opening where the wood buck will be attached.
NOTE: Ensure the sealant is compatible with the water resistant coating.

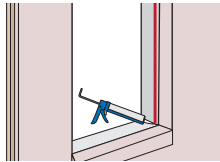

- C. **Apply sealant at the corners** of the wood buck and at the intersection of the wood buck and stucco. Fasten the treated wood buck to the masonry opening using code-approved fasteners.

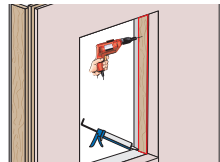

- D. **Apply flashing tape** from the stool over the top of the pre-cast concrete sill and 6" up each side. Apply water resistant coating or flashing tape over the wood buck. If using liquid applied flashing, allow it to dry according to the manufacturer's recommendations before proceeding.

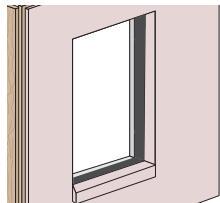

- E. **Install and level sill shims.** Place 1" wide x 1/4" to 3/8" thick shims 1/2" from each side. Keep shims back 1/2" from interior face of window. Place additional shims under each mullion and sliding window interlocker.
For vinyl windows, add shims so maximum spacing is 18".

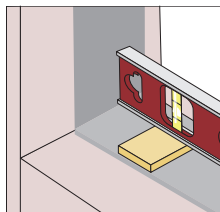

- F. **Attach shims to prevent movement after they are level.**
NOTE: Improper placement of shims may result in bowing the bottom of the window.

2 PREPARE THE WINDOW

FRAME SCREW INSTALLATION

- A. **Prepare the frame (if applicable).**
Remove interior frame covers—Impervia casement.
- B. **Drill pilot holes** (if necessary) in the new window frame. See the anchor instructions at the end of this booklet.
NOTE: Where possible, use frame screws at the sill to avoid penetrating the interior seal. Do not screw through the sill when a sill track is part of the window's weep system.

CLIP INSTALLATION

- C. **Pre-bend clips** if anchors will be installed into the interior wall surface (Metal clips only).
See the anchor spacing instructions at the end of this booklet.

- D. **Secure clips to the window frame:**

Encompass by Pella® / Pella® 150 Series / Pella® 250 Series

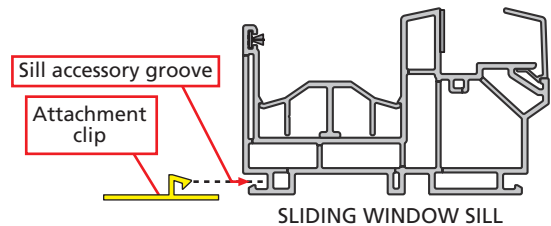



FULL FRAME REPLACEMENT IN MASONRY CONSTRUCTION WITH STUCCO FOR BLOCK FRAME WINDOWS (CONTINUED)

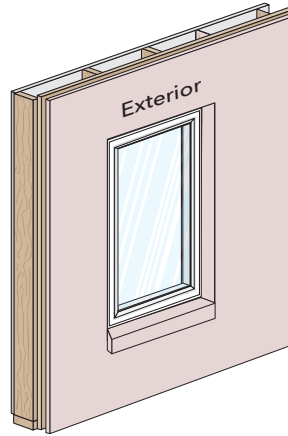
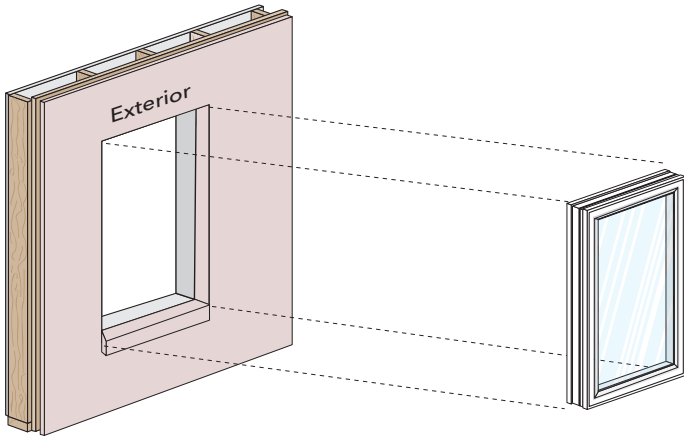

2 PREPARE THE WINDOW (Continued)

Pella® Impervia®:

E. Slide clips into the frame grooves.

NOTE: Pre-bend clips if anchors will be installed into the interior wall surface (Metal clips only).

F. Secure the clips to the frame. Use a small piece of flashing tape to prevent the clips from sliding out of place (Pella® Impervia®).

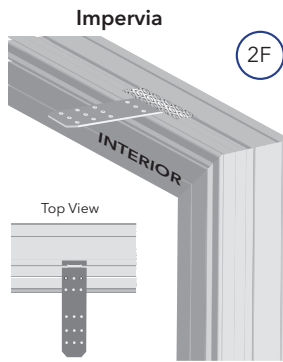

Architect Series (850) and Pella® Lifestyle Dual-Pane Series:

G. Install the clips into the fin grooves. Start one corner of the clip in the fin groove. Tap the corner into the fin groove with a hammer, then continue to tap the other corner until the clip is locked into the groove.

H. Secure the clips to the frame. Drive one #8 x 5/8" screw through the slotted hole in the center of the clip.

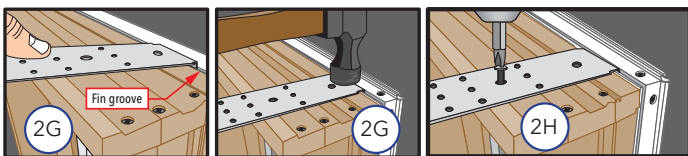

Alternatively, it is acceptable to use two #6 x 5/8" screws through the clip with the clip on its back and not engaged in the fin groove.

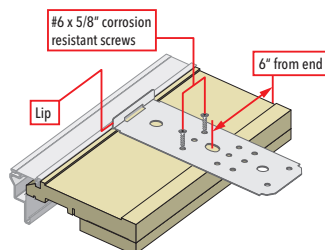

3 SET AND FASTEN THE WINDOW

A. Insert the window into the opening by placing the front edge of the window sill on the opening sill and tilting the window up. Center the window between jambs. Check to make sure the distance from the interior of the new window to the interior of the existing window is consistent all around the window.

B. Place sealant under each clip (if applicable).

C. Place shims and begin driving screws at each predrilled hole in the window frame or each clip. Install masonry screws at least 2" from wall edge.

Refer to the anchor instructions at the end of this booklet.

Keep shims 1/2" from the interior surface of the window to allow for a continuous interior and exterior seal.

D. Check window operation.

Vent Awning and Casement: Refer to applicable hardware instructions. Unlock and open the window to remove the shipping spacers. Open and close the window to test for proper operation.

Double-Hung: Cut the checkrail bands (if applicable) and remove shipping spacers. Open, close and tilt the sashes to test for proper operation. Check for equal sash to frame reveal from top to bottom.

D. Check for plumb, level, and square. Make any necessary adjustments to shims and finish installing frame screws or clip anchors.

F. Adjust the screw jacks (if applicable) with a screwdriver. Turn clockwise to move the frame toward the sash.

Tilt the lower sash inward to locate the jamb jacks in the interior balance channel near the checkrail.

G. Install interior sealant. Refer to the interior sealant instructions at the end of this booklet. Use additional sealant around clips to prevent air and water infiltration.

H. Install exterior sealant between the window and the finished wall material. Refer to the exterior sealant instructions at the end of this booklet.

I. Install optional frame expander trim to bridge the gap between the window and the existing stucco.

J. Apply exterior sealant between the edge of the frame expander and the finished wall material. Refer to the exterior sealant instructions at the end of this booklet.

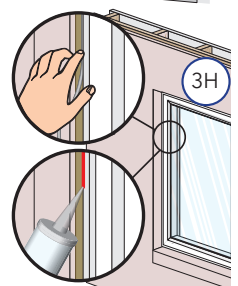
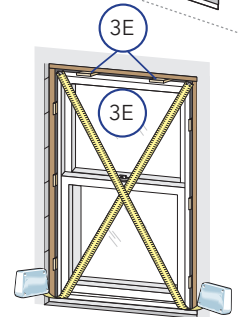
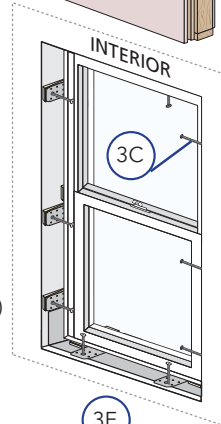
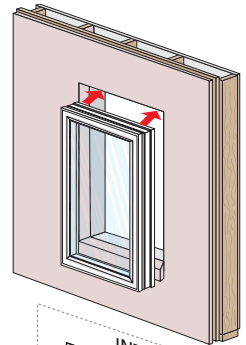



BLOCK FRAME AND RENOVATION® / PRECISION FIT® WINDOWS ANCHOR INSTRUCTIONS

Note: Standard performance only. Additional anchoring may be required for performance upgrade, impact resistant products or to comply with local building code requirements.

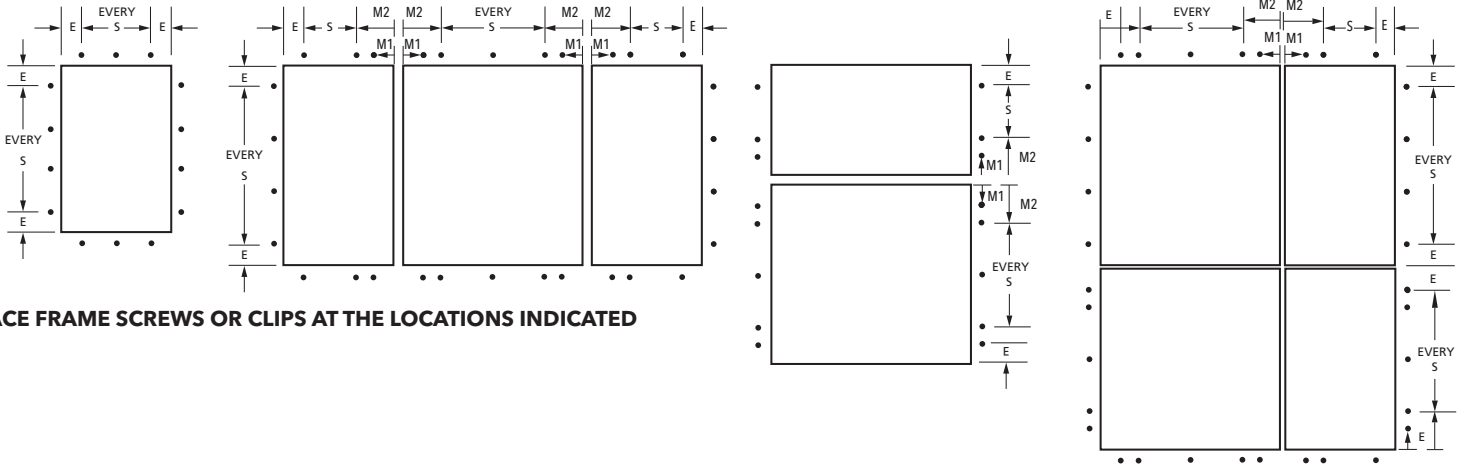

PLACE FRAME SCREWS OR CLIPS AT THE LOCATIONS INDICATED

ARCHITECT SERIES® (850) AND PELLA® LIFESTYLE SERIES WINDOW ANCHOR SPACING INSTRUCTIONS

Product	Edge Spacing (E)	Max. Intermediate Spacing (S)	First Mullion Anchor (M1)	Second Mullion Anchor (M2)	Fastener	Special Notes
					Wood **	
Casement/Awning	6"	16"	3"*	6"	#8x3" Finish Screw	
Double- or Single-Hung	6"	16"	3"*	6"	#8x3" Finish Screw	For windows with integrated Rolscreen® retractable screen, drive jamb screws at each factory pre-punched hole in the jamb liner. Add fasteners as necessary, driving the head past flush of the jamb liner. Avoid Rolscreen components in the head and sill.
Fixed Frame	6"	16"	3"*	6"	#8x3" Finish Screw	
Monumental DH > 54" x 96"	6" (head)	16" (head)	3" *	6" *	#8 x 3" Screw	Remove sashes and jamb liners. Drive 1 screw through each jamb liner support clip (top, bottom, checkrail and center of each sash). Drive 2 additional screws through the frame (or secure clips) 3" above and below the checkrail on each jamb. Drive additional screws through the frame (or secure clips) centered between each jamb liner support clip.

* M1 anchor required if design pressure exceeds 20 psf.

** For light gauge steel framing, use #10 self-drilling/self-tapping screws; For concrete or masonry, use 3/16" masonry screws with 1-1/4" minimum embedment.

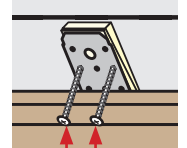

#6 x 1-1/2" screw

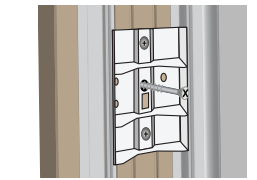
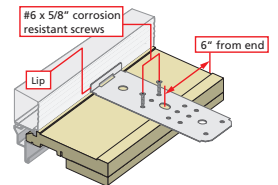

Monumental Hung jamb liner support clip

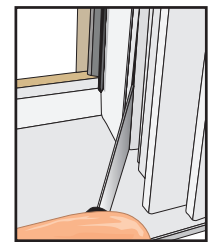

Pry off Monumental Double-Hung jamb liner

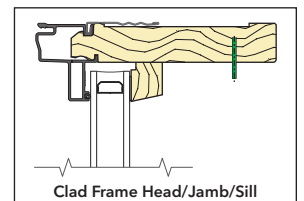

Clad Frame Head/Jamb/Sill

1/8" Pilot Hole Locations

	Casement/Awning	Lifestyle Series Double-Hung	Architect Series Double-Hung	Monumental-Hung
Head				
Jamb			 Units with Integrated Rolscreen	 Pry Here
Sill	Do not install fasteners through operator cutout. 		Not applicable for units with Integrated Rolscreen. 	Sill anchors not required.



BLOCK FRAME AND RENOVATION® / PRECISION FIT® WINDOWS ANCHOR INSTRUCTIONS

NOTE: Standard performance only. Additional anchoring may be required for performance upgrade, impact resistant products or to comply with local building code requirements.

PELLA® IMPERVIA® WINDOW ANCHOR SPACING INSTRUCTIONS

Product	Edge Spacing (E)	Max. Intermediate Spacing (S)	First Mullion Anchor (M1)	Second Mullion Anchor (M2)	Fasteners*	Special Notes
Sliding and Sash Set Fixed	6"	16"	6"	3"	#8 x 2-1/2" Pan Head (provided)	Installation clips required for anchoring at the sill.
Single-Hung						Sill anchors not required for single wide units. Installation clips required for mullion anchoring.
Double-Hung					#8 x 2" Pan Head (provided)	Head and Sill anchors not required when single-wide unit with frame width less than 42".
Casement/Awning - Vent and Fixed	6"	15"			#10 x 3" Pan Head (provided)	Install screws at pre-marked locations after removing interior frame covers (see below).
Direct Set						

Use Factory Drilled installation holes if present.

Install hole plugs after driving screws (except CM/AW and Direct Set)

* For light gauge steel framing, use #10 self-drilling/self-tapping screws

For concrete or masonry, use 3/16" masonry screws with 1-1/4" minimum embedment.

Clip Anchor Method Only

Slide clips into the frame groove and locate per the anchor spacing instructions. Use a small piece of flashing tape to hold the clips in place.

(3) # 8 x 1-1/4" screws through clip into rough opening.

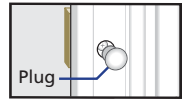
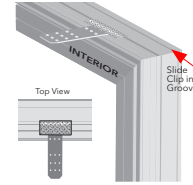
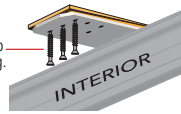

Mullion Anchoring Diagram

Use Factory Drilled installation holes if present.

Composites (Integral) or Standard Joining: M1 anchor using a through frame fastener or installation clips.

1/2" Structural, 1" Structural, or 1/2" Structural with Reinforcement: M1 and M2 anchors required.

1" Structural with 1 or 2 Reinforcements: M1, M2, and M3 anchors required.

*Anchors required at each mullion end. Anchor using through frame fasteners or installation clips.

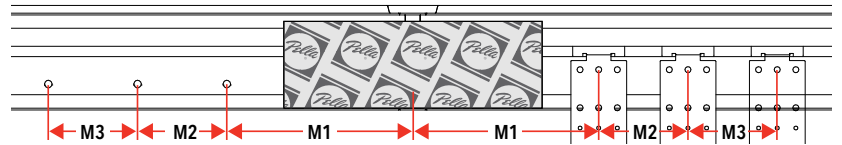

Pilot Hole Locations and Sizes

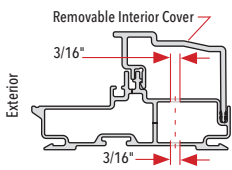

Casement/Awning***

***If an Interior Frame Cover has a "Quick Release Band" around the cover; pull the band to help remove the cover.

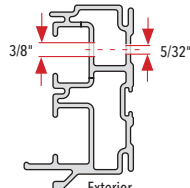

Double-Hung

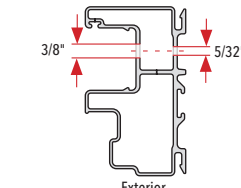

Single-Hung/Sliding/Sash Set Fixed

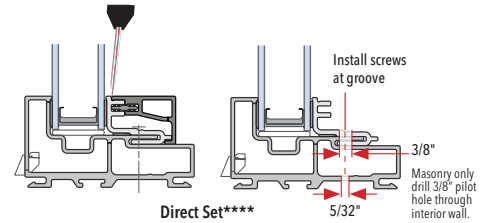

Direct Set****

****Use putty knife; insert where indicated and slide cover to interior.



BLOCK FRAME AND RENOVATION® / PRECISION FIT® WINDOW ANCHOR INSTRUCTIONS

NOTE: Standard performance only. Additional anchoring may be required for performance upgrade, impact-resistant products or to comply with local building code requirements.

ENCOMPASS BY PELLA® / PELLA® 150 SERIES WINDOW ANCHOR SPACING INSTRUCTIONS

Product	Edge Spacing (E)	Max. Intermediate Spacing (S)	First Mullion Anchor (M1)	Second Mullion Anchor (M2)	Fastener		Special Notes
						Wood***	
Sliding Window (East and West)	6"	16"	3" / centered	8" / none		#8 x 1-1/4" Pan Head (provided)	Use M1 and M2 spacing for screws at head of meeting rail. Center 1 clip below the meeting rail.
Single-Hung (West)	6"	16"	3"	6"		#8 x 2-1/2" Pan Head (provided)	Use M1 and M2 spacing for screws at the head only with mullions.
Single- and Double-Hung (East)	Factory Pre-Drilled**		4"	8"		#10 x 2" Pan Head (provided)	High Performance DH: (3) #8 x 2" jamb frame screws, 4" apart at checkrails. Use (4) #8 x 2" screws at head mullion ends and 4 clips at sill mullion ends 3" and 6" from mullion. Use self-adhesive spacer at all installation holes for ≥ PG50 Performance Installs.
Fixed Window	4**	16**	4"	none		#8 x 3" Pan Head (provided)	Use clips at the sill at mullions and centered under fixed casements in 3-wide combinations.

All venting products: Head and sill anchors are required on composites only.

* Use Factory Drilled installation holes if present.

** For DH & SH units >62" tall add 2 screws per jamb, midway between top and bottom pre-drilled holes.

*** For light gauge steel framing, use #10 self-drilling/self-tapping screws; for concrete or masonry, use 3/16" masonry screws with 1-1/4" minimum embedment.

Double-, Single-Hung and Sliding Window

Remove head pocket cover before drilling holes. Re-install after install is complete.

Pilot Hole Locations and Sizes

Sliding, Single- and Double-Hung window hole location.

Clip Installation for Mullions

Drill (2) 5/32" holes and install (2) #10 x 1-1/2" screws per clip.

Single Hung (West)

Before drilling jamb installation holes, pull out the bottom of the take-out clip on each jamb.

Raise the sash until the balance engages the take-out clips. Slide the sash all the way to one side and pull out the opposite side. Carefully set the sash aside.

Separate the balances from the take out clips by holding them at top and bottom and pushing down 1". Tilt the top of the balance away from the frame and lift the hook out of the frame.

Fixed Window

Remove fixed window glazing beads before drilling installation holes. (West)

East Region 2-1/16" Frame Window

East Region 3-1/4" Frame Window

West Region

PELLA® 250 SERIES WINDOW ANCHOR SPACING INSTRUCTIONS

Product	Edge Spacing (E)	Max. Intermediate Spacing (S)	First Mullion Anchor (M1)	Second Mullion Anchor (M2)	Fastener		Special Notes
						Wood***	
DH/SH (single units)	Factory Pre-Drilled**		-	-		#10 x 2" Pan Head (provided)	Use self-adhesive spacer at all installation holes for ≥ PG50 Performance Installs.
DH / SH / FX	4"	16" **	3"	6"		#10 x 2" Pan Head (provided)	Use M1 and M2 spacing for screws at head and clips at sill with mullions only.
SW	4"	16"	-	6"			
SW ≥PG50	4"	12"	-	6"			
CM/AW	Factory pre-drilled holes in Jambes and Head, clips at sill 4" Edge Spacing and 12" Max. Spacing		4"	8"			
FX CM/AW	Clip only 4" Edge Spacing and 12" Max. Spacing		4"	8"			

All venting products: Head and sill anchors are required on composites only.

* Use Factory Drilled installation holes if present.

** For DH & SH units >62" tall add 2 screws per jamb, midway between top and bottom pre-drilled holes.

*** For light gauge steel framing, use #10 self-drilling/self-tapping screws; for concrete or masonry, use 3/16" masonry screws with 1-1/4" minimum embedment.

250 Series DH PG50 ONLY: Add additional clip at center of mullion at sill only. Install hole plugs/caps after driving screws. Replace all covers, fillers and tracks removed earlier.

250 Series 1" Structural Mulls: Use (4) #10 x 2" screws in each end anchor

250 Series 1/2" Mulls: Use Attachment Clips at sill spaced 3" and 6" from mullion.

Pilot Hole Locations and Sizes

SW Vent Track

SW Pocket Filler

Fixed

SH Pocket Removal

CM/AW Fixed Cover Removal

CM/AW



Interior Sealant Instructions

CAUTION: Continuous backer rod (as necessary) and a high quality, low-odor interior sealant such as Pella Window and Door Installation Sealant (or equivalent) is recommended for commercial or high performance installations to create the continuous interior seal. Follow the directions on the cartridge. For standard performance or products with factory applied jamb extensions, use low pressure polyurethane insulating foams. Follow the directions on the can. Do not use high pressure or latex foams. Fiberglass batt or similar insulation is not recommended as it can absorb water and does not act as an air seal.

- A. Insert the nozzle or straw between the rough opening and window frame. This can be done from the interior or exterior.
 - B. Place a 1" deep bead of foam approx. 1" from the interior of the frame to allow for expansion. Do not fill the entire depth of the rough opening cavity.
- NOTE:** Apply foam between the frame and rough opening, NOT between jamb extensions and the rough opening.
- C. Re-Check window operation and remove remaining shipping spacers after foam installation. Excess foam may be removed with a serrated knife after it cures.
 - D. To ensure a continuous interior seal, apply sealant over or around any shims or clips interrupting the foam seal.

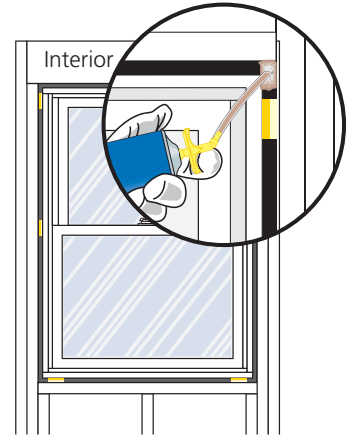

For windows set against drywall return or wood interior stops:

- E. Apply a corner bead of sealant where the frame and drywall return or stop meet. This sealant covers any gaps and creates a smooth transition between materials. Applying a continuous interior bead of sealant eliminates the need for low expansion foam.
- F. Re-check window operation and remove shipping spacers after foam installation. Excess foam may be removed with a serrated knife after it cures.

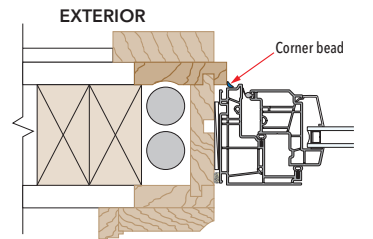
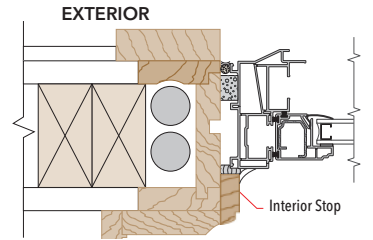

Figure 1

Exterior Sealant Instructions

CAUTION: Use a high quality, multi-purpose exterior sealant such as Pella Window and Door Installation Sealant. Follow the directions on the cartridge.

- A. If the space between the new window frame and the opening is greater than 1/4", go to step (B) If less than 1/4" or if the frame does not project past an exterior stop (Figure 1), skip to step (C).
- B. Insert backer rod 3/8" deep in the space around the window. Backer rod adds shape and controls the depth of the sealant line.
- C. Apply a continuous bead of sealant where the new frame contacts the exterior stop (Figure 1) or between the frame and the opening (Figures 2, 3 and 4). Continue the seal across the bottom of the sill adapter (if applicable). Do not block weep holes or weep hoods with sealant.

NOTE: For full frame replacement in brick or siding, where the wall is designed to manage water do not leave gaps or weeps in the exterior sealant. For pocket replacement, if weep holes are not present in the sill adapter and the existing sill slopes to the exterior, leave weep gaps in the sealant (Figure 5).

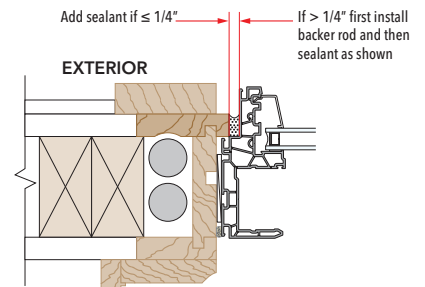

Figure 2

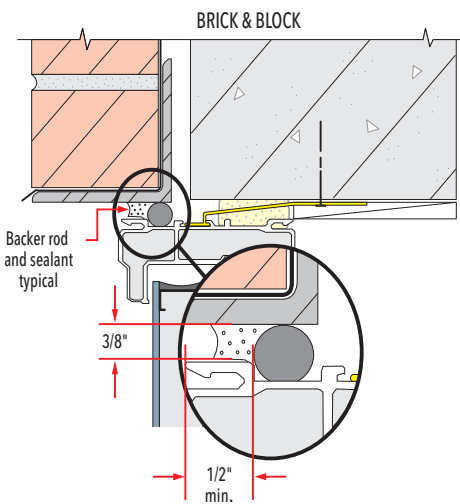

Figure 3

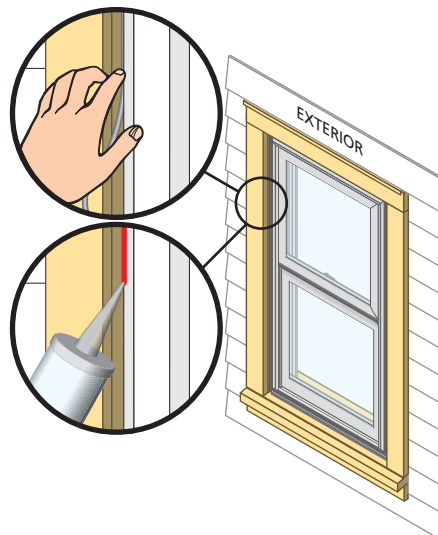

Figure 4

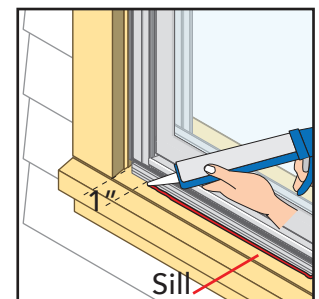

Figure 5