

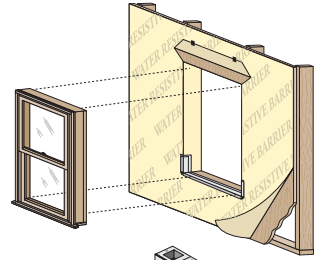

THE FOLLOWING INSTALLATION METHODS ARE INCLUDED IN THIS BOOKLET:

New Construction Installation of Wood Brickmould Windows in Wood Framed Walls After Building Wrap



New Construction Installation in Masonry Construction for Flush Flange or Wood Brickmould Windows

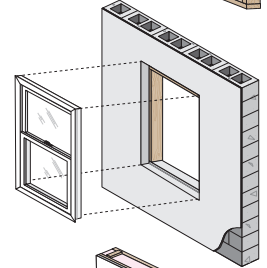

Pocket Replacement into Aluminum Frames in Stucco Walls for Flush Flange Windows Full Frame Replacement

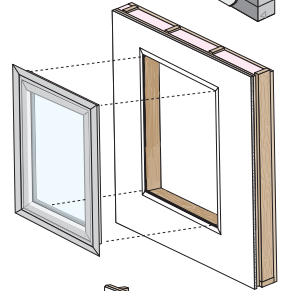

Full Frame Replacement of Wood Brickmould products with new Pella® EnduraClad® Exterior Trim or Wood Brickmould Products

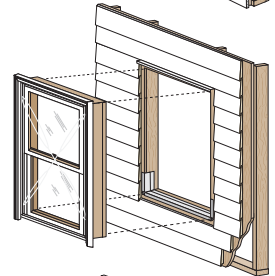

Full Frame Replacement in Stucco Walls for Flush Flange Windows

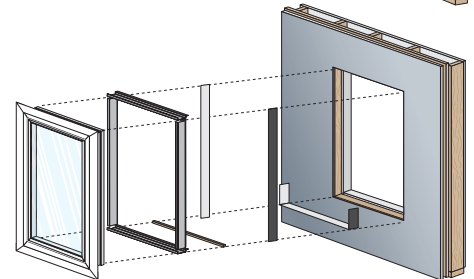

Full Frame Replacement in Masonry Construction with Stucco for Flush Flange Windows

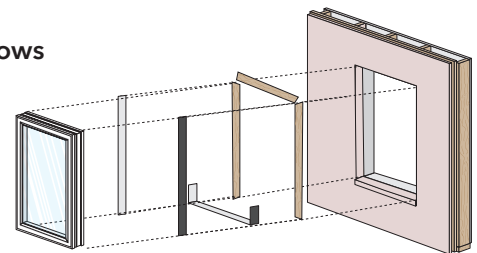

These instructions were developed and tested for use with wall systems designed to manage water. These instructions are not to be used with any other construction methods or window frame types. Installation instructions for use with other construction methods or frame types may be obtained from Pella Corporation, your local Pella retailer or www.installpella.com. Building designs, construction methods, building materials, and site conditions unique to your project may require an installation method different from these instructions and/or additional care. Determining the appropriate installation method is the responsibility of you, your architect, or construction professional.



BY PURCHASING, INSTALLING OR USING PELLA PRODUCTS (INCLUDES PELLA GOODS AND PELLA SERVICES), YOU AGREED TO THE TERMS OF THE LIMITED WARRANTY AND YOU AND PELLA FURTHER AGREE TO ARBITRATE DISPUTES ARISING OUT OF OR RELATING TO PELLA PRODUCTS, AND YOU WAIVE ANY RIGHT TO PARTICIPATE IN A CLASS ACTION RELATED TO PELLA PRODUCTS unless you notify Pella of your decision to opt out of the Arbitration Agreement no later than ninety (90) calendar days from the date you purchased or otherwise took ownership of Your Pella Goods. Opting out of the Arbitration Agreement will not affect the coverage provided by any applicable limited warranty pertaining to Your Pella Products. For opt out information and additional details please read the Limited Warranty and Arbitration Agreement for your Pella Products at www.Pella.com/arbitration.



IMPORTANT SAFETY AND PRODUCT INFORMATION – WINDOW

CAUTION: Many windows in older homes are painted with lead-based paint. Removal of old windows may disturb this paint. Proper precautions must be taken to minimize exposure to dust and debris. Consult state or local authorities and/or go to www.epa.gov/lead for more information.

WARNING: To ensure safety and security and help prevent property damage, including possible damage to your window or door, close and lock windows and doors any time they are not being used for venting on a nice day, and particularly during high winds or rain.

Important Notice

Because all construction must anticipate some water infiltration, it is important that the wall system be designed and constructed to properly manage moisture. Pella Corporation is not responsible for claims or damages caused by anticipated and unanticipated water infiltration; deficiencies in building design, construction and maintenance; failure to install Pella products in accordance with Pella's installation instructions; or the use of Pella products in wall systems which do not allow for proper management of moisture within the wall systems. The determination of the suitability of all building components, including the use of Pella products, as well as the design and installation of flashing and sealing systems are the responsibility of the Buyer or User, the architect, contractor, installer, or other construction professional and are not the responsibility of Pella.

Pella products should not be used in barrier wall systems which do not allow for proper management of moisture within the wall systems, such as barrier Exterior Insulation and Finish Systems (EIFS) (also known as synthetic stucco) or other non-water managed systems. Except in the states of California, New Mexico, Arizona, Nevada, Utah and Colorado, Pella makes no warranty of any kind on and assumes no responsibility for Pella windows and doors installed in barrier wall systems. In the states listed above, the installation of Pella Products in barrier wall or similar systems must be in accordance with Pella's installation instructions. Product modifications that are not approved by Pella Corporation will void the warranty.

Care and Maintenance

Care and maintenance information is available by contacting your local Pella retailer. This information is also available at www.pella.com.

Cleaning Instructions

GLASS: Remove any protective film and labels and clean the glass, using a soft, clean, grit-free cloth and mild soap or detergent. Be sure to remove all liquid by wiping dry or use a clean squeegee.

FACTORY FINISHED PRODUCT: Pella product that has been prefinished with stain or paint from the factory requires no additional finishing. Clean the surface with mild soap and water.

PELLA® ALUMINUM CLAD OR IMPERVIA FRAMES: The interior and exterior frame and sash are protected with a tough factory finish. Clean this surface with mild soap and water. Stubborn stains and deposits may be removed with mineral spirits. DO NOT use abrasives. DO NOT scrape or use tools that might damage the surface.

ENCOMPASS BY PELLA®, PELLA® 150 SERIES AND PELLA® 250 SERIES AND WINDOWS FRAMES: The vinyl frame may be cleaned using the same method as the glass. For stubborn dirt, a "non-abrasive" cleaner such as Bon-Ami® or Soft Scrub® may be used. Do not use solvents such as mineral spirits, toluene, xylene, naphtha or muriatic acid as they can dull the finish, soften the vinyl and/or cause failure of the insulated unit seal. Do not use Isopropyl Alcohol on laminated surfaces as it will damage the finish. Keep door tracks clear of dirt and debris. Keep weep holes open and clear of obstructions.

DO NOT use abrasives. DO NOT scrape or use tools that might damage the surface.

Notice: DO NOT use inappropriate solvents or brickwash or cleaning chemicals. If you do, permanent damage can result and the product failure, loss or damage would not be covered by the Limited Warranty.

Interior Finish (Wood Windows)

Paint or finish immediately after installation.

If products cannot be finished immediately, cover with clear plastic to protect from dirt, damage and moisture. Remove any construction residue before finishing. Sand all wood surfaces lightly with 180 grit or finer sandpaper. DO NOT use steel wool. BE CAREFUL NOT TO SCRATCH THE GLASS. Remove sanding dust. Pella products must be finished per the below instructions; failure to follow these instructions voids the Limited Warranty.

Note: To maintain proper product performance do not paint, finish or remove the weatherstripping, mohair dust pads, gaskets or vinyl parts. Air and water leakage will result if these parts are removed. After finishing, allow venting windows and doors to dry completely before closing them. If paint, stain or finish gets on the weatherstripping, wipe it off immediately with a damp cloth.

Window Cleaning and Prep Instructions for Unfinished or Primed windows: Dry wipe dust from windows gently. Examine window for possible smudges or fingerprints made from normal handling or construction. To remove smudges, lightly wipe surface with warm water. Scuff sand with light grade sand paper or abrasive pad (220 grit or higher). Rinse surface with warm water. Let window surfaces dry completely before applying finish.

Finish the windows as soon as possible after installation.

- On casement and awnings, it is optional to paint, stain or finish the vertical and horizontal sash edges.
- On single-hungs and double-hungs, do not paint, stain or finish the vertical sash edges, any finish on the vertical sash edges may cause the sash to stick; it is optional to paint, stain or finish the horizontal sash edges.

Pella Corporation is not responsible for interior paint and stain finish imperfections for any product that is not factory-applied by Pella Corporation. For additional information on finishing see the Pella Owner's Manual or go to www.pella.com.

The use of unapproved finishes, solvents or cleaning chemicals may cause adverse reactions with door materials. Pella will not be responsible for problems caused by the use of unapproved materials. If in doubt, contact your local retailer or representative.

Exterior Finish of Existing Frame (Pocket Replacement)

It is the responsibility of the homeowner, contractor or installer to ensure any exposed unfinished wood is covered or finished. Possible methods include, however are not limited to, covering with aluminum coil stock or painting.



FULL FRAME OR SASH REMOVAL WHEN PREPARING TO INSTALL A NEW WINDOW WITH BRICKMOULD OR FLUSH FLANGE

CAUTION: Many windows in older homes are painted with lead-based paint. Removal of old windows may disturb this paint. Proper precautions must be taken to minimize exposure to dust and debris. Consult state or local authorities and/or go to www.epa.gov/lead for more information.

REMEMBER TO USE APPROPRIATE PERSONAL PROTECTIVE EQUIPMENT.

Apply adhesive film or duct tape to the glass to prevent breakage.

1 ALUMINUM SASH AND/OR FRAME REMOVAL

- A. **Score the paint or varnish** between the interior trim and the wall or between the drywall return and the window frame to minimize damage. (Frame removal only).
- B. **Remove the interior trim.**
- C. **Score the sealant or paint** between the exterior siding or brick and the window frame.
- D. **Remove the screen and vent sash** from the old window. If it is not removable, see steps G-I.
- E. **Remove the division bar** by removing the screws at the ends or cutting it with a reciprocating saw.
- F. **Remove the other sash/panel.** Remove any screws holding the fixed sash. Slide it and lift it out of the channel (sliding windows) or tilt it and release it from the balance assembly (hung windows).

If the sashes are not removable or the glass is sealed to the frame:

- G. **Remove the glazing bead** using a putty knife or small pry bar.
- H. **For single pane windows with divided lights (grids).** Use an angle grinder with a cut-off wheel to cut the end of the bars where they intersect with the sash or frame. This will allow the window glass to be removed more quickly.
- I. **Heat the glazing seal** using an electric heat gun.
- J. **While applying heat, press a de-glazing wheel** between the glass and sash or frame. Continue around the perimeter of the sash or panel. Apply light, constant pressure to separate the glass from the sash or frame. Dispose or recycle of the glass properly.

NOTE: Wear appropriate personal protective equipment and keep the heat source away from flammable materials.

Stop here for pocket replacement, complete steps K-L for full frame replacement.

- K. **Cut through the frame using a reciprocating saw.**
- L. **Pry the frame away from the brick or siding.** Use a block of wood under the pry bar to protect interior or exterior finishes. Dispose or recycle of the frame materials properly.

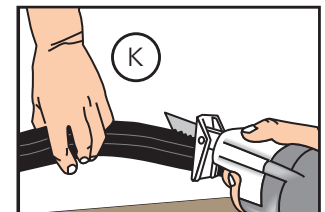
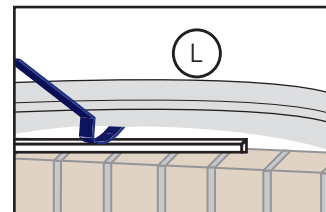
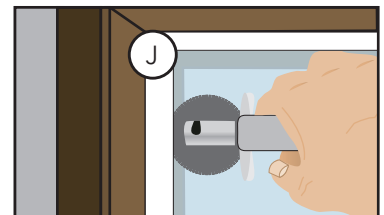
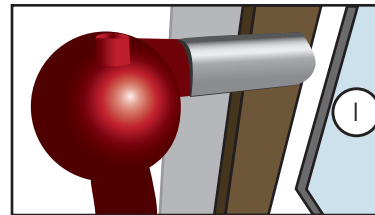
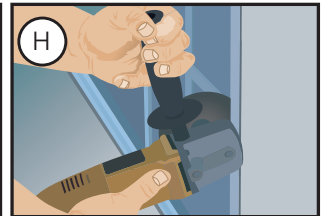
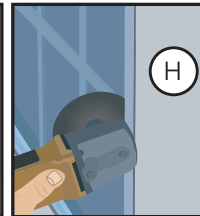
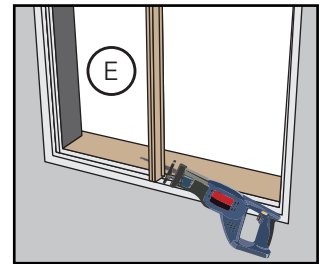
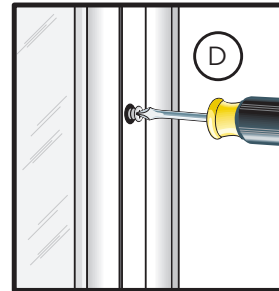
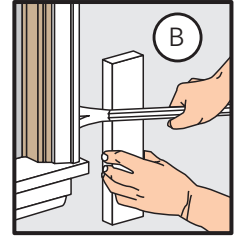

2 BRICKMOULD FRAME REMOVAL

- A. **Score paint or varnish** between the interior trim and the wall with a sharp utility knife. **NOTE: This will minimize the damage to the interior wall and trim.**
- B. **Remove the interior trim.** Remove the interior trim from all the four sides of the window including the stool at the bottom of the window. If the interior trim is being reused, pull the nails out through the back side of the board with nipper pliers.
- C. **Cut the exterior sealant line** between the exterior brickmould or trim and the exterior siding or wall cladding.
- D. **Remove the exterior brickmould or flat trim.** **CAUTION: Some windows may come out of the opening as the exterior trim is removed.** **NOTE: DO NOT disturb existing head flashings.**
- E. **Remove the window frame.**

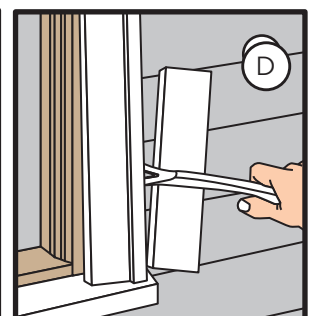
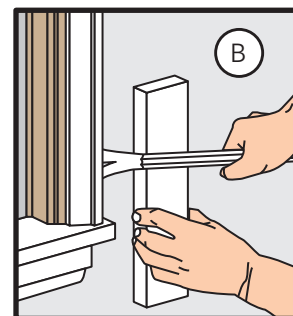







Consult with local providers and authorities to recycle or properly dispose of old window components.













PREPARING FOR BRICKMOULD OR FLUSH FLANGE WINDOW INSTALLATION

YOU WILL NEED TO SUPPLY:

- Moisture resistant shims/spacers 
- Fasteners (see nail fin anchor instructions and tables at the end of this booklet) 
- Closed cell foam backer rod/sealant backer 
- Pella® SmartFlash™ foil backed butyl window and door flashing tape or equivalent 
- Low expansion, low pressure polyurethane insulating window and door foam sealant. **DO NOT** use high pressure or latex foams. 
- Pella Window and Door Installation Sealant or equivalent high quality, multi-purpose sealant 

TOOLS REQUIRED:

- Tape measure 
- Level 
- Square 
- Hammer 
- Stapler 
- Scissors or utility knife 
- Small flat blade screwdriver 
- Sealant Gun 
- Screw Gun with a Phillips Driver bit 
- Drill with 1/8", 5/32", 3/16" & 3/8" drill bits 
- 1/8" Allen wrench 

Other construction materials may be required. Read and understand the instructions and inspect the wall conditions before you begin.

Store windows in upright position, out of direct sunlight.

INSTALLATION WILL REQUIRE (2) OR MORE PERSONS FOR SAFETY REASONS.

Preparing for Installation

- Remove plastic wrap and cardboard packaging** from the window. On laminate units, remove protective film from parts. Do not cut checkrail bands (if present) or remove plastic or foam shipping spacers located between the window sash and frame. **DO NOT** open the window until it is securely fastened.
- Inspect the product** for any damage such as cracks, dents or scratches. **DO NOT** install damaged windows.
- Remove screens and hardware** (if necessary). Label them and set aside in a protected area.

Windows with Half Screens: From the exterior, pull one side of the screen near the shipping clips until the clips disengage from the frame. Rotate the shipping clips toward the exterior of the screen until they snap free from the screen.

Half screens of some vinyl windows can be removed from the interior.
- Pre-Drill Installation holes or install clips** (if necessary). See frame anchor instructions at the end of this booklet."
- Before Installation**, remove dirt and debris from all surfaces of the opening.
- Read the entire instruction before proceeding.**

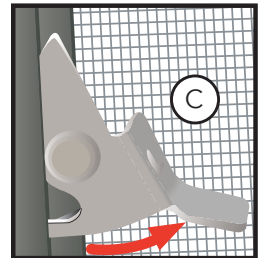
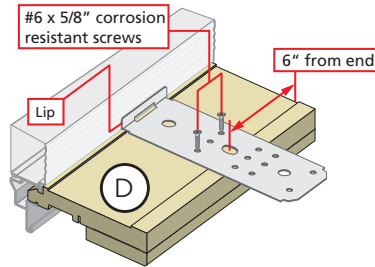
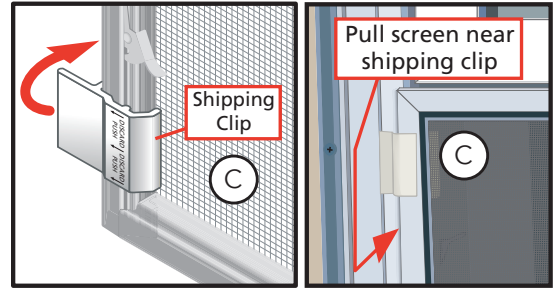

These instructions were developed and tested for use with wall systems designed to manage water. These instructions are not to be used with any other construction methods or window frame types. Installation instructions for use with other construction methods or frame types may be obtained from Pella Corporation, your local Pella retailer or www.installpella.com. Building designs, construction methods, building materials, and site conditions unique to your project may require an installation method different from these instructions and/or additional care. Determining the appropriate installation method is the responsibility of you, your architect, or construction professional.



WOOD BRICKMOULD WINDOW AFTER BUILDING WRAP – FOR USE IN WOOD FRAME WALLS

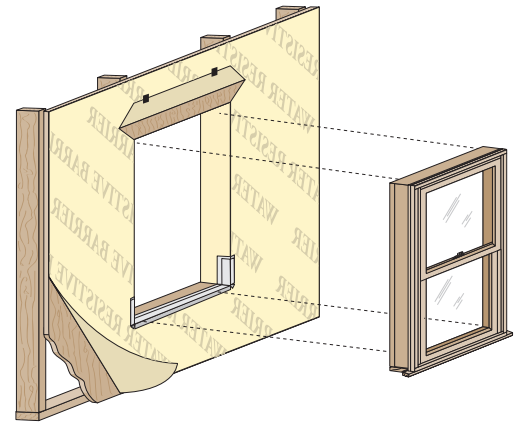
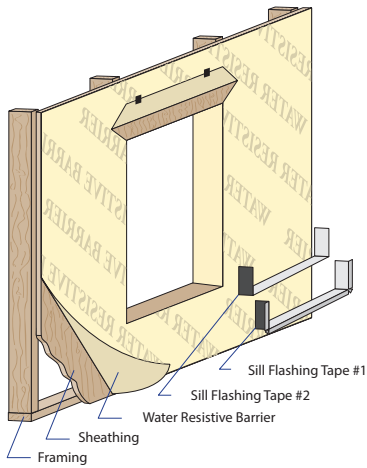

1 Prepare the Opening

Refer to the installation preparation section at the beginning of this booklet.

- A. **Confirm the window will fit the opening.** Measure all four sides of the opening to make sure it is 1/2" to 3/4" larger than the window in both width and height including subsill. On larger openings; measure the width and height in several places to ensure the header or studs are not bowed.

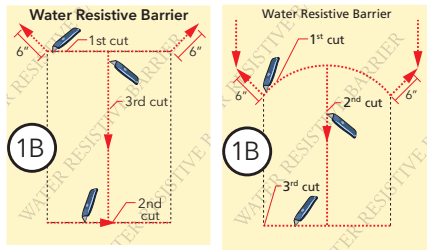

NOTE: 1-1/2" or more of solid wood blocking is required around the perimeter of the opening.

Fix any problems with the rough opening before proceeding.

- B. **Cut the building wrap.** Refer to the diagram for other window shapes.
- C. **Fold the building wrap** in at the jambs and staple it in place. Fold the top flap up and temporarily fasten with flashing tape.
- D. **Cut 2 pieces of flashing tape** 12" longer than opening width.
- E. **Apply sill flashing tape #1** at the sill extending 1" to the exterior and 6" up each jamb.
- F. **Cut 1" wide tabs** at each corner by tearing the foil 1/2" each way from corner.
- G. **Apply sill flashing tape #2** overlapping tape #1 by 1" minimum.

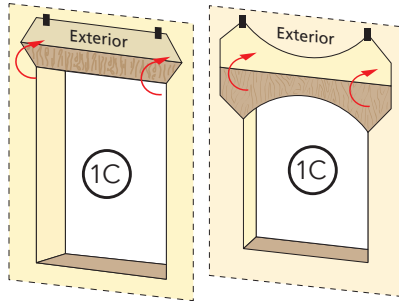

- NOTE: Press all tape down firmly.**
- H. **Install and level sill shims.** Place 1" wide x 1/4" to 3/8" thick shims 1/2" from each side. Keep shims back 1/2" from the interior face of the window. Place additional shims under each mullion and sliding window interlocker.
- I. **Attach shims** to prevent movement after they are level.

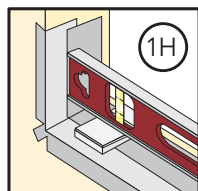
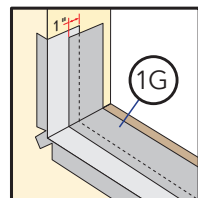
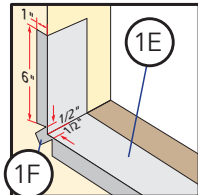

NOTE: Improper placement of shims may result in bowing the bottom of the window.

2 Setting and Fastening the Window

- A. **Apply sealant** to the back of the brickmould or flat casing.
- B. **Insert the window into the opening** by placing the window sill on the sill spacers and tilting the window up. Center the window between jambs.

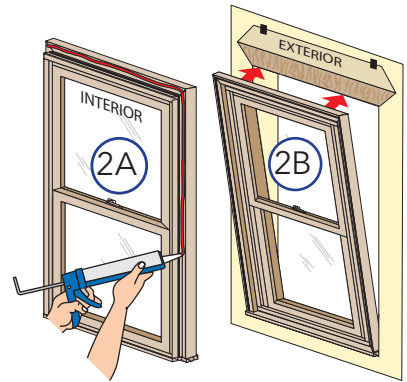

- C. **Level the window across the head.** Adjust the sill shims as necessary.
- D. **Drive 16d galvanized finished nails** at each upper corner through the brickmould and into the wood framing.
- E. **Plumb and square the window** using shims at the locations shown. Adjust shims to plumb and square the window. Keep shims 1/2" short of window frame depth.

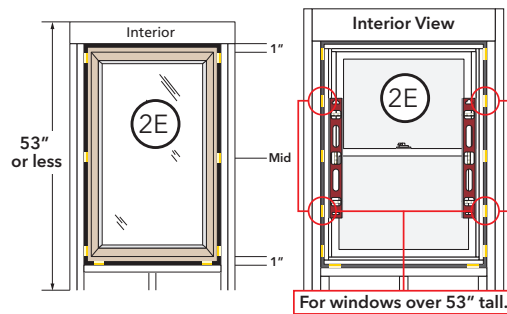
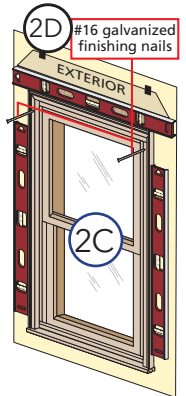

NOTE: DO NOT shim above the window or between the sill shims. Additional shims are required at screw locations for large units and combinations. See the anchor instructions at the end of this booklet.



WOOD BRICKMOULD WINDOW AFTER BUILDING WRAP – FOR USE IN WOOD FRAME WALLS (CONTINUED)

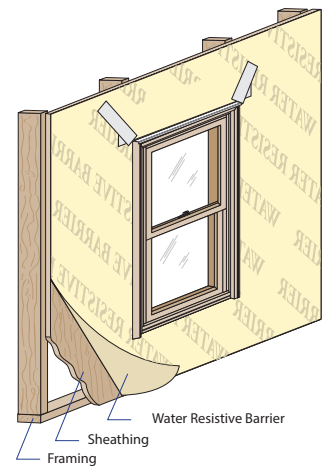
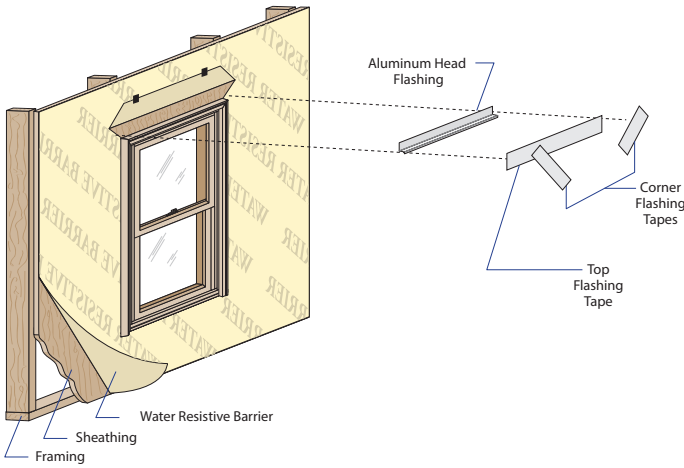

2 Setting and Fastening the Window (continued)

F. Check window operation.

Vent Awning and Casement: Refer to applicable hardware instructions. Unlock and open the window to remove the shipping spacers. Open and close the window to test for proper operation.

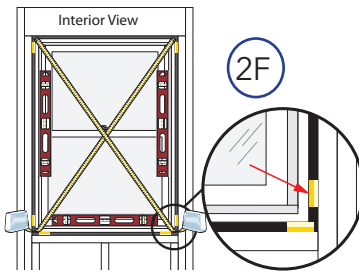

Double-Hung: Cut the checkrail bands (if applicable) and remove shipping spacers. Open, close and tilt the sashes to test for proper operation. Check for equal sash to frame reveal from top to bottom.

NOTE: Adjust shims to correct any issues with plumb, square, operation or reveal. If necessary, secure window frame to ensure window placement and sash to frame reveal is maintained.

G. Close and lock the window.

H. Finish driving #16 galvanized finish nails through the brickmould. Space nails 4" max. from corners and 10" apart between nails.



Building Wrap Cutting Patterns for Window Shapes

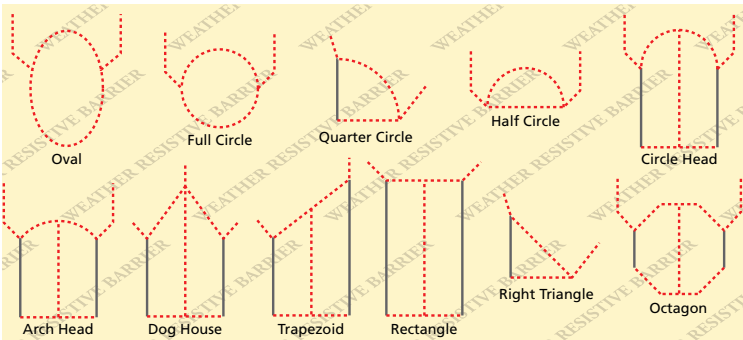

3 Integrating with the Building Wrap

- A. **Apply a bead of sealant** along the top of the brickmould where it meets the wall. Continue the sealant along the edges of the brickmould to the front corner.
- B. **Install Head Flashing** by pressing it into the sealant and securing it to the wall using roofing nails.

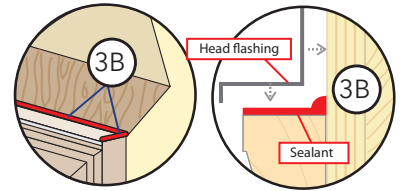

- C. **Cut a piece of flashing tape 4" longer than the brickmould width.**

- D. **Apply the flashing tape** over the head flashing and onto the sheathing so it extends past the brickmould 2" each side.

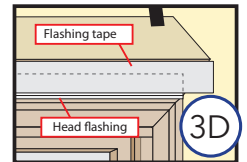

- E. **Fold down top flap** of weather resistive barrier.
- F. **Apply flashing tape to top diagonal cuts.** Cut pieces of flashing tape at least 1" longer than each diagonal cut. Lap tape 1" past end of cut onto weather barrier. Overlap multiple pieces of tape by 1" when necessary.

NOTE: PRESS ALL FLASHING TAPE DOWN FIRMLY.

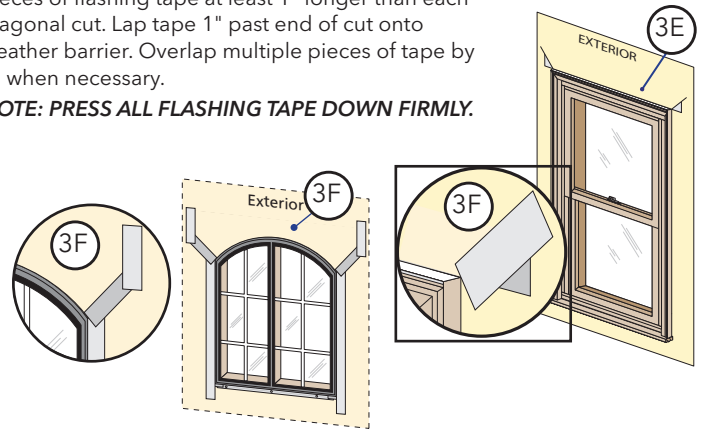

- G. **Install interior sealant.** Refer to the interior sealant instructions at the end of this booklet.
- H. **Install exterior sealant.** (After wall cladding is installed) Refer to the exterior sealant instructions at the end of this booklet.



BRICKMOULD OR FLUSH FLANGE WINDOWS INTO MASONRY CONSTRUCTION – ONTO WOOD BUCK AND/OR PRE-CAST CONCRETE SILLS

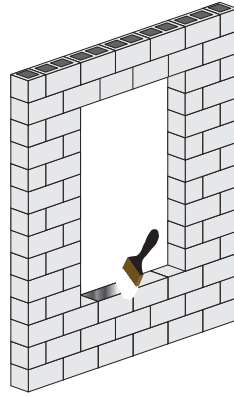

1 Prepare the Opening

Refer to the installation preparation section at the beginning of this booklet.

- A. **Apply water resistant coating.** Extend the coating into the opening on all four sides and onto the wall surface at least 9". The water resistant coating may be a self-adhered sheet membrane (SASM) or a liquid applied flashing. Ensure continuity between the water resistant coating in the opening and the rest of the wall surface. SASM's must be overlapped in a water shed fashion. Apply all water resistant coatings according to the manufacturer's directions.

NOTE: Allow liquid flashing to dry according to the manufacturer's recommendations.

- B. **Apply 2 beads of sealant** to the masonry opening where the wood buck will be attached.

NOTE: Ensure the sealant is compatible with the water resistant coating.

- C. **Pre-drill and fasten the treated wood buck** to the masonry opening using code-approved fasteners.

- D. **Apply water resistant coating (optional)** over the wood buck and onto the masonry opening. If using liquid applied flashing, allow it to dry according to the manufacturer's recommendations before proceeding.

For vinyl windows with 1/2" or 5/8" flanges on Pre-Cast Concrete sills, use steps 1G, 1H, and 1I.

- E. **Install and level sill shims.** Place 1" wide x 1/4" to 3/8" thick shims 1/2" from each side. Keep shims back 1/2" from interior face of window. Place additional shims under each mullion and sliding window interlocker.

For vinyl windows, add shims so maximum spacing is 18".

- F. **Attach shims to prevent movement after they are level.**

NOTE: Improper placement of shims may result in bowing the bottom of the window.

- G. **Apply a continuous, 3/8" tall bead of sealant** on the surface of the buck where the Flush Flange or Brickmould will be placed at the sides and top only. **Do NOT apply sealant at the sill.**

Proceed to Step 2.

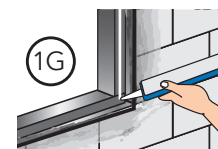
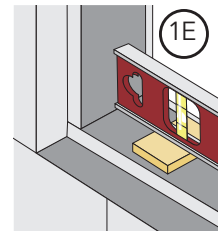
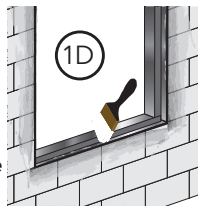
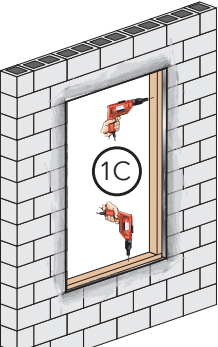
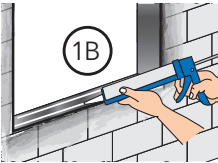
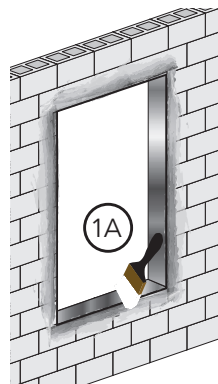

1 Prepare the Opening (continued)

Vinyl windows with 1/2" or 5/8" flanges on Precast Concrete Sills.

- H. Place two 3/8" beads of sealant on the precast sill. Place the first bead 1-1/2" from the exterior edge of the sill. Place the second bead 1/2" from the exterior edge of the sill.

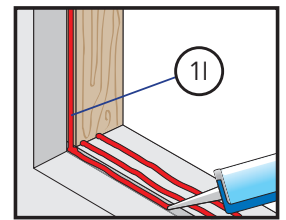
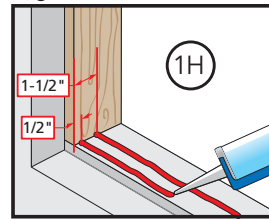

- I. Place a bead of sealant on the front edge of the precast sill, connecting it to the bead of sealant on the surface of the wood buck.

2 Prepare the Window

Frame Screw Installation

- A. **Prepare the frame (if applicable).**

Remove interior frame covers—Impervia casement.

- B. **Drill pilot holes** (if necessary) in the new window frame. See the anchor instructions at the end of this booklet.

NOTE: WHERE POSSIBLE, USE FRAME SCREWS AT THE SILL TO AVOID PENETRATING THE INTERIOR SEAL. DO NOT SCREW THROUGH THE SILL WHEN A SILL TRACK IS PART OF THE WINDOW'S WEEP SYSTEM.

Clip Installation

- C. **Pre-bend clips** if anchors will be installed into the interior wall surface (Metal clips only).

See the anchor spacing instructions at the end of this booklet.

- D. **Secure clips to the window frame:**

Encompass by Pella® / Pella® 150 Series / Pella® 250 Series

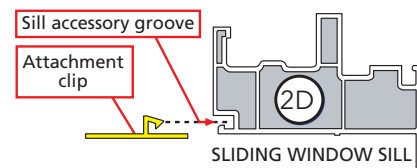



BRICKMOULD OR FLUSH FLANGE WINDOWS INTO MASONRY CONSTRUCTION – (CONTINUED)

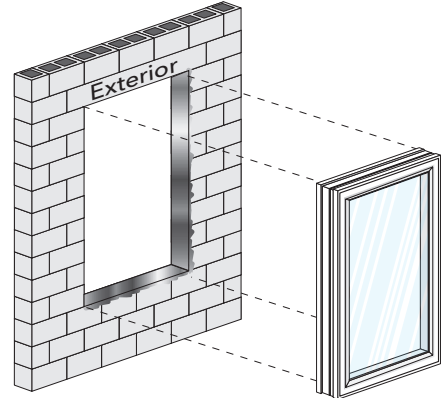
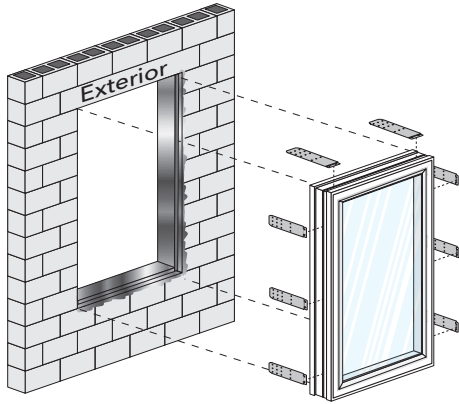

2 Prepare the Window (continued)

Pella® Impervia®

- E. Slide clips into the frame grooves.
NOTE: Pre-bend clips if anchors will be installed into the interior wall surface (Metal clips only).
- F. Secure the clips to the frame. Use a small piece of flashing tape to prevent the clips from sliding out of place (Pella® Impervia®).

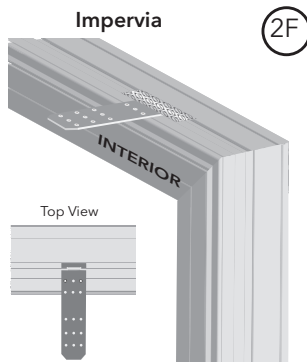

Architect Series (850) & Pella® Lifestyle Series

- G. Install the clips into the fin grooves. Start one corner of the clip in the fin groove. Tap the corner into the fin groove with a hammer, then continue to tap the other corner until the clip is locked into the groove.
- H. Secure the clips to the frame. Drive one #8 x 5/8" screw through the slotted hole in the center of the clip.

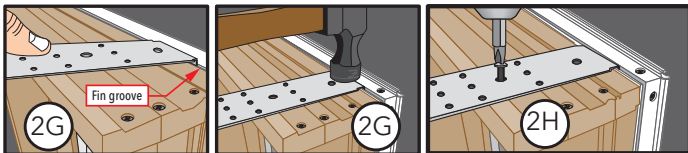

Alternatively, it is acceptable to use two #6 x 5/8" screws through the clip with the clip on its back and not engaged in the fin groove.

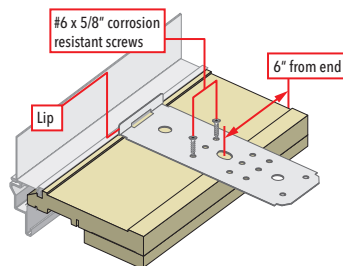

3 Set and Fasten the Window

- A. Insert the window into the opening by placing the front edge of the window sill on the opening sill and tilting the window up. Center the window between jambs.
- B. Wood Brickmould units only: Drive 16d galvanized finished nails at each upper corner through the brickmould and into the wood buck.
- C. Place sealant under each clip (if applicable).
- D. Place shims and begin driving screws at each predrilled hole in the window frame or each clip. Install masonry screws at least 2" from wall edge.

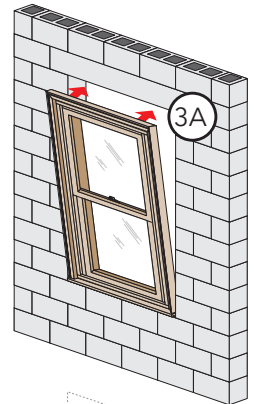

Refer to the anchor instructions at the end of this booklet.

NOTE: Ensure the window flange or brickmould remains firmly embedded in sealant.

Keep shims 1/2" from the interior surface of the window to allow for a continuous interior seal.

- E. Check window operation.
Vent Awning and Casement: Refer to applicable hardware instructions. Unlock and open the window to remove the shipping spacers. Open and close the window to test for proper operation.

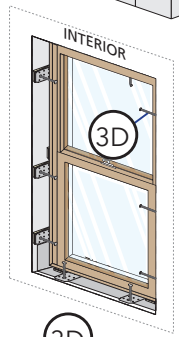

Double-Hung: Cut the checkrail bands (if applicable) and remove shipping spacers. Open, close and tilt the sashes to test for proper operation. Check for equal sash to frame reveal from top to bottom.

- F. Check for plumb, level, and square. Make any necessary adjustments to shims and finish installing frame screws or clip anchors.
- G. Adjust the screw jacks (if applicable) with a screwdriver. Turn clockwise to move the frame toward the sash.

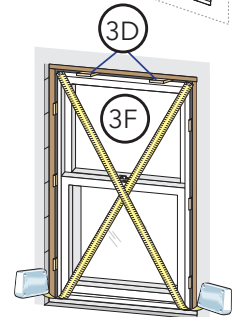

Tilt the lower sash inward to locate the jamb screws in the interior balance channel near the checkrail.

- H. Install interior sealant. Refer to the interior sealant instructions at the end of this booklet. Use additional sealant around clips to prevent air and water infiltration.
- I. Install exterior sealant between the edge of the flush flange or brickmould and the finished wall material. Refer to the exterior sealant instructions at the end of this booklet.

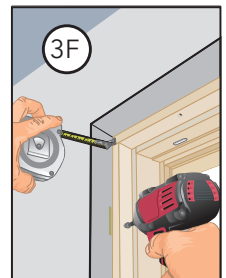



POCKET REPLACEMENT WITH FLUSH FLANGE – FOR THE INSTALLATION OF NEW FLUSH FLANGE WINDOWS IN EXISTING ALUMINUM FRAMES WITH STUCCO WALLS IN ARID CLIMATES

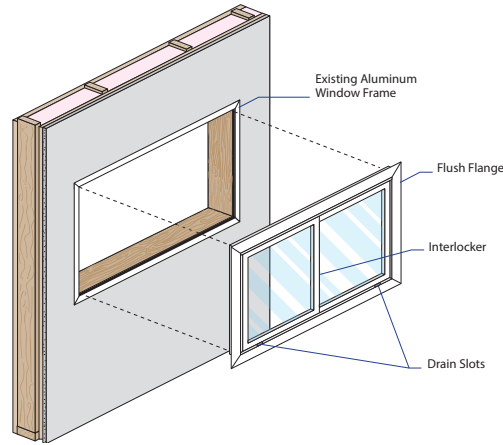

1 Prepare the Opening

- A. **Measure the width and height** of the opening in the remaining aluminum frame after sash/glass removal. The new window must be 1/2" to 3/4" smaller in width and height.
- B. **Remove the sash and/or glass** from the existing aluminum window. Refer to the sash removal instructions at the beginning of this booklet.
- C. **Clean the existing frame** so it is free of dirt and debris. Ensure the weep holes are open and clear.
- D. **Apply sealant** at the lower corners where the jamb and sill of the existing frame meet.
- E. **Cut and/or rip wood blocking** to fit inside the drywall return and to a depth 1/4" less than the existing frame.
- F. **Cut one piece of flashing tape** 6" longer than the existing aluminum frame width.

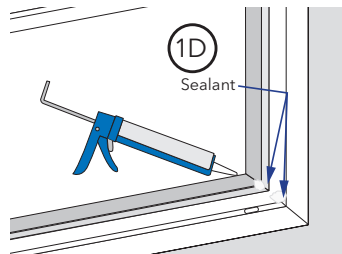
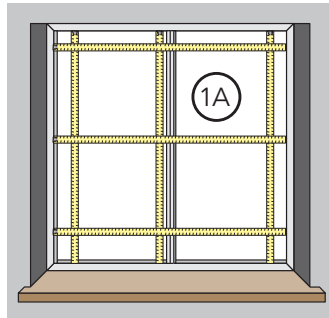

- G. **Apply the tape** over the wood blocking so it extends 1" into the first sill cavity of the existing aluminum frame and goes 3" up each jamb.
- H. **Cut and or rip treated or composite blocking** to fit in the sill cavities of the existing aluminum frame. The height of the blocking should match the tallest leg of the existing aluminum frame.
- I. **Cut notches in the sill filler** blocking to align with the weep holes in the existing aluminum frame.
- J. **Install the sill filler** blocking into the sill cavity. Ensure the existing weeps are not blocked.

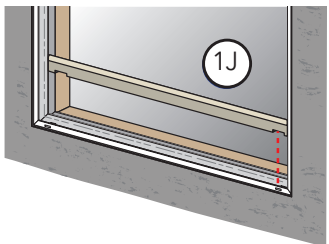
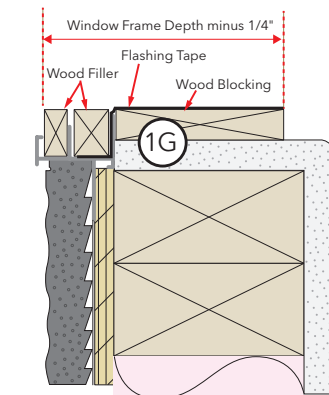

1 Prepare the Opening (continued)

- K. **Install and level sill shims.** Place 1" wide x 1/4" to 3/8" thick shims 1/2" from each side. Keep shims back 1/2" from the interior face of the window. Place additional shims under each mullion and sliding window interlocker.
 - L. **Attach shims** to prevent movement after they are level.
- NOTE: Improper placement of shims may result in bowing the bottom of the window.**
- M. **Dry fit the window into the opening** from the exterior. Confirm the flush flange will overlap the existing aluminum frame or stucco by at least 3/4" on all 4 sides.

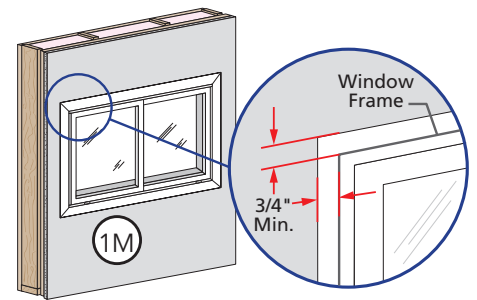
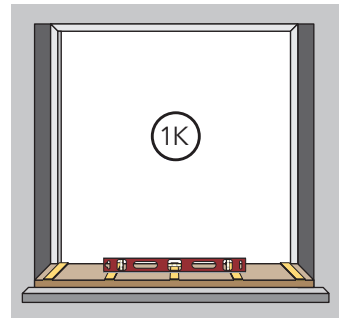

NOTE: Fix any problems before proceeding.
If the flange(s) must be trimmed to fit in a recessed opening, use a utility knife or circular saw for vinyl or fiberglass flanges. Use an electric scissor-style shear for aluminum flanges.



POCKET REPLACEMENT WITH FLUSH FLANGE (CONTINUED)

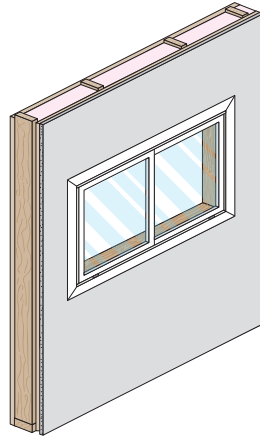

2 Prepare the Window

- A. **Drill pilot holes** (if necessary) in the new window frame. Refer to the anchor instructions at the end of this booklet.

NOTE: Some vinyl windows require attachment clips. Refer to the anchor instructions at the end of this booklet.

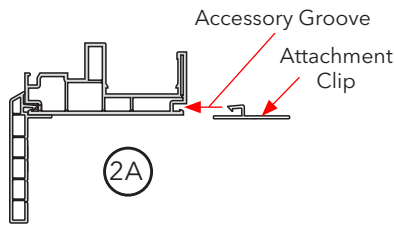

- B. **Place a 3/8" diameter bead of sealant** on the exterior perimeter of the existing aluminum window frame.

Leave 2" gaps in the sealant line at each weep hole.

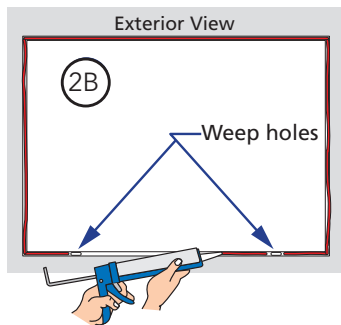

3 Set and Fasten the Window

- A. **Insert the window into the opening** by placing the front edge of the window sill on the opening sill and tilting the window up. Center the window between jambs.

- B. **Place sealant under each clip** (if applicable).

- C. **Drill clearance holes** at each pre-drilled hole in the new window frame through the existing aluminum frame.

- D. **Place shims and begin driving screws** at each predrilled hole in the window frame or each clip. Add additional shims at the ends of the meeting rails and as necessary to ensure even reveal between the frame and sashes.

NOTE: Keep shims 1/2" from the interior surface of the window to allow for a continuous interior seal.

Refer to the anchor instructions at the end of this booklet.

NOTE: Ensure the window flange remains firmly embedded in sealant.

- E. **Cut the checkrail band** at each jamb and remove. Tilt the sashes to remove checkrail clips. (If applicable)

Pella® Lifestyle Series Dual-Pane only: Push the remaining tails of the band into the jambliner holes.

- F. **Check for plumb, level, square and window operation.** Make any necessary adjustments to shims and finish installing frame screws and/or clip anchors.

- G. **Adjust the screw jacks** (if applicable) with a screwdriver. Turn clockwise to move the frame toward the sash.

Tilt the lower sash inward to locate the jamb jacks in the interior balance channel near the checkrail.

- H. **Install interior sealant.** Refer to the interior sealant instructions at the end of this booklet. Use additional sealant around clips to prevent air and water infiltration.

- I. **Install exterior sealant** around the edge of the flush flange on all 4 sides. Leave 2" gaps in the sealant below each existing frame weep hole location.

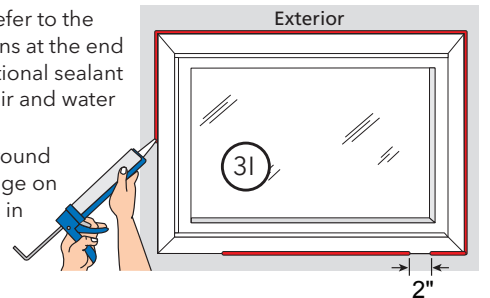
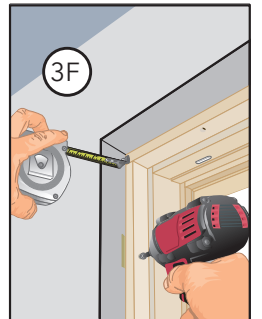
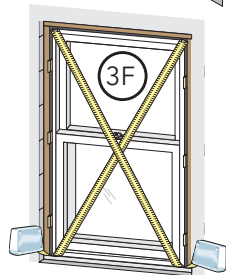
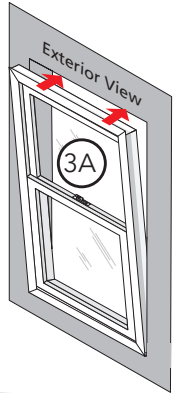



FULL FRAME REPLACEMENT WITH WOOD OR ENDURACLAD BRICKMOULD – FULL FRAME RE-PLACEMENT OF WOOD BRICKMOULD WINDOWS WITH NEW PELLA® ENDURACLAD® EXTERIOR TRIM OR WOOD BRICKMOULD PRODUCTS

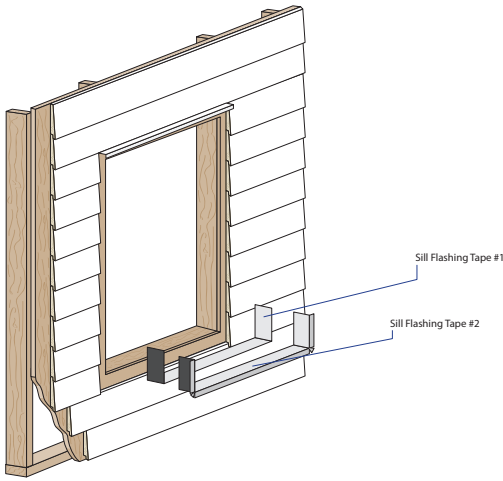

1 Prepare the Opening

Refer to the brickmould frame removal instructions at the beginning of this booklet.

- A. **Measure the width and height** of the brick/siding opening and the rough opening. The new brickmould must be 1/2" to 3/4" smaller than the brick/siding opening. The new window frame must be 1/2" to 3/4" smaller than the rough opening.
- B. **Repair the wall surface around the opening** (if necessary) by installing new blocking flush with the surface of the existing sheathing. Repair the existing building wrap with by cutting it flush with the rough opening and covering any gaps with flashing tape.

Applications with Building Wrap

- C. **Install head flashing** by applying sealant to the back of the upturned leg and inserting the upturned leg behind the building wrap as shown.

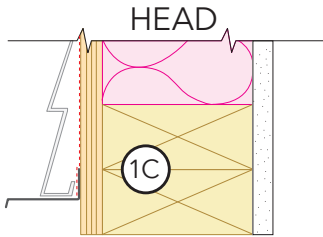

Applications without Building Wrap (steps D and E).

- D. **Cut a piece of flashing tape** equal to the width of the rough opening.
- E. **Apply the tape across the top** of the rough opening so it extends onto the surface of the wall at least 1".

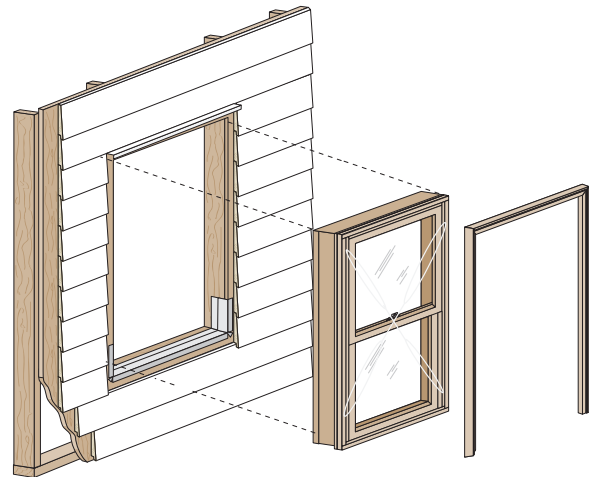
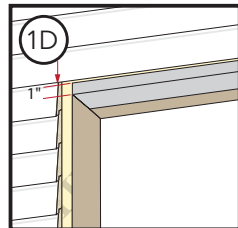

1 Prepare the Opening (continued)

In place of the existing wood subsill, install a sloped sill. (Steps F-J).

- F. **Cut an approx. 1/4" thick spacer** equal to the width of the rough opening. Reduce the thickness (if necessary) to maintain enough opening height for window installation. Set the spacer along the interior of the sill.
- G. **Cut 3/4" thick blocking** (typically a 1x6) equal to the width of the rough opening.
- H. **Apply a 1/4" diameter bead of sealant** along the sides and front edge of the opening sill.
- I. **Apply a bead of low expansion foam** along the center of the rough opening sill.
- J. **Set and fasten the 3/4" thick blocking** on the spacer with nails or screws creating a sloped surface.

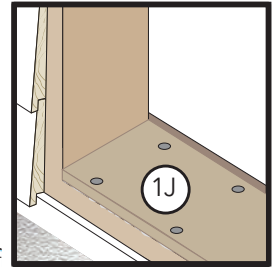
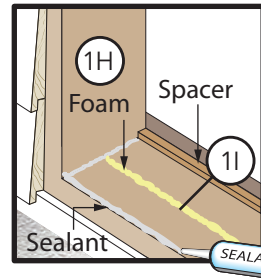
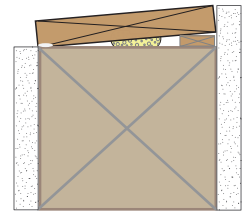

- K. **Cut 2 pieces of flashing tape** 12" longer than opening width.
 - L. **Apply sill flashing tape #1** at the sill extending 1" to the exterior and 6" up each jamb.
 - M. **Cut 1" wide tabs** at each corner by tearing the foil 1/2" each way from corner.
 - N. **Apply sill flashing tape #2** overlapping tape #1 by 1" minimum.
- NOTE: Press all tape down firmly.**

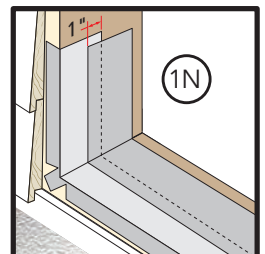
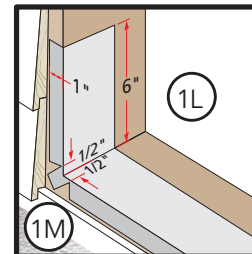

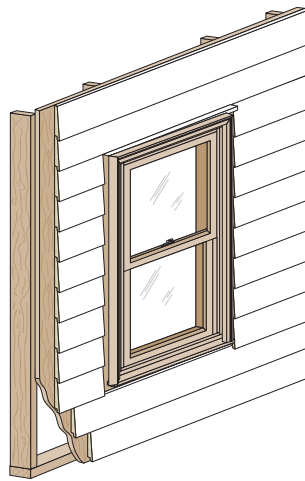

1 Prepare the Opening (continued)

- O. **Install and level wedge shaped sill shims.** Place 1" wide x 1/4" to 3/8" thick shims 1/2" from each side. Place additional shims under each mullion. Keep shims back 1/2" from the interior face of the window. Use wedge shaped shims to make a level surface for the window to set on.
- P. **Attach shims** to prevent movement after they are level.
NOTE: Improper placement of shims may result in bowing the bottom of the window.

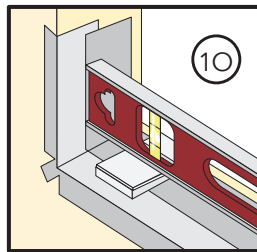

2 Prepare the Window

- A. **Remove the packaging.** Leave installation straps in place. (Enduraclad exterior trim only) Installation straps aide in pulling the brickmould tight against the wall surface.
- B. **For frame screw attachment;** drill pilot holes in the window frame.
- C. **For installation clip attachment;** use two #6 x 5/8" screws through the clip with the clip on its back.

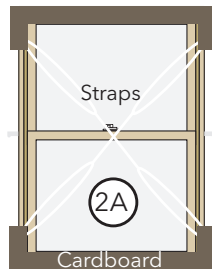

Refer to the screw spacing instructions at the end of this booklet.

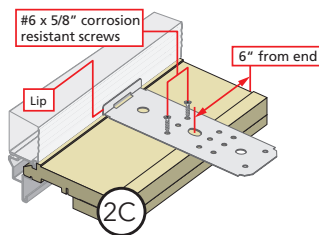

3 Set and Fasten the Window

- A. **Place a continuous 3/8" bead** of sealant on the surface of the wall where the brickmould will be placed. Leave 2" gaps near each jamb along the sill.

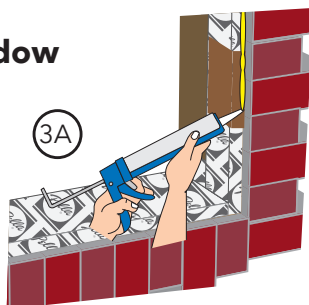

3 Set and Fasten the Window (Continued)

- B. **Insert the window into the opening** by placing the front edge of the window sill on the opening sill and tilting the window up. Center the window between jambs.
- C. **Wood Brickmould units only:** Drive 16d galvanized finished nails at each upper corner through the brickmould and into the wood buck.
- D. **Cut the cord to free up the installation straps** (Enduraclad exterior trim only) and use a quick grip clamp with reversed jaws to push against the wall and pull the window against the opening.
- E. **Place sealant under each clip** (if applicable).
- F. **Place shims and begin driving screws** at each predrilled hole in the window frame or each clip. Use the quick grip clamp to fully embed the brickmould in the sealant and to make the distance from the interior of the new window to the surface of wall equal all around the window.

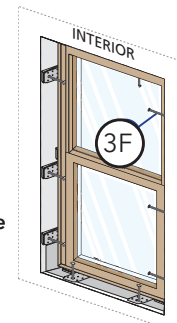
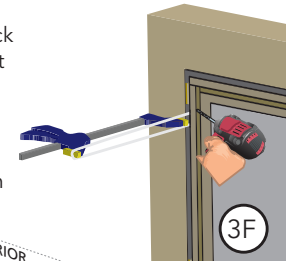
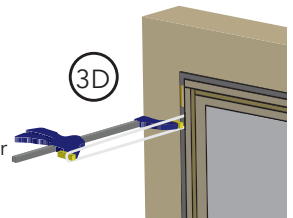

Refer to the anchor instructions at the end of this booklet.

Keep shims 1/2" from the interior surface of the window to allow for a continuous interior seal.

- G. **Check window operation.**

Vent Awning and Casement: Refer to applicable hardware instructions. Unlock and open the window to remove the shipping spacers. Open and close the window to test for proper operation.

Double-Hung: Cut the checkrail bands (if applicable) and remove shipping spacers. Open, close and tilt the sashes to test for proper operation. Check for equal sash to frame reveal from top to bottom.

- H. **Check for plumb, level, and square.** Make any necessary adjustments to shims and finish installing frame screws or clip anchors.
- I. **Install interior sealant.** Refer to the interior sealant instructions at the end of this booklet. Use additional sealant around clips to prevent air and water infiltration (if applicable).
- J. **Install exterior sealant** between the edge of the brickmould and the finished wall material. Refer to the exterior sealant instructions at the end of this booklet.

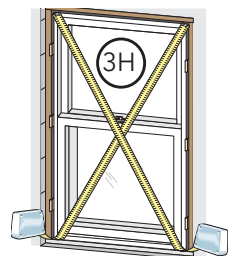



FULL FRAME REPLACEMENT IN STUCCO WITH FLUSH FLANGE – ROUGH OPENING PREPARATION USING WATER MANAGEMENT LINER (PATENT PENDING)

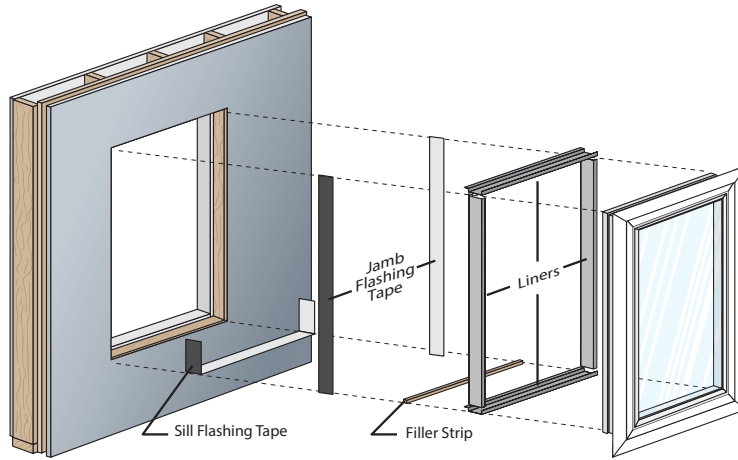

1 Remove the Existing Window

CAUTION: Many windows in older homes are painted with lead-based paint. Removal of old windows may disturb this paint. Proper precautions must be taken to minimize exposure to dust and debris. Consult state or local authorities for more information.

REMEMBER TO USE APPROPRIATE PERSONAL PROTECTIVE EQUIPMENT.

- A. Measure the width and height of the opening inside the drywall return. The new window frame size must be at least 1/2" to 3/4" smaller than this measurement.
- B. Cut through the existing window nailing fin on all sides. Cut against the edge of the frame with an angle grinder or circular saw with diamond blade. Use a reciprocating saw to finish the cutting the corners. Be careful not to chip or crack the stucco.

NOTE: Use a vacuum with a HEPA filter to minimize dust while cutting.

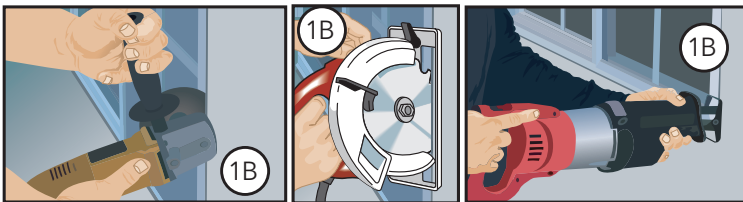

Maintain a safe distance between the vacuum and power tool.

- C. Remove the existing window and dispose of it properly.
- D. Make any modifications or repairs to the opening at this time.
- E. Cut the stucco and existing window fin along the opening sill to ensure the stucco does not project above the sill framing.

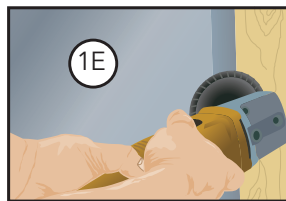

- F. Clean the rough opening by vacuuming all dust and debris.

2 Prepare the Window

- A. Place a 3/8" bead of sealant (or enough to cover the area) between the stucco and the wood framing at the jambs and sill. Do not seal across the top.
- B. Press the sealant into irregularities and smooth it with a putty knife.
- C. Place a 3/8" bead of sealant at each corner of the opening from the stucco to the interior edge of the rough opening.

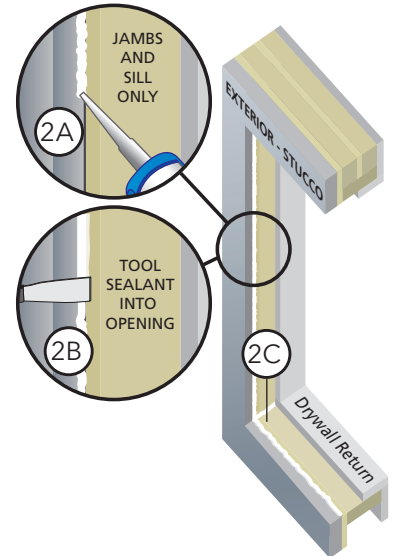

- D. Cut one piece of flashing tape 12" longer than the width of the rough opening.
- E. Apply the tape across the sill and 6" up each jamb. Press the tape down firmly over the stucco, exposed sealant and up the surface of drywall.
- F. Cut 2 pieces of tape equal to the height of the rough opening.
- G. Apply the pieces at each jamb in the same manner as the sill, overlapping the sill tape.

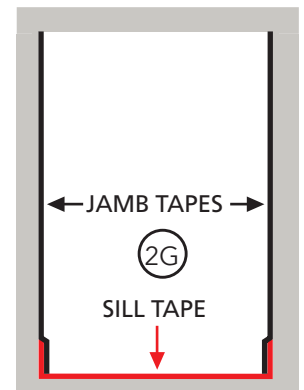
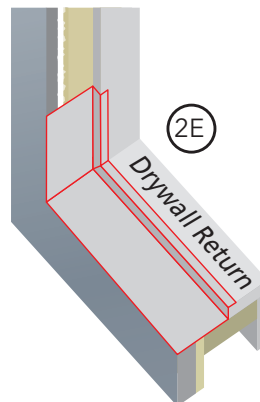



FULL FRAME REPLACEMENT IN STUCCO WITH FLUSH FLANGE (CONTINUED)

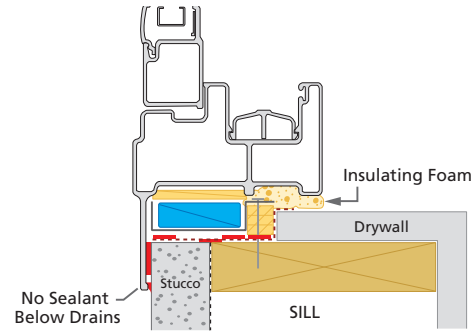
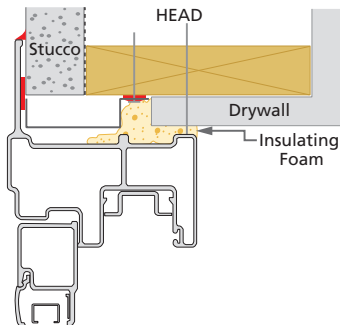

2 Prepare the Window (continued)

- H. Cut a 1/2" thick wood or composite filler strip equal to the rough opening width. Rip it to a width equal to the distance from the exterior surface of drywall to the surface of the stucco - 1-5/8".
- I. Apply a 3/8" bead of sealant across the sill on top of the flashing tape against the drywall and along the end.
- J. Set the filler strip in the sealant and secure it with screws 6" from the ends and every 16".

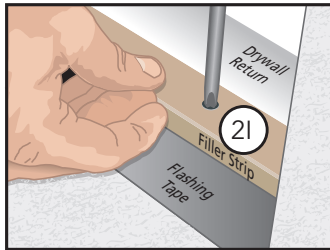
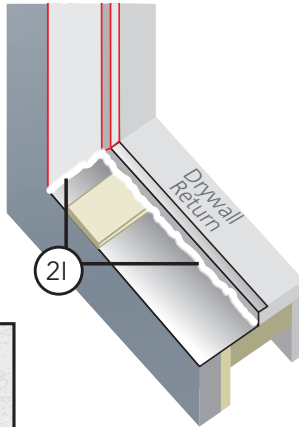

- K. Cut the aluminum extruded sill liner equal to the width of the rough opening.
- L. Cut 1" wide weep slots 2" from each end.



- M. Apply two lines of 3/8" sealant across the opening sill and join them at the ends.
- N. Secure the sill liner over the sealant with 1.25" self-drilling pan head screws 6" from the ends and every 12".
- O. Apply Sealant along each end of the sill liner.
- P. Fill any gaps with sealant along the joint between the stucco and the bottom of the sill liner.
- Q. Tool the sealant smooth. Remove excess sealant below the weep slots.

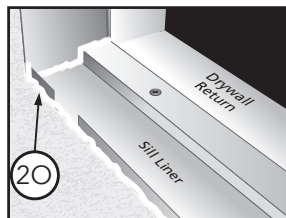
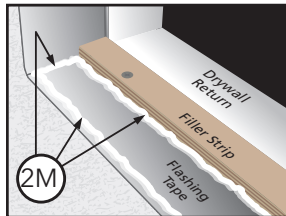

2 Prepare the Window (continued)

- R. Cut the head liner equal to the opening width.
- S. Make 1/4" deep by 3/4" wide tabs, bending them down as shown.
- T. Apply a 3/8" bead of sealant across the top of the opening 1-3/4" from the surface of the stucco and 1" down the sides.
- U. Secure the head liner over the sealant using self-drilling screws 6" from ends and every 12". The liner may be shifted to allow the stucco to extend below the rough opening.

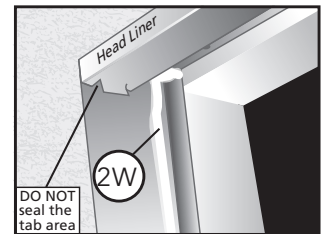
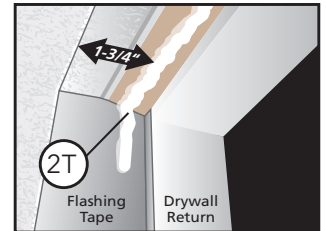
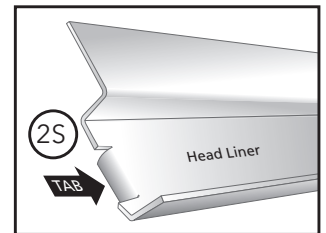
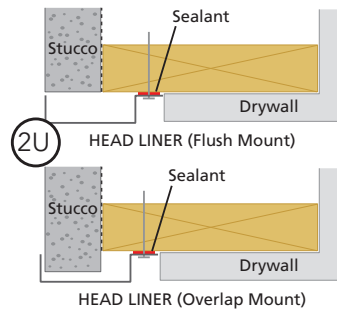

- V. Cut two jamb liners to fit between the head and sill liners.
- W. Apply 3/8" beads of sealant down each jamb 1-3/4" from the surface of the stucco.
- X. Secure the jamb liner over the sealant using self-drilling screws 6" from ends and every 12". The liner may be shifted to allow the stucco to extend below the rough opening.
- Y. Seal the upper corners where the head and jamb liners meet.
- Z. Seal the lower corners at the interior leg only.
- AA. Place composite shims in the sill liner under the location where the installation shims will be installed.
- BB. Refer to the Pocket Replacement with Flush Flange instruction beginning at step 1 K in this booklet to complete the installation.

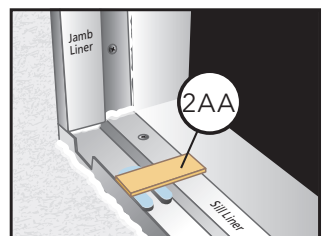
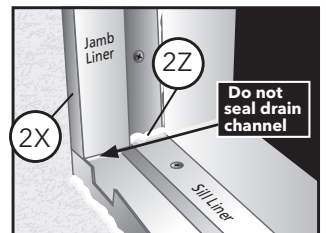



FULL FRAME REPLACEMENT IN MASONRY CONSTRUCTION WITH STUCCO FOR FLUSH FLANGE WINDOWS

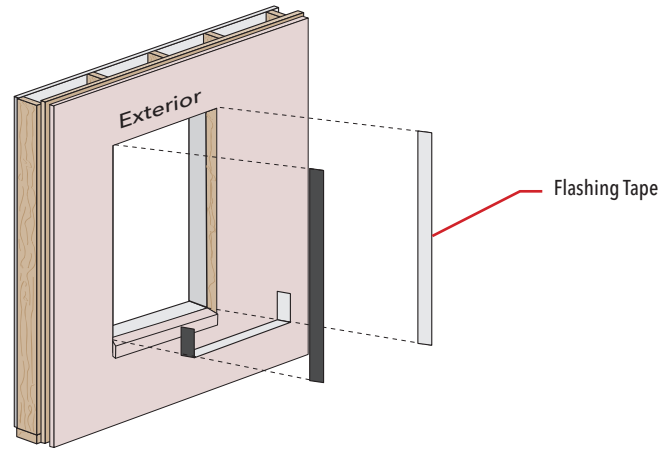
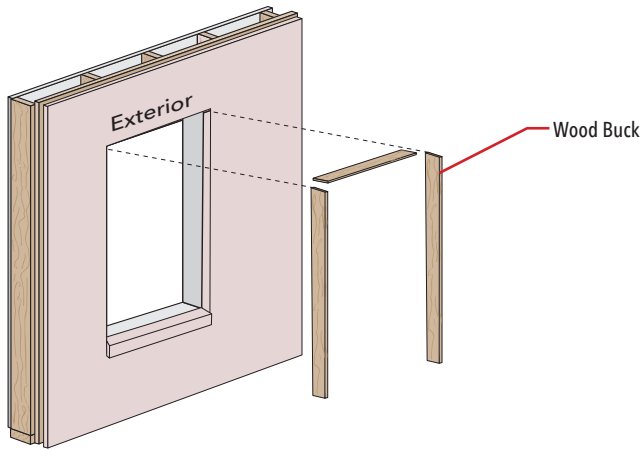

1 Prepare the Opening

Refer to the full frame removal instruction at the beginning of this booklet.

- A. **Measure the width and height of the opening.**
The window must be approximately 1/2" smaller in width and height.
If replacing a wood buck, trim back any finish materials to accommodate the new wood buck.
- B. **Apply 2 beads of sealant** to the masonry opening where the wood buck will be attached.
- C. **Fasten the treated wood buck** to the masonry opening using code-approved fasteners.
- D. **Apply sealant** at the corners of the wood buck and at the intersection of the wood buck and stucco.
- E. **Apply flashing tape from the stool over the top of the pre-cast concrete sill and 6" up each side.**
- F. **Apply water resistant coating** or flashing tape over the wood buck. If using liquid applied flashing, allow it to dry according to the manufacturer's recommendations before proceeding.
- G. **Install and level sill shims.** Place 1" wide x 1/4" to 3/8" thick shims 1/2" from each side. Keep shims back 1/2" from interior face of window. Place additional shims under each mullion and sliding window interlocker.
For vinyl windows, add shims so maximum spacing is 18".
- H. **Attach shims to prevent movement after they are level.**
NOTE: Improper placement of shims may result in bowing the bottom of the window.
- I. **Measure the opening in the stucco** and the size of the window to the tip of the flanges. If necessary, trim the flange.
For Vinyl windows with 1/2" or 5/8" flanges on Pre-Cast Concrete sills use steps 1J, 1K, and 1L if there is not enough space for shims. If sill shims were used, skip to step 2.
- J. **Apply a continuous, 3/8" tall bead of sealant** on the surface of the buck where the Flush Flange will be placed at the sides and top only.
Do NOT apply sealant at the sill.
Proceed to Step 2.

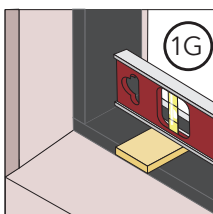
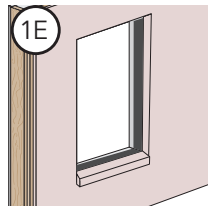
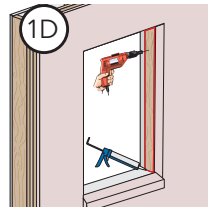
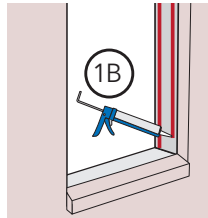
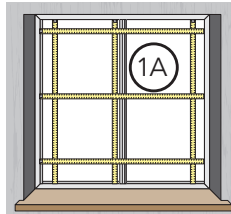

1 Prepare the Opening (continued)

- K. **Place two 3/8" beads of sealant on the precast sill.** Place the first bead 1-1/2" from the exterior edge of the sill. Place the second bead 1/2" from the exterior edge of the sill.
- L. **Place a bead of sealant on the front edge of the precast sill,** connecting it to the bead of sealant on the surface of the wood buck.

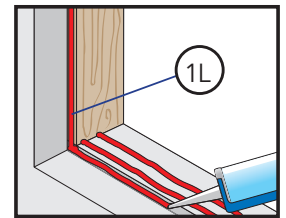
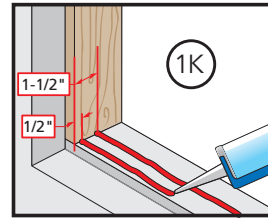

2 Prepare the Window (continued)

Frame Screw Installation

- A. **Prepare the frame (if applicable).**
Remove interior frame covers—Impervia casement.
- B. **Drill pilot holes** (if necessary) in the new window frame. See the anchor instructions at the end of this booklet.
NOTE: WHERE POSSIBLE, USE FRAME SCREWS AT THE SILL TO AVOID PENETRATING THE INTERIOR SEAL. DO NOT SCREW THROUGH THE SILL WHEN A SILL TRACK IS PART OF THE WINDOW'S WEEP SYSTEM.

Clip Installation

- C. **Pre-bend clips** if anchors will be installed into the interior wall surface (Metal clips only).

See the anchor spacing instructions at the end of this booklet.

- D. **Secure clips to the window frame:**

Encompass by Pella® / Pella® 150 Series / Pella® 250 Series

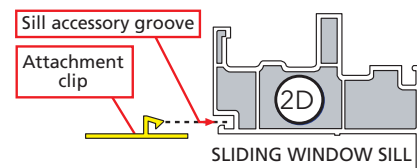



FULL FRAME REPLACEMENT IN MASONRY CONSTRUCTION WITH STUCCO FOR FLUSH FLANGE WINDOWS (CONTINUED)

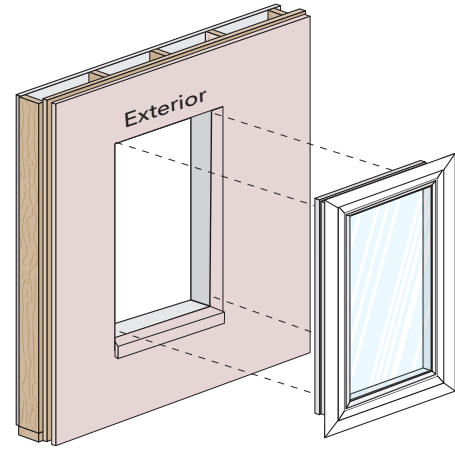
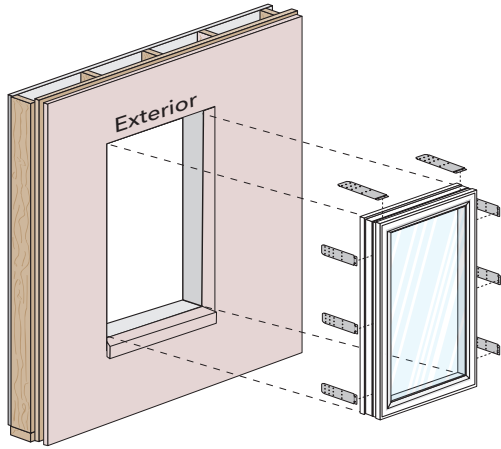

2 Prepare the Window (continued)

Pella® Impervia®

- E. Slide clips into the frame grooves.
NOTE: Pre-bend clips if anchors will be installed into the interior wall surface (Metal clips only).
- F. Secure the clips to the frame. Use a small piece of flashing tape to prevent the clips from sliding out of place (Pella® Impervia®).

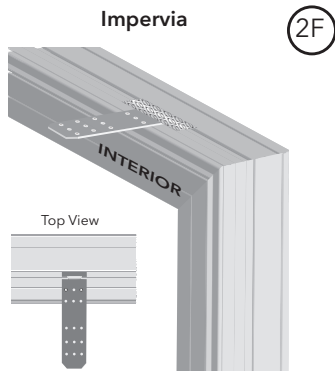

Architect Series (850) and Pella® Lifestyle Series

- G. Install the clips into the fin grooves. Start one corner of the clip in the fin groove. Tap the corner into the fin groove with a hammer, then continue to tap the other corner until the clip is locked into the groove.
- H. Secure the clips to the frame. Drive one #8 x 5/8" screw through the slotted hole in the center of the clip.

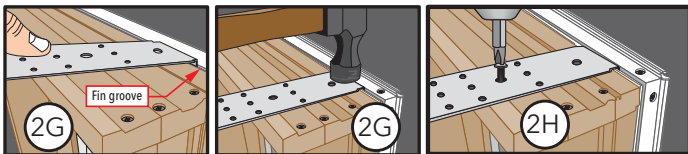

Alternatively, it is acceptable to use two #6 x 5/8" screws through the clip with the clip on its back and not engaged in the fin groove.

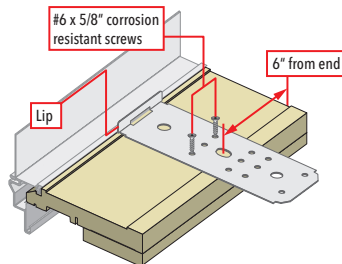

3 Set and Fasten the Window

- A. Insert the window into the opening by placing the front edge of the window sill on the opening sill and tilting the window up. Center the window between jambs.
- B. Place sealant under each clip (if applicable).
- C. Place shims and begin driving screws at each predrilled hole in the window frame or each clip. Install masonry screws at least 2" from wall edge.

Refer to the anchor instructions at the end of this booklet.

NOTE: Ensure the window flange or brickmould remains firmly embedded in sealant.

Keep shims 1/2" from the interior surface of the window to allow for a continuous interior seal.

- D. Check window operation.
Vent Awning and Casement: Refer to applicable hardware instructions. Unlock and open the window to remove the shipping spacers. Open and close the window to test for proper operation.

Double-Hung: Cut the checkrail bands (if applicable) and remove shipping spacers. Open, close and tilt the sashes to test for proper operation. Check for equal sash to frame reveal from top to bottom.

- E. Check for plumb, level, and square. Make any necessary adjustments to shims and finish installing frame screws or clip anchors.
- F. Adjust the screw jacks (if applicable) with a screwdriver. Turn clockwise to move the frame toward the sash. Tilt the lower sash inward to locate the jamb jacks in the interior balance channel near the checkrail.
- G. Install interior sealant. Refer to the interior sealant instructions at the end of this booklet. Use additional sealant around clips to prevent air and water infiltration.

- H. Install exterior sealant between the edge of the flush flange or brickmould and the finished wall material. Refer to the exterior sealant instructions at the end of this booklet.

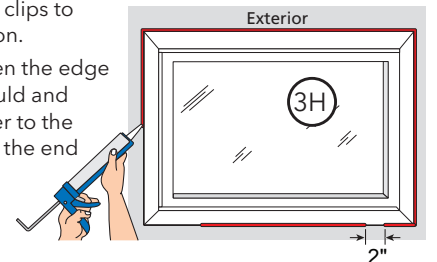
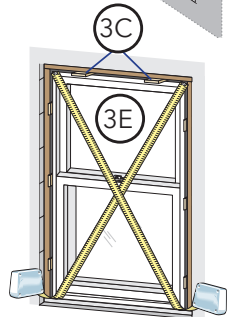
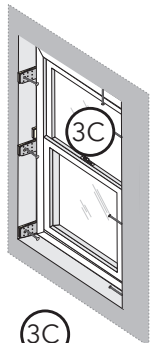
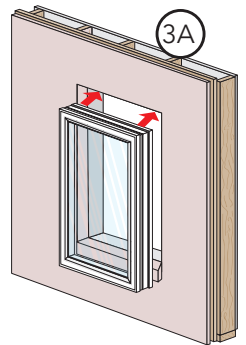



FLUSH FLANGE AND BRICKMOUND FRAME WINDOW ANCHOR INSTRUCTIONS

Note: Standard performance only. Additional anchoring may be required for performance upgrade, impact-resistant products or to comply with local building code requirements.

Place Frame Screws or Clips at the Locations Indicated

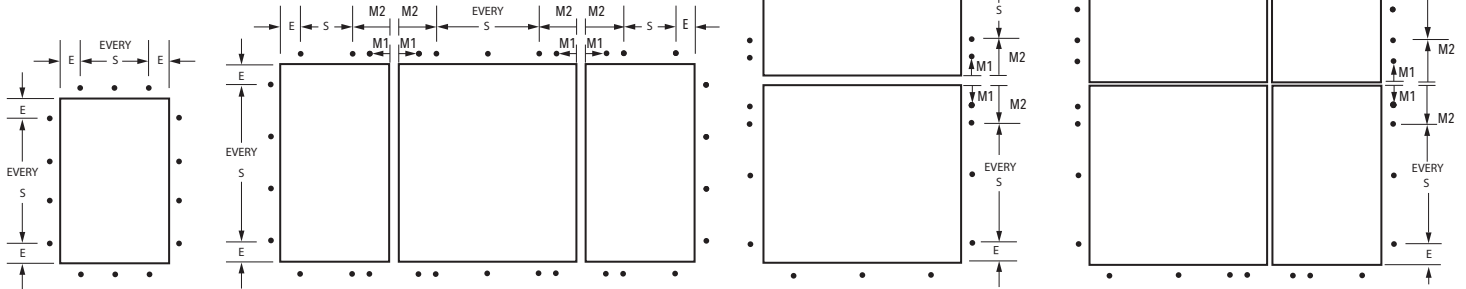

ARCHITECT SERIES® (850) AND PELLA® LIFESTYLE SERIES WINDOW ANCHOR SPACING INSTRUCTIONS

Product	Edge Spacing (E)	Max. Intermediate Spacing (S)	First Mullion Anchor (M1)	Second Mullion Anchor (M2)	Fastener	Special Notes
					Wood **	
Casement/Awning	6"	16"	3"*	6"	#8x3" Finish Screw	
Double- or Single- Hung	6"	16"	3"*	6"	#8x3" Finish Screw	For windows with integrated Rolscreen® retractable screen, drive jamb screws at each factory pre-punched hole in the jamb liner. Add fasteners as necessary, driving the head past flush of the jamb liner. Avoid Rolscreen components in the head and sill.
Fixed Frame	6"	16"	3"*	6"	#8x3" Finish Screw	
Monumental DH > 54" x 96"	6" (head)	16" (head)	3" *	6" *	#8 x 3" Screw	Remove sashes and jamb liners. Drive 1 screw through each jamb liner support clip (top, bottom, checkrail and center of each sash). Drive 2 additional screws through the frame (or secure clips) 3" above and below the checkrail on each jamb. Drive additional screws through the frame (or secure clips) centered between each jamb liner support clip.

* M1 anchor required if design pressure exceeds 20 psf.

** For light gauge steel framing, use #10 self-drilling/self-tapping screws; For concrete or masonry, use 3/16" masonry screws with 1-1/4" minimum embedment.

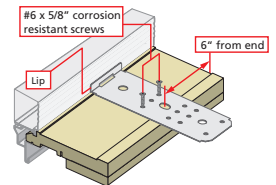
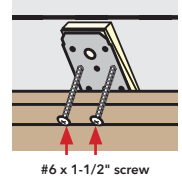

1/8" Pilot Hole Locations

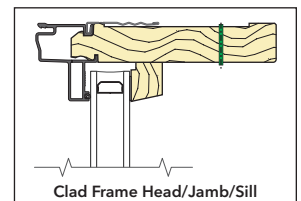
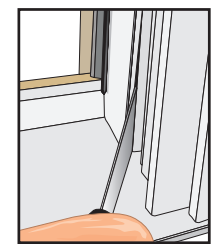
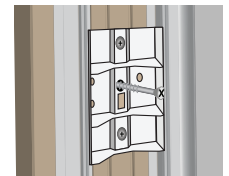
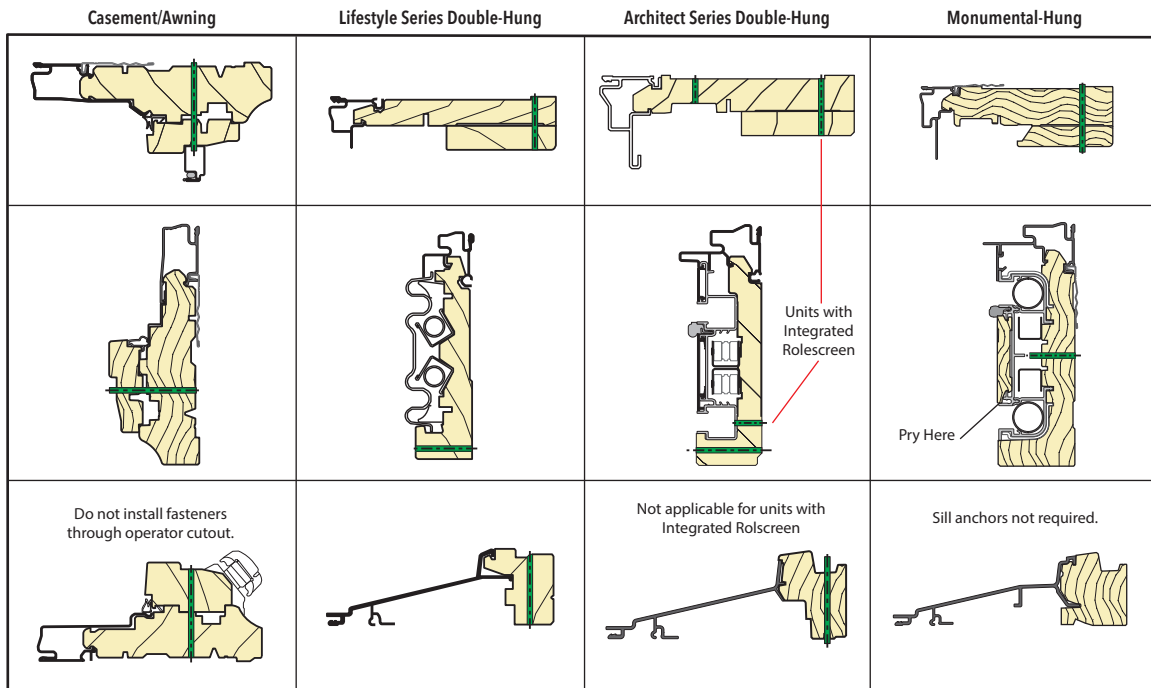



FLUSH FLANGE AND BRICKMOUND FRAME WINDOW ANCHOR INSTRUCTIONS (CONT.)

Note: Standard performance only. Additional anchoring may be required for performance upgrade, impact-resistant products or to comply with local building code requirements.

PELLA® IMPERVIA WINDOW ANCHOR SPACING INSTRUCTIONS

Product	Edge Spacing (E)	Max. Intermediate Spacing (S)	First Mullion Anchor (M1)	Second Mullion Anchor (M2)	Fastener	Special Notes
					Wood**	
Casement/Awning	6"	16"	None	6"	#8 x 3" Pan Head (provided)	Head and Sill anchors not required when frame width < 42".
Single-Hung/Sliding Window	6"	16"	None	6"	#8 x 3" Pan Head (provided)	Do not use Frame screws through the sill.
Double-Hung	6"	16"	None	6"	#8 x 3" Pan Head (provided)	Sill frame screw anchors are not required.
Direct Set	4"	15"	None	4"	#10x3" Pan Head (Provided)	Remove interior frame covers by inserting a putty knife as indicated and rotating to slide the cover interior and disengage from the glass stop. Install screws at pre-marked locations. Utilize 5/32" pilot drill and for masonry applications pilot drill 3/8" pilot hole through interior wall only. (See Illustrations below.)

* = Use Factory Drilled installation holes if present.

** = For light gauge steel framing, use #10 self-drilling/self-tapping screws; For concrete or masonry, use 3/16" masonry screws with 1-1/4" min. embedment. Install hole plugs after driving screws.

Install hole plugs after driving screws, (No plugs on Direct Set units).

Clip Anchor Method Only: Slide clips into the frame groove and locate per the anchor spacing instructions. Use a small piece of flashing tape to hold the clips in place.

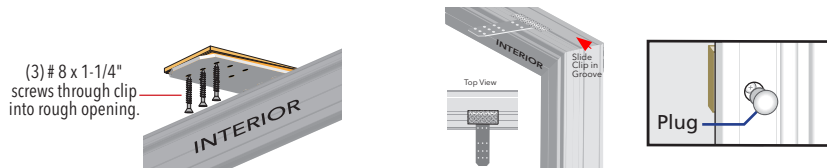

Removable Interior Cover

Casement***

Pilot Hole Locations and Sizes

Direct Set****

***If an Interior Frame Cover has a "Quick Release Band" around the cover; pull the band to help remove the cover.

****Use putty knife; insert where indicated and slide cover to interior.



FLUSH FLANGE AND BRICKMOUND FRAME WINDOW ANCHOR INSTRUCTIONS (CONT.)

Note: Standard performance only. Additional anchoring may be required for performance upgrade, impact-resistant products or to comply with local building code requirements.

ENCOMPASS BY PELLA® / PELLA® 150 SERIES / PELLA® 250 SERIES FLUSH FLANGE FRAME ANCHOR SPACING INSTRUCTIONS

Product		Edge Spacing (E)	Max. Intermediate Spacing (S)	First Mullion Anchor (M1)	Second Mullion Anchor (M2)	Fastener Wood***	Special Notes
Encompass by Pella / Pella 150 Series	Sliding Window (East and West)	6"	16"	3" / centered	8" / none	#8 x 1-1/4" Pan Head (provided)	Use M1 and M2 spacing for screws at head of meeting rail. Center 1 clip below the meeting rail.
	Single-Hung (West)	6"	16"	3"	6"	#8 x 2-1/2" Pan Head (provided)	Use M1 and M2 spacing for screws at the head only with mullions.
	Single- and Double-Hung (East)	Factory Pre-Drilled**		4"	8"	#10 x 2" Pan Head (provided)	High Performance DH: (3) #8 x 2" jamb frame screws, 4" apart at checkrails. Use (4) #8 x 2" screws at head mullion ends and 4 clips at sill mullion ends 3" and 6" from mullion.
	Casement/Awning and Fixed	4"**	16"**	4"	none	#8 x 3" Pan Head (provided)	Use clips at the sill at mullions and centered under fixed casements in 3-wide combinations.
250 Series	DH/SH (single units)	Factory Pre-Drilled**		---	---	#8 x 3" Pan Head (provided)	
	DH / SH / FX	4"	16" **	3"	6"	#8 x 3" Pan Head (provided)	Use M1 and M2 spacing for screws at head and clips at sill with mullions only.
	SW	4"	16"	---	6"	#8 x 3" Pan Head (provided)	
	CM/AW	Factory pre-drilled holes in Jamb and Head, clips at sill 4" Edge Spacing and 12" Max. Spacing		4"	8"	#10 x 2" Pan Head (provided)	Use M1 and M2 spacing for screws at head and clips at sill with mullions only.
	FX CM/AW	Clip only 4" Edge Spacing and 12" Max. Spacing		4"	8"		

All venting products: Head and sill anchors are required on composites only.

* Use Factory Drilled installation holes if present.

** For DH & SH units >62" tall add 2 screws per jamb, midway between top and bottom pre-drilled holes.

*** For light gauge steel framing, use #10 self-drilling/self-tapping screws; for concrete or masonry, use 3/16" masonry screws with 1-1/4" minimum embedment.

Install hole plugs/caps after driving screws. Replace all covers, fillers and tracks removed earlier.

ENCOMPASS BY PELLA / PELLA 150 SERIES

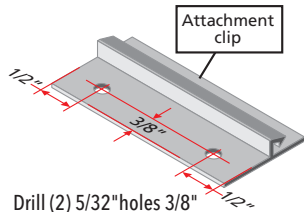

Drill (2) 5/32" holes 3/8" from the edge in each clip and install (2) #10 x 1-1/2" screws per clip.

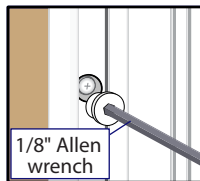

Single Hung (West)

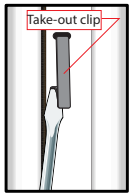

Before drilling jamb installation holes, pull out the bottom of the take-out clip on each jamb.

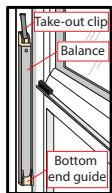

Raise the sash until the balance engages the take-out clips. Slide the sash all the way to one side and pull out the opposite side. Carefully set the sash aside.

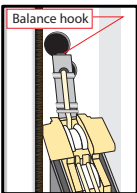

Separate the balances from the take out clips by holding them at top and bottom and pushing down 1". Tilt the top of the balance away from the frame and lift the hook out of the frame.

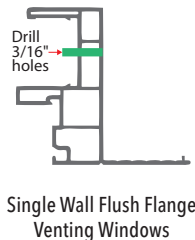

Single Wall Flush Flange Venting Windows

PILOT HOLE LOCATIONS AND SIZES

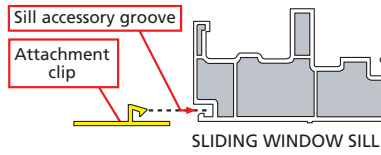

SLIDING WINDOW SILL

Open venting windows to access screw holes. Loosen the tie bar guides and remove the tie bar to access screw holes (if necessary).

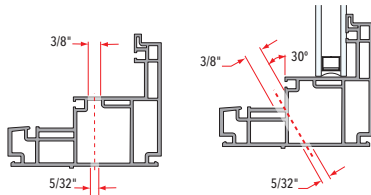

Venting Window

West Fixed Window

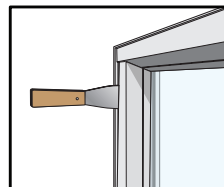

Remove fixed window glazing beads before drilling installation holes. (West)

250 SERIES

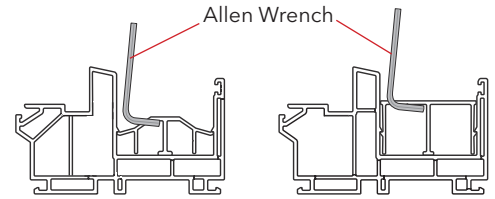

SW Vent Track

SW Pocket Filler

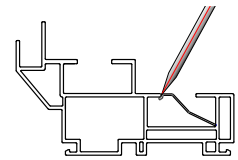

Pocket Cover Removal

ENCOMPASS BY PELLA / PELLA 150 SERIES

Fixed Window

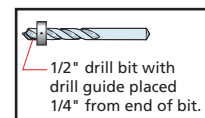
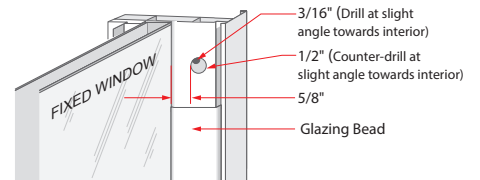
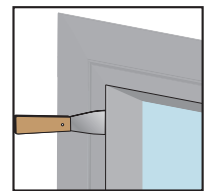



Interior Sealant Instructions

CAUTION: Continuous backer rod (as necessary) and a high quality, low-odor interior sealant such as Pella Window and Door Installation Sealant (or equivalent) is recommended for commercial or high performance installations to create the continuous interior seal. Follow the directions on the cartridge. For standard performance or products with factory applied jamb extensions, use low pressure polyurethane insulating foams. Follow the directions on the can. Do not use high pressure or latex foams. Fiberglass batt or similar insulation is not recommended as it can absorb water and does not act as an air seal.

- A. Insert the nozzle or straw between the rough opening and window frame. This can be done from the interior or exterior.
- B. Place a 1" deep bead of foam approx. 1" from the interior of the frame to allow for expansion. DO NOT fill the entire depth of the rough opening cavity.
NOTE: Apply foam between the frame and rough opening, NOT between jamb extensions and the rough opening.
- C. Re-Check window operation and remove remaining shipping spacers after foam installation. Excess foam may be removed with a serrated knife after it cures.
- D. To ensure a continuous interior seal, apply sealant over or around any shims or clips interrupting the foam seal.

Use sealant instead of foam at all 4 sides on the interior of 1/2" flange vinyl windows installed in masonry construction with pre-cast sills. Add backer rod if the gap exceeds 3/16".

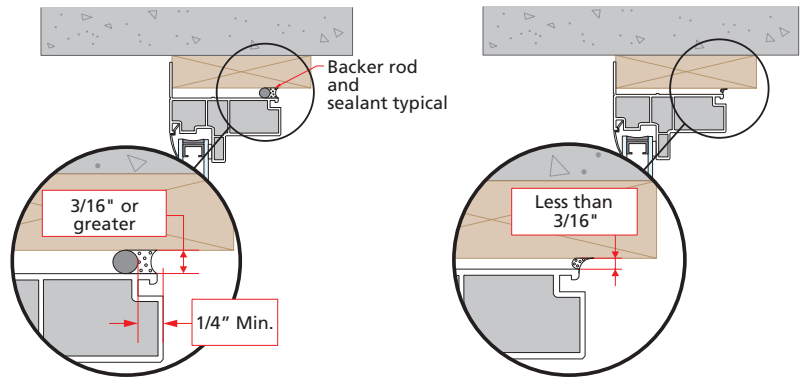
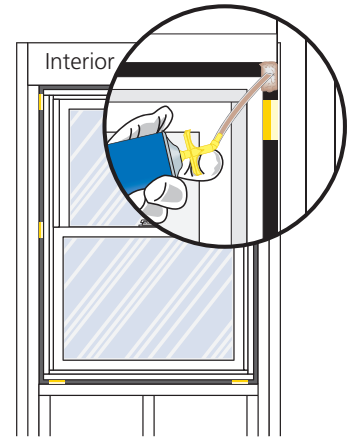

Exterior Sealant Instructions

CAUTION: Use a high quality, multi-purpose exterior sealant such as Pella Window and Door Installation Sealant. Follow the directions on the cartridge.

Flush Flange Windows

Place a corner bead of sealant on the top, sides and bottom of the window along the edge of the flush flange where it meets the stucco. Leave a 2" gap in the sealant bead at the bottom below the weep hole location in the existing aluminum frame.

Brickmould Windows

If the space between the new window brickmould and the opening is less than 1/4", go to step (B).

- A. Insert backer rod 3/8" deep in the space around the window. Backer rod adds shape and controls the depth of the sealant line.
- B. Apply a continuous bead of sealant to the entire perimeter of the window. Do not block weep holes or weep hoods with sealant.
- C. Shape, tool and clean excess sealant. When finished, the sealant should be the shape of an hourglass.

