

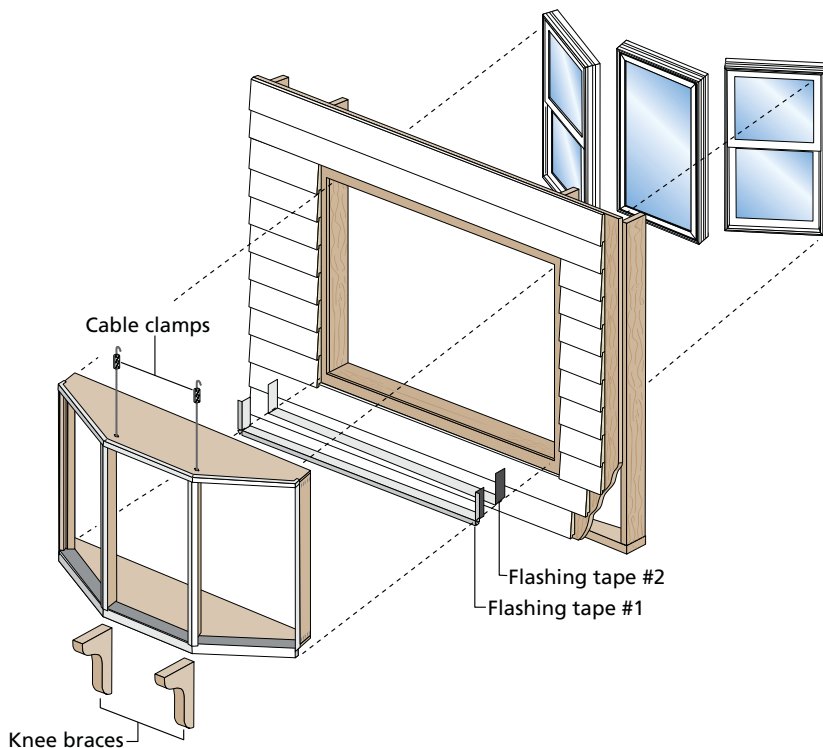

INSTALLATION INSTRUCTIONS OF BAY/BOW FRAME FOR PELLA IMPERVIA CASEMENT, DOUBLE-HUNG, FIXED, OR SINGLE-HUNG WINDOWS







Always read the Pella® Impervia® Limited Warranty before purchasing or installing Pella Impervia products. By installing this product, you are acknowledging that this Limited Warranty is part of the terms of the sale. Failure to comply with all Pella Impervia installation and maintenance instructions may void your Pella Impervia product warranty. See Limited Warranty for complete details at <http://warranty.pellaimpervia.com>.

Caution: The factory-installed support cables must be attached to wall framing members capable of supporting 1,300 lbs. If the wall framing members are not capable of supporting 1,300 lbs., knee braces must be used in addition to the cables. Bay and bow units are not intended to support any roof structure. Consult an architect, engineer or construction professional if the ability of the wall framing members to support the bay or bow is not known.

Installation Instructions for Typical Wood Frame Construction.

These instructions were developed and tested for use with typical wood frame wall construction in a wall system designed to manage water. **These instructions are not to be used with any other construction method.** Installation instructions for use with other construction methods, multiple units or bow and bay windows, may be obtained from Pella Corporation or a local Pella retailer. Building designs, construction methods, building materials, and site conditions unique to your project may require an installation method different from these instructions and additional care. Determining the appropriate installation method is the responsibility of you, your architect, or construction professional.

YOU WILL NEED TO SUPPLY:

- Impervious shims/spacers (12 to 20) 
- Finish nails, 1" brads
- #10 x 3" flat head corrosion resistant wood screws (16 to 20) 
- #8 x 2-1/2" trim head screws (20-30)
- 3/16" x 2-1/2" concrete screws (for masonry installation)
- Closed cell foam backer rod/sealant backer (12 to 30 ft.)
- Pella® SmartFlash™ foil backed butyl window and door flashing tape or equivalent 
- Low expansion, low pressure polyurethane insulating window and door foam sealant - DO NOT use high pressure or latex foams 
- Pella Window and Door Installation Sealant or equivalent high quality, multi-purpose sealant (1 tube per window) 
- Knee braces (for units ≥ 8' wide)

TOOLS REQUIRED:

- Tape measure 
- Level 
- Square 
- Hammer or finish nailer 
- Stapler 
- Scissors or utility knife 
- Drill with a #2 Phillips (at least 4" long) and #3 square drive bit 
- 1/2" open end wrench 
- 3/16" wrench or socket 
- Sealant gun 

Installation will require two or more persons for safety reasons.

REMEMBER TO USE APPROPRIATE PERSONAL PROTECTIVE EQUIPMENT.

1 BAY/BOW FRAME PREPARATION

TWO OR MORE PEOPLE WILL BE REQUIRED FOR THE FOLLOWING STEPS.

- Remove the packaging** from around the bay/bow frame. Inspect the frame before proceeding. Remove the interior trim package and set aside to use later in Step 10.
- Confirm the bay/bow frame will fit into the opening.** Measure all four sides of the opening to make sure it is 3/4" larger than the frame in both width and height. Measure the width and height in several places to ensure the header and studs are not bowed.
Note: If this is a replacement application it will be necessary to remove the existing interior trim/casing to access the opening for a correct measurement.
- Remove the packaging** from around each window to be installed into the bay/bow frame. Inspect the windows before proceeding.
- Confirm the windows will fit into the bay/bow frame openings.** Identify the location of each of the windows. Measure all of the bay/bow openings to make sure they are 3/4" larger in width and 1/2" larger in height than each corresponding window.
- Lay the bay/bow frame down (exterior facing up) and remove the shipping pallet.** Remove all screws from the bottom of the shipping pallet to release it from the frame.
- Open the cable package and place one washer and one hexagon nut** onto the threaded end of each cable.



1 BAY/BOW FRAME PREPARATION (CONTINUED)

G. **Remove the "T" nuts from the cable hardware package.** Using a hammer pound the "T" nut to seat it into the top of the frame head board at the pre-drilled hole location above the mullion joint. Repeat placement on other side.

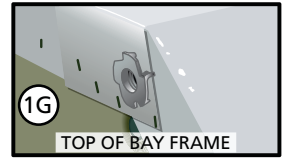

H. **Insert the non-threaded end of the cable into the bottom cable support hole.** Thread the cable through the bay frame mullion and out the top support hole. The threaded end of the prepared cable with the washer and nut will stop against the bottom side of the bay frame. Repeat procedure for the other side.

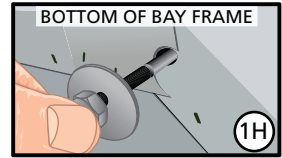

I. **Tape the ends of the cables to the top of the bay/bow frame** to keep them in place during installation.

J. **Tip the bay/bow frame up** so the head board is up and the seat board is down.

K. **Remove the black plastic edging.** Remove all of the attachment staples from the outside edges around the perimeter of the frame.

2 OPENING PREPARATION

A. **If replacement application, remove the existing window.** Clean the opening of any dirt, debris or excess old paint before proceeding. Remove siding as needed to make sure there is a minimum of 1-3/4" of the sheathing exposed below the bottom of the rough opening for the bay/bow frame to be properly installed against the sheathing.

CAUTION: Many windows in older homes are painted with lead-based paint. Removal of old windows may disturb this paint. Proper precautions must be taken to minimize exposure to dust and debris. Consult state or local authorities for more information.

B. **Inspect the opening** and repair or replace any defective or rotted wood parts.

C. **Confirm the opening is plumb and level.**

Note: It is critical the bottom is level.

D. **If new construction, cut the water resistive barrier.** Fold the flaps into the opening and staple to the inside wall.

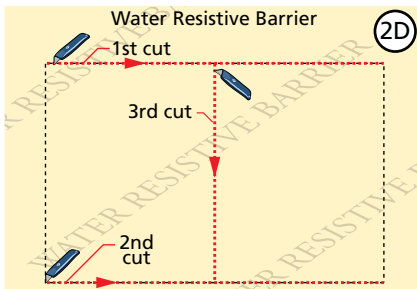
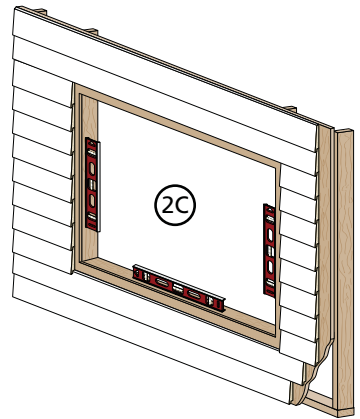

2 OPENING PREPARATION (CONTINUED)

- E. **Apply sill flashing tape #1 (wood construction only).** Cut a piece of flashing tape 12" longer than the opening. Apply at the bottom of the opening overlapping as shown so it overhangs 1" to the exterior and extends 6" up the side and up to the exterior edge of the opening.

Note: The tape is cut 12" longer than the width so it will extend 6" up each side of the opening.

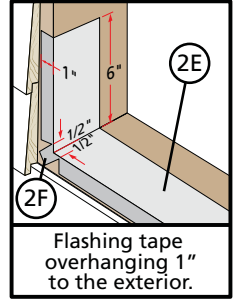

- F. **Tab the sill flashing tape and fold (if tape #1 overhangs to the exterior).** Cut 1" wide tabs at each corner (1/2" from each side of the corner). Fold tape to the exterior and press firmly to adhere it to the water resistive barrier.

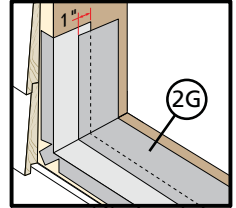

- G. **Apply sill flashing tape #2.** Cut a piece of flashing tape 12" longer than the opening width. Apply at the bottom, overlapping tape #1 by at least 1". DO NOT allow the tape to extend past the interior face of the opening.

Note: The flashing tape may not fully cover the framing members.

Note: If the bay window is to be installed using any support walls in addition to the main rough opening in the building, be sure to apply flashing tape in the same manner to those walls.

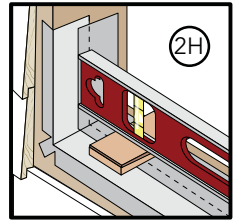

- H. **Install and level sill shims.** Place 1" wide by 1/4" thick shims on the bottom of the opening 1/4" from each side. Keep shims back 1/2" from interior face of bay/bow frame. Add shims as necessary to ensure the sill is level. Once level, attach shims to prevent movement.

3 PREPARING AND SETTING THE BAY/BOW FRAME

TWO OR MORE PEOPLE WILL BE REQUIRED FOR THE FOLLOWING STEPS.

- A. **Drill seven 1/8" diameter installation holes** 1/2" from the interior corner of the bay frame jamb where the frame jamb and interior window pocket meet so the holes can be covered by the jamb interior trim pieces. Holes should be placed 4" from each end and with the remaining five holes evenly spaced between.
- B. **Drill 3/32" diameter installation holes** 2" from the interior edges of the head and seat boards. Holes should be placed 4" from each end and no more than 18" on center.

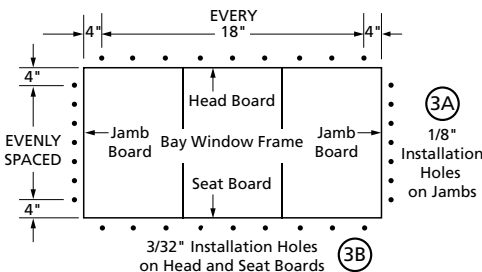
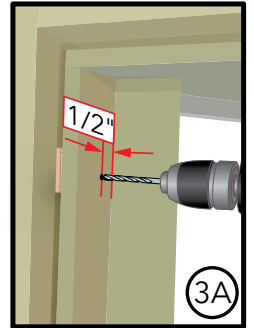

3 PREPARING AND SETTING THE BAY/BOW FRAME (CONTINUED)

- C. **Insert the bay/bow frame.** Place the seat of the frame at the bottom of the opening and slide the top into position. Tip the frame up so the interior edge is flush with the interior wall. Center the frame between the sides of the opening to allow clearance for shimming.

Bottom view of bay/bow frame with step in frame where seat board will be placed on bottom of rough opening and spacers

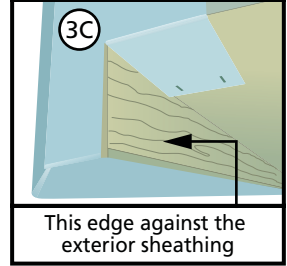

- D. **Place temporary bracing** under the seat of the window to support the bay/bow frame in a level position.

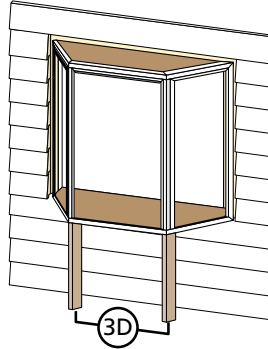

- E. **Place a shim** near the top of one jamb board of the frame, aligned with the top pre-drilled holes in the jamb board. Keep shims back 1/2" from interior face of bay/bow frame. Use a level to ensure the jamb is plumb and partially insert a #10 x 3" flat head screw (not provided). Repeat for the other jamb.

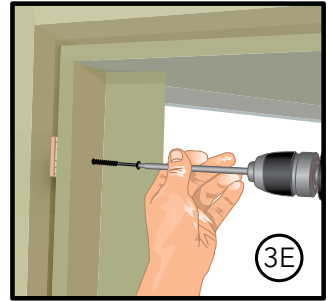

- F. **Continue placing shims** at each pre-drilled installation screw hole in jamb boards as needed to plumb and square the frame. Keep shims back 1/2" from interior face of window. Check the frame for squareness by making sure the diagonal measurement from corner to corner is within 1/8" in both directions. Insert a #10 x 3" flat head screw into each pre-drilled hole in the jamb boards. Finish inserting the top screw in each jamb board.
- G. **Place shims** between the head and seat boards at each pre-drilled installation hole and install a #8 x 2-1/2" trim head screw in each hole.

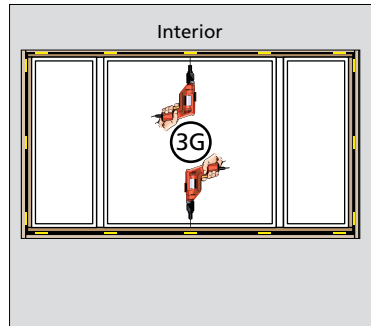
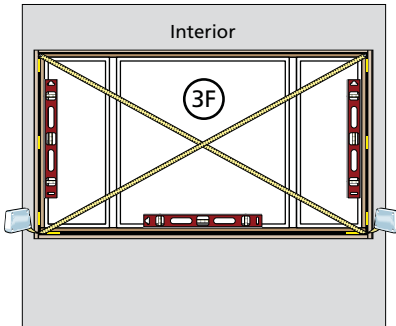

Note: Common bay/bow frame installation conditions are shown in the diagrams below.

CASEMENT BOW FRAME

JAMB - 2 X 4 Frame

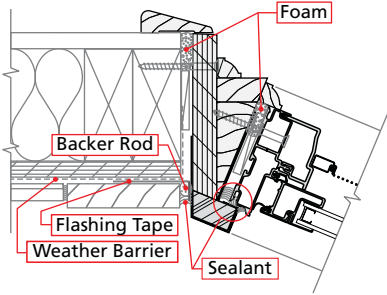

JAMB - Brick Veneer

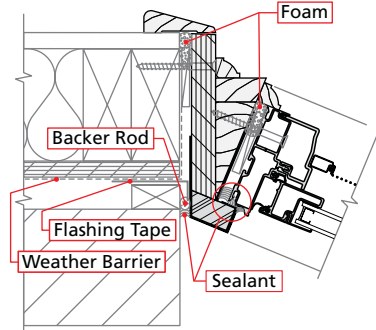

CASEMENT BAY FRAME

JAMB - 2 X 4 Frame

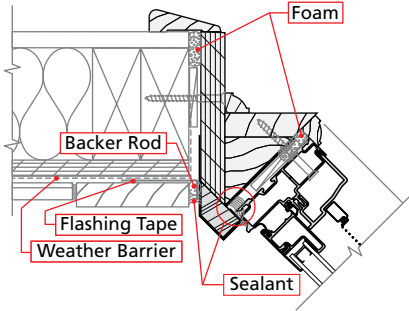

JAMB - Brick Veneer

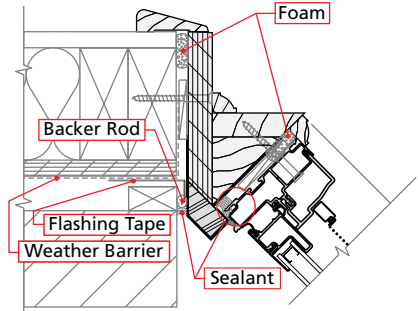

DOUBLE-HUNG BAY FRAME

JAMB - 2 X 4 Frame

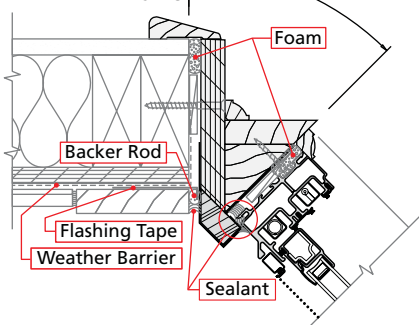

JAMB - Brick Veneer

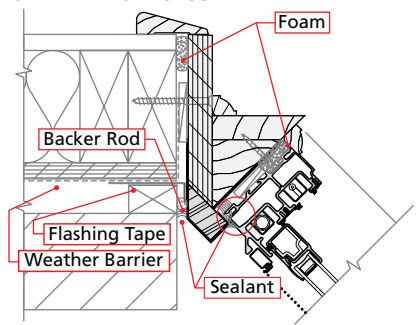

Note: If additional coil wrapping (cladding) is to be installed to the bay frame, DO NOT use mechanical fasteners to attach the cladding to the sill. The sill pan is beneath the sill cladding and attaching with fasteners will penetrate the sill pan and create a path for water infiltration.

4 PREPARING FRAME OPENINGS AND WINDOWS FOR INSTALLATION INTO FRAME

Note: If Impervia Casements will be installed into the bay frame, go to Step 5 and prep by removing the casement interior frame covers before proceeding to Step 4A.

Note: There are two methods of installation. (1) Bulb gasket in the exterior accessory groove or (2) Sealant around the perimeter of the openings. If using sealant proceed to Step 4B.

Note: In the sealant method the term "wetting out" means the adhesive flows and covers a surface to maximize the contact area and the attractive forces between the adhesive and bonding surface.

- A. **Install the bulb gasket accessory kit** (provided) into the exterior accessory groove of the head and both jambs of each window to be installed into the bay/bow frame. Press the attachment leg of the bulb gasket into the accessory groove. The bulb gasket must be installed as one piece. DO NOT cut at the corners.
- B. **Cover the seat board of the bay/bow frame** with cardboard, plastic or a drop cloth to protect it from scratches and sealant during the installation of windows into the frame.
- C. **Measure the opening(s) to confirm they are square.** If opening is out of square, adjust the temporary exterior bracing.
- D. **Dry fit the window** to confirm proper fit and reveal in the opening. Adjust the bracing as needed.

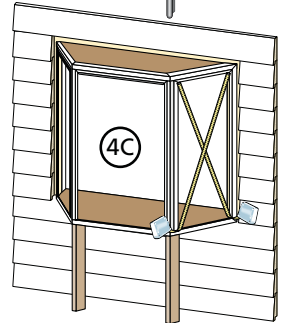
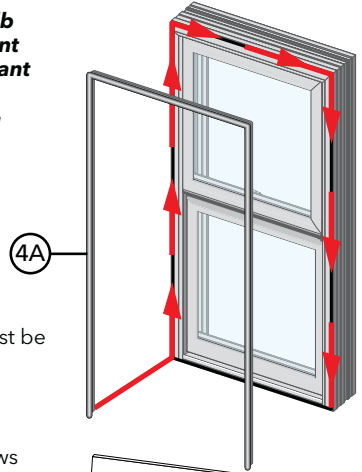

- E. **Apply a 3/8" diameter bead of sealant** across the sill approximately 1/2" from the back of the built-in sill pan at the sill. This will allow for the interior edge of the window sill to be set in the sealant bead when the window is installed. Place a dot of sealant in each corner of the sill pan approximately 1" x 1".

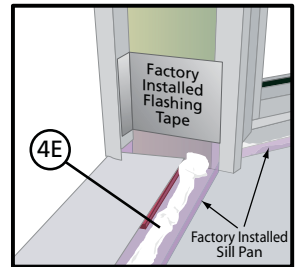

- F. **Apply a 1" diameter dot of sealant** to each top corner of the openings for the windows in the bay/bow frame.

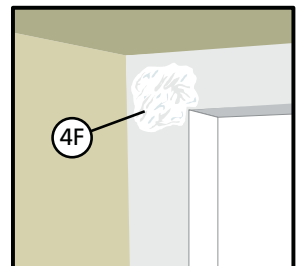

4 PREPARING FRAME OPENINGS AND WINDOWS FOR INSTALLATION INTO FRAME (CONTINUED)

Note: Use opening preparation Step 4G only for units NOT using bulb gasket.

- G. Apply a minimum of 3/8" diameter of sealant on the exterior jamb and head stops of the bay/bow frame. Apply the sealant as close to the outside edge as possible.

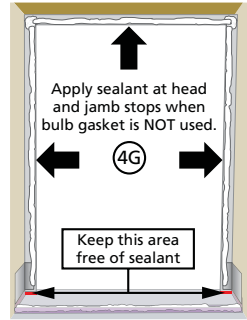

5 WINDOW PREPARATION (CASEMENT ONLY)



The interior frame covers must be removed to provide access to the pre-drilled frame screw installation holes.

CAUTION: To Avoid Interior Frame Cover Breakage - Carefully read and understand the following steps before proceeding with cover removal.

The order of interior frame cover removal is indicated below. Use reverse order for re-installation of covers.

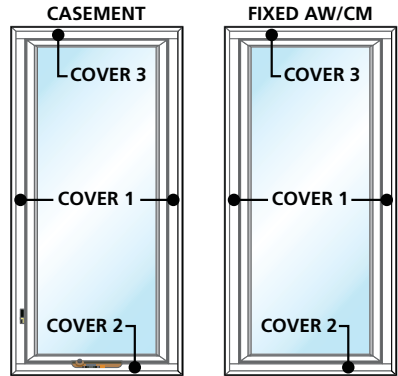

A. Prepare the Window.

1. Remove the screen and set aside.
2. Use pliers to remove the plug(s) from the lock handle location(s).
3. Remove the construction handle tool from the handle package.

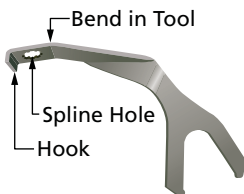
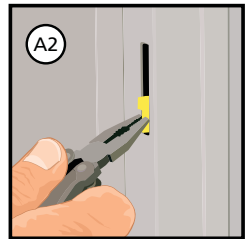

Construction Handle Tool
REFERENCE DESCRIPTION

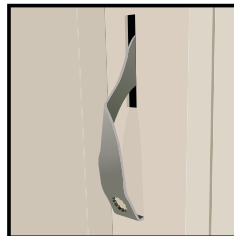

Construction Handle Tool may be used as a lock handle or crank handle.



5 WINDOW PREPARATION (CASEMENT ONLY) (CONTINUED)

- B. Remove Interior Frame Cover #1.** If an Interior Frame Cover has a "Quick Release Band" around the cover, pull the band to help remove the cover.

The cover on vent units where the lock handle slot is located and the cover on the opposite frame side.

1. Approximately 1" from the bottom (end) of the cover, insert the "hooked" end of the tool between the cover and the sash.
2. Rotate the tool toward the sash and continue to insert the tool past the spline hole up to the point where the bend in the tool is aligned with the edge of the cover.

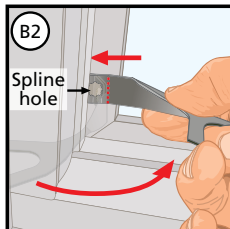
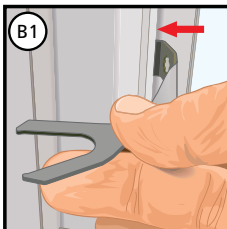

Note: When the tool is inserted with the bend aligned with the cover edge there will be a slight gap between the tool and the face of the sash.

3. Push the tool flat against the sash (not a lot of force is needed) to release the back cover bar from the frame kerf behind the cover. While keeping tension on the tool, pull the tool away from the frame to start releasing the cover bars from the frame kerfs.

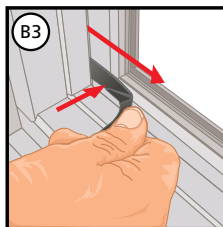

Cross Section of Interior Frame Cover with Tool Placement Detail

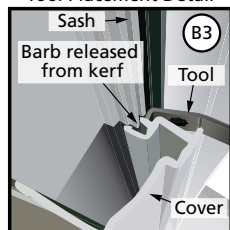

4. Rotate the cover end slightly toward the interior; when the cover begins to pull away from the frame, relocate the tool under the cover towards the interior as shown, then pull the tool away from the frame to continue the release of the cover bars from the frame.

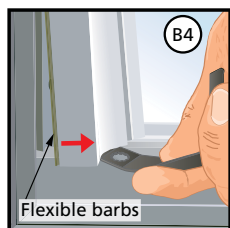

5. Reposition the tool with the hook under the front edge of the cover. Slide the tool over while pulling the cover away from the frame. This will release the flexible bars on the interior side of the cover, which will aid in cover removal. Continue sliding along the length of the cover while pulling it away from the frame until it is removed.

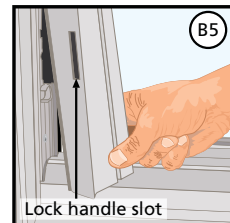
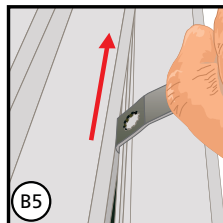

6. Repeat Steps B1 thru B5 to remove the other Interior Frame Cover #1.

If installing a casement or fixed unit less than 42" in width, go to Step 6 "SETTING AND FASTENING THE WINDOW". If installing units greater than 42" in width, go to Step C.



5 WINDOW PREPARATION (CASEMENT ONLY) (CONTINUED)

C. Remove Interior Frame cover #3.

The cover on vent units on the opposite frame side from where the crank handle is located.

For units greater than 42" in width.

1. Start at one end of the cover and insert the tool between the frame and cover as shown.
2. Pull the tool away from the frame to start releasing the cover barbs from the frame kerfs.
3. When the cover begins to pull away from the frame, grasp the cover and continue to pull to release the barbs from the kerfs, removing the cover.

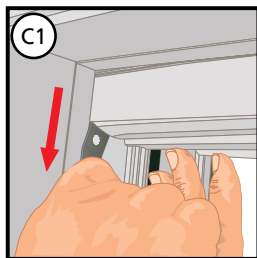

TWO OR MORE PEOPLE ARE REQUIRED FOR THE FOLLOWING STEPS

6 SETTING AND FASTENING THE WINDOW

- A. **Insert the window** and center it in the opening to allow clearance for shimming.

Note: Use of a suction cup on the glass will assist in handling the window.

Note: Each existing window frame and wall depth will vary in different applications; therefore there is not a standard measurement for the overhang of the window frame to the exterior or for the distance from the interior face of the window to interior trim. When performing Steps 6B thru 6D, installing the frame screws, be sure to keep the distance consistent all around the window.

Note: On the exterior, there must be enough room for backer rod and 3/8" sealant bead.

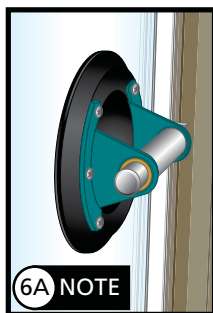

- B. **Insert shims** between the window and the opening at the top two anchor hole locations in the window jambs.

Note: Check the reveal so the interior trim stops cover the interior accessory grooves. Dry fit a piece of trim to check reveal.

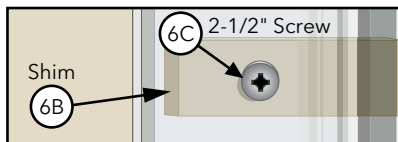

- C. **Fasten the window near the top of the opening** by driving 2-1/2" long wood screws through the top two holes at the jambs and into the opening sides.

Note: Be sure to apply pressure against the window to fully compress the gasket against the stops in the bay/bow frame. Apply enough pressure to make sure the gap between the window and the bay/bow frame at the head and jambs is < 3/16".

Or if wet sealant was used around the perimeter of the opening, press the window against the sealant on the stops of the bay/bow frame until the sealant is fully wetted out. (Make sure the surfaces between contact points are fully covered with sealant).



6 SETTING AND FASTENING THE WINDOW (CONTINUED)

- D. **Plumb and square the window.** Insert shims between the window frame and the rough opening at the anchor hole locations in the window frame.

Note: Install the shims per Shim and Fastener Guide. DO NOT over shim.

- E. **If additional installation holes are needed, drill** a 3/16" installation hole through both the interior and exterior walls of the frame.

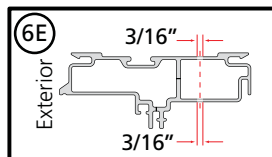

- F. **Fasten the window in the opening** by driving the 2-1/2" long screws through each pre-drilled hole in the window frame, through the shims and into the rough opening.

Note: Drive screws per the Casement Shim Fastener Guide.

- G. **Insert the construction handle** into the lock lever location and unlock the window. Remove the handle. Place the construction crank handle over the roto operator stud. Open and close each sash to verify the smooth operation and alignment of sash locks with sash strikes. Check and adjust shims as needed. Remove the construction handle.

SHIM AND FASTENER PLACEMENT GUIDE

Number of factory drilled fastener locations may vary depending on size of unit(s).

▶ = Indicates typical locations of factory drilled anchor holes where screws and shims are required.

▷ = Indicates location where installation screws are optional.

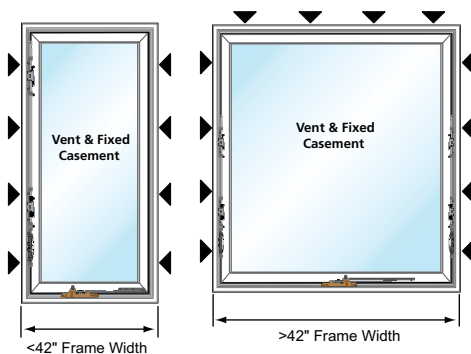

Note: If additional shims are needed to level the window sill frame, shims must be installed from the exterior.

Re-install Interior Frame Covers.

Note: Discard all Quick Release Bands before re-installing Interior Frame Covers.

H. Interior Frame Cover #3

Starting on one end of the frame, insert the cover barbs of Interior Frame Cover #3 into the frame kerfs. Align the kerfs along the length of the cover and press until the cover "clicks" into place.

Note: Interior Frame Covers #3 contains compression springs which allow the cover to be compressed when re-installing Interior Frame Covers #1 in Step 6.

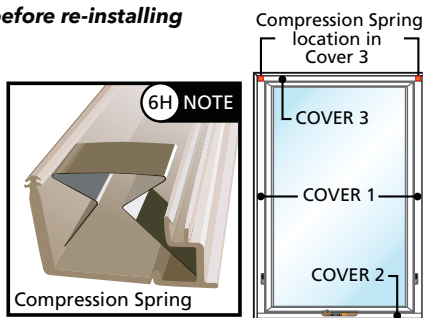



I. Interior Frame Cover #1

Insert the cover barbs of the first Interior Frame Cover #1 into the frame kerfs near Interior Frame Cover #2 first. Rotate the Interior Frame Cover #1 towards Interior Frame Cover #3 and align the kerfs along the frame, then press the cover until it "clicks" into place. Repeat on the other cover.

- J. **Insert the roto cover, crank handle and lock handle.** See steps at the end of the instructions.

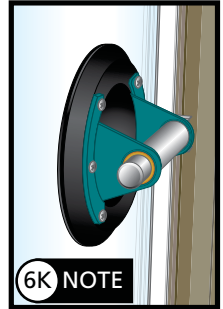

SINGLE-HUNG AND DOUBLE-HUNG

- K. **Insert the window and center it in the opening** to allow clearance for shimming.

Note: Use of a suction cup on the glass will assist in handling the window.

- L. **Insert shims** between the window and the opening at the top two anchor hole locations in the window jambs. Keep shims back 1/2" from interior face of window.

Note: Check the reveal so the interior trim stops cover the interior accessory grooves. Dry fit a piece of trim to check reveal.

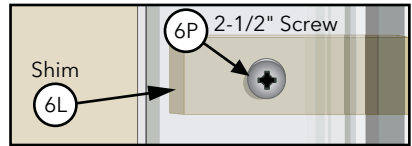

- M. **If additional installation holes are needed, drill a 5/32" installation hole** through both the interior and exterior walls of the frame. Counter drill a 3/8" hole through the interior wall only of the frame. DO NOT penetrate the exterior wall with the 3/8" bit.

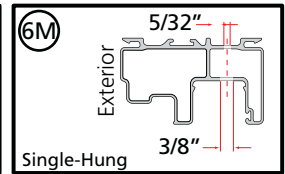
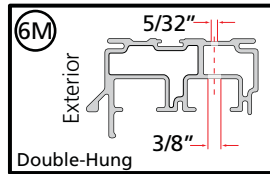

- N. **Fasten the window near the top of the opening** by driving 2-1/2" long wood screws through the top two holes at the jambs and into the opening sides.

Note: Be sure to apply pressure against the window to fully compress the gasket against the stops in the bay/bow frame. Apply enough pressure to make sure the gap between the window and the bay/bow frame at the head and jambs is <3/16".

Or if wet sealant was used around the perimeter of the opening, press the window against the sealant on the stops of the bay/bow frame until the sealant is fully wetted out. (Make sure the surfaces between contact points are fully covered with sealant).

- O. **Plumb and square the window.** Insert shims between the window frame and the rough opening at the anchor hole locations in the window frame. Keep shims back 1/2" from interior face of window.

Note: DO NOT shim above the window. Any sill shimming must be done from the exterior.

- P. **Fasten the window in the opening** by driving the 2-1/2" long screws through each pre-drilled hole in the window frame, through the shims and into the rough opening.

Note:

Single-hung: Raise the lower sash to access lower installation holes.

Double-hung: Lower the top sash to access the upper installation holes and raise the lower sash to access the lower installation holes. Tilt the lower sash to the interior to access the installation holes at the checkrail. Assistance from the interior is recommended for this step.

Note: DO NOT use installation screws at the sill.



FIXED WINDOW AND FIXED FRAME

Note: DO NOT use installation screws at the sill.

- Q. **Insert the window** and center it between the sides of the rough opening to allow clearance for shimming.

Note: Use of a suction cup on the glass will assist in handling the window.

Note: Check the reveal so the interior trim stops cover the interior accessory grooves. Dry fit a piece of trim to check the reveal.

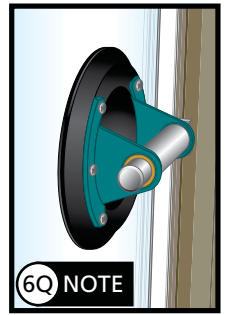

- R. **Insert shims** between the window and the sides of the rough opening at the top two anchor hole locations in the window sides.
- S. **Fasten the window at the top of the opening** by driving 3" long screws (provided) through the top two holes in the window sides and into the rough opening sides.

Note: Be sure to apply pressure against the window to fully compress the gasket against the stops in the bay/bow frame. Apply enough pressure to make sure the gap between the window and the bay frame at the head and jambs is < 3/16".

Or if wet sealant was used around the perimeter of the opening, press the window against the sealant on the stops of the bay/bow frame until the sealant is fully wetted out. (Make sure the surfaces between contact points are fully covered with sealant).

- T. **Plumb and square the window.** Insert shims between the window frame and the rough opening at the anchor hole locations in the window frame. DO NOT over shim. Keep shims back 1/2" from interior face of window.

Note: DO NOT shim above the window. Any sill shimming must be done from the exterior.

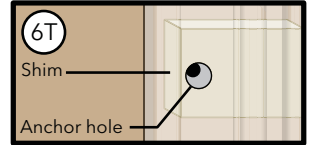

- U. **If additional installation holes are needed,** drill a 5/32" installation hole through both the interior and exterior walls of the frame. Counter drill a 3/8" hole through the interior wall only of the frame. DO NOT penetrate the exterior wall with the 3/8" bit.

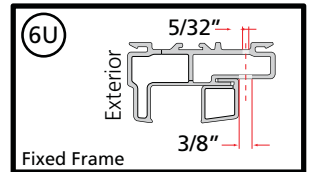

- V. **Fasten the window in the opening** by driving the 3" long screws (provided) through each pre-drilled hole in the window frame, through the shims and into the rough opening.

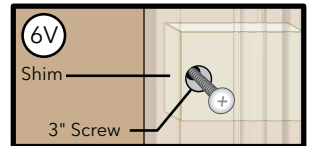

- W. **Insert hole plugs** (provided).

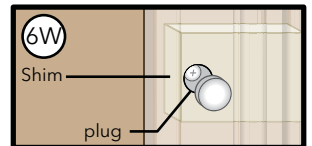

7 INTERIOR SEAL SEAL WINDOWS TO BAY/BOW FRAME

- A. **Confirm the gap between the window and the bay frame** on the exterior at the head and jambs is $< 3/16"$. If it $> 3/16"$, remove screws, apply additional pressure against the window to compress the gasket against the stops and then reset screws so the gap is $< 3/16"$.
- B. **Check the window operation** (vent units only) by opening and closing the window. If needed, remove screws and adjust shims and reset screws before applying sealant.

- C. **From the interior fill the corners at the sill** with sealant.
Note: Cover the seat board with cardboard, plastic or drop cloth to protect the wood surface.



- D. **Fill the opening in each sill pan** between the window and sill pan edge with sealant. Continue applying up each side to approximately 2" above the flashing tape. Tool sealant down into pan taking care to fill all voids. When finished the sealant should be level with the top of the pan edge and the window interior accessory groove should not be visible.

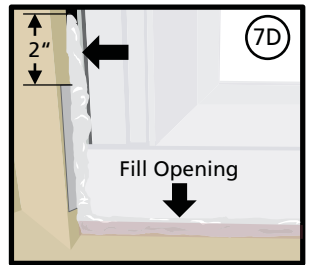

- E. **Apply insulating foam sealant.** From the interior, insert the nozzle between the window frame and the bay/bow frame and place a continuous 1" bead of foam sealant along head and jambs. Connect the foam to the sealant along the sill. Allow the foam to cure completely before proceeding to the next step. Repeat on all windows installed in the bay/bow frame.

Caution: Ensure use of low pressure polyurethane window and door insulating foams and strictly follow the foam manufacturer's recommendations for application. Use of high pressure foams or improper application of the foam may cause the window frame to bow and hinder operation.

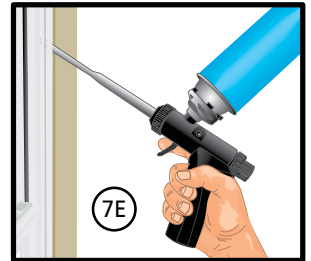

- F. **Check the window operation** (vent units only) by opening and closing the window.
Note: If the window does not operate correctly, check to make sure it is still plumb, level, square, and the jambs are not bowed. If adjustments are required, remove the foam with a serrated knife. Adjust the shims and reapply the insulating foam sealant.



- G. **Insert jamb hole plugs** (provided) into each screw hole for single-hung and double-hung units.

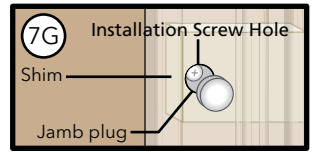

- H. **Apply insulating foam sealant.** From the interior, insert the nozzle between the bay/bow frame and the rough opening and place a continuous 1" bead of foam sealant.

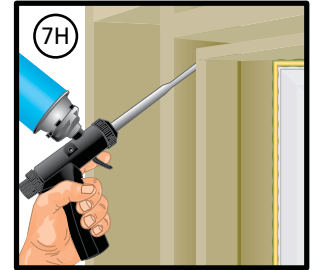

8 EXTERIOR SEAL WINDOWS TO BAY/BOW FRAME

- A. **Place a bead of sealant** along the sill of each window between the window and the bay/bow frame. Continue the bead up each jamb approximately 1/2".
- B. **Continue applying sealant bead around the entire perimeter of the window exterior** when the following conditions are met.
- In all cases when wet sealant is used
 - When bulb gasket is used and if the gap between window and bay/bow frame is 3/16".

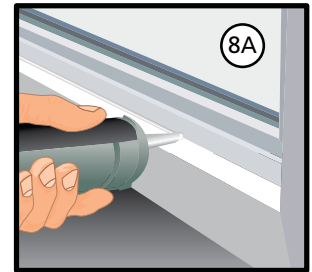

SEAL BAY/BOW FRAME TO ROUGH OPENING

- C. **Insert backer rod** into the space around the window deep enough to provide at least a 1/2" clearance between the backer rod and the exterior face of the wall sheathing.

Note: Backer rod adds shape and depth for the sealant line.

- D. **Apply a bead of high quality exterior grade sealant** to the entire perimeter of the window.

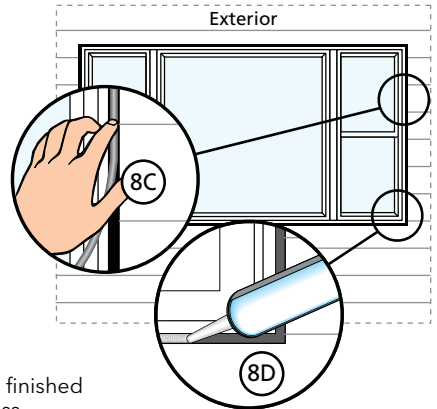

- E. **Shape, tool and clean excess sealant.** When finished the sealant should be the shape of an hourglass.

Note: This method creates a more flexible sealant line capable of expanding and contracting.

9 CABLE CLAMP INSTALLATION

Install Cable Clamps based on type of installation needed. Cross Bracing Installation consists of attaching 2" x 6" cross bracing between rafter tails. Header Mount Installation consists of attaching to a solid structural member - header, sill plates or wall stud.

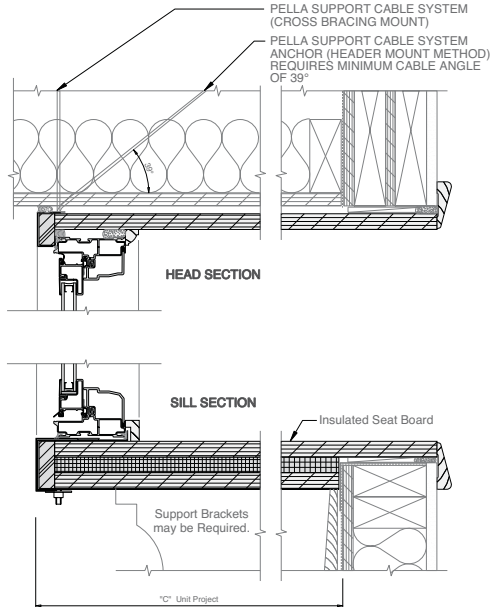
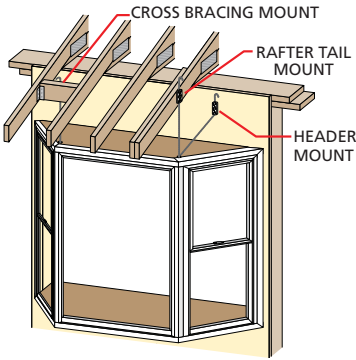

(1) The Bay/Bow support cables must be attached to structural members capable of supporting 1,300 lbs. Knee braces are required in addition to the support cables if the structural members are not capable of supporting 1,300 lbs. Bay/Bow units are not designed to support roof structure.

- A. **Install 2" x 6" cross braces** between rafter tails, directly above the cable holes in the bay/bow head board.
- B. **Install the cable clamps** directly above the "T" nuts where adequate support is available. Holding the clamp parallel to the up-running cable, drive the #12 x 3-1/4" square screws part way into the mounting surface using a #3 square drive bit.

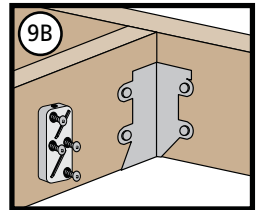

- C. **Run the cable up through the bottom of the cable clamp.** Hold the cable up tight above the clamp and drive the two center clamp screws all the way in, locking the cable in place. Drive the remaining #12 x 3-1/4" square screws all the way.

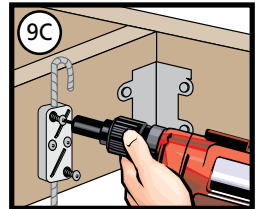

Note: Make sure all four screws are driven in at maximum torque. Additional tensioning may be done with the nuts on the opposite end of the cable at the bottom of the bay/bow unit.

- D. **Installation of knee braces is recommended for all units (and required on units > 8' wide)** to help support the weight of the bay/bow unit. Weight calculations must take into account the weight of items that may be placed on the seat board of the unit. Knee braces are required if more than 500 pounds (not including the weight of the bay/bow frame with windows installed) will need to be supported by the window seat board.

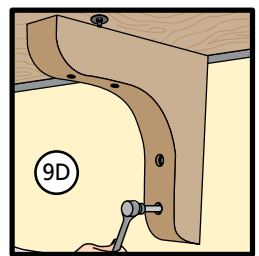

10 INTERIOR CASING/TRIM INSTALLATION

Note: Interior casing/trim is sent cut to length. Dry fit all the trim pieces to confirm the correct length before attaching with 1" brads/finishing nails. If trim pieces are too long they may be trimmed, if they are too short, trim will need to be re-ordered.

- A. **Attach sill trim piece first.** (Sill trim piece is notched to fit over the sill pan edge). Attach with finishing nails.
- B. **Attach jamb pieces** on both sides of the window. Attach with finishing nails.
- C. **Attach head trim** with finishing nails.
- D. **Repeat A-C on all windows** in the bay/bow frame.

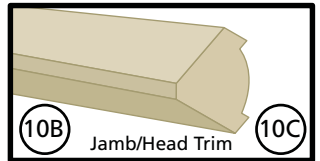
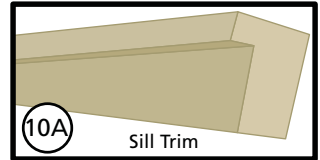

INSTALLING ROTO COVER AND CRANK



- A. Place the cover over the operator stud and snap into place.
- B. Apply pressure to the pocket end of the cover and snap into place.
- C. Use a medium size flat-blade screwdriver to loosen the set screw in the crank handle.

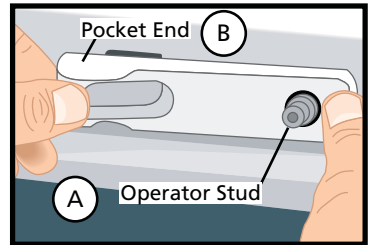

- D. Slide the crank handle onto the stud. Unlock, open window, then close and lock window.
- E. Fold the crank handle down and check alignment of knob with the pocket.

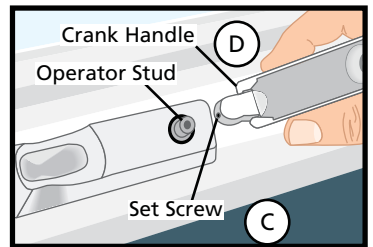

Note: You may need to adjust the crank position on the stud until the correct alignment is achieved.

- F. Open the crank and tighten the set screw.
- G. After the final installation, fold the crank over and snap the knob into the pocket.

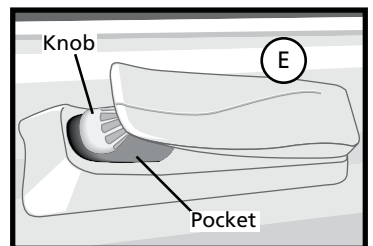

Note: Even with the window open the crank can be folded to avoid interfering with the window treatments.





LOCK LEVER REMOVAL AND INSERTION

Note: You may want to remove the lock lever if it needs to be replaced with a different finish.

A. Unlock and open the window.

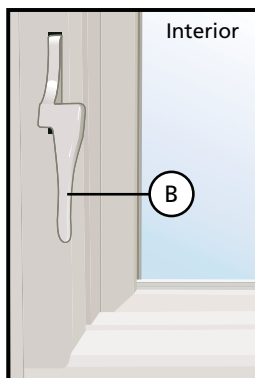

B. Place the lock lever in the locked position.

C. From the exterior of the window, look through the opening behind the lock lever to locate the point where the lock lever and lock cam meet.

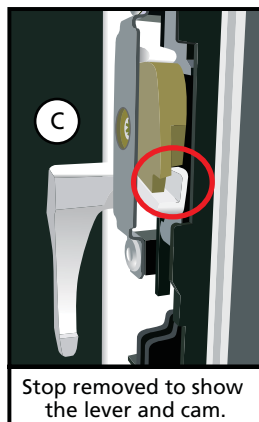

D. Insert an approximately 1/4" wide flat-blade screwdriver straight into the opening and center the blade tip at the point the cam and lever meet.

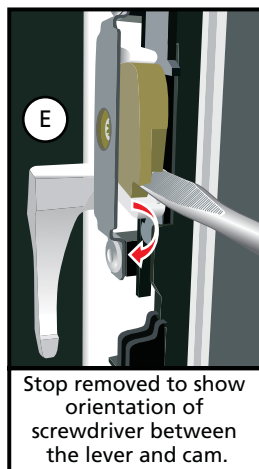

E. Push the screwdriver against the lock cam and rotate the bottom of the blade toward the lock lever. This will push the lock cam away from the lock lever hook so the lever can be removed.

F. Remove the lock lever by pulling it straight out toward the interior of the building.

G. To install a lock lever, from the interior hold it in the locked position and insert into the slot until it snaps onto the cam.

Note: The lock cam must be in the locked position before the lock lever can be inserted.

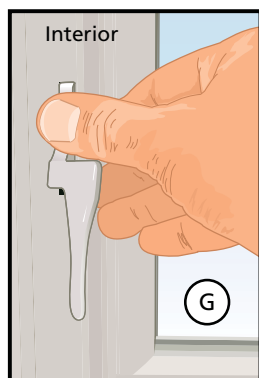

FINISH

The interior and exterior frame and sash are protected by a powder coat baked-on factory finish that requires no painting. Clean this surface with mild soap and water. Stubborn stains and deposits may be removed with mineral spirits. DO NOT use abrasives. DO NOT scrape or use tools that might damage the surface.

Use of inappropriate solvents, brickwash or cleaning chemicals will cause adverse reactions with window and door materials and voids the Limited Warranty.

CARE AND MAINTENANCE

Care and maintenance information is available by contacting your local Pella retailer. This information is also available at www.pellaimpervia.com.

IMPORTANT NOTICE

Because all construction must anticipate some water infiltration, it is important that the wall system be designed and constructed to properly manage moisture. Pella Corporation is not responsible for claims or damages caused by anticipated and unanticipated water infiltration; deficiencies in building design, construction and maintenance; failure to install Pella® products in accordance with Pella installation instructions; or the use of Pella products in wall systems which do not allow for proper management of moisture within the wall systems. The determination of the suitability of all building components, including the use of Pella products, as well as the design and installation of flashing and sealing systems are the responsibility of the Buyer or User, the architect, contractor, installer, or other construction professional and are not the responsibility of Pella.

Pella products should not be used in barrier wall systems which do not allow for proper management of moisture within the wall systems, such as barrier Exterior Insulation and Finish Systems, (EIFS) (also known as synthetic stucco) or other non-water managed systems. Except in the states of California, New Mexico, Arizona, Nevada, Utah, and Colorado, Pella makes no warranty of any kind and assumes no responsibility for Pella windows and doors installed in barrier wall systems. In the states listed above, the installation of Pella products in barrier wall or similar systems must be in accordance with Pella installation instructions.

Product modifications that are not approved by Pella Corporation will void the Limited Warranty.

This page left blank intentionally.