

# Product Document



## Datasheet

DS000697

# EGA2000-850-W

## Industrial High-Power Flood Illuminator

v2-00 • 2023-Apr-04

---

### Abstract

The EGA2000-850-W is a small form factor surface mount infrared laser illuminator enabling a variety of use cases for industrial mass market applications.

# Content Guide

<b>1</b>	<b>General Description</b> .....	<b>3</b>	8.3	MSL Label.....	16
1.1	Key Benefits & Features.....	3	8.4	Label at Outer Box.....	17
1.2	Applications .....	3	<b>9</b>	<b>Soldering &amp; Storage Information</b>	<b>18</b>
1.3	Block Diagram .....	4	9.1	Soldering Information .....	18
1.4	Other General Characteristics.....	4	9.2	Storage Information .....	19
<b>2</b>	<b>Ordering Information</b> .....	<b>5</b>	9.3	Shelf Life.....	19
<b>3</b>	<b>Pin Assignment</b> .....	<b>6</b>	9.4	Floor Life.....	19
3.1	Pin Diagram.....	6	9.5	Rebaking Instructions .....	19
3.2	Pin Description .....	6	<b>10</b>	<b>Handling</b> .....	<b>20</b>
<b>4</b>	<b>Absolute Maximum Ratings</b> .....	<b>7</b>	10.1	Pick Up .....	20
<b>5</b>	<b>Performance Characteristics</b> .....	<b>8</b>	<b>11</b>	<b>Appendix</b> .....	<b>21</b>
5.1	Electrical Characteristics .....	8	11.1	RoHS Compliance .....	21
5.2	Optical Characteristics .....	8	11.2	Safety Advice.....	21
<b>6</b>	<b>Package Drawings</b> .....	<b>10</b>	11.3	Symbols and Abbreviations.....	22
<b>7</b>	<b>Application Information</b> .....	<b>11</b>	<b>12</b>	<b>Revision Information</b> .....	<b>23</b>
7.1	PCB Pad Layout and Solder Mask Recommendation .....	11	<b>13</b>	<b>Legal Information</b> .....	<b>24</b>
7.2	Orientation of the Field of Illumination.....	12			
7.3	Information on the 2D Barcode .....	13			
<b>8</b>	<b>Tape &amp; Reel Information</b> .....	<b>14</b>			
8.1	Overview.....	14			
8.2	Plastic Reel & MBB Bag.....	15			

# 1 General Description

## 1.1 Key Benefits & Features

The EGA2000-850-W module is specifically designed for monochromatic, infrared, high-power, uniform illumination.

The compact modules are assembled with ams OSRAM state-of-the-art component manufacturing processes and are reflow solderable. These modules, using laser illumination, allow improved efficiency, reduced footprint, and overall improved system performance.

**Figure 1:**  
**Added Value Overview**

Benefits	Features
Small package size	4.1 mm x 4.1 mm x 1.38 mm $\pm$ 0.100 mm
Power efficient	High power conversion efficiency
Easy component mounting	Standard lead-free solder reflow compatible
Uniform power distribution	100% tested for uniformity in the far field
Full traceability	Unit level track with 2D barcode

## 1.2 Applications

- Industrial applications using 3D Time-of-Flight and 2D NIR systems
- Machine vision
- Logistics automation
- Dimension weighting systems
- Autonomous robots

### 1.3 Block Diagram

The functional block of this device is shown below:

**Figure 2:**  
Functional Block of EGA2000-850-W

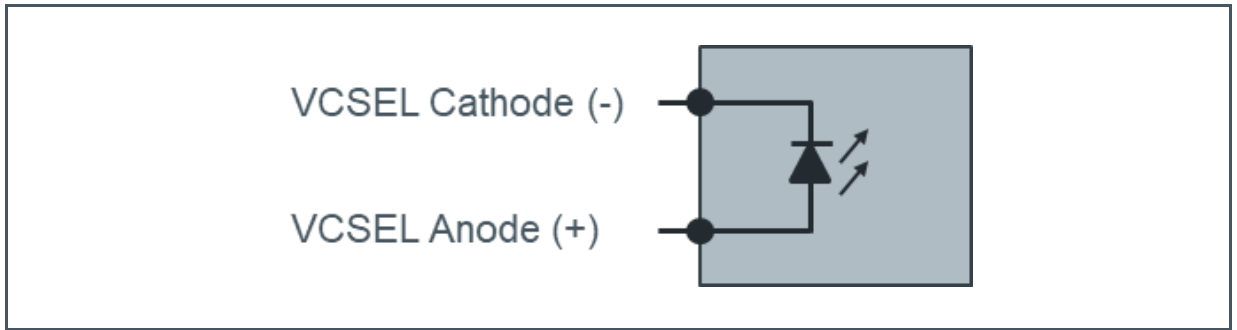

### 1.4 Other General Characteristics

Some additional features of this device are shown below:

**Figure 3:**  
Additional Characteristics

Parameter	Value
Light Source	VCSEL
Electrical Contacts	Anode/Cathode on backside
Number of Electrical Contacts	1x Cathode ; 1x Anode
Assembly Type	Reflow Compatible

---

## 2 Ordering Information

---

Ordering Code	Description	Delivery Form	Delivery Quantity
ASCX-00	EGA2000-850-W	Tape & Reel	4000 pcs/reel

---

## 3 Pin Assignment

### 3.1 Pin Diagram

Figure 4:  
Pin Diagram: Module Bottom View

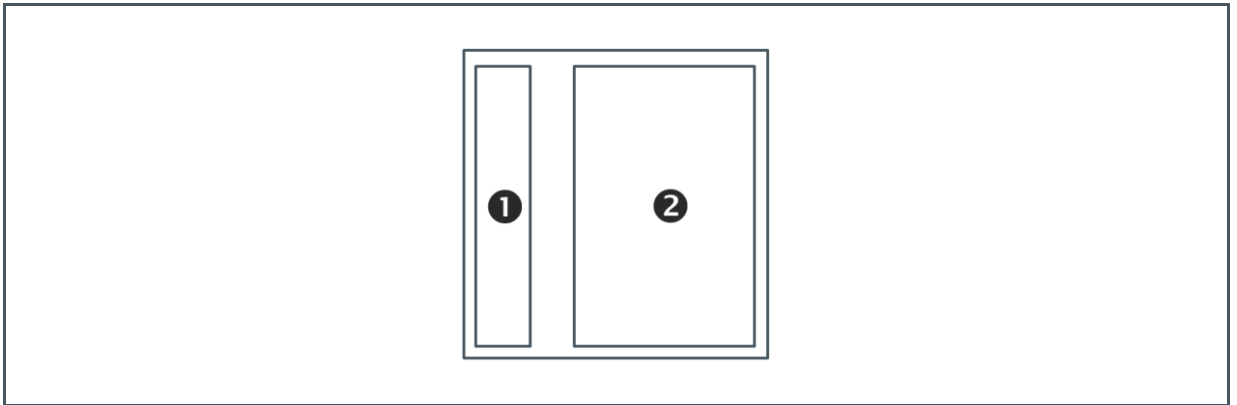

### 3.2 Pin Description

Figure 5:  
Pin Description of EGA2000-850-W

Pin Number	Pin Name	Description
1	Anode	VCSEL Power
2	Cathode	VCSEL Power

## 4 Absolute Maximum Ratings

Stresses beyond those listed under “Absolute Maximum Ratings” may cause permanent damage to the device. These are stress ratings only. Functional operation of the device at these or any other conditions beyond those indicated under “Operating Conditions” is not implied. Exposure to absolute maximum rating conditions for extended periods may affect device reliability.

**Figure 6:**  
**Absolute Maximum Ratings of EGA2000-850-W**

Symbol	Parameter	Min	Max	Unit	Comments
<b>Electrical Parameters</b>					
$I_{F,LD}$	Laser Diode Forward Current		10	A	Duty cycle = 1% Pulse width = 100 $\mu$ s @ 25 °C
$V_{R,LD}$	Laser Diode Reverse		5	V	DC mode @ 25 °C
$I_{R,LD}$	Laser Diode Reverse Current		25	nA	DC mode @ 25 °C
<b>Electrostatic Discharge</b>					
$ESD_{HBM}$	Electrostatic Discharge HBM	$\pm 2$		kV	JEDEC JS-001-2017
$ESD_{CDM}$	Electrostatic Discharge CDM	$\pm 750$		V	JEDEC JS-002-2018
<b>Temperature Ranges and Storage Conditions</b>					
$T_A$	Operating Ambient Temperature	-40	105	°C	
$T_{STRG}$	Storage Temperature Range	-40	125	°C	
$RH_{NC}$	Relative Humidity (non-condensing)		85	%	
MSL	Moisture Sensitivity Level		3		JESD22-A113D



## 5 Performance Characteristics

All limits are guaranteed. The parameters with Min and Max values are guaranteed with production tests or SQC (Statistical Quality Control) methods.

### 5.1 Electrical Characteristics

**Figure 7:**  
Electrical Parameters

Parameter	Conditions	Min	Typ	Max	Unit
Optical Output Power <sup>(1)</sup>	Pulse width=100 $\mu$ s, Duty cycle = 2%, @ 5 A @ 25 °C	3.62		4.82	W
Operating Voltage <sup>(1)</sup>	Pulse width=100 $\mu$ s, Duty cycle = 2%, @ 5 A @ 25 °C	1.8		2.7	V
Power Conversion Efficiency	Pulse width=100 $\mu$ s, Duty cycle = 2%, @ 5 A @ 25 °C	31		45	%

(1) Depending on driving conditions and thermal management.

### 5.2 Optical Characteristics

**Figure 8:**  
Optical Parameters

Parameter	Condition	Min	Typ	Max	Unit
Global Uniformity <sup>(1)</sup>	Pulse width=100 $\mu$ s, Duty cycle = 2%, @ 4 A @ 25 °C	-25		+25	%
Wavelength	Pulse width=100 $\mu$ s, Duty cycle = 2%, @ 4 A @ 25 °C	842	850	858	nm

Parameter	Condition	Min	Typ	Max	Unit
Spectral Width <sup>(2)</sup>	Pulse width=100 μs, Duty cycle = 2%, @ 4 A @ 25 °C	0.1		3	nm

- (1) Maximum deviation between average intensity in scanning windows rolling in 1° steps within the 80% intensity level.
- (2) Full width at half maximum

**Figure 9:**  
**Field of Illumination (FOI)**

Parameter	Condition	Min	Typ	Max	Unit
Horizontal FOI <sup>(1)(2)</sup>	Pulse width = 100 μs, Duty cycle = 2%, @ 4 A @ 25 °C	75	79	83	deg
Vertical FOI <sup>(1)(2)</sup>	Pulse width = 100 μs, Duty cycle = 2%, @ 4 A @ 25 °C	52	56	60	deg

- (1) Angle at 50% level normalized to the centroid.
- (2) Irradiance (W/m²)

# 6 Package Drawings

The drawing below is showing the module size and tolerances of the EGA2000-850-W module.

**Figure 10:**  
Package Dimensions<sup>(1)</sup>

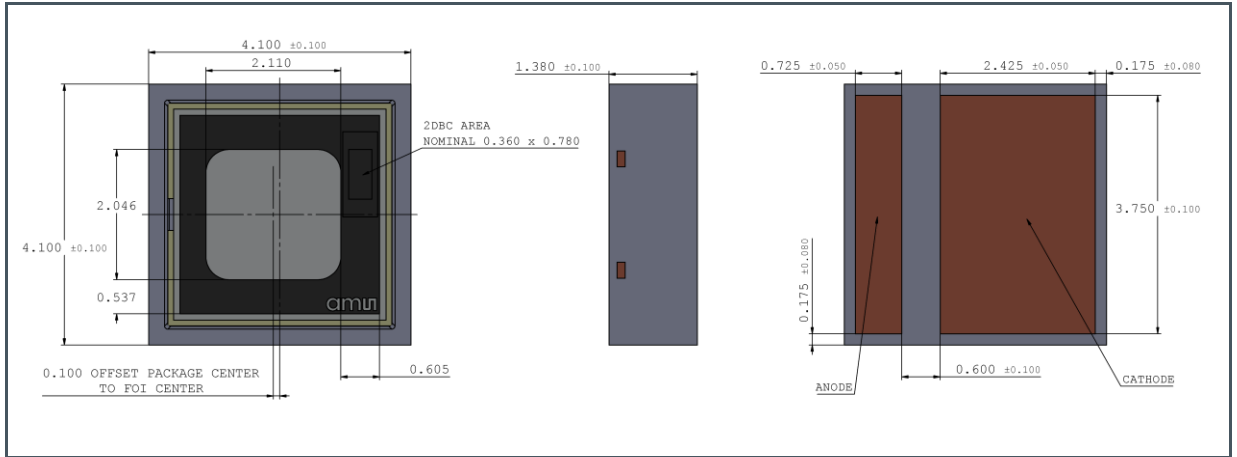

(1) All dimensions in mm.

**Figure 11:**  
Top and Bottom View

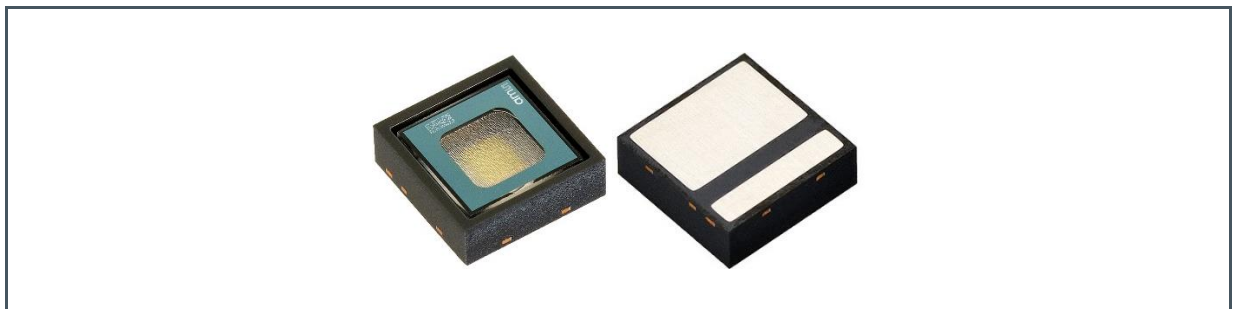

# 7 Application Information

## 7.1 PCB Pad Layout and Solder Mask Recommendation

The drawing below is showing a recommendation for pad layouts and solder mask. This is only to be used as guide and not to be considered as a firm specification.

**Figure 12:**  
**Recommended PCB Pad Layout (top view)<sup>(1)</sup>**

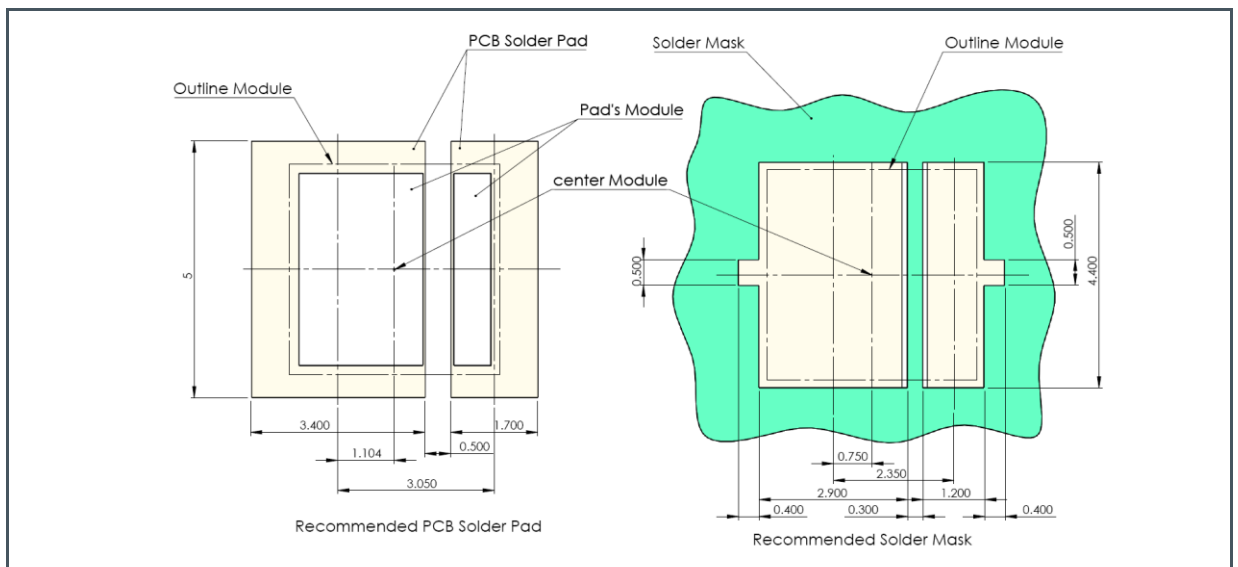

(1) All dimensions in mm.

## 7.2 Orientation of the Field of Illumination

The drawings below are showing the emitting area of the EGA2000-850-W module.

**Figure 13:**  
FOI Orientation Regarding Module Footprint

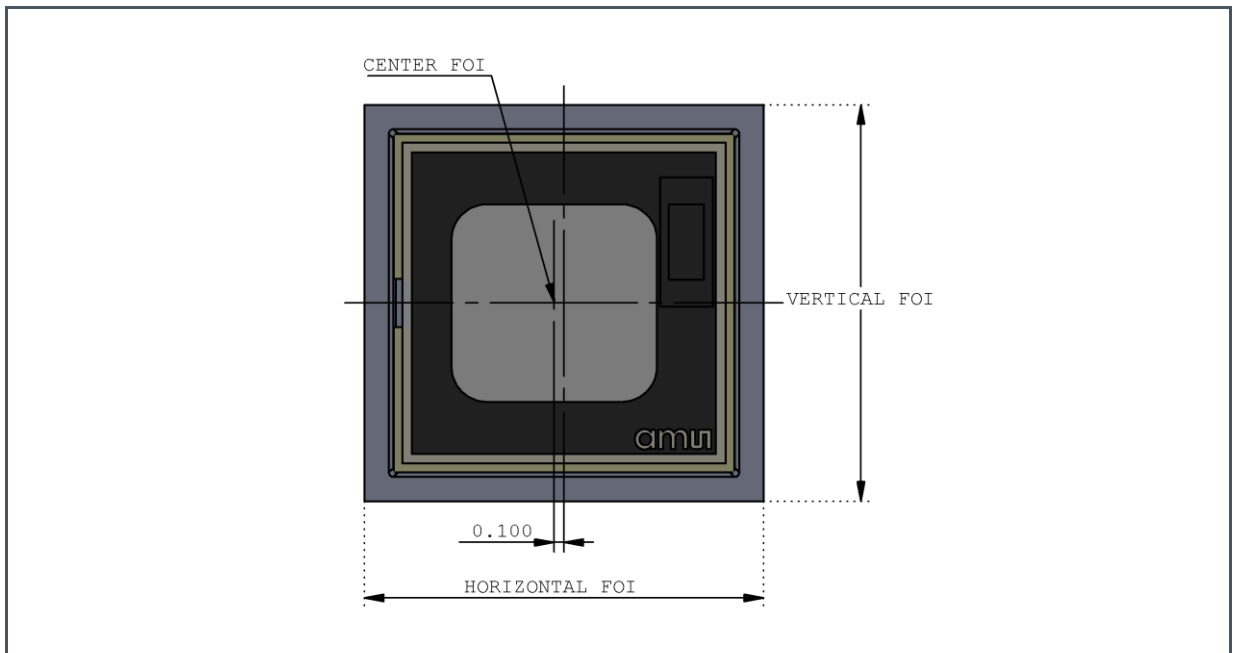

(1) All dimensions in mm.

**Figure 14:**  
FOI Projection

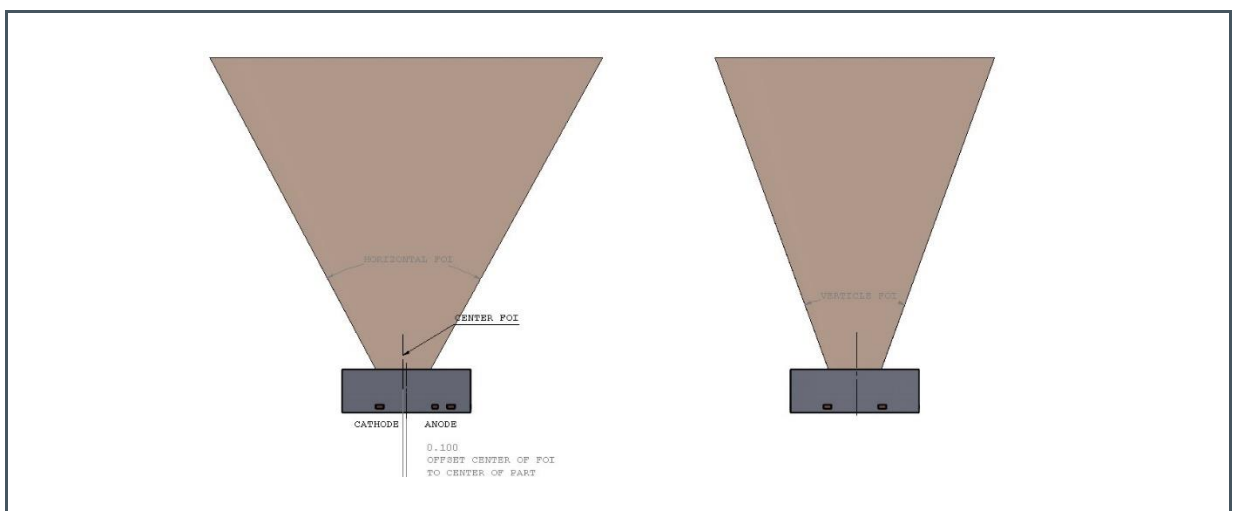

(1) All dimensions in mm.

## 7.3 Information on the 2D Barcode

The figure below shows the 2D barcode on the module that can be used for traceability purpose. The 2D barcode has 14 characters and contains the following information:

- Optics Lot number
- Year / Month / Day of manufacturing
- Lot running number and row & column coordinates located in the wafer
- Build type
- Configuration details

The module lot number can be traced back through module traceability report by referencing to the optics lot number.

**Figure 15:**  
2D Barcode Location on the Module

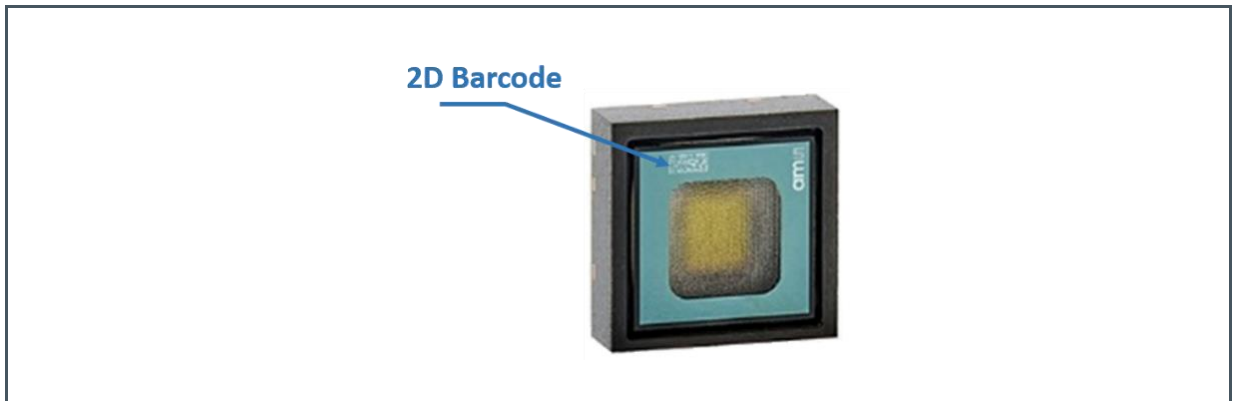

# 8 Tape & Reel Information

## 8.1 Overview

Sampling Shipments: The modules are shipped in tape & reel.

MP Shipments: The modules are shipped in tape & reel.

**Figure 16:**  
Carrier Tape Dimensions and Overview<sup>(1)(2)(3)</sup>

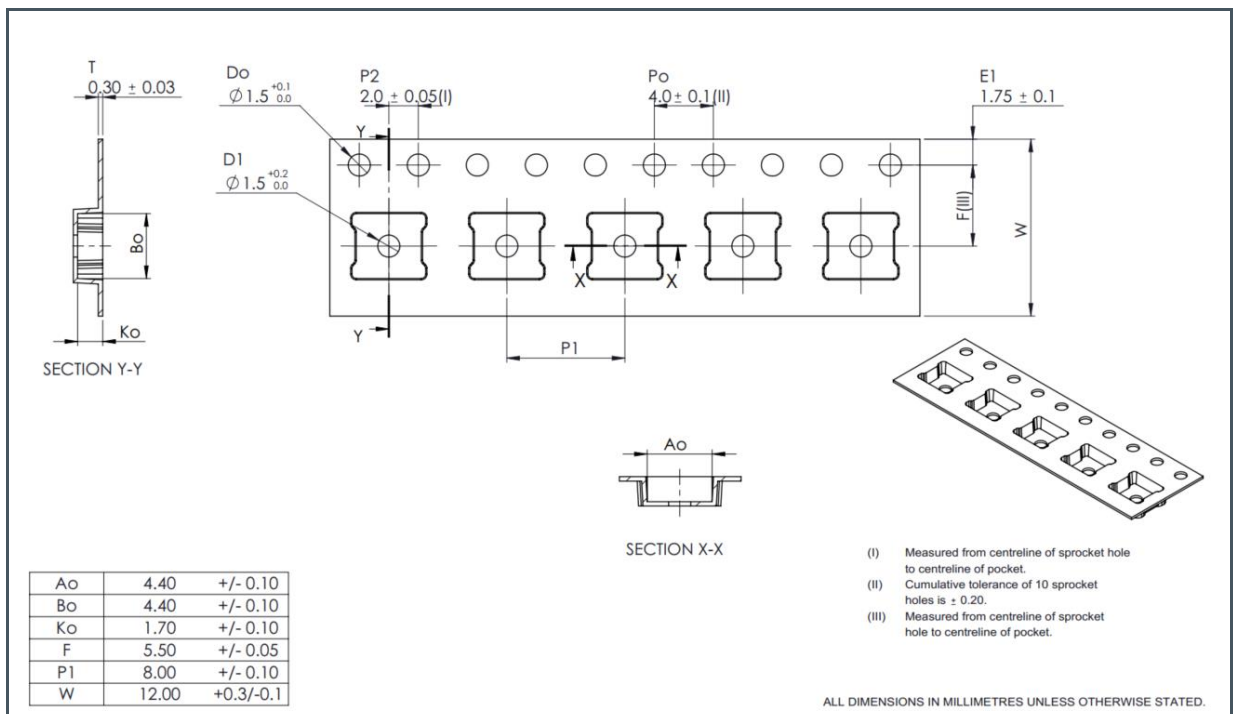

- (1) Cover tape dimensions are 9.3 mm.
- (2) Device pin 1 oriented towards tape holes.
- (3) Reference material: Polystyrene carrier and Polyester clear tape

## 8.2 Plastic Reel & MBB Bag

Reels are individually labeled and put inside a Moisture Barrier Bag (MBB). The label information is as follows:

- Part number
- Lot number
- Date code manufacturing
- Manufacturing country
- Expire date
- VCSEL batch
- Quantity
- Supplier information

**Figure 17:**  
**Shipping Label Example**



SN	Field	Definition	Remarks
1	Part No	Part Number	Product Device/Config
2	PT Lot No	Lot Number	Lot Number from system
3	Date Code 1	Date Code manufacturing	20 = year 2020, 08= week 08
4	Date Code 2	Date Code Lot 2 (merge lot)	
5	COO	Manufacturing Country	TH= Thailand
6	Expire date	Expire date about 1 year from manufacturing date	1 year from date code
7	Wafer No	VCSEL batch	
8	Wafer No 2	VCSEL batch 2 (merge lot)	
9	Quantity	Quantity of unit	
10	Supplier info	2D code information	

**Label Size : 80x48 mm**



### 8.3 MSL Label

The Moisture Sensitivity Level information is mentioned in the MBB Bag as shown in the figure below.

**Figure 18:**  
**MSL Label Example on MBB Bag**

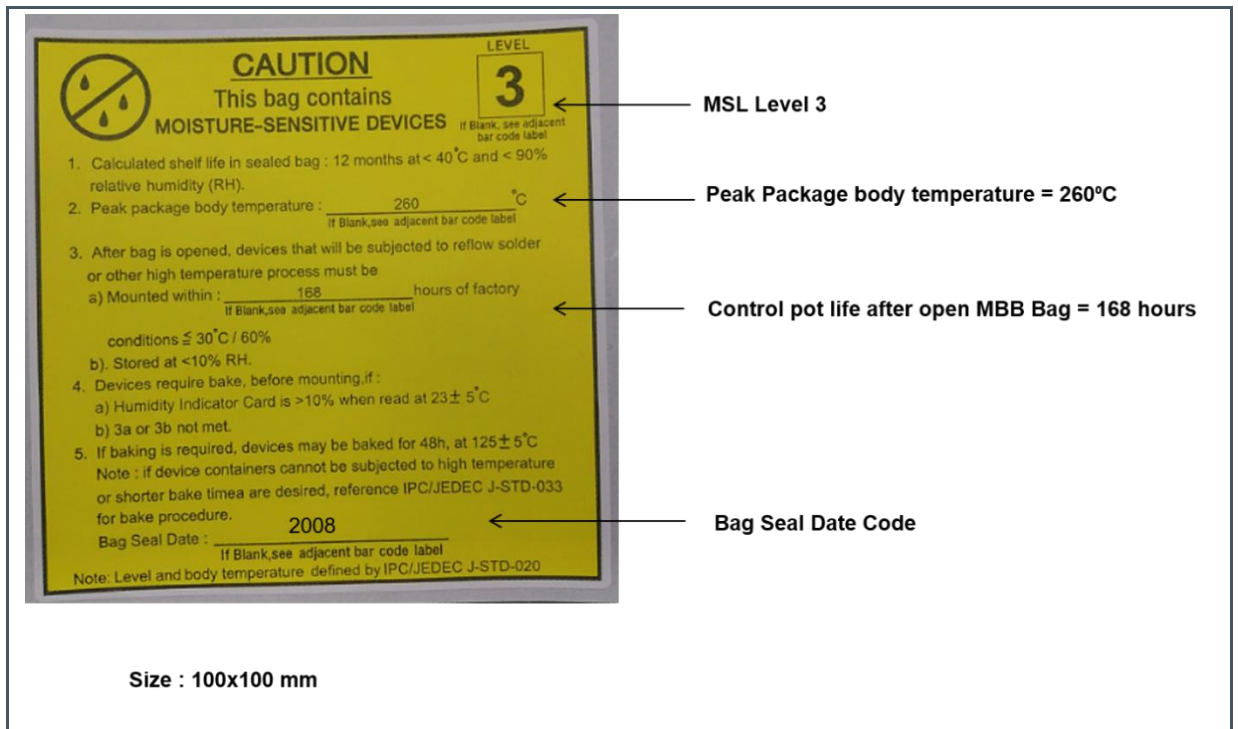

## 8.4 Label at Outer Box

The outer box containing all the plastic reels contain information as shown in the figure below.

**Figure 19:**  
**Label at Outer Box Example**



**Size : 140x80 mm**

S N	Field	Definition	Remarks
1	(P) Material No (Customer Part No)	Material Number	Customer partnumber for shipping label
2	Vendor P/N	Manufacturing part number	Marketing / Ordering Code
3	Vendor	Manufacturing part number	Vendor Code (for shipping label)
4	(Q) Quantity	Package quantity	built quantity
5	(4L) Country of Assembly	Country of Origin	this is similar with Country of Origin
6	(K) Trans. ID (Customer P.O No)	Need Info	Customer PO from Picklist
7	(P) SEC	Need Info	Customer partnumber for shipping label
8	MPN	Material Number	SAP MatNr
9	(2S) Shipment ID	Need Info	Picklist Generated - Hana generated
10	(3S) Package ID	Need Info	HUMO Identification - Hana generated
11	Gross Weight	Weight	actual weight of box for shipment

## 9 Soldering & Storage Information

### 9.1 Soldering Information

The EGA2000-850-W modules have been tested for lead-free solder reflow compatibility with peak temperatures up to 260 °C.

Although an example reflow profile is provided in the following figure, the exact reflow profile may depend on exact solder used.

**Figure 20:**  
Solder Reflow Profile Graph Example (for reference only)

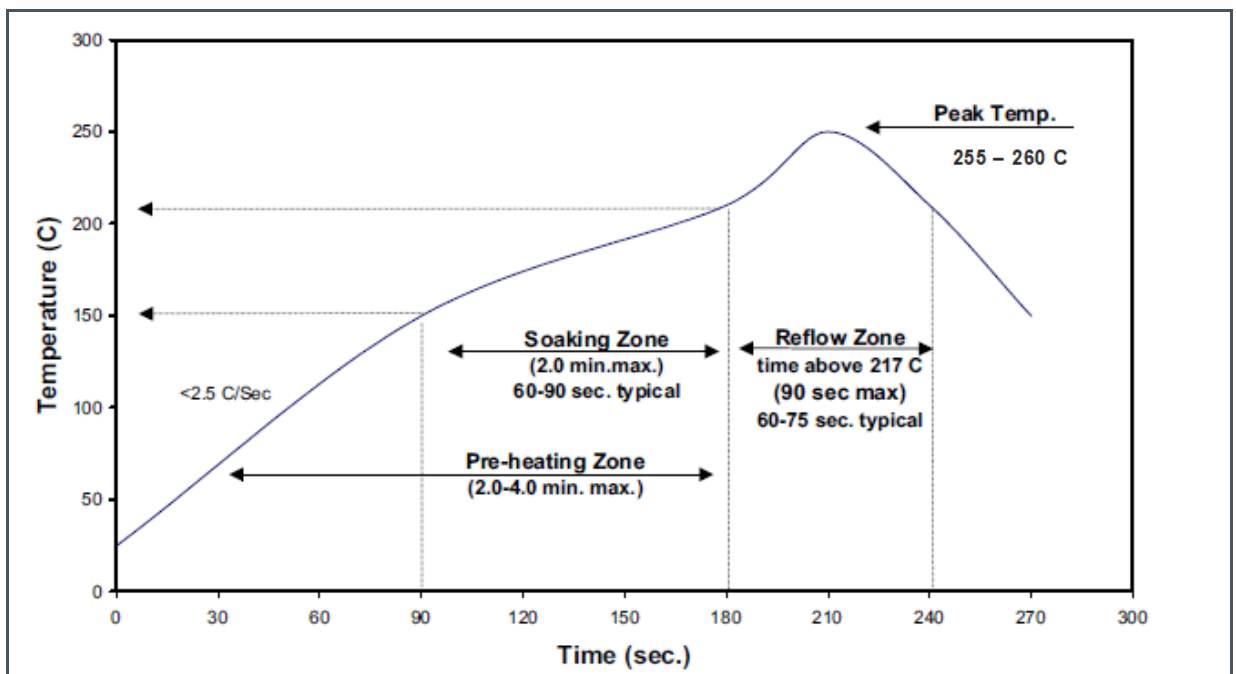

#### Attention

- It is not advised to proceed to cleaning after SMT reflow process.
- The modules **MUST NOT** be cleaned using ultrasonic cleaning.
- We suggest to use “no clean solder paste” and not to clean after SMT.
- In case a cleaning is un-avoidable, rinse with DI water, followed by a 2h bake @70 °C.

---

## 9.2 Storage Information

Moisture sensitivity optical characteristics of the device can be adversely affected during the soldering process by the release and vaporization of moisture that has been previously absorbed into the package. To ensure the package contains the smallest amount of absorbed moisture possible, each device is baked prior to being dry packed for shipping. Devices are dry packed in a sealed aluminized envelope called a moisture-barrier bag with silica gel to protect them from ambient moisture during shipping, handling, and storage before use.

---

## 9.3 Shelf Life

The calculated shelf life of the device in an unopened moisture barrier bag is 12 months from the date code on the bag when stored under the following conditions:

- Shelf Life: 12 months
- Ambient Temperature: <40°C
- Relative Humidity: <90%

Rebaking of the devices will be required if the devices exceed the 12 month shelf life and the Humidity Indicator Card shows that the devices were exposed to conditions beyond the allowable moisture region.

---

## 9.4 Floor Life

The module has been assigned a moisture sensitivity level of MSL 3. As a result, the floor life of devices removed from the moisture barrier bag is 168 hours from the time the bag was opened, provided that the devices are stored under the following conditions:

- Floor Life: 168 hours
- Ambient Temperature: <30°C
- Relative Humidity: <60%

If the floor life or the temperature/humidity conditions have been exceeded, the devices must be rebaked prior to solder reflow or dry packing.

---

## 9.5 Rebaking Instructions

When the shelf life or floor life limits have been exceeded, rebaking is required based on recommended baking conditions (7h at 105 °C).

# 10 Handling

## 10.1 Pick Up

Recommended pick up position on the top window (hatched area in the figure), touching directly the glass.

**Figure 21:**  
**Pick Up Location<sup>(1)</sup>**

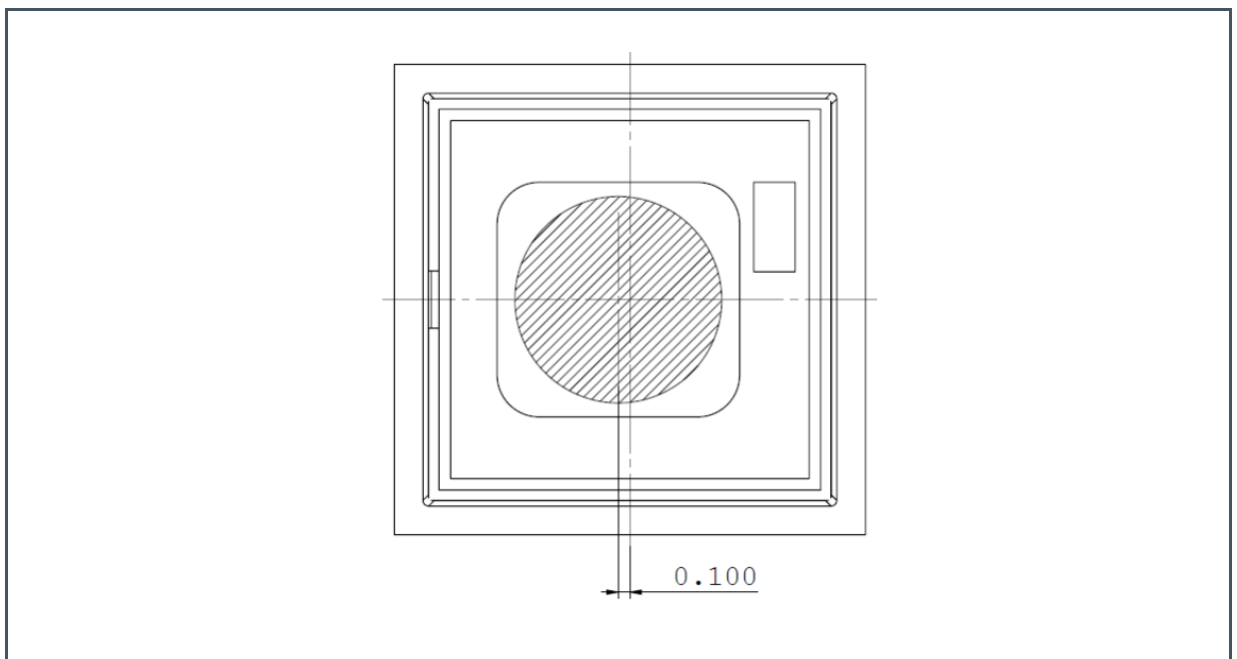

(1) All dimensions in mm.

---

# 11 Appendix

---

## 11.1 RoHS Compliance

The EGA2000-850-W module is RoHS compliant.

## 11.2 Safety Advice

Depending on the operational use of the device, the modules can emit highly concentrated non-visible infrared light, which can be hazardous to the human eyes. Products incorporating these modules may have to follow the safety precautions described by IEC 60825-1 and IEC 62471.

This product emits infrared radiation and has not yet been classified under IEC 60825-1. All appropriate safety precautions should be exercised in the operation and use of this product.



### CAUTION

- Avoid direct eye exposure except as may be determined and directed by purchaser.
- Appropriate protective eyewear should be worn when operating.
- Use of magnifying optical instruments with this component may increase eye hazard.
- Avoid obstructing fully the optical path, due to risk for the lens to melt and cause eye hazard.
- Obstructing, redirecting or focusing the optical power back to the module is considered a device misuse and can potentially lead to a health hazard.



**LASER PRODUCT**  
LASER RADIATION – AVOID DIRECT EYE EXPOSURE  
WAVELENGTH: 850nm  
MAXIMUM OUTPUT POWER: Depends on drive mode  
WEAR PROTECTIVE GLASSES

---

## 11.3 Symbols and Abbreviations

Figure 22:  
Symbols and Abbreviations Used in the Datasheet

Symbol/Abbreviation	Description
DI	Deionized
FOI	Field of Illumination
FWHM	Full Width at Half Maximum
ID	Identification
IR	Infrared
LD	Laser Diode
LI	Light-Current
LIV	Light-Current-Voltage
MP	Mass Production
MSL	Moisture Sensitivity Level
RoHS	Restriction of Hazardous Substances
SMT	Surface Mount Technology
VCSEL	Vertical Cavity Surface Emitting Laser

# 12 Revision Information

Document Status	Product Status	Definition
Product Preview	Pre-Development	Information in this datasheet is based on product ideas in the planning phase of development. All specifications are design goals without any warranty and are subject to change without notice
Preliminary Datasheet	Pre-Production	Information in this datasheet is based on products in the design, validation or qualification phase of development. The performance and parameters shown in this document are preliminary without any warranty and are subject to change without notice
Datasheet	Production	Information in this datasheet is based on products in ramp-up to full production or full production which conform to specifications in accordance with the terms of ams-OSRAM AG standard warranty as given in the General Terms of Trade
Datasheet (discontinued)	Discontinued	Information in this datasheet is based on products which conform to specifications in accordance with the terms of ams-OSRAM AG standard warranty as given in the General Terms of Trade, but these products have been superseded and should not be used for new designs

Changes from previous version to current revision v2-00	Page
---	------

Document security class is changed from “Confidential” to “Public”

- Page and figure numbers for the previous version may differ from page and figure numbers in the current revision.
- Correction of typographical errors is not explicitly mentioned.



# 13 Legal Information

## Copyrights & Disclaimer

Copyright ams-OSRAM AG, Tobelbader Strasse 30, 8141 Premstaetten, Austria-Europe. Trademarks Registered. All rights reserved. The material herein may not be reproduced, adapted, merged, translated, stored, or used without the prior written consent of the copyright owner.

Devices sold by ams-OSRAM AG are covered by the warranty and patent indemnification provisions appearing in its General Terms of Trade. ams-OSRAM AG makes no warranty, express, statutory, implied, or by description regarding the information set forth herein. ams-OSRAM AG reserves the right to change specifications and prices at any time and without notice. Therefore, prior to designing this product into a system, it is necessary to check with ams-OSRAM AG for current information. This product is intended for use in commercial applications. Applications requiring extended temperature range, unusual environmental requirements, or high reliability applications, such as military, medical life-support or life-sustaining equipment are specifically not recommended without additional processing by ams-OSRAM AG for each application. This product is provided by ams-OSRAM AG "AS IS" and any express or implied warranties, including, but not limited to the implied warranties of merchantability and fitness for a particular purpose are disclaimed.

ams-OSRAM AG shall not be liable to recipient or any third party for any damages, including but not limited to personal injury, property damage, loss of profits, loss of use, interruption of business or indirect, special, incidental or consequential damages, of any kind, in connection with or arising out of the furnishing, performance or use of the technical data herein. No obligation or liability to recipient or any third party shall arise or flow out of ams-OSRAM AG rendering of technical or other services.

## RoHS Compliant & ams Green Statement

**RoHS Compliant:** The term RoHS compliant means that ams-OSRAM AG products fully comply with current RoHS directives. Our semiconductor products do not contain any chemicals for all 6 substance categories plus additional 4 substance categories (per amendment EU 2015/863), including the requirement that lead not exceed 0.1% by weight in homogeneous materials. Where designed to be soldered at high temperatures, RoHS compliant products are suitable for use in specified lead-free processes.

**ams Green (RoHS compliant and no Sb/Br/Cl):** ams Green defines that in addition to RoHS compliance, our products are free of Bromine (Br) and Antimony (Sb) based flame retardants (Br or Sb do not exceed 0.1% by weight in homogeneous material) and do not contain Chlorine (Cl) not exceed 0.1% by weight in homogeneous material).

**Important Information:** The information provided in this statement represents ams-OSRAM AG knowledge and belief as of the date that it is provided. ams-OSRAM AG bases its knowledge and belief on information provided by third parties, and makes no representation or warranty as to the accuracy of such information. Efforts are underway to better integrate information from third parties. ams-OSRAM AG has taken and continues to take reasonable steps to provide representative and accurate information but may not have conducted destructive testing or chemical analysis on incoming materials and chemicals. ams-OSRAM AG and ams-OSRAM AG suppliers consider certain information to be proprietary, and thus CAS numbers and other limited information may not be available for release.

## Headquarters

ams-OSRAM AG  
Tobelbader Strasse 30  
8141 Premstaetten  
Austria, Europe  
Tel: +43 (0) 3136 500 0

Please visit our website at [www.ams.com](http://www.ams.com)

Buy our products or get free samples online at [www.ams.com/Products](http://www.ams.com/Products)

Technical Support is available at [www.ams.com/Technical-Support](http://www.ams.com/Technical-Support)

Provide feedback about this document at [www.ams.com/Document-Feedback](http://www.ams.com/Document-Feedback)

For sales offices, distributors and representatives go to [www.ams.com/Contact](http://www.ams.com/Contact)

For further information and requests, e-mail us at [ams\\_sales@ams.com](mailto:ams_sales@ams.com)