



Product  
Range

Designed to Prevent Vehicle Intrusion

STREET FURNITURE & BOLLARDS



Protecting Public Spaces

HANDBOOK







# Protecting Public Spaces



As the world reacts to the growing threat of motor vehicles being used in terrorist attacks local & state governments are now tasked with how best to protect people in public spaces.

In the past the logical solution was to install certified crash rated specialised products. These solutions take time to plan and install, are normally very expensive and often result in a fortress style atmosphere.

A new alternative currently being suggested from Security Agencies is to take a more simple approach by **Stopping Vehicles Gaining Entry.**

Street furniture elements strategically positioned deny vehicle access and provide a more economically engineered solution.

**The key requirements in implementing this are:**

- All products used need to be connected to the pavement by shear keys
- No openings more than 1.2m wide
- Easy for pedestrians to navigate
- Aesthetically attractive
- Allow service vehicle access

LEDA's Street Furniture range has been designed with Security and **Hostile Vehicle Mitigation (HVM)** as the main criteria. With this in mind it is important that architects and end users have a choice in deciding whether to select certified product that has been successfully impact tested (normally involve imported and expensive product) or locally manufactured more economical **Engineered Solutions.**

*LEDA's extensive experience has allowed us to develop the following comprehensive range of Street Furniture for use in crowded & public spaces.*

ENGINEERED SOLUTIONS



The Cube



The Log

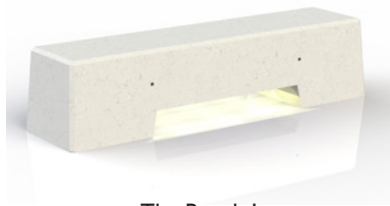

The Bench Log

Optional Seating



Timber Slats



Recycled Plastic Slats

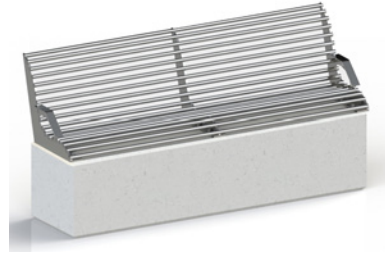

Stainless Steel Seating

Planter Boxes



Planter Box (Square)



Planter Box (Rectangular)



Planter Box (Rectangular)

Bollards



Colossus

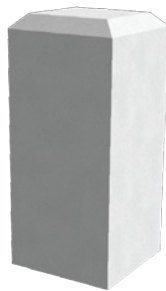

Russell Square



Russell Round

PAS68 TESTED & CERTIFIED



Fixed & Retractable



Westminster



Litter Bin



Planter Box



Seating

Refer to Security Section of LEDA Bollard Handbook

**LOG and CUBE**

**Precast Concrete Options**

Our log and cube models are available in a variety of precast concrete and natural stone finishes

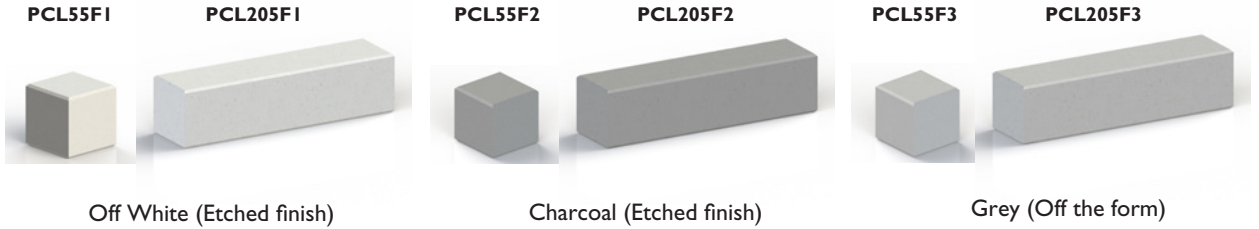

**Natural Stone Options**



**Both the precast and natural stone cube and logs can be**

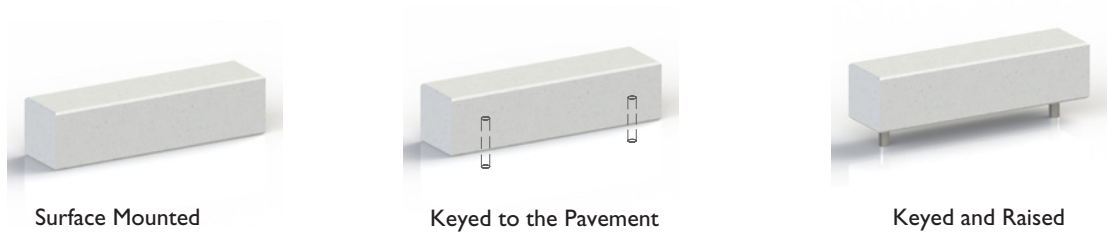

**Seating options**

To further improve functionality of the elements they can be converted to seating using either timber, stainless steel or recycled plastic options.

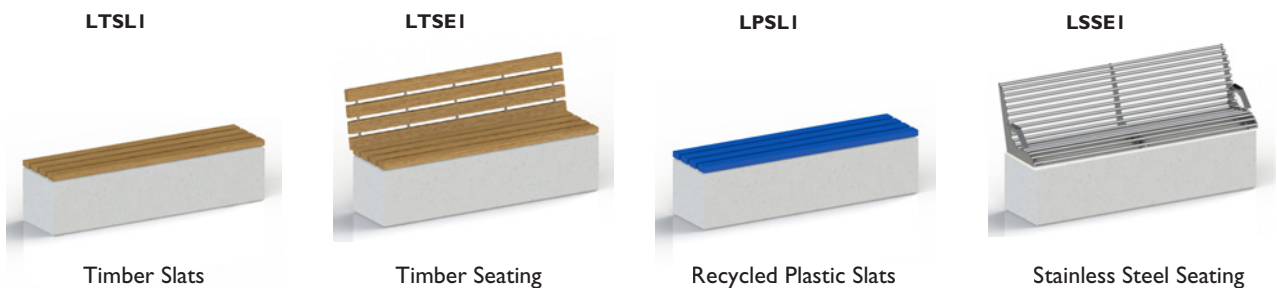



# Protecting Public Spaces > Engineered

## Cube

An attractive and effective vehicle access control delineator or seating module.

**Material** Precast concrete  
**Finish** Off-white etched finish / Grey off the form / Charcoal etched finish  
**Weight** 310kg

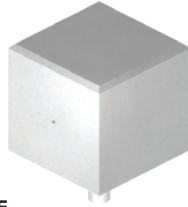

ENGINEERED SOLUTION



### PRECAST CONCRETE CUBE

Flat On Ground

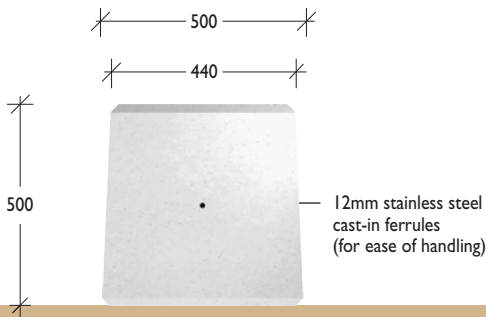

**PCL55F1**  
Off white

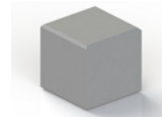

**PCL55F2**  
Charcoal



**PCL55F3**  
Grey off the form

## Log

An attractive and effective vehicle access control delineator or seating module.

**Material** Precast concrete  
**Finish** Off-white etched finish / Grey off the form / Charcoal etched finish  
**Weight** 1300kg

### PRECAST CONCRETE LOG



ENGINEERED SOLUTION



**PCL205F1**  
Off white



**PCL205F2**  
Charcoal



**PCL205F3**  
Grey off the form

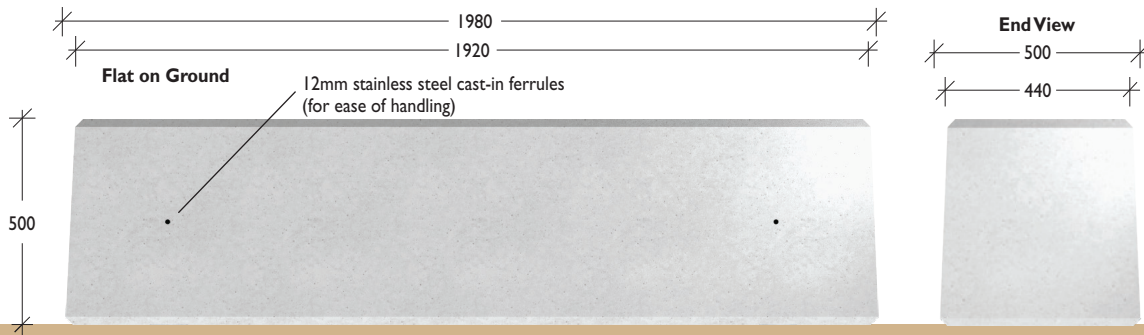

Protecting Public Spaces > Engineered

**Cube**

**Material** Natural stone  
**Finish** Sandstone / Black Granite / Mist Marble / Bluestone  
**Weight** 400kg

An attractive and effective vehicle access control delineator or seating module.

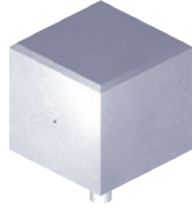

**NATURAL STONE CUBE**

**ENGINEERED SOLUTION**

Flat On Ground

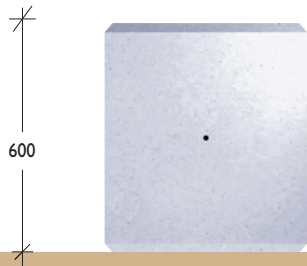

600

12mm stainless steel cast-in ferrules (for ease of handling)



**NSC55F1**  
Hawksbury Sandstone

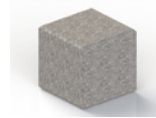

**NSC55F2**  
Adelaide Black Granite



**NSC55F3**  
Victorian Bluestone



**NSC55F4**  
Bianca Mist Marble



**Log**

**Material** Natural stone  
**Finish** Sandstone / Black Granite / Mist Marble / Bluestone  
**Weight** 1500kg

An attractive and effective vehicle access control delineator or seating module.

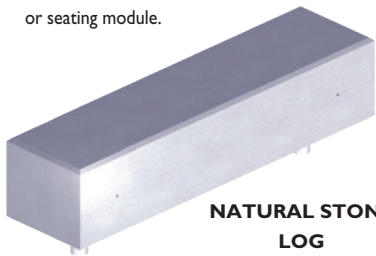

**NATURAL STONE LOG**

**ENGINEERED SOLUTION**



**NSL205F1**  
Hawksbury Sandstone



**NSL205F2**  
Adelaide Black Granite



**NSL205F3**  
Victorian Bluestone



**NSL205F4**  
Bianca Mist Marble

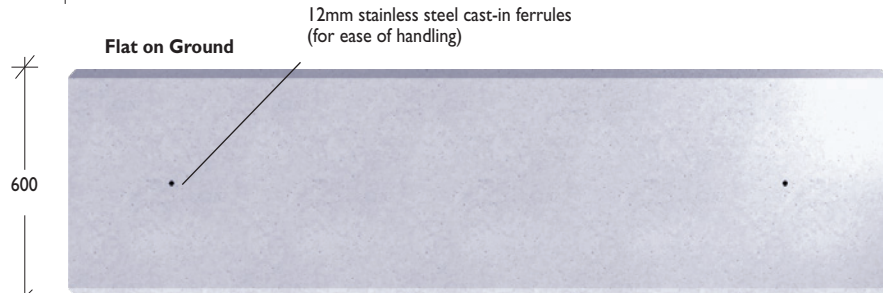
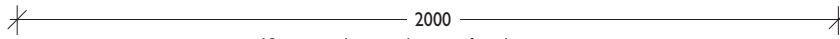

600

Flat on Ground

12mm stainless steel cast-in ferrules (for ease of handling)



End View

500



**IMPROVED IMPACT RESISTANCE**

Where vehicle intrusion and security is required all Leda's street furniture can be keyed into the pavement by **Locking Shear Pins**.

**ENGINEERED SOLUTION**

*When ordering please select and nominate locking pins from following page.*

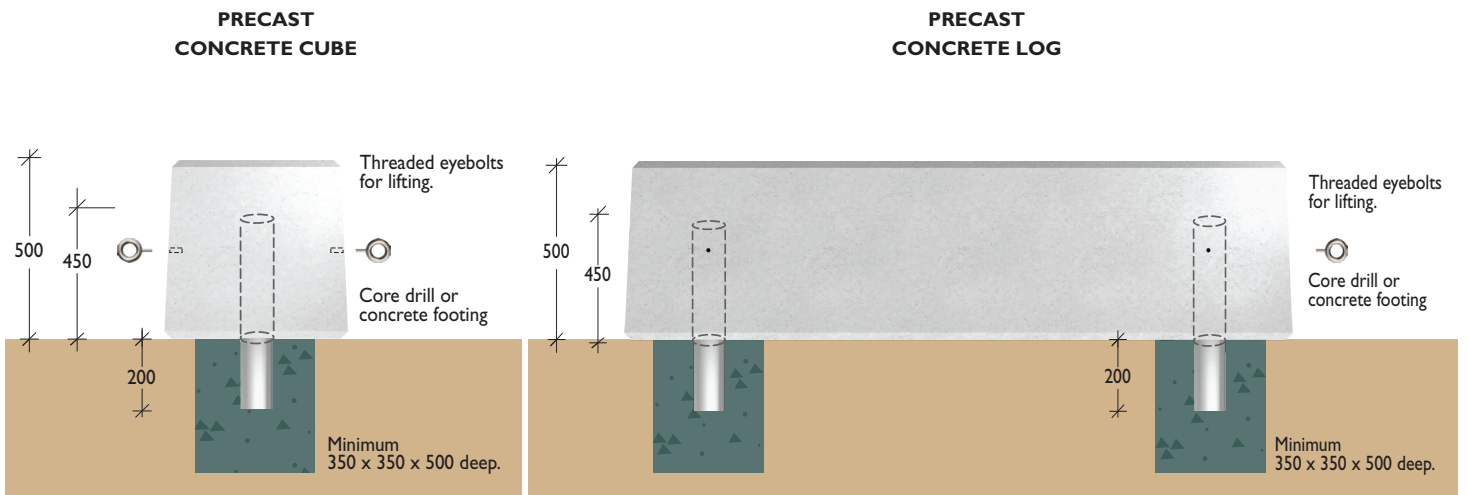

*Installation is a simple matter of core drilling into the existing pavement.*

**LOG AND CUBE ELEVATED**

The log and cube can also be elevated 100mm to increase both the impact height and facilitate cleaning.

*When ordering please select and nominate locking pins from following page.*

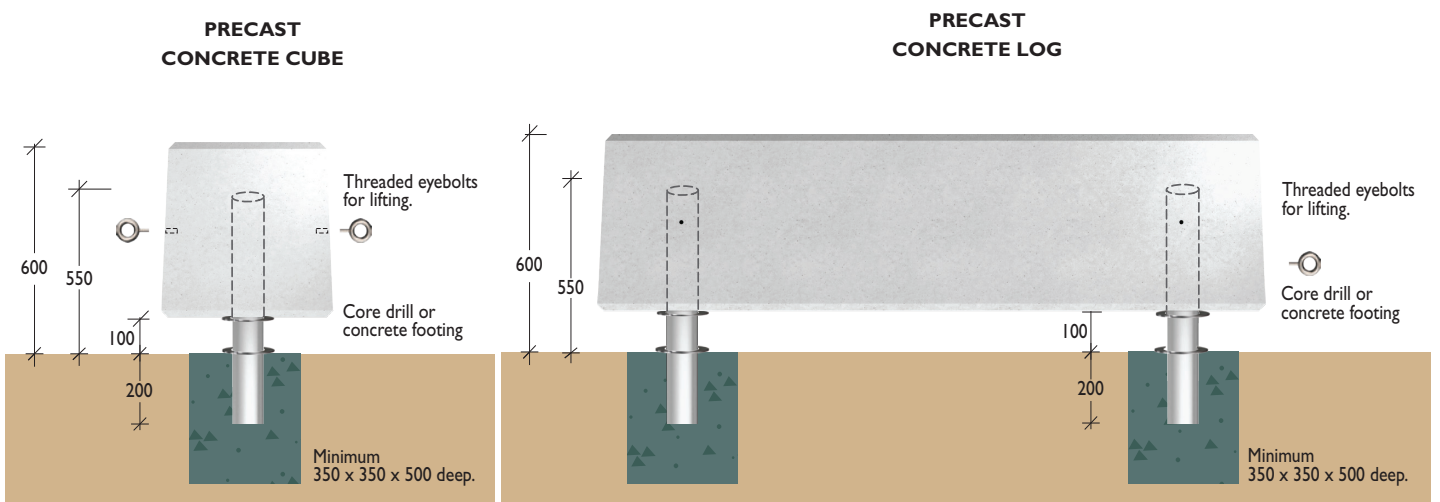

# Protecting Public Spaces > Engineered

## Bench Log

**Material** Precast Concrete  
**Finish** Off-white etched finish / grey off the form / charcoal etched finish  
**Weight** 1120kg

The Bench Log is also available as a stand alone unit or can be anchored to the pavement with our locking pin options.

**ENGINEERED SOLUTION**



Bench log with hidden LED lighting provision is optional

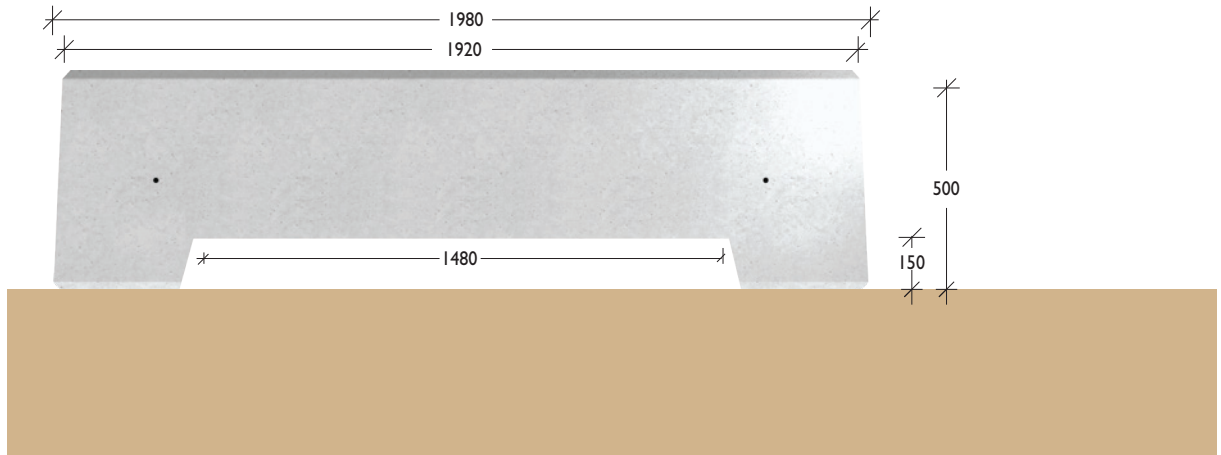

## Locking Pins

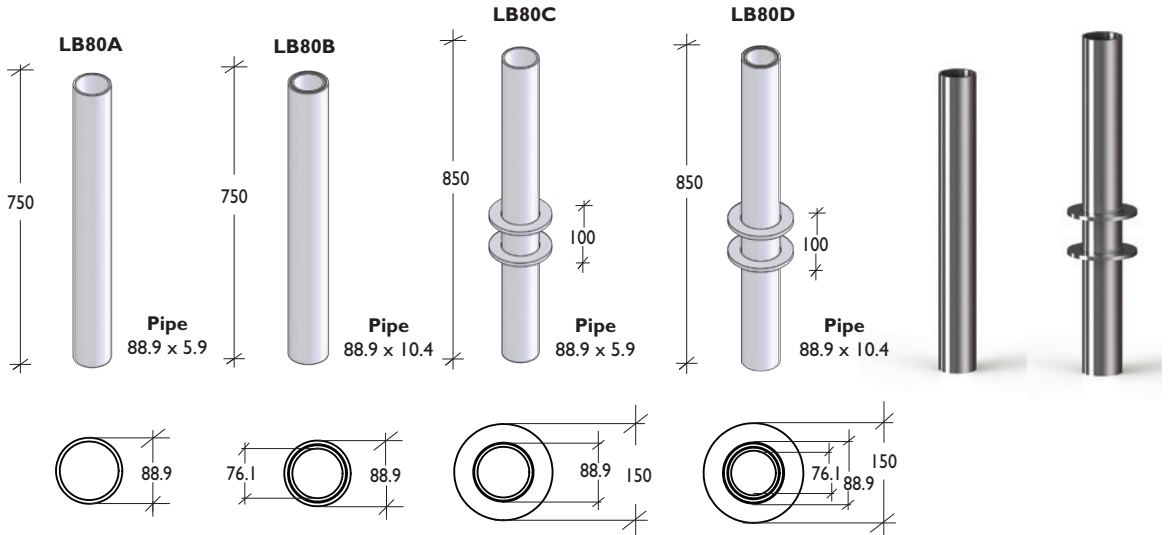



# Protecting Public Spaces > Engineered/PAS68 Certified

Product Range

1300 780 450

## Bollards Colossus

**Material** Precast concrete  
80NB (88.9) x 5.9mm/10.4mm heavy duty galvanised pipe  
**Finish** Off-white etched finish / grey off the form / charcoal etched finish  
**Weight** 800kg



Threaded eyebolts for lifting. Refer Accessories section.

16mm stainless steel cast-in ferrule (for ease of lifting)  
**Spherical with Flat Base**  
BLBOL

Top View

ENGINEERED SOLUTION

675

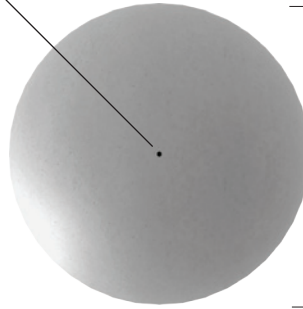
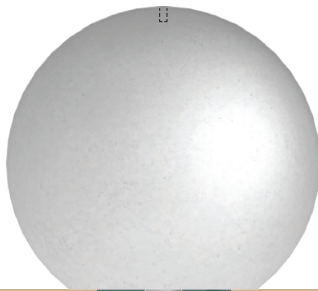

800



**BLBOL1**  
Off white



**BLBOL2**  
Charcoal



**BLBOL3**  
Grey off the form

300



Minimum 350 x 350 x 500 deep.

## Bollards Westminster

**Material** Engineered Steel either unpainted or with a primed finish  
**Finish** Manganese Steel, supplied raw (unpainted) as standard with a blank front face. Can be printed and fitted with a corporate logo or crest

**PAS68 Security Rating**

V/ 7500[N3]/64/90:0.0/5.3

**WBSM10** Shallow Mount

**WBDF10** Deep Fixed In Situ

PAS68 TESTED



1430  
Front View

260  
220

Side View

Shallow mount footing illustrated



1029

100

Impact direction →



The Westminster Bollards are available in shallow mount footing, removable or deep fixed in-situ models

Protecting Public Spaces > Engineered

**Bollards**  
Russell Square

**Material** Precast concrete  
**Finish** Off-white etched finish / Grey off the form / Charcoal etched finish



**ENGINEERED SOLUTION**

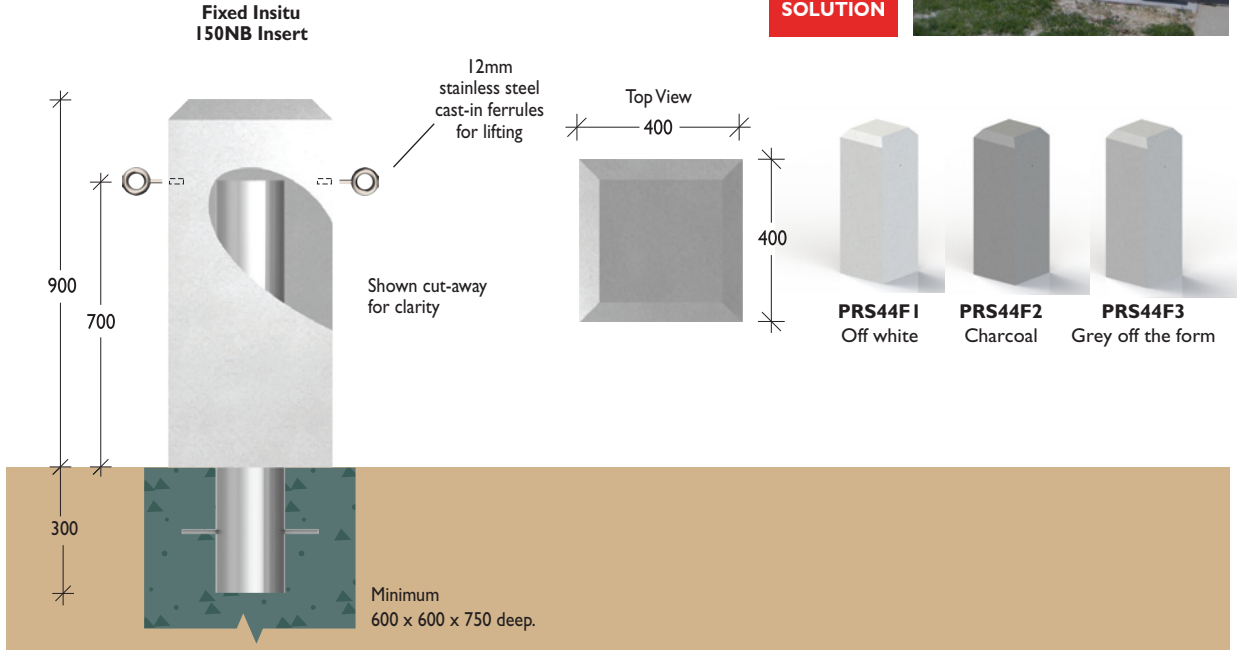

**Bollards**  
Russell Round

**Material** Precast concrete  
**Finish** Off-white etched finish, Grey off the form / Charcoal etched finish



**ENGINEERED SOLUTION**

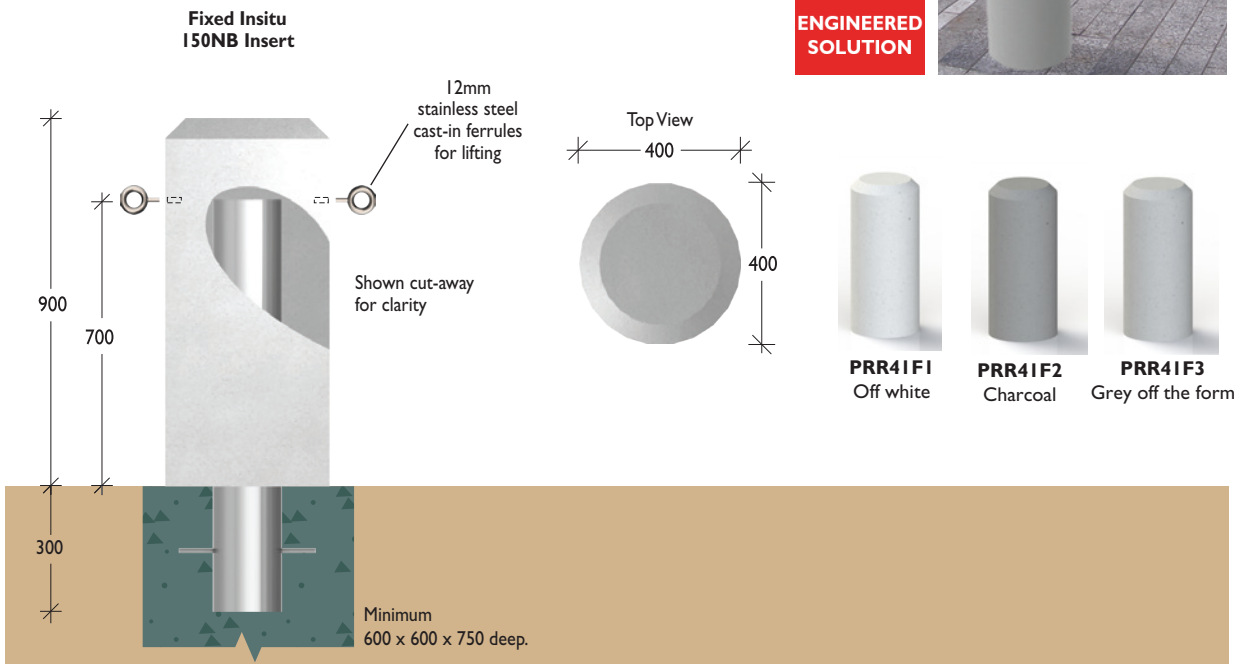

Protecting Public Spaces > Engineered

**Bollards**  
Russell Square

**Material** Natural stone  
**Finish** Sandstone / Black Granite / Mist Marble / Bluestone

**ENGINEERED SOLUTION**

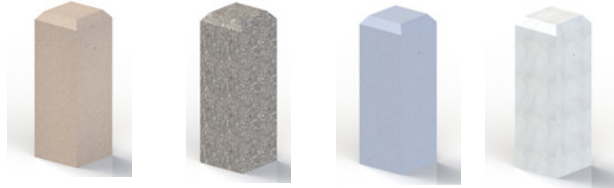

**NSRS44F1**  
Hawksbury Sandstone

**NSRS44F2**  
Adelaide Black Granite

**NSRS44F3**  
Victorian Bluestone

**NSRS44F4**  
Bianca Mist Marble

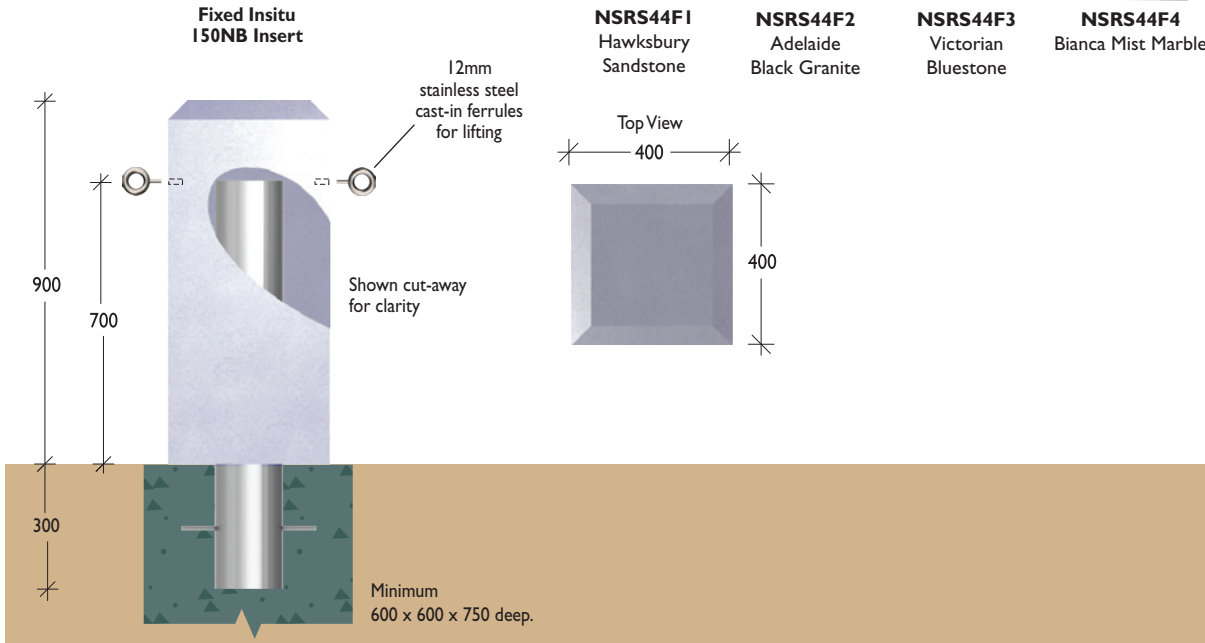

**Bollards**  
Russell Round

**Material** Natural stone  
**Finish** Sandstone / Black Granite / Mist Marble / Bluestone

**ENGINEERED SOLUTION**



**NSRR41F1**  
Hawksbury Sandstone

**NSRR41F2**  
Adelaide Black Granite

**NSRR41F3**  
Victorian Bluestone

**NSRR41F4**  
Bianca Mist Marble

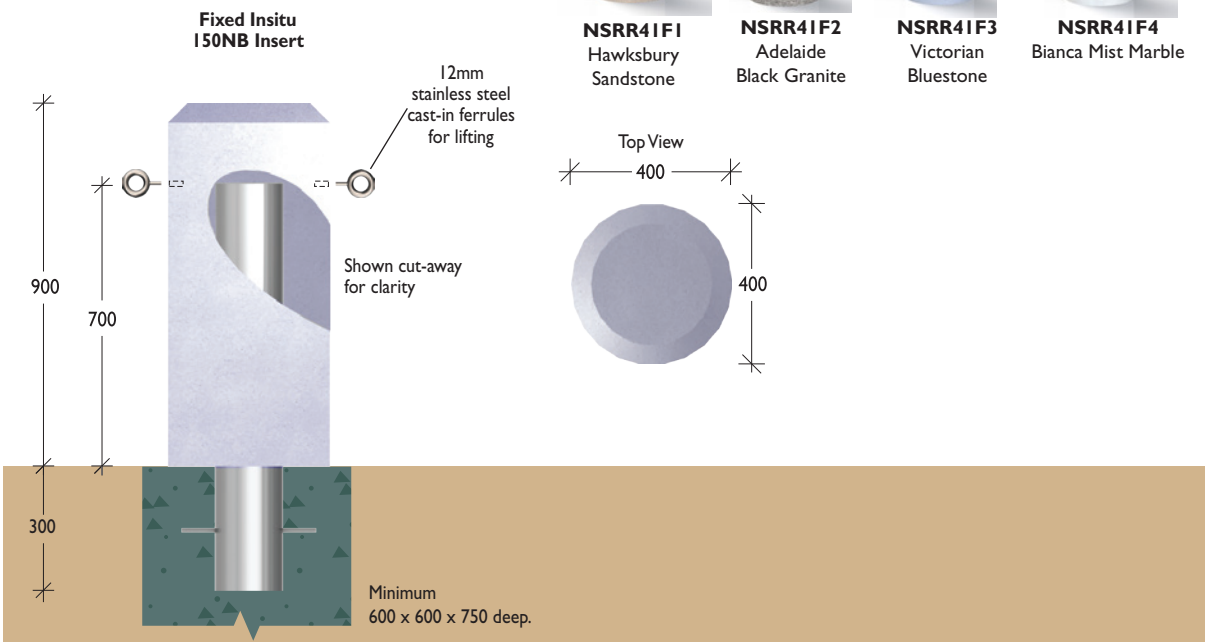



☎ 1300 780 450

**Planter Boxes**

**Material** Precast concrete  
80NB (88.9) x 5.9mm/10.4mm heavy duty galvanised pipe

**Finish** Off-white etched finish / grey off the form / charcoal etched finish

Precast concrete planter boxes can provide an extremely visible deterrent while also enhancing the landscape.

*LEDA's planter boxes can be mounted directly onto the pavement or fitted with locking pins to key them into the pavement*

*Locking pin details (See Page 7)*

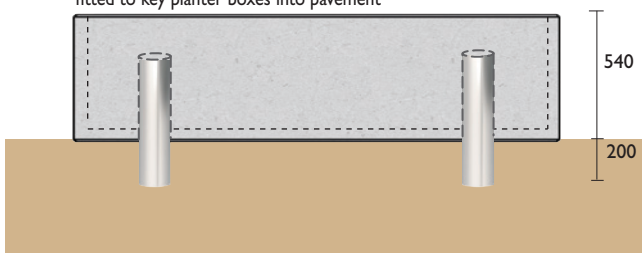
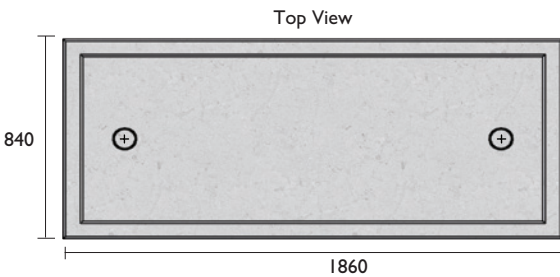
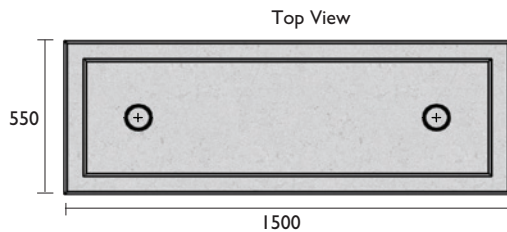
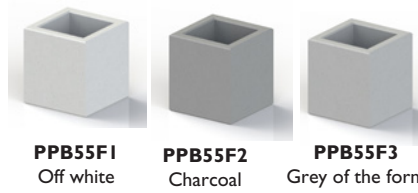
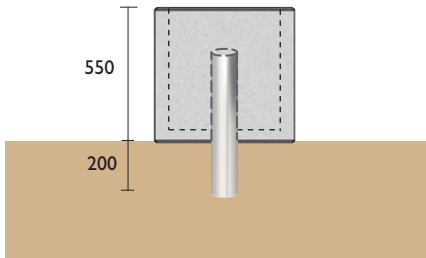
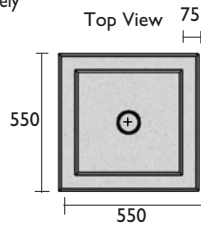

Optional locking pins can be fitted to key planter boxes into pavement

# Protecting Public Spaces > Engineered

## Pedestrian Railing

**Material** 150NB (168.3) x 3.4/7.11/10.97mm Grade 304 stainless steel pipe  
 Rail 50NB (60.33) x 3.4 Grade 304 stainless steel pipe  
**Finish** Linished or electro-polished

Bollards available in 3 various wall thickness

- Fixed In situ**
- SSP155FA 3.40 **1**
  - SSP155FB 7.11 **2**
  - SSP155FC 10.97 **2**

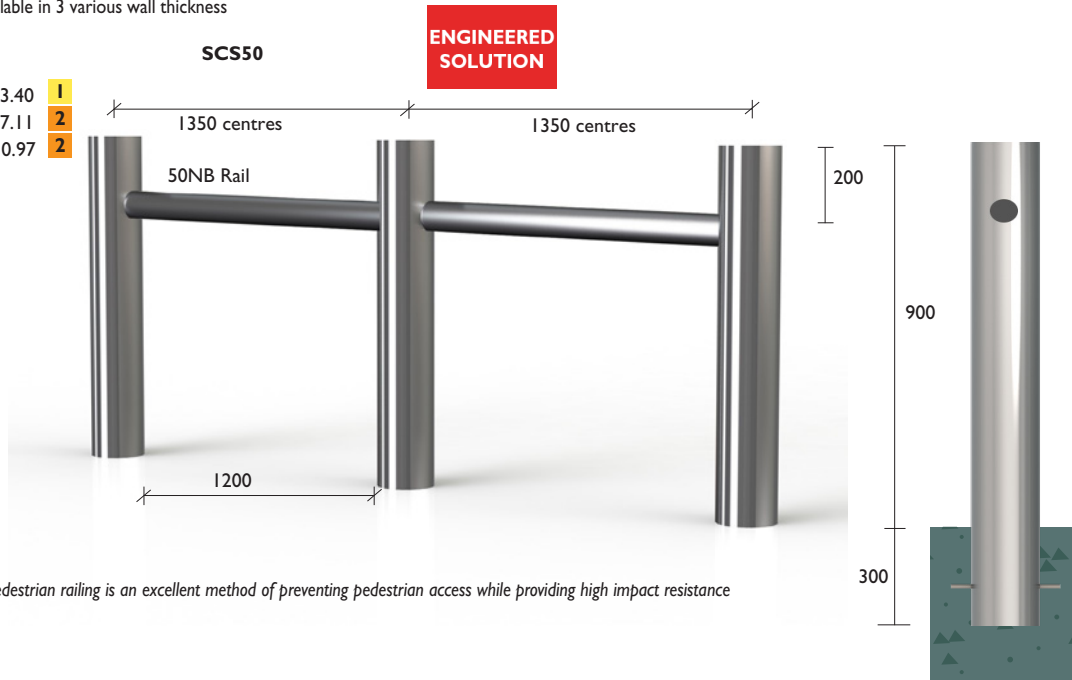

*Pedestrian railing is an excellent method of preventing pedestrian access while providing high impact resistance*

## Pedestrian Railing

**Material** 125NB (141.3) x 3.4/7.11/10.97mm Grade 304 stainless steel pipe  
 Rail 40NB (48.26) x 3.4 Grade 304 stainless steel pipe  
**Finish** Linished or electro-polished

Bollards available in 3 various wall thickness

- Fixed In situ**
- SSP125FA 3.40 **1**
  - SSP125FB 7.11 **2**
  - SSP125FC 10.97 **2**

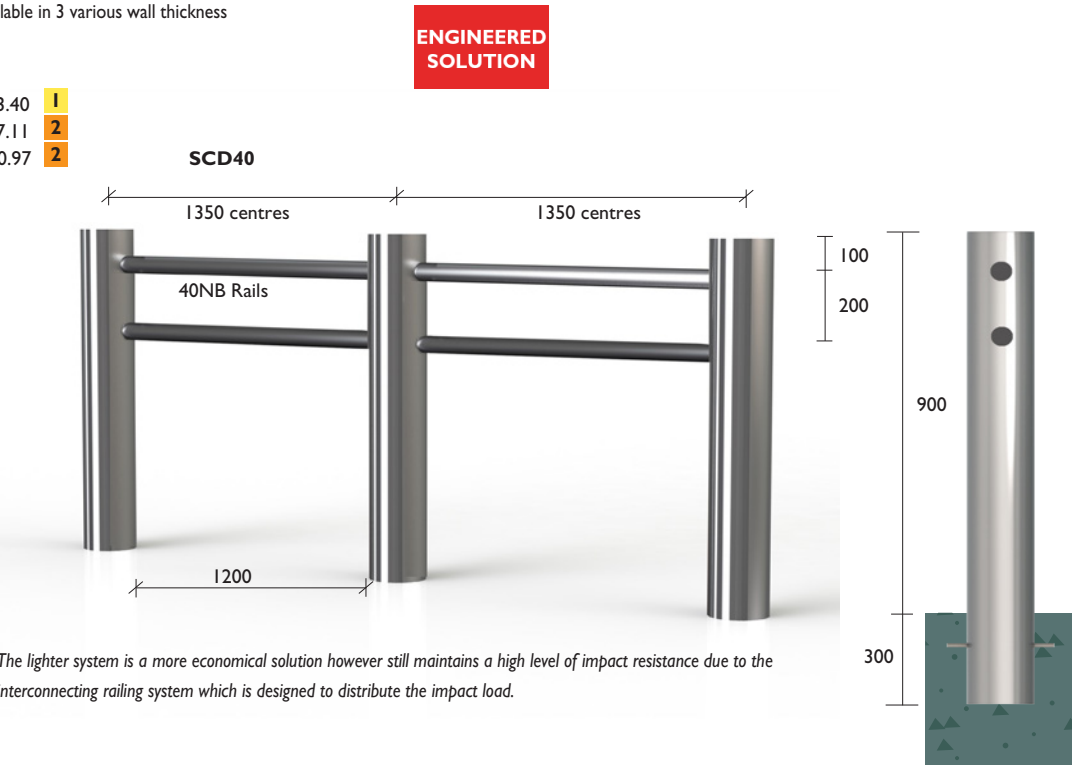

*The lighter system is a more economical solution however still maintains a high level of impact resistance due to the interconnecting railing system which is designed to distribute the impact load.*

1300 780 450

**Sign Board Frame**

**Material** 150NB (168.3) x 3.4/7.11/10.97 grade 304 stainless steel  
**Finish** Linished or electropolished

This frame is available in three wall thickness pipe providing various levels of impact resistance and security

- Fixed Insitu**
- SBR815F A 3.40 **1**
  - SBR815F B 7.11 **2**
  - SBR815F C 10.97 **2**

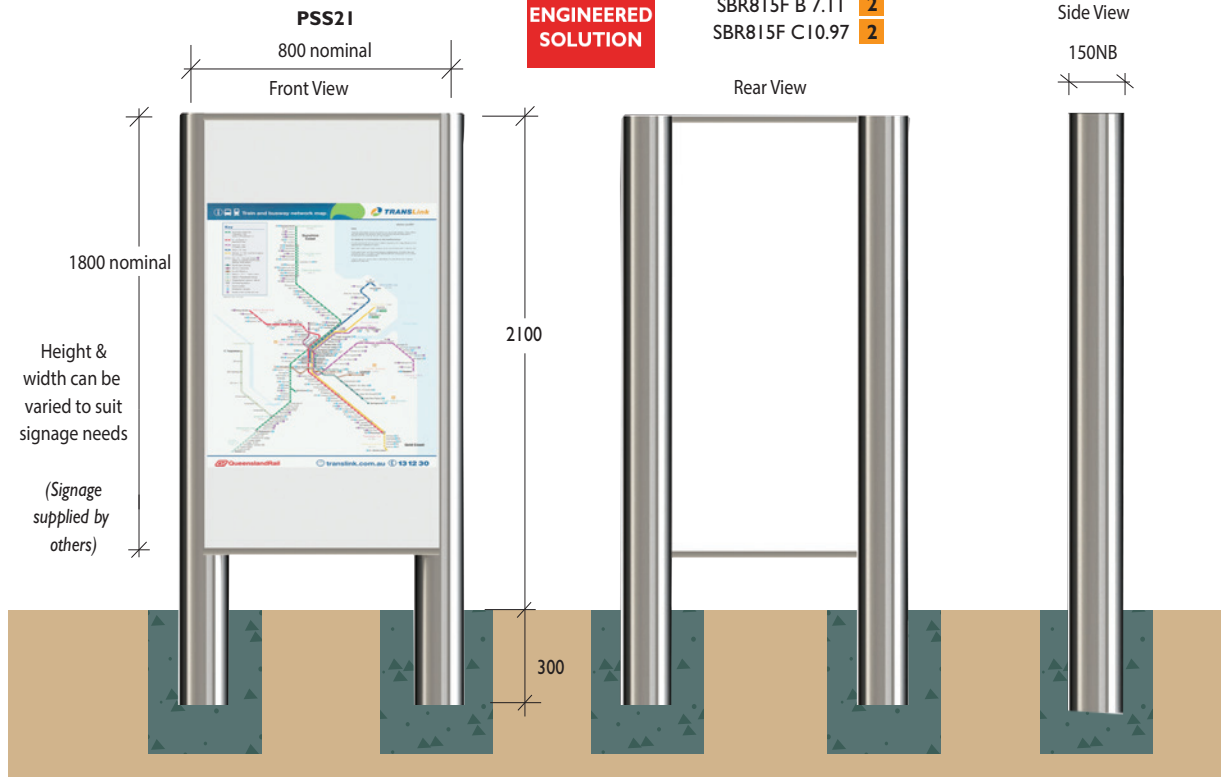

**Square Frame**

**Material** 150(152.4) x 100(101.6) x 3.0mm grade 304 stainless steel RHS  
**Finish** Linished or electropolished

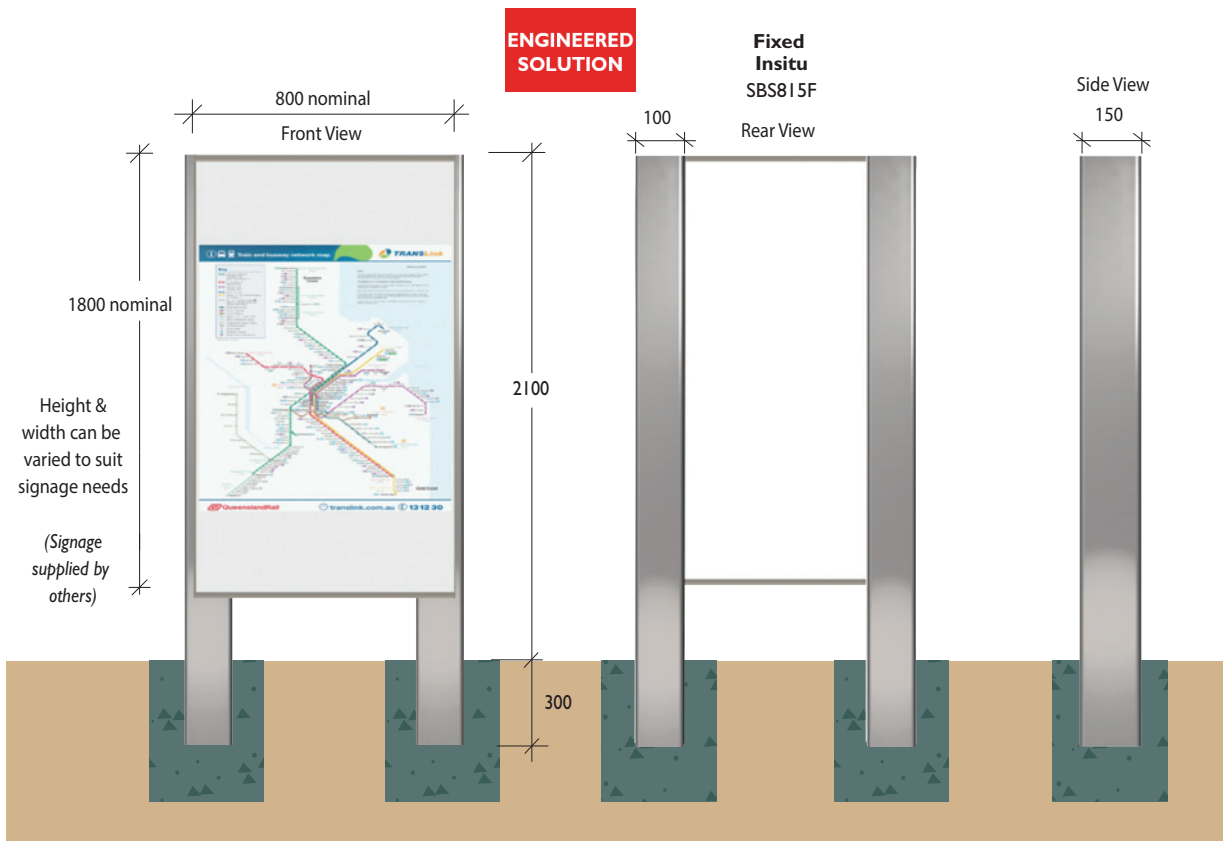



# Protecting Public Spaces > PAS68 Certified

Product Range

1300 780 450

## Seating RG-SE-9999

**Material** Reinforced precast concrete strengthened by RhinoGuard technology/Arm rests - Ferrocast polyurethane  
Standard unit 2 end sections and 1 center section

### Performance

Vehicle: Fully-laden 7.5 tonne two axle rigid N2 lorry  
Vehicle Speed: 40mph (64km/h)

### Test Results

The vehicle was completely immobilised, eliminating the chance of a second attack

**PAS68  
TESTED**



\*Standard unit pictured

### PAS68 classification code

Test1 - Centre: PAS68V/7500(N2)/64/90:3.7/0.0

Test2 - Off Centre: V/7500(N2)/64/90:3.5/0.0



**This modular seating system offers unique style combined with functionality and high impact resistance**

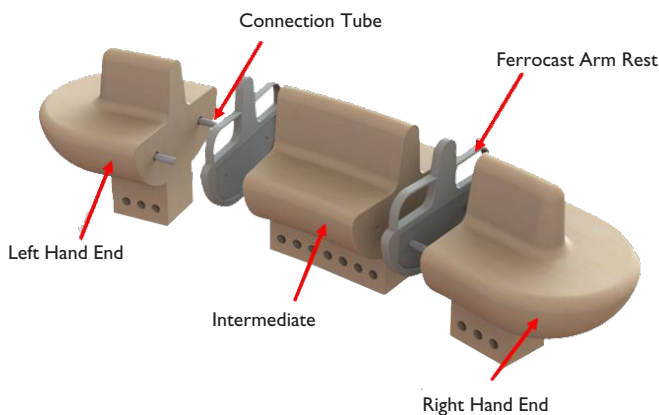

### Dimensions & Weight:

- Centre Section Span - 1102mm
- Left/Right Section Span - 1037mm
- Seating Section - 474mm
- Ferrocast Arm Section Weight - 21.5 Kg
- Cast End Section Weight - 1000 Kg
- Cast Intermediate Section Weight - 1200 Kg

Protecting Public Spaces > PAS68/IWA14-1 Certified

Seating

RG-SE-00001

**Material** Ferrocast and timber  
**Finish** Available in wide selection of RAL colours

**Performance**

Fully laden 7.5 tonne two axle rigid N2 lorry  
 Vehicle Speed: 30mph (48km/h)

**Test Results**

The vehicle was completely immobilised, eliminating the chance of a second attack

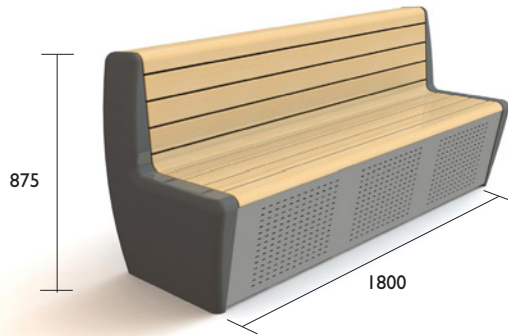

**PAS68 classification code**

Test 1: Front facing (centre): PAS68:2010:V/7500(N2)/48/90:0.0/0.0

Test 2: Back facing (centre): V/7500(N2)/48/90:3.1/0.0

Test 3: Back facing (Off centre):V/7500 (N2)/48/90:2.7/0.0

Seating

RG-SE-00002

**Material** Precast concrete and timber  
**Finish** Available in Silver Grey, Mid Grey / Saxon Buff finish  
**Weight** 2500kg

**Performance**

7.2 tonne N2A lorry  
 Vehicle Speed: 40mph (64km/h)

**Test Results**

The vehicle was completely immobilised, eliminating the chance of a second attack

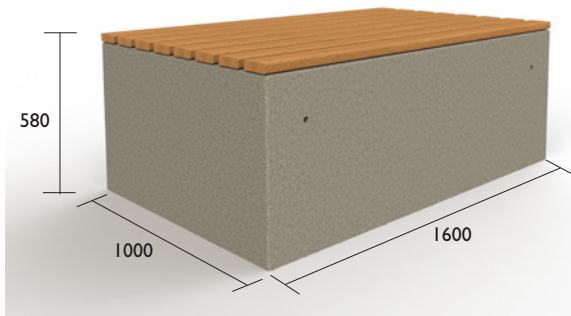

**IWA14-1:2013 Classification Code**

Blok V/7200[N2A]/64/90:19.3

**Available finishes:**

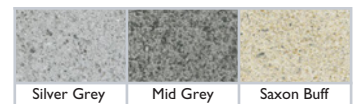

**Planter**  
RG-PL-00002

**Material** Mix of concrete & fine Italian marble  
**Finish** Polished smooth surface treated with a protective varnish

This is an ideal alternative to the more traditional methods of hostile vehicle mitigation providing high level of impact resistance at the same time introducing planting to urban spaces.



Excavation depth: 950mm

Test Results: The vehicle was completely immobilised, eliminating the chance of a second attack



Available finishes:

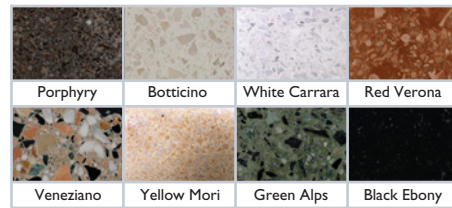

**Test1 (frame)**

Vehicle: Fully laden 7.5 tonne two axle rigid N2 lorry  
Vehicle Speed: 40mph (64km/h)  
PAS68 classification code: PAS68: 2010: V17500(N2)/64190:0.0/0.0

**Test2 (frame)**

Vehicle: Unladen 7.5 tonne two axle rigid N3 lorry (empty 18 tonner)  
Vehicle Speed: 50mph (80km/h)  
PAS68 classification code: PAS68: 2010: V17500(N3)/80190:1.7/0.0

**Test3 (frame with Giove planter)**

Vehicle: Unladen 7.5 tonne two axle rigid N3 lorry (empty 18 tonner)  
Vehicle Speed: 50mph (80km/h)  
PAS68 classification code: PAS68: 2010: V17500(N3)/80190:3.8/35.5

**Planter**  
RG-PL-00003

**Material** Steel upright with timber panels  
**Finish** Powder coated in a range of colors

Features a sleek, geometric design providing high level of impact resistance at the same time introducing planting to urban spaces.



Excavation depth: 950mm

Test Results: The vehicle was completely immobilised, eliminating the chance of a second attack



**Test1 (frame)**

Vehicle: Fully laden 7.5 tonne two axle rigid N2 lorry  
Vehicle Speed: 40mph (64km/h)  
PAS68 classification code: V17500(N2)/64190:0.0/0.0

**Test2 (frame)**

Vehicle: Unladen 7.5 tonne two axle rigid N3 lorry (empty 18 tonner)  
Vehicle Speed: 50mph (80km/h)  
PAS68 classification code: V17500(N3)/80190:1.7/0.0



## Protecting Public Spaces > PAS68 Certified

### Bike Stand

RG-BS-99999

**Size** Ø140mm/Ø204mm stand sleeve  
**Finish** 316 bead blasted stainless steel body/machine finished  
316 grade stainless steel top cap

**Core and Diameter Options:**

Diameter: 140mm cycle stand sleeve  
Core: RhinoGuard PAS68 15/30 core (protection against 1.5 tonne vehicle at 30mph)

Diameter: 204mm cycle stand sleeve  
Core: RhinoGuard PAS68 25/40 core (protection against 2.5 tonne vehicle at 40mph)

Diameter: 204mm cycle stand sleeve  
Core: RhinoGuard 75/40 core (protection against 7.5tonne vehicle at 40mph)

**PAS68  
TESTED**



**Please note:**  
Due to the highly specialised components required for this item,  
lead times may be longer than anticipated.  
Please contact our nearest Sales office for more information.

### Litter Bin

RG-LB-99999

**Size** Ø140mm/Ø204mm bin diameter  
**Finish** 316 bead blasted stainless steel body/machine finished  
316 grade stainless steel top cap

**Core and Diameter Options:**

Diameter: 204mm bin  
Core: RhinoGuard PAS68 15/30 core (protection against 1.5 tonne vehicle at 30mph)

Diameter: 204mm bin  
Core: RhinoGuard PAS68 25/40 core (protection against 2.5 tonne vehicle at 40mph)

Core: RhinoGuard 75/40 core (protection against 7.5tonne vehicle at 40mph)

**PAS68  
TESTED**



**Please note:**  
Due to the highly specialised components required for this item,  
lead times may be longer than anticipated.  
Please contact our nearest Sales office for more information.

# SECURACCESS

LEDA HAS A RANGE OF OTHER HIGH SECURITY PRODUCTS



Crash Tested Miti Gate



Defender Boom Gate



The Surface Guard

Need product advice, information or further technical resources ?

Call Leda now on  
**1300 780 450**  
(business hours)

## Other Leda Publications



Bicycle Parking & Security Handbook



Architectural & Security Bollards Handbook



Modular Track & Cantilever Gates Brochure

Copyright © Leda Security Products Pty Ltd 2017.

Product specifications displayed in this Handbook are accurate at time of printing.

Improvements and additions are continually being made to the product range.

Check with your nearest Leda Sales office that the designs and specifications displayed are still current.

Comprehensive brochures and technical literature on the complete range of Leda's High Security Products are available on request or visit the website: [www.ledasecurity.com.au](http://www.ledasecurity.com.au).

# SecurAccess



Leda Security Products Pty Ltd  
ABN 23 067 258 235

 1300 780 450

[ledasecurity.com.au](http://ledasecurity.com.au)

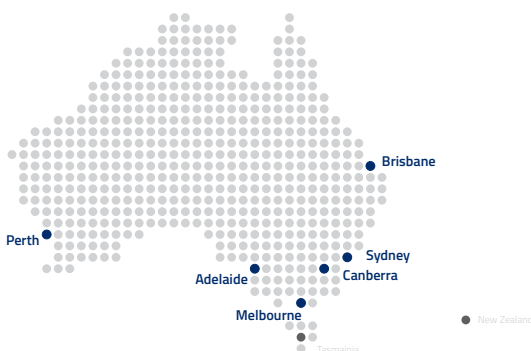

## Head Office & Manufacturing

NSW - Tuggerah  
18 Reliance Drive,  
Tuggerah NSW 2259  
PO Box 5196  
Chittaway Bay 2261  
Tel: (02) 8413 3430  
Fax: (02) 4353 2255

## SALES BRANCHES

Email: [sales@ledasecurity.com.au](mailto:sales@ledasecurity.com.au)

### New South Wales

8 Ferris Street  
North Parramatta  
NSW 2151  
Tel: (02) 8413 3410

### Queensland

3/3375 Pacific Highway  
Slacks Creek  
QLD 4127  
Tel: (07) 3613 8270

### Victoria

67 Calarco Drive  
Derrimut  
VIC 3030  
Tel: (03) 8399 8150

### South Australia

19 Taminga Street  
Regency Park  
SA 5010  
Tel: (08) 8374 3266

### Western Australia

14 Kenhelm Street  
Balcatta  
WA 6021  
Tel: (08) 9406 3650

*Australasian distributors and resellers in Northern Territory, Tasmania and New Zealand.*

**Distributed by**

Leda Security is now part of

