

# Aluminum Exterior Products Lineup and Information

## Aluminum Exterior Products Series Catalog

Perfect for parking space and entertaining areas  
Architecturally designed for style and function

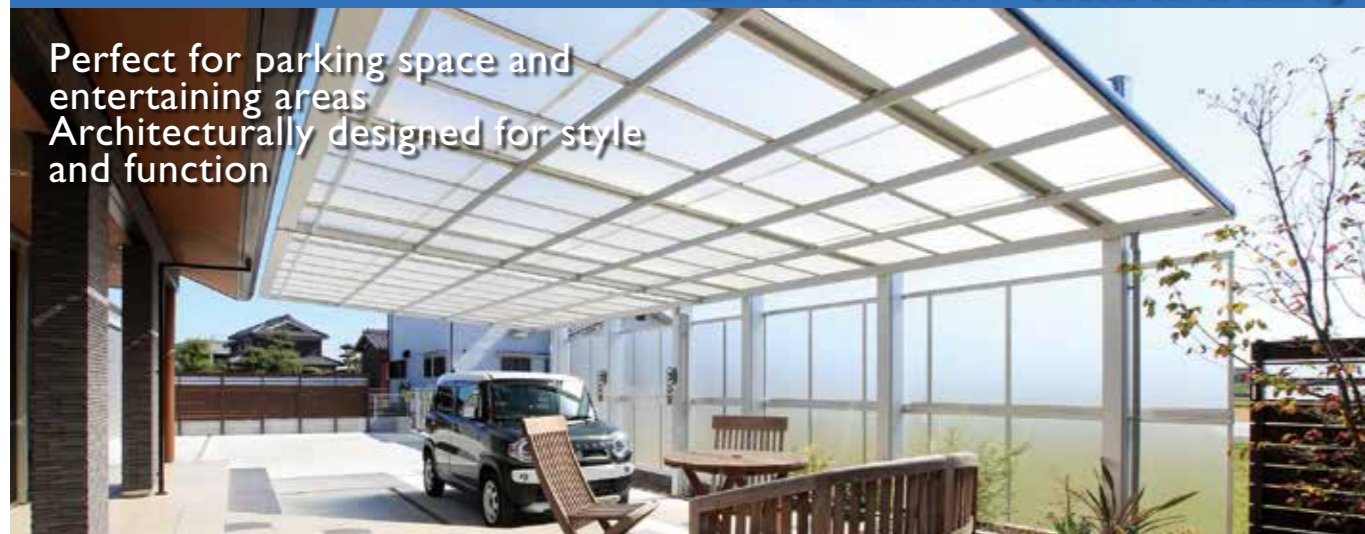

### Carport



### Terrace & Patio Covers



### Entry Gate & Tall Gate



### Boundary Fence and Tall Fence



### Non-Caster Accordion Gates

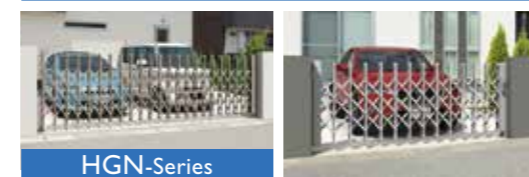

#### Manufacturer:

**Sankyo Tateyama, Inc.**  
SankyoAlumi-Company  
Exterior Division Home Material Department  
Address: 70 Hayakawa, Takaoka, Toyama 933-8610, Japan  
Homepage: <http://www.exteriorworld.jp/english/>



#### General sales agency:

**TOYO Boeki Co., Ltd.**  
Address : 5-3-7 Fukushima, Fukushima-ku,  
Osaka 553-0003, Japan  
Tel : +81-6-6452-3839  
Fax : +81-6-6452-3827  
E-mail : [sales@toyoboeki.co.jp](mailto:sales@toyoboeki.co.jp)  
Homepage: <http://www.toyoboeki.co.jp>  
<http://www.carport-japan.jp>



Catalog No.  
**STX1639A**  
X.22.04-050

Printed in Japan

# SankyoTateyama

## Entry Gate & Boundary Fence Series Catalog



Made in Japan





# Installation examples







# INDEX

Entry Gate & Boundary Fence  
**MCE-Series / CEF-Series**

▶ P.5

Boundary Fence  
**SHR-Series**

▶ P.9

Entry Gate / Tall Gate  
**WM-Series**

▶ P.11

Aluminum Hybrid Structure  
**AGT-Series**

▶ P.15

Public & Privacy Screen  
**RFL-Series**

▶ P.17

Sliding Gate  
**NLB-Series**

▶ P.18

Non-Caster Accordion Gates  
**HGN-Series**

▶ P.18





## Design Variations

### Lattice Picket Style



### Solid Panel Style



### Louver Style / with Airflow



### Frosted Panel Style



## Size Variations

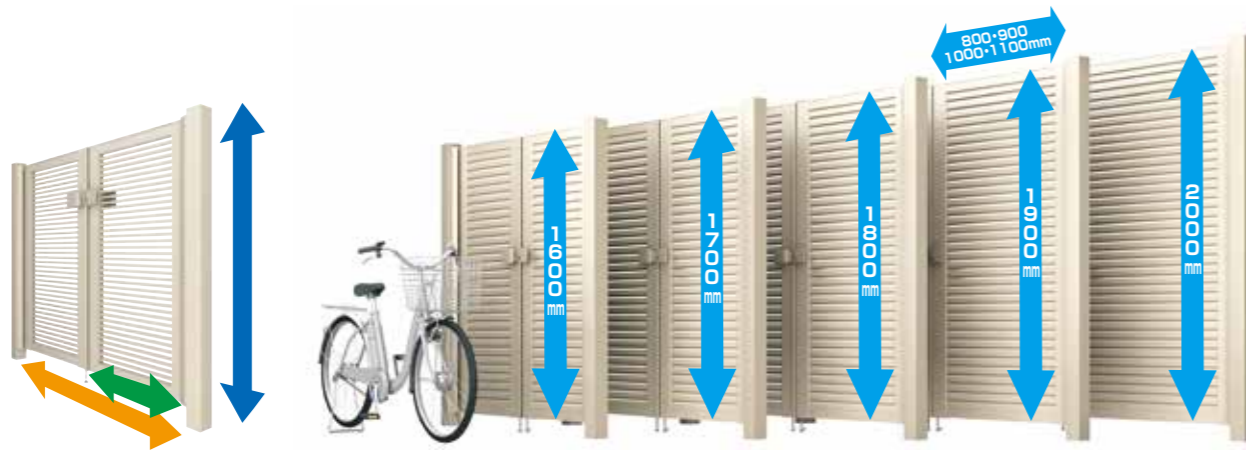

Regular Height : H10 / H12 / H14  
Wide [Single] : W60 / W70 / W80 / W90 / W100

Tall Type : H16 / H17 / H18 / H19 / H20  
Wide [Single] : W80 / W90 / W100 / W110

## COLOR



### Touch Handle

MJNT-CT (Thumb-turn)  
MJNT-CC (Dimple Key)



### Touch Bar Handle

MJNG-CT (Thumb-turn)



### Latch Lever Handle

MJN-CT (Thumb-turn)



## High-Quality Detail



New Lever Handle



Lock-Gap Hider



Lock-Down Stick

## Design Variations

### Lattice Picket Style



### Solid Panel Style



### Louver Style / with Airflow

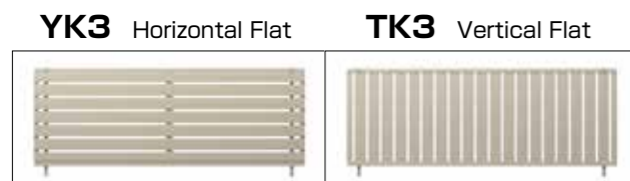

### Frosted Panel Style

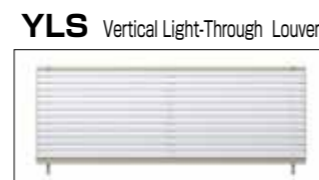

## Size Variations and Line-Up

Regular post spacing is 2000mm.



## COLOR



## Panel Design (front & back)



Clean Design

Profile Detail

## Combining Panels

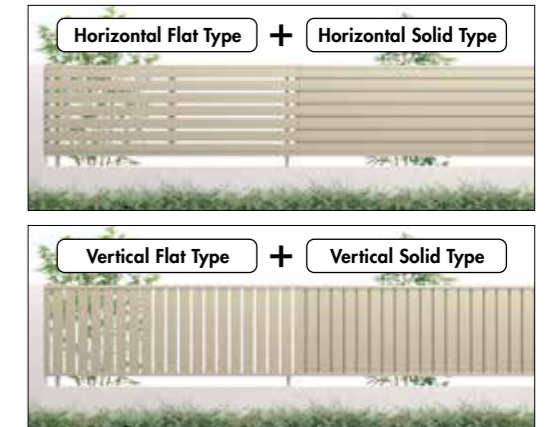

## Options for space below (YL2)

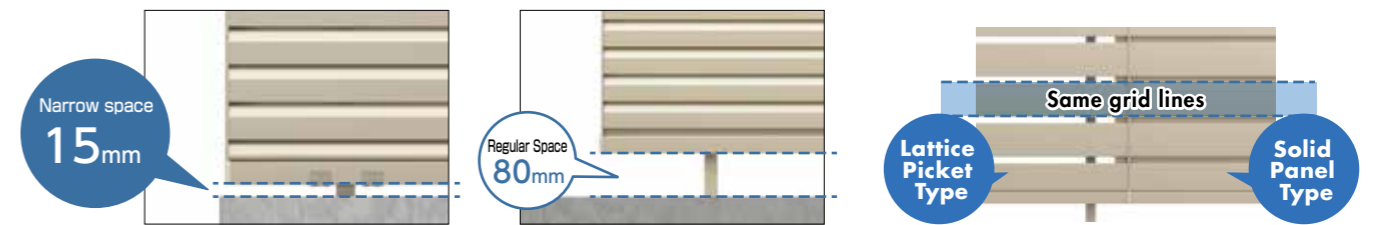

## Tall Fence

Many combinations of fence panel heights are available. Maximum height is 2936mm (9.6ft).

2UP Free Behind Post (60mm)

3UP Free Behind Post (75mm)

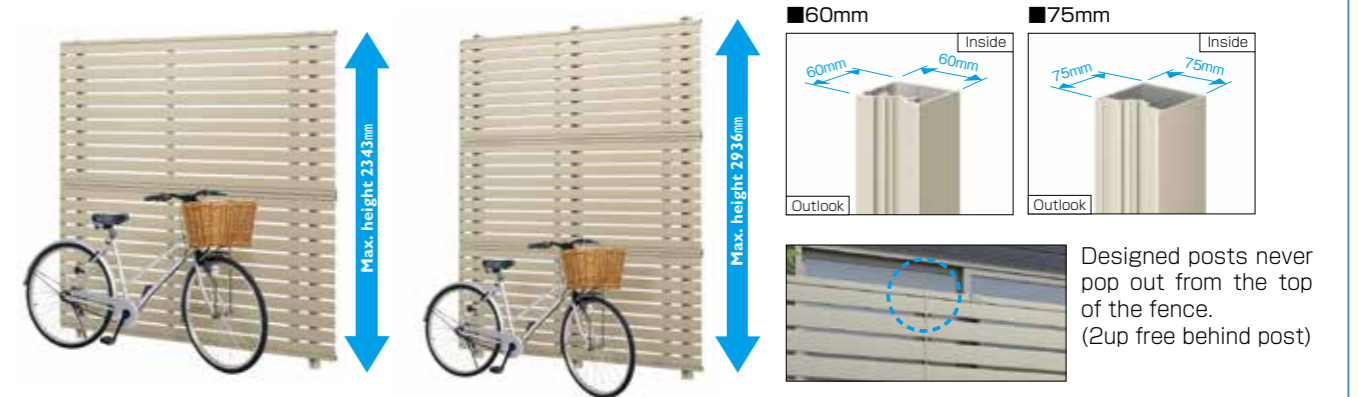

### Basic Combination Size (mm)

	H06 H06	H08 H06	H08 H08	H10 H08	H10 H10	H12 H10	H12 H12	H10 H08	H10 H08	H10 H10	Lower rail gap 80mm
Height	1123	1323	1523	1723	1923	2123	2323	2444	2644	2844	





## Panel Design



The horizontal flat can be selected from one-sided or two-sided wooden lattice.

## COLOR

Laminate Type									
TP Trad Pine	UC Urban Gray	JC Orange Cherry	UC Urban Gray	TP Trad Pine	KC Black	JC Orange Cherry	KC Black	JN Smoke Nut	KC Black
TPU	JCU	TPK	JCK	JNK					

## Design Variations



## Wind Resistance

Wind resistance is improved by reducing posts spacing to less than 1000mm.

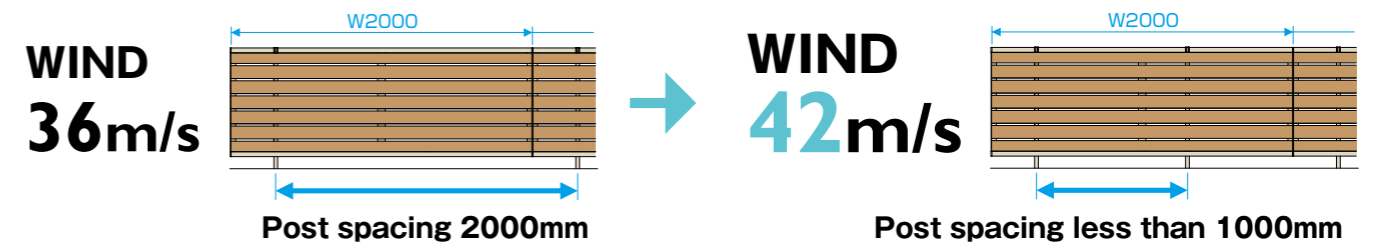

## Size Variations and Line-Up







Y1/TPC/0712 Double Gate

We offer various designs and a wide variety of wood-laminate colors.



Touch Handle	Touch Bar Handle	Latch Handle
<ul style="list-style-type: none"> <li>●LWT-01 (Thumb-turn)</li> <li>●LWT-02 (Dimple Key)</li> </ul>	<ul style="list-style-type: none"> <li>●LWT-B01 (Thumb-turn)</li> <li>●LWT-B02 (Dimple Key)</li> </ul>	<ul style="list-style-type: none"> <li>●LWU-01 (Thumb-turn)</li> </ul>

## COLOR

Laminate Type								Aluminum Only Type	
TP Trad Pine	SLC Sun Silver	JC Orange Cherry	SLC Sun Silver	TP Trad Pine	UC Urban Gray	JC Orange Cherry	UC Urban Gray	UC Urban Gray	BD Dark Bronze
TPL	JCL	TPU	JCU						
TP Trad Pine	BD Dark Bronze	HG Bitter Grain	KC Black	YN Silky Noche	KC Black				
TPC	HGK	YNK							
TP Trad Pine	JC Orange Cherry	YN Silky Noche							

\*The standard color changes depending on the panel design. Please contact us for details.

Dimension (mm)

H \ W	700	800	900
1200	○	○	○
1400	○	○	○
1600		○	○

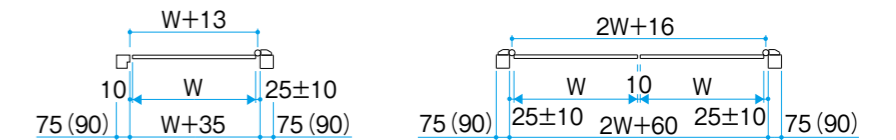

( ) Indicates H=1600mm type.

## Hinge Cover



## Slide Lock Down Stick

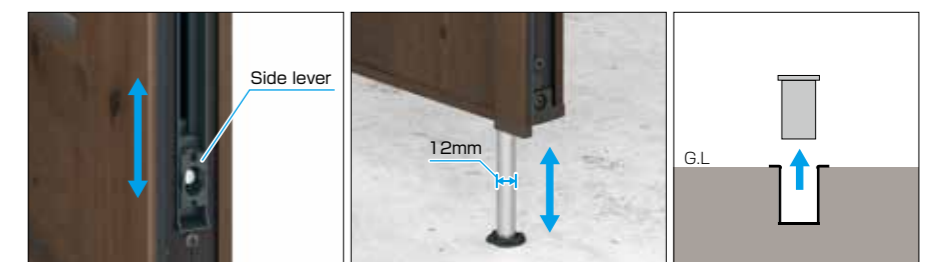





Selectable from Alu-color and Wood-laminate color.



## Wide Variation of Size and Height

Maximum Height is 2m (6.5ft) .  
Maximum Width is 2.2m (7.2ft)  
(for Double Gate)

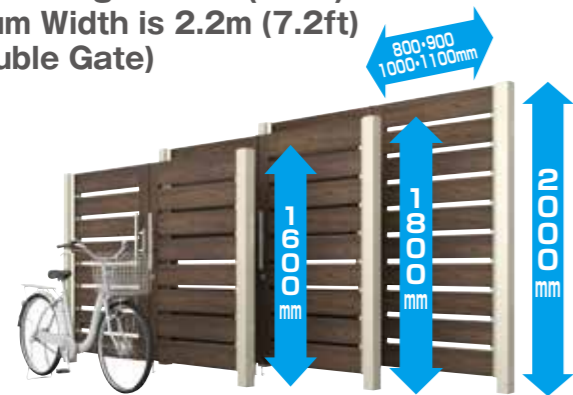

## Upgrade Option : LED Hinge Hider



## COLOR

Laminate Type				Aluminum Type	
TP Trad Pine	SLC Sun Silver	TP Trad Pine	UC Urban Gray	UC Urban Gray	BD Dark Bronze
TPL		TPU			
JC Orange Cherry	UC Urban Gray	TP Trad Pine	BD Dark Bronze		
JCU		TPC			

## Lock-gap hider

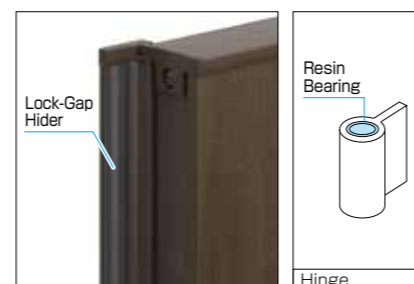

## Dimensions (mm)

H \ W	800	900	1000	1100
1600	○	○	○	○
1800	○	○	○	○
2000	○	○	○	○

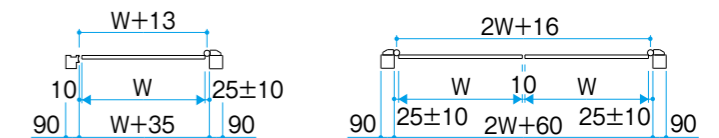

## Hinge Cover



The hinge metal cover inside the gate was attached to refine the design.

## Slide Lock Down Stick

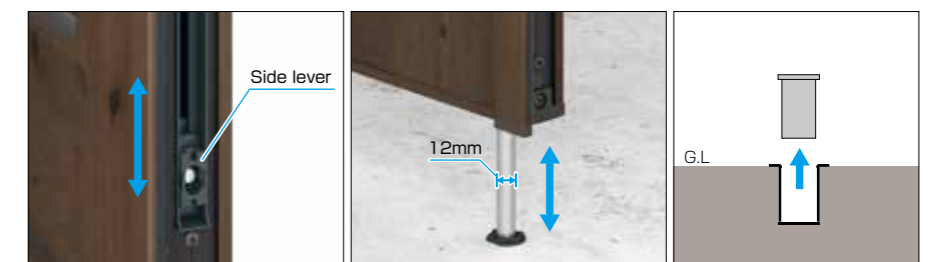





## 3 Design Option

AGT-1



AGT-2

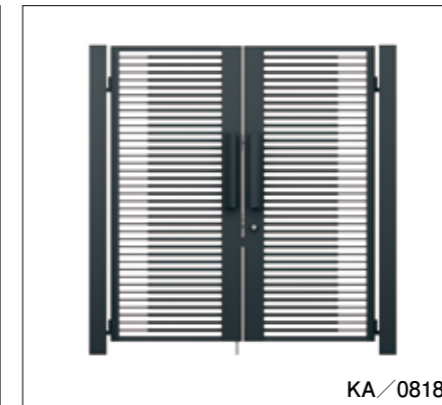

AGT-3

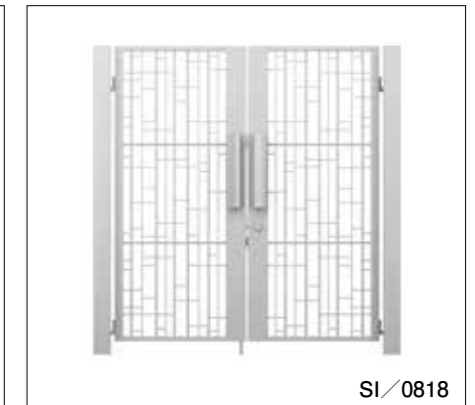

## COLOR

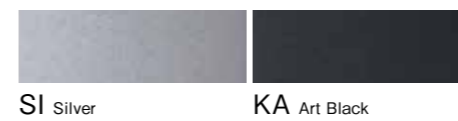

## Dimension (mm)

H \ W	800	900
1600	○	○
1800	○	○
2000	○	○

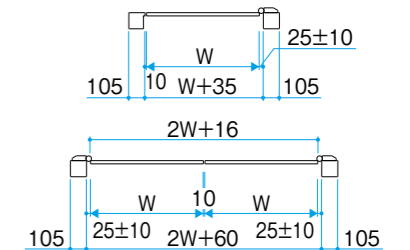

## Combination of Cast Aluminum Panels and Aluminum Profile Frames

### Aluminum Gate Framings with Cast-Aluminum panel combination structure.

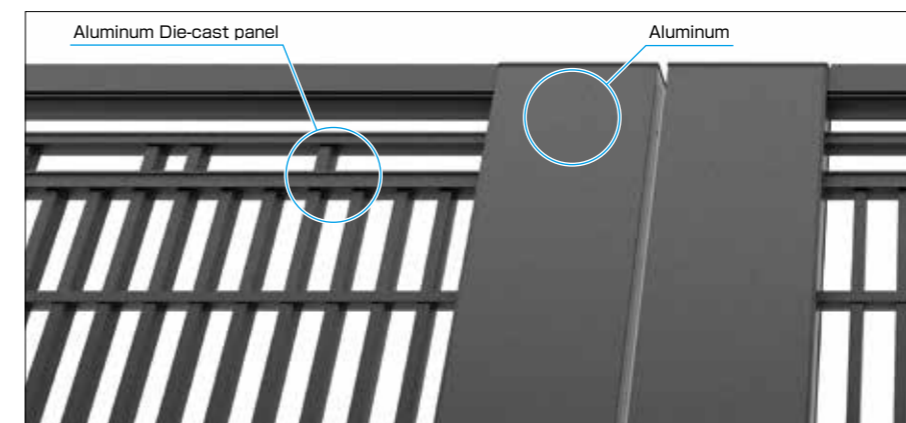

Special Treatment of the paint on gate frame.

## Long Plate Handle

● PL-01



## Bar Handle

● BH-01U



## Long Bar Handle

● LBH-01





# RFL Series Public & Privacy Screen



## Design type

### Vertical Picket Type

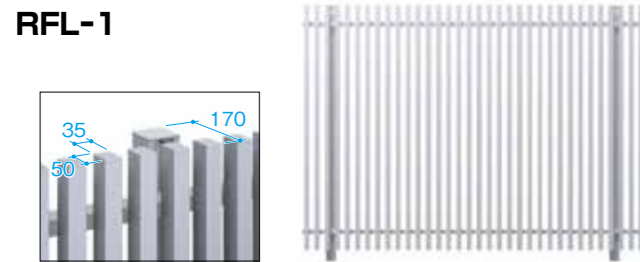

### Vertical Thin Picket Type

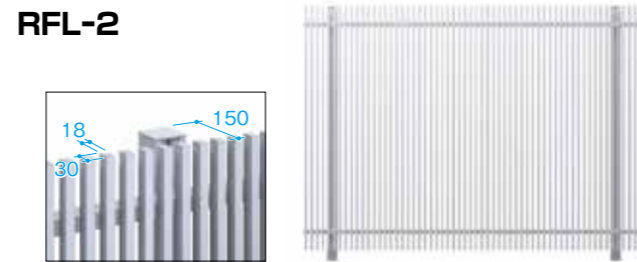

## 3 different heights

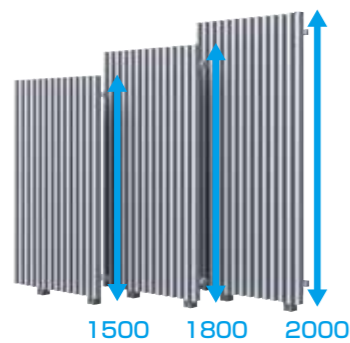

Wind Resistance **1160N/m<sup>2</sup>** Vo=34m/s

## Flexibility for variations in temperature

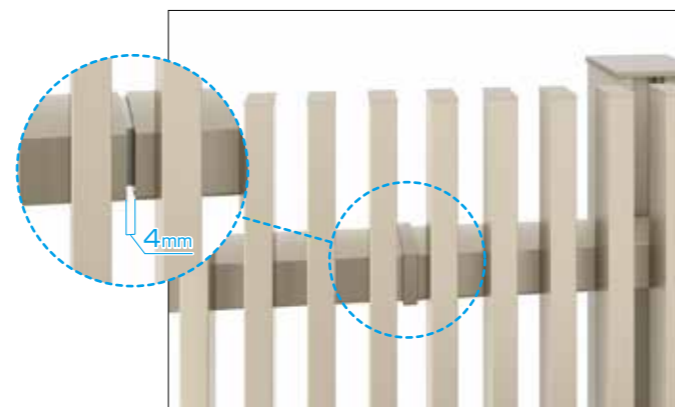

# NLB Series Sliding Gate

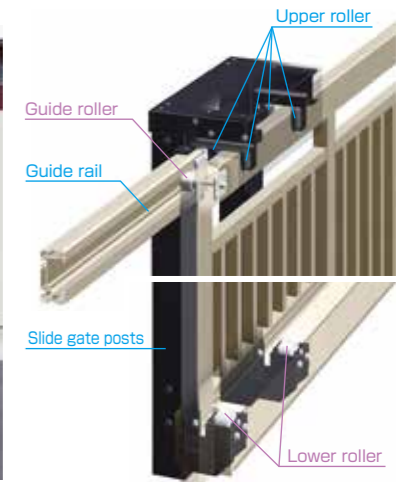

## Double-sided Cylinder Lock



## Lock-Down Stick & Wheel



## Meet point



# HGN Series Non-Caster Accordion Gates



## COLOR

Aluminum Type			
SLC Sun Silver	UC Urban Gray	BD Dark Bronze	
Wood-laminate Option			
TPU Trad Pine	UC Urban Gray	JCU Orange Cherry	UC Urban Gray

## Size Variation

