

# GM AUTO



ProCharger Intercooled Supercharger Systems for

**CAMARO/FIREBIRD  
GTO/SS/G8/LSx/LT1/LT4**





**INVENTED, ENGINEERED**



**AND MADE IN THE USA**





# GM AUTO

## C O N T E N T S

<b>Proven Power</b> .....	4
<b>GM Automotive Supercharger Systems*</b>	
2018 - 2016 Camaro SS (LT1) .....	8
2018 - 2017 Camaro ZL1 (LT4) .....	11
2015 - 2010 Camaro SS (LS3/L99) .....	12
2015 - 2010 Camaro SS Cog Race (LS3/L99) .....	14
2015 - 2014 Camaro Z28 (LS7) .....	15
2018 - 1985 Corvette .....	16
2017 - 2014 Chevy SS (LS3) .....	18
2009 - 2008 Pontiac G8 GT (L76) .....	19
2006 - 2004 Pontiac GTO (LS1/LS2) .....	20
2002 - 1998 Camaro and Firebird (LS1) .....	22
1997 - 1993 Camaro and Firebird (LT1) .....	24
1992 - 1988 Camaro and Firebird (L98) .....	25
LT1/LT4 Transplant .....	26
LSx Transplant .....	27
Small and Big Block Chevy .....	28
<b>Additional Applications</b> .....	29
<b>Thermal Advantage</b> .....	30
<b>Intercooling Leadership</b> .....	32
<b>Centrifugal Innovation</b> .....	36
<b>P-1X/D-1X Superchargers</b> .....	40
<b>Race Systems</b>	
Bypass Valves .....	41
Racing Domination .....	44
F-Series .....	46
<b>Building the Power</b> .....	50
<b>Word on the Street</b> .....	54
<b>Powerful History</b> .....	56

\*See Corvette, Carbureted Chevy and Truck/SUV catalogs for additional GM applications

# PROVEN POWER

LARGEST POWER GAINS AND COOLEST CHARGE AIR TEMPERATURES

**“ProCharger Has The Kit To Satisfy Your Horsepower Lust.”** *—Super Chevy*

## Proven ProCharger Supercharger Systems

ProCharger was the first to safely and reliably supercharge and intercool a wide range of GM performance cars, and for 25 years has been producing the largest reliable power gains. With a unique ability to offer cutting edge technology and features, along with the peace of mind associated with cooler charge air temperatures and outstanding engine reliability, ProCharger has you covered. From the dyno to the street and on the track, ProCharger’s engineering and R&D teams go to great lengths to ensure your supercharged and intercooled vehicle is everything you expect and more.

## The Ultimate GM Power Adder®

Powerful, purposeful and individualized—hallmarks of so many GM cars and ProCharger’s industry leading intercooled supercharger systems. During the past 25 years, many independent tests have documented improvements of more than 200 horsepower and two seconds in 1/4-mile performance on a variety of otherwise stock cars. From stock to purpose-built racing machines, once you’ve experienced the incredible, real-world power of a ProCharger, you’ll agree that ProCharger is the Ultimate Power Adder®.

## Cooler Charge Air Temperatures

ProCharger pioneered the use of air-to-air intercooling and self-contained, gear-driven supercharger oiling among other innovations. ProCharger intercooler and supercharger technology continues to deliver substantial thermal advantages relative to competing products, which in turn produces the coolest charge air temperatures and largest street-legal power gains. Relentless innovation delivers consistent, real-world power advantages for countless ProCharger-equipped Chevy and Pontiac owners.

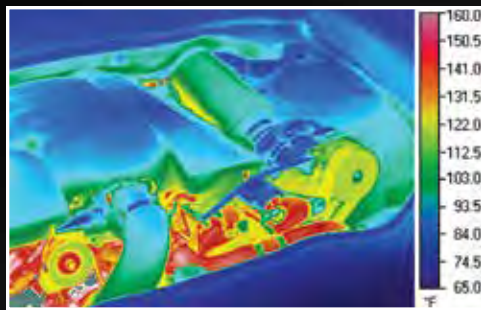

*Underhood thermal image shown above. See pages 30-31 for additional information and thermal images.*

## Powerful, Efficient and Reliable

A ProCharger Intercooled Supercharger System can add 50 to 80 percent additional horsepower to your performance vehicle with no additional engine modifications, special fuels or extended cool-down times. Mild to wild, regardless of your horsepower goals and aspirations, ProCharger can help you reach them.

## Unmatched Quality and Warranty Coverage

For more than 25 years, ProCharger has designed and manufactured its own superchargers and complete systems (unlike some competitors who buy head units and components elsewhere and are really only assembling kits). This helps to ensure that ProCharger delivers a high quality, high performance product designed specifically for your needs. In-house design and production capabilities allow ProCharger to provide industry-best warranty protection, with a 3 year extended warranty available for supercharger head units.

## Fuel-Mileage Friendly

Beyond overall power and performance, centrifugal forced induction is also the most fuel efficient form of high performance. Rising fuel costs and CAFE restrictions have prompted performance enthusiasts to think about fuel economy along with horsepower. It’s no secret that ProCharger systems not only produce the big power numbers we all crave, but under normal operating conditions, owners report very little effect on fuel mileage and in some cases, actually improved fuel economy.

***Visit [ProCharger.com](http://ProCharger.com) for the latest video, blog updates and additional information***



## **ProCharger: The ULTIMATE Power Adder®**

With power, reliability and quality far superior to other forced-air induction systems, ProCharger Intercooled Supercharger Systems and Tuner Kits are excellent ways to add even more power to your performance vehicle. ProCharger supercharger systems and tuner kits feature a visually appealing "from the factory" look, easy installation and minimal relocation of components. The self-contained supercharger requires no external oil feed or return lines while the front-mounted air-to-air intercooler avoids the complexity and maintenance issues of an air-to-water-to-air intercooler.



# PROVEN RELIABILITY

BOLT ON THE LARGEST, STREET-LEGAL POWER GAINS IN THE INDUSTRY

## Engine-Friendly Boost

With ongoing advancements in fuel injection and electronic engine management systems, intercooled centrifugal supercharging has proven to be the most engine friendly and easily installed type of forced air induction. No internal engine modifications, no special fuels—just incredible power gains from a ProCharger system and the best engine reliability in the industry.

## 100% Complete Systems

ProCharger supercharger systems are 100 percent complete—nothing else to purchase. Our intercooled supercharger systems come with all the components needed for an attractive, OEM-quality installation. Install it yourself or have your ProCharger dealer install it for you. The choice is yours.

## ProCharger System Advantages and Choices

ProCharger offers more supercharger, drive system, intercooler, bypass valve and fuel system choices and upgrades than anyone. In addition to options that improve the performance of your vehicle, ProCharger and your ProCharger dealer are the ultimate solution for virtually any GM engine combination. When it comes to supercharger systems for your car, truck, SUV, V-twin motorcycle, UTV or boat, no one meets your needs better than ProCharger.

## OEM Appearance and Quality

When it comes to the finished installation, ProCharger systems feature an outstanding “from the factory” look. ProCharger also utilizes state of the art quality assurance equipment, and all precision assembly and testing is performed in-house. A clean, professional and neatly integrated finished installation means this is a supercharger system that you will be proud to show off every chance you get.

## Resources, Experience and Service Excellence

All ProCharger supercharger systems are engineered in-house and then field-tested by a dedicated team of engineers and technicians on the largest R&D fleet of vehicles in the industry. ProCharger systems are tested and evaluated extensively; on the engine dyno, chassis dyno, on the street and at the track. This diligence results in the most advanced, engine-safe and durable supercharger systems on the market. Combined with world-class engineering, manufacturing, technical and customer service teams, along with unmatched power, performance and reliability—not to mention a 25 year history of record-setting performance—the choice is clear: ProCharger.

**INVENTED, ENGINEERED**



**AND MADE IN THE USA**

## Best Dealer Network

ProCharger has an extensive network of independent dealers across North America and around the world that specialize in installing and fine-tuning the supercharger system on your vehicle; and just like the supercharger systems they install, ProCharger dealers are the best in the business when it comes to helping you realize your performance goals and aspirations.

## Easy to Own—Easy to Drive

With millions of boost-enhanced miles under their tires, ProCharged vehicle owners enjoy the best of both worlds: every-day reliability and driveability with incredible power that is just a toe-tip away. In fact, ProCharger systems and kits are designed to be installed on completely stock or modified GM engines. And thanks to no major modifications, your car can be returned to stock condition if desired.



**"The ProCharger system is designed to provide maximum reliable power gains."**

*—GM High Tech Performance*





# LT1 CAMARO SS

2018–2016

## The Best Performance with the Least Modifications



HO Intercooled System with P-1SC-1, optional black finish shown

**BOLT ON 150+ MORE HORSEPOWER**

*“For those yearning to escalate their horsepower game, ProCharger may have just the answer with it’s recently debuted kit for the sixth-gen Camaro SS. Boasting gains of 150-plus horsepower in out of the box trim, these new systems also allow owners to build horsepower from in the 600-plus range to more than double that [with supercharger and intercooler upgrade options]” –LSXTV*

### The 6th Generation is Here

Without a doubt, ProCharger has become the dominant leader in LT1 and LT4 forced induction. In fact, the 6 fastest 6th Gen Camaros and 13 out of the top 17 fastest C7’s run ProCharger. Whether your Camaro SS is completely stock or already modified, ProCharger has supercharger systems and options to fit your goals from 650 to 1,200 HP.

With only 7 psi on pump gas you can enjoy a gain of 150+ HP with our HO Intercooled System and 170+ HP with our Stage II Intercooled System, thanks to our P-1SC-1 head unit. Complete systems come with proven tuning calibrations and a handheld programmer, simplifying DIY installs. Higher boost levels and HP are possible (up to 50%+) with an Intercooled Tuner Kit and custom tuning, and even higher with modified motors. For custom racing builds, F-Series superchargers up to the record-setting F-1A-94 can be installed on Stage II Intercooled Systems without the need for trimming or new brackets. With the Competition Race Tuner Kit and Air-to-Water intercooler, even larger head units are available up to the F-1R.

### Easy Install and 100% Reversible

The HO System was designed to be compatible with both stock or modified vehicles, with robust billet brackets for maximum strength and integrity. No removal of OEM parts is needed with the bracket installation—this speeds up the install and ensures that all factory braking, cooling, and oiling systems on the car work as GM intended. This system was also designed to be the easiest Camaro install we have ever offered and you can change the pulley and 8-rib belt without removing the bracket or supercharger.





Stage II Intercooler with 756 cu-in core and Race bypass valve

ProCharger is proud to offer the first CNC billet aluminum intake manifold upgrade for LT1 and LT4 equipped Camaros and Corvettes—1000+ HP capable

## Dedicated to Reliability

Using a robust billet bracket system with a dedicated belt drive and patented crank pulley design, we are able to secure a 7.65" drive pulley onto the factory harmonic balancer. The ProCharger crank pulley works by using a system of "cam-locks" to securely grip the factory balancer, taking the load off the crank bolt ensuring years of service without worry. ProCharger also offers an even larger, 8.25" crank pulley upgrade with the addition of an aftermarket balancer.

Combining these crank pulleys and our robust ProCharger tensioner near the supercharger pulley, results in maximum belt wrap and transfer of power even at higher boost levels with Tuner Kits and modified vehicles. ProCharger's tensioner is unique in that it is spring loaded and also allows the customer to add pre-load adjustment to the belt. This tensioner has already been proven to support 1300+HP in similar applications when used with dedicated 8-rib belts so handling the factory 7 psi is no stress at all.

## Intercooler Systems

GM spent a great deal of time on the airflow design of this new Camaro SS, from the new front fascia to the three front mounted radiators. With this in mind, ProCharger offers four different intercoolers for the 2018-16 Camaro's horsepower and cooling needs depending on the level of your build: the 3-Core, Stage II, Air-to-Air Race, and Air-to-Water Intercoolers. Starting with a fresh core design, the cross flow section of the intercooler cores were increased in size to eliminate pressure drop as much as possible while still retaining cooling capacity.

The HO or Stage II intercooler options do not require any cooling system hardware to be removed and these supercharger kits will come with one piece of preformed-silicone charge tubing from the intercooler to throttle body. This helps create the best airflow possible and the added insulation of silicone helps to cool the air charge inside the tubing around the Camaro's hot radiators.



## ProCharger 2018-16 Camaro SS Systems and Tuner Kits

- HO Intercooled System and Tuner Kit
- Stage II Intercooled System and Tuner Kit
- Competition Race Tuner Kit with F-1D, F-1 or F-1A
- Competition Race Tuner Kit with F-1A-94, F-1C or F-1R

## ProCharger 2018-16 Camaro SS Choices and Upgrades

- Satin, Polished, or Black supercharger and bracket finish
- 10 rib belt pulley upgrade (maximum power transfer) for LT1 and LT4 engines
- Helical Gearset for noise reduction (P-1SC-1, P-1X, D-1SC, and D-1X)
- Air-to-Air Intercooler upgrade (from Stage II intercooler)
- HO System and Tuner Kit allows for P-1SC-1 up to F-1A-94 head units
- Race Bypass Valve upgrade available
- 8.25" Crank Pulley upgrade



# LT1 CAMARO SS

2018–2016 WITH FACTORY AIRBOX



*HO Intercooled System, with factory airbox*



**BOLT ON 150+ MORE HORSEPOWER**

## **ProCharger HO Systems with Factory Airbox**

One of our easier-to-install ProCharger systems, this HO ProCharger System retains the factory airbox allowing you to maintain that factory look while still delivering big, reliable horsepower gains. This system uses our proven and durable P-1SC-1 supercharger, compact yet powerful while still providing years of trouble free use. The P-1SC-1 is powered up by the Camaro OEM 6 rib belt drive pulley system and utilizes the existing belt tensioner making simplicity and routine belt maintenance a breeze. See table below for available option upgrades.

## **Intercooler System**

This HO system features our HO intercooler but with an expanded plenum for additional performance. This HO system design provides cool charge air temperatures and provides large horsepower gains while still allowing space for the factory airbox. Additional SPAL fans and a sheet metal fan shroud are included to ensure proper cooling and performance that you come to expect from a ProCharger product.

## **Industry Leadership**

ProCharger is the undisputed leader for 6th Gen Camaro high performance, for both street legal applications and hardcore racing. This new ProCharger system not only features a stealth look, but also addresses some emissions requirements by retaining the factory airbox.

## **ProCharger 2018-16 Camaro SS Systems and Tuner Kits**

- HO Intercooled System and Tuner Kit with factory airbox

## **ProCharger Camaro Choices and Upgrades**

- Satin, Polished, or Black supercharger and bracket finish
- Helical Gearset for noise reduction (P-1SC-1, P-1X, D-1SC, and D-1X)
- HO System and Tuner Kit allows for P-1SC-1 up to D-1X head units



# ZL1 CAMARO

2018–2017



*Stage II Intercooled Kit with D-1SC Supercharger, Black Finish.*



**BOLT ON 110+ MORE HORSEPOWER**

What happens when you replace the factory roots blower on a 2018-17 ZL1 Camaro? Magic—in the form of a 110+ HP gain on an otherwise stock ZL1 running pump gas, and the ability to easily turn it up to substantially higher power levels.

GM laid the foundation for big power with the ZL1 Camaro engine's forged internals, relatively low compression, and factory-supercharger system. Thanks to the inherent efficiency of centrifugal boost combined with the optimized packaging afforded by a large front mounted air-to-air intercooler, together with a new sheet metal intake manifold, with a larger ProCharger head unit, upwards of 1,000+ HP is within reach. In fact, ProCharged ZL1 Camaros have been dominating both street and strip, holding records for quickest and fastest 1/8, 1/4 and 1/2 mile.

ProCharger's ZL1 kit replaces the ZL1's LT4 factory roots-style supercharger with a direct-replacement sheet metal intake manifold designed to optimize the air flow and power potential, but still comfortably fit under the factory hood. ProCharger intercooled kits for ZL1 Camaros continue to lead the industry in OEM-level fit and finish, ease of installation, and reliable performance, all with multiple finish and performance options to suit your needs. It's really no wonder that ProCharger delivers the most horsepower per pound of boost.

## ProCharger Camaro ZL1 Systems and Tuner Kits

- Stage II Intercooled System and Tuner Kit
- Intercooled Race Tuner Kit with F-1D, F-1 or F-1A
- Intercooled Race Tuner Kit with F-1A-94, F-1C or F-1R
- Competition Race Tuner Kit with F-1D, F-1 or F-1A
- Competition Race Tuner Kit with F-1A-94, F-1C or F-1R

## ProCharger Camaro ZL1 Choices and Upgrades

- Satin, Polished, or Black supercharger and bracket finish
- 10 rib belt pulley upgrade (maximum power transfer) for LT1 and LT4 engines
- Helical Gearset for noise reduction (P-1SC-1, P-1X, D-1SC, and D-1X)
- ATI Performance Products balancer upgrade
- Air-to-Air Race Intercooler (Stage II Systems and kits only)
- Air-to-Water Race Intercooler (Stage II Tuner kits only)
- Tuner Kit allows for P-1SC-1 up to F-1A-94 head units
- Race Bypass Valve upgrade available
- 8.25" Crank Pulley upgrade



# LS3/L99 CAMARO SS

2015–2010

*Intercooled Stage II System, polished finished option shown*



**BOLT ON 215 MORE HORSEPOWER**

*“At the end of the [chassis dyno] pulls, we saw a gain of 187 HP and 158 lb-ft to the rear wheels [of an otherwise stock LS3 Camaro] with just 7.5 pounds of boost!” –Chevy High Performance*

Owners of otherwise stock 2015-10 Camaros will enjoy industry leading power, thanks to the high-flowing, durable and extremely efficient ProCharger P-1SC-1 supercharger and large air-to-air intercooler. ProCharger’s design also features easy installation, an 8-rib dedicated drive, and all the components needed for a 100% complete, OEM-quality installation.

ProCharged Camaro owners can expect horsepower gains of 180 to 215+ HP with 7-7.5 psi of intercooled boost on otherwise stock engines running on high-quality 91 octane pump gas.

### **More Power Per Psi of Boost**

With ProCharger’s patented, proven and industry-leading technology, ProCharger produces the least heat and most power per pound of boost. Owners can add 200+ horsepower on otherwise stock LS3 Camaros and 180+ horsepower to an otherwise stock L99s, dependent upon altitude and other factors. Higher boost and power levels are available with custom tuning, and for modified LS-based engines.

### **High Flow Air Inlet System**

The ProCharger design also features the highest flowing air inlet system by providing the most efficient air path into the supercharger, adding to the overall efficiency and power output of the complete system or tuner kit.





## OEM Appearance

ProCharger systems for the new Camaro feature an awesome “from the factory” look and come with a standard 3-year warranty on the intercooler and 1-year warranty on the supercharger (Optional 3-year supercharger warranty is available).

## ProCharger HO and Stage II Systems

Both the HO Intercooled and Stage II Intercooled systems for 2010-15 Camaros utilize the P-1SC-1 ProCharger, a dedicated 8-rib supercharger drive system, a highly-effective, air-to-air intercooler, OEM-quality mounting brackets, eight larger fuel injectors, a handheld programmer and all necessary supercharger and intercooler tubes for installation onto Camaros with no major modifications to your car or engine. Stage II systems supply a larger intercooler and air filter, as well as a fuel pump booster. Systems are 100% complete and require no additional hardware. Bolt on 50-55% more power with Stage II systems producing 7.5 psi and HO systems running 7 psi.

## ProCharger Camaro SS Tuner Kits

In addition to complete systems, ProCharger offers two Intercooled Tuner Kits for the new Camaro SS models: an HO Intercooled Tuner Kit and a Stage II Intercooled Tuner Kit. With reliability, quality and power far superior to other forced-air induction systems, a ProCharger Tuner Kit is an excellent way to add even more power to modified and custom tuned Camaros. Tuner kits require additional components (fuel system upgrade) and custom tuning by a qualified dealer. Building a modified or stroked LS engine for your Camaro? An intercooled ProCharger supports the highest boost and power levels in the industry. Give ProCharger or your local ProCharger dealer a call to learn more.



*625 HP LS3, Intercooled Stage II System shown*

## ProCharger 2015-10 Camaro SS Systems and Tuner Kits

- HO Intercooled System and Tuner Kit
- Stage II Intercooled System and Tuner Kit (larger race intercooler, air filter)

## ProCharger 2015-10 Camaro SS Choices and Upgrades

- Polished supercharger and bracket finish
- Helical Gearset for Noise Reduction (P-1SC-1, P-1X, D-1SC, and D-1X)
- Tuner Kits allow for P-1SC-1 up to F-1R head units
- 12-Rib Supercharger Drive (requires aftermarket crankshaft damper; ATI Performance Products balancer upgrade)
- Cog Race Kit and F-Series Superchargers



# LS3/L99 CAMARO SS

## 2015–2010 COG RACE KITS

*Camaro SS Cog Race Kit with F-1R, standard satin finish shown*



**SUPPORTS UP TO 1,400 HP**

*“Taking the top spot on our list is David Brooks and Late Model Racecraft, with a killer 427 cubic-inch, F-1R blown 2010 Camaro. Not only is this the fastest 2010 in the country, it is also the first in the 9’s, which is quite an accomplishment. On the dyno, this car made 914-rwhp through an automatic, which also puts it on top of the highest horsepower list.”*

*“Of course, it sounds a bit strange when you’re talking about a 2010 Camaro with just 8.0 miles on the odometer that already sports a 1,000+HP, LXR-headed, 427-cubic-inch Warhawk powerplant blown by a ProCharger F-1C.” –GM High Tech Performance*



### **Race and Championship Winning ProCharger Technology for Modified 2015-10 Camaro SS**

Ready to build your new Camaro SS into a dedicated, Mustang-eating race car? An intercooled ProCharger Cog Race Kit is the ultimate power adder for modified and fully “race built” LS-based engine builds. As a matter of fact, the very first 2010 Camaro SS to run in the 9’s was equipped with a ProCharger supercharger.

### **Leading the Way Once Again**

Realizing the performance potential of modified LS-engines, ProCharger led the way with a Cog Race Kit designed specifically for the 2015-2010 Camaro SS. Utilizing a dedicated, 50 mm-wide cog drive and tensioner system, the heavy-duty bracket provides a solid, stable mounting location for a wide range of ProCharger models, including the F-1 through F-1X self-contained superchargers. The available 1,300 HP/1,800 HP/2,500+ HP rated intercooler options help to provide the industry’s coolest charge air temperatures and largest horsepower gains.

### **Legendary ProCharger F-Series Superchargers**

Recognized throughout the industry for its legendary power and durability, an F-1R ProCharger is capable of supporting 1,225 HP while the newer F-1X supports up to 1,400 HP. Intercooled Cog Race Kits include intercooler tubing as well as a Race Bypass Valve and are intended for installation onto modified engines built for off-road/competition use. The Cog Race Kit requires the purchase of an aftermarket crankshaft damper.

### **ProCharger 2015-10 Camaro SS Cog Race Kits**

- Cog Race Kit with F-1D/F-1/F-1A or F-1A-94/F-1C/F-1R
- Intercooled Cog Race Kit with F-1D/F-1/F-1A or F-1A-94/F-1C/F-1R
- Cog Race Kit or Intercooled Cog Race Kit with F-1X
- Air-to-Air Intercooler options available for up to 1,300 HP
- Air-to-Water Intercooler options available for up to 2,500+ HP



# LS7 CAMARO Z/28

## 2015-2014



*Stage II Intercooled System with P-1SC-1, optional black finish shown*



**BOLT ON 120+ MORE HP**

### The Ultimate Street Car

By combining a race-proven LS7 7.0L power plant with the most advanced suspension and brake system ever bolted onto a Camaro body, this new Camaro Z/28 might just be the ultimate street car.

### ProCharger Stage II Systems

The ProCharger Stage II Intercooled Supercharger System for the 2015-14 Camaro Z/28 features the P-1SC-1 head unit with self-contained oiling and an 8 rib dedicated belt drive system. This combination creates 6.5 psi of boost pressure to the highly effective air-to-air intercooler, producing 120+ more horsepower over the stock LS7, with the coolest charge air temperatures in the industry.

With no permanent modifications needed to your vehicle, this system is 100% reversible back to stock. Systems include injectors and a handheld programmer, with power levels around 625+ HP with only 6.5 psi of boost with premium pump gas and conservative tuning.

For those wanting even more power, the Race intercooler can be outfitted with slight modification, resulting in another 20+ HP at the same boost level. That means 645+ HP on pump gas and the preloaded tune! Higher boost levels with custom tuning can result in even more power. With the ProCharger Race Intercooler outfitted and your choice of a D-1SC upgrade up to the 10.5" volute F-1X, the sky is the limit with blower options capable of 1,300+ HP!

### ProCharger Camaro Z/28 Systems and Tuner Kits

- Stage II Intercooled System with P-1SC-1 supercharger (dedicated 8-rib drive)
- Stage II Intercooled Tuner Kit with P-1SC-1 supercharger (dedicated 8-rib drive)

### ProCharger Camaro Z/28 Choices and Upgrades

- Satin, Polished, or Black Supercharger and Bracket Finish
- Helical Gearset for Noise Reduction (P-1SC-1, P-1X, D-1SC, and D-1X)
- Tuner Kits allow for P-1SC-1 up to F-1X head units
- Sheet Metal 3 Core Race Intercooler Upgrade, Race Bypass Valve Upgrade



# CORVETTE

2018–1985



**LT4 C7 Z06**

**GREATER EFFICIENCY  
= MORE POWER!**

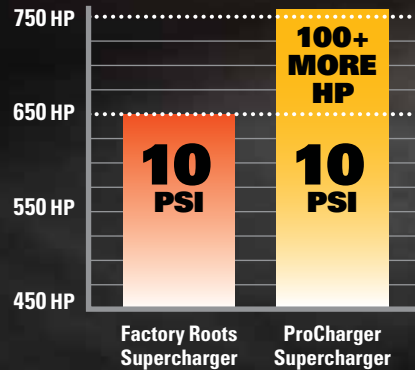

*For more info, visit [ProCharger.com](http://ProCharger.com)  
or call (913) 338-2886 for a complete  
Corvette catalog!*



**LT1 C7**

## From the Factory Performance

Regardless of the model or generation of Corvette you own, a ProCharger Intercooled Supercharger System can add 40 to 75% more power to your car with no additional engine modifications and OEM-quality fit and finish.

## 2015-18 C7 Corvette Z06 (LT4)

GM laid the foundation for big power with the C7 Z06 LT4 engine's forged internals, relatively low compression, and factory-supercharger system. Now with the addition of a ProCharger supercharger you can bolt-on an extra 115+ HP over stock with an intercooled D-1SC head unit at the 10 psi factory boost level and pump gas, with no permanent modifications to the vehicle (see chart at the left). At 13 psi, 825 HP is at your fingertips. Thanks to the super-efficient boost and power created by the ProCharger centrifugal design, with a larger head unit you can achieve upwards of 1,600 HP!

## 2014-18 C7 Corvette Stingray (LT1)

Our C7 Corvette Stingray HO Intercooled Systems with P-1SC-1 are supplied with proven tuning calibrations and handheld programmer set for a 40% power gain over stock, on 7 psi of boost and pump gas. Power gains of 45-50% on stock motors are possible with an Intercooled Tuner Kit and custom tuning, and even higher gains with modified motors. For hyper-custom racing builds, F-Series supercharger models up to the 10.5" volute F-2 can be installed without the need for additional brackets.





### 2005-13 C6 Corvette (LS2/LS3/LS7)

The ProCharger Intercooled Supercharger Systems for LS2, LS3 and LS7 Corvettes offers OEM appearance, fit and finish, and delivers industry leading performance and durability. These systems produce 40% to 50%+ HP gain at the factory boost level, and higher boost and power levels are available for modified engines. The front fascia design on the C6 Corvette allows for the use of a single, center-mounted, air-to-air intercooler system. When coupled with the high-flowing, durable and extremely efficient ProCharger, the intercooler substantially improves overall performance and engine reliability.

### 1997-04 C5 Corvette (LS1/LS6)

An outstanding performance package from the factory, LS1 and LS6 Corvettes are even better with the addition of a powerful and proven ProCharger supercharger system. ProCharger introduced a complete supercharger system for C5 Corvettes a full two years before others. The HO System set the standard and has now evolved into the industry leading Stage II Intercooled System. Sharing much of its design with the LS6 system, including the industry-standard P-1SC-1 ProCharger, highly effective Twin Highflow intercooler system with a high-flow air inlet design, the ProCharger LS1 and LS6 systems truly represent the pinnacle of incredible power gains that you can enjoy day after day.

### 1985-96 C4 Corvette (LT1/LT4/L98)

ProCharger HO Intercooled Supercharger Systems allow C4 Corvette owners to reap the benefits of bolting on 55-60% power gains on LT1 engines, and 55-75% on L98 engines, without having to modify their engines. Working as a system, the front-mounted intercooler, high-flow air intake system and ultra-efficient ProCharger supercharger provides safe, reliable and enjoyable horsepower gains while still retaining the C4's stock hood and exterior appearance. ProCharger is also the only company that offers intercooled supercharger systems for C4, C5 and C6 Corvettes.

LS2/LS3/LS7



LS1/LS6



LT1/LT4



L98





# LS3 CHEVY SS

2017-2014



*HO Intercooled System, optional polished finish shown*



**BOLT ON 50% MORE POWER**

The hot new 2017-14 Chevrolet SS just got hotter with a complete HO Intercooled Supercharger System from ProCharger. With reliability, quality and power far superior to other forced-air induction systems, both ProCharger HO Intercooled Systems and Tuner Kits are excellent ways to add even more power to the world-class performance of the Chevy SS sedan.

### **ProCharger HO Systems and Tuner Kits**

The 8-rib dedicated drive system produces a 50% HP gain over stock with 8 psi of intercooled boost and pump gas. HO intercooled Systems are supplied with proven tuning calibrations and a handheld programmer set for a 50% power gain over stock, though higher boost levels and horsepower gains are possible with an Intercooled Tuner Kit and custom tuning even higher with modified motors. This system utilizes the industry leading ProCharger P-1SC-1 supercharger with self-contained oiling, meaning there is no need for external oil lines or oil pan modification.

Designed and manufactured in the USA, utilizing a highly-efficient 2 core air-to-air intercooler and an 8-rib dedicated supercharger drive system with an automatic tensioner, this is the most advanced and reliable supercharger system available for the SS.

Contact your local ProCharger dealer or call the ProCharger Sales Team at (913) 338-2886 for more information.

### **ProCharger Chevrolet SS Systems and Tuner Kits**

- HO Intercooled System with P-1SC-1 supercharger (dedicated 8-rib drive)
- HO Intercooled Tuner Kit with P-1SC-1 supercharger (dedicated 8-rib drive)

### **ProCharger Chevrolet SS Choices and Upgrades**

- Satin, Polished, or Black Supercharger and Bracket Finish
- Helical Gearset for Noise Reduction (P-1SC-1, P-1X, D-1SC, and D-1X)
- Tuner Kits allow for P-1SC-1 up to F-1A-94 head units
- Larger, 3 Core Intercooler
- Race Bypass Valve Upgrade



# L76 PONTIAC G8 GT

2009–2008



*HO Intercooled System, optional polished finish shown.*



## BOLT ON 55% MORE POWER

*"2008 Pontiac G8 GT ProCharger HO Intercooled Supercharger System: Four Doors Of Fury!"*  
*—GM High Tech Performance*

### ProCharger Pontiac G8 GT Systems and Tuner Kits

- HO Intercooled System (dedicated 8-rib drive)
- HO Intercooled Tuner Kit (dedicated 8-rib drive)

History may consider the Pontiac G8 GT as the "right car at the wrong time," but when it comes to adding power to these world-class four-door sedans, ProCharger is The Ultimate Power Adder. Equipped with one of GM's outstanding LS engines, a ProCharger-equipped G8 GT is an ideal combination of four-door practicality along with the tire-shredding and everyday driveability enjoyment that comes with a ProCharger Intercooled Supercharger System.

Running just 7-8 psi of intercooled boost on an otherwise stock engine, the ProCharger HO Intercooled System produces more than 540 HP while running high quality pump gas.

### ProCharger HO Systems and Tuner Kits

Both the HO Intercooled System and Tuner Kit for the G8 utilize the patented and proven self-contained P-1SC-1 ProCharger, as well as a dedicated 8-rib supercharger drive system, an automatic tensioner, a highly-effective air-to-air intercooler, OEM-quality mounting brackets and eight larger fuel injectors. Tuner Kits are identical but omit fuel injectors and will require custom tuning by a qualified dealer.

### Helical Gearset for Noise Reduction

For those G8 owners who want a more stealthy horsepower profile, ProCharger now has an optional helical gearset for reduced supercharger noise. The helical gearset is available on both the P-1SC-1 and D-1SC supercharger models.

### ProCharger Pontiac G8 GT Choices and Upgrades

- Polished supercharger; polished bracket finish
- ProCharger D-1SC supercharger upgrade (Tuner Kit only)
- Helical Gearset for Noise Reduction (P-1SC-1 and D-1SC only)
- 800+ HP Air-to-Air Intercooler System Upgrade



# LS1/LS2 PONTIAC GTO

2006-2004



*H0 Intercooled System, optional polished ProCharger shown*

**BOLT ON 50-55% MORE POWER**

When the GTO was reborn in 2004, Pontiac enthusiasts once again had an LS-powered performance car to make up for the demise of the Firebird in 2002. Equipped with both the LS1 (2004) and LS2 (2005-06) engines, ProCharger once again led the way with air-to-air intercooled supercharger systems and tuner kits for these unique GM performance cars.

## **LS1 GTO**

Utilizing 7 psi of intercooled boost, a ProCharger System for LS1-equipped GTOs produces a 50-55% power gain on otherwise stock engines running high quality pump gas. Built around the ProCharger P-1SC-1 supercharger and a dedicated 8-rib drive, this system comes 100% complete, including the front-mounted air-to-air intercooler, fuel injectors and a hand-held programmer.

## **LS2 GTO**

LS2 powered GTOs also run 7 psi of intercooled boost for 50-55% power gains on otherwise stock engines running high quality pump gas. ProCharger's LS2 systems and tuner kits feature a front-mounted, air-to-air intercooler, P-1SC-1 supercharger and a dedicated 8-rib drive.

*"How about more than 525 flywheel horsepower on tap at the push of the pedal with no bottles to refill? The [intercooled] ProCharger supercharger system incorporates some unique features that separate it from other offerings in the GTO supercharger market." –High Performance Pontiac*





### Helical Gearset for Noise Reduction

For those GTO owners who want a more stealthy horsepower profile, ProCharger offers an optional helical gearset for reduced supercharger noise. The helical gearset is available on both the P-1SC-1 and D-1SC supercharger models.

### OEM Appearance

Once installed, the ProCharger design features an outstanding OEM appearance and retains the trademark GTO coil covers. ProCharger GTO systems come with a standard 3-year warranty on the intercooler and 1-year warranty on the supercharger (Optional 3-year supercharger warranty is available). ProCharger systems for both LS1 and LS2 GTOs come complete with tuning and fuel injectors.

### ProCharger GTO Tuner Kits

In addition to complete systems, ProCharger offers two Intercooled Tuner Kits for each model of GTO: an HO Intercooled Tuner Kit and an Intercooled Serpentine Race Kit. With reliability, quality and power far superior to other forced-air induction systems, a ProCharger Tuner Kit is an excellent way to add even more power to modified and custom tuned LS1 and LS2 GTOs. Tuner kits require additional components (fuel system upgrade) and custom tuning by a qualified dealer.

### ProCharger Intercooled Serpentine Race Kits

Building a modified LS-based engine for your GTO? An intercooled ProCharger Serpentine Race Kit supports the highest boost and power levels in the industry. Utilizing a ProCharger F-1 Series supercharger, these race kits provide an outstanding power adder foundation on which to build your GTO racer and can even be upgraded to include an intercooler capable of handling 1,300 horsepower.

Contact your local ProCharger dealer or call the ProCharger Sales Team at (913) 338-2886 for more information.



### First IRS GTO in the 8's: 8.95 @ 154 mph

*Weighing in at 3,840 lbs, Travis Wester's GTO is powered by a 427 cid, LS7-based engine equipped with a ProCharger F-1R supercharger and air-to-air intercooler. On the chassis dyno, Wester's GTO has put down 1,018 rwhp and 915 ft. lbs. of torque with 20 psi of boost from the ProCharger.*

### ProCharger Pontiac GTO Systems and Tuner Kits

- 2004: HO Intercooled System and Tuner Kit
- 2005-2006: HO Intercooled System and Tuner Kit
- 2004: Intercooled Serpentine Race Kit with F-1 Series supercharger
- 2005-2006: Intercooled Serpentine Race Kit with F-1 Series supercharger

### ProCharger Pontiac GTO Choices and Upgrades

- Polished supercharger finish
- ProCharger D-1SC supercharger upgrade (Tuner Kit only)
- Helical Gearset for Noise Reduction (P-1SC-1 and D-1SC only)
- 800+ HP Air-to-Air Intercooler Upgrade
- 1,300 HP Air-to-Air Race Intercooler Upgrade (minor modifications required)



# LS1 CAMARO AND FIREBIRD

## 2002–1998 CAMARO AND FIREBIRD

*H0 Intercooled System, customer-painted air plenum shown*



### 500+ HORSEPOWER

*"It's been a flawless combination. This is pretty much my daily driver ... [and] it's also been flogged pretty hard at the racetrack, but not even a whimper from the engine. The LS1 engine is force-fed by an Intercooled ProCharger P-1SC-1, which helps the engine produce about 540 horsepower."*

*–ProCharged LS1 Firebird Owner*

### Leading Forced Induction System for LS1 F-Body Cars

The LS1 engine ushered in a new generation of high tech, high performance engines and ProCharger was right there, taking LS performance to another level. With record breaking performance by LS1 F-body customers around the world, ProCharger is the undisputed leader when it comes to forced induction solutions for these outstanding GM performance cars.

### Maximum Performance and Reliability

These are the basic goals that drove the ProCharger engineering team even when these cars were new, and to this day the goals are the same: outstanding performance and everyday driveability with an intercooled ProCharged LS1 Firebird or Camaro.

### Intercooler Systems

Intercooled supercharging is the most advanced, reliable and cost effective method to increase the power and overall performance of your LS1 Camaro or Firebird.

ProCharger's exclusive Twin High Flow Intercooler System provides the coolest charge air temperatures in the industry for outstanding performance and engine longevity. Available in both 3.5" and optional 4.5" thickness, the two intercoolers mount behind the stock front bumper cover and feed the cooled charge air into a single air plenum before it enters the engine. For racing applications, ProCharger offers an optional single 3 core Race Intercooler, capable of supporting 850+ HP.





*Optional polished finish shown*

*Optional 850+ HP Race Intercooler shown*

### **Patented and Proven P-1SC-1 Supercharger**

Both the 100% complete intercooled system and the available Tuner Kit utilize the patented and proven, self-contained ProCharger P-1SC-1 supercharger. This supercharger is capable of supporting up to 825 HP on modified LS engines.

### **Tuner Kit and Serpentine Race Kit**

ProCharger's LS1 Tuner Kit is identical to the system, but omits fuel system upgrades and will require custom tuning by a qualified dealer. Realizing the performance potential of modified LS1 F-bodies, ProCharger also has an intercooled 8-rib serpentine drive race kit available. Please talk with your local ProCharger dealer or call the ProCharger Sales Team at (913) 338-2886 for more LS1 Camaro or Firebird supercharging information.

### **ProCharger LS1 Camaro/Firebird Systems and Tuner Kits**

- 1999-2002: HO Intercooled System with P-1SC-1 (dedicated 6-rib drive)
- 1998-2002: HO Intercooled Tuner Kit with P-1SC-1 (dedicated 6-rib drive)
- 1998-2002: Intercooled Serpentine Race Kit with D-1SC (dedicated 8-rib drive)

### **ProCharger LS1 Camaro/ Firebird Choices and Upgrades**

- Polished supercharger finish
- Polished Air Plenum (roto-mold plastic standard)
- ProCharger D-1SC supercharger upgrade (Tuner Kit only)
- Helical Gearset for Noise Reduction (P-1SC-1 and D-1SC only)
- Larger, 4.5-inch core Twin Highflow Intercooler System
- 850+ HP Air-to-Air Intercooler System Upgrade (Race Kit only, minor mods required)

# LT1 CAMARO AND FIREBIRD

## 1997-1993



**BOLT ON 55-60% MORE POWER**

With the largest horsepower gains available from any aftermarket manufacturer, ProCharger simply dominates the LT1 and L98 performance arena.

### **Bolt On 155+ Horsepower**

Using the same patented and proven technology that revolutionized the performance of LT1/LT4 Corvettes, a properly tuned intercooled ProCharger supercharger system can add more than 155 HP to an otherwise stock LT1 Camaro or Firebird while running high quality pump gas. That's enough power to increase quarter-mile trap speeds by 14 to 17 mph!

### **Twin Highflow Intercooler System**

Intercooled supercharging is absolutely the most sophisticated, reliable and cost-effective method for substantially increasing the horsepower and overall performance of your LT1 Camaro or Firebird. ProCharger's available Twin Highflow Intercooler System provides the coolest charge air temperatures in the industry for outstanding performance and engine longevity. The two intercoolers mount behind the stock front bumper cover and then feed the cooled charge air into a single air plenum before it enters the engine.

### **Modified LT1s**

Running 12 to 20 psi of intercooled boost from a D-1SC supercharger, modified LT1 F-bodies are capable of supporting HP gains of 75-100%!

### **ProCharger LT1 Camaro/Firebird Systems and Tuner Kits**

- HO Intercooled System with P-1SC supercharger (dedicated 8-rib drive)
- Intercooled Serpentine Race Kit with D-1SC supercharger (12-rib drive)
- High Output Tuner Kit with P-1SC supercharger

### **ProCharger LT1 Camaro/Firebird Choices and Upgrades**

- Polished supercharger finish; Polished finish for Air Intake Tract
- ProCharger D-1SC supercharger upgrade
- Helical Gearset for Noise Reduction (P-1SC and D-1SC only)
- Larger, 4.5-inch core Twin Highflow Intercooler System
- F-1/F-1A Supercharger Upgrade (Race Kit only)



# L98 CAMARO AND FIREBIRD

## 1992-1988



**BOLT ON 60-80% MORE POWER**

### Add More Than 130 Horsepower

Owners of L98-equipped Camaros and Firebirds can expect gains of at least 130 HP on otherwise stock engines running high quality pump gas and utilizing 9 psi of intercooled ProCharger boost.

Using the same patented and proven technology that revolutionized the performance of L98 Corvettes, a properly tuned intercooled ProCharger supercharger system is an outstanding and cost-effective way to increase quarter-mile trap speeds by 13 to 20 mph – and knock almost two seconds off your ET – while still maintaining everyday driveability and consistent power delivery. Higher boost levels and even more power are available for modified L98 TPI engines.

### Ultimate Engine Protection

The fundamental solution to maximizing L98 horsepower output is the use of an air-to-air intercooler system. Mounted behind the front bumper, ProCharger's intercooler significantly reduces charge air temperatures for higher boost levels and eliminates the need for ignition retard. The bottom line is cooler air makes more power while eliminating engine-damaging detonation. Owners of ProCharged L98 F-bodies get consistent, repeatable performance without the power fade suffered by non-intercooled power adders as the engine warms up during daily driving and back-to-back runs.

### ProCharger L98 Camaro/Firebird Systems and Tuner Kits

- HO Intercooled System with P-1SC supercharger (dedicated 8-rib drive)
- Stage II Intercooled System with D-1SC supercharger
- Stage II Intercooled System with D-1 supercharger

### ProCharger L98 Camaro/Firebird Choices and Upgrades

- Polished supercharger finish; Polished finish for Air Intake Tract
- ProCharger D-1SC supercharger upgrade
- Helical Gearset for Noise Reduction (P-1SC and D-1SC only)
- Larger, 3 Core Intercooler

# LT1/LT4 TRANSPLANT KITS

## FOR EFI AND CARBURETED ENGINES

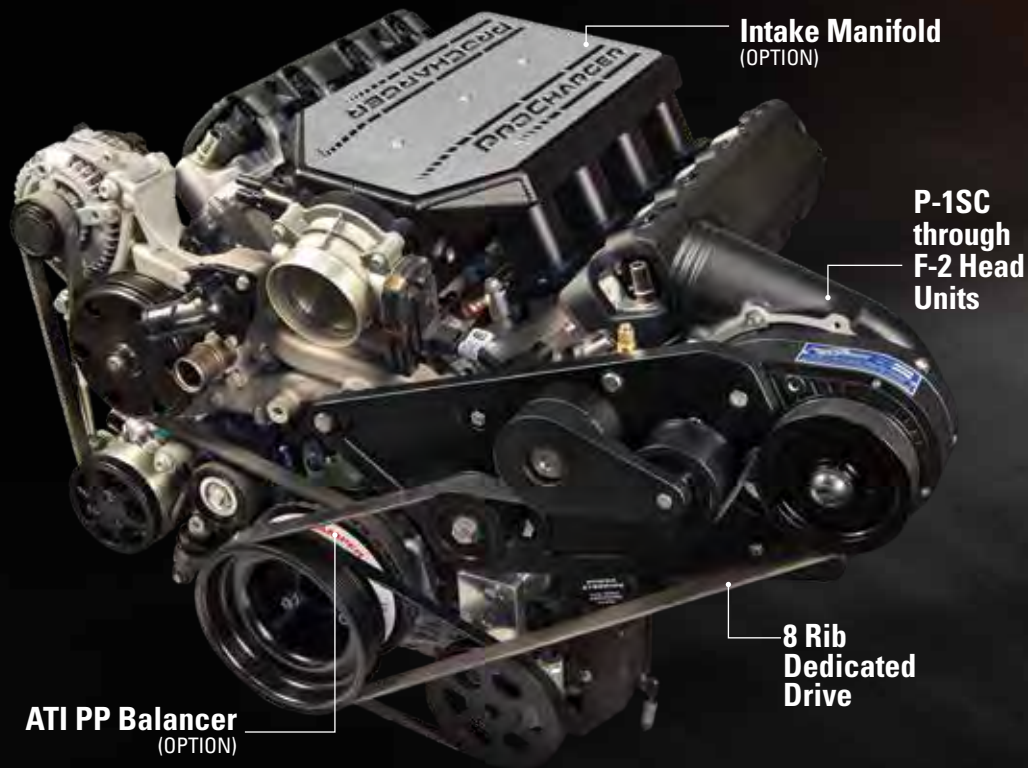

Add a ProCharger to GM's latest generation of engines and enjoy even more horsepower (40%+ HP increase). Our kit includes our most popular P-1SC-1 supercharger with optional supercharger upgrades up to F-2, for those seeking ultimate power. Dedicated 8-rib serpentine belt drive system ensures optimum belt contact for maximum power output. This kit works with the OEM LT1 intake as well as ProCharger's intake manifold upgrade for even higher performance (see picture at left).

The LT1/LT4 Transplant kit is compatible with ATI's standard ATI PP Super Damper (Part# 917314) and a power steering bracket option is available for use with a GM Type II power steering pump. The kit is also compatible with most OEM and aftermarket A/C compressors. Race and Bullet bypass valve kits are also available.

Satin, polished, or black finish options are available for superchargers, brackets, and intake manifolds to help your ride stand out at car shows. A wide range of intercooler options are available (intercooler kits contain universal components and customization is required).

### LT1/LT4 Transplant Kit Information and Options

- Dedicated 8-rib serpentine belt drive system is standard
- Race and Bullet bypass valve kits available
- Transplant Kit comes with ProCharger 8-rib crank pulley, but is also compatible with ATI PP Super Damper # 917314
- Transplant kit works with OEM LT1 intake—ProCharger LT1/LT4 manifold option shown above
- Satin, polished, or black finish options available for supercharger, brackets and intake manifold
- Power steering bracket option available for use with GM Type II P/S pump
- Wide range of intercooler options (intercooler kits contain universal components—customization required)
- Compatible with factory and most aftermarket A/C compressors

### ProCharger LT1/LT4 Transplant Kits

- High Output with P-1SC-1 or D-1SC supercharger
- High Output with Intercooled P-1SC-1 or D-1SC supercharger
- High Output with F-1/F-1A/F-1D or F-1C/F-1R supercharger
- High Output with Intercooled F-1/F-1A/F-1D or F-1C/F-1R
- High Output with F-1A-91 or F-1A-94 supercharger
- High Output with Intercooled F-1A-91 or F-1A-94 supercharger
- High Output with F-1X or F-2 supercharger
- High Output with Intercooled F-1X or F-2 supercharger



# LSX TRANSPLANT KITS

## FOR EFI AND CARBURETED ENGINES

Designed for the popular LSx “transplant” applications, ProCharger’s LSx Serpentine and Cog Drive Supercharger Kits provide a solid, stable mounting and drive configuration for a wide range of ProCharger supercharger models. Building on over 15 years of LSx forced induction leadership, ProCharger is the first to offer a complete supercharger kit for use on modern EFI LSx engines being transplanted into various vehicles. A properly spec’d LSx engine and ProCharger F-2 supercharger can support 1,750+ HP!



### LSx Serpentine Drive Supercharger Kits

Featuring a patented and proven self-contained ProCharger supercharger, a rigid serpentine-drive billet aluminum bracket, available air-to-air intercoolers and the ability to retain many stock accessories including air-conditioning and power-steering, the ProCharger LSx Serpentine Drive Kit is exactly what your LSx transplant vehicle needs. An intercooled system is good for a safe, fuel-efficient and streetable 530 HP on an otherwise stock LS1, and 620+ HP on an otherwise stock ProCharged and intercooled LS3. Upgrading to a D-1SC ProCharger will support up to 900 HP. Significantly higher power levels are possible with modified engines and a ProCharger F-Series supercharger (tuning, injectors and fuel system required).

The serpentine drive kit utilizes a dedicated 8-rib supercharger drive (12-rib upgrade available) and includes a standard 1 year warranty on the supercharger. HO Kits with P- and D-Series ProChargers include a ProFlow valve while kits with an F-Series utilize the legendary “race” valve.

### ProCharger LSx Serpentine Drive Transplant Kits

- High Output with P-1SC-1 or D-1SC supercharger
- High Output with Intercooled P-1SC-1 or D-1SC supercharger
- ProCharger P-1X or D-1X supercharger upgrades available
- High Output with F-1/F-1A/F-1D or F-1C/F-1R supercharger
- High Output with Intercooled F-1/F-1A/F-1D or F-1C/F-1R supercharger

### LSx Cog Drive Supercharger Kit

The LSx Cog Drive Kit can be used in both carbureted (shown at right) and EFI applications and is compatible with accessories such as A/C and P/S, making the kit race-rugged while still maintaining excellent streetability.



The patented and proven lineup of ProCharger superchargers features self-contained oiling, so there is no need for an external oil line and can be matched with a wide range of intercooler options.

In addition to the rugged, 50 mm-wide cog drive belt, the Cog Drive Kit includes a ProCharger race bypass valve. The new ProCharger Competition Carb Bonnet is also available for that ultimate finishing touch for The Ultimate Power Adder under the hood of your LSx transplant project.

Please call ProCharger at (913) 338-2886 for available LSx Serpentine and Cog Drive Kit options, measurements and compatibility.

### ProCharger LSx Cog Drive Transplant Kits

- Cog Drive Kit with F-1/F-1A/F-1D supercharger
- Intercooled Cog Drive Kit with F-1/F-1A/F-1D supercharger
- Cog Drive Kit with F-1C/F-1R supercharger
- Intercooled Cog Drive Kit with F-1C/F-1R supercharger
- Cog Drive Kit with F-1X / F-2 supercharger
- Intercooled Cog Drive Kit with F-1X / F-2 supercharger

# SMALL/BIG BLOCK CHEVY

## FOR AFTERMARKET EFI AND CARB APPLICATIONS



*ProCharger F-2 (12-rib drive) with available Big Block Serpentine Accessory Drive shown with optional polished ProCharger, brackets and Competition Carb Bonnet. Small Block Serpentine Accessory Drive also available.*



*For additional Chevy applications, visit [ProCharger.com](http://ProCharger.com) or call (913) 338-2886*

*"A centrifugal supercharger is the easiest big horsepower gainer that can be added to an automotive engine. Whether it's a blow-through carb system or on an EFI-controlled engine, bolting on a ProCharger results in instant performance."*

*—Super Chevy*

When it comes to adding big, reliable power to your classic Chevrolet-powered "muscle car," no other aftermarket supercharger manufacturer even comes close to ProCharger's offerings for these horsepower hungry owners.

### **Carb and Aftermarket EFI Chevy**

From 350 small blocks to 383 strokers and all the way up to massive 600+ cid big block monsters, ProCharger's extensive lineup of applications for carbureted and aftermarket EFI Chevrolet engines are ideally suited for street, strip and full race vehicles.

Building the correct engine and blower combination, numerous ProCharged "muscle car" owners have demonstrated that it is possible to build a 1,600+ HP street car, complete with air conditioning and power steering!

ProCharger's carb and aftermarket EFI Chevy applications include a wide range of available superchargers, intercoolers, drive systems, bypass vales, carb bonnets and even serpentine accessory drives for both small and big block Chevrolet engines.

### **Carb and Aftermarket EFI Catalog**

For even more information about these awesome ProCharger Chevy combinations, call the ProCharger Sales Team at (913) 338-2886 and ask for a copy of the Chevrolet Carbureted and Aftermarket EFI Applications catalog or visit [www.ProCharger.com](http://www.ProCharger.com) to download.





# FOR WHATEVER MOVES YOU

STREET, STRIP, SAND, SNOW AND WATER ... WE HAVE YOU COVERED



## ProCharger is The **ULTIMATE** Power Adder®

As a GM vehicle owner, you're all about awesome, tire-shredding horsepower, performance and every-day reliability. So why settle for anything less out of the other vehicles in your garage? In addition to being the leader in GM supercharger systems and kits, ProCharger has the most extensive lineup of supercharger solutions in the industry. From the four door family sedan to boats, pickup trucks, SUVs, Harley-Davidson® motorcycles, high-performance UTVs, classic muscle cars and all-out race and track cars, chances are ProCharger has a supercharger solution for it. Give our Sales Team a call at (913) 338-2886 or visit us online at [procharger.com](http://procharger.com) for information.

*"The real magic, of course, comes from the ProCharger centrifugal supercharger. Which specific blower model used depends on how fast you want to go." –HOT ROD Magazine*





# COOLER IS BETTER

## TECHNOLOGY ADVANTAGE

### Thermal Advantage

It's really quite simple: cooler air is more dense. Denser air is able to produce more power. If your goal is to produce maximum reliable power, then you need the coolest charge air temperatures possible. When it comes to producing consistent and reliable power, heat is the ultimate enemy.

These images illustrate the thermal advantages of a ProCharger supercharger system when compared with a turbocharger and positive displacement blower. By their very design, centrifugal superchargers are more efficient compressors and create less heat during their operation. Additionally, ProCharger superchargers are mounted in front of the engine which is a much cooler environment than on top of the engine or if plumbed into the engine's exhaust.

Turbochargers require hot engine exhaust to compress air. The result is a very hot turbine and turbine housing which transfers heat to the compressor. Turbochargers also create high exhaust gas temperatures and backpressure, causing additional heat build up in exhaust manifolds, cylinder heads and valves.

Positive-displacement (PD) blowers are typically located directly on top of the engine or deep between the cylinder heads. Because they are attached to or surrounded by hot engine components, this is an extremely hot environment. Now add the heat created by their lower-efficiency compressors and you end up with a hot compressor producing hot, compressed air. The location of a PD blower necessitates the use of a complex air-to-water-to-air intercooling system which is also located in a hot and heat-soaked environment.

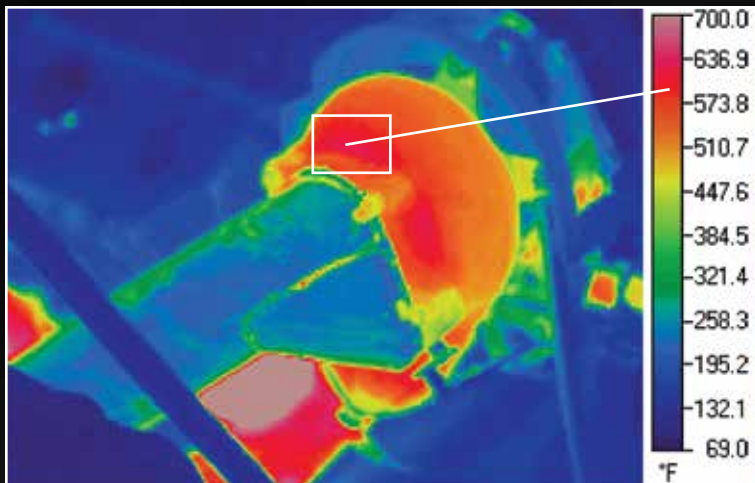

*Turbocharger*

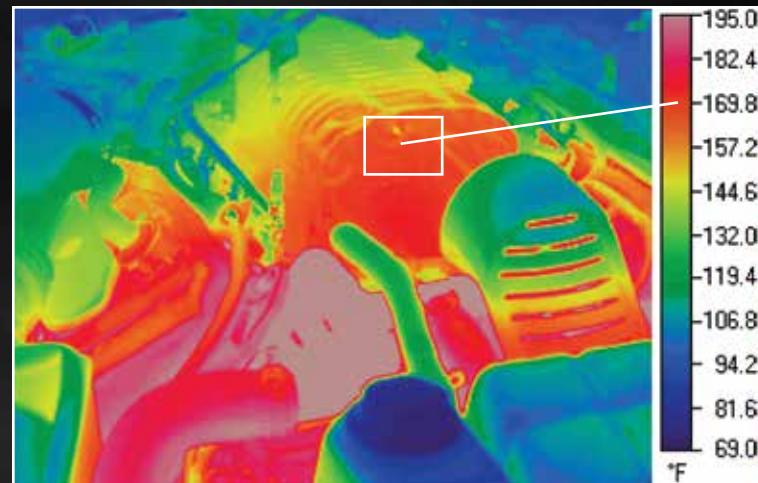

*Positive Displacement with air-to-water-to-air intercooler, 8 psi*

**NOTE:** the scales of the turbocharger and positive displacement images are higher due to the additional heat they produce.



### Increase in Charge Air Temperatures at Engine Intake (10 psi, °F)

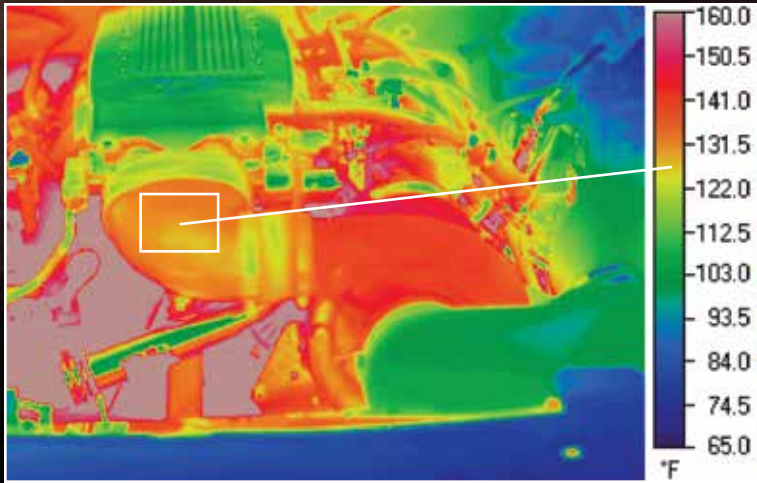
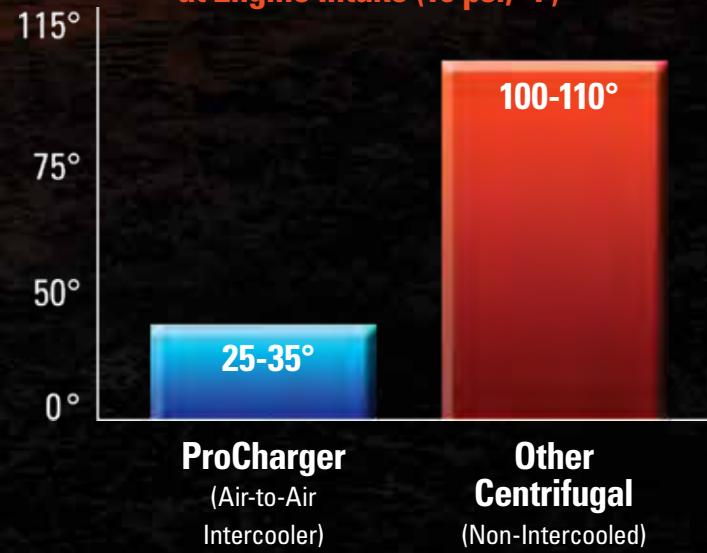

*Other centrifugal, non-intercooled, 9 psi*

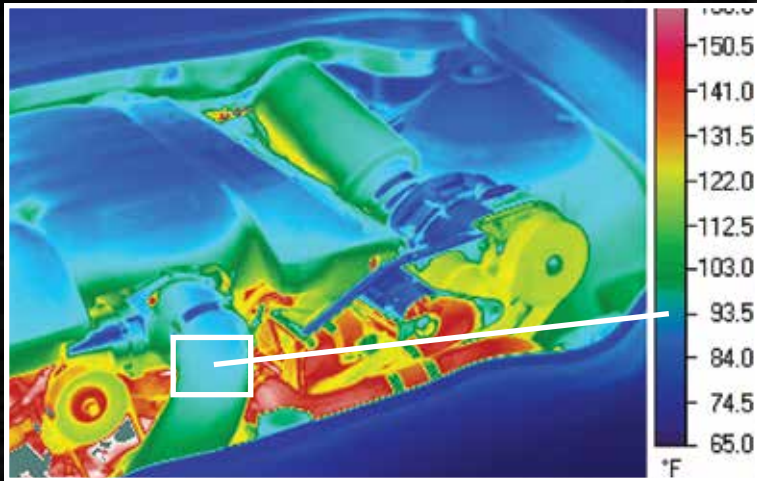

*ProCharger with air-to-air intercooler, 9 psi*



# AIR-TO-AIR INTERCOOLING

## COOLER IS BETTER

### Intercooled Supercharging

ProCharger pioneered the practice of intercooling as an integral design solution on aftermarket supercharger systems nearly 5 years before others and to this day, still offers the most effective, reliable and highest flowing intercoolers. Other aftermarket companies are now embracing air-to-air intercooling, with air-to-air being standard on their newer supercharger kits, while they only offer air-to-water-to-air or no intercooling on their older kits. Don't get stuck with yesterday's technology.

ProCharger intercoolers are an integrated part of our street supercharger systems and have been specifically designed to deliver the lowest charge air temperatures to the engine for maximum engine longevity and efficiency, with zero maintenance. In fact, in test after test, ProCharger's air-to-air intercooled supercharger systems have been proven to produce the largest power gains and coolest charge air temperatures.

Others offer only one size of intercoolers for street/strip applications (or none at all), and their one intercooler frequently becomes undersized with even minor engine modifications. ProCharger offers at least two sizes of intercoolers, often more, and supports the highest street/strip power levels in the industry. This ensures the right product for your power level based on how you will be using your ProCharged vehicle.

With respect to intercooling: efficient, reliable power is the bottom line. And when it comes to street-driven performance, air-to-air intercooling provides superior charge air cooling which in turn is able to produce more power after it enters the engine.

### Intercooler Design Considerations

Because of their design and mounting location, positive-displacement blowers are unable to use air-to-air intercooling, instead having to go with the less effective

air-to-water-to-air configuration or no intercooling at all. Aftermarket turbocharger manufacturers on the other hand, who could go with either system, choose to utilize the more effective air-to-air intercooler technology.

### Benefits of Air-To-Air Intercooling

- More effective
- More reliable
- No maintenance
- Simpler and far easier to install
- Intercooler exposed to a constantly replenished airflow
- Large intercooler surface area for quick recovery and repeatable performance in real-world driving situations
- Superior charge air cooling capabilities

Air-to-air intercooling is effective and simple—no worries of a coolant pump failure or coolant leaks that are possible with an air-to-water-to-air intercooling system. Failure of an air-to-water-to-air intercooler can result in serious and expensive engine damage due to detonation or water entering the engine oil or engine itself.

ProCharger's industry leading system efficiency is proven by producing the most power per psi of boost while also having the ability to produce the highest overall boost and power levels. For maximum power, reliability and driveability since 1994, customers have looked to ProCharger: The Intercooled Supercharging Experts®.

**For even more information on air-to-air intercooling, visit [ProCharger.com](http://ProCharger.com) and check out the Technology pages.**

**“When space permits an adequately sized air-to-air intercooler to be fitted and given access to decent airflow, it will always prove superior. The only excuse for a liquid-based intercooler is when severe space restrictions exist [including positive displacement superchargers, due to mounting location] or ... where an iced coolant can be used.”** *—SuperCharged, Corky Bell*



**“The normal, closed loop air-to-water intercooler system [not using ice] is not as effective as a properly designed air-to-air intercooling system since the cooling medium or the liquid coming from the front heat exchanger is always warmer than the ambient air temperature.”**

*—All About Intercooling, George Spears*

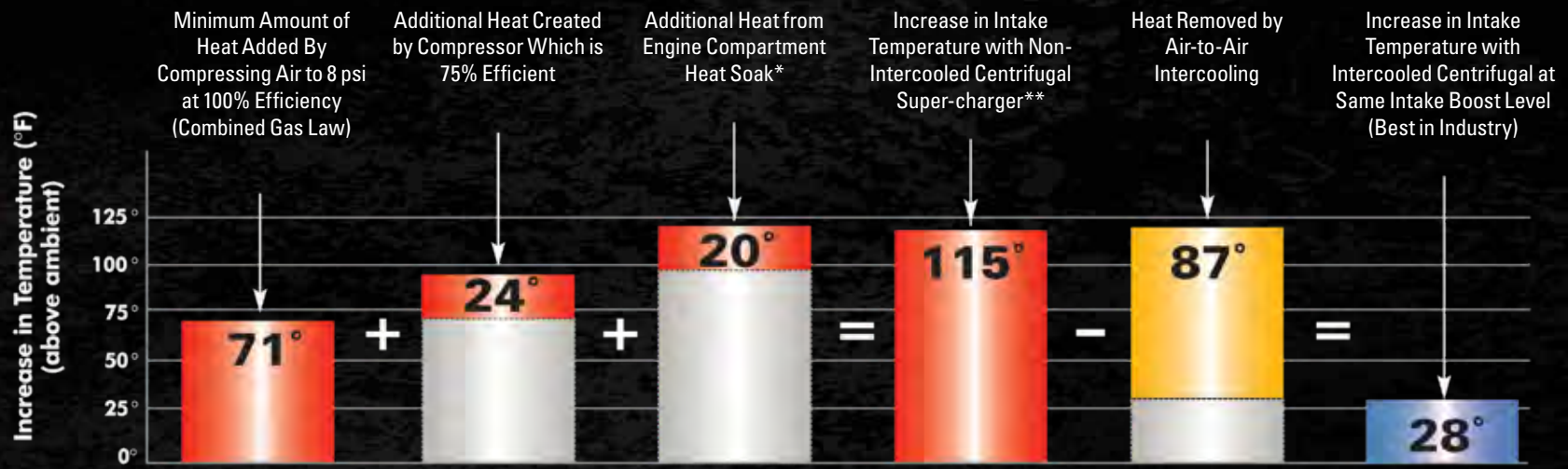

\*Radiant heat from engine and exhaust transferred through air, conductive heat transferred directly, and convective heat from engine oil. This engine compartment heat is not addressed by SAE J1723 (supercharger efficiency standard).

\*\*Temperature will be higher for PD blower or turbo.

# AIR-TO-AIR SUPERIORITY

## THE FUNDAMENTAL SOLUTION

### Air-To-Air Advantage

Since their earliest uses in fighter and bomber aircraft, the advantages of air-to-air intercooling have been demonstrated time and time again. It's a simple fact of physics: cooler air makes more power. Period. Today, ProCharger owners are still reaping the performance benefits of air-to-air intercooling.

On street driven vehicles, air-to-air intercooling is a natural fit because it locates the intercooler at the front of the car where it is exposed to a constant supply of cooling airflow. Consisting of large-volume air plenums, ProCharger's air-to-air intercoolers utilize a highly efficient and durable cross-flow intercooler core that provides large surface areas for superior levels of heat dispersion.

Air-to-air intercooling is a one-step process and represents a fundamental ProCharger advantage. Compressed air enters one side of the intercooler, making its way into the cross-flow core. Once in the core, the compressed air is cooled by the airflow moving

through the passages or fins of the intercooler. Next, this cooler, denser air is routed into the throttle body and into the engine. In engineering terms, air-to-air intercooling represents a one-step cooling process.

On the other hand, positive-displacement blowers are forced to use an air-to-water intercooler system which is a complex arrangement of intercooler cores, hoses, fittings, a coolant pump, electrical connections and yes, a front-mounted air-to-air heat exchanger. In street applications, an air-to-water intercooler is in fact an air-to-water-to-air system.

Typically packed into the tight and hot confines under the supercharger and intake manifold deep in the V of the engine, air-to-water-to-air intercooler systems are very complex, difficult to install, and not as effective as air-to-air intercooling. In engineering terms, air-to-water-to-air intercooling is a two-step cooling process.

### One Step Process: Air-to-Air

Air-to-air intercooling represents a one step process of cooling the compressed air before it enters the engine. Simple, easy-to-install and highly effective, ProCharger's air-to-air intercooler design provides the coolest charge air temperatures for the highest horsepower gains.

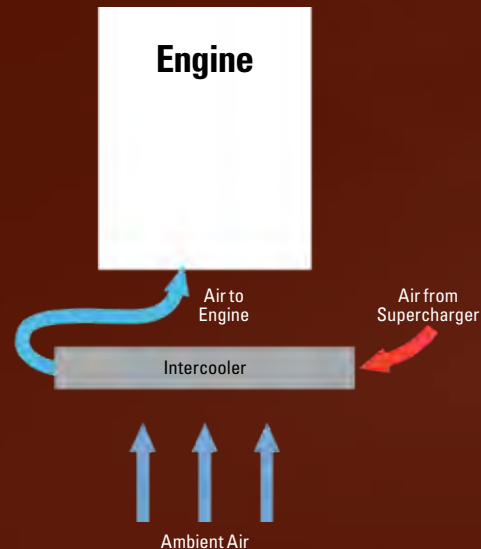

### Two Step Process: Air-to-Water-to-Air

Air-to-water-to-air is a two step process of cooling the compressed air before it enters the engine. Typical air-to-water-to-air intercooler systems are a complex arrangement of potentially unreliable components. Not only is this less effective, but it is also unsightly, adds complexity and risk of coolant leaks and/or coolant pump failure.

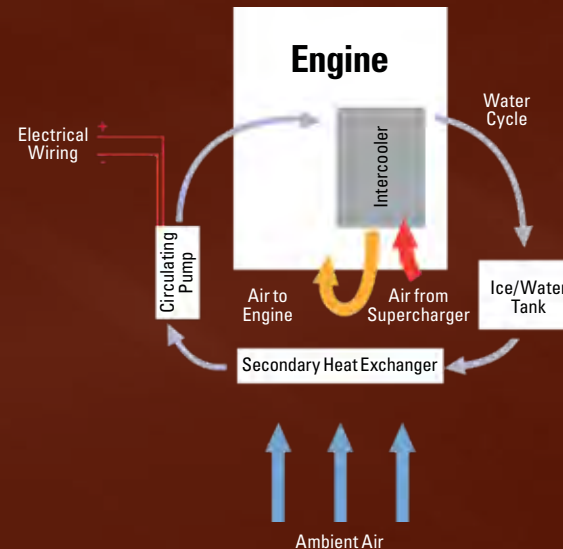



INVENTED, ENGINEERED



AND MADE IN THE USA

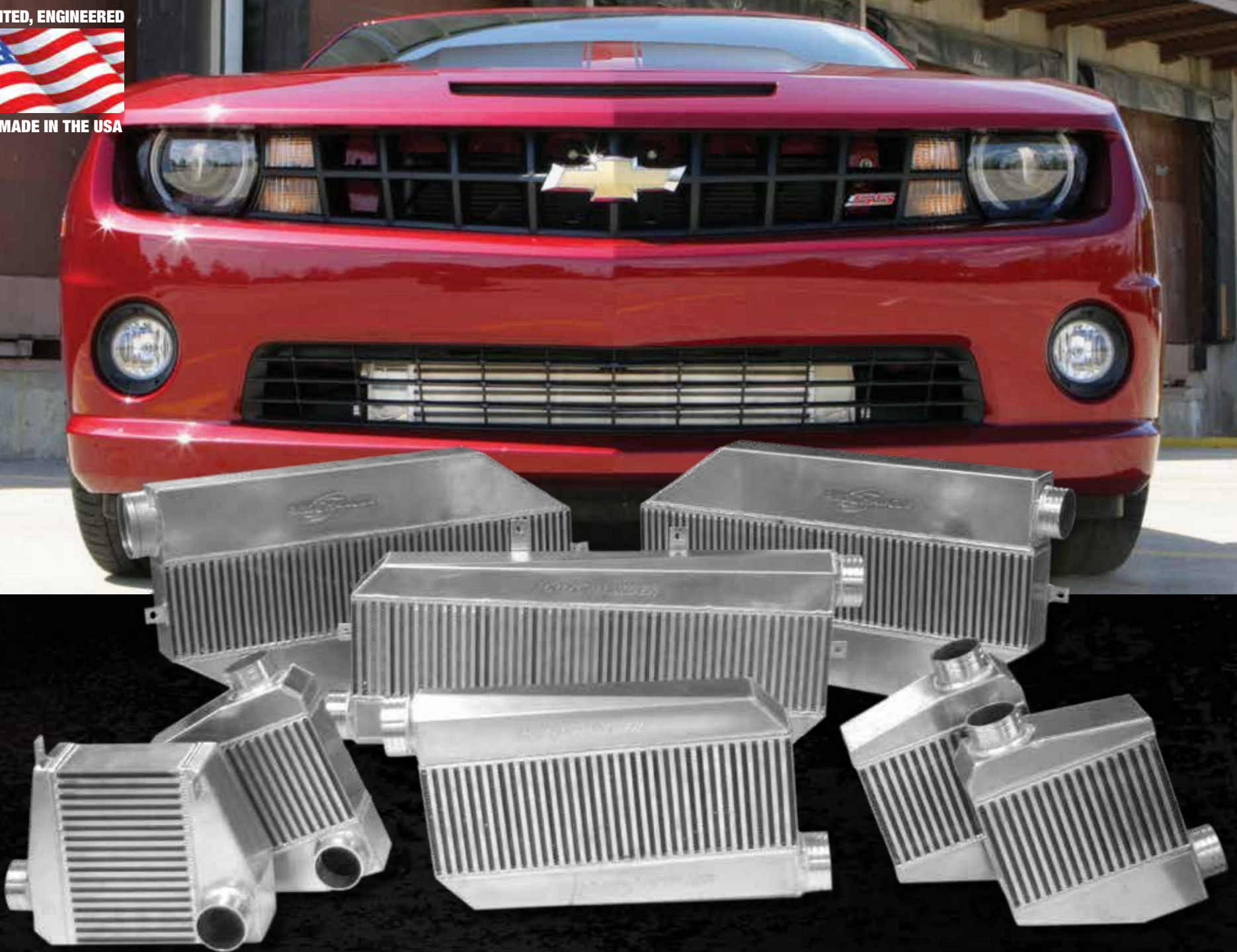

On the street or on the track, ProCharger offers the broadest range of intercoolers of any supercharger manufacturer.

# CENTRIFUGAL LEADERSHIP

DESIGNED TO BLOW AWAY THE COMPETITION™

## Technology

ProCharger introduced the industry's first self-contained, gear-driven supercharger in 2000. Since then, this patented and proven self-contained design has become the standard by which other superchargers are measured.

The top-selling ProCharger P-1SC, P-1SC-1 and D-1SC supercharger models share many of the design elements that deliver the record-setting durability and performance of the ProCharger F-Series competition superchargers. With their rugged design, including an exclusive billet gear case, these self-contained superchargers are powerful and efficient enough to harness the benefits of air-to-air intercooling, while also being durable enough to carry the industry's best warranty coverage.

The patented self-contained design eliminates the need for an external oil supply or oil lines that require a hole to be punched in the engine's oil pan. Additionally, testing has shown self-contained superchargers run cooler than those fed by engine oil.

## Internal Oil Pump

At the heart of the ProCharger self-contained design is a simple, but highly effective oil aerator. This oil aerator creates the oil mist lubrication required for the precision bearings and gears. This oil pump does not require priming at start-up, and oil changes are only required every 6,000 miles.

Instead of being forced to utilize hot engine oil or the grease in sealed bearings, ProCharger superchargers are lubricated with an extremely high-quality synthetic oil specifically engineered for high speed use.

ProCharger's self-contained design eliminates the heat that is transferred to a supercharger by engine-oiled designs and also avoids the possibility of supercharger damage that can result from clogged oil feed lines or oil drainage problems.

## Billet Impellers

Using state-of-the-art, five-axis CNC machines, ProCharger's proprietary impeller designs are crafted from aircraft-grade 7075 T-6 aluminum alloy for tremendous strength and performance. This top-tier material allows for larger impellers that weigh less and are free of the flaws found in typical cast impellers. Large, structurally sound impellers are capable of higher speeds, which flow more air and in turn, produce more power. ProCharger was the first in the industry to utilize billet impellers, back in 1994.



"The self-contained ProCharger that I race has never been back to ProCharger for any kind of repair or check-up since it was new. Five years worth of racing—that means three championships and two runner-up finishes with well over 1,000 passes on it with no problems. Awesome durability!" *—Multi-time National Champion*



## Self-Contained Superiority

Introduced in 2000, self-contained ProCharger superchargers were designed specifically to be self-lubricating, not as an afterthought. Not only does this make our superchargers easier to install, but this patented, gear-driven, self-contained design is durable enough to be available with the best warranty in the industry.

**P-1SC-1: Industry-Leading  
4.10:1 Step Up Ratio**

**Precision Ground Gears  
with Patented Design for  
Noise Reduction Provide  
Unmatched Durability**

**Exclusive 7075 T-6  
billet impeller**

**Custom Teflon Composite  
High Pressure Dual Lipped Seal**

**Precision High Speed  
Rated Aerospace Spec  
Support Bearings**

**Patented Aeration Pump  
Provides Self-Contained  
Oiling with Superior  
Bearing Lubrication**

**Exclusive CNC Machined  
6061 Billet Aluminum  
Housing Ensure Precise  
Shaft Alignment**

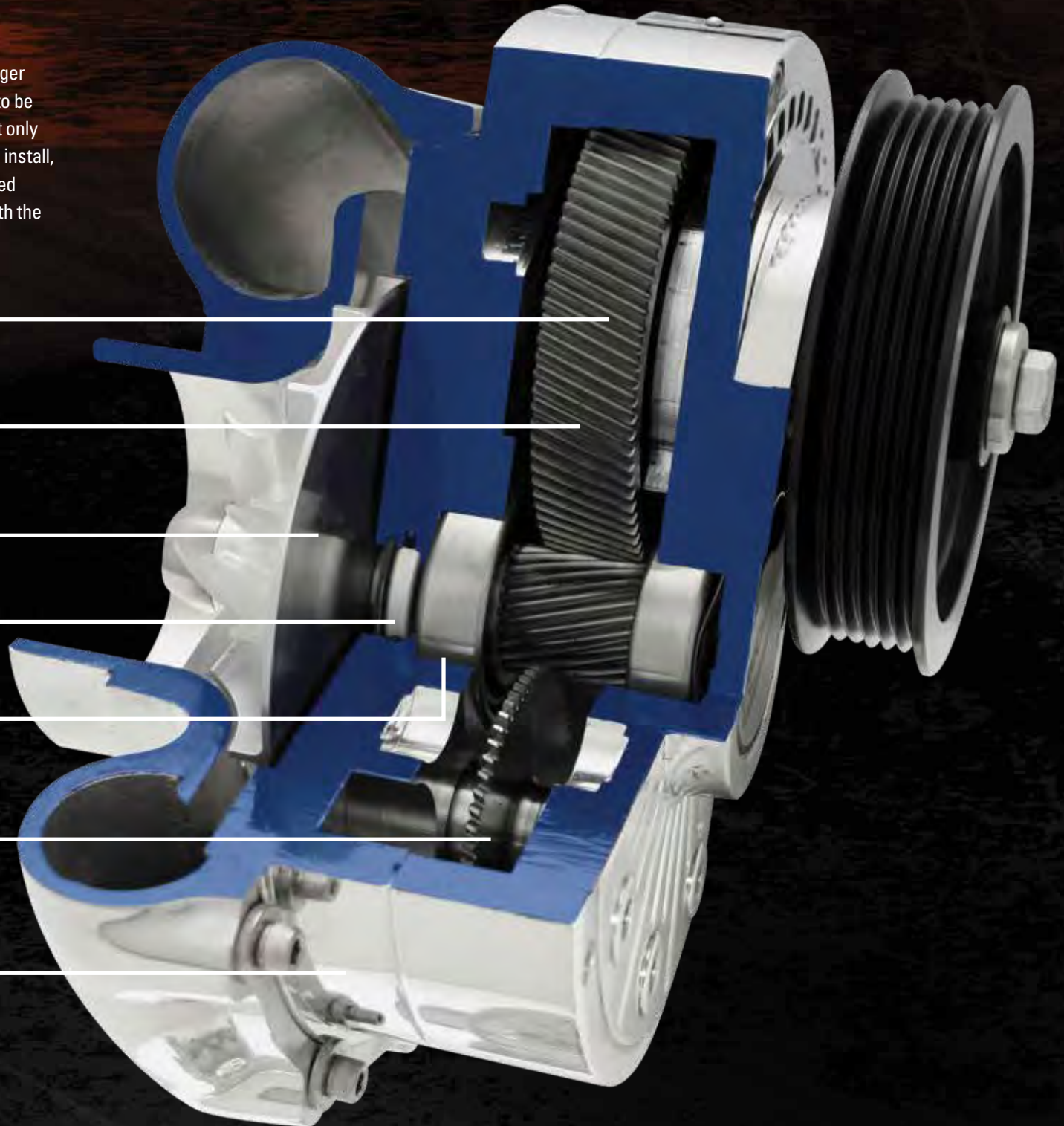

*(Optional helical gear set shown)*

# CENTRIFUGAL SUPERCHARGING

HIGHER EFFICIENCY, MORE POWER, LESS HEAT

## Supercharger Efficiency: Centrifugal vs Positive Displacement

By its very definition, a supercharger is a device (such as a blower or compressor) for increasing the volume air charge of an internal combustion engine over that which would normally be drawn in by the intake stroke of the pistons. Efficiency refers to both the heat created by the supercharger and the power required to drive it.

Due to their design, it's a commonly accepted engineering fact that centrifugal compressors are much more efficient than positive displacement superchargers. More efficient compressors mean more efficient supercharger systems, this in turn means more power across a wider operating range for your engine. This is the very core of the ProCharger supercharger advantage.

The advantages are in terms of airflow and air pressure, and as a result, centrifugal compressors produce greater power and significantly lower charge air temperatures. This broad operational range supports future engine modifications, meaning you are less likely to "outgrow" your ProCharger supercharger than a positive displacement design.

At higher boost levels, centrifugal superchargers remain 70 to 80% efficient, whereas positive-displacement-blowers are less efficient to begin with and efficiency further declines as pressure increases. Positive-displacement blowers are also mounted on top of the engine where they quickly become heat soaked, further increasing charge air temperatures. Positive-displacement blowers deliver a nearly-fixed volume of air per revolution at all RPMs, making PD blowers less efficient than ProCharger centrifugal design throughout the engine's performance operating range.

## More Boost After Peak Torque

Most of today's stock street engines have a torque curve that falls away while horsepower is still on the rise. A ProCharger centrifugal supercharger system continues to increase the amount of intercooled boost available to your engine once it is past its peak torque output. Now, rather than your engine "going flat" after peak torque, it continues to build power right up to your engine's maximum RPM. The result is more power across the typical operational RPM range of a performance engine.

A ProCharger centrifugal supercharger can also support future modifications to your engine or exhaust system. Thanks to industry-leading step-up ratios and rugged design, ProCharger provides the best performance at any power level. High-flow intake manifolds, camshaft, cylinder heads and exhaust systems can all be supported via more airflow and boost from the same ProCharger supercharger with a simple pulley upgrade.







## ADVANTAGE IN EFFICIENCY AND OPERATING RANGE

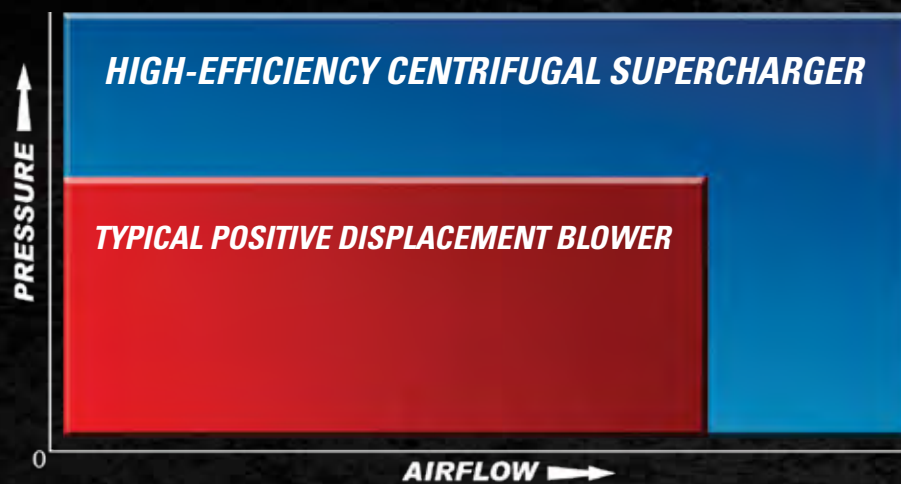

## Wider Operating Range

Centrifugal superchargers have a much broader operating range, in terms of both airflow and pressure, when compared to typical positive displacement blowers. Bottom line: ProCharger makes more power at the same boost level, and also offers far more upgradability to accommodate engine modifications and higher boost and power levels.

“ProCharger takes pride in this kit being designed and manufactured in the U.S. of A.” –*GM High Tech Performance*

# P-1X/D-1X SUPERCHARGERS

## HIGH EFFICIENCY STREET/STRIP SUPERCHARGERS

### Higher Efficiency 9" Designs

The ProCharger P-1X and D-1X head units feature the robust, self-contained gearcase that is standard on most ProCharger models, but with a new aerodynamic compressor design that creates cooler charge air temperatures and more horsepower at the same boost level than the industry-standard P-1SC-1 and D-1SC. This higher efficiency design is engineered to be a bolt-in replacement for P-1SC-1 and D-1SC equipped systems. These unique designs are built on the same proven technology that propels the P-1SC-1 and D-1SC models. This technology allows

the D-1X to be capable of 4-digit power numbers and slightly beyond, and utilize 4.10:1 step-up ratio. The compressor side of the supercharger is designed with greater efficiency and less parasitic engine load. This means less heat and less power needed to spin the impeller—that adds up to more horsepower. The P-1X fits into the same brackets as P-1SC-1 systems and is an optional upgrade for those who want increased performance on otherwise stock, modern V8 engines—to the tune of 10-15 more flywheel HP at the same pulley size!

### ProCharger P-1X

Base HP (NA Engine) ...300-500 HP  
Max Supercharged HP..... 875 HP  
Maximum Airflow .....1,275 cfm  
Maximum Boost..... 32 psi  
Maximum Impeller RPM ....65,000  
Internal Step-up Ratio .....4.10:1

### ProCharger D-1X

Base HP (NA Engine) ...300-550 HP  
Max Supercharged HP.... 1,000 HP  
Maximum Airflow .....1,500 cfm  
Maximum Boost..... 32 psi  
Maximum Impeller RPM ....62,000  
Internal Step-up Ratio .....4.10:1

### P-1X/D-1X Features:

- More power per psi, more maximum HP, and cooler charge air temperatures
- 10-15 flywheel HP gain with P-1X on otherwise stock, modern V8 engines at the same boost level and pulley size (vs P-1SC-1)
- Even larger gains possible at the same boost level with built and modified engines
- P-1X™ is 875+ HP capable and is a direct bolt-in upgrade for the P-1SC-1
- D-1X™ is 1000+ HP capable and is a direct bolt-in upgrade for the D-1SC
- Designed for today's high flowing V8 engines producing 300+ naturally aspirated HP
- Durable, high HP designs with a compact new state-of-the-art 9.0" housing/volute
- Uses same proven gearcase as P-1SC-1 and D-1SC—also available with standard or reduced noise level





# BYPASS VALVES

## SURGE VALVES FOR STREET AND RACE APPLICATIONS

### Why Bypass/Surge Valves are so Important

A bypass/anti-surge valve, also known as a "surge valve" or "blow off valve" is an important part of the forced induction driving experience. From a practical standpoint, it's designed to help maintain the longevity and reliability of the compressor by evacuating turbulent air from hitting the impeller. From a driver's standpoint, it can either operate quietly by re-routing this discharged air back into the intake plumbing or provide a distinctive and visceral woosh of sound when vented directly to the atmosphere. Whether you like to be reminded that you're driving a ProCharged car with the satisfying vent of air, or prefer to have it run quietly in the background, ProCharger offers four different surge valve options to fit your preference.

### Street

**ProFlow™ Valve:** The ProFlow valve is the standard surge valve option for street supercharger systems and kits. Compact in size, it can be fitted into tight spots when space is limited. Its butterfly valve is extremely durable and reliable, and this design creates a straight airflow path which achieves excellent flow for its size. The ProFlow valve can also be paired with a small air filter to minimize noise.

**Bullet Valve:** This surge valve's compact design also makes it fit easily in tight spaces. It comes in both an open and closed format. The closed format allows you to recirculate air back into the system, or instead, to run to an air filter to minimize noise.

### Race

**Race Valve:** This is the industry leading surge valve for both street and race applications. The larger valve diameter is designed for high flow applications.

**ProRace™ Valve:** The ProRace valve outperforms any other single valve on the market and is ProCharger's highest-HP bypass valve option. This massive flow capacity comes from a piston style valve design (patent pending) that allows for a significant increase in curtain area over traditional style valves, while still fitting into a reasonably sized package. It also incorporates a v-band clamp for an easy install.



	ProFlow	Bullet (open)	Bullet (closed)	Race (open)	Race (closed)	ProRace
Application	Street	Street	Street	Street/Race	Street/Race	Race
Inlet Diameter	1.5 in	1.5 in	1.5 in	2.0 in	2.0 in	3.0 in
Outlet Diameter	1.5 in	Open Vent	1.5 in	Open Vent	2.0 in	Open Vent
Mounting	Hose Clamp	Hose Clamp	Hose Clamp	Weld-On Flange, Bolt-On Valve	Weld-On Flange, Bolt-On Valve	Weld-on Flange, V-Band Clamp Valve

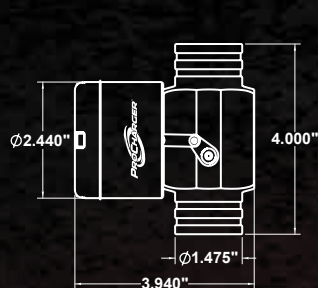

ProFlow™

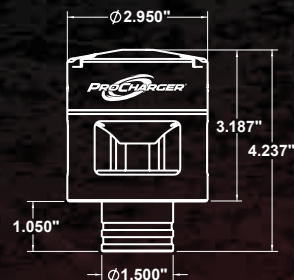

Bullet

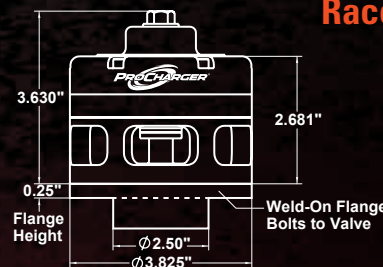

Race

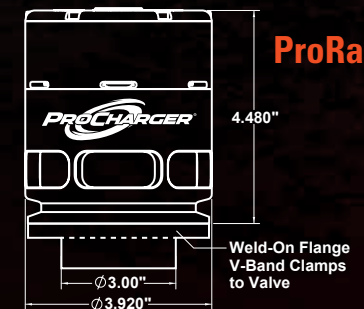

ProRace™

# THE ULTIMATE POWER ADDER®

NOTHING ELSE EVEN COMES CLOSE

## Other Power Adders Just Don't Add Up

Proven by dealers, racers and GM owners around the world, no other form of aftermarket power-adder provides the combination of power, reliability, ease of installation and maintenance, engine safety and cool operation of a ProCharger. Let's take a look at why the other power enhancing options just don't add up.

## Nitrous Oxide

Initially, nitrous may look like a bargain, but a review of the facts reveals otherwise. Nitrous oxide accelerates the combustion rate, which in turn, increases peak cylinder pressures. This combination greatly increases the probability of piston-melting pre-detonation. This rapid increase in cylinder pressure also increases the load placed on internal engine components. Additionally, nitrous oxide adds the expense and hassle of constantly having to refill bottles and is not always available when you need it.

## Positive Displacement Blowers

Centrifugal superchargers offer substantially higher adiabatic efficiencies than their positive-displacement (PD) counterparts. PD blowers are located on top or nestled in the "V" of the engine, placing them in a very hot, harsh environment which results in significantly hotter charge air temperatures. This location also requires the use of a significantly more complex and less effective air-to-water-to-air intercooling configuration. To cope with these high charge air temperatures, PD blowers must be tuned extremely rich with less timing. This reduces the vehicle's fuel efficiency, driveability, power and engine longevity.

## Turbochargers

A turbocharger, technically a turbosupercharger, is in fact a form of centrifugal supercharging. Although they use advanced compressor technologies similar to ProCharger's compressor designs, turbo systems' initial cost and complexity make them less practical for everyday street driving. Because a turbo relies on hot engine exhaust to create power, they also create high exhaust temperatures and backpressure, high charge air temperatures and are subject to "lag" that degrades their real-world driving performance. Additionally, turbos require engine oil feed and return lines for lubrication and due to extreme heat, increase the thermal breakdown of your engine's oil.



*ProCharger F-3 powers HOT ROD® Drag Week Champion: Fastest Street Car in America*

## Other Centrifugal Superchargers

When compared with other centrifugal superchargers on the market, ProCharger superchargers support nearly twice the horsepower along with much greater durability and reliability. Additionally, ProCharger is focused solely on centrifugal compressor technology, providing superior product and support to customers and dealers.

## Naturally Aspirated

The expense associated with building an engine large enough to produce the same power as a ProCharged stock engine just doesn't add up, especially when you consider the poor idle quality and extra fuel the larger engine will require. You must also consider the time and hassle of a complete engine swap or the downtime of a complete engine rebuild. Large displacement engines also tend to utilize higher compression ratios which create more heat and require expensive race fuels.

**"ProCharger has really taken supercharging to the next level."**

**—Chevy High Performance**





# POWER ADDER COMPARISON

MAKING 675+ HP WITH A STOCK 5.0L 4V ENGINE

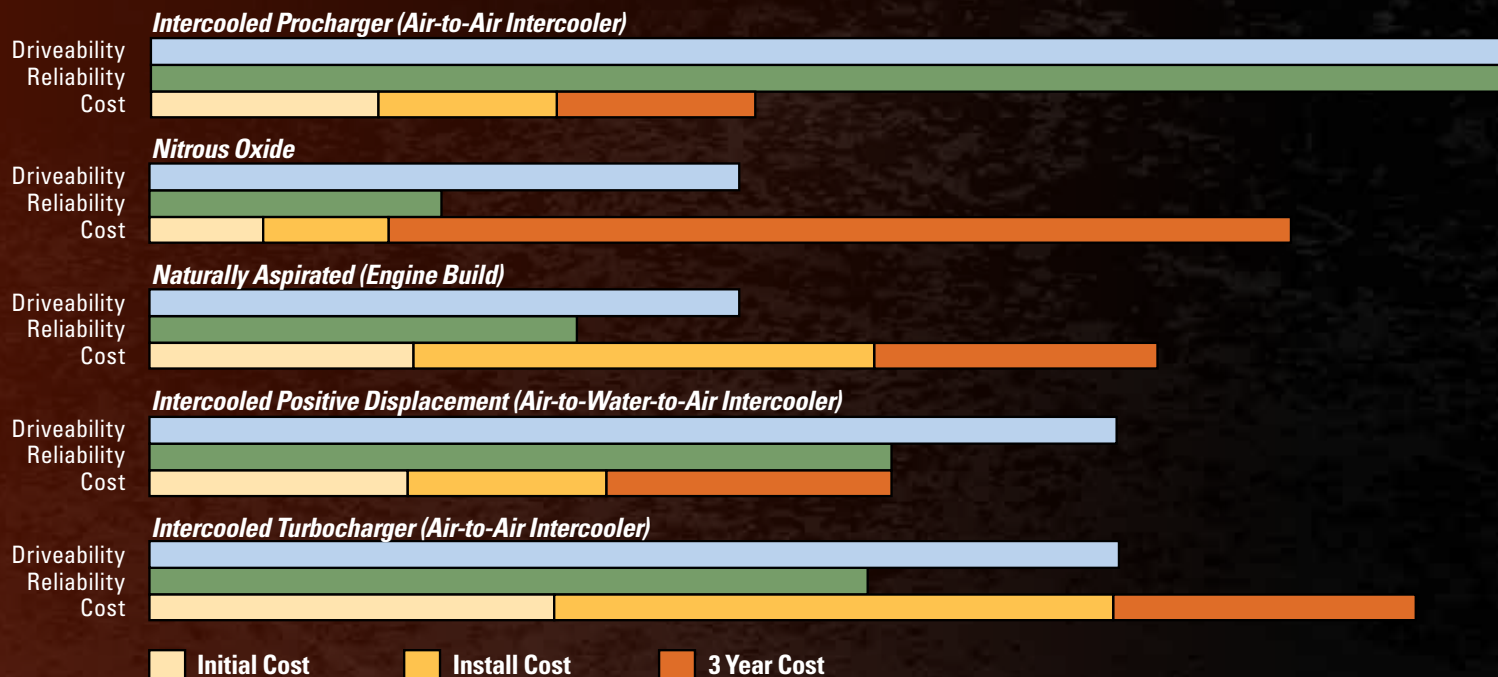

# RACING DOMINATION

## REAL WORLD PROCHARGER POWER

### ProCharger Motorsports

ProCharger has a long 20+ year history of helping an incredible number of enthusiasts and racers accomplish their performance goals: WINNING! From drag strips to road course, and from the salt flats of Bonneville to open road races and rear-wheel dyno competitions, more and more ProCharger owners are reaching and exceeding their performance goals in amazing fashion.

When it comes to motorsports, talk is cheap. It seems like there are always too many aftermarket manufacturers willing to inflate their performance claims. ProCharger-equipped racers prefer to let their actions and results speak for themselves.

### ProCharger and Racing: A Winning Combination

ProCharger superchargers are synonymous with GM performance, especially in sanctioned drag racing competition. ProCharger was the first centrifugal supercharger to power racers into the 6's. As a matter of fact, as far back as 2002, every single Super Street and Street Outlaw racer in the 7's, and Renegade racer in the 8's were all ProCharged. Once the ProCharger supercharger power genie was out of the bottle, there was no looking back—unless you count looking in the mirror for the other guys.

The list of ProCharged racing champions, record holders and top performers reads like a Who's Who of Chevy and Pontiac racers. Check out the ProCharger Honor Roll on the next page. Are you ready to put your name on this list?

### We Race, You Win

The same design philosophy that puts top racers into the winner's circle can be found in every street-legal ProCharger supercharger system. With a ProCharger system, not only will you receive the largest and most engine-friendly horsepower gains, you also have the peace of mind knowing that your supercharger was designed to reliably and consistently produce event and championship-winning power race after race, year after year. What are your high-performance goals? Let ProCharger help you blow them away.



*3000+ Horsepower*

### Consider these ProCharger Motorsports Achievements:

- ProCharged racers have won over 100 national championships in the past 15 years
- In drag racing, the 80 quickest centrifugal racers are all powered by ProCharger
- The first centrifugal supercharger to power a doorslammer past 200 mph
- HOT ROD Pump Gas Drags Championship
- HOT ROD Drag Week Championship
- Car Craft Street Machine of the Year Award
- HOT ROD Maxton Mile Top Speed Challenge Winner
- Bonneville record—World's Fastest Camaro
- The ONLY supercharger to make 2,000 horsepower on pump gas
- The ONLY supercharger to make 3,000 horsepower on alcohol—far more than the closest centrifugal!





## ProCharger Honor Roll GM Champions and Record Holders

- |                   |                 |
|-------------------|-----------------|
| Marco Abruzzi     | Troy Langlo     |
| J.R. Baxter       | James Lawrence  |
| Benjamin Board    | Jason McNeil    |
| Noel Borg         | Mark Micke      |
| Jake Brantner     | Mikey Rees      |
| Bo Butner         | David Reese     |
| Jared Cocanougher | Jason Reuckert  |
| Johnny Coleman    | Tony Ridenour   |
| George Farkouh    | Mike Roy        |
| Louie Filippides  | Fran Schatz     |
| Ric Fleck         | Scott Smith     |
| Jese Gese         | Will Stevenson  |
| Mark Gjavenis     | Troy Terpantier |
| Eric Gustafson    | Denny Terzich   |
| Dave Hinzman      | Mark Weiler     |
| Mike Hupp         | Jarod Wenrick   |
| Steve Jackson     | Travis Wester   |
| Al Jimenez        | Kevin Young     |
| Andrew Johnson    | Rob Zarcone     |



# F-1 SERIES

1000+ HP

## ProCharger F-Series Superchargers

ProCharger F-Series superchargers were designed with one simple goal: blow the competition away. Since their introduction in 2000, ProCharger's ever-expanding lineup of F-Series superchargers have continued to be the standard by which others hope to be measured, both on the track and on the street. From the custom designed 7075 billet aluminum impeller to the CNC machined transmission case to the industry-exclusive, compound bearing design, each self-contained F-Series supercharger has been designed to deliver maximum performance, pass after pass, year after year, championship after championship.

## ProCharger F-1, F-1D and F-1A Superchargers

These five ProCharger superchargers utilize a compact, 9" volute and are powerful and highly versatile superchargers. Like all the F-Series models, the F-1 and F-1A feature the industry-exclusive compound bearing design that supports high horsepower applications, while the patented and proven self-contained oiling design eliminates the need for external oil lines while providing years and years of trouble-free high performance.

## ProCharger F-1C and F-1R Superchargers

These ProCharger superchargers use a slightly larger, 9.75" volute for higher airflow and HP ratings and retain all the design advantages of the other F-Series models.

## On the Street or Strip

The highly versatile ProCharger F-1 Series supercharger lineup is compact enough for many of today's high-horsepower modified street engine applications, yet powerful enough for ultra-high street horsepower and hard-core racing applications. Give the ProCharger Sales Team a call at (913) 338-2886.



## ProCharger F-1D

Base HP (NA Engine) ...300-500 HP  
Max Supercharged HP .....1,050 HP  
Maximum Airflow .....1,500 cfm  
Maximum Boost..... 34 psi  
Maximum Impeller RPM ....65,000  
Internal Step-up Ratio ..... 5.40:1

## ProCharger F-1A-91

Base HP (NA Engine) ...300-500 HP  
Max Supercharged HP .....1,150 HP  
Maximum Airflow .....1,600 cfm  
Maximum Boost..... 38 psi  
Maximum Impeller RPM ....74,000  
Internal Step-up Ratio ..... 5.40:1

## ProCharger F-1C-94

Base HP (NA Engine) ...300-550 HP  
Max Supercharged HP .....1,200 HP  
Maximum Airflow .....1,650 cfm  
Maximum Boost..... 38 psi  
Maximum Impeller RPM ....74,000  
Internal Step-up Ratio ..... 5.40:1

## ProCharger F-1

Base HP (NA Engine) ...300-500 HP  
Max Supercharged HP .....1,050 HP  
Maximum Airflow .....1,525 cfm  
Maximum Boost..... 38 psi  
Maximum Impeller RPM ....70,000  
Internal Step-up Ratio ..... 5.40:1

## ProCharger F-1A-94

Base HP (NA Engine) ...300-500 HP  
Max Supercharged HP .....1,200 HP  
Maximum Airflow .....1,625 cfm  
Maximum Boost..... 38 psi  
Maximum Impeller RPM ....74,000  
Internal Step-up Ratio ..... 5.40:1

## ProCharger F-1R

Base HP (NA Engine) ...375-550 HP  
Max Supercharged HP .... 1,225 HP  
Maximum Airflow .....1,700 cfm  
Maximum Boost..... 38 psi  
Maximum Impeller RPM ....68,000  
Internal Step-up Ratio ..... 5.40:1

## ProCharger F-1A

Base HP (NA Engine) ...300-500 HP  
Max Supercharged HP .....1,100 HP  
Maximum Airflow .....1,575 cfm  
Maximum Boost..... 38 psi  
Maximum Impeller RPM ....74,000  
Internal Step-up Ratio ..... 5.40:1

## ProCharger F-1C

Base HP (NA Engine) ...300-550 HP  
Max Supercharged HP .....1,200 HP  
Maximum Airflow .....1,625 cfm  
Maximum Boost..... 38 psi  
Maximum Impeller RPM ....74,000  
Internal Step-up Ratio ..... 5.40:1



# F-1X / F-2

1600+ HP

## ProCharger F-1X Supercharger

The ProCharger F-1X features a larger, 10.5 inch volute diameter and provides a significant increase in airflow when compared with the F-1/F-1A and F-1C/F-1R superchargers. Considered by many to be the ideal combination of small size and high performance, the F-1X retains all the F-Series design advantages, including patented self-contained oiling, ultra-high speed compound bearing assembly, and precision ground 9310 steel gears that can support up to 1,300 HP.

## ProCharger F-1X-12 Supercharger

The F-1X-12 features another increase in airflow with a 12 inch volute diameter. Compared to the F-1X, the F-1X-12 is larger in most categories, with larger inlet, outlet, inducer, and exducer diameters. The F-1X-12 retains all the F-Series design advantages, including patented self-contained oiling, ultra-high speed compound bearing assembly, and precision ground 9310 steel gears that can support up to 1,500 HP.

## ProCharger F-2 Supercharger

The legendary F-2 supercharger also features a 10.5" volute diameter and provides a further performance increase above the F-1X. The F-2 is not subject to the racing class restrictions placed on the F-1X, and supports up to 1,750 HP. The F-2 presents an ideal combination of size and performance, and retains all of the F-Series design advantages, including patented self-contained oiling, a patented ultra-high speed compound bearing assembly, and precision ground 9310 steel gears that can support up to 1,600 HP.



### ProCharger F-1X

Base HP (NA Engine) ... 375-550 HP  
Max Supercharged HP .... 1,300 HP  
Maximum Airflow ..... 2,000 cfm  
Maximum Boost ..... 38 psi  
Maximum Impeller RPM .... 72,000  
Internal Step-up Ratio ..... 5.40:1

### ProCharger F-1X-12

Base HP (NA Engine) ... 375-550 HP  
Max Supercharged HP .... 1,500 HP  
Maximum Airflow ..... 2,300 cfm  
Maximum Boost ..... 38 psi  
Maximum Impeller RPM .... 68,000  
Internal Step-up Ratio ..... 5.63:1

### ProCharger F-2

Base HP (NA Engine) ... 425-600 HP  
Max Supercharged HP .... 1,600 HP  
Maximum Airflow ..... 2,700 cfm  
Maximum Boost ..... 38 psi  
Maximum Impeller RPM .... 65,000  
Internal Step-up Ratio ..... 5.40:1



# F-3 SERIES

2100–3000+ HP

## ProCharger F-3 Supercharger

Welcome to the Big Time. The ProCharger F-3 supercharger is the pinnacle for racers looking for ultra-high horsepower along with championship-earning reliability and consistency. The first centrifugal supercharger to power a doorslammer over 200 mph and into the 6's, F-3 ProChargers are the centrifugal superchargers of choice among the best racers around the world. In fact, more racing championships and more world records have been set by racers running F-3 ProChargers than any other centrifugal supercharger. Period.

National Muscle Car Association (NMCA), National Hot Rod Association (NHRA), X275, Pacific Street Car Association (PSCA), LS Fest, West Coast Hot Rod Association (WCHRA), HOT ROD's Drag Week and Pump Gas Drags, Bonneville, Maxton and more—chances are very good that a ProCharger-equipped racer has “been there, won that” with a ProCharger F-3 under their hood.

The legendary ProCharger F-3 family of supercharger models features a large, 12-inch volute and provides vastly higher airflow than the F-1 and F-2 models. Considered by many to be the ultimate competition power adder, the F-3 retains all the F-Series design advantages, including self-contained oiling, the patented ultra-high speed compound bearing assembly, precision ground 9310 steel gears and can support 3,000+ HP.

## Proven Repeatable Performance

With three trims available, the ProCharger Motorsports Team can help you determine which F-3 model best suits your specific application and horsepower goals. Visit [ProCharger.com/models](http://ProCharger.com/models) for specifications on all ProCharger supercharger models.

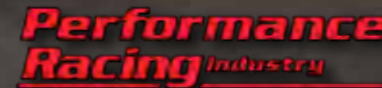
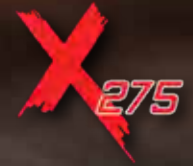

*ProCharger F-3R-121, Record for quickest centrifugally-supercharged small-block car*

### ProCharger F-3R-121

Base HP (NA Engine) ... 500-580 HP  
 Max Supercharged HP.... 2,100 HP  
 Maximum Airflow ..... 3,100 cfm  
 Maximum Boost..... 40 psi  
 Maximum Impeller RPM .... 72,000  
 Internal Step-up Ratio ..... 5.63:1

### ProCharger F-3R-130

Base HP (NA Engine) ... 600-900 HP  
 Max Supercharged HP.... 2,600 HP  
 Maximum Airflow ..... 3,600 cfm  
 Maximum Boost..... 45 psi  
 Maximum Impeller RPM .... 72,000  
 Internal Step-up Ratio ..... 5.63:1

### ProCharger F-3R-136

Base HP (NA Engine) .. 700-1000 HP  
 Max Supercharged HP.... 3,000 HP  
 Maximum Airflow ..... 4,000 cfm  
 Maximum Boost..... 50 psi  
 Maximum Impeller RPM .... 72,000  
 Internal Step-up Ratio ..... 5.63:1



“So what makes this new blower so much better than the models that created a tidal wave of ProCharger racers last year? Well, it starts where most things do at ATI— with a stronger transmission for improved durability.”

—Steve Turner

# F-SERIES TECHNOLOGY

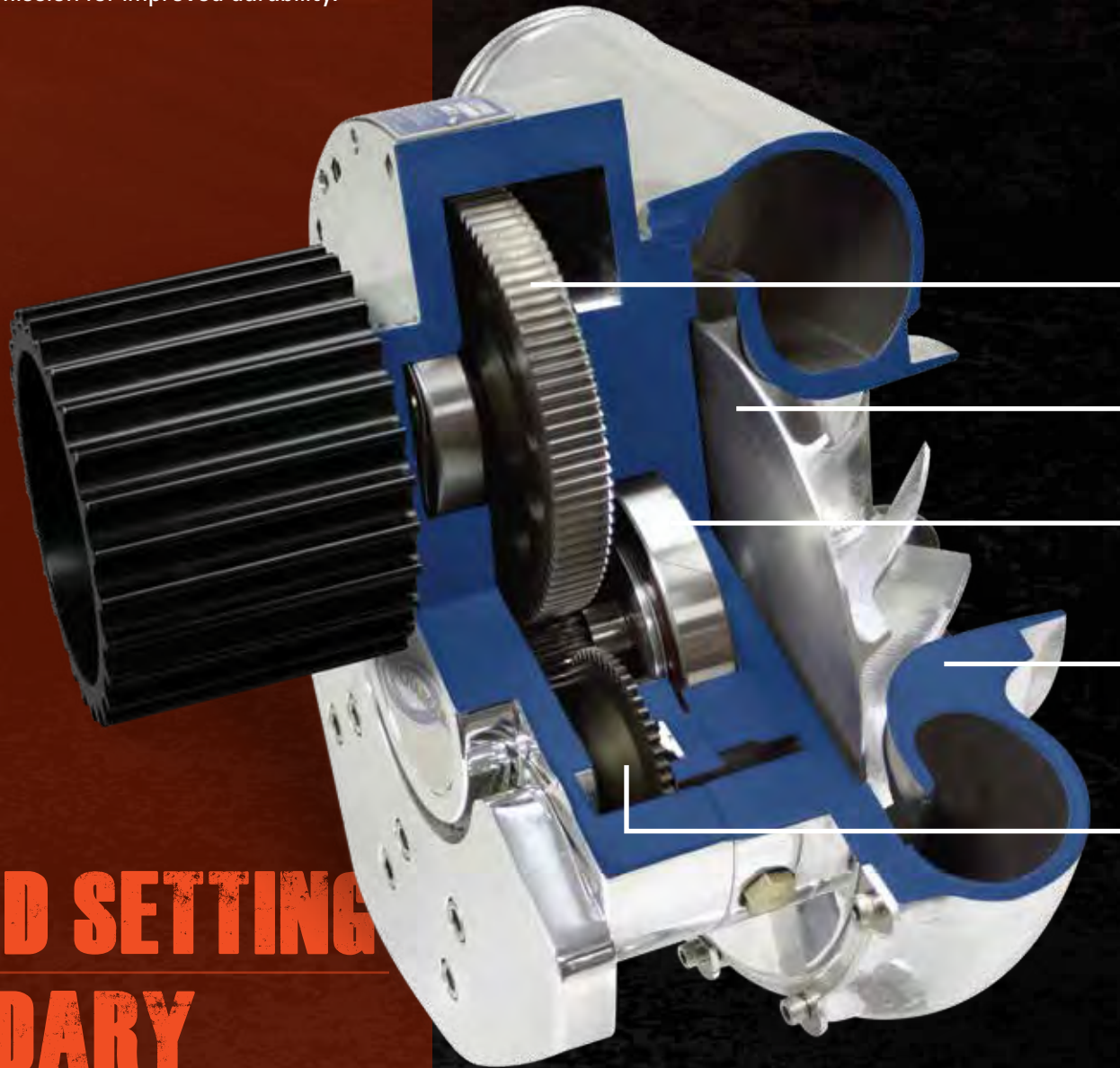

Custom Teflon Composite High Pressure Dual Lipped Seal

Precision Ground 9310 Steel Gears Provide Industry Leading Step-Up Ratios

Industry-Exclusive 7075 T-6 Billet Impeller

Patented Ultra High Speed Compound Bearing Assembly

Exclusive CNC Machined 6061 Billet Aluminum Housing Ensure Precise Shaft Alignment

Patented Aeration Pump Provides Self-contained Oiling with Superior Bearing Lubrication

*(visit ProCharger.com for model-specific step up ratios)*

**RECORD SETTING  
LEGENDARY  
MOST WINNING**

# BUILDING THE POWER

THE LARGEST POWER GAINS, FROM THE GROUND UP

## ProCharger: Fundamental Advantage

ProCharger has several advantages which help support cutting edge innovation, precise engineering, quality manufacturing, unsurpassed performance and best in class service. First, ProCharger designs and manufactures both its own superchargers and complete supercharger systems, unlike some competitors who buy superchargers and components elsewhere and are really only assembling kits. This helps ensure that ProCharger delivers a high quality, high performance product designed specifically for your needs. Secondly, ProCharger resources lead the industry, including best in class aerodynamic design capabilities, and an unmatched commitment to testing (test lab, chassis and engine dynos, industry's largest test fleet). No other aftermarket company is even close to ProCharger's ability to rapidly design, prototype and test new compressor models. Lastly, from the engineering group to the production team, from the sales and service staff to the shipping department, ProCharger is comprised of enthusiasts who share your passion for high performance.

## Billet Gear Cases

ProCharger designs and manufactures the centrifugal supercharger industry's only billet gear cases for superior rigidity, durability, sealing and appearance. This helps to support higher boost level and superior overall performance relative to other superchargers, as well as improved performance. Billet gear cases cost more than castings, but are representative of ProCharger's commitment to quality and high performance. Billet is also utilized for brackets, crank pulleys and other components.

These advantages, together with over 25 years of experience, help to explain why ProCharger leads the supercharging industry in patents and documented performance gains—as well as more records and championships in the past 10 years than all of our direct competitors combined.



## The ProCharger Campus

Made in the USA: From concept to finished product, all ProCharger Supercharger Systems are designed, tested and manufactured inside these state-of-the-art facilities.



## Exclusive Billet Impellers

Using state-of-the-art, five-axis CNC machines, ProCharger's proprietary impeller designs are crafted from aircraft-grade 7075 T-6 aluminum alloy for tremendous strength and performance. This top-tier material allows for larger impellers that weigh less, are free of the flaws found in typical cast impellers, and reliably produce more power.

Additionally, the precision bearings used in ProCharger superchargers are of consistently higher-quality and carry higher load ratings than those used by others.

INVENTED, ENGINEERED



AND MADE IN THE USA





# LEADERSHIP THROUGH INNOVATION

ENGINEERED QUALITY AND PERFORMANCE

## State-of-the-Art Test Facility

ProCharger's aerodynamics test lab utilizes state-of-the-art equipment and 3 separate test cells to help ensure that ProCharger superchargers are the best available. This test lab, the industry's largest and most capable, allows ProCharger engineers to simultaneously perform aerodynamic, gear case, and long term durability testing. A hallmark of the company's success has been a thorough understanding of engine dynamics and customer usage on the street, off road, and at the track. This helps ensure that testing in the lab, on the dyno and on the pavement are all representative of real world performance. Additionally, knowledge transferred from Inovair, Accessible Technologies' industrial products division which features gear cases designed for nonstop 24/7 operation and compressor efficiencies exceeding 80%, now helps fuel further advances for ProCharger superchargers.



Watch 3D Video







*Test lab, building #2 of the ProCharger campus*



*Engine dynos, building #1*



*Chassis dyno, building #1*



*Aerodynamic test station, 1 of 6*

## Engineering Excellence

The ProCharger team includes the largest and most capable engineering staff in the aftermarket forced induction industry. For two decades, this highly-skilled and dedicated team has produced the most innovation and greatest number of patents in the industry. Utilizing the latest software, collaboration with OEM auto makers and rapid prototyping, combined with extensive lab and real world testing, ProCharger systems are not only typically first-to-market, but also best-in-class for power-hungry GM car owners.



*ProCharger Vehicle R&D Area, Building #1*

*2nd Chassis dyno*



# UNBRIDLED POWER

## WORD ON THE STREET

“ProCharger can increase the power of a stock LS3 Camaro (or Corvette) by nearly 200 rear-wheel horsepower with no other modifications. The car we tested [otherwise stock 2010 Camaro SS] went from 373 rwhp to 568 [195 rwhp gain] with just 7.5 lbs of pump-gas-friendly boost. . . At the track [with 7.9 psi]. . . our test car with a manual transmission. . . was a full 5.5 [mph, in 1/4 mile] better than the ZL1. That speaks volumes for the efficiency of the ProCharger blower. Don't let anyone tell you all boost is created equal.”

–*Super Chevy*

“My goal was to create a daily driver [2010 Camaro SS] that rode smoothly and would annihilate the tires at will, at any speed, while retaining some form of reasonable fuel mileage and, of course, all the creature comforts such as power windows, a nice stereo, A/C, etc. The project started off with a set of twin GT3582Rs and somewhere along the way, the turbo stuff, all bought and paid for, got shelved and a ProCharger F-1C found its way into the scene.” With the new lungs bolted to the engine, David returned to the engine dyno and walked away with a 1,048 HP pull on just 16 psi.

–*GM High Tech Performance*

“The intercooled ProCharger centrifugal supercharger system [modified engine with F-1A] served up an astonishing 962.6 lb-ft of torque.”

–*Motor Trend*

“Due to its superior efficiency, centrifugal superchargers heat the air less than roots blowers per pound of boost, thus each pound carries more oxygen molecules (something we refer to as greater mass flow). . . [This means] a centrifugal supercharger is capable of supplying more power per pound of boost than a roots blower.”

–*Super Chevy*

“I told my best friend at that moment, that I was going to buy one [’98 Trans Am] and make it the fastest one in the world. Three and a half years later, it was the first one in the eights with a ProCharger. Not long after that he made it into the sevens at 182 mph.”

–*Fastest Street Car*

“Just one romp of the throttle from a standstill, it becomes quite clear that the centrifugal blower is every bit the equal of a roots blower when it comes to low-end grunt.”

–*Popular Hot Rodding*

“Charge air cooling is critical to maximizing horsepower and ProCharger offers two intercooler options for sixth-generation Camaro owners. The new [2016 Camaro] bracket contains key components for the dedicated belt drive system including the idler and tensioner pulley. The bracket's design not only accepts supercharger units up to the F-1A-94, but is also designed to optimize belt wrap and routing.”

–*LSXTV*

“The D-1SC tuner kit provided all of the power potential and extras we would want to make the system reliable as possible during some hard miles”

–*GM High Tech Performance*

“Right from the introduction of the new [2010] Camaro, ProCharger was there, measuring and designing its HO Intercooler system kit. All of its homework paid off to make for a perfect fit and easy install.”

–*Super Chevy*

“With 773 ProCharged horsepower on board, [he] could have hot-pink wheels on his Trans Am and he would still get our attention.” [built 396-cid LS1, ProCharger D-1SC and Twin Highflow Intercooler System]

–*GM High Tech Performance*

“With a goal of 800 HP on the stock block [LS2]—exactly twice the factory rating—the combo's big hitter is a ProCharger Intercooled supercharger kit, which was outfitted at the factory with an upsized D-1SC head unit to facilitate boost levels of up to 12 psi. The excellent ProCharger intercooler keeps the intake-air temperatures from ever exceeding 120 degrees, even when hot-lapped.”

“The boost from the ProCharger is almost instantaneous, and once the cam gets into the heart of the wide torque curve, the car is a handful. Even with the extremely high heat and humidity of Houston, the car has been a paragon of reliability. Whether driving on the clogged arteries to and from Houston or displaying the potential to turn mid-10-second e.t.'s at the local drag strip, this C6 manages the balance between all-out race car and luxury cruiser with aplomb. ProCharger magic raises the stock-block LS2's rear-wheel output from 350 HP to a staggering 706 horses at 6,400 rpm. The torque curve is almost linear in nature and crests at 606 lb-ft at 5,300 rpm.”

–*Vette*





“A centrifugal supercharger is the easiest big horsepower gainer that can be added to an automotive engine. Whether it’s a blow-through carb system or on an EFI-controlled engine, bolting on a ProCharger results in instant performance.”

–*Super Chevy*

“The forced-injection motor uses a ProCharger F-1A supercharger set up to produce 17 psi. How does 835 HP feel behind the wheel of a street-tuned Corvette? “It takes some getting used to. The g-force is breathtaking.”

–*Vette*

“Perhaps the wildest car on the Power Tour, Mike Roy’s ATI ProCharger-urged ‘71 Monte Carlo blew minds on the chassis dyno when it registered an awesome 708 rwhp and 902 lb-ft of torque (975 HP on engine dyno). But that’s nothing compared to the fact this screamer was driven the entire 1,500 mile distance, gulping nothing other than 92-octane pump gas.”

–*Hot Rod*

“I have to say the thing I love the most now is the look you get when pulling up to places and stop lights from people at the amazing sound the F-1A ProCharger makes. It’s awesome ...”

–*GM High Tech Performance*

“Bolting on the ProCharger also increased our gas mileage.”

–*Sport Truck*

“ProCharger is the only gear driven centrifugal blower with self-lubrication. That way you don’t have to tap into your engine’s oil system. Whether it’s for the street or the strip, a supercharger is going to make more power, more safely with an intercooler.”

–*Horsepower TV*

“So, not only do you not have to punch a hole in the oil pan for an oil supply, but the use of the internal oiling system also allows the ProCharger to operate at a cooler temperature, since it’s not circulating hot engine oil through the aluminum housing.”

“The aggressive step-up gearing that drives the impeller also allows the use of larger pulleys to create the same amount of boost as a smaller pulley would in other systems, yet still provide for a generous amount of belt wrap to prevent slippage. ProCharger’s air-to-air intercooler is a maintenance-free unit utilizing a straight-forward approach to intercooling but with some unique engineering built in.”

–*High Performance Pontiac*

“With the ProCharger it is so easy ... just get in and run 8’s like it’s no big deal.”

–*GM High Tech Performance*

“ProCharger’s ‘10 SS Camaro centrifugal blower system comes complete with everything a new Camaro owner needs”

–*Super Chevy*

For the latest independent testing, visit [www.procharger.com/editorial-reviews](http://www.procharger.com/editorial-reviews)



# POWERFUL HISTORY

## TIME LINE OF INNOVATION AND PERFORMANCE

### 1994-1996

ProCharger introduces the first air-to-air intercooled aftermarket supercharger system, featuring the P600 ProCharger supercharger.



ProCharger introduces the first blow-through centrifugal supercharger kit for carbureted Chevy "muscle cars."

State-of-the-art, CNC-machined billet impellers, a ProCharger exclusive, are introduced with the P600B. Designed for use with big blocks and intercooling, the P600B outflowed other street-legal models by more than 65%.



Industry exclusive intercooled supercharger systems for GM F-bodies are introduced by ProCharger, first for the LT1-equipped cars, followed by systems and tuner kits for L98 Tuned Port Injection (TPI) engines. Bolt-on TPI power gains of up to 75% are achieved on quality pump gas.

### 1997-1999



ATI / ProCharger moves into their own, newly-constructed, state-of-the-art manufacturing facility.



ProCharger is the first to be 50 state legal with more than 8 psi of boost, receiving EO D-365 for a 14 psi intercooled system.

ProCharger is the first centrifugal supercharger manufacturer to successfully supercharge marine engines and first to offer intercooling for the extremely demanding marine market.



The ProCharger D-1 is the first race supercharger offered with a warranty and features an over-sized impeller shaft, 4.44:1 step-up ratio and dual support bearings—all ProCharger supercharger exclusives.

### 2000

The first self-contained, gear-driven centrifugal, the P-1SC, is produced. The patented design requires no external oil lines and becomes the industry standard.



An industrial customer uses a D-1 ProCharger to win a U.S. Air Force contract for an aircraft deicing system which utilizes forced air.



The all-new ProCharger F-Series dominate racing, propelling racers into the 7.20's—over one second ahead of competing centrifugals.



Intercooled ProCharger systems for LT1 F-bodies, with 55-60% power gains, demonstrate the power of ProCharger's intercooling leadership.

### 2001-2002



Self-contained ProChargers produce 2,000+ HP on 400 cid Ford small blocks and dominate all others at the racetrack.



In 2001, ProCharger introduces the first air-to-air intercooled supercharger system for the high-tech LS1 Camaro and Firebird, followed closely by the release of industry-leading systems for LS1 and LS6-equipped Corvettes.



ProCharger is the first centrifugal to power racers into the 6's. Three ProCharged racers run 6's in 2001, including Jim Summers.



### 2003-2004

ProCharger's F-3 superchargers firmly establish themselves as the dominant centrifugal supercharger in racing and other ultra-high horsepower applications. The innovative and patented compound bearing and advanced impeller design provide outstanding power and championship-winning consistency.



Having outgrown their existing facility, ProCharger breaks ground on a major building expansion.



ProCharger is first-to-market with intercooled supercharger applications for the Pontiac GTO.



Racers win 5 national championships and set 10 national records using self-contained ProCharger superchargers.



# "ProCharger is the world headquarters of supercharging." *—Bret Kepner, ESPN2*

## 2005-2006

Less than five months after introducing systems for the LS2 GTO, ProCharger releases applications for LS1 powered GTOs. Owners of these great performance cars see horsepower gains of 50 - 55%.



ProCharged versions of the LS1 F-body and LS1 and LS2 GTO earn CARB EO D-365-6, providing a 50-state legal, 600+ HP solution.



ProCharged LS1 Firebirds and Camaros terrorize drag strips all across North America.

ProCharger superchargers make a statement on Discovery Channel's "Monster Garage" by adding insane power to an Army Jeep hot rod puller.



## 2007



After being outlawed for years, a ProCharger racer wins the first centrifugal championship in NHRA competition. ProCharger racers are now producing more than 2,500 HP with gasoline and 3,000 HP using methanol.

A ProCharger-powered Chevrolet racer wins the prestigious HOT ROD Drag Week, earning the title: Fastest Street Car in America.



ProCharger-equipped racers win a record-setting 11 Championships in 2007.



**Performance Product of the Year**

ProCharger Intercooled Supercharger Systems for Harley-Davidson® V-twin engines earn the Performance Product of the Year award.

## 2008-2010

ProCharger continues to dominate the industry, powering 90% of the 100 fastest centrifugally supercharged racers and running nearly two seconds ahead of the nearest competitor.



To accommodate continued growth, ProCharger expands into an adjacent facility, which includes a state-of-the-art test lab.



ProCharger is first-to-market with an air-to-air intercooled supercharger system for the all-new 2010 Camaro SS.



A few months later a ProCharged customer pilots the first 2010 Camaro into the 9's.

ProCharger-power strikes the salt flats of Bonneville: the World's Fastest Camaro sets the record running a ProCharger F-3R.

## 2011-2015

ProCharger racers win an industry-leading 9 national championships in 2015, after winning 22 in the prior 3 years and over 100 championships in the past 15 years



ProCharger begins shipping for the LS7 Z/28, substantially increasing the capabilities of this USA road-race icon.



GM Truck logs 230,000+ on a ProCharger. ProChargers with 50k, 100k, and even 150k miles on them is common, illustrating durability and quality.



ProCharger leads the way once again, with a new state of the art supercharger system for the 2016 Camaro SS



## 2016-2018



ProCharger releases the ZL1 Kit with custom replacement intake manifold for LT4 (and LT1) Engines



ProCharger continues to be featured prominently on TV, and in No Prep Racing



Records are reset across the nation as ProCharger powers the six fastest 6th Gen Camaros and 13 of the 17 fastest C7's. ProCharger's unique combo of high efficiency, durability and upgradability sets the standard.



ProCharged customers deliver record Wins, with numerous 3-sec 1/8 mile and 5-sec 1/4 mile passes. New F-3X model pushes power levels above 3,500 HP, and ProCharger is the first centrifugal supercharger to win a Pro Mod race.



# TERMS AND DEFINITIONS

## ProCharger Complete Systems (Tuning is provided)

- ProCharger HO and Stage II Systems are sold 100% complete with all necessary hardware and tuning required for complete installation unless otherwise noted.
- High Output (HO) and Stage II Intercooled Systems are designed for operation on vehicles with stock engines and stock exhaust.
- Tuning is available for Systems only, and only for vehicles with stock engines with stock exhaust, as well as most “cat-back” exhaust systems.
- Complete systems with tuning provided require a minimum of US 91 octane gas.
- All engine and exhaust modifications must be noted at time of order. ATI is not responsible for boost levels or quality of tune for modified applications.
- Vehicles built for export and other non-US specification vehicles may require custom tuning.
- California approved and 50 state legal products for street legal use (complete systems) will have an associated CARB EO# for compliance. For compliance information, visit <http://www.arb.ca.gov>
- All ProCharger Air-To-Air Intercoolers come standard with a 3 year warranty. New supercharger head units driven by a ProCharger serpentine belt drive come standard with a 12 month warranty. Select ProCharger supercharger system head units are optionally extendable to three years. For additional warranty information contact Technical Services at [TS@ProCharger.com](mailto:TS@ProCharger.com).
- Refer to the official Applications, Specifications and Price Guide for more info at <https://www.procharger.com/catalogs> or call us today at (913) 338-2886.

## ProCharger Tuner Kits

- ProCharger Tuner Kits exclude fuel components, tuning components and computer programming, but are otherwise identical to complete systems.
- HO Intercooled Tuner Kits are designed for stock and modified vehicles.
- Stage II Intercooled Tuner Kits accommodate higher power levels, and are designed for both stock and modified vehicles.
- Race kits and components are intended for off-road/racing use only and may require modifications, trimming, and/or additional components.
- Tuner kits are intended to be dyno-tuned by professional tuners/installers with custom programming.
- All ProCharger Air-To-Air Intercoolers come standard with a 3 year warranty. New supercharger head units driven by a ProCharger serpentine belt drive come standard with a 12 month warranty. Select ProCharger supercharger kit head units are optionally extendable to three years. For additional warranty information contact Technical Services at [TS@ProCharger.com](mailto:TS@ProCharger.com).
- Refer to the official Applications, Specifications and Price Guide for more info at <https://www.procharger.com/catalogs> or call us today at (913) 338-2886.

## Find Your Local ProCharger Dealer

To ensure the best service, ProCharger dealers are required to have experience with high performance forced induction applications, and provide a high level of customer service. Additionally, dealers are also required to have installation facilities and/or a high degree of experience with ProCharger installations. Look up your local ProCharger dealer at [procharger.com/dealer-locator](http://procharger.com/dealer-locator).



# PROCHARGE YOUR LIFE

GET EQUIPPED, GET CONNECTED



## ProCharger Online: Catalogs, Apparel, Branded Items and more!

We invite you to take a tour of ProCharger.com and check out the ProCharger blog, videos page, vehicle gallery, and browse through the many different applications that we have available. If you already own a ProCharger system, you can even create a vehicle gallery with your own ProCharged ride!



While you're there, don't forget to check out the online versions of ProCharger's industry leading catalogs and showcase your pride with a wide assortment of ProCharger branded items. From t-shirts and license plate frames, to gauges and wall clocks, visit [www.ProCharger.com/store](http://www.ProCharger.com/store) to see the latest additions.



## Stay Up to Speed with the ProCharger Blog

Keep up with all the latest news, events and amazing, real-world customer and racer accomplishments via the ProCharger Blog, located at [www.ProCharger.com/blog](http://www.ProCharger.com/blog).





**INVENTED, ENGINEERED AND MADE IN THE USA**



All of us here at ATI encourage you to use your new found ProCharger power responsibly. Please drive safely and be respectful of your fellow motorists. If you feel the need to race, don't do it on the street—take it to the track!

ProCharger® and The Ultimate Power Adder® are registered trademarks of Accessible Technologies, Inc. MerCruiser® is a registered trademark of Brunswick Corporation and is used for descriptive purposes only. Harley-Davidson® is a registered trademark of Harley-Davidson, Inc. and is used for descriptive purposes only.

© Copyright 2018, Accessible Technologies, Inc. 08/18

