

# HEMI

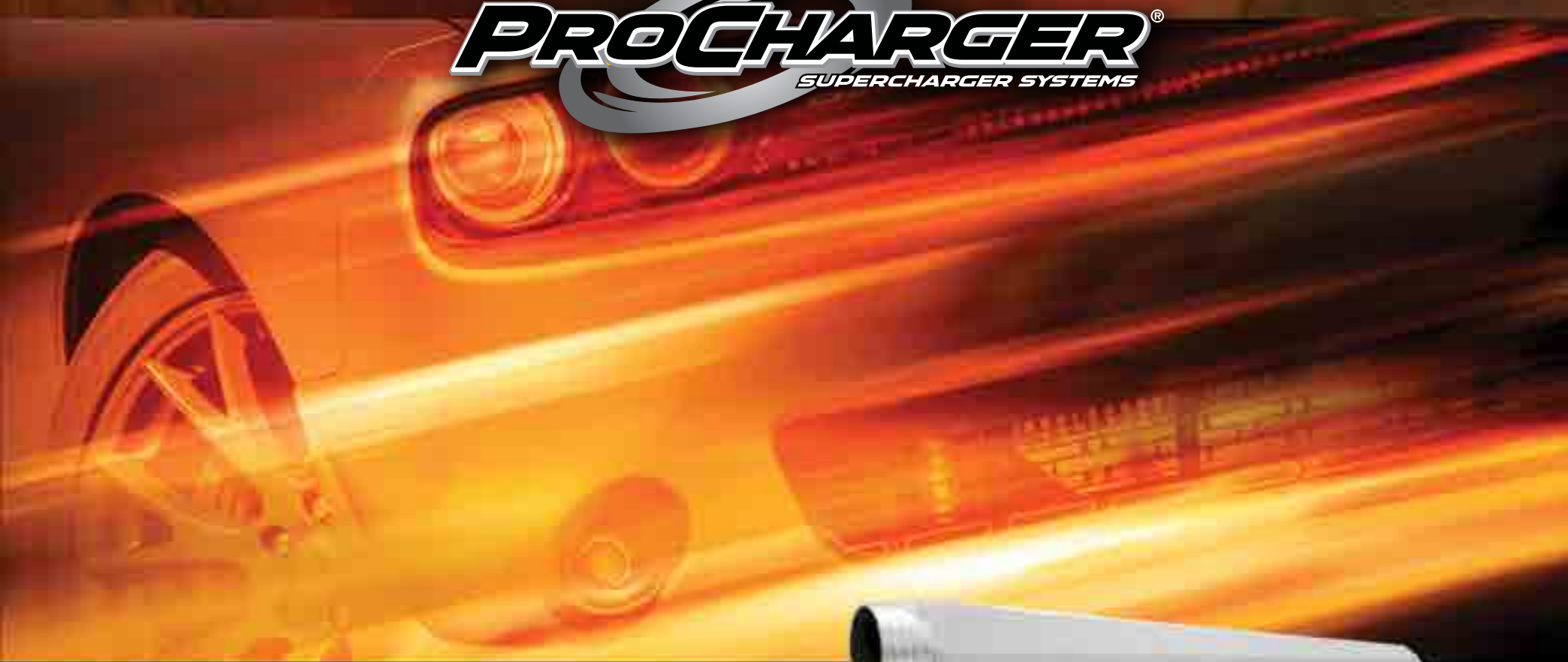

ProCharger Intercooled Supercharger Systems for

**MODERN HEMI  
ENGINES**







**INVENTED, ENGINEERED**



**AND MADE IN THE USA**

**“ProCharger really does their homework, designing powerful supercharger kits that don’t sacrifice drivability or reliability”** *–Mopar Muscle*





# HEMI

## CONTENTS

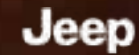
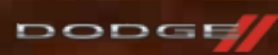

Proven Power and Performance.....	4
Proven Reliability and Drivability.....	6
<b>Automotive Systems</b>	
2020 - 2015 Challenger (6.4).....	8
2014 - 2011 Challenger (6.4).....	10
2020 - 2015 Challenger (5.7).....	12
2014 - 2011 Challenger (5.7).....	13
2010 - 2008 Challenger (6.1/5.7).....	14
2020 - 2015 Charger (6.4).....	16
2014 - 2012 Charger (6.4).....	17
2020 - 2015 Charger (5.7).....	18
2014 - 2011 Charger (5.7).....	19
2010 - 2006 Charger (6.1).....	20
2010 - 2006 Charger (5.7).....	21
2014 - 2012 300 (6.4).....	22
2019 - 2011 300 (5.7).....	23
2010 - 2005 300 (6.1/5.7).....	24
2008 - 2005 Magnum (6.1/5.7).....	25
<b>Jeep and Truck Systems</b>	
2020 - 2012 Grand Cherokee (6.4).....	26
2020 - 2011 Grand Cherokee (5.7).....	27
2010 - 2006 Grand Cherokee (6.1).....	28
2020 - 2012 Wrangler JK/JL/JT (3.6).....	29
2020 - 1996 Ram Truck.....	29
Thermal Advantage.....	32
Intercooling Leadership.....	34
Centrifugal Innovation.....	38
ProCharger F-Series.....	45
Building the Power.....	48
Leadership Through Innovation.....	50
Powerful History.....	52
Additional Applications.....	54

**FOR EARLY MOPAR AND HEMI,  
CALL US TODAY FOR MORE INFO**

# PROVEN POWER AND PERFORMANCE

LARGEST POWER GAINS, COOLEST CHARGE AIR, BEST DRIVABILITY

## Technology and Market Leadership

ProCharger was the first to safely supercharge and intercool HEMI performance cars, and for over 25 years has been producing the industry's largest reliable power gains. With a unique ability to offer cutting edge technology and features, along with the peace of mind associated with cooler charge air temperatures and outstanding engine reliability, ProCharger is the undisputed leader. From the dyno to the street and on the track, ProCharger's engineering and R&D teams go to great lengths to ensure your supercharged and intercooled vehicle is everything you expect and more.

## The Ultimate HEMI Power Adder®

Powerful, purposeful and individualized—hallmarks of so many HEMI's, as well as ProChargers intercooled supercharger systems. Since 1994, many independent tests have documented ProCharged improvements of more than 200 hp and two seconds in quarter-mile performance on a variety of otherwise stock cars. From daily drivers to purpose-built racing machines, once you've experienced the incredible, real-world power of a ProCharger, you'll agree that ProCharger is the Ultimate Power Adder®.

## Cooler Charge Air Temperatures

Among other innovations, ProCharger pioneered the use of air-to-air intercooling, billet impellers and self-contained gear-driven supercharger oiling. ProCharger technology continues to deliver substantial thermal advantages relative to competing products, which in turn produces the coolest charge air temperatures and largest street-legal power gains. Relentless innovation delivers consistent, real world power advantages for countless ProCharger-equipped HEMI owners.

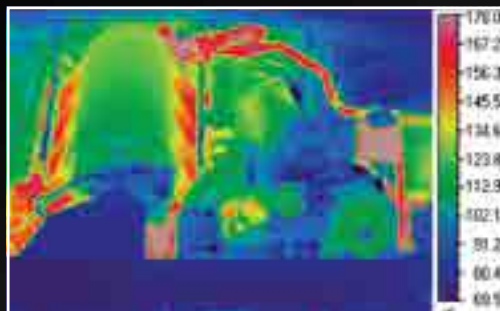

Underhood thermal image shown above. See pages 32-33 for additional information and thermal images.

## Powerful, Efficient and Reliable

A ProCharger Intercooled Supercharger System can add best-in-class power gains to your performance vehicle with no additional engine modifications, special fuels or extended cool-down times. ProCharger systems and kits are designed to be installed on completely stock or modified engines, and offer a very cost effective and customer-friendly upgrade path for those wanting to turn up the power further. Mild to wild, regardless of your power goals and aspirations, ProCharger can help you reach them.

## Unmatched Quality & Warranty Coverage

For more than 2 decades, ProCharger has designed and manufactured its own superchargers and complete systems (unlike some competitors who buy head units and components elsewhere and are really just assembling kits). This helps to ensure that ProCharger delivers a high quality, high performance product designed specifically for your needs. In-house design and production capabilities allow ProCharger to provide industry-best warranty protection, with a 3-year warranty standard for intercoolers, and a 3-year extended warranty available for supercharger head units.

## Fuel-Mileage Friendly

Beyond overall power and performance, centrifugal forced induction is also the most fuel efficient form of high performance. Rising fuel costs and government regulation have prompted performance enthusiasts to think about fuel economy along with horsepower. It's no secret that ProCharger systems not only produce the big power numbers we all crave, but under normal operating conditions, owners report very little effect on fuel mileage and in some cases, actually improved fuel economy.

## Superior Drivability

With millions of boost-enhanced miles under their tires, ProCharged vehicle owners enjoy the best of both worlds: incredible power with everyday reliability and drivability. With the factory provided torque and throttle responses of HEMI engines, the power curve of Intercooled ProCharger technology produces a vastly superior driving experience, relative to positive displacement superchargers or turbochargers.



**“The real magic, of course, comes from the ProCharger centrifugal supercharger. Which specific blower model used depends on how fast you want to go.”** *–HOT ROD Magazine*



# PROVEN RELIABILITY AND DRIVABILITY

BOLT ON THE LARGEST, STREET-LEGAL POWER GAINS IN THE INDUSTRY

## Engine-Friendly Boost

With industry leading technology, and supercharger and intercooler mounting locations which minimize engine compartment heat transfer, Intercooled ProCharger systems have proven to be the most engine friendly type of forced air induction for HEMIs. Due to the highly efficient system design, ProCharger systems produce more power with less boost and heat, and can also safely run higher boost and power levels than competing designs. No internal engine modifications, no special fuels—just incredible power gains and the best engine reliability.

## 100% Complete Systems

Unless otherwise noted, ProCharger supercharger systems are 100 percent complete—nothing else to purchase. Our intercooled supercharger systems come with all the components needed for an attractive, OEM-quality installation. Install it yourself or have your ProCharger dealer install it for you. The choice is yours.

## ProCharger System Advantages and Choices

ProCharger offers more supercharger, drive system, intercooler, bypass valve and fuel system choices and upgrades than anyone. In addition to options that improve the performance of your vehicle, ProCharger and your ProCharger dealer are the ultimate solution for virtually any engine combination. Whether for your car, truck, SUV, V-twin motorcycle, UTV or boat, no one meets your needs better than ProCharger.

## OEM Appearance & Quality

When it comes to the finished installation, ProCharger systems feature an outstanding “from the factory” look. ProCharger also utilizes the most advanced quality assurance equipment, and all precision assembly and testing is performed on-site. A clean, professional and neatly integrated finished installation means this is a supercharger system that you will be proud to show off every chance you get.

## Resources, Experience and Service Excellence

All ProCharger systems are engineered in-house using state-of-the-art equipment, with component testing occurring in the industry’s largest and most capable test lab. This is followed with system testing by a dedicated team of engineers and technicians on the largest R&D fleet of vehicles. System testing is performed on the dyno, on the street and at the track. This diligence results in the most advanced, engine-safe and durable supercharger systems. Combined with world-class manufacturing, technical and customer service, along with unmatched performance and over 25 years of industry leadership, the choice is clear: ProCharger.

## Best Dealer Network

ProCharger has an extensive network of independent dealers across North America and around the world that specialize in installing and fine-tuning the supercharger system on your vehicle; and just like the supercharger systems they install, ProCharger dealers are the best in the business when it comes to helping you realize your performance goals and aspirations.

## Installation Simplicity

The basic system design of a ProCharger system minimizes heat transfer by placing the supercharger and intercooler in a fresh air stream rather than on top of the engine or attached to the exhaust. This superior design also simplifies installation. The benefits of self-contained oiling are similar—no heat transfer from engine oil, no need to punch a hole in the oil pan, and no need to run oil feed and drain lines. There is also no need to remove or replace the engine intake manifold and no air-to-water intercooler complexity. Thanks to no major modifications, your car can even be returned to stock condition if desired.

**INVENTED, ENGINEERED**



**AND MADE IN THE USA**



**“Thanks to the highly efficient air-to-air intercooler design, the kit can make more power with less boost and heat.”** *–Mopar Muscle*

**ProCharger: The ULTIMATE Power Adder®**

With power, reliability and quality far superior to other forced-air induction systems, ProCharger Intercooled Supercharger Systems and Tuner Kits are excellent ways to add even more power to your performance vehicle. ProCharger supercharger systems and tuner kits feature a visually appealing “from the factory” look, easy installation and minimal relocation of components. The self-contained supercharger requires no external oil feed or return lines while the front-mounted air-to-air intercooler avoids the complexity and maintenance issues of an air-to-water-to-air intercooler.



Gen III HEMI 1/4 Mile Record, 6.69 @ 211 MPH



Visit [ProCharger.com](http://ProCharger.com) for the latest videos, blog updates and additional information

# CHALLENGER 6.4

2020 - 2015

*HO Intercooled System with P-1SC-1, optional black finish shown*



**BOLT ON 215+ MORE HORSEPOWER**

*“Cooler air makes more power—period. With the ProCharger Kit, those numbers jumped to 616.86 RWHP [otherwise stock 392 HEMI, automatic transmission, race intercooler] ... and with just 7-pounds of boost.”*

**—Mopar Muscle**



## Industry Leading Power Gains

ProCharger was the first manufacturer to safely supercharge the late-model HEMI platform—the first to offer complete supercharger systems for 6.4L/392 and the first to supercharge the 6.1 and 5.7 HEMI's back in 2007. With continued industry and HEMI leadership, ProCharger leads once again for 2015+ Dodge Challengers equipped with the 6.4L (392) HEMI. Power gains of over 215 HP are possible on standard premium pump gas, putting power output of the 6.4L (392) engines at more than 700 HP with the optional race intercooler. This rivals the Dodge Hellcat at a fraction of the price, with only 7 psi of highly efficient, engine-friendly boost.

## ProCharger HO Systems and Tuner Kits

Intercooled ProCharger Systems produce vastly superior repeatability and drivability. This technology delivers unmatched power gains with a conservative 7 psi and a relatively quick and simple bolt-on installation. Systems contain a handheld programmer with proven tuning calibration, larger fuel injectors and a larger fuel pump. With an Intercooled Tuner Kit and custom tuning performed by a local dealer, higher boost levels and power gains are possible.

## Maximum Performance and Reliability

Intercooled ProCharger Systems provide the coolest charge air temperatures, largest power gains and most repeatable performance available. ProCharger's 6.4L Systems and Tuner Kits feature the industry standard P-1SC-1 ProCharger, with self-contained oiling, billet impeller and billet gear case standard. Highly effective and reliable air-to-air intercooling combines with an advantaged mounting location and best-in-class supercharger efficiency to minimize heat production and transfer, and maximize reliable power gains.





### ProCharger Stage II Systems

The ProCharger Stage II Supercharger offering features an 8-rib dedicated drive system with the option of a race intercooler upgrade. ProCharger designed this dedicated 8-rib system to have maximum belt wrap in order to support the truly power hungry. The bracket system fits head units up to the F-1A-94 without modifications to the car, which means no cutting or trimming with a blower that can support 1,200+ HP! Even though this system is perfect for "race" applications, it can still be used with a P-1SC-1 at lower boost levels for mild street applications.

### Intercooler Options

ProCharger also offers a Race Intercooler option for HO and Stage II Intercooled Systems which produces higher horsepower and cooler charge air temperatures. No trimming or cutting is required to fit this highly effective intercooler behind the bumper, thanks to a custom ProCharger design built just for this application. That's great news for anyone who may want to eventually return their car to stock. This optional intercooler also produces cooler charge air temperatures and larger power gains on stock engines.



RACE INTERCOOLER

3 CORE INTERCOOLER



### ProCharger 2015+ Challenger Systems & Tuner Kits

- HO Intercooled System and Tuner Kit with P-1SC-1
- Stage II Intercooled System and Tuner Kit (dedicated 8-rib drive)

### ProCharger 2015+ Challenger Choices & Upgrades

- Satin, Polished, or Black supercharger and bracket finish
- Helical Gearset for noise reduction (P-series and D-series only)
- Tuner Kits allow for D-1SC up to F-1A-94 upgrades
- Race Intercooler upgrade (from HO intercooler)
- Race Bypass Valve upgrade available



# CHALLENGER 6.4

2014–2011



*HO Intercooled System with P-1SC-1, optional polished finish shown*



**200+ MORE HP WITH STOCK 392**

*“ProCharger’s been doing this for a long time and they’ve got it dialed in.”*

*–GearzTV*

## **Engineered Power**

ProCharger systems and kits are painstakingly designed to be installed onto completely stock or modified engines with no major modifications to the vehicle. Under the hood, the installed kit looks like it could have come from the factory, while the large front-mounted intercooler lets others know this is not your average Challenger.

## **ProCharger HO Systems and Tuner Kits**

Intercooled ProCharger Systems and Tuner Kits for 2011-14 6.4L SRT8 Challengers offer a gain of 200+ horsepower with a conservative 7 psi, on otherwise stock engines. This industry leading technology provides the coolest charge air temperatures, largest power gains and most repeatable performance available. For those wanting to purchase a tuner kit and have custom tuning performed by a local dealer, gains can exceed 225+ HP.

ProCharger’s 6.4L/392 systems and tuner kits feature the industry standard P-1SC-1 ProCharger, with self-contained oiling, billet impeller and billet gear cases. This kit also features highly effective and reliable air-to-air intercooling, which combines with an advantaged mounting location and best in class supercharger efficiency to minimize heat production and heat transfer, and maximize reliable power gains.

## **Easy Install and 100% Reversible**

The ProCharger engineering staff works hard to ensure that not only will your supercharger system be easy enough to install in a home garage with an OEM fit and finish, but also that it leaves no permanent changes to the automobile, like cutting or trimming of body parts. This gives you the piece of mind that installing the Ultimate Power Adder won’t affect the resale or trade-in value. Need help with installation? ProCharger also has a vast network of experienced installing dealers all across the USA.





**Systems and Tuner Kits are Fully Compatible with Shaker Hoods and Strut Bars**



## ProCharger Stage II Systems

The ProCharger Stage II Supercharger offering features an 8-rib dedicated drive system with the option of a race intercooler upgrade. The bracket system fits head units up to the F-1A-94 without modifications to the car, which means no cutting or trimming with a blower that can support 1,200+ HP! Even though this system is perfect for "race" applications, it can still be used with a P-1SC-1 at lower boost levels for mild street applications.

## Intercooler Options

ProCharger also offers a Race Intercooler option for HO and Stage II Intercooled Systems which produces higher horsepower and cooler charge air temperatures. No trimming or cutting is required to fit this highly effective intercooler behind the bumper, thanks to a custom ProCharger design built just for this application. This intercooler option also produces cooler air and larger power gains on stock engines.

***P-1SC-1, Race Intercooler, 7 psi, Otherwise Stock, Full Weight, Pump Gas***



***Above: Stage II Intercooled System with 8-rib Dedicated Drive and Race Intercooler Upgrade***

## ProCharger 2014-11 Challenger Systems & Tuner Kits

- HO Intercooled System and Tuner Kit with P-1SC-1
- Stage II Intercooled System and Tuner Kit with P-1SC-1 (dedicated 8-rib drive)

## ProCharger 2014-11 Challenger Choices & Upgrades

- Satin, Polished, or Black supercharger and bracket finish
- Helical Gearset for noise reduction (P-series and D-series only)
- Tuner Kits allow for D-1SC up to F-1A-94 upgrades
- Race Intercooler upgrade (from HO intercooler)
- Race Bypass Valve upgrade available

# CHALLENGER 5.7

2020 - 2015



HO Intercooled System with P-1SC-1, optional satin finish shown



## BOLT ON 160+ MORE HP

*"Assuming you have your tools laid out and dive right in, you could be up and running with over 500 hp ... in about five hours. Just try and tell us that doesn't sound appealing." –GearzTV*

### ProCharger Leads the Pack

ProCharger was the first manufacturer to offer complete supercharger systems for 6.1L and 5.7L HEMI's back in 2007. With continued industry and HEMI leadership, ProCharger leads once again for 2015+ 5.7L R/T Dodge Challengers. Proven Intercooled ProCharger Systems and Tuner Kits for 5.7L HEMI's produce a gain of 160+ HP with only 7 psi on otherwise stock engines running premium pump gas.

### ProCharger HO Systems and Tuner Kits

Intercooled ProCharger Systems provide the coolest charge air temperatures, largest power gains and most repeatable performance available. ProCharger's 5.7L systems and tuner kits for Challengers feature the industry standard P-1SC-1 ProCharger, with self-contained oiling that eliminates the need for external oil lines or the need to tap into the engine's oil supply. This kit features highly effective and reliable air-to-air intercooling (3 core intercooler is standard), and your choice of supercharger gearset: standard or the helical gearset option for lower supercharger noise levels. You also have your choice of multiple finishes—satin, polished, or black finish—and Systems and Tuner Kits are available for models with Shaker hoods and strut bars.

**HAVE A 3.6L CHALLENGER?  
CALL US TODAY FOR MORE INFO!**

### 2015+ Challenger 5.7L Systems & Tuner Kits

- HO Intercooled System with P-1SC-1
- HO Intercooled Tuner Kit with P-1SC-1

### 2015+ Challenger 5.7L Options & Upgrades

- Satin, Polished, or Black supercharger and bracket finish
- Helical Gearset for noise reduction (P-series and D-series only)
- Tuner Kits allow for D-1SC up to F-1A-94 upgrades
- Race Intercooler upgrade (from HO intercooler)
- Race Bypass Valve upgrade available





# CHALLENGER 5.7

2014–2011



HO Intercooled System with P-1SC-1, optional polished finish shown



**160+ MORE HP ON PUMP GAS**

*“Essentially, you can go out and find a bargain on a '09-14 5.7L Hemi car, load it up with a ProCharger kit, and run down the bigger engines with ease.” –HotRod.com*

Building on our late-model, EFI HEMI® supercharging leadership, ProCharger has complete HO systems for 5.7L HEMI R/T Challengers, utilizing a shared drive arrangement and an innovative air-to-air intercooler configuration.

## ProCharger HO Systems and Tuner Kits

Proven Intercooled ProCharger Systems and Tuner Kits for 2014-11 5.7L Challengers produce a gain of 160+ HP with a conservative 7 psi while running premium pump gas. For those wanting to purchase a tuner kit and have custom tuning performed by a local dealer, higher gains are possible on modified engines. Systems and Tuner Kits are fully compatible for models with Shaker hoods and strut bars.

ProCharger's 5.7L systems and tuner kits feature the industry-standard P-1SC-1 ProCharger, with self-contained oiling, billet impeller and billet gear cases. This kit also features highly effective and reliable air-to-air intercooling, which combines with an advantaged mounting location and best in class supercharger efficiency to minimize heat production and heat transfer, and maximize reliable power gains. 5.7L HEMI R/T HO Systems are 100% complete and include fuel injectors as well as a handheld programmer.

**HAVE A 3.6L CHALLENGER?  
CALL US TODAY FOR MORE INFO!**

## 2014-11 Challenger 5.7L Systems & Tuner Kits

- HO Intercooled System with P-1SC-1
- HO Intercooled Tuner Kit with P-1SC-1

## 2014-11 Challenger 5.7L Options & Upgrades

- Satin, Polished, or Black supercharger and bracket finish
- Helical Gearset for noise reduction (P-series and D-series only)
- Tuner Kits allow for D-1SC up to F-1A-94 upgrades
- Race Intercooler upgrade (from HO intercooler)
- Race Bypass Valve upgrade available



# CHALLENGER 6.1

2010–2008



HO Intercooled System with P-1SC-1, optional polished finish shown



## BOLT ON 160+ MORE HP

*“What makes the ProCharger system so appealing to many Challenger owners in addition to the instant addition of 200 more horsepower is that installation is easy and straight forward.”*

*-Street Muscle Magazine*

### 2010-08 Challenger 6.1L Systems & Tuner Kits

- HO Intercooled System and Tuner Kit with P-1SC-1
- Stage II Intercooled System and Tuner Kit with P-1SC-1 (dedicated 8-rib drive)
- HEMI Reverse Cog Race Kit with F-1D, F-1, or F-1A

### 2010-08 Challenger 6.1L Options & Upgrades

- Satin, Polished, or Black supercharger and bracket finish
- Helical Gearset for noise reduction (P-series and D-series only)
- Tuner Kits allow for D-1SC up to F-1A-94 upgrades
- Race Bypass Valve upgrade available



### The Ultimate HEMI Power Adder

ProCharger has two complete intercooled systems for the awesome 6.1L HEMI Challengers—a shared-drive HO Intercooled System (left) and dedicated-drive Stage II Intercooled System (below).

### ProCharger HO and Stage II Intercooled Systems

Both the HO and Stage II systems allow SRT8 Challenger owners to experience nearly 600 HP in these modern Mopar® muscle cars. Both systems utilize the patented, proven and self-contained P-1SC-1 ProCharger, a 3-core air-to-air intercooler, OEM-quality mounting brackets, larger fuel injectors, a fuel-pump and all necessary supercharger and intercooler tubes for installation onto SRT8 Challengers with no major modifications to your car or engine. They also utilize a handheld programmer to upload the ProCharger tune. Both the HO Intercooled and Stage II Intercooled Systems add more than 160 horsepower on stock 6.1L HEMIs running premium pump gas.

### HEMI Reverse Cog Race Kits

ProCharger also has Reverse Cog Race Kits for modified 6.1L HEMI engines. Designed for custom, ultra-high HP racing applications, the race kit features a F-1D, F-1 or F-1A, 50 mm cog drive, and tensioner.



# CHALLENGER 5.7

2010–2008



*HO Intercooled System with P-1SC-1, optional polished finish shown*



**130+ MORE HP ON PUMP GAS**

*“Once installed, the supercharger and related bracket and components look as if they could have been installed at the factory.” –Mopar Muscle*

## ProCharger HO Systems and Tuner Kits

The HO system for 5.7L Challengers utilizes the patented, proven and self-contained P-1SC-1 ProCharger, a 3-core air-to-air intercooler, OEM-quality mounting brackets, larger fuel injectors and all necessary supercharger and intercooler tubes for installation onto Dodge Challengers with no major modifications to your car or engine. ProCharger systems for the 5.7L HEMI Challengers utilize a handheld tuner to upload the ProCharger tune.

The HO Intercooled System adds more than 130 horsepower when installed onto the stock 5.7L HEMI engine while running premium pump gas. Thanks to the largest power gains and coolest charge air temperatures in the industry, no other forced induction system for the Challenger even comes close. These Challenger systems also feature a visually appealing, “from the factory” look and come with a standard 3-year warranty on the intercooler and 1-year warranty on the supercharger (Optional 3-year supercharger warranty is available).

## 2010-08 Challenger 5.7L Systems & Tuner Kits

- HO Intercooled System with P-1SC-1
- HO Intercooled Tuner Kit with P-1SC-1

## 2010-08 Challenger 5.7L Options & Upgrades

- Satin, Polished, or Black supercharger and bracket finish
- Helical Gearset for noise reduction (P-series and D-series only)
- Tuner Kits allow for D-1SC up to F-1A-94 upgrades
- Race Bypass Valve upgrade available



# CHARGER 6.4

2020 - 2015



HO Intercooled System with P-1SC-1, optional black finish shown



## BOLT ON 215+ MORE HORSEPOWER

*"Their centrifugal superchargers and associated hardware have outstanding fit and finish, and mount under the hood for a clean, OEM look." –Mopar Muscle*

### 2015+ Charger 6.4L Systems & Tuner Kits

- HO Intercooled System with P-1SC-1
- HO Intercooled Tuner Kit with P-1SC-1
- Stage II Intercooled System and Tuner Kit with P-1SC-1 (dedicated 8-rib drive)

### 2015+ Charger 6.4L Choices & Upgrades

- Satin, Polished, or Black supercharger and bracket finish
- Helical Gearset for noise reduction (P-series and D-series only)
- Tuner Kits allow for D-1SC up to F-1A-94 upgrades
- Race Intercooler upgrade (from HO intercooler)
- Race Bypass Valve upgrade available

### ProCharger HO Systems and Tuner Kits

ProCharger offers intercooled supercharger systems and tuner kits for 2015+ 6.4L HEMI powered Chargers. ProCharger HO Systems and Tuner Kits offer a gain of 200+ HP with only 7 psi, and 215+ HP with the optional race intercooler upgrade. That's 700+ HP with a single bolt-on!

### ProCharger Stage II Systems

The ProCharger Stage II Supercharger offering features an 8-rib dedicated drive system with the option of a race intercooler upgrade. ProCharger designed this dedicated 8-rib system to have maximum belt wrap in order to support the truly power hungry. The bracket system fits head units up to the F-1A-94 without modifications to the car, which means no cutting or trimming with a blower that can support 1,200+ HP! Even though this system is perfect for "race" applications, it can still be used with a P-1SC-1 at lower boost levels for mild street applications.

Systems and Tuner kits feature the patented and proven, self-contained P-1SC-1 supercharger, a highly effective air-to-air intercooler and the ability to be bolted directly to a stock HEMI engine with no additional modifications. When it comes to providing safe and reliable performance, ProCharger leads the industry with thoroughly-tested and proven supercharger solutions for late-model HEMI's.





# CHARGER 6.4

2014–2012



HO Intercooled System with P-1SC-1, optional polished finish shown



## BOLT ON 200+ MORE HORSEPOWER

*"Why did we select ProCharger?... They have been the leading aftermarket supercharger manufacturer for 25 years, and their products are some of the best engineered, reliable, and powerful on the market." –Hot Rod*

### ProCharger HO Systems and Tuner Kits

Intercooled ProCharger Systems and Tuner Kits for 2014-12 6.4L SRT8 Chargers offer a gain of 200+ horsepower with a conservative 7 psi. This industry leading technology provides the coolest charge air temperatures, largest power gains and most repeatable performance available. For those wanting to purchase a tuner kit and have custom tuning performed by a local dealer, higher gains are possible on modified engines.

ProCharger's 6.4L/392 systems and tuner kits feature the P-1SC-1 ProCharger, with self-contained oiling, billet impeller and billet gear cases. This kit also features highly effective and reliable air-to-air intercooling, which combines with an advantaged mounting location and best in class supercharger efficiency to minimize heat production and heat transfer, and maximize reliable power gains.

### Easy Bolt-On Installation

The ProCharger engineering staff works hard to ensure that not only will your supercharger system be easy enough to install in a home garage with an OEM fit and finish, but also that it leaves no permanent changes to the automobile, like cutting or trimming of body parts. This gives you the piece of mind that installing the Ultimate Power Adder won't affect the resale or trade-in value.

### 2014-12 Charger 6.4L Systems & Tuner Kits

- HO Intercooled System with P-1SC-1
- HO Intercooled Tuner Kit with P-1SC-1

### 2014-12 Charger 6.4L Choices & Upgrades

- Satin, Polished, or Black supercharger and bracket finish
- Helical Gearset for noise reduction (P-series and D-series only)
- Tuner Kits allow for D-1SC up to F-1A-94 upgrades
- Race Intercooler upgrade (from HO intercooler)
- Race Bypass Valve upgrade available



# CHARGER 5.7

2020 - 2015

*HO Intercooled System with P-1SC-1, optional polished finish shown*



## BOLT ON 160+ MORE HP

*"That is an addition of 134 hp and 110 lb-ft of torque at the rear wheels! Not bad for a couple hours of wrenching in your garage." –Mopar Muscle*

### 2015+ Charger 5.7L Systems & Tuner Kits

- HO Intercooled System with P-1SC-1
- HO Intercooled Tuner Kit with P-1SC-1

### 2015+ Charger 5.7L Options & Upgrades

- Satin, Polished, or Black supercharger and bracket finish
- Helical Gearset for noise reduction (P-series and D-series only)
- Tuner Kits allow for D-1SC up to F-1A-94 upgrades
- Race Intercooler upgrade (from HO intercooler)
- Race Bypass Valve upgrade available



### ProCharger HO Systems and Tuner Kits

Proven Intercooled ProCharger Systems and Tuner Kits are available for 2015+ 5.7L Dodge Chargers. This industry leading technology produces a gain of 160+ HP with a conservative 7 psi. For those wanting to purchase a tuner kit and have custom tuning performed by a local dealer, higher gains are possible on modified engines.

Intercooled ProCharger Systems provide the coolest charge air temperatures, largest power gains and most repeatable performance available. ProCharger's 5.7L systems and tuner kits feature the industry standard P-1SC-1 ProCharger, with self-contained oiling, billet impeller and billet gear cases standard. This kit also features highly effective and reliable air-to-air intercooling, which combines with an advantaged mounting location and best in class supercharger efficiency to minimize heat production and heat transfer, and maximize reliable power gains.

With continued industry and HEMI leadership, ProCharger leads once again for the Dodge and Chrysler HEMI's.

**HAVE A 3.6L CHARGER?  
CALL US TODAY FOR MORE INFO!**





# CHARGER 5.7

2014-2011

*HO Intercooled System with P-1SC-1, optional polished finish shown*



**160+ MORE HP ON PUMP GAS**

*"With reliability, quality and power far superior to other forced-air induction systems, ProCharger Systems and Tuner Kits are excellent ways to add even more power to these modern HEMI powerhouses." -autoblog*

## 2014-11 Charger 5.7L Systems & Tuner Kits

- HO Intercooled System with P-1SC-1
- HO Intercooled Tuner Kit with P-1SC-1

## 2014-11 Charger 5.7L Options & Upgrades

- Satin, Polished, or Black supercharger and bracket finish
- Helical Gearset for noise reduction (P-series and D-series only)
- Tuner Kits allow for D-1SC up to F-1A-94 upgrades
- Race Bypass Valve upgrade available



Building on our late-model, EFI HEMI® supercharging leadership, ProCharger has complete HO systems for 5.7L HEMI R/T Chargers, utilizing a shared drive arrangement and an innovative air-to-air intercooler configuration.

## ProCharger HO Systems and Tuner Kits

Proven Intercooled ProCharger Systems and Tuner Kits for 2014-11 5.7L Chargers produce a gain of 160+ HP with a conservative 7 psi while running premium pump gas. For those wanting to purchase a tuner kit and have custom tuning performed by a local dealer, higher gains are possible on modified engines.

ProCharger's 5.7L systems and tuner kits feature the industry-standard P-1SC-1 ProCharger, with self-contained oiling, billet impeller and billet gear cases standard. This kit also features highly effective and reliable air-to-air intercooling, which combines with an advantaged mounting location and best in class supercharger efficiency to minimize heat production and heat transfer, and maximize reliable power gains. 5.7L HEMI R/T HO Systems are 100% complete and include fuel injectors as well as a handheld programmer. Tuner Kits exclude programmer and fuel system components.

**HAVE A 3.6L CHARGER?  
CALL US TODAY FOR MORE INFO!**



# CHARGER 6.1

2010–2006



*HO Intercooled System with P-1SC-1, optional polished finish shown*



**BOLT ON 160+ MORE HP**

*“What else would you call a daily driven Chrysler sedan capable of 10.01 quarter-mile time slips?” -Mopar Muscle*

## 2010-06 Charger 6.1L Systems & Tuner Kits

- HO Intercooled System and Tuner Kit with P-1SC-1
- Stage II Intercooled System and Tuner Kit with P-1SC-1 (dedicated 8-rib drive)
- HEMI Reverse Cog Race Kit with F-1D, F-1, or F-1A

## 2010-06 Charger 6.1L Options & Upgrades

- Satin, Polished, or Black supercharger and bracket finish
- Helical Gearset for noise reduction (P-series and D-series only)
- Tuner Kits allow for D-1SC up to F-1A-94 upgrades
- Race Bypass Valve upgrade available



## The Ultimate HEMI Power Adder for 6.1L HEMI

ProCharger has two complete intercooled systems for the awesome 6.1L HEMI Chargers—a shared-drive HO Intercooled System (left) and dedicated-drive Stage II Intercooled System (below).

## ProCharger HO and Stage II Intercooled Systems

Both the HO and Stage II systems allow SRT8 Charger owners to experience what 585+ HP feels like in these modern Mopar® muscle cars. Both systems utilize the patented, proven and self-contained P-1SC-1 ProCharger, a 3-core air-to-air intercooler, OEM-quality mounting brackets, larger fuel injectors, a fuel-pump and all necessary supercharger and intercooler tubes for installation onto SRT8 Chargers with no major modifications to your car or engine. They also utilize a handheld tuner to upload the ProCharger tune. Both the HO Intercooled and Stage II Intercooled Systems add more than 160 horsepower on stock 6.1L HEMIs running premium pump gas.

## HEMI Reverse Cog Race Kits

ProCharger also has Reverse Cog Race Kits for modified 6.1L HEMI engines. Designed for custom, ultra-high HP racing applications, the race kit features a F-1D, F-1 or F-1A, 50 mm cog drive, and tensioner.



# CHARGER 5.7

2010–2006



*HO Intercooled System with P-1SC-1, optional polished finish shown*



**130+ MORE HP ON PUMP GAS**

*“ProCharger has become an industry leader in self-contained supercharger applications.”*

*–Mopar Enthusiast*

## 2010-06 Charger 5.7L Systems & Tuner Kits

- HO Intercooled System and Tuner Kit with P-1SC-1
- Stage II Intercooled System and Tuner Kit with P-1SC-1 (dedicated 8-rib drive, 2006-2008 models only)

## 2010-06 Charger 5.7L Options & Upgrades

- Satin, Polished, or Black supercharger and bracket finish
- Helical Gearset for noise reduction (P-series and D-series only)
- Tuner Kits allow for D-1SC up to F-1A-94 upgrades
- Race Bypass Valve upgrade available

## 5.7L HEMI Dominance

ProCharger has two complete intercooled systems for the awesome 5.7L HEMI Chargers—a shared-drive HO Intercooled System (left) and dedicated-drive Stage II Intercooled System (shown below).

## ProCharger HO and Stage II Intercooled Systems

The HO and Stage II systems allow R/T Charger owners to gain 130+ HP on their 2010-09 5.7L VCT HEMI Charger, or 110+ HP with 2008-06 5.7L engines. Both systems utilize the patented, proven and self-contained P-1SC-1 ProCharger, a 3-core air-to-air intercooler, OEM-quality mounting brackets, larger fuel injectors and all necessary supercharger and intercooler tubes for installation onto R/T Chargers with no major modifications to your car or engine. They also utilize a handheld tuner to upload the ProCharger tune.

Both the HO Intercooled and Stage II Intercooled Systems can add more than 110/130 horsepower on stock 5.7L HEMI Chargers running premium pump gas. Even higher boost and power levels are possible on stock and modified engines with a Tuner Kit and custom programming.



# 300 6.4

2014–2012



*HO Intercooled System with P-1SC-1, optional polished finish shown*



## BOLT ON 200+ MORE HORSEPOWER

*“Because of the similar Hemi engine platforms between Jeep, Dodge Challenger and Chargers, Ram trucks, and Chrysler 300c’s, the install time is about the same for all of them. Right at 8-10 hours.” –Engine Power*

### 2014-12 300 6.4L Systems & Tuner Kits

- HO Intercooled System with P-1SC-1
- HO Intercooled Tuner Kit with P-1SC-1

### 2014-12 300 6.4L Options & Upgrades

- Satin, Polished, or Black supercharger and bracket finish
- Helical Gearset for noise reduction (P-series and D-series only)
- Tuner Kits allow for D-1SC up to F-1A-94 upgrades
- Race Bypass Valve upgrade available

### ProCharged Wolf in Sheep’s Clothing

Classy, luxurious and now, even faster! ProCharger is proud to offer an Intercooled Supercharger system for the 2014-12 Chrysler 300C equipped with the 6.4L Hemi engines. Expect horsepower gains of 200+ with an HO Intercooled System on pump gas and only 7 psi of intercooled boost!

### Power Without Compromise

Thanks to the industry’s coolest charge air temperatures and largest power gains, no other supercharger system for the Chrysler 300C even comes close. With ProCharger’s patented and proven self-contained P-1SC-1 supercharger and a high-performance air-to-air intercooler system, unmatched power is delivered with maximum reliability and a relatively simple, bolt-on installation with standard hand tools.

The HO Intercooled System is 100% complete, with fuel injectors and innovative handheld programmer included. Tuner Kits exclude programmer and fuel system components.





# 300 5.7

2019-2011



HO Intercooled System with P-1SC-1, optional black finish shown



## BOLT ON 160+ MORE HORSEPOWER

*"Like a top fuel Hemi "boilin' the hides; this 300c is a serious muscle car." –Mopar Muscle*

### ProCharger Complete Intercooled Systems

For those searching for the ultimate sleeper, ProCharger offers complete intercooled systems for the 2019-11 5.7L 300 sedans adding 160+ HP to the potent 5.7L V8 for over 520+ HP. That's more power than a stock Camaro, Mustang, or 392 Challenger/Charger!

The P-1SC-1 complete intercooled system is a bolt-on design that comes complete with step-by-step instructions and all of the fuel system, tuning and supercharger components needed for install. The patented and proven self-contained supercharger design is self-lubricated, so you don't have to tap into the engine's oil pan. ProCharger systems also retain an OEM-like appearance, providing smooth, consistent, repeatable power to the vehicle's stock drivetrain with no additional vehicle modifications required.

For an even stealthier approach, the P-1SC-1 systems and tuner kits are available with an optional Helical cut gear set for noise reduction and optional black (or polished) finishes for the P-1SC-1 head units and the ProCharger main bracket. The HO Intercooled System is 100% complete, with injectors and handheld programmer. Tuner Kits exclude programmer and fuel system components.

### 2019-11 300 5.7L Systems & Tuner Kits

- HO Intercooled System with P-1SC-1
- HO Intercooled Tuner Kit with P-1SC-1

### 2019-11 300 5.7L Options & Upgrades

- Satin, Polished, or Black supercharger and bracket finish
- Helical Gearset for noise reduction (P-series and D-series only)
- Tuner Kits allow for D-1SC up to F-1A-94 upgrades
- Race Bypass Valve upgrade available



# 300 6.1/5.7

2010-2005



*HO Intercooled System with P-1SC-1, optional polished finish shown*



**130-160+ MORE HORSEPOWER**

*"If you have mechanical skills, and can follow simple instructions, you can definitely install this kit."*

**-Engine Power**

## 2010-05 300 6.1L/5.7L Systems & Tuner Kits

- HO Intercooled System with P-1SC-1
- HO Intercooled Tuner Kit with P-1SC-1

## 2010-05 300 6.1L/5.7L Options & Upgrades

- Satin, Polished, or Black supercharger and bracket finish
- Helical Gearset for noise reduction (P-series and D-series only)
- Tuner Kits allow for D-1SC up to F-1A-94 upgrades
- Race Bypass Valve upgrade available

## Unmatched Appearance and Power

ProCharger HO Intercooled Systems are available for 6.1L HEMI-equipped Chrysler 300s. Owners can expect power gains of 160+ HP on the 6.1L HEMIs and 130+ HP on 5.7L HEMIs (110+ with 2009-10 5.7L VCT engines).

Designed around the patented and proven, self-contained ProCharger P-1SC-1 supercharger, the HO Intercooled system features a reliable, "shared-drive" design, a highly efficient, 3-core air-to-air intercooler, a beautiful "from the factory look," OEM-quality mounting brackets and all necessary supercharger and intercooler tubes for installation onto Chrysler 300Cs. ProCharger systems for the 300C utilize a handheld programmer to upload the ProCharger tune.

ProCharger Tuner Kits are identical to complete systems, but come without fuel system components and handheld programmer. Tuner kits require custom tuning by a qualified dealer, and are available for AWD 300C's and require additional fuel system upgrades.





# MAGNUM 6.1/5.7

2008–2005

*HO Intercooled System with P-1SC-1, optional polished finish shown*



## 110–160+ MORE HORSEPOWER

*"It doesn't matter what the [HEMI] engine comes in, it's a great platform that responds to big boost from ProCharger and they are the leader in HEMI kits hands down."*

*–Engine Power*

### 2008-05 Magnum 6.1L/5.7L Systems & Tuner Kits

- HO Intercooled System with P-1SC-1
- HO Intercooled Tuner Kit with P-1SC-1

### 2008-05 Magnum 6.1L/5.7L Options & Upgrades

- Satin, Polished, or Black supercharger and bracket finish
- Helical Gearset for noise reduction (P-series and D-series only)
- Tuner Kits allow for D-1SC up to F-1A-94 upgrades
- Race Bypass Valve upgrade available



### Magnum Comfort with ProCharger HEMI Power

The Dodge Magnum has been lauded for its flexibility as a comfortable cruiser and a hefty hauler. Now you can really make it haul with the addition of a ProCharger HO Intercooled Supercharger System for 2005 through 2008 Dodge Magnums with either the 5.7L or 6.1L HEMI engines. Magnum owners can expect power gains of 160+ HP on the 6.1L and 110+ HP on the 5.7L HEMI Magnum.

Thanks to the industry's coolest charge air temperatures and largest power gains, no other supercharger system for the Dodge Hemi Magnum even comes close. With ProCharger's patented and proven self-contained P-1SC-1 supercharger and a high-performance air-to-air intercooler system, unmatched power is delivered with maximum reliability and simple installation. The HO Intercooled System is 100% complete, with fuel injectors and a handheld programmer included.

ProCharger Tuner Kits are identical to complete systems, but come without fuel system components and handheld tuner. Both 6.1L and 5.7L tuner kits require custom tuning by a qualified dealer. Tuner Kits are available for AWD Magnums and require additional fuel system upgrades.



# GRAND CHEROKEE 6.4

2020–2012



HO Intercooled System with P-1SC-1, optional black finish shown

## BOLT ON 215+ MORE HP

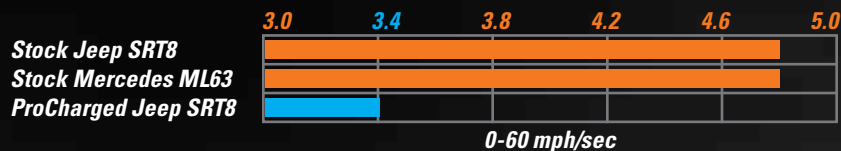

### Engineered Power

HO Intercooled Systems and Tuner Kits for the 2012+ Jeep Grand Cherokee SRT8/SRT utilize ProCharger patented technology that continues to lead the industry in OEM-style fit and finish, ease of installation, and reliable performance. ProCharger HO Intercooled Systems are supplied with the patented self-contained P-1SC-1 supercharger, proven tuning calibrations, and a handheld programmer set for a 215+ horsepower gain over stock, on 7 psi of boost and pump gas. Higher boost levels and horsepower are possible with an Intercooled Tuner Kit and custom tuning, and even higher with modified engines. The HO system is 100% reversible, with no trimming or cutting to any factory OEM plastics or hardware. You also have your choice of supercharger and bracket finishes: satin, polished, or black finish.

### 0-60 mph in only 3.4 Seconds

Even tipping the scales at 5,150 lbs, with nothing more than a bolt-on ProCharger supercharger system that installs in a matter of hours, you could shed nearly 1.5 seconds off your 0-60 time! This ProCharger supercharger system was also designed with long lasting performance in mind—thanks to the efficient P-1SC-1 supercharger and highly effective intercooler, massive power gains are possible with only 7 psi of boost and premium pump gas.

### 2020-12 Grand Cherokee 6.4L Systems & Tuner Kits

- HO Intercooled System with P-1SC-1
- HO Intercooled Tuner Kit with P-1SC-1

### 2020-12 Grand Cherokee 6.4L Options & Upgrades

- Satin, Polished, or Black supercharger and bracket finish
- Helical Gearset for noise reduction (P-series and D-series only)
- Tuner Kits allow for D-1SC up to F-1A-94 upgrades
- Race Intercooler upgrade (shown at right)
- Race Bypass Valve upgrade available





# GRAND CHEROKEE 5.7

2020–2011



HO Intercooled System with P-1SC-1, optional black finish shown



## BOLT ON 160+ MORE HP

*"If you're looking for triple-digit increases in torque and horsepower for your late-model hemi, it's time to step up to a ProCharger supercharger." -Hot Rod*

### Haulin' the Groceries

Jeeps are known worldwide as the do everything vehicles. Whether off-roading, hill climbing, taking the kids to soccer practice or somewhere in-between—Jeeps do it all. ProCharging your 5.7L Grand Cherokee takes the performance of your daily driver to a new level with the complete intercooled systems and tuner kits adding 160+hp to the 5.7L power plant at just 7 psi. That's more power than a stock 392 Challenger!

ProCharger systems are easy to bolt on with common hand tools and after only one afternoon in the garage, you can have a supercharged HEMI monster. These supercharger systems are designed to leave no permanent modifications to your vehicle. That means no cutting, no trimming, and no bending is needed to achieve this OEM fit and finish. Full systems come complete with a handheld programmer to get you up and running fast, with smooth drivability and tons of reliable power.

ProCharger is the undisputed leader in forced induction for modern HEMI-powered cars, trucks and SUVs. For over a decade we have been adding safe and reliable boost with great power gains.

### 2020-11 Grand Cherokee 5.7L Systems & Tuner Kits

- HO Intercooled System with P-1SC-1
- HO Intercooled Tuner Kit with P-1SC-1

### 2020-11 Grand Cherokee 5.7L Options & Upgrades

- Satin, Polished, or Black supercharger and bracket finish
- Helical Gearset for noise reduction (P-series and D-series only)
- Tuner Kits allow for D-1SC up to F-1A-94 upgrades
- Race Intercooler upgrade (from HO intercooler)
- Race Bypass Valve upgrade available



# GRAND CHEROKEE 6.1

2010–2006



*HO Intercooled System with P-1SC-1, optional polished finish shown*



## BOLT ON 160+ MORE HORSEPOWER

*"It really is the perfect blend of performance while maintaining utility in one seamless package."*

*-Truckin*

### 2010-06 Grand Cherokee 6.1L Systems & Tuner Kits

- HO Intercooled System and Tuner Kit with P-1SC-1
- Stage II Intercooled System and Tuner Kit

### 2010-06 Grand Cherokee 6.1L Choices & Upgrades

- Satin, Polished, or Black supercharger and bracket finish
- Helical Gearset for noise reduction (P-series and D-series only)
- Tuner Kits allow for D-1SC up to F-1A-94 upgrades
- Race Intercooler upgrade (from HO intercooler)
- Race Bypass Valve upgrade available

### 160+ More HP for SRT8 Grand Cherokee HO Systems

ProCharger has intercooled power for your 2010-2006 Jeep Grand Cherokee SRT8 with the 6.1L engine. The High Output and Stage II Intercooled Systems produce an industry leading 160+ HP power gain on 7 psi of intercooled boost on otherwise stock engines running premium pump gas. ProCharger's Tuner Kit offers higher boost and power levels for modified engines. HO Intercooled systems utilize the patented, proven and self-contained P-1SC-1 ProCharger, a compact supercharger drive system, a highly-effective, air-to-air intercooler, OEM-quality mounting brackets, tuning and all necessary supercharger and intercooler tubes for installation onto your Jeep Grand Cherokee SRT8 SUV engine. ProCharger HO Systems come standard with a highly effective air-to-air 3-core intercooler.

### ProCharger Stage II Systems and Tuner Kits

Stage II Intercooled Systems and Tuner Kits (shown below) are designed for modified applications, but are also compatible with stock vehicles. They feature an industry exclusive dedicated 8-rib belt drive system standard. ProCharger also has an Air-to-Air Race intercooler upgrade capable of 1100 HP for both HO and Stage II systems! At 4.5" thick, this race intercooler displaces 1,296 cubic inches of highly effective core, so cooling is at an absolute max.





# RAM

2020–1996

# WRANGLER

2020-2018 JL / 2018–2012 JK

# GLADIATOR

2020+ JT



## The Ultimate Power Adder® for HEMI's and Pentastar Engines

Powerful, purposeful, and individualized—hallmarks of so many Ram trucks and truck owners, as well as the industry-leading intercooled supercharger systems from ProCharger. Recognizing the performance potential of the HEMI Ram trucks, ProCharger was first-to-market and is still years ahead of others in making sure these work hard, play hard rigs have all the power their tires can handle. With industry leading experience and technology, ProCharger produces the coolest charge air temperatures and largest power gains. For over 25 years, from the dyno to the street, on and off road, ProCharger's engineering and R&D teams go to great lengths to ensure your supercharged, American-made truck/SUV is everything you expect and more. Once you've experienced the incredible, real-world performance of this technology, you'll agree that ProCharger is The Ultimate Power Adder.

ProCharger systems for 2020-2004 5.7L HEMI Rams and 2020-2012 3.6L Pentastar Jeep Wrangler and Gladiator feature easy installation, minimal relocation of components, no need for external oil feed and return lines, and avoids the complexity and maintenance issues of an air-to-water-to-air intercooler. All models feature a standard upper mount intercooler, with an optional lower mount intercooler available for 2008-2006 HEMI Ram trucks. Intercooled systems and tuner kits for 2001-1996 Dodge Ram and 2001-1997 Dodge Dakota/Durango trucks equipped with the 5.9L or 5.2L V8 Magnum engines are also available. **Give us a call at (913) 338-2886 or visit [www.procharger.com](http://www.procharger.com) to get a copy of our ProCharger Truck/SUV catalog.**





# R&D: BEHIND THE POWER

## LARGEST AND SAFEST POWER GAINS FOR HEMI ENGINES

### ProCharger: The HEMI Supercharger Experts

Since their introduction, ProCharger has established itself as the industry leader in late-model HEMI forced induction systems. The ProCharger R&D Team of engineers knew they would be faced with some tuning challenges on this new engine platform. Testing began with an engine and two vehicles and was expanded to dozens of beta test vehicles. In late 2005, a complete 5.7L HEMI engine was purchased new by ProCharger with a Dodge factory stock accessory drive.

The intake manifold for the HEMI Ram engine varied in design and flow from the intake manifold for the HEMI Charger engines, so ProCharger tested both, measuring the air/fuel ratio at each individual cylinder during every test performed on the engine dyno. This engine went through a grueling 18 month R&D process without a single failure. ProCharger engineers made a total of 227 dyno pulls on this engine; 139 with the Ram intake manifold and 88 with the Charger intake. In 2011 the process was repeated and ProCharger was first to market once again, this time for the 6.4L/392 HEMI.

### Testing the Limits

The initial R&D process also included ProCharger purchasing a Dodge HEMI Charger and a HEMI Ram for additional chassis dyno and real-world street testing. Together, more than 200 chassis dyno pulls were made and today, both vehicles continue to rack up thousands of spirited supercharged miles without a single failure. Dozens of successful beta test vehicles soon followed. Today the self-contained and intercooled HEMI ProCharger systems are producing the largest reliable and streetable power gains in the industry. With unmatched technology and breadth of product offering, ProCharger is sure to have a complete system or tuner kit to get you the horsepower you desire.

At ProCharger, we take pride in the fact that all of our EFI HEMI intercooled supercharger systems feature a “from the factory” look and can be installed with a minimum of factory component relocation and little to no modification of stock components—supercharger systems that perform as good as they look.







**We Race, You Win**

The same design philosophy that puts top racers into the winner's circle can be found in every Intercooled ProCharger Supercharger System and Tuner Kit. With a ProCharger system, not only will you receive the largest and most engine-friendly horsepower gains, you also have the peace of mind knowing that your supercharger was designed to reliably and consistently produce event and championship-winning power pass after pass, year after year. What are your HEMI high-performance goals? Let ProCharger help you blow them away.

# COOLER IS BETTER

## TECHNOLOGY ADVANTAGE

### Thermal Advantage

It's really quite simple: cooler air is more dense, and is able to produce more power. If your goal is to produce maximum reliable power, then you want the coolest charge air temperatures possible. When it comes to producing consistent and reliable power, heat is the ultimate enemy. With other forced induction designs, excess heat not only reduces power gains on your first pull, it produces power fade that further reduces power and performance as the engine heats up.

These images illustrate the thermal advantages of a ProCharger supercharger system when compared with a turbocharger and positive displacement blower. By their very design, centrifugal superchargers are more efficient compressors and create less heat during their operation. Additionally, ProCharger superchargers are mounted in front of the engine which is a much cooler environment than on top of the engine or if plumbed into the engine's exhaust.

Turbochargers require hot engine exhaust to compress air. The result is a very hot turbine and turbine housing which transfers heat to the compressor. Turbochargers also create high exhaust gas temperatures and backpressure, causing additional heat build up in exhaust manifolds, cylinder heads and valves.

Positive-displacement (PD) blowers are typically located directly on top of the engine or deep between the cylinder heads. Because they are attached to or surrounded by hot engine components, this is an extremely hot environment. Now add the heat created by their lower-efficiency compressors and you end up with a hot compressor producing hot, compressed air. The location of a PD blower necessitates the use of a complex air-to-water-to-air intercooling system which is also located in a hot and heat-soaked environment. Heat is the enemy of consistent and reliable power in general, but especially on HEMI engines, which experience substantial power fade when exposed to excess heat

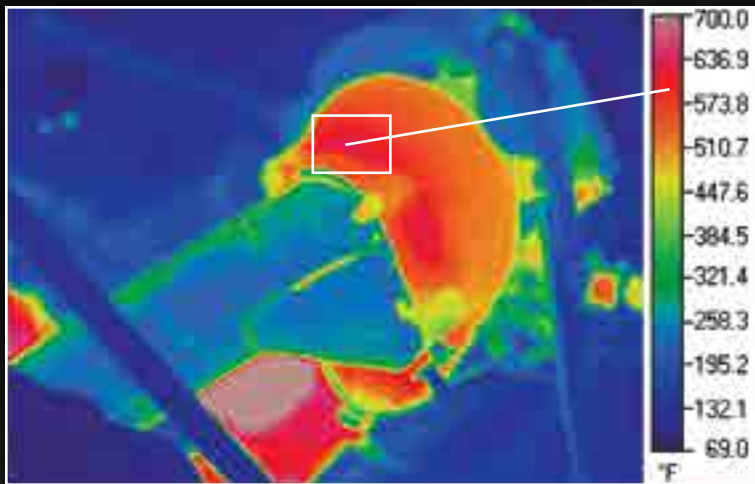

*Turbocharger*

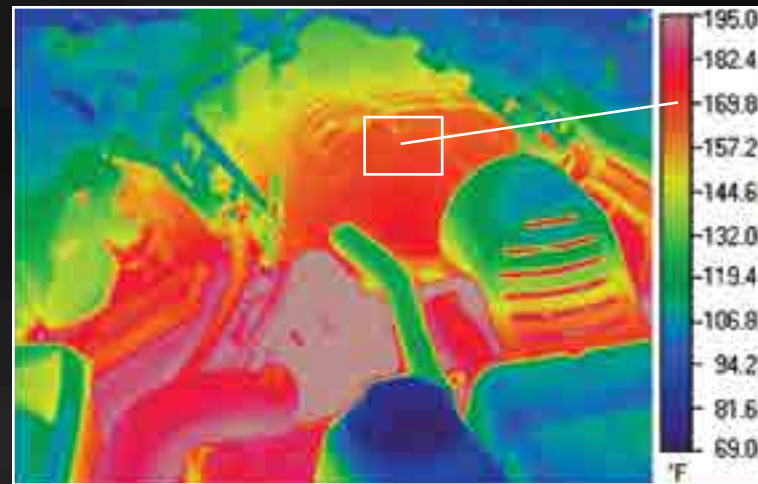

*Positive Displacement with air-to-water-to-air intercooler, 8 psi*

**NOTE: the scales of the turbocharger and positive displacement images are higher due to the additional heat they produce.**



## Increase in Charge Air Temperatures at Engine Intake for 6.1 HEMI (°F)

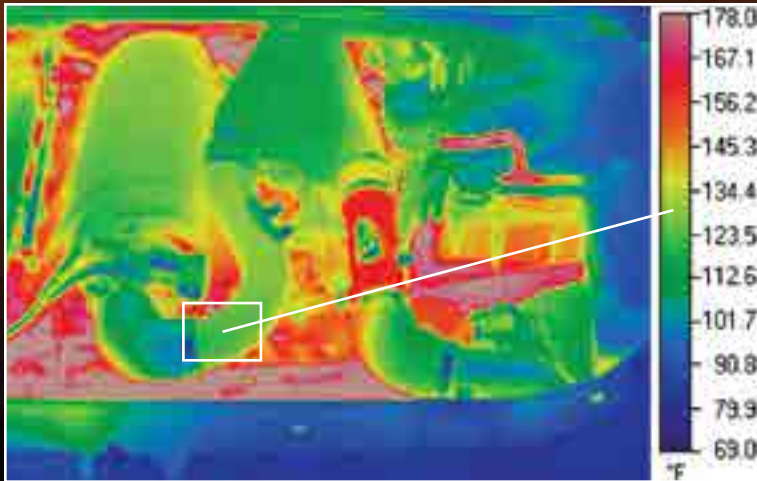
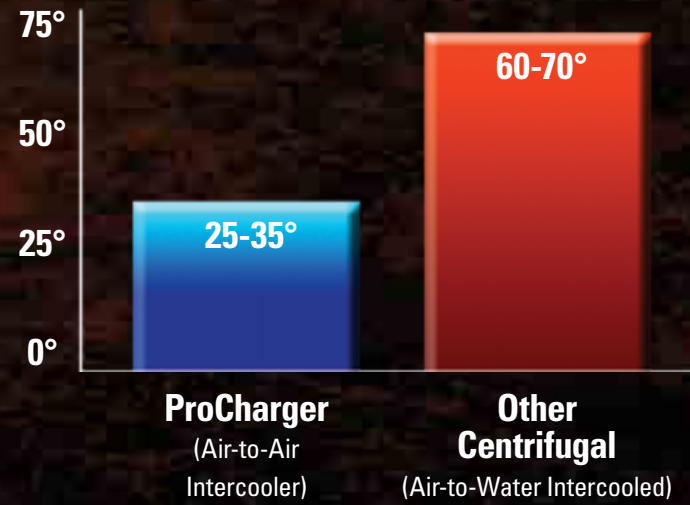

*Other centrifugal with air-to-water-to-air intercooler*

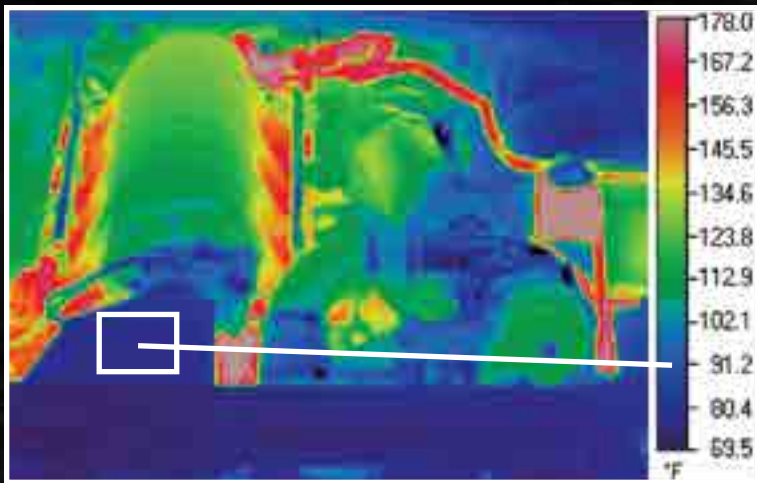

*ProCharger centrifugal with air-to-air intercooler*



# AIR-TO-AIR INTERCOOLING

## COOLER IS BETTER

### Intercooled Supercharging

Today's modern Hemi's are some of the largest displacement, biggest horsepower, and highest torque engines on the road, and as such are very sensitive to heat. As the engine gets hot, higher engine inlet air temperatures result in reduced power and torque over time. ProCharger's highly efficient centrifugal compressors and air-to-air intercoolers are engineered to provide the coolest inlet air charge temperatures with a linear power curve that continues to increase intercooled boost to the engine once it is past its peak torque output, so you can build power right up to your engine's maximum RPM.

ProCharger pioneered the practice of intercooling as an integral design solution on aftermarket supercharger systems nearly 5 years before others and to this day, still offers the most effective, reliable and highest flowing intercoolers. Other aftermarket companies are now embracing air-to-air intercooling, with air-to-air being standard on their newer supercharger kits, while they only offer air-to-water-to-air or no intercooling on their older kits. Don't get stuck with yesterday's technology.

ProCharger intercoolers are an integrated part of our street supercharger systems and have been specifically designed to deliver the lowest charge air temperatures to the engine for maximum engine longevity and efficiency, with zero maintenance. In fact, in test after test, ProCharger's air-to-air intercooled supercharger systems have been proven to produce the largest power gains and coolest charge air temperatures.

Others offer only one size of intercoolers for street/strip applications (or none at all), and their one intercooler frequently becomes undersized with even minor engine modifications. ProCharger generally offers two sizes of intercoolers, often more, and supports the highest street/strip power levels in the industry. This ensures the right product for your power level based on how you will be using your ProCharged vehicle.

With respect to intercooling: efficient, reliable power is the bottom line. And when it comes to street-driven performance, air-to-air intercooling provides superior charge air cooling which in turn is able to produce more power after it enters the engine.

### Intercooler Design Considerations

Because of their design and mounting location, positive-displacement blowers are unable to use air-to-air intercooling, instead having to go with the less effective air-to-water-to-air configuration or no intercooling at all. Aftermarket turbocharger manufacturers on the other hand, who could go with either system, choose to utilize the more effective air-to-air intercooler technology.

### Benefits Of Air-To-Air Intercooling

- More effective
- More reliable
- No maintenance
- Simpler and easier to install
- Superior charge air cooling capabilities
- Intercooler exposed to a constantly replenished airflow
- Large intercooler surface area for quick recovery and repeatable performance in real-world driving situations

Air-to-air intercooling is effective and simple—no worries of a coolant pump failure or coolant leaks that are possible with an air-to-water-to-air intercooling system. Failure of an air-to-water-to-air intercooler can result in serious and expensive engine damage due to detonation or water entering the engine oil or engine itself.

ProCharger's industry leading system efficiency is proven by producing the most power per psi of boost while also having the ability to produce the highest overall boost and power levels. For maximum power, reliability and driveability since 1994, customers have looked to ProCharger: The Intercooled Supercharging Experts®.

*"When space permits an adequately sized air-to-air intercooler to be fitted and given access to decent airflow, it will always prove superior. The only excuse for a liquid-based intercooler is when severe space restrictions exist [including positive displacement superchargers, due to mounting location] or ... where an iced coolant can be used." –SuperCharged, Corky Bell*



**“The normal, closed loop air-to-water intercooler system [not using ice] is not as effective as a properly designed air-to-air intercooling system since the cooling medium or the liquid coming from the front heat exchanger is always warmer than the ambient air temperature.” –All About Intercooling, George Spears**

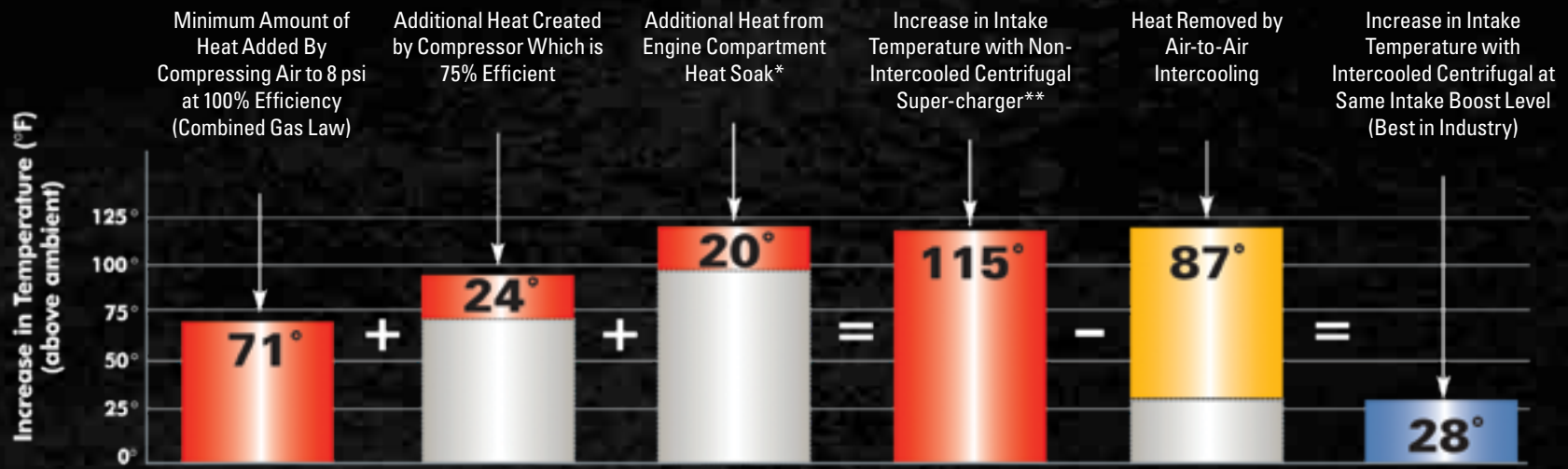

\*Radiant heat from engine and exhaust transferred through air, conductive heat transferred directly, and convective heat from engine oil. This engine compartment heat is not addressed by SAE J1723 (supercharger efficiency standard).

\*\*Temperature will be higher for PD blower or turbo.

# AIR-TO-AIR SUPERIORITY

## THE FUNDAMENTAL SOLUTION

### Air-To-Air Advantage

Since their earliest uses in fighter and bomber aircraft, the advantages of air-to-air intercooling have been demonstrated time and time again. It's a simple fact of physics: cooler air makes more power. Period. Today, ProCharger owners are still reaping the performance benefits of air-to-air intercooling.

On street driven vehicles, air-to-air intercooling is a natural fit because it locates the intercooler at the front of the car where it is exposed to a constant supply of cooling airflow. Consisting of large-volume air plenums, ProCharger's air-to-air intercoolers utilize a highly efficient and durable cross-flow intercooler core that provides large surface areas for superior levels of heat dispersion.

Air-to-air intercooling is a one-step process and represents a fundamental ProCharger advantage. Compressed air enters one side of the intercooler, making its way into the cross-flow core. Once in the core, the compressed air is cooled by the airflow moving

through the passages or fins of the intercooler. Next, this cooler, denser air is routed into the throttle body and into the engine. In engineering terms, air-to-air intercooling represents a one-step cooling process.

On the other hand, positive-displacement blowers are forced to use an air-to-water intercooler system which is a complex arrangement of intercooler cores, hoses, fittings, a coolant pump, tank, electrical connections and yes, a front-mounted air-to-air heat exchanger. In street applications, an air-to-water intercooler is in fact an air-to-water-to-air system. Typically packed into the tight and hot confines under the supercharger and intake manifold deep in the V of the engine, air-to-water-to-air intercooler systems are very complex, difficult to install, and not as effective as air-to-air intercooling. In engineering terms, air-to-water-to-air intercooling is a two-step cooling process.

**For more on air-to-air intercooling, check out the Technology pages at ProCharger.com.**

### One Step Process: Air-to-Air

Air-to-air intercooling represents a one step process of cooling the compressed air before it enters the engine. Simple, easy-to-install and highly effective, ProCharger's air-to-air intercooler design provides the coolest charge air temperatures for the highest horsepower gains.

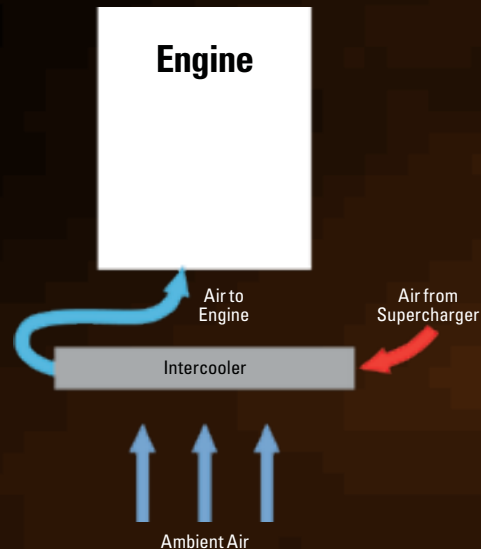

### Two Step Process: Air-to-Water-to-Air

Air-to-water-to-air is a two step process of cooling the compressed air before it enters the engine. Typical air-to-water-to-air intercooler systems are a complex arrangement of potentially unreliable components. Not only is this less effective, but it is also unsightly, adds complexity and risk of coolant leaks and/or coolant pump failure.

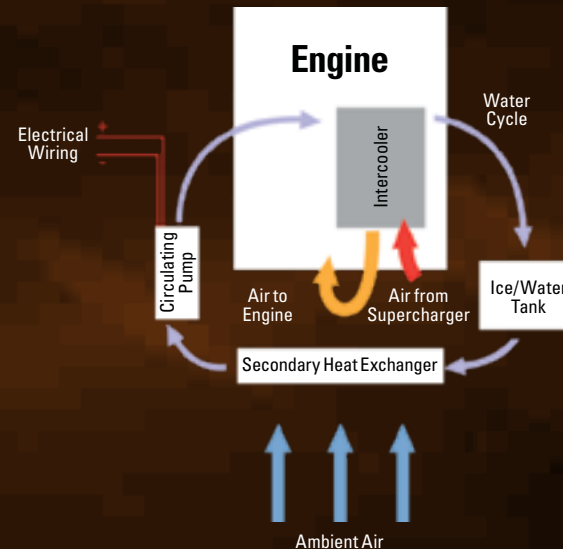





On the street or on the track, ProCharger offers the broadest range of intercoolers of any supercharger manufacturer.

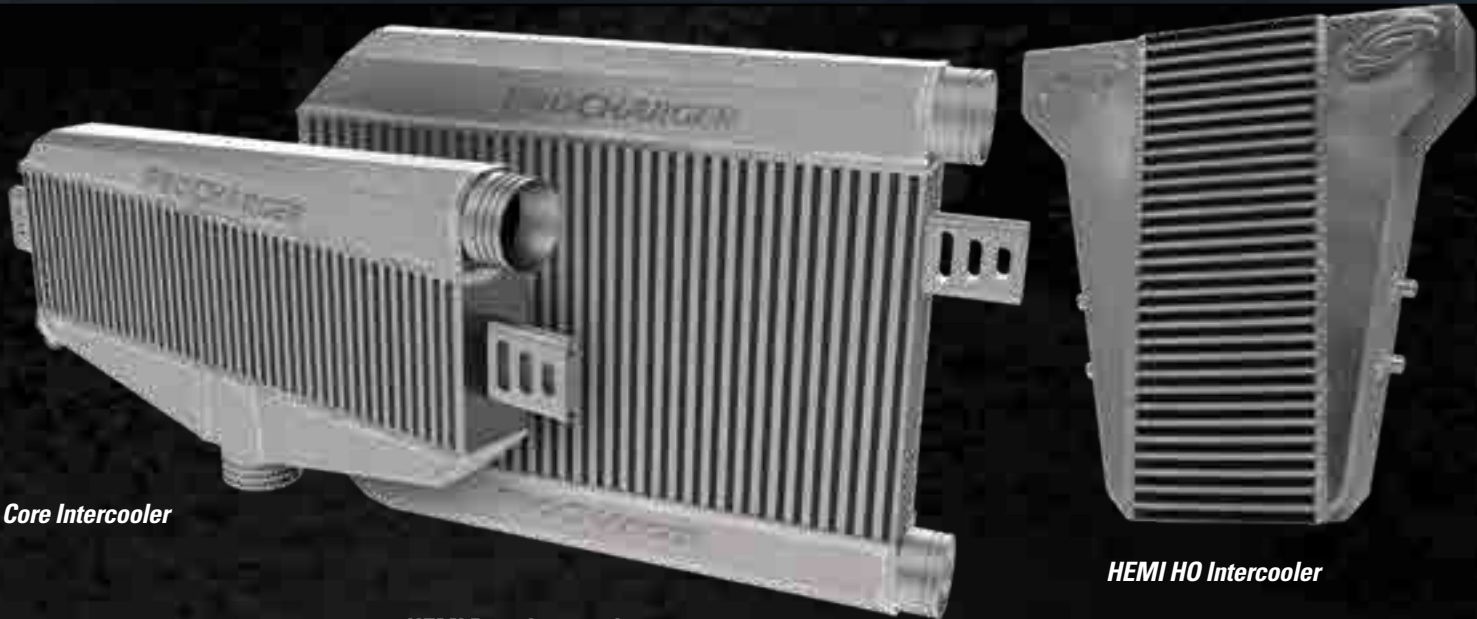

*HEMI 3 Core Intercooler*

*HEMI Race Intercooler*

*HEMI HO Intercooler*

# CENTRIFUGAL LEADERSHIP

DESIGNED TO BLOW AWAY THE COMPETITION™

## Technology

ProCharger introduced the industry's first self-contained, gear-driven supercharger in 2000. Since then, this patented and proven self-contained design has become the standard by which other superchargers are measured.

The top-selling ProCharger P-1SC, P-1SC-1, P-1X, D-1SC and D-1X supercharger models share many of the design elements that deliver the record-setting durability and performance of the ProCharger F-Series competition superchargers. With their rugged design, including an exclusive billet gear case, these self-contained superchargers are powerful and efficient enough to harness the benefits of air-to-air intercooling, while also being durable enough to carry the industry's best warranty coverage.

The patented self-contained design eliminates the need for an external oil supply or oil lines that require a hole to be punched in the engine's oil pan. Additionally, testing has shown self-contained superchargers run cooler than those fed by engine oil.

## Internal Oil Pump

At the heart of the ProCharger self-contained design is a simple, but highly effective oil aerator. This oil aerator creates the oil mist lubrication required for the precision bearings and gears. This oil pump does not require priming at start-up, and oil changes are only required every 6,000 miles.

Instead of being forced to utilize hot engine oil or the grease in sealed bearings, ProCharger superchargers are lubricated with an extremely high-quality synthetic oil specifically engineered for high speed use.

ProCharger's self-contained design eliminates the heat that is transferred to a supercharger by engine-oiled designs and also avoids the possibility of supercharger damage that can result from clogged oil feed lines or oil drainage problems.

## Billet Impellers

Using state-of-the-art, five-axis CNC machines, ProCharger's proprietary impeller designs are crafted from aircraft-grade 7075 T-6 aluminum alloy for tremendous strength and performance. This top-tier material allows for larger impellers that weigh less and are free of the flaws found in typical cast impellers. Large, structurally sound impellers are capable of higher speeds, which flow more air and in turn, produce more power. ProCharger was the first in the industry to utilize billet impellers, back in 1994.



*"The self-contained ProCharger that I race has never been back to ProCharger for any kind of repair or check-up since it was new. Five years worth of racing—that means three championships and two runner-up finishes with well over 1,000 passes on it with no problems. Awesome durability!" —Monte Smith*



## Self-Contained Superiority

Introduced in 2000, self-contained ProCharger superchargers were designed specifically to be self-lubricating, not as an afterthought. Not only does this make our superchargers easier to install, but this patented, gear-driven, self-contained design is durable enough to be available with the best warranty in the industry.

**P-1SC-1: Industry-Leading  
4.10:1 Step Up Ratio**

**Precision Ground Gears  
with Patented Design for  
Noise Reduction Provide  
Unmatched Durability**

**Exclusive 7075 T-6  
billet impeller**

**Custom Teflon Composite  
High Pressure Dual Lipped Seal**

**Precision High Speed  
Rated Aerospace Spec  
Support Bearings**

**Patented Aeration Pump  
Provides Self-Contained  
Oiling with Superior  
Bearing Lubrication**

**Exclusive CNC Machined  
6061 Billet Aluminum  
Housing Ensure Precise  
Shaft Alignment**

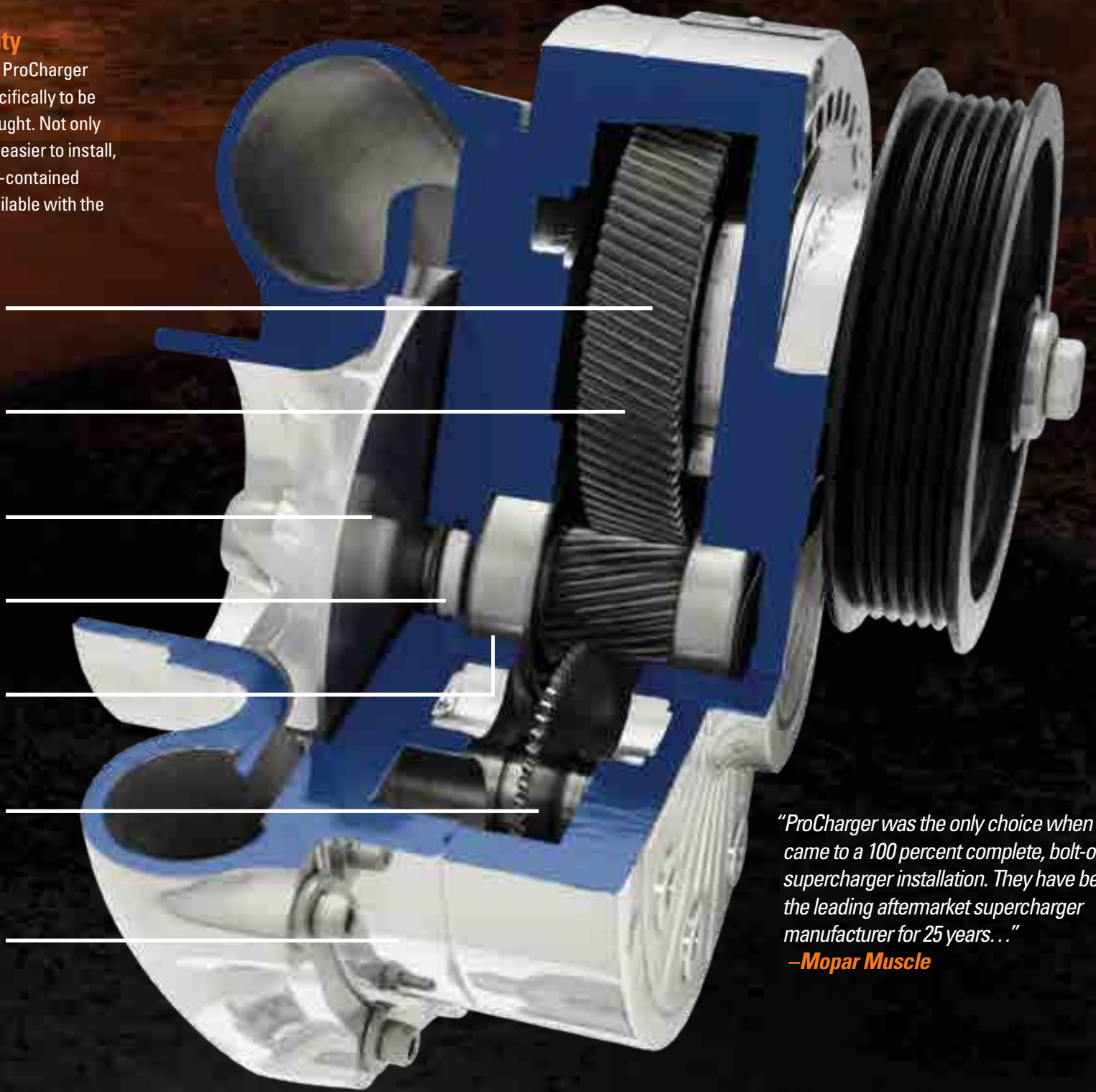

*"ProCharger was the only choice when it came to a 100 percent complete, bolt-on supercharger installation. They have been the leading aftermarket supercharger manufacturer for 25 years..."*

**-Mopar Muscle**

*(Optional helical gear set shown)*

# CENTRIFUGAL SUPERCHARGING

MORE POWER, LESS HEAT, IDEAL POWER CURVE

## Supercharger Efficiency: Centrifugal vs Positive Displacement

By its very definition, a supercharger is a device (such as a blower or compressor) for increasing the volume air charge of an internal combustion engine over that which would normally be drawn in by the intake stroke of the pistons. Efficiency refers to both the heat created by the supercharger and the power required to drive it.

Due to their design, it's a commonly accepted engineering fact that centrifugal compressors are much more efficient than positive displacement superchargers. More efficient compressors mean more efficient supercharger systems, this in turn means more power across a wider operating range for your engine. Centrifugal superchargers are also a great fit for modern HEMI engines with respect to the shape of the power curve. For HEMI engines, ProCharger technology not only produces far superior drivability relative to positive displacement blowers and turbos, ProCharger systems deliver power in line with your ability to use it.

Centrifugal superchargers also have a broader operating range than positive displacement superchargers. This broad operational range supports future engine modifications, meaning you are less likely to "outgrow" your ProCharger supercharger than a positive displacement design.

At higher boost levels, centrifugal superchargers remain 70 to 80% efficient, whereas positive-displacement-blowers are less efficient to begin with and efficiency further declines as pressure increases. Positive-displacement blowers are also mounted on top of the engine where they quickly become heat soaked, further increasing charge air temperatures. Positive-displacement blowers deliver a nearly-fixed volume of air per revolution at all RPMs, making PD blowers less efficient than ProCharger centrifugal design throughout the engine's performance operating range.

## More Boost After Peak Torque

Most of today's stock street engines have a torque curve that falls away while horsepower is still on the rise. A ProCharger centrifugal supercharger system continues to increase the amount of intercooled boost available to your engine once it is past its peak torque output. Now, rather than your engine "going flat" after peak torque, it continues to build power right up to your engine's maximum RPM. The result is more power across the typical operational RPM range of a performance engine.

A ProCharger centrifugal supercharger can also support future modifications to your engine or exhaust system. Thanks to industry-leading step-up ratios and rugged design, ProCharger provides the best performance at any power level. High-flow intake manifolds, camshaft, cylinder heads and exhaust systems can all be supported via more airflow and boost from the same ProCharger supercharger with a simple pulley upgrade.







## ADVANTAGE IN EFFICIENCY AND OPERATING RANGE

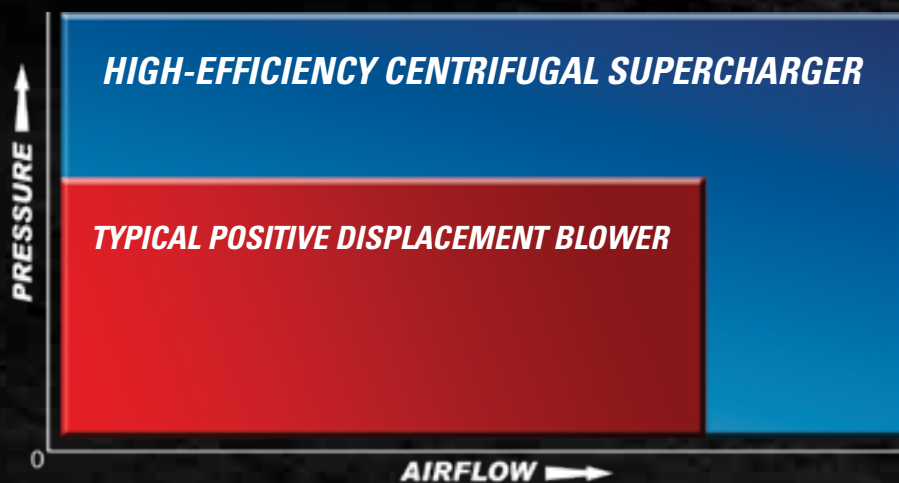

## Wider Operating Range

Centrifugal superchargers have a much broader operating range, in terms of both airflow and pressure, when compared to typical positive displacement blowers. Bottom line: ProCharger makes more power at the same boost level, and also offers far more upgradability to accommodate engine modifications and higher boost and power levels.

*“ProCharger prides themselves on creating 100% complete kits that arrive in a single, well-organized box. We love how everything is bagged and labeled with both the part name and number for easy identification during the install. There’s no guesswork here.”* —**Mopar Enthusiast**

# THE ULTIMATE POWER ADDER®

NOTHING ELSE EVEN COMES CLOSE

## Other Power Adders Just Don't Add Up

Proven by dealers, racers and HEMI owners around the world, no other form of aftermarket power-adder provides the combination of power, reliability, ease of installation and maintenance, engine safety and cool operation of a ProCharger. Let's take a look at why the other power enhancing options just don't add up.

## Nitrous Oxide

Initially, nitrous may look like a bargain, but a review of the facts reveals otherwise. Nitrous oxide accelerates the combustion rate, which in turn, increases peak cylinder pressures. This combination greatly increases the probability of piston-melting pre-detonation. This rapid increase in cylinder pressure also increases the load placed on internal engine components. Additionally, nitrous oxide adds the expense and hassle of constantly having to refill bottles and is not always available when you need it.

## Positive Displacement Blowers

Centrifugal superchargers offer substantially higher adiabatic efficiencies than their positive-displacement (PD) counterparts. PD blowers are located on top or nestled in the "V" of the engine, placing them in a very hot, harsh environment which results in significantly hotter charge air temperatures. This location also requires the use of a significantly more complex and less effective air-to-water-to-air intercooling configuration. To cope with these high charge air temperatures, PD blowers must be tuned extremely rich with less timing. This reduces the vehicle's fuel efficiency, driveability, power and engine longevity.

## Turbochargers

A turbocharger, technically a turbosupercharger, is in fact a form of centrifugal supercharging. Although they use advanced compressor technologies similar to ProCharger's compressor designs, turbo systems' initial cost and complexity make them less practical for everyday street driving. Because a turbo relies on hot engine exhaust to create power, they also create high exhaust temps, backpressure, high charge air temperatures, and are subject to "lag" that degrades their real-world driving performance. Turbos also require you to punch a hole in the oil pan in order to use engine oil feed and return lines for lubrication, which run the risk of oil contamination, oil line clogs, and increase the unwanted thermal breakdown of your engine's oil.



*ProCharger sponsored the World's Fastest HEMI Challenge at Maple Grove Raceway, which was part of the annual Late-Model Shootout and NMCA's Muscle Car Nationals. ProCharger also sponsors the Modern Hemi Shootout series.*

## Other Centrifugal Superchargers

When compared with other centrifugal superchargers on the market, ProCharger superchargers support nearly twice the horsepower along with much greater durability and reliability. Additionally, ProCharger is focused solely on centrifugal compressor technology, providing superior product and support to customers and dealers.

## Naturally Aspirated

The expense associated with building an engine large enough to produce the same power as a ProCharged stock engine just doesn't add up, especially when you consider the poor idle quality and extra fuel the larger engine will require. You must also consider the time and hassle of a complete engine swap or the downtime of a complete engine rebuild. Large displacement engines also tend to utilize higher compression ratios which create more heat and require expensive race fuels.





### Johnny Law Has a ProCharger

Superchargers and law enforcement generally are not thought of as going hand-in-hand. But for the Utah Highway Patrol it was a match made in heaven. In hopes of promoting recruitment numbers, a private citizen donated a sum of money for the UHP to turn a Dodge Charger into one of the meanest police cars on the street. With boost pumping through the intercooled ProCharged HEMI, this beast is sure to turn heads and increase recruitment for the department.

# POWER ADDER COMPARISON

MAKING 700 HP WITH A STOCK HEMI 6.4L ENGINE



### Goonzquad Police Car

Even though this Dodge Charger's life on patrol was cut short due to an accident, it came back better than ever. And you can watch the entire transformation on Youtube, thanks to the talented stars known as the "Goonzquad." These guys, not only did a full repair on the damage from the accident, but also added loads of horsepower to the 5.7L HEMI with a ProCharger supercharger install. For a full installation video hop on over to their channel and enjoy.

# RACING DOMINATION

## REAL WORLD PROCHARGER POWER

### ProCharger Motorsports

ProCharger has a long 25 year history of helping an incredible number of enthusiasts and racers accomplish their performance goals: WINNING! From drag strips to road course, and from the salt flats of Bonneville to open road races and rear-wheel dyno competitions, more and more ProCharger owners are reaching and exceeding their performance goals in amazing fashion.

When it comes to motorsports, talk is cheap. It seems like there are always too many aftermarket manufacturers willing to inflate their performance claims. ProCharger-equipped racers prefer to let their actions and results speak for themselves.

### ProCharger and Racing: A Winning Combination

ProCharger superchargers are synonymous with HEMI performance, especially in sanctioned drag racing competition. ProCharger was the first centrifugal supercharger to power racers into the 6's. As a matter of fact, as far back as 2002, every single Super Street and Street Outlaw racer in the 7's, and Renegade racer in the 8's were all ProCharged. Once the ProCharger supercharger power genie was out of the bottle, there was no looking back—unless you count looking in the mirror for the other guys.

The list of ProCharged racing champions, record holders and top performers reads like a Who's Who of winning racers. Check out the ProCharger Honor Roll at Procharger.com. Are you ready to put your name on this list?

### We Race, You Win

The same design philosophy that puts top racers into the winner's circle can be found in every street-legal ProCharger supercharger system. With a ProCharger system, not only will you receive the largest and most engine-friendly horsepower gains, you also have the peace of mind knowing that your supercharger was designed to reliably and consistently produce event and championship-winning power race after race, year after year. What are your high-performance goals? Let ProCharger help you blow them away.



*World's Fastest Gen III HEMI, 4.23 @ 169 (1/8 mile) 6.69 @ 211 (1/4 mile)  
Multi-time X275 and Street Outlaw winner*

### Consider these ProCharger Motorsports Achievements:

- ProCharged racers have won over 100 national championships in the past 15 years
- In drag racing, the 80 quickest centrifugal racers are all powered by ProCharger
- The first centrifugal supercharger to power a doorslammer past 200 mph
- HOT ROD Pump Gas Drags Championship
- HOT ROD Drag Week Championship
- Car Craft Street Machine of the Year Award
- HOT ROD Maxton Mile Top Speed Challenge Winner
- The ONLY supercharger to make 2,000 horsepower on pump gas
- The first centrifugal supercharger to make 3,000 horsepower on alcohol
- First centrifugal to run 3.50's in 1/8th mile and 5.50's in 1/4 mile



# F-1 SERIES

1000+ HP

## ProCharger F-Series Superchargers

ProCharger F-Series superchargers were designed with one simple goal: blow the competition away. Since their introduction in 2000, ProCharger's ever-expanding lineup of F-Series superchargers have continued to be the standard by which others hope to be measured, both on the track and on the street. From the custom designed 7075 billet aluminum impeller to the CNC machined transmission case to the industry-exclusive, compound bearing design, each self-contained F-Series supercharger has been designed to deliver maximum performance, pass after pass, year after year, championship after championship.

## ProCharger F-1D, F-1A, F-1A-91 and F-1A-94 Superchargers

These four ProCharger superchargers utilize a compact, 9" volute and are powerful and highly versatile superchargers. Like all the F-Series models, the F-1 and F-1A models feature the industry exclusive compound bearing design that supports high horsepower applications, while the patented and proven self-contained oiling design eliminates the need for external oil lines while providing years and years of trouble-free high performance.

## ProCharger F-1C and F-1R Superchargers

These ProCharger superchargers use a slightly larger, 9.75" volute for higher airflow and HP ratings and retain all the design advantages of the other F-Series models.

## On the Street or Strip

The highly versatile ProCharger F-1 Series supercharger lineup is compact enough for many of today's high-horsepower modified street engine applications, yet powerful enough for ultra-high street horsepower and hard-core racing applications.



### ProCharger F-1D

Base HP (NA Engine) ...300-500 HP  
Max Supercharged HP .....1,050 HP  
Maximum Airflow .....1,500 cfm  
Maximum Boost..... 34 psi  
Maximum Impeller RPM ....65,000  
Internal Step-up Ratio ..... 5.40:1

### ProCharger F-1A-91

Base HP (NA Engine) ...300-500 HP  
Max Supercharged HP .....1,150 HP  
Maximum Airflow .....1,800 cfm  
Maximum Boost..... 38 psi  
Maximum Impeller RPM ....74,000  
Internal Step-up Ratio ..... 5.40:1

### ProCharger F-1A-94

Base HP (NA Engine) ...300-500 HP  
Max Supercharged HP .... 1,300 HP  
Maximum Airflow .....1,950 cfm  
Maximum Boost..... 38 psi  
Maximum Impeller RPM ....74,000  
Internal Step-up Ratio ..... 5.40:1

### ProCharger F-1A

Base HP (NA Engine) ...300-500 HP  
Max Supercharged HP .....1,100 HP  
Maximum Airflow .....1,575 cfm  
Maximum Boost..... 38 psi  
Maximum Impeller RPM ....74,000  
Internal Step-up Ratio ..... 5.40:1

### ProCharger F-1C

Base HP (NA Engine) ...300-550 HP  
Max Supercharged HP .....1,100 HP  
Maximum Airflow .....1,625 cfm  
Maximum Boost..... 38 psi  
Maximum Impeller RPM ....74,000  
Internal Step-up Ratio ..... 5.40:1

### ProCharger F-1R

Base HP (NA Engine) ...375-550 HP  
Max Supercharged HP .... 1,250 HP  
Maximum Airflow .....1,700 cfm  
Maximum Boost..... 38 psi  
Maximum Impeller RPM ....68,000  
Internal Step-up Ratio ..... 5.40:1

# F-1X / F-2 / F-3 SERIES

2100–3500+ HP

## ProCharger F-1X Supercharger

The ProCharger F-1X features a larger, 10.5 inch volute diameter. Considered by many to be the ideal combination of small size and high performance, the F-1X (and all the F-Series models) retains all the ProCharger design advantages, including patented self-contained oiling, ultra-high speed compound bearing assembly, and precision ground 9310 steel gears that can support up to 1,300 HP.

## ProCharger F-2 Supercharger

The legendary F-2 supercharger also features a 10.5" volute diameter and provides a further performance increase above the F-1X. The F-2 is not subject to the racing class restrictions placed on the F-1X, and supports up to 1,600 HP.

## ProCharger F-3R-112 Supercharger

The F-3R-112 (formerly named F-1X-12) features an increase in airflow with a 12 inch volute diameter. Compared to the F-1X, the F-3R-112 is larger in most categories, with larger inlet, outlet, inducer, and exducer diameters. The F-3R-112 can support up to 2,100 HP.

## ProCharger F-3 Supercharger

The F-3 family of superchargers start with the F-3D models, which include 102mm and 106mm inducer options and are equipped with a 10.5" diameter volute. The F-3R models have a 12" diameter volute, with options that include a 112mm, 121mm, 130mm, and 136mm inducer diameters. The largest and most powerful option is the F-3X, with an inducer diameter of 140mm, and is equipped with a 13.5" diameter volute. The F-3R and F-3X models have an optional billet thread-on outlet flange, to accommodate either a v-band or "dual-seal" style charge pipe connection. All F-series models can be ordered with our CrankDrive unit, ProRace bypass valves, and Race Bellmouth.



521CI ProCharged F-3R-140 with CrankDrive BAE HEMI - 3500+ HP

HEMI Reverse Cog Race Kit

### ProCharger F-1X

Base HP (NA Engine) ...375-550 HP  
 Max Supercharged HP.... 1,400 HP  
 Maximum Airflow ..... 2,000 cfm  
 Maximum Boost..... 38 psi  
 Maximum Impeller RPM ....72,000  
 Internal Step-up Ratio ..... 5.40:1

### ProCharger F-2

Base HP (NA Engine) ...425-600 HP  
 Max Supercharged HP.... 1,450 HP  
 Maximum Airflow ..... 2,200 cfm  
 Maximum Boost..... 38 psi  
 Maximum Impeller RPM ....65,000  
 Internal Step-up Ratio ..... 5.40:1

### ProCharger F-3R-112

Base HP (NA Engine) ...375-550 HP  
 Max Supercharged HP....2,100 HP  
 Maximum Airflow ..... 3,000 cfm  
 Maximum Boost..... 38 psi  
 Maximum Impeller RPM ....72,000  
 Internal Step-up Ratio ..... 5.63:1

### ProCharger F-3R-121

Base HP (NA Engine) ...500-580 HP  
 Max Supercharged HP.... 2,400 HP  
 Maximum Airflow ..... 3,500 cfm  
 Maximum Boost..... 40 psi  
 Maximum Impeller RPM ....72,000  
 Internal Step-up Ratio ..... 5.63:1

### ProCharger F-3R-136

Base HP (NA Engine) ..700-1000 HP  
 Max Supercharged HP.... 3,000 HP  
 Maximum Airflow ..... 4,250 cfm  
 Maximum Boost..... 50 psi  
 Maximum Impeller RPM ....72,000  
 Internal Step-up Ratio ..... 5.63:1

### ProCharger F-3X-140

Base HP (NA Engine) ..700-1000 HP  
 Max Supercharged HP...3,500+ HP  
 Maximum Airflow ..... 4,800 cfm  
 Maximum Boost..... 60 psi  
 Maximum Impeller RPM ....72,000  
 Internal Step-up Ratio ..... 5.63:1



*"The intercooled ProCharger centrifugal supercharger system ... [modified, with F-1A] served up an astonishing 962.6 lb-ft of torque."*

*-Motor Trend*

# F-SERIES TECHNOLOGY

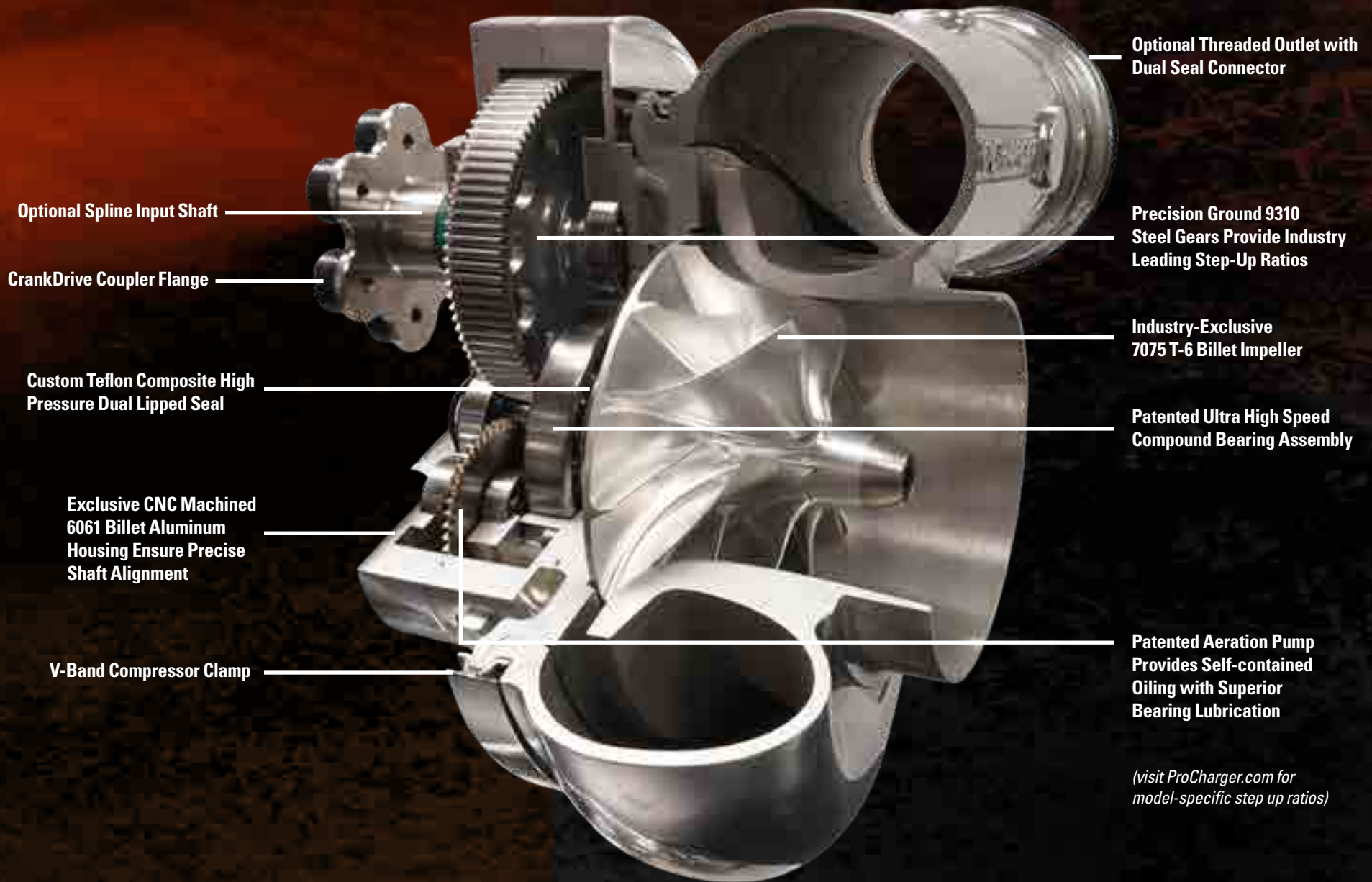

**RECORD SETTING. LEGENDARY. MOST WINNING.**

*(visit ProCharger.com for model-specific step up ratios)*

# BUILDING THE POWER

## THE LARGEST POWER GAINS, FROM THE GROUND UP

### ProCharger: Fundamental Advantage

ProCharger has several advantages which help support cutting edge innovation, precise engineering, quality manufacturing, unsurpassed performance and best in class service.

First, ProCharger designs and manufactures both its own superchargers and complete supercharger systems, unlike some competitors who buy superchargers and components elsewhere and are really only assembling kits. This helps ensure that ProCharger delivers a high quality, high performance product designed specifically for your needs.

Secondly, ProCharger resources lead the industry, including best in class aerodynamic design capabilities, and an unmatched commitment to testing (test lab, chassis and engine dynos, industry's largest test fleet). No other aftermarket company is even close to ProCharger's ability to rapidly design, prototype and test new compressor models.

Lastly, from the engineering group to the production team, from the sales and service staff to the shipping department, ProCharger is comprised of enthusiasts who share your passion for high performance.

### Billet Gear Cases

ProCharger designs and manufactures the centrifugal supercharger industry's only billet gear cases for superior rigidity, durability, sealing and appearance. This helps to support higher boost level and superior overall performance relative to other superchargers, as well as improved performance. Billet gear cases cost more than castings, but are representative of ProCharger's commitment to quality and high performance. Billet is also utilized for brackets, crank pulleys and other components.

These advantages, together with over 25 years of experience, help to explain why ProCharger leads the supercharging industry in patents and documented performance gains—as well as more records and championships in the past 10 years than all of our direct competitors combined.



### The ProCharger Campus

Made in the USA: From concept to finished product, all ProCharger Supercharger Systems are designed, tested and manufactured inside these state-of-the-art facilities.



## Exclusive Billet Impellers

Using state-of-the-art, five-axis CNC machines, ProCharger's proprietary impeller designs are crafted from aircraft-grade 7075 T-6 aluminum alloy for tremendous strength and performance. This top-tier material allows for larger impellers that weigh less, are free of the flaws found in typical cast impellers, and reliably produce more power.

Additionally, the precision bearings used in ProCharger superchargers are of consistently higher-quality and carry higher load ratings than those used by others.

**INVENTED, ENGINEERED**



**AND MADE IN THE USA**



# LEADERSHIP THROUGH INNOVATION

ENGINEERED QUALITY AND PERFORMANCE

## State-of-the-Art Test Facility

ProCharger's aerodynamics test lab utilizes state-of-the-art equipment and 3 separate test cells to help ensure that ProCharger superchargers are the best available. This test lab, the industry's largest and most capable, allows ProCharger engineers to simultaneously perform aerodynamic, gear case, and long term durability testing. A hallmark of the company's success has been a thorough understanding of engine dynamics and customer usage on the street, off road, and at the track. This helps ensure that testing in the lab, on the dyno and on the pavement are all representative of real world performance. Additionally, knowledge transferred from Inovair, Accessible Technologies' industrial products division which features gear cases designed for nonstop 24/7 operation and compressor efficiencies exceeding 80%, now helps fuel further advances for ProCharger superchargers.



Watch 3D Video







*Test lab, building #2 of the ProCharger campus*



*Engine dynos, building #1*



*Chassis dyno (1 of 2)*



*Aerodynamic test station (1 of 6)*

## Engineering Excellence

The ProCharger team includes the largest and most capable engineering staff in the aftermarket forced induction industry. For over two decades, this highly-skilled and dedicated team has produced the most innovation and greatest number of patents in the industry. Utilizing the latest software, collaboration with OEM auto makers and rapid prototyping, combined with extensive lab and real world testing, ProCharger systems are not only typically first-to-market, but also best-in-class for power-hungry HEMI car owners.



# POWERFUL HISTORY

## TIME LINE OF INNOVATION AND PERFORMANCE

### 1994-1996



ProCharger introduces the first air-to-air intercooled aftermarket supercharger system, featuring the P600B ProCharger supercharger.

ProCharger debuts the first blow-through centrifugal supercharger system for carbureted muscle cars and classic trucks.

State-of-the-art, CNC-machined billet impellers, a ProCharger exclusive, are introduced with the P600B. Designed for use with big blocks and intercooling, the P600B outflows other street-legal models by more than 65%.



ProCharger is the first centrifugal supercharger manufacturer to successfully supercharge marine engines and is also the first to offer integrated intercooling.

### 1997-1999



ATI/ProCharger moves into their own, newly-constructed, state-of-the-art manufacturing facility. The new location serves as engineering, R&D, technical service, customer service and marketing head-quarters, leading to a period of unprecedented product expansion.



An industrial customer uses a D-1 ProCharger to win a U.S. Air Force contract for an aircraft deicing system which utilizes forced air.



An Intercooled ProCharger System is the first to become 50 state legal with more than 8 psi of boost.

### 2000-2002

The first self-contained, gear-driven supercharger, the P-1SC, is produced by ProCharger. The patented design requires no external oil lines and becomes the industry standard.



ProCharger is the first centrifugal supercharger to power racers into the 6's. In fact, in 2002 every single supercharged Pro 5.0 racer in the 6's, Super Street and Street Outlaw racer in the 7's, and Renegade racer in the 8's, was ProCharged.



ProCharger introduces the first intercooled supercharger systems for 5.2L and 5.9L Dodge Magnum V8 Ram, Dakota and Durango models.

### 2003-2004



Having outgrown the existing facility, ProCharger breaks ground on a major building expansion.



The Little Red Wagon project appears on Stacey David's "Trucks!" TV show, produces 55-60% power gains on a Dodge Ram with a ProCharged 5.9L Magnum engine.



After being outlawed for years, a ProCharged racer wins the first centrifugal championship in NHRA.



A ProCharger-powered racer wins the prestigious HOT ROD Drag Week, earning the title: Fastest Street Car in America.

### 2005-2007

The HEMI is back! ProCharger is the first manufacturer to release a fully-engineered, tested and safely-tuned intercooled supercharger system for this new generation of late-model HEMI performance enthusiasts at the 2006 SEMA Show.



ProCharged racers win a record setting 11 International Championships in a season, and the best ProCharged 1/4 mile performance is reset to 6.18 ET @ 228 mph.





# "ProCharger is the world headquarters of supercharging." *—Bret Kepner, ESPN2*

## 2008

The SRT8 Challenger lights up the performance world and once again, ProCharger is first-to-market with a safe, reliable air-to-air intercooled supercharger system for 6.1L HEMI Challengers.



An F-3 ProCharged big block Ford wins HOT ROD's Pump Gas Drags, becoming the Fastest Pump Gas car in America. At Bonneville, ProCharger-power strikes the salt flats of Bonneville with the World's Fastest Production muscle cars running ProCharger superchargers.



With the introduction of helical gear sets for noise reduction, ProCharger becomes the first company to offer a choice of supercharger sound levels.



**Performance Product of the Year**

The Performance Product of the Year title is awarded to ProCharger for its Harley-Davidson® intercooled supercharger systems.

## 2009-2011



To accommodate continued growth, ProCharger expands operations into an adjacent facility and a state-of-the-art aerodynamic test center.



2009-10 Ram ProCharger Intercooled Systems are introduced, producing industry leading power.



ProCharger releases systems R/T for Challengers with the 5.7L HEMI.



Intercooled ProCharger Systems for 2006-10 Jeep Grand Cherokees receive praise for their unmatched performance, drivability and appearance.

## 2012-2016

ProCharger is once again first to market, this time for 392 Challengers and Chargers. Industry-leading ProCharger technology allows extremely reliable, bolt-on gains of 200+ HP with 6.4L HEMI's.



Rob Goss runs a 6.85 @ 204 (1/4 mile) to become the world's fastest Gen3 HEMI, as well as the X275 Record Holder.



ProCharger releases a rugged new Intercooled System for the Jeep 3.6L Wrangler JK.



Grand Cherokee SRT ProCharger Systems begin shipping. Testing demonstrates supercar performance, with ProCharger 0-60 mph times as quick as 3.4 sec.



## 2017-2018



Mopar Muscle installs a ProCharger system on a 6.4L Challenger, picks up over 200 HP, and states, "ProCharger was the only choice when it came to a 100 percent complete, bolt-on supercharger installation. They have been the leading aftermarket supercharger manufacturer for 25 years..."

3.587

ProCharger becomes the first in the 3.50's on a Drag Radial tire, 3.58@206.67 MPH! (F-3X-140 supercharger and Crankdrive)



Engine Power TV shows how to add 215+ hp to a 6.4L Grand Cherokee on 7psi.



ProCharger named Best New Racing Product at the 2018 SEMA Show.

## 2019-2020



Permatex Partners with ProCharger and PowerNationTV on Dodge Challenger build project.



Rob Goss sets HEMI record and wins X275 with F-3D-102 on his Challenger.



ProCharger Challenger stolen and recovered at 2019 SEMA Show!



ProCharged BAE HEMI wins JE pistons Master of Motors Award.



ProCharger is first and only centrifugal supercharger legal for NHRA Pro Mod, sponsors the class at US Nationals at Indy.



# FOR WHATEVER MOVES YOU

STREET, STRIP, SAND, SNOW AND WATER ... WE HAVE YOU COVERED



## ProCharger is The **ULTIMATE** Power Adder®

As a HEMI vehicle owner, you're all about awesome, tire-shredding horsepower, performance and every-day reliability. So why settle for anything less out of the other vehicles in your garage? In addition to being the leader in HEMI supercharger systems and kits, ProCharger has the most extensive lineup of supercharger solutions in the industry. From the four door family sedan to boats, pickup trucks, SUVs, Harley-Davidson® motorcycles, high-performance UTVs, classic muscle cars and all-out race and track cars, chances are that ProCharger has a supercharger solution for it. Give our Sales Team a call at (913) 338-2886 or visit us online at [procharger.com](http://procharger.com) for information.

**"In many applications, ProCharger's package is capable of generating a 50-percent or greater increase in power."**

*—Mopar Enthusiast*



**FOR EARLY MOPAR AND HEMI, CALL US TODAY FOR MORE INFO.**



# PROCHARGE YOUR LIFE

GET EQUIPPED, GET CONNECTED



## ProCharger Online: Catalogs, Apparel, Branded Items and more!

We invite you to take a tour of ProCharger.com and check out the ProCharger blog, videos page, vehicle gallery, and browse through the many different applications that we have available. If you own a ProCharger system, you can even create a vehicle gallery with your own ProCharged ride!



While you're there, don't forget to check out the online versions of ProCharger's industry leading catalogs and showcase your pride with a wide assortment of ProCharger branded items. From t-shirts and license plate frames, to gauges and can coolers, visit [www.ProCharger.com/store](http://www.ProCharger.com/store) to see the latest additions.



## Stay up to speed with the ProCharger Blog

Keep up with all the latest news, events and amazing, real-world customer and racer accomplishments via the ProCharger Blog, located at [www.ProCharger.com/blog](http://www.ProCharger.com/blog).





**INVENTED, ENGINEERED AND MADE IN THE USA**



All of us at ATI encourage you to use your newfound ProCharger power responsibly.  
Please drive safely and be respectful of your fellow engineists. If you feel the need to race, don't do it on the street—take it to the track!

ProCharger and The Ultimate Power Adder are registered trademarks of Accessible Technologies, Inc. Chrysler, Dodge, Jeep, Ram, Mopar, Challenger, Charger, Chrysler 300C, Magnum, Daytona, Durango, HEMI, 392 HEMI, Pentastar, R/T, SRT8, SRT, SRT Hellcat, Super Bee, Yellow Jacket, Grand Cherokee, and Wrangler are registered trademarks and Scat Pack is a trademark of FCA US LLC. MerCruiser is a registered trademark of Brunswick Corporation. Harley-Davidson is a registered trademark of Harley-Davidson, Inc. NASCAR is a registered trademark of The National Association for Stock Car Auto Racing, Inc. These names are used for descriptive purposes only; none of the products herein are authorized by, sponsored by, affiliated with, or otherwise approved by their respective owners.

© Copyright 2020, Accessible Technologies, Inc. 3/20

