



ONC+ Developer's Guide

Sun Microsystems, Inc.
4150 Network Circle
Santa Clara, CA 95054
U.S.A.

Part No: 816-1435-10
May, 2002

Copyright 2002 Sun Microsystems, Inc. 4150 Network Circle, Santa Clara, CA 95054 U.S.A. All rights reserved.

This product or document is protected by copyright and distributed under licenses restricting its use, copying, distribution, and decompilation. No part of this product or document may be reproduced in any form by any means without prior written authorization of Sun and its licensors, if any. Third-party software, including font technology, is copyrighted and licensed from Sun suppliers.

Parts of the product may be derived from Berkeley BSD systems, licensed from the University of California. UNIX is a registered trademark in the U.S. and other countries, exclusively licensed through X/Open Company, Ltd.

Sun, Sun Microsystems, the Sun logo, docs.sun.com, AnswerBook, AnswerBook2, --> and Solaris are trademarks, registered trademarks, or service marks of Sun Microsystems, Inc. in the U.S. and other countries. All SPARC trademarks are used under license and are trademarks or registered trademarks of SPARC International, Inc. in the U.S. and other countries. Products bearing SPARC trademarks are based upon an architecture developed by Sun Microsystems, Inc.

The OPEN LOOK and Sun™ Graphical User Interface was developed by Sun Microsystems, Inc. for its users and licensees. Sun acknowledges the pioneering efforts of Xerox in researching and developing the concept of visual or graphical user interfaces for the computer industry. Sun holds a non-exclusive license from Xerox to the Xerox Graphical User Interface, which license also covers Sun's licensees who implement OPEN LOOK GUIs and otherwise comply with Sun's written license agreements.

Federal Acquisitions: Commercial Software—Government Users Subject to Standard License Terms and Conditions.

DOCUMENTATION IS PROVIDED "AS IS" AND ALL EXPRESS OR IMPLIED CONDITIONS, REPRESENTATIONS AND WARRANTIES, INCLUDING ANY IMPLIED WARRANTY OF MERCHANTABILITY, FITNESS FOR A PARTICULAR PURPOSE OR NON-INFRINGEMENT, ARE DISCLAIMED, EXCEPT TO THE EXTENT THAT SUCH DISCLAIMERS ARE HELD TO BE LEGALLY INVALID.

Copyright 2002 Sun Microsystems, Inc. 4150 Network Circle, Santa Clara, CA 95054 U.S.A. Tous droits réservés

Ce produit ou document est protégé par un copyright et distribué avec des licences qui en restreignent l'utilisation, la copie, la distribution, et la décompilation. Aucune partie de ce produit ou document ne peut être reproduite sous aucune forme, par quelque moyen que ce soit, sans l'autorisation préalable et écrite de Sun et de ses bailleurs de licence, s'il y en a. Le logiciel détenu par des tiers, et qui comprend la technologie relative aux polices de caractères, est protégé par un copyright et licencié par des fournisseurs de Sun.

Des parties de ce produit pourront être dérivées du système Berkeley BSD licenciés par l'Université de Californie. UNIX est une marque déposée aux Etats-Unis et dans d'autres pays et licenciée exclusivement par X/Open Company, Ltd.

Sun, Sun Microsystems, le logo Sun, docs.sun.com, AnswerBook, AnswerBook2, et Solaris sont des marques de fabrique ou des marques déposées, ou marques de service, de Sun Microsystems, Inc. aux Etats-Unis et dans d'autres pays. Toutes les marques SPARC sont utilisées sous licence et sont des marques de fabrique ou des marques déposées de SPARC International, Inc. aux Etats-Unis et dans d'autres pays. Les produits portant les marques SPARC sont basés sur une architecture développée par Sun Microsystems, Inc.

L'interface d'utilisation graphique OPEN LOOK et Sun™ a été développée par Sun Microsystems, Inc. pour ses utilisateurs et licenciés. Sun reconnaît les efforts de pionniers de Xerox pour la recherche et le développement du concept des interfaces d'utilisation visuelle ou graphique pour l'industrie de l'informatique. Sun détient une licence non exclusive de Xerox sur l'interface d'utilisation graphique Xerox, cette licence couvrant également les licenciés de Sun qui mettent en place l'interface d'utilisation graphique OPEN LOOK et qui en outre se conforment aux licences écrites de Sun.

CETTE PUBLICATION EST FOURNIE "EN L'ETAT" ET AUCUNE GARANTIE, EXPRESSE OU IMPLICITE, N'EST ACCORDEE, Y COMPRIS DES GARANTIES CONCERNANT LA VALEUR MARCHANDE, L'APTITUDE DE LA PUBLICATION A REpondre A UNE UTILISATION PARTICULIERE, OU LE FAIT QU'ELLE NE SOIT PAS CONTREFAISANTE DE PRODUIT DE TIERS. CE DENI DE GARANTIE NE S'APPLIQUERAIT PAS, DANS LA MESURE OU IL SERAIT TENU JURIDIQUEMENT NUL ET NON AVENU.



020116@3062



Contents

Preface	21
1 Introduction to ONC+ Technologies	25
Brief Description of ONC+ Technologies	26
TI-RPC	26
XDR	26
NFS	26
NIS+	27
2 Introduction to TI-RPC	29
What Is TI-RPC?	29
TI-RPC Issues	30
Parameter Passing	31
Binding	31
Transport Protocol	31
Call Semantics	31
Data Representation	31
Program, Version, and Procedure Numbers	32
Overview of Interface Routines	32
Simplified Interface Routines	32
Standard Interface Routines	33
Network Selection	35
Transport Selection	36
Name-to-Address Translation	37
Address Look-up Services	37

	Registering Addresses	38
	Reporting RPC Information	39
3	rpcgen Programming Guide	41
	What Is rpcgen?	41
	SunOS 9 Software Environment Features	42
	rpcgen Tutorial	42
	Converting Local Procedures to Remote Procedures	43
	Passing Complex Data Structures	49
	Preprocessing Directives	54
	cpp Directive	55
	Compile-Time Flags	55
	Compile-Time Client and Server Templates	56
	Compile-Time C-style Mode	56
	Compile-Time MT-Safe Code	59
	Compile-Time MT Auto Mode	65
	Compile-Time TI-RPC or TS-RPC Library Selection	66
	Compile-Time ANSI C-compliant Code	66
	Compile-Time xdr_inline() Count	67
	rpcgen Programming Techniques	67
	Network Types/Transport Selection	68
	Command-Line Define Statements	68
	Server Response to Broadcast Calls	68
	Port Monitor Support	69
	Time-out Changes	70
	Client Authentication	70
	Dispatch Tables	71
	64-Bit Considerations for rpcgen	72
	IPv6 Considerations for rpcgen	74
	Debugging Applications	74
4	Programmer's Interface to RPC	77
	Simplified Interface	77
	Client Side of Simplified Interface	78
	Server Side of the Simplified Interface	80
	Hand-Coded Registration Routine	81
	Passing Arbitrary Data Types	81

Standard Interfaces	85
Top-Level Interface	86
Intermediate-Level Interface	89
Expert-Level Interface	92
Bottom-Level Interface	96
Server Caching	98
Low-Level Data Structures	98
Testing Programs Using Low-Level Raw RPC	101
Connection-Oriented Transports	103
Memory Allocation With XDR	106
5 Advanced RPC Programming Techniques	109
poll () on the Server Side	109
Broadcast RPC	111
Batching	113
Authentication	116
AUTH_SYS Authentication	118
AUTH_DES Authentication	120
AUTH_KERB Authentication	122
Authentication Using RPCSEC_GSS	123
RPCSEC_GSS API	124
RPCSEC_GSS Routines	125
Creating a Context	127
Changing Values and Destroying a Context	128
Principal Names	128
Receiving Credentials at the Server	130
Callbacks	132
Maximum Data Size	133
Miscellaneous Functions	133
Associated Files	133
Using Port Monitors	135
Using inetd	135
Using the Listener	136
Multiple Server Versions	137
Multiple Client Versions	139
Using Transient RPC Program Numbers	140

6	Porting From TS-RPC to TI-RPC	143
	Porting an Application	143
	Benefits of Porting	144
	IPv6 Considerations for RPC	144
	Porting Issues	145
	Differences Between TI-RPC and TS-RPC	145
	Function Compatibility Lists	146
	Creating and Destroying Services	147
	Registering and Unregistering Services	147
	SunOS Compatibility Calls	147
	Broadcasting	147
	Address Management Functions	148
	Authentication Functions	148
	Other Functions	148
	Comparison Examples	149
7	Multithreaded RPC Programming	153
	MT Client Overview	153
	MT Server Overview	155
	Sharing the Service Transport Handle	156
	MT Auto Mode	157
	MT User Mode	160
	Freeing Library Resources in User Mode	161
8	Extensions to the Sun RPC Library	165
	New Features	165
	One-Way Messaging	166
	<code>clnt_send()</code>	168
	oneway Attribute	168
	Non-Blocking I/O	171
	Using Non-Blocking I/O	172
	<code>clnt_call()</code> Configured as Non-Blocking	175
	Client Connection Closure Callback	175
	Example of client connection closure callback	176
	User File Descriptor Callbacks	182
	Example of User File Descriptors	183

9	NIS+ Programming Guide	193
	NIS+ Overview	193
	NIS+ Domains	193
	NIS+ and Servers	194
	NIS+ Tables	194
	NIS+ Security	195
	Name Service Switch	195
	NIS+ Administration Commands	195
	NIS+ API	197
	NIS+ Sample Program	200
	Unsupported Macros	201
	Functions Used in the Example	201
	Program Compilation	202
A	XDR Technical Note	213
	What Is XDR?	213
	Canonical Standard	216
	XDR Library	218
	XDR Library Primitives	220
	Memory Requirements for XDR Routines	220
	Number Filters	222
	Floating-Point Filters	223
	Enumeration Filters	223
	No-Data Routine	224
	Constructed Data Type Filters	224
	Strings	224
	Byte Arrays	225
	Arrays	226
	Opaque Data	229
	Fixed-Length Arrays	229
	Discriminated Unions	230
	Pointers	232
	Nonfilter Primitives	233
	Operation Directions	234
	Stream Access	234
	Standard I/O Streams	234
	Memory Streams	234

Record TCP/IP Streams	235
XDR Stream Implementation	236
XDR Object	236
Advanced XDR Topics	238
Linked Lists	238
B RPC Protocol and Language Specification	243
Protocol Overview	243
RPC Model	244
Transports and Semantics	244
Binding and Rendezvous Independence	245
Program and Procedure Numbers	246
Program Number Assignment	247
Program Number Registration	248
Other Uses of the RPC Protocol	248
RPC Message Protocol	249
Record-Marking Standard	252
Authentication Protocols	252
AUTH_NONE	252
AUTH_SYS	253
AUTH_DES Authentication	254
AUTH_DES Authentication Verifiers	255
Nicknames and Clock Synchronization	256
DES Authentication Protocol (in XDR language)	256
AUTH_KERB Authentication	259
RPC Language Specification	263
Example Service Described in the RPC Language	263
RPCL Syntax	264
RPCL Enumerations	265
RPCL Constants	266
RPCL Type Definitions	266
RPCL Declarations	266
RPCL Simple Declarations	266
RPCL Fixed-Length Array Declarations	267
RPCL Variable-Length Array Declarations	267
RPCL Pointer Declarations	268
RPCL Structures	268

	RPCL Unions	269
	RPCL Programs	269
	RPCL Special Cases	270
	rpcbind Protocol	272
	rpcbind Operation	277
C	XDR Protocol Specification	281
	XDR Protocol Introduction	281
	Graphic Box Notation	281
	Basic Block Size	282
	XDR Data Type Declarations	282
	Signed Integer	283
	Unsigned Integer	283
	Enumerations	284
	Booleans	284
	Hyper Integer and Unsigned Hyper Integer	285
	Floating Point	285
	Quadruple-Precision Floating Point	286
	Fixed-Length Opaque Data	287
	Variable-Length Opaque Data	288
	Counted Byte Strings	289
	Fixed-Length Array	290
	Variable-Length Array	291
	Structure	292
	Discriminated Union	292
	Void	293
	Constant	293
	Typedef	294
	Optional-Data	294
	XDR Language Specification	295
	Notational Conventions	295
	Lexical Notes	296
	Syntax Notes	297
	XDR Data Description	298
	RPC Language Reference	299

D	RPC Code Examples	301
	Directory Listing Program and Support Routines (rpcgen)	301
	Time Server Program (rpcgen)	305
	Add Two Numbers Program (rpcgen)	305
	Spray Packets Program (rpcgen)	306
	Print Message Program With Remote Version	307
	Batched Code Example	310
	Non-Batched Example	312
E	portmap Utility	315
	System Registration Overview	315
	portmap Protocol	316
	portmap Operation	318
	PMAPPROC_NULL	318
	PMAPPROC_SET	318
	PMAPPROC_UNSET	318
	PMAPPROC_GETPORT	319
	PMAPPROC_DUMP	319
	PMAPPROC_CALLIT	319
F	Writing a Port Monitor With the Service Access Facility (SAF)	321
	What Is the SAF?	321
	What Is the SAC?	322
	Basic Port Monitor Functions	322
	Port Management	323
	Activity Monitoring	323
	Other Port Monitor Functions	323
	Terminating a Port Monitor	325
	SAF Files	325
	Port Monitor Administrative File	325
	Per-Service Configuration Files	325
	Private Port Monitor Files	326
	SAC/Port Monitor Interface	326
	Message Formats	326
	Message Classes	328
	Port Monitor Administrative Interface	328
	SAC Administrative File _sactab	328

Port Monitor Administrative File <code>_pmtab</code>	329
SAC Administrative Command <code>sacadm</code>	331
Port Monitor Administrative Command <code>pmadm</code>	332
Monitor-Specific Administrative Command	332
Port Monitor/Service Interface	332
Port Monitor Requirements	333
Important Files	333
Port Monitor Responsibilities	334
Configuration Files and Scripts	335
Interpreting Configuration Scripts With <code>doconfig()</code>	335
Per-System Configuration File	336
Per-Port Monitor Configuration Files	336
Per-Service Configuration Files	336
Configuration Language	336
Printing, Installing, and Replacing Configuration Scripts	338
Sample Port Monitor Code	340
Logic Diagram and Directory Structure	345

Glossary 349

Index 353

Tables

TABLE 2-1	RPC Routines—Simplified Level	33
TABLE 2-2	RPC Routines—Top Level	33
TABLE 2-3	RPC Routines—Intermediate Level	34
TABLE 2-4	RPC Routines—Expert Level	34
TABLE 2-5	RPC Routines—Bottom Level	35
TABLE 2-6	nettype Parameters	35
TABLE 2-7	Name-to-Address Translation Routines	37
TABLE 3-1	rpcgen Preprocessing Directives	54
TABLE 3-2	rpcgen Compile-Time Flags	55
TABLE 3-3	rpcgen Template Selection Flags	56
TABLE 3-4	RPC Programming Techniques	67
TABLE 4-1	Primitive Type Equivalences	82
TABLE 5-1	Authentication Methods Supported by Sun RPC	116
TABLE 5-2	RPCSEC_GSS Functions	125
TABLE 5-3	RPC inetd Services	136
TABLE 6-1	Differences Between TI-RPC and TS-RPC	145
TABLE 7-1	rpc_control () Library Routines	157
TABLE 9-1	NIS+ Namespace Administration Commands	195
TABLE 9-2	NIS+ API Functions	197
TABLE 9-3	NIS+ Table Objects	203
TABLE B-1	RPC Program Number Assignment	247
TABLE B-2	RPC Language Definitions	265
TABLE C-1	XDR Data Description Example	299
TABLE F-1	Service Access Controller _sactab File	329
TABLE F-2	SVCTAG Service Entries	330
TABLE F-3	Key Port Monitor Files	334

Figures

FIGURE 1-1	ONC+ Distributed Computing Platform	25
FIGURE 2-1	How RPC Works	29
FIGURE 5-1	GSS-API and RPCSEC_GSS Security Layers	124
FIGURE 6-1	RPC Applications	144
FIGURE 7-1	Two Client Threads Using Different Client Handles (Real Time)	154
FIGURE 7-2	MT RPC Server Timing Diagram	156
FIGURE 8-1	One-Way Messaging	166
FIGURE 8-2	Two-Way Messaging	167
FIGURE 8-3	Non-Blocking Messaging	171
FIGURE 9-1	NIS+ Domain	193
FIGURE 9-2	NIS+ Tables	194
FIGURE B-1	Authentication Process Map	253
FIGURE E-1	Typical Portmap Sequence (For TCP/IP Only)	316
FIGURE F-1	SAF Logical Framework	345
FIGURE F-2	SAF Directory Structure	346

Examples

EXAMPLE 3-1	Single Process Version of <code>printmsg.c</code>	43
EXAMPLE 3-2	RPC Version of <code>printmsg.c</code>	45
EXAMPLE 3-3	Client Program to Call <code>printmsg.c</code>	46
EXAMPLE 3-4	RPC Protocol Description File: <code>dir.x</code>	49
EXAMPLE 3-5	Server <code>dir_proc.c</code> Example	50
EXAMPLE 3-6	Client-side Implementation of <code>rls.c</code>	51
EXAMPLE 3-7	Time Protocol <code>rpcgen</code> Source	54
EXAMPLE 3-8	C-style Mode Version of <code>add.x</code>	57
EXAMPLE 3-9	Default Mode Version of <code>add.x</code>	57
EXAMPLE 3-10	C-style Mode Client Stub for <code>add.x</code>	57
EXAMPLE 3-11	Default Mode Client	58
EXAMPLE 3-12	C-style Mode Server	59
EXAMPLE 3-13	Default Mode Server Stub	59
EXAMPLE 3-14	MT-Safe Program: <code>msg</code>	59
EXAMPLE 3-15	MT-Safe Client Stub	60
EXAMPLE 3-16	Client Stub (MT Unsafe)	61
EXAMPLE 3-17	MT-Safe Server Stub	61
EXAMPLE 3-18	MT-Safe Program: <code>add.x</code>	62
EXAMPLE 3-19	MT-Safe Client: <code>add.x</code>	63
EXAMPLE 3-20	MT-Safe Server: <code>add.x</code>	64
EXAMPLE 3-21	MT Auto Mode: <code>time.x</code>	65
EXAMPLE 3-22	<code>rpcgen</code> ANSI C Server Template	66
EXAMPLE 3-23	NFS Server Response to Broadcast Calls	68
EXAMPLE 3-24	<code>clnt_control</code> Routine	70
EXAMPLE 3-25	<code>AUTH_SYS</code> Authentication Program	70
EXAMPLE 3-26	<code>printmsg_1</code> for Superuser	71

EXAMPLE 3-27	Using a Dispatch Table	72
EXAMPLE 4-1	rusers Program	78
EXAMPLE 4-2	rusers Program Using Simplified Interface	79
EXAMPLE 4-3	xdr_simple Routine	83
EXAMPLE 4-4	xdr_varintarr Syntax Use	83
EXAMPLE 4-5	xdr_vector Syntax Use	84
EXAMPLE 4-6	xdr_reference Syntax Use	84
EXAMPLE 4-7	time_prot.h Header File	86
EXAMPLE 4-8	Client for Trivial Date Service	86
EXAMPLE 4-9	Server for Trivial Date Service	88
EXAMPLE 4-10	Client for Time Service, Intermediate Level	90
EXAMPLE 4-11	Server for Time Service, Intermediate Level	91
EXAMPLE 4-12	Client for RPC Lower Level	92
EXAMPLE 4-13	Server for RPC Lower Level	95
EXAMPLE 4-14	Client for Bottom Level	97
EXAMPLE 4-15	Server for Bottom Level	97
EXAMPLE 4-16	RPC Client Handle Structure	98
EXAMPLE 4-17	Client Authentication Handle	99
EXAMPLE 4-18	Server Transport Handle	99
EXAMPLE 4-19	Simple Program Using Raw RPC	101
EXAMPLE 4-20	Remote Copy (Two-Way XDR Routine)	103
EXAMPLE 4-21	Remote Copy Client Routines	104
EXAMPLE 4-22	Remote Copy Server Routines	105
EXAMPLE 5-1	svc_run() and poll()	110
EXAMPLE 5-2	RPC Broadcast	111
EXAMPLE 5-3	Collect Broadcast Replies	112
EXAMPLE 5-4	Unbatched Client	113
EXAMPLE 5-5	Batched Client	114
EXAMPLE 5-6	Batched Server	115
EXAMPLE 5-7	AUTH_SYS Credential Structure	118
EXAMPLE 5-8	Authentication Server	118
EXAMPLE 5-9	AUTH_DES Server	121
EXAMPLE 5-10	rpc_gss_seccreate()	127
EXAMPLE 5-11	rpc_gss_set_defaults()	128
EXAMPLE 5-12	rpc_gss_set_svc_name()	129
EXAMPLE 5-13	rpc_gss_get_principal_name()	130
EXAMPLE 5-14	Getting Credentials	131
EXAMPLE 5-15	Server Handle for Two Versions of Single Routine	137

EXAMPLE 5-16	Procedure for Two Versions of Single Routine	138
EXAMPLE 5-17	RPC Versions on Client Side	139
EXAMPLE 5-18	Transient RPC Program—Server Side	141
EXAMPLE 6-1	Client Creation in TS-RPC	149
EXAMPLE 6-2	Client Creation in TI-RPC	149
EXAMPLE 6-3	Broadcast in TS-RPC	150
EXAMPLE 6-4	Broadcast in TI-RPC	151
EXAMPLE 7-1	Server for MT Auto Mode	158
EXAMPLE 7-2	MT Auto Mode: <code>time_prot.h</code>	160
EXAMPLE 7-3	MT User Mode: <code>rpc_test.h</code>	161
EXAMPLE 7-4	Client for MT User Mode	161
EXAMPLE 9-1	NIS+ Routine to Create Directory Objects	202
EXAMPLE 9-2	NIS+ Routine to Create Group Objects	203
EXAMPLE 9-3	NIS+ Routine to Create Table Objects	203
EXAMPLE 9-4	NIS+ Routine to Add Objects to Table	204
EXAMPLE 9-5	NIS+ Routine for <code>nis_list</code> Call	206
EXAMPLE 9-6	NIS+ Routine to List Objects	206
EXAMPLE 9-7	NIS+ Routine to Remove Directory Objects	208
EXAMPLE 9-8	NIS+ Routine to Remove All Objects	209
EXAMPLE 9-9	NIS+ Program Execution	210
EXAMPLE A-1	Writer Example (initial)	214
EXAMPLE A-2	Reader Example (initial)	214
EXAMPLE A-3	Writer Example (XDR modified)	215
EXAMPLE A-4	Reader Example (XDR modified)	215
EXAMPLE A-5	<code>xdr_sizeof</code> Example #1	220
EXAMPLE A-6	<code>xdr_sizeof</code> Example #2	221
EXAMPLE A-7	Array Example #1	226
EXAMPLE A-8	Array Example #2	227
EXAMPLE A-9	Array Example #3	227
EXAMPLE A-10	<code>xdr_netobj</code> Routine	229
EXAMPLE A-11	<code>xdr_vector</code> Routine	229
EXAMPLE A-12	XDR Discriminated Union	231
EXAMPLE A-13	XDR Stream Interface Example	236
EXAMPLE A-14	Linked List	238
EXAMPLE A-15	<code>xdr_pointer</code>	239
EXAMPLE A-16	Nonrecursive Stack in XDR	240
EXAMPLE B-1	RPC Message Protocol	249
EXAMPLE B-2	AUTH_DES Authentication Protocol	256

EXAMPLE B-3	AUTH_KERB Authentication Protocol	261
EXAMPLE B-4	ping Service Using RPC Language	263
EXAMPLE B-5	rpcbind Protocol Specification in RPC Language	272
EXAMPLE C-1	XDR Specification	296
EXAMPLE C-2	XDR File Data Structure	298
EXAMPLE D-1	rpcgen Program: dir.x	301
EXAMPLE D-2	Remote dir_proc.c	302
EXAMPLE D-3	rls.c Client	303
EXAMPLE D-4	rpcgen Program: time.x	305
EXAMPLE D-5	rpcgen program: Add Two Numbers	305
EXAMPLE D-6	rpcgen program: spray.x	306
EXAMPLE D-7	printmesg.c	307
EXAMPLE D-8	Remote Version of printmesg.c	308
EXAMPLE D-9	rpcgen Program: msg.x	309
EXAMPLE D-10	mesg_proc.c	309
EXAMPLE D-11	Batched Client Program	310
EXAMPLE D-12	Batched Server Program	311
EXAMPLE D-13	Unbatched Version of Batched Client	312
EXAMPLE E-1	portmap Protocol Specification (in RPC Language)	317
EXAMPLE F-1	Sample Port Monitor	340
EXAMPLE F-2	sac.h Header File	343

Preface

The *ONC+ Developer's Guide* describes the programming interfaces to remote procedure call (RPC) and the network name service (NIS+), which belong to the ONC+™ distributed services developed at Sun Microsystems, Inc.

In this guide, the terms SunOS™ and Solaris™ are used interchangeably because the interfaces described in this manual are common to both. The Solaris 9 release is the Sun Microsystems distributed computing operating environment. It includes SunOS release 5.9 with the ONC+ technologies, OpenWindows™, ToolTalk™, DeskSet™, and OPEN LOOK, as well as other utilities.

All utilities, their options, and library functions in this manual reflect the current Solaris operating environment software developed by Sun Microsystems, Inc. If you are using a previous version of Solaris software, some utilities and library functions might function differently.

Who Should Use This Guide

The guide assists you in converting an existing single-computer application to a networked, distributed application, or developing and implementing distributed applications.

Use of this guide assumes basic competence in programming, a working familiarity with the C programming language, and a working familiarity with the UNIX® operating system. Previous experience in network programming is helpful, but is not required to use this manual.

How This Guide Is Organized

Chapter 1 gives a high-level introduction to the ONC+ distributed computing platform and services.

Chapter 2 introduces TI-RPC.

Chapter 3 describes how the `rpcgen` tool generates client and server stubs.

Chapter 4 describes the use of RPC in the programming environment.

Chapter 9 describes the NIS + applications programming interface.

Appendix A describes XDR and how it is used in data formatting and type conversion.

Appendix B describes the protocol of RPC usage, both syntax and limitations.

Appendix C describes the XDR protocol and language.

Appendix D contains complete functional listings of some of the code included in the document as examples.

Appendix E describes the `portmap` utility and its function. This appendix is included in this document to aid in the migration of applications written to run on earlier SunOS releases.

Appendix F describes the process of writing a port monitor application under the SAF and is included as a reference for applications development.

Related Books and Sites

For information on NFS distributed computing file system, see the following sources.

- *NFS: Network File System Version 3 Protocol Specification*. Sun Microsystems, 1993. You can view a PostScript copy by using anonymous ftp:
 - `ftp.uu.net:/networking/ip/nfs/NFS3.spec.ps.Z` `bcm.tmc.edu:/nfs/nfsv3.ps.Z`
`gatekeeper.dec.com:/pub/standards/nfs/nfsv3.ps.Z`
- *1094 NFS: Network File System Protocol Specification Version 2*
- *1813 NFS Version 3 Protocol Specification*
- *1831 RPC: Remote Procedure Call Protocol Specification Version 2*

- 1832 XDR: *External Data Representation Standard*

The following third-party books and articles provide information on network programming topics.

- Brent Callaghan. *NFS Illustrated*, Addison-Wesley Professional Computing Series. ISBN: 0201325705
- W. Richard Stevens. "Networking APIs: Sockets and XTI in *UNIX Network Programming Volume 1*. Englewood Cliffs, N.J. : Prentice Hall Software Series, 1990. Describes UNIX network programming, including code examples. Covers IPv4 and IPv6, sockets and XTI, TCP and UDP, raw sockets, programming techniques, multicasting, and broadcasting.
- John Bloomer. *Power Programming with RPC* Sebastopol, Calif.: O'Reilly & Associates, Inc, 1992.

Accessing Sun Documentation Online

The docs.sun.comSM Web site enables you to access Sun technical documentation online. You can browse the docs.sun.com archive or search for a specific book title or subject. The URL is <http://docs.sun.com>.

Typographic Conventions

The following table describes the typographic changes used in this book.

TABLE P-1 Typographic Conventions

Typeface or Symbol	Meaning	Example
AaBbCc123	The names of commands, files, and directories; on-screen computer output	Edit your <code>.login</code> file. Use <code>ls -a</code> to list all files. <code>machine_name% you have mail.</code>
AaBbCc123	What you type, contrasted with on-screen computer output	<code>machine_name% su</code> Password:

TABLE P-1 Typographic Conventions (Continued)

Typeface or Symbol	Meaning	Example
<i>AaBbCc123</i>	Command-line placeholder: replace with a real name or value	To delete a file, type rm <i>filename</i> .
<i>AaBbCc123</i>	Book titles, new words, or terms, or words to be emphasized.	Read Chapter 6 in <i>User's Guide</i> . These are called <i>class</i> options. You must be <i>root</i> to do this.

Shell Prompts in Command Examples

The following table shows the default system prompt and superuser prompt for the C shell, Bourne shell, and Korn shell.

TABLE P-2 Shell Prompts

Shell	Prompt
C shell prompt	machine_name%
C shell superuser prompt	machine_name#
Bourne shell and Korn shell prompt	\$
Bourne shell and Korn shell superuser prompt	#

Introduction to ONC+ Technologies

This chapter briefly introduces ONC+ technologies, the Sun™ open systems distributed computing environment. The ONC+ technologies are the core services available to developers who implement distributed applications in a heterogeneous distributed computing environment. ONC+ technologies also include tools to administer client/server networks.

Figure 1-1 shows an integrated view of how client-server applications are built on top of ONC+ technologies, and how they sit on top of the low-level networking protocols.

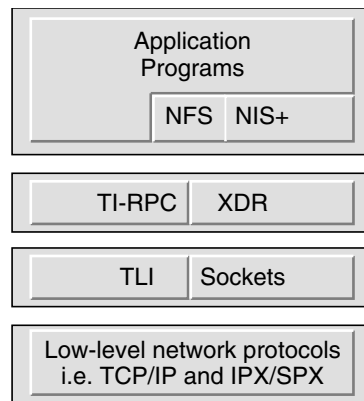

FIGURE 1-1 ONC+ Distributed Computing Platform

Brief Description of ONC+ Technologies

ONC+ technologies consist of a family of technologies, services, and tools. These technologies are backward compatible and interoperate with the installed base of ONC services. The main components are described. This guide covers the technologies that require the use of programming facilities.

TI-RPC

The transport-independent remote procedure call (TI-RPC) was developed as part of UNIX System V Release 4 (SVR4). TI-RPC makes RPC applications transport-independent by enabling a single binary version of a distributed program to run on multiple transports. Previously, with transport-specific RPC, the transport was bound at compile time so that applications could not use other transports unless the program was rebuilt. With TI-RPC, applications can use new transports if the system administrator updates the network configuration file and restarts the program. Thus, no changes are required to the binary application.

XDR

External data representation (XDR) is an architecture-independent specification for representing data. It resolves the differences in data byte ordering, data type size, representation, and alignment between different architectures. Applications that use XDR can exchange data across heterogeneous hardware systems.

NFS

NFS is a distributed computing file system that provides transparent access to remote file systems on heterogeneous networks. In this way, users can share files among PCs, workstations, mainframes, and supercomputers. As long as users are connected to the same network, the files appear as though they are on the user's desktop. The NFS environment features Kerberos V5 authentication, multithreading, the network lock manager, and the automounter.

NFS does not have programming facilities, so it is not covered in this guide. However, the specification for NFS is available through anonymous ftp at:

- `ftp.uu.net:/networking/ip/nfs/NFS3.spec.ps.Z` `bcm.tmc.edu:/nfs/nfsv3.ps.Z`
`gatekeeper.dec.com:/pub/standards/nfs/nfsv3.ps.Z`

NIS+

NIS+ is the enterprise naming service in the Solaris environment. It provides a scalable and secure information base for host names, network addresses, and user names. NIS+ makes administration of large, multivendor client/server networks easier by being the central point for adding, removing, and relocating network resources. Changes made to the NIS+ information base are automatically and immediately propagated to replica servers across the network. This propagation ensures that system uptime and performance are preserved. Security is integral to NIS+. Unauthorized users and programs are prevented from reading, changing, or destroying naming service information.

Introduction to TI-RPC

This section provides an overview of TI-RPC, also known as Sun RPC. The information presented is most useful to someone new to RPC. See the Glossary for the definition of the terms used in this guide.

Topics covered in this chapter include:

- “What Is TI-RPC?” on page 29
- “TI-RPC Issues” on page 30
- “Overview of Interface Routines” on page 32
- “Network Selection” on page 35
- “Transport Selection” on page 36
- “Address Look-up Services” on page 37

What Is TI-RPC?

TI-RPC is a powerful technique for constructing distributed, client-server based applications. It is based on extending the notion of conventional, or local, procedure calling so that the called procedure need not exist in the same address space as the calling procedure. The two processes might be on the same system, or they might be on different systems with a network connecting them.

By using RPC, programmers of distributed applications avoid the details of the interface with the network. The transport independence of RPC isolates the application from the physical and logical elements of the data communications mechanism and enables the application to use a variety of transports.

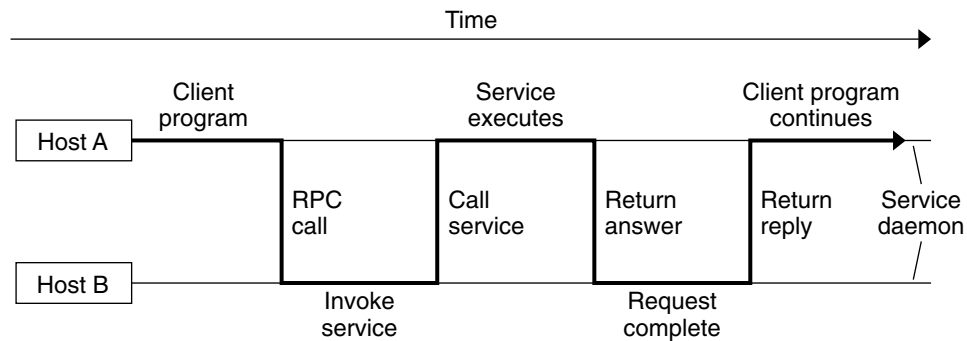

FIGURE 2-1 How RPC Works

An RPC is analogous to a function call. Like a function call, when an RPC is made, the calling arguments are passed to the remote procedure and the caller waits for a response to be returned from the remote procedure.

Figure 2-1 shows the flow of activity that takes place during an RPC call between two networked systems. The client makes a procedure call that sends a request to the server and waits. The thread is blocked from processing until either a reply is received, or the request times out. When the request arrives, the server calls a dispatch routine that performs the requested service, and sends the reply to the client. After the RPC call is completed, the client program continues.

RPC specifically supports network applications. TI-RPC runs on available networking mechanisms such as TCP/IP. Other RPC standards are OSF DCE (based on Apollo's NCS system), Xerox Courier, and Netwise.

TI-RPC Issues

A number of issues help to characterize a particular RPC implementation.

- How are parameters and results passed?
- How is binding carried out?
- How are transport protocols dealt with?
- What are the call semantics?
- What data representation is used?

Parameter Passing

TI-RPC allows a single parameter to be passed from client to server. If more than one parameter is required, the components can be combined into a structure that is counted as a single element. Information passed from server to client is passed as the function's return value. Information cannot be passed back from server to client through the parameter list.

Binding

The client must know how to contact the service. The two necessary aspects are finding out which host the server is on, and then connecting to the actual server process. On each host, a service called `rpcbind` manages RPC services. TI-RPC uses the available host-naming services, such as the `hosts` and `ipnodes` file, NIS+, and DNS, to locate a host.

Transport Protocol

The transport protocol specifies how the call message and the reply message are transmitted between client and server. TS-RPC used TCP and UDP as transport protocols, but the current version of TI-RPC is transport independent, so it works with any transport protocol.

Call Semantics

Call semantics define what the client can assume about the execution of the remote procedure; in particular, how many times the procedure was executed. These semantics are important in dealing with error conditions. The three alternatives are *exactly once*, *at most once*, and *at least once*. ONC+ provides *at least once* semantics. Procedures called remotely are *idempotent*: they should return the same result each time they are called, even through several iterations.

Data Representation

Data representation describes the format used for parameters and results as they are passed between processes. To function on a variety of system architectures, RPC requires a standard data representation. TI-RPC uses external data representation (XDR). XDR is a machine-independent data description and encoding protocol. Using XDR, RPC can handle arbitrary data structures, regardless of the byte orders or structure layout conventions of the different hosts. For a detailed discussion of XDR, see Appendix A and Appendix C.

Program, Version, and Procedure Numbers

A remote procedure is uniquely identified by the triple:

- Program number
- Version number
- Procedure number

The *program* number identifies a group of related remote procedures, each of which has a unique procedure number.

A program can consist of one or more *versions*. Each version consists of a collection of procedures that are available to be called remotely. Version numbers enable multiple versions of an RPC protocol to be available simultaneously.

Each version contains a number of procedures that can be called remotely. Each procedure has a *procedure* number.

“Program and Procedure Numbers” on page 246 lists the range of values and their significance and tells you how to have a program number assigned to your RPC program. A list of mappings of RPC service name to program number is available in the RPC network database `/etc/rpc`.

Overview of Interface Routines

RPC has multiple levels of application interface to its services. These levels provide different degrees of control balanced with different amounts of interface code to implement, in order of increasing control and complexity. This section gives a summary of the routines available at each level.

Simplified Interface Routines

The simplified interfaces are used to make remote procedure calls to routines on other machines, and specify only the type of transport to use. The routines at this level are used for most applications. Descriptions and code samples are in the section “Simplified Interface” on page 77.

TABLE 2-1 RPC Routines—Simplified Level

Routine	Function
<code>rpc_reg()</code>	Registers a procedure as an RPC program on all transports of the specified type
<code>rpc_call()</code>	Remotely calls the specified procedure on the specified remote host
<code>rpc_broadcast()</code>	Broadcasts a call message across all transports of the specified type

Standard Interface Routines

The standard interfaces are divided into *top level*, *intermediate level*, *expert level*, and *bottom level*. These interfaces give a programmer much greater control over communication parameters such as the transport being used, how long to wait before responding to errors and retransmitting requests, and so on.

Top-Level Routines

At the top level, the interface is still simple, but the program has to create a client handle before making a call or create a server handle before receiving calls. If you want the application to run on all transports, use this interface. You can find the use of these routines and code samples in “Top-Level Interface” on page 86.

TABLE 2-2 RPC Routines—Top Level

Routine	Description
<code>clnt_create()</code>	Generic client creation. The program tells <code>clnt_create()</code> where the server is located and the type of transport to use.
<code>clnt_create_timed()</code>	Similar to <code>clnt_create()</code> but enables the programmer to specify the maximum time allowed for each type of transport tried during the creation attempt.
<code>svc_create()</code>	Creates server handles for all transports of the specified type. The program tells <code>svc_create()</code> which dispatch function to use.
<code>clnt_call()</code>	Client calls a procedure to send a request to the server.

Intermediate-Level Routines

The intermediate level interface of RPC enables you to you control details. Programs written at these lower levels are more complicated but run more efficiently. The intermediate level enables you to specify the transport to use. “Intermediate-Level Interface” on page 89 describes the use of these routines and code samples.

TABLE 2-3 RPC Routines—Intermediate Level

Routine	Description
<code>clnt_tp_create()</code>	Creates a client handle for the specified transport
<code>clnt_tp_create_timed()</code>	Similar to <code>clnt_tp_create()</code> but enables the programmer to specify the maximum time allowed
<code>svc_tp_create()</code>	Creates a server handle for the specified transport
<code>clnt_call()</code>	Client calls a procedure to send a request to the server

Expert-Level Routines

The expert level contains a larger set of routines with which to specify transport-related parameters. “Expert-Level Interface” on page 92 describes the use of these routines and code samples.

TABLE 2-4 RPC Routines—Expert Level

Routine	Description
<code>clnt_tli_create()</code>	Creates a client handle for the specified transport
<code>svc_tli_create()</code>	Creates a server handle for the specified transport
<code>rpcb_set()</code>	Calls <code>rpcbind</code> to set a map between an RPC service and a network address
<code>rpcb_unset()</code>	Deletes a mapping set by <code>rpcb_set()</code>
<code>rpcb_getaddr()</code>	Calls <code>rpcbind()</code> to get the transport addresses of specified RPC services
<code>svc_reg()</code>	Associates the specified program and version number pair with the specified dispatch routine
<code>svc_unreg()</code>	Deletes an association set by <code>svc_reg()</code>
<code>clnt_call()</code>	Client calls a procedure to send a request to the server

Bottom-Level Routines

The bottom level contains routines used for full control of transport options. “Bottom-Level Interface” on page 96 describes these routines.

TABLE 2-5 RPC Routines—Bottom Level

Routine	Description
<code>clnt_dg_create()</code>	Creates an RPC client handle for the specified remote program using a connectionless transport
<code>svc_dg_create()</code>	Creates an RPC server handle using a connectionless transport
<code>clnt_vc_create()</code>	Creates an RPC client handle for the specified remote program using a connection-oriented transport
<code>svc_vc_create()</code>	Creates an RPC server handle using a connection-oriented transport
<code>clnt_call()</code>	Client calls a procedure to send a request to the server

Network Selection

You can write programs to run on a specific transport or transport type, or to operate on a system-chosen or user-chosen transport. Two mechanisms for network selection are the `/etc/netconfig` database and the environmental variable `NETPATH`. These mechanisms enable a fine degree of control over network selection: a user can specify a preferred transport and an application will use it if it can. If the specified transport is inappropriate, the application automatically tries other transports with the right characteristics.

`/etc/netconfig` lists the transports available to the host and identifies them by type. `NETPATH` is optional and enables you to specify a transport or selection of transports from the list in `/etc/netconfig`. By setting the `NETPATH`, you specify the order in which the application tries the available transports. If `NETPATH` is not set, the system defaults to all visible transports specified in `/etc/netconfig`, in the order that they appear in that file.

For more details on network selection, see the `getnetconfig(3NSL)` and `netconfig(4)` man pages.

RPC divides selectable transports into the types described in the following table:

TABLE 2-6 `nettype` Parameters

Value	Meaning
<code>NULL</code>	Same as selecting <code>netpath</code> .

TABLE 2-6 nettype Parameters (Continued)

Value	Meaning
visible	Uses the transports chosen with the visible flag ('v') set in their /etc/netconfig entries.
circuit_v	Same as visible, but restricted to connection-oriented transports. Transports are selected in the order listed in /etc/netconfig.
datagram_v	Same as visible, but restricted to connectionless transports.
circuit_n	Uses the connection-oriented transports chosen in the order defined in NETPATH.
datagram_n	Uses the connectionless transports chosen in the order defined in NETPATH.
udp	Specifies Internet User Datagram Protocol (UDP).
tcp	Specifies Internet Transport Control Protocol (TCP).

Transport Selection

RPC services are supported on both circuit-oriented and datagram transports. The selection of the transport depends on the requirements of the application.

Choose a datagram transport if the application has all of the following characteristics:

- Calls to the procedures do not change the state of the procedure or of associated data.
- The size of both the arguments and results is smaller than the transport packet size.
- The server is required to handle hundreds of clients. A datagram server does not keep any state data on clients, so it can potentially handle many clients. A circuit-oriented server keeps state data on each open client connection, so the number of clients is limited by the host resources.

Choose a circuit-oriented transport if the application has any of the following characteristics:

- The application can tolerate or justify the higher cost of connection setup compared to datagram transports.
- Calls to the procedures can change the state of the procedure or of associated data.
- The size of either the arguments or the results exceeds the maximum size of a datagram packet.

Name-to-Address Translation

Each transport has an associated set of routines that translate between universal network addresses (string representations of transport addresses) and the local address representation. These universal addresses are passed around within the RPC system (for example, between `rpcbind` and a client). A runtime linkable library that contains the name-to-address translation routines is associated with each transport. Table 2-7 shows the main translation routines.

For more details on these routines, see the `netdir(3NSL)` man page. Note that the `netconfig` structure in each case provides the context for name-to-address translations.

TABLE 2-7 Name-to-Address Translation Routines

<code>netdir_getbyname()</code>	Translates from host or service pairs (for example <code>server1</code> , <code>rpcbind</code>) and a <code>netconfig</code> structure to a set of <code>netbuf</code> addresses. <code>netbufs</code> are Transport Level Interface (TLI) structures that contain transport-specific addresses at runtime.
	Translates from <code>netbuf()</code> addresses and a <code>netconfig</code> structure to host or service pairs.
<code>uaddr2taddr()</code>	Translates from universal addresses and a <code>netconfig()</code> structure to <code>netbuf</code> addresses.
<code>taddr2uaddr()</code>	Translates from <code>netbuf</code> addresses and a <code>netconfig</code> structure to universal addresses.

Address Look-up Services

Transport services do not provide address look-up services. They provide only message transfer across a network. A client program needs a way to obtain the address of its server program. In previous system releases this service was performed by `portmap`. In this release, `rpcbind` replaces the `portmap` utility.

RPC makes no assumption about the structure of a network address. It handles universal addresses specified only as null-terminated strings of ASCII characters. RPC translates universal addresses into local transport addresses by using routines specific to the transport. For more details on these routines, see the `netdir(3NSL)` and `rpcbind(3NSL)` man pages.

`rpcbind` enables you to perform the following operations:

- Add a registration
- Delete a registration

- Get address of a specified program number, version number, and transport
- Get the complete registration list
- Perform a remote call for a client

Registering Addresses

`rpcbind` maps RPC services to their addresses, so `rpcbind`'s address must be known. The name-to-address translation routines must reserve a known address for each type of transport used. For example, in the Internet domain, `rpcbind` has port number 111 on both TCP and UDP. When `rpcbind` is started, it registers its location on each of the transports supported by the host. `rpcbind` is the only RPC service that must have a known address.

For each supported transport, `rpcbind` registers the addresses of RPC services and makes the addresses available to clients. A service makes its address available to clients by registering the address with the `rpcbind` daemon. The address of the service is then available to `rpcinfo(1M)` and to programs using library routines named in the `rpcbind(3NSL)` man page. No client or server can assume the network address of an RPC service.

Client and server programs and client and server hosts are usually distinct but they need not be. A server program can also be a client program. When one server calls another `rpcbind` server it makes the call as a client.

To find a remote program's address, a client sends an RPC message to a host's `rpcbind` daemon. If the service is on the host, the daemon returns the address in an RPC reply message. The client program can then send RPC messages to the server's address. A client program can minimize its calls to `rpcbind` by storing the network addresses of recently called remote programs.

The `RPCBPROC_CALLIT` procedure of `rpcbind` enables a client to make a remote procedure call without knowing the address of the server. The client passes the target procedure's program number, version number, procedure number, and calling arguments in an RPC call message. `rpcbind` looks up the target procedure's address in the address map and sends an RPC call message, including the arguments received from the client, to the target procedure.

When the target procedure returns results, `RPCBPROC_CALLIT` passes them to the client program. It also returns the target procedure's universal address so that the client can later call it directly.

The RPC library provides an interface to all `rpcbind` procedures. Some of the RPC library procedures also call `rpcbind` automatically for client and server programs. For details, see "RPC Language Specification" on page 263.

Reporting RPC Information

`rpcinfo` is a utility that reports current RPC information registered with `rpcbind`. `rpcinfo`, with either `rpcbind` or the `portmap` utility, reports the universal addresses and the transports for all registered RPC services on a specified host. `rpcinfo` can call a specific version of a specific program on a specific host and report whether a response is received. `rpcinfo` can also delete registrations. For details, see the `rpcinfo(1M)` man page.

rpcgen Programming Guide

This section introduces the `rpcgen` tool and provides a tutorial with code examples and usage of the available compile-time flags. See Glossary for the definition of the terms used in this chapter.

The topics covered in this chapter include:

- “SunOS 9 Software Environment Features” on page 42
- “`rpcgen` Tutorial” on page 42
- “Compile-Time Flags” on page 55
- “`rpcgen` Programming Techniques” on page 67

What Is `rpcgen`?

The `rpcgen` tool generates remote program interface modules. It compiles source code written in the RPC language. The RPC language is similar in syntax and structure to C. The `rpcgen` tool produces one or more C language source modules, which are then compiled by a C compiler.

The default output of `rpcgen` is:

- A header file of definitions common to the server and the client
- A set of XDR routines that translate each data type defined in the header file
- A stub program for the server
- A stub program for the client

`rpcgen` can optionally generate:

- Various transports
- A timeout for servers
- Server stubs that are multithread safe

- Server stubs that are not main programs
- C-style arguments passing ANSI C-compliant code
- An RPC dispatch table that checks authorizations and invokes service routines

`rpcgen` significantly reduces the development time that would otherwise be spent developing low-level routines. Handwritten routines link easily with the `rpcgen` output. For a discussion of RPC programming without `rpcgen`, see Chapter 4.

SunOS 9 Software Environment Features

This section lists the features found in the current `rpcgen` code generator.

- SunOS Template Generation: `rpcgen` generates client-side, server-side, and makefile templates. See “Compile-Time Client and Server Templates” on page 56 for the list of options.
- SunOS C-style Mode: `rpcgen` has two compilation modes, C-style and default. In C-style mode arguments can be passed by value, instead of as pointers to a structure. It also supports passing multiple arguments. The default mode is the same as in previous releases. See “Compile-Time C-style Mode” on page 56 for the example code for both modes.
- SunOS Multithread-Safe Code: `rpcgen` generates MT-safe code for use in a threaded environment. By default, the code generated by `rpcgen` is not MT safe. See “Compile-Time MT-Safe Code” on page 59 for the description and example code.
- SunOS Multithread Auto Mode: `rpcgen` generates MT-safe server stubs that operate in the MT Auto mode. See “Compile-Time MT Auto Mode” on page 65 for the definition and example code.
- SunOS Library Selection: `rpcgen` uses library calls for either TS-RPC or TI-RPC. See “Compile-Time TI-RPC or TS-RPC Library Selection” on page 66.
- SunOS ANSI C-compliant Code: The output generated by `rpcgen` conforms to ANSI C standards. See “Compile-Time ANSI C-compliant Code” on page 66.

`rpcgen` Tutorial

`rpcgen` provides programmers a direct way to write distributed applications. Server procedures can be written in any language that observes procedure-calling conventions. These procedures are linked with the server stub produced by `rpcgen` to form an executable server program. Client procedures are written and linked in the same way.

This section presents some basic `rpcgen` programming examples. Refer also to the `rpcgen(1)` man page.

Converting Local Procedures to Remote Procedures

Assume that an application runs on a single computer and you want to convert it to run in a “distributed” manner on a network. This example shows the stepwise conversion of this program that writes a message to the system console. The following code example shows the original program.

EXAMPLE 3-1 Single Process Version of `printmesg.c`

```
/* printmesg.c: print a message on the console */

#include <stdio.h>

main(argc, argv)
    int argc;
    char *argv[];
{
    char *message;

    if (argc != 2) {
        fprintf(stderr, "usage: %s <message>\n",
            argv[0]);
        exit(1);
    }
    message = argv[1];
    if (!printmessage(message)) {
        fprintf(stderr, "%s: couldn't print your
            message\n", argv[0]);
        exit(1);
    }
    printf("Message Delivered!\n");
    exit(0);
}

/* Print a message to the console.
 * Return a boolean indicating whether
 * the message was actually printed. */
printmessage(msg)
    char *msg;
{
    FILE *f;
    f = fopen("/dev/console", "w");
    if (f == (FILE *)NULL) {
        return (0);
    }
    fprintf(f, "%s\n", msg);
    fclose(f);
    return(1);
}
```

EXAMPLE 3-1 Single Process Version of `printmsg.c` (Continued)

For local use on a single machine, this program could be compiled and executed as follows:

```
$ cc printmsg.c -o printmsg
$ printmsg "Hello, there."
Message delivered!
$
```

If the `printmessage()` function is turned into a remote procedure, the function can be called from anywhere in the network.

First, determine the data types of all procedure-calling arguments and the resulting argument. The calling argument of `printmessage()` is a string, and the result is an integer. You can write a protocol specification in the RPC language that describes the remote version of `printmessage()`. The RPC language source code for such a specification is:

```
/* msg.x: Remote msg printing protocol */
program MESSAGEPROG {
    version PRINTMESSAGEVERS {
        int PRINTMESSAGE(string) = 1;
    } = 1;
} = 0x20000001;
```

Remote procedures are always declared as part of remote programs. The previous code declares an entire remote program that contains the single procedure `PRINTMESSAGE`. In this example, the `PRINTMESSAGE` procedure is declared to be procedure 1, in version 1 of the remote program `MESSAGEPROG`, with the program number `0x20000001`. See Appendix B for guidance on choosing program numbers.

Version numbers are incremented when functionality is changed in the remote program. Existing procedures can be changed or new ones can be added. More than one version of a remote program can be defined and a version can have more than one procedure defined.

Note that the program and procedure names are declared with all capital letters.

Note also that the argument type is `string` and not `char *` as it would be in C. This is because a `char *` in C is ambiguous. `char` usually means an array of characters, but it could also represent a pointer to a single character. In the RPC language, a null-terminated array of `char` is called a string.

You have just two more programs to write:

- The remote procedure itself
- The main client program that calls it

Example 3-2 is a remote procedure that implements the `PRINTMESSAGE` procedure in Example 3-1.

EXAMPLE 3-2 RPC Version of printmsg.c

```
/*
 * msg_proc.c: implementation of the
 * remote procedure "printmessage"
 */
#include <stdio.h>
#include "msg.h"          /* msg.h generated by rpcgen */

int *
printmessage_1(msg, req)
char **msg;
struct svc_req *req;    /* details of call */
{
    static int result;    /* must be static! */
    FILE *f;

    f = fopen("/dev/console", "w");
    if (f == (FILE *)NULL) {
        result = 0;
        return (&result);
    }
    fprintf(f, "%s\n", *msg);
    fclose(f);
    result = 1;
    return (&result);
}
```

The declaration of the remote procedure `printmessage_1()` differs from that of the local procedure `printmessage()` in four ways:

1. `printmessage_1()` takes a pointer to the character array instead of the pointer itself. This principle is true of all remote procedures when the `-N` option is not used. These procedures always take pointers to their arguments rather than the arguments themselves. Without the `-N` option, remote procedures are always called with a single argument. If more than one argument is required the arguments must be passed in a struct.
2. `printmessage_1()` is called with two arguments. The second argument contains information on the context of an invocation: the program, version, and procedure numbers; raw and canonical credentials; and an `SVCXPRT` structure pointer. The `SVCXPRT` structure contains transport information. All of the information is made available in case the invoked procedure requires it to perform the request.
3. `printmessage_1()` returns a pointer to an integer instead of the integer itself. This principle is also true of remote procedures when the `-N` option is not used. These procedures return pointers to the result. The result should be declared static unless the `-M` (multithread) or `-A` (Auto mode) options are used. Ordinarily, if the result is declared local to the remote procedure, references to the result by the server stub are invalid after the remote procedure returns. In the case of `-M` and `-A` options, a pointer to the result is passed as a third argument to the procedure, so the result is not declared in the procedure.

4. An `_1` is appended to the `printmessage_1()` name. In general, all remote procedures calls generated by `rpcgen` are named as follows: the procedure name in the program definition (here `PRINTMESSAGE`) is converted to all lowercase letters, an underbar (`_`) is appended to it, and the version number (here `1`) is appended. This naming scheme enables you to have multiple versions of the same procedure.

The following code example shows the main client program that calls the remote procedure.

EXAMPLE 3-3 Client Program to Call `printmsg.c`

```
/*
 * rprintmsg.c: remote version
 * of "printmsg.c"
 */
#include <stdio.h>
#include "msg.h"          /* msg.h generated by rpcgen */

main(argc, argv)
    int argc;
    char *argv[];
{
    CLIENT *clnt;
    int *result;
    char *server;
    char *message;

    if (argc != 3) {
        fprintf(stderr, "usage: %s host
            message\n", argv[0]);
        exit(1);
    }

    server = argv[1];
    message = argv[2];
    /*
     * Create client "handle" used for
     * calling MESSAGEPROG on the server
     * designated on the command line.
     */
    clnt = clnt_create(server, MESSAGEPROG,
        PRINTMESSAGEEVERS,
        "visible");

    if (clnt == (CLIENT *)NULL) {
        /*
         * Couldn't establish connection
         * with server.
         * Print error message and die.
         */
        clnt_pcreateerror(server);
        exit(1);
    }
    /*
```

EXAMPLE 3-3 Client Program to Call `printmsg.c` (Continued)

```
    * Call the remote procedure
* "printmessage" on the server
*/
result = printmessage_1(&message, clnt);
if (result == (int *)NULL) {
    /*
    * An error occurred while calling
* the server.
    * Print error message and die.
    */
    clnt_perror(clnt, server);
    exit(1);
}
/* Okay, we successfully called
* the remote procedure.
*/
if (*result == 0) {
    /*
    * Server was unable to print
* our message.
    * Print error message and die.
    */
    fprintf(stderr,
"%s: could not print your message\n", argv[0]);
    exit(1);
}
/* The message got printed on the
* server's console
*/
printf("Message delivered to %s\n",
server);
clnt_destroy( clnt );
exit(0);}
```

In the example code, a client handle is created by the RPC library routine `clnt_create()`. This client handle is passed to the stub routine that calls the remote procedure. See Chapter 4 for details on how the client handle can be created in other ways. If no more calls are to be made using the client handle, destroy it with a call to `clnt_destroy()` to conserve system resources.

The last parameter to `clnt_create()` is `visible`, which specifies that any transport noted as visible in `/etc/netconfig` can be used. For further information on transports, see the `/etc/netconfig` file and its description in *Programming Interfaces Guide*.

The remote procedure `printmessage_1()` is called exactly the same way as it is declared in `msg_proc.c`, except for the inserted client handle as the second argument. The remote procedure also returns a pointer to the result instead of the result.

The remote procedure call can fail in two ways. The RPC mechanism can fail or an error can occur in the execution of the remote procedure. In the former case, the remote procedure `printmessage_1()` returns a `NULL`. In the latter case, the error reporting is application dependent. Here, the error is returned through `*result`.

The compile commands for the `printmsg` example are:

```
$ rpcgen msg.x
$ cc rprintmsg.c msg_clnt.c -o rprintmsg -lnsl
$ cc msg_proc.c msg_svc.c -o msg_server -lnsl
```

`rpcgen` is used to generate the header files (`msg.h`), client stub (`msg_clnt.c`), and server stub (`msg_svc.c`). Then, two programs are compiled: the client program `rprintmsg` and the server program `msg_server`. The C object files must be linked with the library `libnsl`, which contains all of the networking functions, including those for RPC and XDR.

In this example, no XDR routines were generated because the application uses only the basic types that are included in `libnsl`.

`rpcgen` received the input file `msg.x` and created:

- A header file called `msg.h` that contained `#define` statements for `MESSAGEPROG`, `MESSAGEVERS`, and `PRINTMESSAGE` for use in the other modules. This file must be included by both the client and server modules.
- The client stub routines in the `msg_clnt.c` file. Only one routine, the `printmessage_1()` routine, was called from the `rprintmsg` client program. If the name of an `rpcgen` input file is `FOO.x`, the client stub's output file is called `FOO_clnt.c`.
- The server program in `msg_svc.c` that calls `printmessage_1()` from `msg_proc.c`. The rule for naming the server output file is similar to that of the client: for an input file called `FOO.x`, the output server file is named `FOO_svc.c`.

After the server program is created, it is installed on a remote machine and run. If the machines are homogeneous, the server binary can just be copied. If they are not homogeneous, the server source files must be copied to and compiled on the remote machine. For this example, the remote machine is called `remote` and the local machine is called `local`. The server is started from the shell on the remote system:

```
remote$ msg_server
```

Server processes generated with `rpcgen` always run in the background. You do not have to follow the server's invocation with an ampersand (&). Servers generated by `rpcgen` can also be invoked by port monitors like `listen()` and `inetd()`, instead of from the command line.

Thereafter, a user on `local` can print a message on the console of machine `remote` as follows:

```
local$ rprintmsg remote "Hello, there."
```

Using `rprintmsg`, a user can print a message on any system console, including the local console, when the server `msg_server` is running on the target system.

Passing Complex Data Structures

“Converting Local Procedures to Remote Procedures” on page 43 shows how to generate client and server RPC code. `rpcgen` can also be used to generate XDR routines, which are the routines that convert local data structures into XDR format and the reverse.

The following code example presents a complete RPC service: a remote directory listing service, built using `rpcgen` to generate both stub routines and the XDR routines.

EXAMPLE 3-4 RPC Protocol Description File: `dir.x`

```
/*
 * dir.x: Remote directory listing protocol
 *
 * This example demonstrates the functions of rpcgen.
 */

const MAXNAMELEN = 255;                /* max length of directory
entry */
typedef string nametype<MAXNAMELEN>;   /* director entry */
typedef struct namenode *namelist;     /* link in the listing */

/* A node in the directory listing */
struct namenode {
    nametype name;                    /* name of directory entry */
    namelist next;                   /* next entry */
};

/*
 * The result of a READDIR operation
 *
 * a truly portable application would use
 * an agreed upon list of error codes
 * rather than (as this sample program
 * does) rely upon passing UNIX errno's
 * back.
 *
 * In this example: The union is used
 * here to discriminate between successful
 * and unsuccessful remote calls.
 */
union readdir_res switch (int errno) {
    case 0:
        namelist list;               /* no error: return directory listing */
    default:
        void;                        /* error occurred: nothing else to return */
};
```

EXAMPLE 3-4 RPC Protocol Description File: dir.x (Continued)

```
};
/* The directory program definition */
program DIRPROG {
    version DIRVERS {
        readdir_res
        READDIR(nametype) = 1;
    } = 1; } = 0x20000076;
```

You can redefine types (like `readdir_res` in the previous example) using the `struct`, `union`, and `enum` RPC language keywords. These keywords are not used in later declarations of variables of those types. For example, if you define a union, `foo`, you declare using only `foo`, and not `union foo`.

`rpcgen` compiles RPC unions into C structures. Do not declare C unions using the `union` keyword.

Running `rpcgen` on `dir.x` generates four output files:

- Header file
- Client stub
- Server skeleton
- XDR routines in the file `dir_xdr.c`.

The `dir_xdr.c` file contains the XDR routines to convert declared data types from the host platform representation into XDR format, and the reverse.

For each RPC data type used in the `.x` file, `rpcgen` assumes that `libns1` contains a routine with a name that is the name of the data type, prepended by the XDR routine header `xdr_` (for example, `xdr_int`). If a data type is defined in the `.x` file, `rpcgen` generates the required `xdr_` routine. If there is no data type definition in the `.x` source file (for example, `msg.x`), then no `_xdr.c` file is generated.

You can write a `.x` source file that uses a data type not supported by `libns1`, and deliberately omit defining the type in the `.x` file. In doing so, you must provide the `xdr_` routine. This is a way to provide your own customized `xdr_` routines. See Chapter 4 for more details on passing arbitrary data types. The server-side of the `READDIR` procedure is shown in the following example.

EXAMPLE 3-5 Server `dir_proc.c` Example

```
/*
 * dir_proc.c: remote readdir
 * implementation
 */
#include <dirent.h>
#include "dir.h" /* Created by rpcgen */

extern int errno;
extern char *malloc();
extern char *strdup();
```

EXAMPLE 3-5 Server `dir_proc.c` Example (Continued)

```
readdir_res *
readdir_1(dirname, req)
    nametype *dirname;
    struct svc_req *req;

{
    DIR *dirp;
    struct dirent *d;
    namelist nl;
    namelist *nlp;
    static readdir_res res; /* must be static! */

    /* Open directory */
    dirp = opendir(*dirname);
    if (dirp == (DIR *)NULL) {
        res.errno = errno;
        return (&res);
    }
    /* Free previous result */
    xdr_free(xdr_readdir_res, &res);
    /*
     * Collect directory entries.
     * Memory allocated here is free by
     * xdr_free the next time readdir_1
     * is called
     */
    nlp = &res.readdir_res_u.list;
    while (d = readdir(dirp)) {
        nl = *nlp = (namenode *)
            malloc(sizeof(namenode));
        if (nl == (namenode *) NULL) {
            res.errno = EAGAIN;
            closedir(dirp);
            return(&res);
        }
        nl->name = strdup(d->d_name);
        nlp = &nl->next;
    }
    *nlp = (namelist)NULL;
    /* Return the result */
    res.errno = 0;
    closedir(dirp);
    return (&res);
}
```

The following code example shows the client-side implementation of the READDIR procedure.

EXAMPLE 3-6 Client-side Implementation of `rls.c`

```
/*
 * rls.c: Remote directory listing client
```

EXAMPLE 3-6 Client-side Implementation of `rls.c` (Continued)

```
*/

#include <stdio.h>
#include "dir.h" /* generated by rpcgen */

extern int errno;

main(argc, argv)
    int argc;
    char *argv[];
{
    CLIENT *clnt;
    char *server;
    char *dir;
    readdir_res *result;
    namelist nl;
    if (argc != 3) {
        fprintf(stderr, "usage: %s host
            directory\n", argv[0]);
        exit(1);
    }
    server = argv[1];
    dir = argv[2];
    /*
     * Create client "handle" used for
     * calling MESSAGEPROG on the server
     * designated on the command line.
     */
    cl = clnt_create(server, DIRPROG,
                    DIRVERS, "tcp");
    if (clnt == (CLIENT *)NULL) {
        clnt_pcreateerror(server);
        exit(1);
    }
    result = readdir_1(&dir, clnt);
    if (result == (readdir_res *)NULL) {
        clnt_perror(clnt, server);
        exit(1);
    }
    /* Okay, we successfully called
     * the remote procedure.
     */
    if (result->errno != 0) {
        /* Remote system error. Print
         * error message and die.
         */
        errno = result->errno;
        perror(dir);
        exit(1);
    }
    /* Successfully got a directory listing.
     * Print it.
     */
}
```

EXAMPLE 3-6 Client-side Implementation of `rls.c` (Continued)

```
for (nl = result->readdir_res_u.list;
     nl != NULL;
     nl = nl->next) {
    printf("%s\n", nl->name);
}
xdr_free(xdr_readdir_res, result);
clnt_destroy(cl);
exit(0);
```

As in other examples, execution is on systems named `local` and `remote`. The files are compiled and run as follows:

```
remote$ rpcgen dir.x
remote$ cc -c dir_xdr.c
remote$ cc rls.c dir_clnt.c dir_xdr.o -o rls -lnsl
remote$ cc dir_svc.c dir_proc.c dir_xdr.o -o dir_svc -lnsl
remote$ dir_svc
```

When you install `rls()` on system `local`, you can list the contents of `/usr/share/lib` on system `remote` as follows:

```
local$ rls remote /usr/share/lib
ascii
eqnchar
greek
kbd
marg8
tabclr
tabs
tabs4
local
$
```

Client code generated by `rpcgen` does not release the memory allocated for the results of the RPC call. Call `xdr_free()` to release the memory when you are finished with it. Calling `xdr_free()` is similar to calling the `free()` routine, except that you pass the XDR routine for the result. In this example, after printing the list, `xdr_free(xdr_readdir_res, result);` was called.

Note – Use `xdr_free()` to release memory allocated by `malloc()`. Failure to use `xdr_free()` to release memory results in memory leaks.

Preprocessing Directives

`rpcgen` supports C and other preprocessing features. C preprocessing is performed on `rpcgen` input files before they are compiled. All standard C preprocessing directives are allowed in the `.x` source files. Depending on the type of output file being generated, five symbols are defined by `rpcgen`.

`rpcgen` provides an additional preprocessing feature: any line that begins with a percent sign (%) is passed directly to the output file, with no action on the line's content. Use caution because `rpcgen` does not always place the lines where you intend. Check the output source file and, if needed, edit it.

`rpcgen` uses the preprocessing directives listed in the following table.

TABLE 3-1 `rpcgen` Preprocessing Directives

Symbol	Use
<code>RPC_HDR</code>	Header file output
<code>RPC_XDR</code>	XDR routine output
<code>RPC_SVC</code>	Server stub output
<code>RPC_CLNT</code>	Client stub output
<code>RPC_TBL</code>	Index table output

The following code example is a simple `rpcgen` example. Note the use of `rpcgen`'s pre-processing features.

EXAMPLE 3-7 Time Protocol `rpcgen` Source

```
/*
 * time.x: Remote time protocol
 */
program TIMEPROG {
    version TIMEVERS {
        unsigned int TIMEGET() = 1;
    } = 1;
} = 0x20000044;

#ifdef RPC_SVC
%int *
%timeget_1()
%{
%    static int thetime;
%
%    thetime = time(0);
%    return (&thetime);
%}
#endif
```

cpp Directive

rpcgen supports C preprocessing features. rpcgen defaults to use `/usr/ccs/lib/cpp` as the C preprocessor. If that fails, rpcgen tries to use `/lib/cpp`. You can specify a library containing a different `cpp` to rpcgen with the `-Y` flag.

For example, if `/usr/local/bin/cpp` exists, you can specify it to rpcgen as follows:

```
rpcgen -Y /usr/local/bin test.x
```

Compile-Time Flags

This section describes the rpcgen options available at compile time. The following table summarizes the options that are discussed in this section.

TABLE 3-2 rpcgen Compile-Time Flags

Option	Flag	Comments
Templates	<code>-a</code> , <code>-Sc</code> , <code>-Ss</code> , <code>-Sm</code>	See Table 3-3
C-style	<code>-N</code>	Also called Newstyle mode
ANSI C	<code>-C</code>	Often used with the <code>-N</code> option
MT-safe code	<code>-M</code>	For use in multithreaded environments
MT auto mode	<code>-A</code>	<code>-A</code> also turns on <code>-M</code> option
TS-RPC library	<code>-b</code>	TI-RPC library is default
<code>xdr_inline count</code>	<code>-i</code>	Uses five packed elements as default, but other number can be specified

Compile-Time Client and Server Templates

`rpcgen` generates sample code for the client and server sides. Use the options described in the following table to generate the desired templates.

TABLE 3-3 `rpcgen` Template Selection Flags

Flag	Function
-a	Generates all template files
-Sc	Generates client-side template
-Ss	Generates server-side template
-Sm	Generates makefile template

The files can be used as guides by filling in the missing parts. These files are in addition to the stubs generated.

A C-style mode server template is generated from the `add.x` source by the command `rpcgen -N -Ss -o add_server_template.c add.x`

The result is stored in the file `add_server_template.c`. A C-style mode, client template for the same `add.x` source is generated with the command `rpcgen -N -Sc -o add_client_template.c add.x`

The result is stored in the file `add_client_template.c`. A makefile template for the same `add.x` source is generated with the command `rpcgen -N -Sm -o mkfile_template add.x`

The result is stored in the file `mkfile_template`. It can be used to compile the client and the server. The `-a` flag, used in the command `rpcgen -N -a add.x`, generates all three template files. The client template is stored in `add_client.c`, the server template in `add_server.c`, and the makefile template in `makefile.a`. If any of these files already exists, `rpcgen` displays an error message and exits.

Note – When you generate template files, give them new names to avoid the files being overwritten the next time `rpcgen` is executed.

Compile-Time C-style Mode

Also called Newstyle mode, the `-N` flag causes `rpcgen` to produce code in which arguments are passed by value and multiple arguments are passed without a struct. These changes enable RPC code that is more like C and other high-level languages.

For compatibility with existing programs and make files, the previous standard mode of argument passing is the default. The following examples demonstrate the new feature. The source modules for both modes, C-style and default, are shown in Example 3-8 and Example 3-9 respectively.

EXAMPLE 3-8 C-style Mode Version of add.x

```

/*
 * This program contains a procedure
 * to add 2 numbers. It demonstrates
 * the C-style mode argument passing.
 * Note that add() has 2 arguments.
 */
program ADDPROG {                               /* program number */
    version ADDVER {                             /* version number */
        int add(int, int) = 1;                 /* procedure */
    } = 1;
} = 0x20000199;

```

EXAMPLE 3-9 Default Mode Version of add.x

```

/*
 * This program contains a procedure
 * to add 2 numbers. It demonstrates
 * the "default" mode argument passing.
 * In this mode rpcgen can process
 * only one argument.
 */
struct add_arg {
    int first;
    int second;
};
program ADDPROG {                               /* program number */
    version ADDVER {                             /* version number */
        int add (add_arg) = 1;                 /* procedure */
    } = 1;
} = 0x20000199;

```

The next four examples show the resulting client-side templates.

EXAMPLE 3-10 C-style Mode Client Stub for add.x

```

/*
 * The C-style client side main
 * routine calls the add() function
 * on the remote rpc server
 */
#include <stdio.h>
#include "add.h"

main(argc, argv)
int argc;
char *argv[];

```

EXAMPLE 3-10 C-style Mode Client Stub for add.x (Continued)

```
{
    CLIENT *clnt;
    int *result,x,y;

    if(argc != 4) {
        printf("usage: %s host num1
              num2\n" argv[0]);
        exit(1);
    }
    /* create client handle -
 * bind to server
 */
    clnt = clnt_create(argv[1], ADDPROG,
                      ADDVER, "udp");

    if (clnt == NULL) {
        clnt_pcreateerror(argv[1]);
        exit(1);
    }
    x = atoi(argv[2]);
    y = atoi(argv[3]);
    /*
 * invoke remote procedure: Note that
 * multiple arguments can be passed to
 * add_1() instead of a pointer
 */
    result = add_1(x, y, clnt);
    if (result == (int *) NULL) {
        clnt_perror(clnt, "call failed:");
        exit(1);
    } else {
        printf("Success: %d + %d = %d\n",
              x, y, *result);
    }
    exit(0);
}
```

The following code example shows how the default mode code differs from C-style mode code.

EXAMPLE 3-11 Default Mode Client

```
arg.first = atoi(argv[2]);
arg.second = atoi(argv[3]);
/*
 * invoke remote procedure -- note
 * that a pointer to the argument has
 * to be passed to the client stub
 */
result = add_1(&arg, clnt);
```

The server-side procedure in C-style mode is shown in the following example.

EXAMPLE 3-12 C-style Mode Server

```
#include "add.h"

int *
add_1(arg1, arg2, rqstp)
    int arg1;
    int arg2;
    struct svc_req *rqstp;
{
    static int result;

    result = arg1 + arg2;
    return(&result);
}
```

The server-side procedure in default mode is shown in the following code example.

EXAMPLE 3-13 Default Mode Server Stub

```
#include "add.h"
int *
add_1(argp, rqstp)
    add_arg *argp;
    struct svc_req *rqstp;
{
    static int result;

    result = argp->first + argp->second;
    return(&result);
}
```

Compile-Time MT-Safe Code

By default, the code generated by `rpcgen` is not MT safe. It uses unprotected global variables and returns results in the form of static variables. The `-M` flag generates MT-safe code that can be used in a multithreaded environment. This code can be used with the C-style flag, the ANSI C flag, or both.

An example of an MT-safe program with this interface follows. The `rpcgen` protocol file is `msg.x`, shown in the following code example.

EXAMPLE 3-14 MT-Safe Program: `msg`

```
program MESSAGEPROG {
version PRINTMESSAGE {
    int PRINTMESSAGE(string) = 1;
} = 1;
} = 0x4001;
```

A string is passed to the remote procedure, which prints it and returns the length of the string to the client. The MT-safe stubs are generated with the `rpcgen -M msg.x` command.

Client-side code that could be used with this protocol file is shown in the following code example.

EXAMPLE 3-15 MT-Safe Client Stub

```
#include "msg.h"

void
messageprog_1(host)
    char *host;
{
    CLIENT *clnt;
    enum clnt_stat retval_1;
    int result_1;
    char * printmessage_1_arg;

    clnt = clnt_create(host, MESSAGEPROG,
                      PRINTMESSAGE,
                      "netpath");

    if (clnt == (CLIENT *) NULL) {
        clnt_pcreateerror(host);
        exit(1);
    }
    printmessage_1_arg =
        (char *) malloc(256);
    strcpy(printmessage_1_arg, "Hello World");

    retval_1 = printmessage_1(&printmessage_1_arg,
                              &result_1, clnt);

    if (retval_1 != RPC_SUCCESS) {
        clnt_perror(clnt, "call failed");
    }
    printf("result = %d\n", result_1);

    clnt_destroy(clnt);
}

main(argc, argv)
    int argc;
    char *argv[];
{
    char *host;

    if (argc < 2) {
        printf("usage:  %s server_host\n", argv[0]);
        exit(1);
    }
    host = argv[1];
    messageprog_1(host);
}
```

A pointer to both the arguments and the results needs to be passed in to the `rpcgen`-generated code in order to preserve re-entrancy. The value returned by the stub function indicates whether this call is a success or a failure. The stub returns `RPC_SUCCESS` if the call is successful. Compare the MT-safe client stub, generated with the `-M` option, and the MT-unsafe client stub shown in Example 3–16. The client stub that is not MT-safe uses a static variable to store returned results and can use only one thread at a time.

EXAMPLE 3–16 Client Stub (MT Unsafe)

```
int *
printmessage_1(argp, clnt)
    char **argp;
    CLIENT *clnt;
{
    static int clnt_res;
    memset((char *)&clnt_res, 0,
           sizeof (clnt_res));
    if (clnt_call(clnt, PRINTMESSAGE,
                 (xdrproc_t) xdr_wrapstring,
                 (caddr_t) argp,
                 (xdrproc_t) xdr_int, (caddr_t)
                 &clnt_res,
                 TIMEOUT) != RPC_SUCCESS) {
        return (NULL);
    }
    return (&clnt_res);
}
```

The server side code is shown in the following example.

Note – When compiling a server that uses MT-safe mode, you must link in the threads library. To do so, specify the `-lthread` option in the compile command.

EXAMPLE 3–17 MT-Safe Server Stub

```
#include "msg.h"

#include <syslog.h>

bool_t
printmessage_1_svc(argp, result, rqstp)
    char **argp;
    int *result;
    struct svc_req *rqstp;
{
    int retval;

    if (*argp == NULL) {
        syslog(LOG_INFO, "argp is NULL\n");
        *result = 0;
    }
}
```

EXAMPLE 3-17 MT-Safe Server Stub (Continued)

```
    }
    else {
        syslog("argp is %s\n", *argp);
        *result = strlen (*argp);
    }
    retval = 1;
    return (retval);
}

int
messageprog_1_freeresult(transp, xdr_result, result)
    SVCXPRT *transp;
    xdrproc_t xdr_result;
    caddr_t result;
{
    /*
     * Insert additional freeing code here,
     * if needed
     */
    (void) xdr_free(xdr_result, result);}
}
```

The server-side code should not use statics to store returned results. A pointer to the result is passed in and this should be used to pass the result back to the calling routine. A return value of 1 indicates success to the calling routine, while 0 indicates a failure.

In addition, the code generated by `rpcgen` also generates a call to a routine to free any memory that might have been allocated when the procedure was called. To prevent memory leaks, any memory allocated in the service routine needs to be freed in this routine. `messageprog_1_freeresult()` frees the memory.

Normally, `xdr_free()` frees any allocated memory for you. In this example, no memory was allocated, so no freeing needs to take place.

The following `add.x` file shows the use of the `-M` flag with the C-style and ANSI C flag.

EXAMPLE 3-18 MT-Safe Program: `add.x`

```
program ADDPROG {
    version ADDVER {
        int add(int, int) = 1;
    } = 1;
} = 199;
```

This program adds two numbers and returns its result to the client. `rpcgen` is invoked on it, with the `rpcgen -N -M -C add.x` command. The following example shows the multithreaded client code to call this code.

EXAMPLE 3-19 MT-Safe Client: add.x

```
/*
 * This client-side main routine
 * starts up a number of threads,
 * each of which calls the server
 * concurrently.
 */

#include "add.h"

CLIENT *clnt;
#define NUMCLIENTS 5
struct argrec {
    int arg1;
    int arg2;
};

/* Keeps count of number of
 * threads running
 */
int numrunning;
mutex_t numrun_lock;
cond_t condnum;

void
addprog(struct argrec *args)
{
    enum clnt_stat retval;
    int result;
    /* call server code */
    retval = add_1(args->arg1, args->arg2,
                  &result, clnt);

    if (retval != RPC_SUCCESS) {
        clnt_perror(clnt, "call failed");
    } else
        printf("thread #%x call succeeded,
              result = %d\n", thr_getself(),
              result);

    /* decrement the number of running
     * threads
     */
    mutex_lock(&numrun_lock);
    numrunning--;
    cond_signal(&condnum);
    mutex_unlock(&numrun_lock);
    thr_exit(NULL);
}

main(int argc, char *argv[])
{
    char *host;
    struct argrec args[NUMCLIENTS];
    int i;
    thread_t mt;
```

EXAMPLE 3-19 MT-Safe Client: add.x (Continued)

```
int ret;

if (argc < 2) {
    printf("usage: %s server_host\n",
        argv[0]);
    exit(1);
}
host = argv[1];
clnt = clnt_create(host, ADDPROG, ADDVER,
    "netpath");
if (clnt == (CLIENT *) NULL) {
    clnt_pcreateerror(host);
    exit(1);
};
mutex_init(&numrun_lock, USYNC_THREAD, NULL);
cond_init(&condnum, USYNC_THREAD, NULL);
numrunning = 0;

/* Start up separate threads */
for (i = 0; i < NUMCLIENTS; i++) {
    args[i].arg1 = i;
    args[i].arg2 = i + 1;
    ret = thr_create(NULL, NULL, addprog,
        (char *) &args[i],
        THR_NEW_LWP, &mt);

    if (ret == 0)
        numrunning++;
}

mutex_lock(&numrun_lock);
/* are any threads still running ? */
while (numrunning != 0)
    cond_wait(&condnum, &numrun_lock);
mutex_unlock(&numrun_lock);
clnt_destroy(clnt);}
```

The server-side procedure is shown in the following example.

Note – When compiling a server that uses MT-safe mode, you must link in the threads library. To do so, specify the `-lthread` option in the compile command.

EXAMPLE 3-20 MT-Safe Server: add.x

```
add_1_svc(int arg1, int arg2,
    int *result, struct svc_req *rqstp)
{
    bool_t retval;
    /* Compute result */
    *result = arg1 + arg2;
```

EXAMPLE 3-20 MT-Safe Server: add.x (Continued)

```
        retval = 1;
        return (retval);
    }

/* Routine for freeing memory that may
 * be allocated in the server procedure
 */
int
addprog_1_freeresult(SVCXPRT *transp,
                    xdrproc_t xdr_result,
                    caddr_t result)

{
    (void) xdr_free(xdr_result, result);
}

```

Compile-Time MT Auto Mode

MT Auto mode enables RPC servers to automatically use Solaris threads to process client requests concurrently. Use the `-A` option to generate RPC code in MT Auto mode. The `-A` option also has the effect of turning on the `-M` option, so `-M` does not need to be explicitly specified. The `-M` option is necessary because any code that is generated has to be multithread safe.

The section Chapter 7 contains further discussion on multithreaded RPC. See also “MT Auto Mode” on page 157.

An example of an Auto mode program generated by `rpcgen` follows in the `rpcgen` protocol file `time.x`. A string is passed to the remote procedure, which prints the string and returns its length to the client.

EXAMPLE 3-21 MT Auto Mode: time.x

```
program TIMEPROG {
    version TIMEVERS {
        unsigned int TIMEGET(void) = 1;
        void TIMESET(unsigned) = 2;
    } = 1;
} = 0x20000044;
```

The MT-safe stubs are generated with the `rpcgen -A time.x` command.

When the `-A` option is used, the generated server code contains instructions for enabling MT Auto mode for the server.

Note – When compiling a server that uses MT Auto mode, you must link in the threads library. To do so, specify the `-lthread` option in the compile command.

Compile-Time TI-RPC or TS-RPC Library Selection

In older SunOS releases, `rpcgen` created stubs that used the socket functions. With the current SunOS release, you can use either the transport-independent RPC (TI-RPC) or the transport-specific socket (TS-RPC) routines. These routines provides backward compatibility with previous releases. The default uses the TI-RPC interfaces. The `-b` flag tells `rpcgen` to create TS-RPC variant source code as its output.

Compile-Time ANSI C-compliant Code

`rpcgen` can also produce output that is compatible with ANSI C. This feature is selected with the `-C` compile flag and is most often used with the `-N` flag, described in “Compile-Time C-style Mode” on page 56.

The `add.x` example of the server template is generated by the `rpcgen -N -C -Ss -o add_server_template.c add.x` command:

Note that on the C++ 3.0 server, remote procedure names require an `_svc` suffix. In the following example, the `add.x` template and the `-C` compile flag produce the client side `add_1` and the server stub `add_1_svc`.

EXAMPLE 3-22 `rpcgen` ANSI C Server Template

```
/*
 * This is a template. Use it to
 * develop your own functions.
 */
#include <c_varieties.h>
#include "add.h"

int *
add_1_svc(int arg1, int arg2,
          struct svc_req *rqstp)
{
    static int result;
    /*
     * insert server code here
     */
    return(&result);
}
```

This output conforms to the syntax requirements and structure of ANSI C. The header files that are generated when this option is invoked can be used with ANSI C or with C++.

Compile-Time `xdr_inline()` Count

`rpcgen` tries to generate more efficient code by using `xdr_inline()` when possible (see the `xdr_admin(3NSL)` man page). When a structure contains elements that `xdr_inline()` can be used on (for example `integer()`, `long()`, `bool()`), the relevant portion of the structure is packed with `xdr_inline()`. A default of five or more packed elements in sequence causes inline code to be generated. You can change this default with the `-i` flag. The `rpcgen -i 3 test.x` command causes `rpcgen` to start generating inline code after three qualifying elements are found in sequence. The `rpcgen -i 0 test.x` command prevents any inline code from being generated.

In most situations, you do not need to use the `-i` flag. The `_xdr.c` stub is the only file affected by this feature.

`rpcgen` Programming Techniques

This section suggests some common RPC and `rpcgen` programming techniques.

TABLE 3-4 RPC Programming Techniques

Technique	Description
Network type	<code>rpcgen</code> can produce server code for specific transport types.
Define statements	You can define C-preprocessing symbols on <code>rpcgen</code> command lines.
Broadcast calls	Servers need not send error replies to broadcast calls.
Debugging applications	Debug as normal function calls, then change to a distributed application.
Port monitor support	Port monitors can “listen” on behalf of RPC servers.
Dispatch tables	Programs can access server dispatch tables.
Time-out changes	You can change client default time-out periods.
Authentication	Clients can authenticate themselves to servers; the appropriate servers can examine client authentication information.

Network Types/Transport Selection

`rpcgen` takes optional arguments that enable a programmer to specify desired network types or specific network identifiers. For details of network selection, see *Programming Interfaces Guide*.

The `-s` flag creates a server that responds to requests on the specified type of transport. For example, the command `rpcgen -s datagram_n prot.x` writes a server to standard output that responds to any of the connectionless transports specified in the `NETPATH` environment variable, or in `/etc/netconfig`, if `NETPATH` is not defined. A command line can contain multiple `-s` flags and their network types.

Similarly, the `-n` flag creates a server that responds only to requests from the transport specified by a single network identifier.

Note – Be careful using servers created by `rpcgen` with the `-n` flag. Network identifiers are host specific, so the resulting server might not run as expected on other hosts.

Command-Line Define Statements

You can define C-preprocessing symbols and assign values to them from the command line. Command-line define statements can be used to generate conditional debugging code when the `DEBUG` symbol is defined. For example:

```
$ rpcgen -DDEBUG proto.x
```

Server Response to Broadcast Calls

When a procedure has been called through broadcast RPC and cannot provide a useful response, the server should send no reply to the client, thus reducing network traffic. To prevent the server from replying, a remote procedure can return `NULL` as its result. The server code generated by `rpcgen` detects this return and sends no reply.

The following code example is a procedure that replies only if it reaches an NFS server.

EXAMPLE 3-23 NFS Server Response to Broadcast Calls

```
void *
reply_if_nfsserver()
{
    char notnull; /*only here so we can
                  *use its address
                  */
}
```

EXAMPLE 3-23 NFS Server Response to Broadcast Calls (Continued)

```
if( access( "/etc/dfs/sharetab",
           F_OK ) < 0 ) {
    /* prevent RPC from replying */
    return( (void *) NULL );
}
/* assign notnull a non-null value
 * then RPC sends a reply
 */
return( (void *) &notnull );
}
```

A procedure must return a non-NULL pointer when it is appropriate for RPC library routines to send a reply.

In the example, if the procedure `reply_if_nfsserver()` is defined to return nonvoid values, the return value `¬null` should point to a static variable.

Port Monitor Support

Port monitors such as `inetd` and `listen` can monitor network addresses for specified RPC services. When a request arrives for a particular service, the port monitor spawns a server process. After the call has been serviced, the server can exit. This technique conserves system resources. The main server function generated by `rpcgen` allows invocation by `inetd`. See “Using `inetd`” on page 135 for details.

Services might wait for a specified interval after completing a service request, in case another request follows. If no call arrives in the specified time, the server exits, and some port monitors, like `inetd`, continue to monitor for the server. If a later request for the service occurs, the port monitor gives the request to a waiting server process (if any), rather than spawning a new process.

Note – When monitoring for a server, some port monitors, like `listen()`, always spawn a new process in response to a service request. If a server is used with such a monitor, the server should exit immediately on completion.

By default, services created using `rpcgen` wait for 120 seconds after servicing a request before exiting. You can change the interval with the `-K` flag. In the following example, the server waits for 20 seconds before exiting. To create a server that exits immediately, you can use zero value for the interval period.

```
rpcgen -K 20 proto.x
rpcgen -K 0 proto.x
```

To create a server that never exits, the value is `-K -1`.

For more information on port monitors, see Appendix F.

Time-out Changes

After sending a request to the server, a client program waits for a default period (25 seconds) to receive a reply. You can change this timeout by using the `clnt_control()` routine. See “Standard Interfaces” on page 85 for additional uses of the `clnt_control()` routine. See also the `rpc(3NSL)` man page. When considering time-out periods, be sure to allow the minimum amount of time required for “round-trip” communications over the network. The following code example illustrates the use of `clnt_control()`.

EXAMPLE 3-24 `clnt_control` Routine

```
struct timeval tv;
CLIENT *clnt;
clnt = clnt_create( "somehost", SOMEPROG,
                  SOMEVERS, "visible" );

if (clnt == (CLIENT *)NULL)
    exit(1);
tv.tv_sec = 60; /* change time-out to
                * 60 seconds
                */
tv.tv_usec = 0;
clnt_control(clnt, CLSET_TIMEOUT, &tv);
```

Client Authentication

The client create routines do not have any facilities for client authentication. Some clients might have to authenticate themselves to the server.

The following example illustrates one of the least secure authentication methods in common use. See “Authentication” on page 116 for information on more secure authentication techniques.

EXAMPLE 3-25 `AUTH_SYS` Authentication Program

```
CLIENT *clnt;
clnt = clnt_create( "somehost", SOMEPROG,
                  SOMEVERS, "visible" );

if (clnt != (CLIENT *)NULL) {
    /* To set AUTH_SYS style authentication */
    clnt->cl_auth = authsys_createdefault();
}
```

Authentication information is important to servers that have to achieve some level of security. This extra information is supplied to the server as a second argument.

The following example is for a server that checks client authentication data. It is modified from `printmessage_1()` in “`rpcgen Tutorial`” on page 42. The code allows only superusers to print a message to the console.

EXAMPLE 3-26 `printmsg_1` for Superuser

```
int *
printmessage_1(msg, req)
    char **msg;
    struct svc_req *req;
{
    static int result;    /* Must be static */
    FILE *f;
    struct authsys_parms *aup;

    aup = (struct authsys_parms *)req->rq_clntcred;
    if (aup->aup_uid != 0) {
        result = 0;
        return (&result)
    }

    /* Same code as before. */
}
```

Dispatch Tables

Sometimes programs should have access to the dispatch tables used by the RPC package. For example, the server dispatch routine might check authorization and then invoke the service routine. Or, a client library might handle the details of storage management and XDR data conversion.

When invoked with the `-T` option, `rpcgen` generates RPC dispatch tables for each program defined in the protocol description file, `proto.x`, in the file `proto_tbl.i`. The suffix `.i` stands for “index.” You can invoke `rpcgen` with the `-t` option to build only the header file. You cannot invoke `rpcgen` in C-style mode (`-N`) with either the `-T` or `-t` flag.

Each entry in the dispatch table is a struct `rpcgen_table`, defined in the header file `proto.h` as follows:

```
struct rpcgen_table {
    char *(*proc)();
    xdrproc_t xdr_arg;
    unsigned len_arg;
    xdrproc_t xdr_res;
    xdrproc_t len_res
};
```

where:

proc is a pointer to the service routine

xdr_arg is a pointer to the input (argument) *xdr* routine

len_arg is the length in bytes of the input argument

xdr_res is a pointer to the output (result) *xdr* routine

len_res is the length in bytes of the output result

The table, named *dirprog_1_table* for the *dir.x* example, is indexed by procedure number. The variable *dirprog_1_nproc* contains the number of entries in the table.

The *find_proc()* routine shows an example of how to locate a procedure in the dispatch tables.

EXAMPLE 3-27 Using a Dispatch Table

```
struct rpcgen_table *
find_proc(proc)
    rpcproc_t proc;
{
    if (proc >= dirprog_1_nproc)
        /* error */
    else
        return (&dirprog_1_table[proc]);
}
```

Each entry in the dispatch table contains a pointer to the corresponding service routine. However, that service routine is usually not defined in the client code. To avoid generating unresolved external references, and to require only one source file for the dispatch table, the *rpcgen* service routine initializer is *RPCGEN_ACTION(proc_ver)*.

Using this technique, the same dispatch table can be included in both the client and the server. Use the following *define* statement when compiling the client.

```
#define RPCGEN_ACTION(routine) 0
```

Use the following *define* when writing the server.

```
#define RPCGEN_ACTION(routine) routine
```

64-Bit Considerations for *rpcgen*

In Example 3-27 *proc* is declared as type *rpcproc_t*. Formerly, RPC programs, versions, procedures, and ports were declared to be of type *u_long*. On a 32-bit machine, a *u_long* is a 4-byte quantity (as is an *int*); on a 64-bit system, a *u_long* is an 8-byte quantity. The data types *rpcprog_t*, *rpcvers_t*, *rpc_proc_t*, and *rpcport_t*, introduced in the Solaris 7 environment, should be used whenever possible in declaring RPC programs, versions, procedures, and ports in place of both

`u_long` and `long`. These newer types provide backwards compatibility with 32-bit systems. They are guaranteed to be 4-byte quantities no matter which system `rpcgen` is run on. While `rpcgen` programs using `u_long` versions of programs, versions, and procedures can still run, they have different consequences on 32- and 64-bit machines. For that reason, replace them with the appropriate newer data types. In fact, avoid using `long` and `u_long` whenever possible.

Beginning with the Solaris 7 environment, source files created with `rpcgen` containing XDR routines use different inline macros depending on whether the code is to run on a 32-bit or 64-bit machine. Specifically, the source files will use the `IXDR_GET_INT32()` and `IXDR_PUT_INT32()` macros instead of `IXDR_GETLONG()` and `IXDR_PUTLONG()`. For example, if the `rpcgen` source file `foo.x` contains the following code, the resulting `foo_xdr.c` file ensures that the correct inline macro is used.

```

struct foo {
    char    c;
    int     i1;
    int     i2;
    int     i3;
    long    l;
    short   s;
};

#if defined(_LP64) || defined(_KERNEL)
    register int *buf;
#else
    register long *buf;
#endif
. . .
#if defined(_LP64) || defined(_KERNEL)

    IXDR_PUT_INT32(buf, objp->i1);

    IXDR_PUT_INT32(buf, objp->i2);
    IXDR_PUT_INT32(buf, objp->i3);

    IXDR_PUT_INT32(buf, objp->l);

    IXDR_PUT_SHORT(buf, objp->s);
#else

    IXDR_PUT_LONG(buf, objp->i1);

    IXDR_PUT_LONG(buf, objp->i2);

    IXDR_PUT_LONG(buf, objp->i3);
    IXDR_PUT_LONG(buf, objp->l);

    IXDR_PUT_SHORT(buf, objp->s);
#endif

```

The code declares *buf* to be either `int` or `long`, depending on whether the machine is 64-bit or 32-bit.

Currently, data types transported by using RPC are limited in size to 4-byte quantities (32 bits). The 8-byte `long` is provided to enable applications to make maximum use of 64-bit architecture. However, programmers should avoid using `long`s, and functions that use `long`s, such as `x_putlong()`, in favor of `int`s whenever possible. As noted previously, RPC programs, versions, procedures, and ports have their own dedicated types. `xdr_long()` fails if the data value is not between `INT32_MIN` and `INT32_MAX`. Also, the data could be truncated if inline macros such as `IXDR_GET_LONG()` and `IXDR_PUT_LONG()` are used. The same concerns apply to `u_long` variables. See also the `xdr_long(3NSL)` man page.

IPv6 Considerations for `rpcgen`

Only TI-RPC supports IPv6 transport. If an application is intended to run over IPv6, now or in the future, you must not use the backward compatibility switch. The selection of IPv4 or IPv6 is determined by the respective order of associated entries in `/etc/netconfig`.

Debugging Applications

To simplify the testing and debugging process, first test the client program and the server procedure in a single process by linking them with each other rather than with the client and server skeletons. Comment out calls to the client create RPC library routines (see the `rpc_clnt_create(3NSL)` man page) and the authentication routines. Do not link with `libnsl`.

Link the procedures from the previous example by using the command `cc rls.c dir_clnt.c dir_proc.c -o rls`

With the RPC and XDR functions commented out, the procedure calls execute as ordinary local function calls, and the program is debugged with a local debugger such as `dbxtool`. When the program works, the client program is linked to the client skeleton produced by `rpcgen` and the server procedures are linked to the server skeleton produced by `rpcgen`.

You can also use the Raw RPC mode to test the XDR routines. For details, see “Testing Programs Using Low-Level Raw RPC” on page 101 for details.

Two kinds of errors can happen in an RPC call. The first kind of error is caused by a problem with the mechanism of the remote procedure calls. Examples of this problem are:

- The procedure is not available
- The remote server is not responding

- The remote server is unable to decode the arguments.

In Example 3–26, an RPC error happens if `result` is `NULL`. The reason for the failure can be displayed by using `clnt_perror()`, or an error string can be returned through `clnt_sperror()`.

The second type of error is caused by the server itself. In Example 3–26, an error can be returned by `opendir()`. The handling of these errors is application specific and is the responsibility of the programmer.

Note that you will be unable to link the client and server programs to each other if you are using the `-C` option, because of the `-_svc` suffix added to the server-side routines.

Programmer's Interface to RPC

This chapter addresses the C interface to RPC and describes how to write network applications using RPC. For a complete specification of the routines in the RPC library, see the `rpc(3NSL)` and related man pages.

The topics covered in this chapter include:

- “Simplified Interface” on page 77
- “Standard Interfaces ” on page 85
- “Testing Programs Using Low-Level Raw RPC” on page 101
- “MT User Mode” on page 160

Note – The client and server interfaces described in this chapter are multithread safe, except where noted (such as raw mode). This designation means that applications that contain RPC function calls can be used freely in a multithreaded application.

Simplified Interface

The simplified interface is the level to use if you do not require the use of any other RPC routines. This level also limits control of the underlying communications mechanisms. You can rapidly develop a program at this level, and the development is directly supported by the `rpcgen` compiler. For most applications, `rpcgen` and its facilities are sufficient.

Some RPC services are not available as C functions, but they are available as RPC programs. The simplified interface library routines provide direct access to the RPC facilities for programs that do not require fine levels of control. Routines such as `rusers()` are in the RPC services library `librpcsvc`. The following code example is a program that displays the number of users on a remote host. It calls the RPC library routine `rusers()`.

EXAMPLE 4-1 rusers Program

```
#include <rpc/rpc.h>

#include <rpcsvc/rusers.h>
#include <stdio.h>

/*
 * a program that calls the
 * rusers() service
 */

main(argc, argv)
    int argc;
    char **argv;
{
    int num;

    if (argc != 2) {
        fprintf(stderr, "usage: %s hostname\n",
            argv[0]);
        exit(1);
    }
    if ((num = rnusers(argv[1])) < 0) {
        fprintf(stderr, "error: rusers\n");
        exit(1);
    }
    fprintf(stderr, "%d users on %s\n", num,
        argv[1] );
    exit(0);}

```

Compile the program in Example 4-1 by typing:

```
cc program.c -lrpcsvc -lnsl
```

Client Side of Simplified Interface

Just one function exists on the client side of the simplified interface: `rpc_call()`. It has nine parameters:

```
int    0 or error code
rpc_call (
    char          *host          /* Name of server host */
    rpcprog_t     prognum        /* Server program number */
    rpcvers_t     versnum       /* Server version number */
    rpcproc_t     procnum       /* Server procedure number */
    xdrproc_t     inproc        /* XDR filter to encode arg */
    char          *in           /* Pointer to argument */
    xdr_proc_t    outproc       /* Filter to decode result */
    char          *out          /* Address to store result */
    char          *nettype      /*For transport selection */
);

```

The `rpc_call()` function calls the procedure specified by *prognum*, *versum*, and *procnum* on the *host*. The argument to be passed to the remote procedure is pointed to by the *in* parameter, and *inproc* is the XDR filter to encode this argument. The *out* parameter is an address where the result from the remote procedure is to be placed. *outproc* is an XDR filter that decodes the result and places it at this address.

The client blocks on `rpc_call()` until it receives a reply from the server. If the server accepts, it returns `RPC_SUCCESS` with the value of zero. The server returns a non-zero value if the call was unsuccessful. You can cast this value to the type `clnt_stat`, an enumerated type defined in the RPC include files and interpreted by the `clnt_sperno()` function. This function returns a pointer to a standard RPC error message corresponding to the error code.

In the example, all “visible” transports listed in `/etc/netconfig` are tried. Adjusting the number of retries requires use of the lower levels of the RPC library.

Multiple arguments and results are handled by collecting them in structures.

The following code example changes the code in Example 4–1 to use the simplified interface.

EXAMPLE 4–2 rusers Program Using Simplified Interface

```
#include <stdio.h>

#include <utmpx.h>
#include <rpc/rpc.h>

#include <rpcsvc/rusers.h>

/* a program that calls the RUSERSPROG
 * RPC program
 */

main(argc, argv)
    int argc;
    char **argv;
{
    unsigned int nusers;
    enum clnt_stat cs;

    if (argc != 2) {
        fprintf(stderr, "usage: rusers hostname\n");
        exit(1);
    }
    if( cs = rpc_call(argv[1], RUSERSPROG,
        RUSERSVERS, RUSERSPROC_NUM, xdr_void,
        (char *)0, xdr_u_int, (char *)&nusers,
        "visible") != RPC_SUCCESS ) {
        clnt_perrno(cs);
        exit(1);
    }
    fprintf(stderr, "%d users on %s\n", nusers,
```

EXAMPLE 4-2 rusers Program Using Simplified Interface (Continued)

```
        argv[1] );
    exit(0);
}
```

Data types can be represented differently on different machines. Therefore, `rpc_call()` needs both the type of the RPC argument and a pointer to it. `rpc_call()` also needs this information for the result. For `RUSERSPROC_NUM`, the return value is an unsigned int, so the first return parameter of `rpc_call()` is `xdr_u_int`, which is for an unsigned int, and the second return parameter is `&nusers`, which points to unsigned int storage. Because `RUSERSPROC_NUM` has no argument, the XDR encoding function of `rpc_call()` is `xdr_void()` and its argument is `NULL`.

Server Side of the Simplified Interface

The server program using the simplified interface is straightforward. The server calls `rpc_reg()` to register the procedure to be called. It then calls `svc_run()`, the RPC library's remote procedure dispatcher, to wait for requests to arrive.

`rpc_reg()` has the following arguments:

```
rpc_reg (
    rpcprog_t      prognum      /* Server program number */
    rpcvers_t      versnum     /* Server version number */
    rpcproc_t      procnum     /* server procedure number */
    char           *procname   /* Name of remote function */
    xdrproc_t      inproc     /* Filter to encode arg */
    xdrproc_t      outproc    /* Filter to decode result */
    char           *nettype    /* For transport selection */
);
```

`svc_run()` invokes service procedures in response to RPC call messages. The dispatcher in `rpc_reg()` decodes remote procedure arguments and encodes results, using the XDR filters specified when the remote procedure was registered. Some notes about the server program include:

- Most RPC applications follow the naming convention of appending a `_1` to the function name. The sequence `_n` is added to the procedure names to indicate the version number `n` of the service.
- The argument and result are passed as addresses. This is true for all functions that are called remotely. Passing `NULL` as a result of a function means that no reply is sent to the client, because `NULL` indicates that there is no reply to send.
- The result must exist in static data space because its value is accessed after the actual procedure has exited. The RPC library function that builds the RPC reply message accesses the result and sends the value back to the client.

- Only a single argument is allowed. If there are multiple elements of data, they should be wrapped inside a structure that can then be passed as a single entity.
- The procedure is registered for each transport of the specified type. If the type parameter is (char *)NULL, the procedure is registered for all transports specified in NETPATH.

Hand-Coded Registration Routine

You can sometimes implement faster or more compact code than can `rpcgen`. `rpcgen` handles the generic code-generation cases. The following program is an example of a hand-coded registration routine. It registers a single procedure and enters `svc_run()` to service requests.

```
#include <stdio.h>

#include <rpc/rpc.h>
#include <rpcsvc/rusers.h>
void *rusers();

main()
{
    if(rpc_reg(RUSERSPROG, RUSERSVERS,
              RUSERSPROC_NUM, rusers,
              xdr_void, xdr_u_int,
              "visible") == -1) {
        fprintf(stderr, "Couldn't Register\n");
        exit(1);
    }
    svc_run(); /* Never returns */
    fprintf(stderr, "Error: svc_run
              returned!\n");
    exit(1);
}
```

`rpc_reg()` can be called as many times as is needed to register different programs, versions, and procedures.

Passing Arbitrary Data Types

Data types passed to and received from remote procedures can be any of a set of predefined types, or can be programmer-defined types. RPC handles arbitrary data structures, regardless of the byte orders or structure layout conventions of different machines. RPC always converts these structures to a standard transfer format called external data representation (XDR) before sending them over the transport. The conversion from a machine representation to XDR is called serializing, and the reverse process is called deserializing.

The translator arguments of `rpc_call()` and `rpc_reg()` can specify an XDR primitive procedure, like `xdr_u_int()`, or a programmer-supplied routine that processes a complete argument structure. Argument processing routines must take only two arguments: a pointer to the result and a pointer to the XDR handle.

The XDR Primitive Type Routines are:

<code>xdr_int()</code>	<code>xdr_double()</code>
<code>xdr_netobj()</code>	<code>xdr_u_short()</code>
<code>xdr_u_long()</code>	<code>xdr_wrapstring()</code>
<code>xdr_enum()</code>	<code>xdr_char()</code>
<code>xdr_long()</code>	<code>xdr_quadruple()</code>
<code>xdr_float()</code>	<code>xdr_u_char()</code>
<code>xdr_u_int()</code>	<code>xdr_void()</code>
<code>xdr_bool()</code>	<code>xdr_hyper()</code>
<code>xdr_short()</code>	<code>xdr_u_hyper()</code>

The fixed-width integer types found in `int_types.h`, the routines `xdr_char()`, `xdr_short()`, `xdr_int()`, and `xdr_hyper()` (and the unsigned versions of each) have equivalent functions with names familiar to ANSI C, as indicated in the following table:

TABLE 4-1 Primitive Type Equivalences

Function	Equivalent
<code>xdr_char()</code>	<code>xdr_int8_t()</code>
<code>xdr_u_char()</code>	<code>xdr_u_int8_t()</code>
<code>xdr_short()</code>	<code>xdr_int16_t()</code>
<code>xdr_u_short()</code>	<code>xdr_u_int16_t()</code>
<code>xdr_int()</code>	<code>xdr_int32_t()</code>
<code>xdr_u_int()</code>	<code>xdr_u_int32_t()</code>
<code>xdr_hyper()</code>	<code>xdr_int64_t()</code>
<code>xdr_u_hyper()</code>	<code>xdr_u_int64_t()</code>

The nonprimitive `xdr_string()`, which takes more than two parameters, is called from `xdr_wrapstring()`.

The following example of a programmer-supplied routine contains the calling arguments of a procedure.

```
struct simple {
    int a;
    short b;
} simple;
```

The XDR routine `xdr_simple()` translates the argument structure as shown in the following code example.

EXAMPLE 4-3 `xdr_simple` Routine

```
#include <rpc/rpc.h>
#include "simple.h"

bool_t
xdr_simple(xdrsp, simplep)
    XDR *xdrsp;
    struct simple *simplep;
{
    if (!xdr_int(xdrsp, &simplep->a))
        return (FALSE);
    if (!xdr_short(xdrsp, &simplep->b))
        return (FALSE);
    return (TRUE);
}
```

`rpcgen` can automatically generate an equivalent routine.

An XDR routine returns nonzero (a C `TRUE`) if it completes successfully, and zero otherwise. A complete description of XDR is provided in Appendix C.

The following list shows prefabricated routines:

```
xdr_array()
xdr_bytes()
xdr_reference()
xdr_vector()
xdr_union()
xdr_pointer()
xdr_string()
xdr_opaque()
```

For example, to send a variable-sized array of integers, the routine is packaged in a structure containing the array and its length:

```
struct varintarr {
    int *data;
    int arrlnth;
} arr;
```

Translate the array with `xdr_varintarr()`, as shown in the following code example.

EXAMPLE 4-4 `xdr_varintarr` Syntax Use

```
bool_t
xdr_varintarr(xdrsp, arrp)
    XDR *xdrsp;
    struct varintarr *arrp;
```

EXAMPLE 4-4 xdr_varintarr Syntax Use (Continued)

```
{
    return(xdr_array(xdrsp, (caddr_t)&arrp->data,
        (u_int *)&arrp->arrlnth, MAXLEN,
        sizeof(int), xdr_int));
}
```

The arguments of `xdr_array()` are the XDR handle, a pointer to the array, a pointer to the size of the array, the maximum array size, the size of each array element, and a pointer to the XDR routine to translate each array element. If the size of the array is known in advance, use `xdr_vector()`, as shown in the following code example.

EXAMPLE 4-5 xdr_vector Syntax Use

```
int intarr[SIZE];

bool_t
xdr_intarr(xdrsp, intarr)
    XDR *xdrsp;
    int intarr[];
{
    return (xdr_vector(xdrsp, intarr, SIZE,
        sizeof(int),
xdr_int));
}
```

XDR converts quantities to 4-byte multiples when serializing. For arrays of characters, each character occupies 32 bits. `xdr_bytes()` packs characters. It has four parameters similar to the first four parameters of `xdr_array()`.

Null-terminated strings are translated by `xdr_string()`, which is like `xdr_bytes()` with no length parameter. On serializing `xdr_string()` gets the string length from `strlen()`, and on deserializing it creates a null-terminated string.

The following example calls the built-in functions `xdr_string()` and `xdr_reference()`, which translates pointers to pass a string, and `struct simple` from previous examples.

EXAMPLE 4-6 xdr_reference Syntax Use

```
struct finalexample {
    char *string;
    struct simple *simplep;
} finalexample;

bool_t
xdr_finalexample(xdrsp, finalp)
    XDR *xdrsp;
    struct finalexample *finalp;
{
    if (!xdr_string(xdrsp, &finalp->string,
```

EXAMPLE 4-6 xdr_reference Syntax Use (Continued)

```
        MAXSTRLEN)
    return (FALSE);
    if (!xdr_reference( xdrsp, &finalp->simplep,
        sizeof(struct simple), xdr_simple))
        return (FALSE);
    return (TRUE);
}
```

Note that `xdr_simple()` could have been called here instead of `xdr_reference()`.

Standard Interfaces

Interfaces to standard levels of the RPC package provide increasing control over RPC communications. Programs that use this control are more complex. Effective programming at these lower levels requires more knowledge of computer network fundamentals. The top, intermediate, expert, and bottom levels are part of the standard interfaces.

This section describes how to control RPC details by using lower levels of the RPC library. For example, you can select the transport protocol, which can be done at the simplified interface level only through the `NETPATH` variable. You should be familiar with the top-level interface (TLI) in order to use these routines.

The routines shown below cannot be used through the simplified interface because they require a transport handle. For example, there is no way to allocate and free memory while serializing or deserializing with XDR routines at the simplified interface.

```
clnt_call()
clnt_destroy()
clnt_control()
clnt_perrno()
clnt_pcreateerror()
clnt_perror()
svc_destroy()
```

Top-Level Interface

At the top level, the application can specify the type of transport to use but not the specific transport. This level differs from the simplified interface in that the application creates its own transport handles in both the client and server.

Client Side of the Top-Level Interface

Assume the header file in the following code example.

EXAMPLE 4-7 time_prot.h Header File

```
/* time_prot.h */

#include <rpc/rpc.h>
#include <rpc/types.h>

struct timev {
    int second;
    int minute;
    int hour;
};
typedef struct timev timev;
bool_t xdr_timev();

#define TIME_PROG 0x40000001
#define TIME_VERS 1
#define TIME_GET 1
```

The following example shows the client side of a trivial date service using top-level service routines. The transport type is specified as an invocation argument of the program.

EXAMPLE 4-8 Client for Trivial Date Service

```
#include <stdio.h>
#include "time_prot.h"

#define TOTAL (30)
/*
 * Caller of trivial date service
 * usage: calltime hostname
 */
main(argc, argv)
    int argc;
    char *argv[];
{
    struct timeval time_out;
    CLIENT *client;
    enum clnt_stat stat;
    struct timev timev;
```

EXAMPLE 4-8 Client for Trivial Date Service (Continued)

```
char *nettype;

if (argc != 2 && argc != 3) {
    fprintf(stderr, "usage: %s host [nettype]\n",
           argv[0]);
    exit(1);
}
if (argc == 2)
    nettype = "netpath";          /* Default */
else
    nettype = argv[2];
client = clnt_create(argv[1], TIME_PROG,
                    TIME_VERS, nettype);
if (client == (CLIENT *) NULL) {
    clnt_pcreateerror("Couldn't create client");
    exit(1);
}
time_out.tv_sec = TOTAL;
time_out.tv_usec = 0;
stat = clnt_call(client, TIME_GET,
                xdr_void, (caddr_t) NULL,
                xdr_timev, (caddr_t) &timev,
                time_out);
if (stat != RPC_SUCCESS) {
    clnt_perror(client, "Call failed");
    exit(1);
}
fprintf(stderr, "%s: %02d:%02d:%02d GMT\n",
        nettype, timev.hour, timev.minute,
        timev.second);
(void) clnt_destroy(client);
exit(0);
}
```

If *nettype* is not specified in the invocation of the program, the string *netpath* is substituted. When RPC libraries routines encounter this string, the value of the `NETPATH` environment variable governs transport selection.

If the client handle cannot be created, display the reason for the failure with `clnt_pcreateerror()`. You can also get the error status by reading the contents of the global variable `rpc_createerr`.

After the client handle is created, `clnt_call()` is used to make the remote call. Its arguments are the remote procedure number, an XDR filter for the input argument, the argument pointer, an XDR filter for the result, the result pointer, and the time-out period of the call. The program has no arguments, so `xdr_void()` is specified. Clean up by calling `clnt_destroy()`.

To bound the time allowed for client handle creation in the previous example to 30 seconds, replace the call to `clnt_create()` with a call to `clnt_create_timed()` as shown in the following code segment:

```

struct timeval timeout;
timeout.tv_sec = 30;          /* 30 seconds */
timeout.tv_usec = 0;

client = clnt_create_timed(argv[1],
                           TIME_PROG, TIME_VERS, nettype,
                           &timeout);

```

The following example shows a top-level implementation of a server for the trivial date service.

EXAMPLE 4-9 Server for Trivial Date Service

```

#include <stdio.h>

#include <rpc/rpc.h>
#include "time_prot.h"

static void time_prog();

main(argc,argv)
    int argc;
    char *argv[];
{
    int transpnum;
    char *nettype;

    if (argc > 2) {
        fprintf(stderr, "usage: %s [nettype]\n",
                argv[0]);
        exit(1);
    }
    if (argc == 2)
        nettype = argv[1];
    else
        nettype = "netpath";          /* Default */
    transpnum =
    svc_create(time_prog,TIME_PROG,TIME_VERS,nettype);
    if (transpnum == 0) {
        fprintf(stderr,"%s: cannot create %s service.\n",
                argv[0], nettype);
        exit(1);
    }
    svc_run();
}

/*
 * The server dispatch function
 */
static void

```

EXAMPLE 4-9 Server for Trivial Date Service (Continued)

```
time_prog(rqstp, transp)
    struct svc_req *rqstp;
    SVCXPRT *transp;
{
    struct timev rslt;
    time_t thetime;

    switch(rqstp->rq_proc) {
        case NULLPROC:
            svc_sendreply(transp, xdr_void, NULL);
            return;
        case TIME_GET:
            break;
        default:
            svcerr_noproc(transp);
            return;
    }
    thetime = time((time_t *) 0);
    rslt.second = thetime % 60;
    thetime /= 60;
    rslt.minute = thetime % 60;
    thetime /= 60;
    rslt.hour = thetime % 24;
    if (!svc_sendreply( transp, xdr_timev, &rslt)) {
        svcerr_systemerr(transp);
    }
}
```

`svc_create()` returns the number of transports on which it created server handles. `time_prog()` is the service function called by `svc_run()` when a request specifies its program and version numbers. The server returns the results to the client through `svc_sendreply()`.

When you use `rpcgen` to generate the dispatch function, `svc_sendreply()` is called after the procedure returns. Therefore, `rslt` in this example must be declared `static` in the actual procedure. `svc_sendreply()` is called from inside the dispatch function, so `rslt` is not declared `static`.

In this example, the remote procedure takes no arguments. When arguments must be passed, the calls listed below fetch, deserialize (XDR decode), and free the arguments.

```
svc_getargs( SVCXPRT_handle, XDR_filter, argument_pointer);
svc_freeargs( SVCXPRT_handle, XDR_filter argument_pointer );
```

Intermediate-Level Interface

At the intermediate level, the application directly chooses the transport to use.

Client Side of the Intermediate-Level Interface

The following example shows the client side of the time service from “Top-Level Interface” on page 86, written at the intermediate level of RPC. In this example, the user must name the transport over which the call is made on the command line.

EXAMPLE 4-10 Client for Time Service, Intermediate Level

```
#include <stdio.h>

#include <rpc/rpc.h>
#include <netconfig.h>          /* For netconfig structure */
#include "time_prot.h"

#define TOTAL (30)

main(argc,argv)
    int argc;
    char *argv[];
{
    CLIENT *client;
    struct netconfig *nconf;
    char *netid;
    /* Declarations from previous example */

    if (argc != 3) {
        fprintf(stderr, "usage: %s host netid\n",
                argv[0]);
        exit(1);
    }
    netid = argv[2];
    if ((nconf = getnetconfig( netid)) ==
        (struct netconfig *) NULL) {
        fprintf(stderr, "Bad netid type: %s\n",
                netid);
        exit(1);
    }
    client = clnt_tp_create(argv[1], TIME_PROG,
                           TIME_VERS, nconf);
    if (client == (CLIENT *) NULL) {
        clnt_pcreateerror("Could not create client");
        exit(1);
    }
    freenetconfig(nconf);

    /* Same as previous example after this point */
}
```

In this example, the `netconfig` structure is obtained by a call to `getnetconfig(netid)`. See the `getnetconfig(3NSL)` man page and *Programming Interfaces Guide* for more details. At this level, the program explicitly selects the network.

To bound the time allowed for client handle creation in the previous example to 30 seconds, replace the call to `clnt_tp_create()` with a call to `clnt_tp_create_timed()` as shown in the following code segment:

```
struct timeval timeout;
timeout.tv_sec = 30; /* 30 seconds */
timeout.tv_usec = 0;

client = clnt_tp_create_timed(argv[1],
                             TIME_PROG, TIME_VERS, nconf,
                             &timeout);
```

Server Side of the Intermediate-Level Interface

The following example shows the corresponding server. The command line that starts the service must specify the transport over which the service is provided.

EXAMPLE 4-11 Server for Time Service, Intermediate Level

```
/*
 * This program supplies Greenwich mean
 * time to the client that invokes it.
 * The call format is: server netid
 */
#include <stdio.h>
#include <rpc/rpc.h>

#include <netconfig.h> /* For netconfig structure */
#include "time_prot.h"

static void time_prog();

main(argc, argv)
    int argc;
    char *argv[];
{
    SVCXPRT *transp;
    struct netconfig *nconf;

    if (argc != 2) {
        fprintf(stderr, "usage: %s netid\n",
                argv[0]);
        exit(1);
    }
    if ((nconf = getnetconfig(argv[1])) ==
        (struct netconfig *) NULL) {
        fprintf(stderr, "Could not find info on %s\n",
                argv[1]);
        exit(1);
    }
    transp = svc_tp_create(time_prog, TIME_PROG,
                          TIME_VERS, nconf);
    if (transp == (SVCXPRT *) NULL) {
```

EXAMPLE 4-11 Server for Time Service, Intermediate Level (Continued)

```
        fprintf(stderr, "%s: cannot create
                    %s service\n", argv[0], argv[1]);
        exit(1)
    }
    freenetconfigent(nconf);
    svc_run();
}

static
void time_prog(rqstp, transp)
    struct svc_req *rqstp;
    SVCXPRT *transp;
{
/* Code identical to Top Level version */
```

Expert-Level Interface

At the expert level, network selection is done the same as at the intermediate level. The only difference is in the increased level of control that the application has over the details of the CLIENT and SVCXPRT handles. These examples illustrate this control, which is exercised using the `clnt_tli_create()` and `svc_tli_create()` routines. For more information on TLI, see *Programming Interfaces Guide*.

Client Side of the Expert-Level Interface

Example 4-12 shows a version of `clntudp_create()`, the client creation routine for UDP transport, using `clnt_tli_create()`. The example shows how to do network selection based on the family of the transport you choose. `clnt_tli_create()` is used to create a client handle and to:

- Pass an open TLI file descriptor, which might or might not be bound
- Pass the server's address to the client
- Specify the send and receive buffer size

EXAMPLE 4-12 Client for RPC Lower Level

```
#include <stdio.h>

#include <rpc/rpc.h>
#include <netconfig.h>

#include <netinet/in.h>
/*
 * In earlier implementations of RPC,
 * only TCP/IP and UDP/IP were supported.
 * This version of clntudp_create()
```

EXAMPLE 4-12 Client for RPC Lower Level (Continued)

```
* is based on TLI/Streams.
*/
CLIENT *
clntudp_create(raddr, prog, vers, wait, sockp)
    struct sockaddr_in *raddr;      /* Remote address */
    rpcprog_t prog;                 /* Program number */
    prcvers_t vers;                 /* Version number */
    struct timeval wait;            /* Time to wait */
    int *sockp;                     /* fd pointer */
{
    CLIENT *cl;                     /* Client handle */
    int made_fd = FALSE;            /* Is fd opened here */
    int fd = *sockp;                /* TLI fd */
    struct t_bind *tbind;           /* bind address */
    struct netconfig *nconf;        /* netconfig structure */
    void *handlep;

    if ((handlep = setnetconfig()) == (void *) NULL) {
        /* Error starting network configuration */
        rpc_createerr.cf_stat = RPC_UNKNOWNPROTO;
        return((CLIENT *) NULL);
    }
    /*
     * Try all the transports until it gets one that is
     * connectionless, family is INET, and preferred name is UDP
     */
    while (nconf = getnetconfig( handlep)) {
        if ((nconf->nc_semantics == NC_TPI_CLTS) &&
            (strcmp( nconf->nc_protofmly, NC_INET ) == 0) &&
            (strcmp( nconf->nc_proto, NC_UDP ) == 0))
            break;
        }
    if (nconf == (struct netconfig *) NULL)
        rpc_createerr.cf_stat = RPC_UNKNOWNPROTO;
        goto err;
    }
    if (fd == RPC_ANYFD) {
        fd = t_open(nconf->nc_device, O_RDWR, &tinfo);
        if (fd == -1) {
            rpc_createerr.cf_stat = RPC_SYSTEMERROR;
            goto err;
        }
    }
}
if (raddr->sin_port == 0) { /* remote addr unknown */
    u_short sport;
    /*
     * rpcb_getport() is a user-provided routine that calls
     * rpcb_getaddr and translates the netbuf address to port
     * number in host byte order.
     */
    sport = rpcb_getport(raddr, prog, vers, nconf);
    if (sport == 0) {
```

EXAMPLE 4-12 Client for RPC Lower Level (Continued)

```
        rpc_createerr.cf_stat = RPC_PROGUNAVAIL;
        goto err;
    }
    raddr->sin_port = htons(sport);
}
/* Transform sockaddr_in to netbuf */
tbind = (struct t_bind *) t_alloc(fd, T_BIND, T_ADDR);
if (tbind == (struct t_bind *) NULL)
    rpc_createerr.cf_stat = RPC_SYSTEMERROR;
    goto err;
}
if (t_bind->addr.maxlen < sizeof( struct sockaddr_in))
    goto err;
(void) memcpy( tbind->addr.buf, (char *)raddr,
              sizeof(struct sockaddr_in));
tbind->addr.len = sizeof(struct sockaddr_in);
/* Bind fd */
if (t_bind( fd, NULL, NULL) == -1) {
    rpc_createerr.ct_stat = RPC_TLIERROR;
    goto err;
}
cl = clnt_tli_create(fd, nconf, &(tbind->addr), prog, vers,
                   tinfo.tsdu, tinfo.tsdu);
/* Close the netconfig file */
(void) endnetconfig( handlep);
(void) t_free((char *) tbind, T_BIND);
if (cl) {
    *sockp = fd;
    if (madefd == TRUE) {
        /* fd should be closed while destroying the handle */
        (void)clnt_control(cl, CLSET_FD_CLOSE, (char *)NULL);
    }
    /* Set the retry time */
    (void) clnt_control( 1, CLSET_RETRY_TIMEOUT,
                       (char *) &wait);

    return(cl);
}
err:
if (madefd == TRUE)
    (void) t_close(fd);
(void) endnetconfig(handlep);
return((CLIENT *) NULL);
}
```

The network is selected using `setnetconfig()`, `getnetconfig()`, and `endnetconfig()`. `endnetconfig()` is not called until after the call to `clnt_tli_create()`, near the end of the example.

`clntudp_create()` can be passed an open TLI *fd*. If passed none (`fd == RPC_ANYFD`), `clntudp_create()` opens its own using the `netconfig` structure for UDP to find the name of the device to pass to `t_open()`.

If the remote address is not known (`raddr->sin_port == 0`), it is obtained from the remote `rpcbind`.

After the client handle has been created, you can modify it using calls to `clnt_control()`. The RPC library closes the file descriptor when destroying the handle, as it does with a call to `clnt_destroy()` when it opens the *fd* itself. The RPC library then sets the retry timeout period.

Server Side of the Expert-Level Interface

Example 4-13 shows the server side of Example 4-12. It is called `svcudp_create()`. The server side uses `svc_tli_create()`.

`svc_tli_create()` is used when the application needs a fine degree of control, particularly to:

- Pass an open file descriptor to the application.
- Pass the user's bind address.
- Set the send and receive buffer sizes. The *fd* argument can be unbound when passed in. It is then bound to a given address, and the address is stored in a handle. If the bind address is set to `NULL` and the *fd* is initially unbound, it is bound to any suitable address.

Use `rpcb_set()` to register the service with `rpcbind`.

EXAMPLE 4-13 Server for RPC Lower Level

```
#include <stdio.h>

#include <rpc/rpc.h>
#include <netconfig.h>

#include <netinet/in.h>

SVCXPRT *
svcudp_create(fd)
    register int fd;
{
    struct netconfig *nconf;
    SVCXPRT *svc;
    int madefd = FALSE;
    int port;
    void *handlep;
    struct t_info tinfo;

    /* If no transports available */
    if ((handlep = setnetconfig() ) == (void *) NULL) {
        nc_perror("server");
        return((SVCXPRT *) NULL);
    }
    /*
```

EXAMPLE 4-13 Server for RPC Lower Level (Continued)

```

    * Try all the transports until it gets one which is
    * connectionless, family is INET and, name is UDP
    */
while (nconf = getnetconfig( handlep)) {
    if ((nconf->nc_semantics == NC_TPI_CLTS) &&

        (strcmp( nconf->nc_protofmly, NC_INET) == 0 )&&
        (strcmp( nconf->nc_proto, NC_UDP) == 0 ))
        break;
    }
if (nconf == (struct netconfig *) NULL) {
    endnetconfig(handlep);
    return((SVCXPRT *) NULL);
}
if (fd == RPC_ANYFD) {
    fd = t_open(nconf->nc_device, O_RDWR, &tinfo);
    if (fd == -1) {
        (void) endnetconfig();
        return((SVCXPRT *) NULL);
    }
    madefd = TRUE;
} else
    t_getinfo(fd, &tinfo);
svc = svc_tli_create(fd, nconf, (struct t_bind *) NULL,
                    tinfo.tsdu, tinfo.tsdu);
(void) endnetconfig(handlep);
if (svc == (SVCXPRT *) NULL) {
    if (madefd)
        (void) t_close(fd);
    return((SVCXPRT *)NULL);
}
return (svc);
}

```

The network selection here is accomplished similar to `clntudp_create()`. The file descriptor is not bound explicitly to a transport address because `svc_tli_create()` does that.

`svculdp_create()` can use an open *fd*. It opens one itself using the selected `netconfig` structure if none is provided.

Bottom-Level Interface

The bottom-level interface to RPC enables the application to control all options. `clnt_tli_create()` and the other expert-level RPC interface routines are based on these routines. You rarely use these low-level routines.

Bottom-level routines create internal data structures, buffer management, RPC headers, and so on. Callers of these routines, like the expert-level routine `clnt_tli_create()`, must initialize the `cl_netid` and `cl_tp` fields in the client handle. For a created handle, `cl_netid` is the network identifier (for example, `udp`) of the transport and `cl_tp` is the device name of that transport (for example, `/dev/udp`). The routines `clnt_dg_create()` and `clnt_vc_create()` set the `clnt_ops` and `cl_private` fields.

Client Side of the Bottom-Level Interface

The following code example shows calls to `clnt_vc_create()` and `clnt_dg_create()`.

EXAMPLE 4-14 Client for Bottom Level

```
/*
 * variables are:
 * cl: CLIENT *
 * tinfo: struct t_info returned from either t_open or t_getinfo
 * svcaddr: struct netbuf *
 */
switch(tinfo.servtype) {
    case T_COTS:
    case T_COTS_ORD:
        cl = clnt_vc_create(fd, svcaddr,
            prog, vers, sendsz, recvsz);
        break;
    case T_CLTS:
        cl = clnt_dg_create(fd, svcaddr,
            prog, vers, sendsz, recvsz);
        break;
    default:
        goto err;
}
```

These routines require that the file descriptor be open and bound. `svcaddr` is the address of the server.

Server Side of the Bottom-Level Interface

The following code example is an example of creating a bottom-level server.

EXAMPLE 4-15 Server for Bottom Level

```
/*
 * variables are:
 * xprt: SVCXPRT *
 */
switch(tinfo.servtype) {
```

EXAMPLE 4-15 Server for Bottom Level (Continued)

```
case T_COTS_ORD:
case T_COTS:
    xprt = svc_vc_create(fd, sendsz, recvsz);

    break;
case T_CLTS:
    xprt = svc_dg_create(fd, sendsz, recvsz);

    break;
default:
    goto err;
}
```

Server Caching

`svc_dg_enablecache()` initiates service caching for datagram transports. Caching should be used only in cases where a server procedure is a “once only” kind of operation. Executing a cached server procedure multiple times yields different results.

```
svc_dg_enablecache(xprt, cache_size)
    SVCXPRT *xprt;
    unsigned int cache_size;
```

This function allocates a duplicate request cache for the service endpoint *xprt*, large enough to hold *cache_size* entries. A duplicate request cache is needed if the service contains procedures with varying results. After caching is enabled, it cannot be disabled.

Low-Level Data Structures

The following data structure information is for reference only. The implementation might change.

The first structure is the client RPC handle, defined in `<rpc/clnt.h>`. Low-level implementations must provide and initialize one handle per connection, as shown in the following code example.

EXAMPLE 4-16 RPC Client Handle Structure

```
typedef struct {
    AUTH *cl_auth;                                /* authenticator */
    struct clnt_ops {
        enum clnt_stat (*cl_call)();             /* call remote procedure */
        void (*cl_abort)();                      /* abort a call */
        void (*cl_geterr)();                    /* get specific error code */
        bool_t (*cl_freeres)();                 /* frees results */
    };
};
```

EXAMPLE 4-16 RPC Client Handle Structure (Continued)

```

        void          (*cl_destroy)();          /* destroy this structure */
        bool_t        (*cl_control)();         /* the ioctl() of rpc */
    } *cl_ops;
    caddr_t          cl_private;                /* private stuff */
    char              *cl_netid;               /* network token */
    char              *cl_tp;                  /* device name */
} CLIENT;

```

The first field of the client-side handle is an authentication structure, defined in `<rpc/auth.h>`. By default, this field is set to `AUTH_NONE`. A client program must initialize `cl_auth` appropriately, as shown in the following code example.

EXAMPLE 4-17 Client Authentication Handle

```

typedef struct {
    struct          opaque_auth  ah_cred;
    struct          opaque_auth  ah_verf;
    union          des_block     ah_key;
    struct auth_ops {
        void        (*ah_nextverf)();
        int         (*ah_marshall)();          /* nextverf & serialize */
        int         (*ah_validate)();          /* validate verifier */
        int         (*ah_refresh)();           /* refresh credentials */
        void        (*ah_destroy)();           /* destroy this structure */
    } *ah_ops;
    caddr_t         ah_private;
} AUTH;

```

In the `AUTH` structure, `ah_cred` contains the caller's credentials, and `ah_verf` contains the data to verify the credentials. See "Authentication" on page 116 for details.

The following code example shows the server transport handle.

EXAMPLE 4-18 Server Transport Handle

```

typedef struct {
    int          xp_fd;
#define xp_sock          xp_fd
    u_short     xp_port;          /* associated port number. Obsolete */
    struct xp_ops {
        bool_t   (*xp_rcv)();     /* receive incoming requests */
        enum xp_rt_stat (*xp_stat)(); /* get transport status */
        bool_t   (*xp_getargs)(); /* get arguments */
        bool_t   (*xp_reply)();   /* send reply */
        bool_t   (*xp_freeargs)(); /* free mem alloc for args */
        void     (*xp_destroy)();  /* destroy this struct */
    } *xp_ops;
    int         xp_addrlen;       /* length of remote addr. Obsolete */
    char        *xp_tp;           /* transport provider device name */

```

EXAMPLE 4-18 Server Transport Handle (Continued)

```
char      *xp_netid;          /* network token */
struct netbuf xp_ltaddr;     /* local transport address */
struct netbuf xp_rtaddr;     /* remote transport address */
char      xp_raddr[16];     /* remote address. Now obsolete */
struct opaque_auth xp_verf; /* raw response verifier */
caddr_t   xp_p1;            /* private: for use by svc ops */
caddr_t   xp_p2;            /* private: for use by svc ops */
caddr_t   xp_p3;            /* private: for use by svc lib */
} SVCXPRT;
```

The following table shows the fields for the server transport handle.

<code>xp_fd</code>	The file descriptor associated with the handle. Two or more server handles can share the same file descriptor.
<code>xp_netid</code>	The network identifier (for example, <code>udp</code>) of the transport on which the handle is created and <code>xp_tp</code> is the device name associated with that transport.
<code>xp_ltaddr</code>	The server's own bind address.
<code>xp_rtaddr</code>	The address of the remote caller (and so can change from call to call).
<code>xp_netid xp_tp xp_ltaddr</code>	Initialized by <code>svc_tli_create()</code> and other expert-level routines.

The rest of the fields are initialized by the bottom-level server routines `svc_dg_create()` and `svc_vc_create()`.

For connection-oriented endpoints, the following fields are not valid until a connection has been requested and accepted for the server:

```
xp_fd
xp_ops()
xp_p1()
xp_p2
xp_verf()
xp_tp()
xp_ltaddr
xp_rtaddr()
xp_netid()
```

Testing Programs Using Low-Level Raw RPC

Two pseudo-RPC interface routines bypass all the network software. The routines shown in `clnt_raw_create()` and `svc_raw_create()` do not use any real transport.

Note – Do not use raw mode on production systems. Raw mode is intended as a debugging aid only. Raw mode is not MT safe.

The following code example is compiled and linked using the following makefile:

```
all: raw
CFLAGS += -g
raw: raw.o
cc -g -o raw raw.o -lnsl
```

EXAMPLE 4-19 Simple Program Using Raw RPC

```
/*
 * A simple program to increment a number by 1
 */

#include <stdio.h>
#include <rpc/rpc.h>

#include <rpc/raw.h>
#define prognum 0x40000001
#define versnum 1
#define INCR 1

struct timeval TIMEOUT = {0, 0};
static void server();

main (argc, argv)
    int argc;
    char **argv;
{
    CLIENT *cl;
    SVCXPRT *svc;
    int num = 0, ans;
    int flag;

    if (argc == 2)
        num = atoi(argv[1]);
        svc = svc_raw_create();
    if (svc == (SVCXPRT *) NULL) {
```

EXAMPLE 4-19 Simple Program Using Raw RPC (Continued)

```
        fprintf(stderr, "Could not create server handle\n");
        exit(1);
    }
    flag = svc_reg( svc, prognum, versnum, server,
                  (struct netconfig *) NULL );
    if (flag == 0) {
        fprintf(stderr, "Error: svc_reg failed.\n");
        exit(1);
    }
    cl = clnt_raw_create( prognum, versnum );
    if (cl == (CLIENT *) NULL) {
        clnt_pcreateerror("Error: clnt_raw_create");
        exit(1);
    }
    if (clnt_call(cl, INCR, xdr_int, (caddr_t) &num, xdr_int,
                 (caddr_t) &ans, TIMEOUT)
        != RPC_SUCCESS) {
        clnt_perror(cl, "Error: client_call with raw");
        exit(1);
    }
    printf("Client: number returned %d\n", ans);
    exit(0);
}

static void
server(rqstp, transp)
    struct svc_req *rqstp;
    SVCXPRT *transp;
{
    int num;

    fprintf(stderr, "Entering server procedure.\n");

    switch(rqstp->rq_proc) {
        case NULLPROC:
            if (svc_sendreply( transp, xdr_void,
                              (caddr_t) NULL) == FALSE) {
                fprintf(stderr, "error in null proc\n");
                exit(1);
            }
            return;
        case INCR:
            break;
        default:
            svcerr_noproc(transp);
            return;
    }
    if (!svc_getargs( transp, xdr_int, &num)) {
        svcerr_decode(transp);
        return;
    }
    fprintf(stderr, "Server procedure: about to increment.\n");
```

EXAMPLE 4-19 Simple Program Using Raw RPC (Continued)

```
num++;
if (svc_sendreply(transp, xdr_int, &num) == FALSE) {
    fprintf(stderr, "error in sending answer\n");
    exit (1);
}
fprintf(stderr, "Leaving server procedure.\n");
}
```

Note the following points about the example:

- The server must be created before the client.
- `svc_raw_create()` has no parameters.
- The server is not registered with `rpcbind`. The last parameter to `svc_reg()` is `(struct netconfig *) NULL`.
- `svc_run()` is not called.
- All the RPC calls occur within the same thread of control.
- The server-dispatch routine is the same as for normal RPC servers.

Connection-Oriented Transports

Example 4-20 copies a file from one host to another. The RPC `send()` call reads standard input and sends the data to the server `receive()`, which writes the data to standard output. This example also illustrates an XDR procedure that behaves differently on serialization and on deserialization. A connection-oriented transport is used.

EXAMPLE 4-20 Remote Copy (Two-Way XDR Routine)

```
/*
 * The xdr routine:
 *   on decode, read wire, write to fp
 *   on encode, read fp, write to wire
 */
#include <stdio.h>
#include <rpc/rpc.h>

bool_t
xdr_rcp(xdrs, fp)
    XDR *xdrs;
    FILE *fp;
{
    unsigned long size;
```

EXAMPLE 4-20 Remote Copy (Two-Way XDR Routine) *(Continued)*

```
char buf[BUFSIZ], *p;

if (xdrs->x_op == XDR_FREE)          /* nothing to free */
    return(TRUE);
while (TRUE) {
    if (xdrs->x_op == XDR_ENCODE) {
        if ((size = fread( buf, sizeof( char ), BUFSIZ, fp))
            == 0 && ferror(fp)) {
            fprintf(stderr, "can't fread\n");
            return(FALSE);
        } else
            return(TRUE);
    }
    p = buf;
    if (! xdr_bytes( xdrs, &p, &size, BUFSIZ))
        return(0);
    if (size == 0)
        return(1);
    if (xdrs->x_op == XDR_DECODE) {
        if (fwrite( buf, sizeof(char), size, fp) != size) {
            fprintf(stderr, "can't fwrite\n");
            return(FALSE);
        } else
            return(TRUE);
    }
}
}
```

In Example 4-21 and Example 4-22, the serializing and deserializing are done only by the `xdr_rcp()` routine shown in Example 4-20.

EXAMPLE 4-21 Remote Copy Client Routines

```
/* The sender routines */
#include <stdio.h>

#include <netdb.h>
#include <rpc/rpc.h>

#include <sys/socket.h>
#include <sys/time.h>
#include "rcp.h"

main(argc, argv)
    int argc;
    char **argv;
{
    int xdr_rcp();

    if (argc != 2 7) {
        fprintf(stderr, "usage: %s servername\n", argv[0]);
        exit(1);
    }
}
```

EXAMPLE 4-21 Remote Copy Client Routines (Continued)

```
    }
    if( callcots( argv[1], RCPPROG, RCPPROC, RCPVERS, xdr_rcp,
stdin,
        xdr_void, 0 ) != 0 )
        exit(1);
    exit(0);
}

callcots(host, prognum, procnum, versnum, inproc, in, outproc,
out)
char *host, *in, *out;
xdrproc_t inproc, outproc;
{
    enum clnt_stat clnt_stat;
    register CLIENT *client;
    struct timeval total_timeout;

    if ((client = clnt_create( host, prognum, versnum,
"circuit_v"
    == (CLIENT *) NULL)) {
        clnt_pcreateerror("clnt_create");
        return(-1);
    }
    total_timeout.tv_sec = 20;
    total_timeout.tv_usec = 0;
    clnt_stat = clnt_call(client, procnum, inproc, in, outproc,
out,
                        total_timeout);
    clnt_destroy(client);
    if (clnt_stat != RPC_SUCCESS)
        clnt_perror("callcots");
    return((int)clnt_stat);
}
```

The following code example defines the receiving routines. Note that in the server, `xdr_rcp()` did all the work automatically.

EXAMPLE 4-22 Remote Copy Server Routines

```
/*
 * The receiving routines
 */
#include <stdio.h>
#include <rpc/rpc.h>
#include "rcp.h"

main()
{
    void rcp_service();
    if (svc_create(rpc_service, RCPPROG, RCPVERS, "circuit_v") == 0) {
        fprintf(stderr, "svc_create: errpr\n");
        exit(1);
    }
}
```

EXAMPLE 4-22 Remote Copy Server Routines (Continued)

```
    }
    svc_run(); /* never returns */
    fprintf(stderr, "svc_run should never return\n");
}

void
rcp_service(rqstp, transp)
    register struct svc_req *rqstp;
    register SVCXPRT *transp;
{
    switch(rqstp->rq_proc) {
        case NULLPROC:
            if (svc_sendreply(transp, xdr_void, (caddr_t) NULL) == FALSE)
                fprintf(stderr, "err: rcp_service");
            return;
        case RCPPROC:
            if (!svc_getargs(transp, xdr_rcp, stdout)) {
                svcerr_decode(transp);
                return();
            }
            if (!svc_sendreply(transp, xdr_void, (caddr_t) NULL)) {
                fprintf(stderr, "can't reply\n");
                return();
            }
            return();
        default:
            svcerr_noproc(transp);
            return();
    }
}
```

Memory Allocation With XDR

XDR routines normally serialize and deserialize data. XDR routines often automatically allocate memory and free automatically allocated memory. The convention is to use a NULL pointer to an array or structure to indicate that an XDR function must allocate memory when deserializing. The next example, `xdr_chararr1()`, processes a fixed array of bytes with length `SIZE` and cannot allocate memory if needed:

```
xdr_chararr1(xdrsp, chararr)
    XDR *xdrsp;
    char chararr[];
{
    char *p;
    int len;
```

```

    p = chararr;
    len = SIZE;
    return (xdr_bytes(xdrsp, &p, &len, SIZE));
}

```

If space has already been allocated in *chararr*, it can be called from a server as follows.

```

char chararr[SIZE];
svc_getargs(transp, xdr_chararr1, chararr);

```

Any structure through which data is passed to XDR or RPC routines must be allocated so that its base address is at an architecture-dependent boundary. An XDR routine that does the allocation must be written so that it can:

- Allocate memory when a caller requests
- Return the pointer to any memory it allocates

In the following example, the second argument is a NULL pointer, meaning that memory should be allocated to hold the data being deserialized.

```

xdr_chararr2(xdrsp, chararrp)
    XDR *xdrsp;
    char **chararrp;
{
    int len;

    len = SIZE;
    return (xdr_bytes(xdrsp, chararrp, &len, SIZE));
}

```

The corresponding RPC call is:

```

char *arrptr;
arrptr = NULL;
svc_getargs(transp, xdr_chararr2, &arrptr);
/*
 * Use the result here
 */
svc_freeargs(transp, xdr_chararr2, &arrptr);

```

After use, free the character array through `svc_freeargs()`. `svc_freeargs()` does nothing if passed a NULL pointer as its second argument.

To summarize:

- An XDR routine normally serializes, deserializes, and frees memory.
- `svc_getargs()` calls the XDR routine to deserialize.
- `svc_freeargs()` calls the XDR routine to free memory.

Advanced RPC Programming Techniques

This section addresses areas of occasional interest to developers using the lower-level interfaces of the RPC package. The topics are:

- `poll()` on the server- How a server can call the dispatcher directly if calling `svc_run()` is not feasible
- Broadcast RPC - How to use the broadcast mechanisms
- Batching - How to improve performance by batching a series of calls
- Authentication - What authentication methods are available in this release
- Port monitors - How to interface with the `inetd` and `listener` port monitors
- Multiple program versions - How to service multiple program versions

`poll()` on the Server Side

This section applies only to servers running RPC in single-threaded (default) mode.

A process that services RPC requests and performs some other activity cannot always call `svc_run()`. If the other activity periodically updates a data structure, the process can set a `SIGALRM` signal before calling `svc_run()`. This process enables the signal handler to process the data structure and return control to `svc_run()` when done.

A process can bypass `svc_run()` and access the dispatcher directly with the `svc_getreqset()` call. The process must be given the file descriptors of the transport endpoints associated with the programs being waited on. Then the process can have its own `poll()` that waits on both the RPC file descriptors and its own descriptors.

Example 5-1 shows `svc_run()`. `svc_pollset` is an array of `pollfd` structures that is derived, through a call to `__rpc_select_to_poll()`, from `svc_fdset()`. The array can change every time any RPC library routine is called because descriptors are constantly being opened and closed. `svc_getreq_poll()` is called when `poll()` determines that an RPC request has arrived on some RPC file descriptors.

Note – The `__rpc_dtbsize()` and `__rpc_select_to_poll()` functions are not part of the SVID, but they are available in the `libnsl` library. The descriptions of these functions are included here so that you can create versions of these functions for non-Solaris implementations.

Given an `fd_set` pointer and the number of bits to check in it, the `__rpc_select_to_poll` function initializes the supplied `pollfd` array for RPC's use. RPC polls only for input events. The number of `pollfd` slots that were initialized is returned. The arguments for this function are:

```
int __rpc_select_to_poll(int fdmax, fd_set *fdset,
                       struct pollfd *pollset)
```

The `__rpc_dtbsize()` function calls the `getrlimit()` function to determine the maximum value that the system can assign to a newly created file descriptor. The result is cached for efficiency.

For more information on the SVID routines in this section, see the `rpc_svc_calls(3NSL)` and `poll(2)` man pages.

EXAMPLE 5-1 `svc_run()` and `poll()`

```
void
svc_run()
{
    int nfd;
    int dtbsize = __rpc_dtbsize();
    int i;
    struct pollfd svc_pollset[fd_setsize];

    for (;;) {
        /*
         * Check whether there is any server fd on which we may have
         * to wait.
         */
        nfd = __rpc_select_to_poll(dtbsize, &svc_fdset,
                                 svc_pollset);

        if (nfd == 0)
            break; /* None waiting, hence quit */

        switch (i = poll(svc_pollset, nfd, -1)) {
            case -1:
                /*
                 * We ignore all errors, continuing with the assumption
```

EXAMPLE 5-1 `svc_run()` and `poll()` (Continued)

```
        * that it was set by the signal handlers (or any
        * other outside event) and not caused by poll().
        */
    case 0:
        continue;
    default:
        svc_getreq_poll(svc_pollset, i);
    }
}
```

Broadcast RPC

When an RPC broadcast is issued, a message is sent to all `rpcbind` daemons on a network. An `rpcbind` daemon with which the requested service is registered forwards the request to the server. The main differences between broadcast RPC and normal RPC calls are:

- Normal RPC expects one answer; broadcast RPC expects many answers, one or more answer from each responding machine.
- Broadcast RPC works only on connectionless protocols that support broadcasting, such as UDP.
- With broadcast RPC, all unsuccessful responses are filtered out. If a version mismatch occurs between the broadcaster and a remote service, the broadcaster is never contacted by the service.
- Only datagram services registered with `rpcbind` are accessible through broadcast RPC. Service addresses can vary from one host to another, so `rpc_broadcast()` sends messages to `rpcbind`'s network address.
- The size of broadcast requests is limited by the maximum transfer unit (MTU) of the local network. The MTU for Ethernet is 1500 bytes.

The following code example shows how `rpc_broadcast()` is used and describes its arguments.

EXAMPLE 5-2 RPC Broadcast

```
/*
 * bcast.c: example of RPC broadcasting use.
 */

#include <stdio.h>
#include <rpc/rpc.h>
```

EXAMPLE 5-2 RPC Broadcast (Continued)

```

main(argc, argv)
    int argc;
    char *argv[];
{
    enum clnt_stat rpc_stat;
    rpcprog_t prognum;
    rpcvers_t vers;
    struct rpcent *re;

    if(argc != 3) {
        fprintf(stderr, "usage : %s RPC_PROG VERSION\n", argv[0]);
        exit(1);
    }
    if (isdigit( *argv[1]))
        prognum = atoi(argv[1]);
    else {
        re = getrpcbyname(argv[1]);
        if (! re) {
            fprintf(stderr, "Unknown RPC service %s\n", argv[1]);
            exit(1);
        }
        prognum = re->r_number;
    }
    vers = atoi(argv[2]);
    rpc_stat = rpc_broadcast(prognum, vers, NULLPROC, xdr_void,
        (char *)NULL, xdr_void, (char *)NULL, bcast_proc,
NULL);
    if ((rpc_stat != RPC_SUCCESS) && (rpc_stat != RPC_TIMEDOUT)) {
        fprintf(stderr, "broadcast failed: %s\n",
            clnt_sperrno(rpc_stat));
        exit(1);
    }
    exit(0);
}

```

The function in Example 5-3 collects the replies to the broadcast. The normal operation is to collect either the first reply or all replies. `bcast_proc()` displays the IP address of the server that has responded. Because the function returns `FALSE` it continues to collect responses. The RPC client code continues to resend the broadcast until it times out.

EXAMPLE 5-3 Collect Broadcast Replies

```

bool_t
bcast_proc(res, t_addr, nconf)
    void *res;
    struct t_bind *t_addr;
    struct netconfig *nconf;
{
    register struct hostent *hp;
    char *naddr;

```

/* Nothing comes back */
/* Who sent us the reply */

EXAMPLE 5-3 Collect Broadcast Replies (Continued)

```
naddr = taddr2naddr(nconf, &taddr->addr);
if (naddr == (char *) NULL) {
    fprintf(stderr, "Responded: unknown\n");
} else {
    fprintf(stderr, "Responded: %s\n", naddr);
    free(naddr);
}
return(FALSE);
}
```

If `done` is `TRUE`, then broadcasting stops and `rpc_broadcast()` returns successfully. Otherwise, the routine waits for another response. The request is rebroadcast after a few seconds of waiting. If no responses come back, the routine returns with `RPC_TIMEDOUT`.

Batching

RPC is designed so that clients send a call message and wait for servers to reply to the call. This procedure implies that a client is blocked while the server processes the call. This result is inefficient when the client does not need each message acknowledged.

RPC batching lets clients process asynchronously. RPC messages can be placed in a pipeline of calls to a server. Batching requires that:

- The server does not respond to any intermediate message.
- The pipeline of calls is transported on a reliable transport, such as TCP.
- The result's XDR routine in the calls is `NULL`.
- The RPC call's timeout is zero.

Because the server does not respond to each call, the client can send new calls in parallel with the server processing previous calls. The transport can buffer many call messages and send them to the server in one `write()` system call. This buffering decreases interprocess communication overhead and the total time of a series of calls. The client should end with a nonbatched call to flush the pipeline.

The following code example shows the unbatched version of the client. It scans the character array, *buf*, for delimited strings and sends each string to the server.

EXAMPLE 5-4 Unbatched Client

```
#include <stdio.h>

#include <rpc/rpc.h>
```

EXAMPLE 5-4 Unbatched Client (Continued)

```
#include "windows.h"

main(argc, argv)
    int argc;
    char **argv;
{
    struct timeval total_timeout;
    register CLIENT *client;
    enum clnt_stat clnt_stat;
    char buf[1000], *s = buf;

    if ((client = clnt_create( argv[1], WINDOWPROG, WINDOWVERS,
                             "circuit_v")) == (CLIENT *) NULL) {
        clnt_pcreateerror("clnt_create");
        exit(1);
    }

    total_timeout.tv_sec = 20;
    total_timeout.tv_usec = 0;
    while (scanf( "%s", s ) != EOF) {
        if (clnt_call(client, RENDERSTRING, xdr_wrapstring, &s,
                     xdr_void, (caddr_t) NULL, total_timeout) != RPC_SUCCESS) {
            clnt_perror(client, "rpc");
            exit(1);
        }
    }

    clnt_destroy( client );
    exit(0);
}
```

The following code example shows the batched version of the client. It does not wait after each string is sent to the server. It waits only for an ending response from the server.

EXAMPLE 5-5 Batched Client

```
#include <stdio.h>

#include <rpc/rpc.h>
#include "windows.h"

main(argc, argv)
    int argc;
    char **argv;
{
    struct timeval total_timeout;
    register CLIENT *client;
    enum clnt_stat clnt_stat;
    char buf[1000], *s = buf;

    if ((client = clnt_create( argv[1], WINDOWPROG, WINDOWVERS,
```

EXAMPLE 5-5 Batched Client (Continued)

```

                                "circuit_v")) == (CLIENT *) NULL) {
    clnt_pcreateerror("clnt_create");
    exit(1);
}
timerclear(&total_timeout);
while (scanf("%s", s) != EOF)
    clnt_call(client, RENDERSTRING_BATCHED, xdr_wrapstring,
              &s, xdr_void, (caddr_t) NULL, total_timeout);
/* Now flush the pipeline */
total_timeout.tv_sec = 20;
clnt_stat = clnt_call(client, NULLPROC, xdr_void,
                     (caddr_t) NULL, xdr_void, (caddr_t) NULL,
total_timeout);
if (clnt_stat != RPC_SUCCESS) {
    clnt_perror(client, "rpc");
    exit(1);
}
clnt_destroy(client);
exit(0);
}

```

The following code example shows the dispatch portion of the batched server. Because the server sends no message, the clients are not notified of failures.

EXAMPLE 5-6 Batched Server

```

#include <stdio.h>

#include <rpc/rpc.h>
#include "windows.h"

void
windowdispatch(rqstp, transp)
    struct svc_req *rqstp;
    SVCXPRT *transp;
{
    char *s = NULL;

    switch(rqstp->rq_proc) {
    case NULLPROC:
        if (!svc_sendreply( transp, xdr_void, NULL))
            fprintf(stderr, "can't reply to RPC call\n");
        return;
    case RENDERSTRING:
        if (!svc_getargs( transp, xdr_wrapstring, &s)) {
            fprintf(stderr, "can't decode arguments\n");
            /* Tell caller an error occurred */
            svcerr_decode(transp);
            break;
        }
        /* Code here to render the string s */
        if (!svc_sendreply( transp, xdr_void, (caddr_t) NULL))

```

EXAMPLE 5-6 Batched Server (Continued)

```
        fprintf( stderr, "can't reply to RPC call\n");
        break;
    case RENDERSTRING_BATCHED:
        if (!svc_getargs(transp, xdr_wrapstring, &s)) {
            fprintf(stderr, "can't decode arguments\n");
            /* Be silent in the face of protocol errors */
            break;
        }
        /* Code here to render string s, but send no reply! */
        break;
    default:
        svcerr_noproc(transp);
        return;
    }
    /* Now free string allocated while decoding arguments */
    svc_freeargs(transp, xdr_wrapstring, &s);
}
```

Note – To illustrate the benefits of batching, Example 5-4 and Example 5-6 were completed to render the lines in a 25,144-line file. The rendering service throws away the lines. The batched version of the application is four times as fast as the unbatched version.

Authentication

Just as you can use different transports when creating RPC clients and servers, you can associate different “flavors” of authentication with RPC clients. The authentication subsystem of RPC is open ended. So, RPC can support many flavors of authentication. Appendix B further defines the authentication protocols.

Sun RPC currently supports the authentication flavors shown in the following table.

TABLE 5-1 Authentication Methods Supported by Sun RPC

Method	Description
AUTH_NONE	Default. No authentication performed.
AUTH_SYS	An authentication flavor based on the process permissions authentication in the UNIX operating system.

TABLE 5-1 Authentication Methods Supported by Sun RPC (Continued)

Method	Description
AUTH_SHORT	An alternate flavor of AUTH_SYS used by some servers for efficiency. Client programs using AUTH_SYS authentication can receive AUTH_SHORT response verifiers from some servers. See Appendix B for details.
AUTH_DES	An authentication flavor based on DES encryption techniques.
AUTH_KERB	Version 5 Kerberos authentication based on DES framework.

When a caller creates a new RPC client handle as in:

```
clnt = clnt_create(host, prognum, versnum, nettype);
```

the appropriate client-creation routine sets the associated authentication handle to:

```
clnt->cl_auth = authnone_create();
```

If you create a new instance of authentication, you must destroy it with `auth_destroy(clnt->cl_auth)`. This destruction conserves memory.

On the server side, the RPC package passes a request that has an arbitrary authentication style associated with it to the service-dispatch routine. The request handle passed to a service-dispatch routine contains the structure `rq_cred`. This structure is opaque, except for one field: the flavor of the authentication credentials.

```
/*  
 * Authentication data  
 */  
struct opaque_auth {  
    enum_t    oa_flavor;           /* style of credentials */  
    caddr_t   oa_base;            /* address of more auth stuff */  
    u_int     oa_length;          /* not to exceed MAX_AUTH_BYTES */  
};
```

The RPC package guarantees the following structural requirements to the service-dispatch routine:

- The `rq_cred` field in the `svc_req` structure is well formed. You can check `rq_cred.oa_flavor` to get the flavor of authentication. You can also check the other fields of `rq_cred` if RPC does not support the flavor.
- The `rq_clntcred` field that is passed to service procedures is either NULL or points to a well-formed structure that corresponds to a supported flavor of authentication credential. No authentication data exists for the AUTH_NONE flavor. `rq_clntcred` can be cast only as a pointer to an `authsys_parms`, `short_hand_verf`, `authkerb_cred`, or `authdes_cred` structure.

AUTH_SYS Authentication

The client can use AUTH_SYS style authentication (called AUTH_UNIX in previous releases) by setting `clnt->cl_auth` after creating the RPC client handle:

```
clnt->cl_auth = authsys_create_default();
```

This setting causes each RPC call associated with `clnt` to carry with it the following credentials-authentication structure shown in the following example:

EXAMPLE 5-7 AUTH_SYS Credential Structure

```
/*
 * AUTH_SYS flavor credentials.
 */
struct authsys_parms {
    u_long aup_time;           /* credentials creation time */
    char *aup_machname;       /* client's host name */
    uid_t aup_uid;            /* client's effective uid */
    gid_t aup_gid;            /* client's current group id */
    u_int aup_len;            /* element length of aup_gids*/
    gid_t *aup_gids;          /* array of groups user is in */
};
```

`rpc.broadcast` defaults to AUTH_SYS authentication.

The following example shows a server, with procedure `RUSERPROC_1()`, that returns the number of users on the network. As an example of authentication, the server checks AUTH_SYS credentials and does not service requests from callers with a *uid* of 16.

EXAMPLE 5-8 Authentication Server

```
nuser(rqstp, transp)
    struct svc_req *rqstp;
    SVCXPRT *transp;
{
    struct authsys_parms *sys_cred;
    uid_t uid;
    unsigned int nusers;

    /* NULLPROC should never be authenticated */
    if (rqstp->rq_proc == NULLPROC) {
        if (!svc_sendreply( transp, xdr_void, (caddr_t) NULL))
            fprintf(stderr, "can't reply to RPC call\n");
        return;
    }

    /* now get the uid */
    switch(rqstp->rq_cred.oa_flavor) {
        case AUTH_SYS:
            sys_cred = (struct authsys_parms *) rqstp->rq_clntcred;
            uid = sys_cred->aup_uid;
```

EXAMPLE 5-8 Authentication Server (Continued)

```
        break;
    default:
        svcerr_weakauth(transp);
        return;
    }
    switch(rqstp->rq_proc) {
    case RUSERSPROC_1:
        /* make sure caller is allowed to call this proc */
        if (uid == 16) {
            svcerr_systemerr(transp);

            return;
        }
        /*
         * Code here to compute the number of users and assign it
         * to the variable nusers
         */
        if (!svc_sendreply( transp, xdr_u_int, &nusers))
            fprintf(stderr, "can't reply to RPC call\n");
        return;
    default:
        svcerr_noproc(transp);
        return;
    }
}
```

Note the following points about the example:

- The authentication parameters associated with the NULLPROC (procedure number zero) are usually not checked.
- The server calls `svcerr_weakauth()` if the authentication parameter's flavor is too weak. In this case, there is no way to get the list of authentication flavors the server requires.
- The service protocol should return status for access denied. In the examples, the protocol instead calls the service primitive `svcerr_systemerr()`.

The last point underscores the relation between the RPC authentication package and the services: RPC deals only with authentication and not with an individual service's access control. The services must establish access-control policies and reflect these policies as return statuses in their protocols.

AUTH_DES Authentication

Use AUTH_DES authentication for programs that require more security than AUTH_SYS provides. AUTH_SYS authentication is easy to defeat. For example, instead of using `authsys_create_default()`, a program can call `authsys_create()` and change the RPC authentication handle to give itself any desired user ID and host name.

AUTH_DES authentication requires `key serv()` daemons to be running on both the server and client hosts. The NIS or NIS+ naming service must also be running. Users on these hosts need public/secret key pairs assigned by the network administrator in the `publickey()` database. The users must also have decrypted their secret keys with the `keylogin()` command. This decryption is normally done by `login()` unless the login password and secure-RPC password differ.

To use AUTH_DES authentication, a client must set its authentication handle appropriately, as shown in the following example.

```
cl->cl_auth = authdes_seccreate(servername, 60, server,
                               (char *)NULL);
```

The first argument is the network name or “net name” of the owner of the server process. Server processes are usually root processes, and you can get their net names with the following call;

```
char servername[MAXNETNAMELEN];
host2netname(servername, server, (char *)NULL);
```

`servername` points to the receiving string and `server` is the name of the host the server process is running on. If the server process was run by a non-root user, use the call `user2netname()` as follows:

```
char servername[MAXNETNAMELEN];
user2netname(servername, serveruid(), (char *)NULL);
```

`serveruid()` is the user ID of the server process. The last argument of both functions is the name of the domain that contains the server. NULL means “use the local domain name.”

The second argument of `authdes_seccreate()` is the lifetime (known also as the “window”) of the client’s credential. In this example, a credential expires 60 seconds after the client makes an RPC call. If a program tries to reuse the credential, the server RPC subsystem recognizes that the credential has expired and does not service the request carrying the expired credential. If any program tries to reuse a credential within its lifetime, the process is rejected, because the server RPC subsystem saves credentials it has seen in the near past and does not serve duplicates.

The third argument of `authdes_seccreate()` is the name of the *timehost* used to synchronize clocks. AUTH_DES authentication requires that server and client agree on the time. Example 5-8 specifies synchronization with the server. A `(char *)NULL` says not to synchronize. Use this syntax only when you are sure that the client and server are already synchronized.

The fourth argument of `authdes_seccreate()` points to a DES encryption key to encrypt timestamps and data. If this argument is `(char *)NULL`, as it is in Example 5-8, a random key is chosen. The `ah_key` field of the authentication handle contains the key.

The server side is simpler than the client. The following example shows the server in Example 5-8 changed to use AUTH_DES.

EXAMPLE 5-9 AUTH_DES Server

```
#include <rpc/rpc.h>
...
...
nuser(rqstp, transp)
struct svc_req *rqstp;
SVCXPRT *transp;
{
    struct authdes_cred *des_cred;
    uid_t uid;
    gid_t gid;
    int gidlen;
    gid_t gidlist[10];

    /* NULLPROC should never be authenticated */
    if (rqstp->rq_proc == NULLPROC) {
        /* same as before */
    }
    /* now get the uid */
    switch(rqstp->rq_cred.oa_flavor) {
        case AUTH_DES:
            des_cred = (struct authdes_cred *) rqstp->rq_clntcred;
            if (! netname2user( des_cred->adc_fullname.name, &uid,
                                &gid, &gidlen, gidlist)) {
                fprintf(stderr, "unknown user: %s\n",
                        des_cred->adc_fullname.name);
                svcerr_systemerr(transp);
                return;
            }
            break;
        default:
            svcerr_weakauth(transp);
            return;
    }
    /* The rest is the same as before */
}
```

The routine `netname2user()` converts a network name, or “net name” of a user, to a local system ID. It also supplies group IDs, which are not used in this example.

AUTH_KERB Authentication

SunOS 5.0 and compatible versions include support for most client-side features of Kerberos 5 except `klogin`. `AUTH_KERB` is conceptually similar to `AUTH_DES`. The essential difference is that `DES` passes a network name and a DES-encrypted session key, while Kerberos passes the encrypted service ticket. This section describes other factors that affect implementation and interoperability.

Kerberos uses the concept of a time window in which its credentials are valid. It does not place restrictions on the clocks of the client or server. Specifically, the *window* is passed as an argument to `authkerb_seccreate()`. The window does not change. If a *timehost* is specified as an argument, the client side gets the time from the *timehost* and alters its timestamp by the difference in time. Various methods of time synchronization are available. See the `kerberos_rpc` man page for more information.

Kerberos users are identified by a primary name, instance, and realm. The RPC authentication code ignores the realm and instance, while the Kerberos library code does not. The assumption is that user names are the same between client and server. This enables a server to translate a primary name into user identification information. Two forms of well-known names are used (omitting the realm):

- `root.host` represents a privileged user on client *host*.
- `user.ignored` represents the user whose user name is *user*. The instance is ignored.

Kerberos uses cipher block chaining (CBC) mode when sending a full name credential, one that includes the ticket and window, and electronic code book (ECB) mode otherwise. CBC and ECB are two methods of DES encryption. The session key is used as the initial input vector for CBC mode. The following notation means that XDR is used on *object* as a type.

```
xdr_type(object)
```

The length in the next code section is the size, in bytes of the credential or verifier, rounded up to 4-byte units. The full name credential and verifier are obtained as follows:

```
xdr_long(timestamp.seconds)
xdr_long(timestamp.useconds)
xdr_long(window)
xdr_long(window - 1)
```

After encryption with CBC with input vector equal to the session key, the output is two DES cipher blocks:

```
CB0
CB1.low
CB1.high
```

The credential is:

```
xdr_long (AUTH_KERB)
xdr_long (length)
xdr_enum (AKN_FULLNAME)
xdr_bytes (ticket)
xdr_opaque (CB1.high)
```

The verifier is:

```
xdr_long (AUTH_KERB)
xdr_long (length)
xdr_opaque (CB0)
xdr_opaque (CB1.low)
```

The nickname exchange yields:

```
xdr_long (timestamp.seconds)
xdr_long (timestamp.useconds)
```

The nickname is encrypted with ECB to obtain ECB0, and the credential is:

```
xdr_long (AUTH_KERB)
xdr_long (length)
xdr_enum (AKN_NICKNAME)
xdr_opaque (akc_nickname)
```

The verifier is:

```
xdr_long (AUTH_KERB)
xdr_long (length)
xdr_opaque (ECB0)
xdr_opaque (0)
```

Authentication Using RPCSEC_GSS

A determined snoop can overcome the authentication flavors mentioned previously—AUTH_SYS, AUTH_DES, and AUTH_KERB. For this reason a new networking layer, the Generic Security Standard API, or GSS-API, was added, which RPC programmers can use. The GSS-API framework offers two extra services beyond authentication: integrity and privacy.

- *Integrity.* With the integrity service, the GSS-API uses the underlying mechanism to authenticate messages exchanged between programs. Cryptographic checksums establish:
 - The identity of the data originator to the recipient
 - The identity of the recipient to the originator if mutual authentication is requested
 - The authenticity of the transmitted data itself

- *Privacy.* The privacy service includes the integrity service. In addition, the transmitted data is also encrypted to protect it from any eavesdroppers.
Because of U.S. export restrictions, the privacy service might not be available to all users.

Note – Currently, the GSS-API is exposed, and certain GSS-API features are visible through RPCSEC_GSS functions. See the *GSS-API Programming Guide*.

RPCSEC_GSS API

The RPCSEC_GSS security flavor enables ONC RPC applications to maximize the features of GSS-API. RPCSEC_GSS sits “on top” of the GSS-API layer as shown in the following figure.

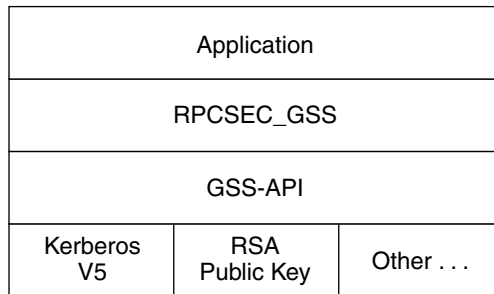

FIGURE 5-1 GSS-API and RPCSEC_GSS Security Layers

Using the programming interface for RPCSEC_GSS, ONC RPC applications can specify the following information:

- **Mechanism** — A security paradigm. Each kind of security mechanism offers a different kind of data protection, as well as one or more levels of data protection. You can use any security mechanism supported by the GSS-API (Kerberos V5, RSA public key, and so forth).
- **Security service** — Either privacy or integrity or neither. The default is integrity. The service is mechanism independent.
- **QOP** — Quality of protection. The QOP specifies the type of cryptographic algorithm to be used to implement privacy or integrity services. Each security mechanism can have one or more QOPs associated with it.

Applications can obtain lists of valid QOPs and mechanisms through functions provided by `RPCSEC_GSS`. See “Miscellaneous Functions” on page 133. Developers should avoid hard-coding mechanisms and QOPs into their applications, so that the applications do not need to be modified to use new or different mechanisms and QOPs.

Note – Historically, “security flavor” and “authentication flavor” have had the same meaning. With the introduction of `RPCSEC_GSS`, “flavor” now has a somewhat different sense. A flavor can now include a service integrity or privacy along with authentication, although currently `RPCSEC_GSS` is the only flavor that falls into this category.

Using `RPCSEC_GSS`, ONC RPC applications establish a security context with a peer, exchange data, and destroy the context, just as they do with other flavors. After a context is established, the application can change the QOP and service for each data unit sent.

For more information on `RPCSEC_GSS`, including `RPCSEC_GSS` data types, see the `rpcsec_gss(3N)` man page.

RPCSEC_GSS Routines

The following table summarizes `RPCSEC_GSS` commands. It is a general overview of `RPCSEC_GSS` functions, rather than a specific description of each one. For more information on each function, see its man page, or check the `rpcsec_gss(3NSL)` man page for an overview, including a list of `RPCSEC_GSS` data structures.

TABLE 5–2 `RPCSEC_GSS` Functions

Action	Function	Input	Output
Create a security context	<code>rpc_gss_seccreate(3NSL)</code>	CLIENT handle, principal name, mechanism, QOP, service type	AUTH handle
Change QOP, service type for context	<code>rpc_gss_set_defaults(3NSL)</code>	Old QOP, service	New QOP, service
Show maximum size for data before security transformation	<code>rpc_gss_max_data_length(3NSL)</code> (client side)	Maximum data size allowed by transport	Maximum pre-transformation data size

TABLE 5-2 RPCSEC_GSS Functions (Continued)

Action	Function	Input	Output
Show maximum size for data before security transformation	<code>rpc_gss_svc_max_data_length(3NSL)</code> (server side)	Maximum data size allowed by transport	Maximum pre-transformation data size
Set name of principals for server to represent	<code>rpc_gss_set_svc_name(3NSL)</code>	Principal name, RPC program, version #s	TRUE if successful
Fetch credentials of caller (client)	<code>rpc_gss_getcred(3NSL)</code>	Pointer to <code>svc_req</code> structure	UNIX credentials, RPCSEC_GSS credentials, cookie
Specify user-written callback function	<code>rpc_gss_set_callback(3NSL)</code>	Pointer to callback function	TRUE if successful
Create RPCSEC_GSS structure for principal names from unique parameters	<code>rpc_gss_get_principal_name(3NSL)</code>	Mechanism, user name, machine name, domain name	RPCSEC_GSS principal name structure
Fetch an error code when an RPCSEC_GSS routine fails	<code>rpc_gss_get_error(3NSL)</code>		RPCSEC_GSS error number, <code>errno</code> if applicable
Get strings for installed mechanisms	<code>rpc_gss_get_mechanisms(3NSL)</code>		List of valid mechanisms
Get valid QOP strings	<code>rpc_gss_get_mech_info(3NSL)</code>	Mechanism	Valid QOPs for that mechanism
Get the highest, lowest version numbers of RPCSEC_GSS supported	<code>rpc_gss_get_versions(3NSL)</code>		Highest, lowest versions
Check if a mechanism is installed	<code>rpc_gss_is_installed(3NSL)</code>	Mechanism	TRUE if installed

TABLE 5-2 RPCSEC_GSS Functions (Continued)

Action	Function	Input	Output
Convert ASCII mechanism to RPC object identifier	<code>rpc_gss_mech_to_oid(3NSL)</code>	Mechanism (as string)	Mechanism (as OID)
Convert ASCII QOP to integer	<code>rpc_gss_qop_to_num(3NSL)</code>	QOP (as string)	QOP (as integer)

Creating a Context

You create contexts with the `rpc_gss_seccreate()` call. This function takes as its arguments:

- A client handle returned, for example, by `clnt_create()`
- The name of the server principal, for example, `nfs@acme.com`
- The mechanism (for example, Kerberos V5) for the session
- The security service type (for example, `privacy`)
- The QOP for the session
- Two GSS-API parameters that can remain opaque for most uses (that is, the programmer can supply NULL values)

This function returns an AUTH authentication handle. The following example shows how `rpc_gss_seccreate()` might be used to create a context using the Kerberos V5 security mechanism and the integrity service.

EXAMPLE 5-10 `rpc_gss_seccreate()`

```
CLIENT *clnt;                /* client handle */
char server_host[] = "foo";
char service_name[] = "nfs@eng.acme.com";
char mech[] = "kerberos_v5";

clnt = clnt_create(server_host, SERVER_PROG, SERV_VERS, "netpath");
clnt->clnt_auth = rpc_gss_seccreate(clnt, service_name, mech,
                                   rpc_gss_svc_integrity, NULL, NULL, NULL);

. . .
```

Note the following points about the example:

- Although the mechanism was declared explicitly for ease of reading, it would be more commonly obtained programmatically with `rpc_gss_get_mechanisms()` from a table of available mechanisms.

- The QOP is passed as a NULL, which sets the QOP to this mechanism's default. Otherwise, a valid value could, as with the mechanism, be obtained programmatically with `rpc_gss_get_mechanisms()`. See the `rpc_gss_get_mechanisms(3NSL)` man page for more information.
- The security service type, `rpc_gss_svc_integrity`, is an enum of the RPCSEC_GSS type `rpc_gss_service_t`. `rpc_gss_service_t` has the following format:

```
typedef enum {
    rpc_gss_svc_default = 0,
    rpc_gss_svc_none = 1,
    rpc_gss_svc_integrity = 2,
    rpc_gss_svc_privacy = 3
} rpc_gss_service_t;
```

The default security service maps to integrity, so the programmer could have specified `rpc_gss_svc_default` and obtained the same result.

For more information, see the `rpc_gss_seccreate(3NSL)` man page.

Changing Values and Destroying a Context

After a context has been set, the application might need to change QOP and service values for individual data units being transmitted. For example, if you want a program to encrypt a password but not a login name, you can use `rpc_gss_set_defaults()`.

EXAMPLE 5-11 `rpc_gss_set_defaults()`

```
rpc_gss_set_defaults(clnt->clnt_auth, rpc_gss_svc_privacy, qop);
. . .
```

In this case, the security service is set to privacy. See “Creating a Context” on page 127. `qop` is a pointer to a string naming the new QOP.

Contexts are destroyed in the usual way, with `auth_destroy()`.

For more information on changing service and QOP, see the `rpc_gss_set_defaults(3NSL)` man page.

Principal Names

You need both a client and a server principal name to establish and maintain a security context.

- A server's principal name is always specified as a NULL-terminated ASCII string of the form *service@host*. One example is *nfs@eng.acme.com*.

When a client creates a security context, it specifies the server principal name in this format. See "Creating a Context" on page 127. Similarly, when a server needs to set the name of a principal it represents, it uses `rpc_gss_set_svc_name()`. This function takes a principal name in this format as an argument.

- The principal name of a client, as received by a server, takes the form of an `rpc_gss_principal_t` structure: a counted, opaque byte string determined by the mechanism being used. This structure is described in the `rpcsec_gss(3NSL)` man page.

Setting Server Principal Names

A server needs to be told the names of the principals it represents when it starts up. A server can act as more than one principal. `rpc_gss_set_svc_name()` sets the name of the principals, as shown in the following code example.

```
EXAMPLE 5-12 rpc_gss_set_svc_name()
char *principal, *mechanism;
u_int req_time;

principal = "nfs@eng.acme.com";
mechanism = "kerberos_v5";
req_time = 10000;          /* time for which credential should be valid */

rpc_gss_set_svc_name(principal, mechanism, req_time, SERV_PROG, SERV_VERS);
```

Kerberos ignores the *req_time* parameter. Other authentication systems might use it.

For more information, see the `rpc_gss_set_svc_name(3NSL)` man page.

Generating Client Principal Names

Servers need to be able to operate on a client's principal name. For example, you might need to compare a client's principal name to an access control list, or look up a UNIX credential for that client, if such a credential exists. Such principal names are kept in the form of a `rpc_gss_principal_t` structure pointer. See the `rpcsec_gss(3NSL)` man page for more on `rpc_gss_principal_t`. If a server is to compare a principal name it has received with the name of a known entity, the server needs to be able to generate a principal name in that form.

The `rpc_gss_get_principal_name()` call takes as input several parameters that uniquely identify an individual on a network, and generates a principal name as a `rpc_gss_principal_t` structure pointer, as shown in the following code example.

```

EXAMPLE 5-13 rpc_gss_get_principal_name()
rpc_gss_principal_t *principal;
rpc_gss_get_principal_name(principal, mechanism, name, node, domain);
. . .

```

The arguments to `rpc_gss_get_principal_name()` are:

- *principal* is a pointer to the `rpc_gss_principal_t` structure to be set.
- *mechanism* is the security mechanism being used. The principal name being generated is mechanism dependent.
- *name* is an individual or service name, such as `joeh` or `nfs`, or even the name of a user-defined application.
- *node* might be, for example, a UNIX machine name.
- *domain* might be, for example, a DNS, NIS, or NIS+ domain name, or a Kerberos realm.

Each security mechanism requires different identifying parameters. For example, Kerberos V5 requires a user name and, only optionally, qualified node and domain names, which in Kerberos terms are host and realm names.

For more information, see the `rpc_gss_get_principal_name(3NSL)` man page.

Freeing Principal Names

Use the `free()` library call to free principal names.

Receiving Credentials at the Server

A server must be able to fetch the credentials of a client. The `rpc_gss_getcred()` function, shown in Example 5-14, enables the server to retrieve either UNIX credentials or RPCSEC_GSS credentials, or both. The function has two arguments that are set if the function is successful. One is a pointer to an `rpc_gss_ucred_t` structure, which contains the caller's UNIX credentials, if such exist:

```

typedef struct {
    uid_t    uid;           /* user ID */
    gid_t    gid;           /* group ID */
    short    gidlen;
    git_t    *gidlist;     /* list of groups */
} rpc_gss_ucred_t;

```

The other argument is a pointer to a `rpc_gss_raw_cred_t` structure, which looks like this:

```

typedef struct {
    u_int    version;           /*RPCSEC_GS program version *mechanism;
    char     *qop;

```

```

    rpc_gss_principal_t client_principal; /* client principal name */
    char                *svc_principal; /*server principal name */
    rpc_gss_service_t   service;        /* privacy, integrity enum */
} rpc_gss_rawcred_t;

```

Because `rpc_gss_rawcred_t` contains both the client and server principal names, `rpc_gss_getcred()` can return them both. See “Generating Client Principal Names” on page 129 for a description of the `rpc_gss_principal_t` structure and how it is created.

The following example is a simple server-side dispatch procedure, in which the server gets the credentials for the caller. The procedure gets the caller’s UNIX credentials and then verifies the user’s identity, using the mechanism, QOP, and service type found in the `rpc_gss_rcred_t` argument.

EXAMPLE 5-14 Getting Credentials

```

static void server_prog(struct svc_req *rqstp, SVCXPRT *xpirt)
{
    rpc_gss_ucred_t *ucred;
    rpc_gss_rawcred_t *rcred;

    if (rqstp->rq_proq == NULLPROC) {
        svc_sendreply(xpirt, xdr_void, NULL);
        return;
    }
    /*
     * authenticate all other requests */
    /*

    switch (rqstp->rq_cred.oa_flavor) {
    case RPCSEC_GSS:
        /*
         * get credential information
         */
        rpc_gss_getcred(rqstp, &rcred, &ucred, NULL);
        /*
         * verify that the user is allowed to access
         * using received security parameters by
         * peeking into my config file
         */
        if (!authenticate_user(ucred->uid, rcred->mechanism,
            rcred->qop, rcred->service)) {
            svcerr_weakauth(xpirt);
            return;
        }
        break; /* allow the user in */
    default:
        svcerr_weakauth(xpirt);
        return;
    } /* end switch */

    switch (rqstp->rq_proq) {
    case SERV_PROCL1:

```

EXAMPLE 5-14 Getting Credentials (Continued)

```
    . . . .  
    }  
  
    /* usual request processing; send response ... */  
    return;  
  
}
```

For more information, see the `rpc_gss_getcred(3NSL)` man page.

Cookies

In Example 5-14, the last argument to `rpc_gss_getcred()` (here, a `NULL`) is a user-defined cookie, with a value on return of whatever was specified by the server when the context was created. This cookie, a 4-byte value, can be used in any way appropriate for the application. RPC does not interpret the cookie. For example, the cookie can be a pointer or index to a structure that represents the context initiator. Instead of computing this value for every request, the server computes it at context-creation time, saving on request-processing time.

Callbacks

Another opportunity to use cookies is with callbacks. By using the `rpc_gss_set_callback()` function, a server can specify a user-defined callback so that it knows when a context first gets used. The callback is invoked the first time a context is used for data exchanges, after the context is established for the specified program and version.

The user-defined callback routine takes the following form:

```
bool_t callback (struct svc_req *req, gss_cred_id_t deleg,  
gss_ctx_id_t gss_context, rpc_gss_lock_t *  
lock, void ** cookie);
```

The second and third arguments, `deleg` and `gss_context`, are GSS-API data types and are currently exposed. See the *GSS-API Programming Guide* for more information. Note that `deleg` is the identity of any delegated peer, while `gss_context` is a pointer to the GSS-API context. This pointer is necessary in case the program needs to perform GSS-API operations on the context, that is, to test for acceptance criteria. You have already seen the `cookie` argument.

The `lock` argument is a pointer to a `rpc_gss_lock_t` structure:

```
typedef struct {  
    bool_t                locked;
```

```
        rpc_gss_rawcred_t    *raw_cred;
} rpc_gss_lock_t;
```

This parameter enables a server to enforce a particular QOP and service for the session. QOP and service are found in the `rpc_gss_rawcred_t` structure described in Example 5–14. A server should not change the values for service and QOP. When the user-defined callback is invoked, the *locked* field is set to `FALSE`. If the server sets *locked* to `TRUE`, only requests with QOP and service values that match the QOP and service values in the `rpc_gss_rawcred_t` structure are accepted.

For more information, see the `rpc_gss_set_callback(3NSL)` man page.

Maximum Data Size

Two functions, `rpc_gss_max_data_length()` on the client side, and `rpc_gss_svc_max_data_length()` on the server side, are useful in determining how large a piece of data can be before it is transformed by security measures and sent “over the wire.” A security transformation such as encryption usually changes the size of a piece of transmitted data, most often enlarging it. To make sure that data won’t be enlarged past a usable size, these two functions return the maximum pre-transformation size for a given transport.

For more information, see the `rpc_gss_max_data_length(3NSL)` man page.

Miscellaneous Functions

You can use several functions for getting information about the installed security system.

- `rpc_gss_get_mechanisms(3NSL)()` returns a list of installed security mechanisms.
- `rpc_gss_is_installed(3NSL)()` checks if a specified mechanism is installed.
- `rpc_gss_get_mech_info(3NSL)()` returns valid QOPs for a given mechanism.

Using these functions gives the programmer latitude in avoiding hard-coding security parameters in applications. (See Table 5–2 and the `rpcsec_gss(3NSL)` man page for a list of all `RPCSEC_GSS` functions.)

Associated Files

`RPCSEC_GSS` makes use of certain files to store information.

gsscred Table

When a server retrieves the client credentials associated with a request, the server can get either the client's principal name in the form of a `rpc_gss_principal_t` structure pointer or local UNIX credentials (UID) for that client. Services such as NFS require a local UNIX credential for access checking, but others might not. Those services can, for example, store the principal name directly in their own access control lists as a `rpc_gss_principal_t` structure.

Note – The correspondence between a client's network credential (its principal name) and any local UNIX credential is not automatic. The local security administrator must be set up explicitly.

The `gsscred` file contains both the client's UNIX and network (for example, Kerberos V5) credentials. The network credential is the Hex-ASCII representation of the `rpc_gss_principal_t` structure. The `gsscred` file is accessed through XFN. Thus, this table can be implemented over files, NIS, or NIS+, or any future name service supported by XFN. In the XFN hierarchy, this table appears as `this_org_unit/service/gsscred`. Administrators can maintain the `gsscred` table with the use of the `gsscred` utility, which enables adding and deleting of users and mechanisms.

`/etc/gss/qop` and `/etc/gss/mech`

For convenience, `RPCSEC_GSS` uses string literals for representing mechanisms and quality of protection (QOP) parameters. The underlying mechanisms themselves, however, require mechanisms to be represented as object identifiers and QOPs as 32-bit integers. Additionally, for each mechanism, you need to specify the shared library that implements the services for that mechanism.

The `/etc/gss/mech` file stores the following information on all installed mechanisms on a system: the mechanism name, in ASCII; the mechanism's OID; the shared library implementing the services provided by this mechanism; and, optionally, the kernel module implementing the service. A sample line might look like this:

```
kerberos_v5 1.2.840.113554.1.2.2 gl/mech_krb5.so gl_kmech_krb5
```

For all mechanisms installed, the `/etc/gss/qop` file stores all the QOPs supported by each mechanism, both as an ASCII string and as its corresponding 32-bit integer.

Both `/etc/gss/mech` and `/etc/gss/qop` are created when security mechanisms are first installed on a given system.

Many of the in-kernel RPC routines use non-string values to represent mechanism and QOP. Therefore, applications can use the `rpc_gss_mech_to_oid()` and `rpc_gss_qop_to_num()` functions to get the non-string equivalents for these parameters, should they need to maximize use of those in-kernel routines.

Using Port Monitors

RPC servers can be started by port monitors such as `inetd` and `listen`. Port monitors listen for requests and spawn servers in response. The forked server process is passed the file descriptor 0 on which the request has been accepted. For `inetd`, when the server is done, it can exit immediately or wait a given interval for another service request. See also Appendix F.

For `listen`, servers should exit immediately after replying because `listen()` always spawns a new process. The following function call creates a `SVCXPRT` handle to be used by the services started by port monitors.

```
transp = svc_tli_create(0, nconf, (struct t_bind *)NULL, 0, 0)
```

`nconf` is the `netconfig` structure of the transport from which the request is received.

Because the port monitors have already registered the service with `rpcbind`, the service does not need to register with `rpcbind`. The service must call `svc_reg()` to register the service procedure.

```
svc_reg(transp, PROGNUM, VERSNUM, dispatch, (struct netconfig *)NULL)
```

The `netconfig` structure is `NULL` to prevent `svc_reg()` from registering the service with `rpcbind`.

For connection-oriented transports, the following routine provides a lower level interface:

```
transp = svc_fd_create(0, recvsize, sendsize);
```

A 0 file descriptor is the first argument. You can set the value of `recvsize` and `sendsize` to any appropriate buffer size. A 0 for either argument causes a system default size to be chosen. Application servers that do not do any listening of their own use `svc_fd_create()`.

Using `inetd`

Entries in `/etc/inet/inetd.conf` have different formats for socket-based, TLI-based, and RPC services. The format of `inetd.conf` entries for RPC services follows.

TABLE 5-3 RPC `inetd` Services

Service	Description
<i>rpc_prog/vers</i>	The name of an RPC program followed by a / and the version number or a range of version numbers.
<i>endpoint_type</i>	One of <code>dgram</code> (for connectionless sockets), <code>stream</code> (for connection mode sockets), or <code>tli</code> (for TLI endpoints).
<i>proto</i>	May be * (for all supported transports), a net type, a net ID, or a comma separated list of net type and net ID.
<i>flags</i>	Either <code>wait</code> or <code>nowait</code> .
<i>user</i>	Must exist in the effective <code>passwd</code> database.
<i>pathname</i>	Full path name of the server daemon.
<i>args</i>	Arguments to be passed to the daemon on invocation.

For example:

```
rquotad/1 tli rpc/udp wait root /usr/lib/nfs/rquotad rquotad
```

For more information, see the `inetd.conf(4)` man page.

Using the Listener

Use `pmadm` to add RPC services:

```
pmadm -a -p pm_tag -s svctag -i id -v vers \
      -m 'nlsadmin -c command -D -R prog:vers'
```

The arguments are:

- a adds a service
- p *pm_tag* specifies a tag associated with the port monitor providing access to the service
- s *svctag* server's identifying code
- i *id* the `/etc/passwd` user name assigned to service *svctag*
- v *ver* the version number for the port monitor's database file
- m specifies the `nlsadmin` command to invoke the service. `nlsadmin` can have additional arguments. For example, to add version 1 of a remote program server named `rusersd`, a `pmadm` command would be:

```
# pmadm -a -p tcp -s rusers -i root -v 4 \
      -m 'nlsadmin -c /usr/sbin/rpc.ruserd -D -R 100002:1'
```

The command is given root permissions, installed in version 4 of the `listener` database file, and is made available over TCP transports. Because of the complexity of the arguments and options to `pmaadm`, use a command script or the menu system to add RPC services. To use the menu system, type `sysadm ports` and choose the `-port_services` option.

After adding a service, the `listener` must be re-initialized before the service is available. To do this, stop and restart the listener, as follows. `rpcbind` must be running.

```
# sacadm -k -p pmtag
# sacadm -s -p pmtag
```

For more information, such as how to set up the listener process, see the `listen(1M)`, `pmaadm(1M)`, and `sacadm(1M)` man pages. Also see “How the TCP/IP Protocols Handle Data Communications” in *System Administration Guide: IP Services*.

Multiple Server Versions

By convention, the first version number of a program, `PROG`, is named `PROGVERS_ORIG` and the most recent version is named `PROGVERS`. Program version numbers must be assigned consecutively. Leaving a gap in the program version sequence can cause the search algorithm not to find a matching program version number that is defined.

Only the owner of a program should change version numbers. Adding a version number to a program that you do not own can cause severe problems when the owner increments the version number. Sun registers version numbers and answers questions about them (`rpc@Sun.com`).

Suppose a new version of the `ruser` program returns an unsigned short rather than an int. If you name this version `RUSERSVERS_SHORT`, a server that supports both versions would do a double register. Use the same server handle for both registrations.

EXAMPLE 5-15 Server Handle for Two Versions of Single Routine

```
if (!svc_reg(transp, RUSERSPROG, RUSERSVERS_ORIG,
            nuser, nconf))
{
    fprintf(stderr, "can't register RUSER service\n");
    exit(1);
}
if (!svc_reg(transp, RUSERSPROG, RUSERSVERS_SHORT, nuser,
            nconf)) {
    fprintf(stderr, "can't register RUSER service\n");
    exit(1);
}
```

EXAMPLE 5-15 Server Handle for Two Versions of Single Routine (Continued)

```
}
```

Both versions can be performed by a single procedure, as shown in the following example.

EXAMPLE 5-16 Procedure for Two Versions of Single Routine

```
void
nuser(rqstp, transp)
    struct svc_req *rqstp;
    SVCXPRT *transp;
{
    unsigned int nusers;
    unsigned short nusers2;
    switch(rqstp->rq_proc) {
        case NULLPROC:
            if (!svc_sendreply( transp, xdr_void, 0))
                fprintf(stderr, "can't reply to RPC call\n");
            return;
        case RUSERSPROC_NUM:
            /*
             * Code here to compute the number of users
             * and assign it to the variable nusers
             */
            switch(rqstp->rq_vers) {
                case RUSERSVERS_ORIG:
                    if (! svc_sendreply( transp, xdr_u_int, &nusers))
                        fprintf(stderr, "can't reply to RPC call\n");
                    break;
                case RUSERSVERS_SHORT:
                    nusers2 = nusers;
                    if (! svc_sendreply( transp, xdr_u_short, &nusers2))
                        fprintf(stderr, "can't reply to RPC call\n");
                    break;
            }
        default:
            svcerr_noproc(transp);
            return;
    }
    return;
}
```

Multiple Client Versions

Because different hosts can run different versions of RPC servers, a client should be capable of accommodating the variations. For example, one server can run the old version of RUSERSPROG(RUSERSVERS_ORIG) while another server runs the newer version (RUSERSVERS_SHORT).

If the version on a server does not match the version number in the client creation call, `clnt_call()` fails with an `RPCPROGVERSMISMATCH` error. You can get the version numbers supported by a server and then create a client handle with the appropriate version number. Use either the routine in the following example, or `clnt_create_vers()`. See the `rpc(3NSL)` man page for more details.

EXAMPLE 5-17 RPC Versions on Client Side

```
main()
{
    enum clnt_stat status;
    u_short num_s;
    u_int num_l;
    struct rpc_err rpcerr;
    int maxvers, minvers;
    CLIENT *clnt;

    clnt = clnt_create("remote", RUSERSPROG, RUSERSVERS_SHORT,
                     "datagram_v");
    if (clnt == (CLIENT *) NULL) {
        clnt_pcreateerror("unable to create client handle");
        exit(1);
    }
    to.tv_sec = 10; /* set the time outs */
    to.tv_usec = 0;

    status = clnt_call(clnt, RUSERSPROC_NUM, xdr_void,
                      (caddr_t) NULL, xdr_u_short,
                      (caddr_t)&num_s, to);
    if (status == RPC_SUCCESS) { /* Found latest version number */
        printf("num = %d\n", num_s);
        exit(0);
    }
    if (status != RPC_PROGVERSMISMATCH) { /* Some other error */
        clnt_perror(clnt, "rusers");
        exit(1);
    }
    /* This version not supported */
    clnt_geterr(clnt, &rpcerr);
    maxvers = rpcerr.re_vers.high; /* highest version supported */
    minvers = rpcerr.re_vers.low; /* lowest version supported */

    if (RUSERSVERS_SHORT < minvers || RUSERSVERS_SHORT > maxvers)
```

EXAMPLE 5-17 RPC Versions on Client Side (Continued)

```
{
    /* doesn't meet minimum standards */
    clnt_perror(clnt, "version mismatch");
    exit(1);
}
(void) clnt_control(clnt, CLSET_VERSION, RUSERSVERS_ORIG);
status = clnt_call(clnt, RUSERSPROC_NUM, xdr_void,
(caddr_t) NULL, xdr_u_int, (caddr_t)&num_l, to);
if (status == RPC_SUCCESS)
    /* We found a version number we recognize */
    printf("num = %d\n", num_l);
else {
    clnt_perror(clnt, "rusers");
    exit(1);
}
}
```

Using Transient RPC Program Numbers

Occasionally, an application could use RPC program numbers that are generated dynamically. This technique could be used for implementing callback procedures, for example. In the callback example, a client program typically registers an RPC service using a dynamically generated, or transient, RPC program number. The program then passes this number on to a server along with a request. The server then calls back the client program using the transient RPC program number in order to supply the results.

This mechanism might be necessary if processing the client's request takes an excessive amount of time and the client cannot block, assuming it is single threaded. In this case, the server acknowledges the client's request, and calls back later with the results.

Another use of callbacks is to generate periodic reports from a server. The client makes an RPC call to start the reporting, and the server periodically calls back the client with reports using the transient RPC program number supplied by the client program.

Dynamically generated, or transient, RPC program numbers are in the transient range 0x40000000 - 0x5fffffff. The following routine creates a service based on a transient RPC program for a given transport type. The service handle and the transient RPC program number are returned. The caller supplies the service dispatch routine, the version, and the transport type.

EXAMPLE 5-18 Transient RPC Program—Server Side

```
SVCXPRT *register_transient_prog(dispatch, program, version, netid)
void (*dispatch)(); /* service dispatch routine */
rpcproc_t *program; /* returned transient RPC number */
rpcvers_t version; /* program version */
char *netid; /* transport id */
{
    SVCXPRT *transp;
    struct netconfig *nconf;
    rpcprog_t prognum;
    if ((nconf = getnetconfigent(netid)) == (struct netconfig
*)NULL)
        return ((SVCXPRT *)NULL);
    if ((transp = svc_tli_create(RPC_ANYFD, nconf,
        (struct t_bind *)NULL, 0, 0)) == (SVCXPRT *)NULL) {
        freenetconfigent(nconf);
        return ((SVCXPRT *)NULL);
    }
    prognum = 0x40000000;
    while (prognum < 0x60000000 && svc_reg(transp, prognum,
version,
                                dispatch, nconf) == 0) {
        prognum++;
    }
    freenetconfigent(nconf);
    if (prognum >= 0x60000000) {
        svc_destroy(transp);
        return ((SVCXPRT *)NULL);
    }
    *program = prognum;
    return (transp);
}
```

Porting From TS-RPC to TI-RPC

The transport-independent RPC (TI-RPC) routines provide the developer with stratified levels of access to the transport layer. The highest-level routines provide complete abstraction from the transport and provide true transport-independence. Lower levels provide access levels similar to the TI-RPC of previous releases.

This section is an informal guide to porting transport-specific RPC (TS-RPC) applications to TI-RPC. Table 6-1 shows the differences between selected routines and their counterparts. For information on porting issues concerning sockets and transport layer interface (TLI), see the *Programming Interfaces Guide*.

Porting an Application

An application based on either TCP or UDP can run in binary-compatibility mode. For some applications you only recompile and relink all source files. Such applications might use simple RPC calls and use no socket or TCP or UDP specifics.

You might need to edit code and write new code if an application depends on socket semantics or features specific to TCP or UDP. For example, the code might use the format of host addresses or rely on the Berkeley UNIX concept of privileged ports.

Applications that are dependent on the internals of the library or the socket implementation, or applications that depend on specific transport addressing, probably require more effort to port and might require substantial modification.

Benefits of Porting

Some of the benefits of porting are:

- Application transport independence means applications operate over more transports than before.
- Use of new interfaces makes your application more efficient.
- Binary compatibility is less efficient than native mode.

IPv6 Considerations for RPC

IPv6 is the successor of IPv4, the most commonly used layer 2 protocol. IPv6 is also known as IP next generation (IPng). For more information, see *System Administration Guide: IP Services*.

Both IPv4 and IPv6 are available to users. Applications choose which stack to use when using COTS (connection-oriented transport service). They can choose TCP or CLTS (connectionless transport service).

The following figure illustrates a typical RPC application running over an IPv4 or IPv6 protocol stack.

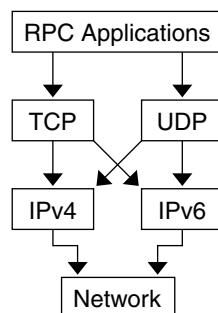

FIGURE 6-1 RPC Applications

IPv6 is supported only for TI-RPC applications. TS-RPC does not currently support IPv6. Transport selection in TI-RPC is governed either by the `NETPATH` environment variable or in `/etc/netconfig`.

The selection of TCP or UDP instead of IPv4 or IPv6 is dependent on the order in which the corresponding entries appear in `/etc/netconfig`. Two new entries are associated with IPv6 in `/etc/netconfig`, and by default they are the first two entries of the file. TI-RPC first tries IPv6. Failing that, it falls back to IPv4. Doing so requires no change in the RPC application itself provided that it doesn't have any knowledge of the transport and is written using the top-level interface.

Porting Issues

- `libnsl` library — `libc` no longer includes networking functions. `libnsl` must be explicitly specified at compile time to link the network services routines.
- Old interfaces — Many old interfaces are supported in the `libnsl` library, but they work only with TCP or UDP transports. To make full use of new transports, you must use the new interfaces.
- Name-to-address mapping — Transport independence requires opaque addressing. This requirement has implications for applications that interpret addresses.

Differences Between TI-RPC and TS-RPC

The major differences between transport-independent RPC and transport-specific RPC are illustrated in the following table. Also see “Comparison Examples” on page 149 for code examples comparing TS-RPC with TI-RPC.

TABLE 6-1 Differences Between TI-RPC and TS-RPC

Category	TI-RPC	TS-RPC
Default Transport Selection	TI-RPC uses the TLI interface.	TS-RPC uses the socket interface.
RPC Address Binding	TI-RPC uses <code>rpcbind()</code> for service binding. <code>rpcbind()</code> keeps address in universal address format.	TS-RPC uses <code>portmap</code> for service binding.

TABLE 6-1 Differences Between TI-RPC and TS-RPC (Continued)

Category	TI-RPC	TS-RPC
Transport Information	Transport information is kept in a local file, <code>/etc/netconfig</code> . Any transport identified in <code>netconfig</code> is accessible.	Only TCP and UDP transports are supported.
Loopback Transports	<code>rpcbind</code> service requires a secure loopback transport for server registration.	TS-RPC services do not require a loopback transport.
Host Name Resolution	The order of host-name resolution in TI-RPC depends on the order of dynamic libraries identified by entries in <code>/etc/netconfig</code> .	Host-name resolution is done by name services. The order is set by the state of the <code>hosts</code> database.
File Descriptors	Descriptors are assumed to be TLI endpoints.	Descriptors are assumed to be sockets.
<code>rpcgen</code>	The TI-RPC <code>rpcgen</code> tool adds support for multiple arguments, pass-by values, sample client files, and sample server files.	<code>rpcgen</code> in SunOS 4.1 and previous releases does not support the features listed for TI-RPC <code>rpcgen</code> .
Libraries	TI-RPC requires that applications be linked to the <code>libnsl</code> library.	All TS-RPC functionality is provided in <code>libc</code> .
MT Support	Multithreaded RPC clients and servers are supported.	Multithreaded RPC is not supported.

Function Compatibility Lists

This section lists the RPC library functions and groups them into functional areas. Each section includes lists of functions that are unchanged, have added functionality, and are new to this release.

Note – Functions marked with an asterisk are retained for ease of porting.

Creating and Destroying Services

The following functions are unchanged from the previous releases and are available in the current SunOS release:1

```
svc_destroy
svcfld_create
*svc_raw_create
*svc_tp_create
*svcludp_create
*svc_udp_bufcreate
svc_create
svc_dg_create
svc_fd_create
svc_raw_create
svc_tli_create
svc_tp_create
svc_vc_create
```

Registering and Unregistering Services

The following functions are unchanged from the previous releases and are available in the current SunOS release:

```
*registerrpc
*svc_register
*svc_unregister
xprt_register
xprt_unregister
rpc_reg
svc_reg
svc_unreg
```

SunOS Compatibility Calls

The following functions are unchanged from previous releases and are available in the current SunOS release:

```
*callrpc
clnt_call
*svc_getcaller - works only with IP-based transports
rpc_call
svc_getrpccaller
```

Broadcasting

The `clnt_broadcast` call has the same functionality as in previous releases, although it is supported for backward compatibility only.

`clnt_broadcast()` can broadcast only to the `portmap` service. It does not support `rpcbind`.

The `rpc_broadcast` function broadcasts to both `portmap` and `rpcbind` and is also available in the current SunOS release.

Address Management Functions

The TI-RPC library functions interface with either `portmap` or `rpcbind`. Because the services of the programs differ, there are two sets of functions, one for each service.

The following functions work with `portmap`:

```
pmap_set
pmap_unset
pmap_getport
pmap_getmaps
pmap_rmtcall
```

The following functions work with `rpcbind`:

```
rpcb_set
rpcb_unset
rpcb_getaddr
rpcb_getmaps
rpcb_rmtcall
```

Authentication Functions

The following calls have the same functionality as in previous releases. They are supported for backward compatibility only.

```
authdes_create
authunix_create
authunix_create_default
authdes_seccreate
authsys_create
authsys_create_default
```

Other Functions

`rpcbind` provides a time service, primarily for use by secure RPC client-server time synchronization, available through the `rpcb_gettime()` function.

`pmap_getport()` and `rpcb_getaddr()` can be used to get the port number of a registered service. `rpcb_getaddr()` communicates with any server running version 2, 3, or 4 of `rpcbind`. `pmap_getport()` can only communicate with version 2.

Comparison Examples

The changes in client creation from TS-RPC to TI-RPC are illustrated in Example 6–1 and Example 6–2. Each example:

- Creates a UDP descriptor
- Contacts the remote host's RPC binding process to get the service's address
- Binds the remote service's address to the descriptor
- Creates the client handle and set its timeout

EXAMPLE 6–1 Client Creation in TS-RPC

```
struct hostent *h;
struct sockaddr_in sin;
int sock = RPC_ANYSOCK;
u_short port;
struct timeval wait;

if ((h = gethostbyname( "host" )) == (struct hostent *) NULL)
{
    syslog(LOG_ERR, "gethostbyname failed");
    exit(1);
}
sin.sin_addr.s_addr = *(u_int *) hp->h_addr;
if ((port = pmap_getport(&sin, PROGRAM, VERSION, "udp")) == 0) {
    syslog (LOG_ERR, "pmap_getport failed");
    exit(1);
} else
    sin.sin_port = htons(port);
wait.tv_sec = 25;
wait.tv_usec = 0;
clntudp_create(&sin, PROGRAM, VERSION, wait, &sock);
```

The TI-RPC version of client creation, shown in the following example, assumes that the UDP transport has the netid *udp*. A netid is not necessarily a well-known name.

EXAMPLE 6–2 Client Creation in TI-RPC

```
struct netconfig *nconf;
struct netconfig *getnetconfigent();
struct t_bind *tbind;
struct timeval wait;

nconf = getnetconfigent("udp");
if (nconf == (struct netconfig *) NULL) {
    syslog(LOG_ERR, "getnetconfigent for udp failed");
    exit(1);
}
fd = t_open(nconf->nc_device, O_RDWR, (struct t_info *)NULL);
```

EXAMPLE 6-2 Client Creation in TI-RPC (Continued)

```

if (fd == -1) {
    syslog(LOG_ERR, "t_open failed");
    exit(1);
}
tbind = (struct t_bind *) t_alloc(fd, T_BIND, T_ADDR);
if (tbind == (struct t_bind *) NULL) {
    syslog(LOG_ERR, "t_bind failed");
    exit(1);
}
if (rpcb_getaddr( PROGRAM, VERSION, nconf, &tbind->addr, "host")
    == FALSE) {
    syslog(LOG_ERR, "rpcb_getaddr failed");
    exit(1);
}
cl = clnt_tli_create(fd, nconf, &tbind->addr, PROGRAM, VERSION,
                    0, 0);
(void) t_free((char *) tbind, T_BIND);
if (cl == (CLIENT *) NULL) {
    syslog(LOG_ERR, "clnt_tli_create failed");
    exit(1);
}
wait.tv_sec = 25;
wait.tv_usec = 0;
clnt_control(cl, CLSET_TIMEOUT, (char *) &wait);

```

Example 6-3 and Example 6-4 show the differences between broadcast in TS-RPC and TI-RPC. The older `clnt_broadcast()` is similar to the newer `rpc_broadcast()`. The primary difference is in the `collectnames()` function: it deletes duplicate addresses and displays the names of hosts that reply to the broadcast.

EXAMPLE 6-3 Broadcast in TS-RPC

```

statstime sw;
extern int collectnames();

clnt_broadcast(RSTATPROC, RSTATVERS_TIME, RSTATPROC_STATS,
              xdr_void, NULL, xdr_statstime, &sw, collectnames);
...
collectnames(resultsp, raddrp)
    char *resultsp;
    struct sockaddr_in *raddrp;
{
    u_int addr;
    struct entry *entryp, *lim;
    struct hostent *hp;
    extern int curentry;

    /* weed out duplicates */
    addr = raddrp->sin_addr.s_addr;
    lim = entry + curentry;
    for (entryp = entry; entryp < lim; entryp++)

```

EXAMPLE 6-3 Broadcast in TS-RPC (Continued)

```
        if (addr == entryp->addr)
            return (0);
        ...
        /* print the host's name (if possible) or address */
        hp = gethostbyaddr(&raddrp->sin_addr.s_addr, sizeof(u_int),
            AF_INET);
        if( hp == (struct hostent *) NULL)
            printf("0x%x", addr);
        else
            printf("%s", hp->h_name);
    }
```

The following code example shows broadcast in TI-RPC.

EXAMPLE 6-4 Broadcast in TI-RPC

```
statstime sw;
extern int collectnames();

rpc_broadcast(RSTATPROG, RSTATVERS_TIME, RSTATPROC_STATS,
    xdr_void, NULL, xdr_statstime, &sw, collectnames, (char *)
0);
...

collectnames(resultsp, taddr, nconf)
    char *resultsp;
    struct t_bind *taddr;
    struct netconfig *nconf;
{
    struct entry *entryp, *lim;
    struct nd_hostservlist *hs;
    extern int curentry;
    extern int netbufeq();

    /* weed out duplicates */
    lim = entry + curentry;
    for (entryp = entry; entryp < lim; entryp++)
        if (netbufeq( &taddr->addr, entryp->addr))
            return (0);
    ...
    /* print the host's name (if possible) or address */
    if (netdir_getbyaddr( nconf, &hs, &taddr->addr ) == ND_OK)
        printf("%s", hs->h_hostservs->h_host);
    else {
        char *uaddr = taddr2uaddr(nconf, &taddr->addr);
        if (uaddr) {
            printf("%s\n", uaddr);
            (void) free(uaddr);
        } else
            printf("unknown");
    }
}
```

EXAMPLE 6-4 Broadcast in TI-RPC *(Continued)*

```
netbufeq(a, b)
    struct netbuf *a, *b;
{
    return(a->len == b->len && !memcmp( a->buf, b->buf, a->len));
}
```

Multithreaded RPC Programming

This manual does not cover basic topics and code examples for the Solaris implementation of multithreaded programming. Instead, refer to the *Multithreaded Programming Guide* for background on the following topics.

- Thread creation
- Scheduling
- Synchronization
- Signals
- Process resources
- Lightweight processes (LWP)
- Concurrency
- Data-locking strategies

TI-RPC supports multithreaded RPC servers. The difference between a multithreaded server and a single-threaded server is that a multithreaded server uses threading technology to process incoming client requests concurrently. Multithreaded servers can have higher performance and availability compared with single-threaded servers.

MT Client Overview

In a multithread client program, a thread can be created to issue each RPC request. When multiple threads share the same client handle, only one thread at a time is able to make an RPC request. All other threads wait until the outstanding request is complete. On the other hand, when multiple threads make RPC requests using different client handles, the requests are carried out concurrently. Figure 4-1 illustrates a possible timing of a multithreaded client implementation consisting of two client threads using different client handles.

The following figure shows the client side implementation of a multithreaded `rstat` program. The client program creates a thread for each host. Each thread creates its own client handle and makes various RPC calls to the given host. Because the client threads are using different handles to make the RPC calls, they can carry out the RPC calls concurrently.

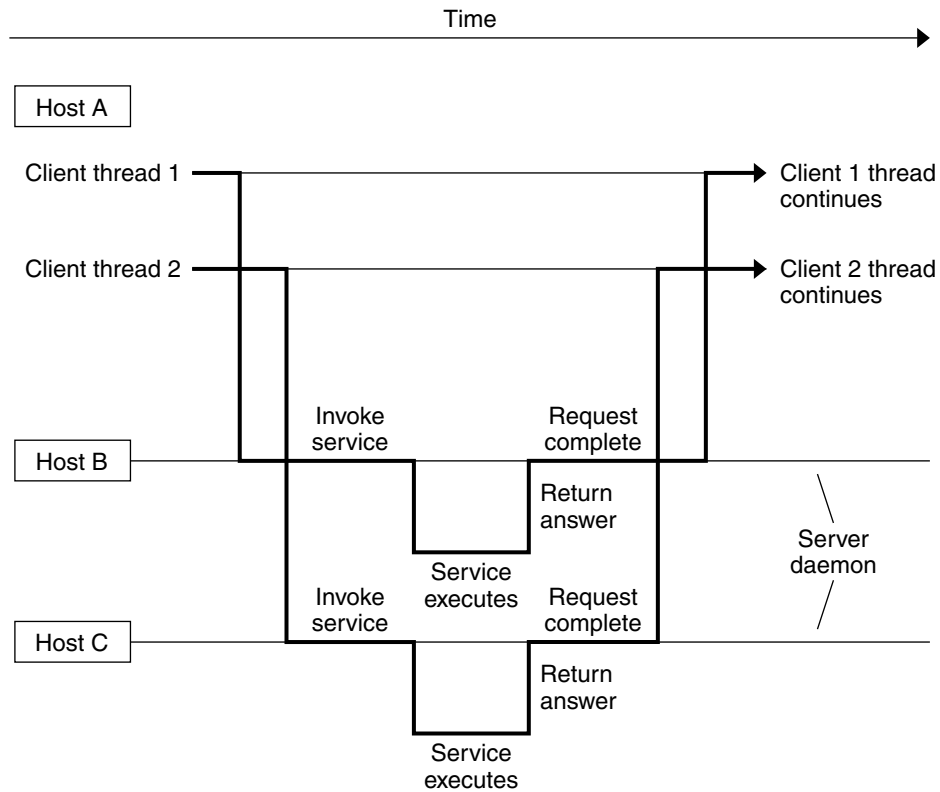

FIGURE 7-1 Two Client Threads Using Different Client Handles (Real Time)

Note – You must link in the thread library when writing any RPC multithreaded-safe application. The thread library must be the last named library on the link line. To link this properly, specify the `-lthread` option in the `compile` command.

Compile the program in the code example by typing `cc rstat.c -lnsl -lthread`.

MT Server Overview

RPC servers made available prior to the Solaris 2.4 release are single threaded. That is, they process client requests sequentially, as the requests come in. For example, say two requests come in, and the first takes 30 seconds to process, and the second takes only 1 second to process. The client that made the second request still has to wait for the first request to complete before it receives a response. This result is not desirable, especially in a multiprocessor server environment, where each CPU could be processing a different request simultaneously. Also, while one request is waiting for I/O to complete, sometimes other requests could be processed by the server.

Facilities in the RPC library for service developers can create multithreaded servers that deliver better performance to end users. Two modes of server multithreading are supported in TI-RPC: the Auto MT mode and the User MT mode.

In the Auto mode, the server automatically creates a new thread for every incoming client request. This thread processes the request, sends a response, and exits. In the User mode, the service developer decides how to create and manage threads for concurrently processing the incoming client requests. The Auto mode is much easier to use than the User mode, but the User mode offers more flexibility for service developers with special requirements.

Note – You must link in the thread library when writing RPC multithreaded-safe applications. The thread library must be the last named library on the link line. To link this properly, specify the `-lthread` option in the compile command.

The two calls that support server multithreading are `rpc_control()` and `svc_done()`. The `rpc_control()` call is used to set the MT mode, either Auto or User mode. If the server uses Auto mode, it does not need to invoke `svc_done()` at all. In User mode, `svc_done()` must be invoked after each client request is processed so that the server can reclaim the resources from processing the request. In addition, multithreaded RPC servers must call on `svc_run()`. Note that `svc_getreqpoll()` and `svc_getreqset()` are unsafe in MT applications.

If the server program does not invoke any of the MT interface calls, it remains in single-threaded mode, which is the default mode.

You are required to make RPC server procedures multithreaded safe regardless of which mode the server is using. Usually, this means that all static and global variables need to be protected with mutex locks. Mutual exclusion and other synchronization APIs are defined in `synch.h`. See the `condition(3THR)`, `rwlock(3THR)`, and `mutex(3THR)` man pages for a list of the various synchronization interfaces.

The following figure illustrates a possible timing of a server implemented in one of the MT modes of operation.

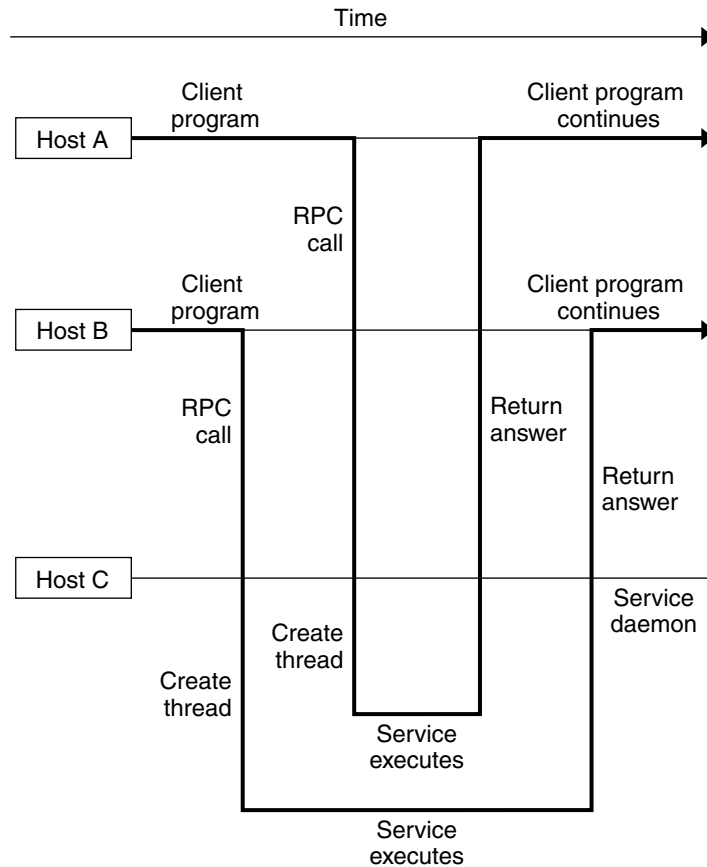

FIGURE 7-2 MT RPC Server Timing Diagram

Sharing the Service Transport Handle

The service transport handle, `SVCXPRT`, contains a single data area for decoding arguments and encoding results. Therefore, in the default, single-threaded mode, this structure cannot be freely shared between threads that call functions that perform these operations. However, when a server is operating in the MT Auto or User modes, a copy of this structure is passed to the service dispatch procedure in order to enable concurrent request processing. Under these circumstances, some routines that would otherwise be unsafe become safe. Unless otherwise noted, the server interfaces are generally MT safe. See the `rpc_svc_calls(3NSL)` man page for more details on safety for server-side interfaces.

MT Auto Mode

In the Auto mode, the RPC library creates and manages threads. The service developer invokes a new interface call, `rpc_control()`, to put the server into MT Auto mode before invoking the `svc_run()` call. In this mode, the programmer needs only to ensure that service procedures are MT safe.

`rpc_control()` enables applications to set and modify global RPC attributes. At present, this function supports only server-side operations. The following table shows the `rpc_control()` operations defined for Auto mode. See also the `rpc_control(3NSL)` man page for additional information.

TABLE 7-1 `rpc_control()` Library Routines

Routine	Description
<code>RPC_SVC_MTMODE_SET()</code>	Set multithread mode
<code>RPC_SVC_MTMODE_GET()</code>	Get multithread mode
<code>RPC_SVC_THRMAX_SET()</code>	Set maximum number of threads
<code>RPC_SVC_THRMAX_GET()</code>	Get maximum number of threads
<code>RPC_SVC_THRTOTAL_GET()</code>	Total number of threads currently active
<code>RPC_SVC_THRCREATES_GET()</code>	Cumulative total number of threads created by the RPC library
<code>RPC_SVC_THRERRORS_GET()</code>	Number of <code>thr_create()</code> errors within RPC library

Note – All of the get operations in Table 7-1, except `RPC_SVC_MTMODE_GET()`, apply only to the Auto MT mode. If used in MT User mode or the single-threaded default mode, the results of the operations might be undefined.

By default, the maximum number of threads that the RPC server library creates at any time is 16. If a server needs to process more than 16 client requests concurrently, the maximum number of threads must be set to the desired number. This parameter can be set at any time by the server. It enables the service developer to put an upper bound on the thread resources consumed by the server. Example 7-1 is an example RPC program written in MT Auto mode. In this case, the maximum number of threads is set at 20.

MT performance is enhanced if the function `svc_getargs()` is called by every procedure other than `NULLPROCS`, even if there are no arguments (you can use `xdr_void()` in this case). This is true for both the MT Auto and MT User modes. For more information on this call, see the `rpc_svc_calls(3NSL)` man page.

Note – You must link in the thread library when writing RPC multithreaded-safe applications. The thread library must be the last named library on the link line. Specify the `-pthread` option in the compile command.

The following example illustrates the server in MT Auto mode. To compile this program, type `cc time_svc.c -lnsl -pthread`.

EXAMPLE 7-1 Server for MT Auto Mode

```
#include <stdio.h>

#include <rpc/rpc.h>
#include <synch.h>

#include <thread.h>
#include "time_prot.h"

void time_prog();

main(argc, argv)
int argc;
char *argv[];
{
    int transpnum;
    char *nettype;
    int mode = RPC_SVC_MT_AUTO;
    int max = 20;      /* Set maximum number of threads to 20 */

    if (argc > 2) {
        fprintf(stderr, "usage: %s [nettype]\n", argv[0]);
        exit(1);
    }

    if (argc == 2)
        nettype = argv[1];
    else
        nettype = "netpath";

    if (!rpc_control(RPC_SVC_MTMODE_SET, &mode)) {
        printf("RPC_SVC_MTMODE_SET: failed\n");
        exit(1);
    }
    if (!rpc_control(RPC_SVC_THRMAX_SET, &max)) {
        printf("RPC_SVC_THRMAX_SET: failed\n");
        exit(1);
    }
}
```

EXAMPLE 7-1 Server for MT Auto Mode (Continued)

```
transpnum = svc_create( time_prog, TIME_PROG, TIME_VERS,
                        nettype);

if (transpnum == 0) {
    fprintf(stderr, "%s: cannot create %s service.\n",
            argv[0], nettype);
    exit(1);
}
svc_run();
}

/*
 * The server dispatch function.
 * The RPC server library creates a thread which executes
 * the server dispatcher routine time_prog(). After which
 * the RPC library destroys the thread.
 */

static void
time_prog(rqstp, transp)
    struct svc_req *rqstp;
    SVCXPRT *transp;
{
    switch (rqstp->rq_proc) {
        case NULLPROC:
            svc_sendreply(transp, xdr_void, NULL);
            return;
        case TIME_GET:
            dotime(transp);
            break;
        default:
            svcerr_noproc(transp);
            return;
    }
}

dotime(transp)
SVCXPRT *transp;
{
    struct timev rslt;
    time_t thetime;

    thetime = time((time_t *)0);
    rslt.second = thetime % 60;
    thetime /= 60;
    rslt.minute = thetime % 60;
    thetime /= 60;
    rslt.hour = thetime % 24;
    if (!svc_sendreply(transp, xdr_timev, (caddr_t) &rslt)) {
        svcerr_systemerr(transp);
    }
}
}
```

The following code example shows the `time_prot.h` header file for the server.

EXAMPLE 7-2 MT Auto Mode: `time_prot.h`

```
#include <rpc/types.h>

struct timev {
    int second;

    int minute;
    int hour;
};

typedef struct timev timev;

bool_t xdr_timev();

#define TIME_PROG 0x40000001

#define TIME_VERS 1
#define TIME_GET 1
```

MT User Mode

In MT User mode, the RPC library does not create any threads. This mode works, in principle, like the single-threaded, or default mode. The only difference is that it passes copies of data structures, such as the transport service handle to the service-dispatch routine to be MT safe.

The RPC server developer takes the responsibility for creating and managing threads through the thread library. In the dispatch routine, the service developer can assign the task of procedure execution to newly created or existing threads. The `thr_create()` API is used to create threads having various attributes. All thread library interfaces are defined in `thread.h`. See the `pthread_create(3THR)` man page for more details.

This mode provides flexibility to the service developer. Threads can now have different stack sizes based on service requirements. Threads can be bound. Different procedures can be executed by threads with different characteristics. The service developer might choose to run some services single threaded. The service developer might choose to do special thread-specific signal processing.

As in the Auto mode, you use the `rpc_control()` library call to turn on User mode. Note that the `rpc_control()` operations shown in Table 7-1, except for `RPC_SVC_MTMODE_GET()`, apply only to MT Auto mode. If used in MT User mode or the single-threaded default mode, the results of the operations can be undefined.

Freeing Library Resources in User Mode

In the MT User mode, service procedures must invoke `svc_done()` before returning. `svc_done()` frees resources allocated to service a client request directed to the specified service transport handle. This function is invoked after a client request has been serviced, or after an error or abnormal condition that prevents a reply from being sent. After `svc_done()` is invoked, the service procedure should not reference the service transport handle. The following example shows a server in MT User mode.

Note – `svc_done()` must only be called within MT User mode. For more information on this call, see the `rpc_svc_calls(3NSL)` man page.

EXAMPLE 7-3 MT User Mode: `rpc_test.h`

```
#define SVC2_PROG 0x30000002
#define SVC2_VERS 1
#define SVC2_PROC_ADD 1)
#define SVC2_PROC_MULT 2

struct intpair {
    u_short a;
    u_short b;
};

typedef struct intpair intpair;

struct svc2_add_args {
    int argument;
    SVCXPRT *transp;
};

struct svc2_mult_args {
    intpair mult_argument;
    SVCXPRT *transp;
};

extern bool_t xdr_intpair();

#define NTHREADS_CONST 500
```

The following code example is the client for MT User mode.

EXAMPLE 7-4 Client for MT User Mode

```
#define _REENTRANT
#include <stdio.h>

#include <rpc/rpc.h>
#include <sys/uio.h>
```

EXAMPLE 7-4 Client for MT User Mode (Continued)

```
#include <netconfig.h>
#include <netdb.h>

#include <rpc/nettype.h>
#include <thread.h>
#include "rpc_test.h"
void *doclient();
int NTHREADS;
struct thread_info {
    thread_t client_id;
    int client_status;
};
struct thread_info save_thread[NTHREADS_CONST];
main(argc, argv)
    int argc;
    char *argv[];
{
    int index, ret;
    int thread_status;
    thread_t departedid, client_id;
    char *hosts;
    if (argc < 3) {
        printf("Usage: do_operation [n] host\n");
        printf("\twhere n is the number of threads\n");
        exit(1);
    } else
        if (argc == 3) {
            NTHREADS = NTHREADS_CONST;
            hosts = argv[1]; /* live_host */
        } else {
            NTHREADS = atoi(argv[1]);
            hosts = argv[2];
        }
    for (index = 0; index < NTHREADS; index++){
        if (ret = thr_create(NULL, NULL, doclient,
            (void *) hosts, THR_BOUND, &client_id)){
            printf("thr_create failed: return value %d", ret);
            printf(" for %dth thread\n", index);
            exit(1);
        }
        save_thread[index].client_id = client_id;
    }
    for (index = 0; index < NTHREADS; index++){

        if (thr_join(save_thread[index].client_id, &departedid,
            (void *)
            &thread_status)){
            printf("thr_join failed for thread %d\n",
                save_thread[index].client_id);
            exit(1);
        }
        save_thread[index].client_status = thread_status;
    }
}
```

EXAMPLE 7-4 Client for MT User Mode (Continued)

```

}
void *doclient(host)
char *host;
{
    struct timeval tout;
    enum clnt_stat test;
    int result = 0;
    u_short mult_result = 0;
    int add_arg;
    int EXP_RSLT;
    intpair pair;
    CLIENT *clnt;
    if ((clnt = clnt_create(host, SVC2_PROG, SVC2_VERS, "udp"
==NULL) {
        clnt_pcreateerror("clnt_create error: ");
        thr_exit((void *) -1);
    }
    tout.tv_sec = 25;
    tout.tv_usec = 0;
    memset((char *) &result, 0, sizeof (result));

    memset((char *) &mult_result, 0, sizeof (mult_result));
    if (thr_self() % 2){
        EXP_RSLT = thr_self() + 1;
        add_arg = thr_self();
        test = clnt_call(clnt, SVC2_PROC_ADD, (xdrproc_t) xdr_int,

            (caddr_t) &add_arg, (xdrproc_t) xdr_int, (caddr_t) &result,
            tout);
    } else {
        pair.a = (u_short) thr_self();
        pair.b = (u_short) 1;
        EXP_RSLT = pair.a * pair.b;
        test = clnt_call(clnt, SVC2_PROC_MULT, (xdrproc_t)
xdr_intpair,
            (caddr_t) &pair, (xdrproc_t) xdr_u_short,

            (caddr_t) &mult_result, tout);
        result = mult_result;
    }
    if (test != RPC_SUCCESS) {
        printf("THREAD: %d clnt_call hav
        thr_exit((void *) -1);
    };
    thr_exit((void *) 0);
}

```

MT performance is enhanced if the function `svc_getargs()` is called by every procedure other than `NULLPROC`, even if there are no arguments. `xdr_void` may be used in this case. This result is true for both the MT Auto and MT User modes. For more information on this call, see the `rpc_svc_calls(3NSL)` man page.

Note – You must link in the thread library when writing RPC multithreaded-safe applications. The thread library must be the last named library on the link line. Specify the `-lthread` option in the compile command.

Extensions to the Sun RPC Library

New features have been added to the Sun RPC library which are integrated into the standard Solaris 9 product.

New and altered man pages are available to describe the functionality added to the Sun RPC library.

The additions to the Sun RPC library are described in the following sections:

- “One-Way Messaging” on page 166
- “Non-Blocking I/O” on page 171
- “Client Connection Closure Callback” on page 175
- “User File Descriptor Callbacks” on page 182

New Features

The new features added to the Sun RPC library are:

- One-way messaging - Reduces the time a client thread waits before continuing processing.
- Non-blocking I/O - Enables a client to send requests without being blocked.
- Client connection closure callback - Enables a server to detect client disconnection and to take corrective action.
- Callback user file descriptor - Extends the RPC server to handle non-RPC descriptors.

One-Way Messaging

In one-way messaging the client thread sends a request containing a message to the server. The client thread does not wait for a reply from the server and is free to continue processing when the request has been accepted by the transport layer. The request is not always sent immediately to the server by the transport layer, but waits in a queue until the transport layer sends it. The server executes the request received by processing the message contained in the request. This method saves processing time.

The following figure illustrates one-way messaging.

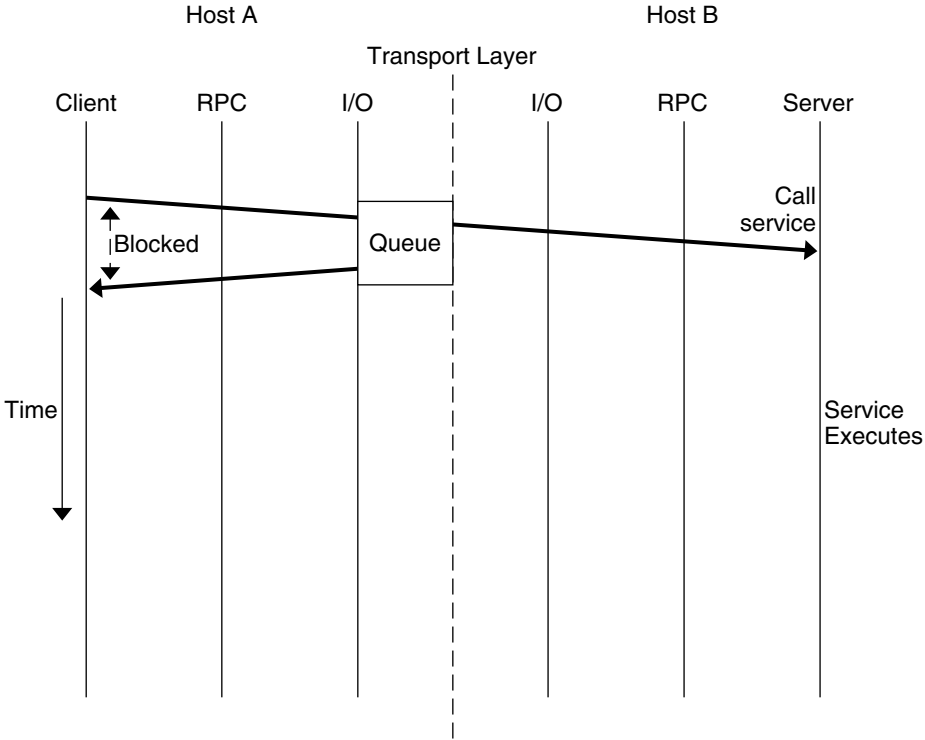

FIGURE 8-1 One-Way Messaging

In previous versions of the Sun RPC library, most requests were sent by two-way messaging. In two-way messaging, the client thread waits until it gets an answer from the server before continuing processing. If the client thread does not receive a reply

from the server within a certain period of time, a time-out occurs. This client thread cannot send a second request until the first request is executed or until a time-out occurs. This messaging method is illustrated in the following figure.

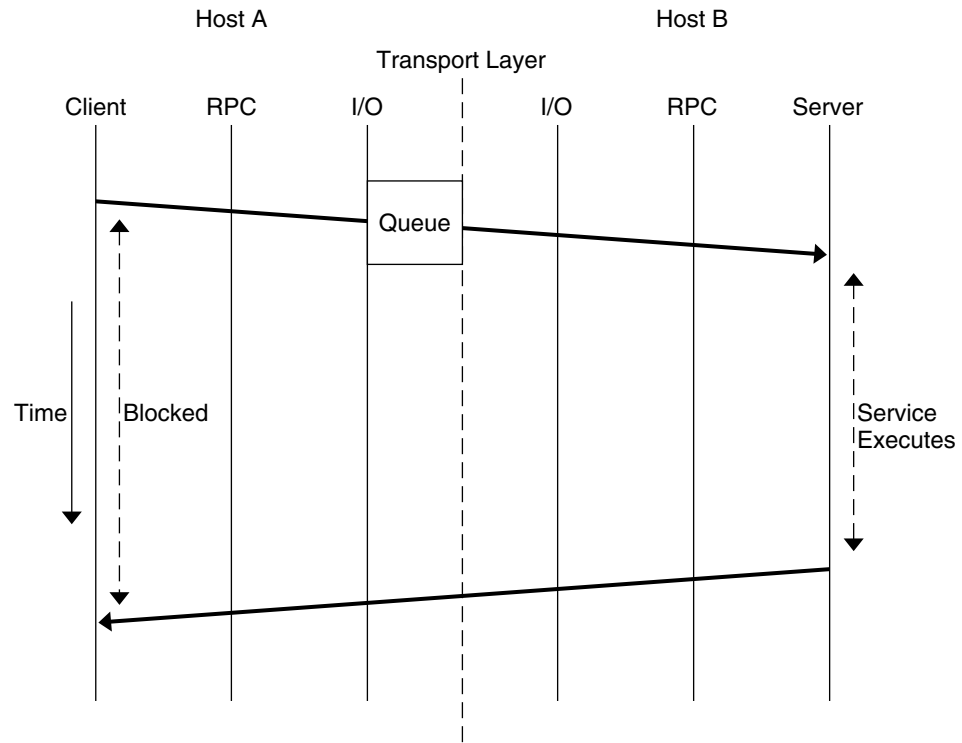

FIGURE 8-2 Two-Way Messaging

Previous versions of the Sun RPC library contain a second method of messaging called batching. In this method, client requests are held in a queue until a group of requests can be processed at the same time. This is a form of one-way messaging. See Chapter 4 for further details.

After the transport layer accepts a request, the client is not notified of failures in transmission and does not receive a receipt from the server from the request. For example, if the server refuses the request due to an authentication problem, the client is not notified of this problem. If the transport layer does not accept the request, the sending operation returns an immediate error to the client.

If you need to check whether the server is functioning correctly, you can send a two-way request to the server. Such a request can determine whether the server is still available and whether it has received the one-way requests sent by the client.

For one-way messaging, the `clnt_send()` function has been added to the Sun RPC library, and the `oneway` attribute has been added to the RPC grammar.

`clnt_send()`

In previous versions of the Sun RPC library, you used the `clnt_call()` function to send a remote procedure call. With the extended one-way messaging service, the `clnt_send()` function sends one-way remote procedure calls.

When the client calls `clnt_send()`, the client sends a request to the server and continues processing. When the request arrives at the server, the server calls a dispatch routine to process the incoming request.

Like `clnt_call()`, the `clnt_send()` function uses a client handle to access a service. See the `clnt_send(3NSL)` and `clnt_call(3NSL)` man pages for further information.

If you do not provide the correct version number to `clnt_create()`, `clnt_call()` fails. In the same circumstances, `clnt_send()` does not report the failure, as the server does not return a status.

oneway Attribute

To use one-way messaging, add the `oneway` keyword to the XDR definition of a server function. When you use the `oneway` keyword, the stubs generated by `rpcgen` use `clnt_send()`. You can either:

- Use a simplified interface as outlined in the Chapter 2. The stubs used by the simplified interface must call `clnt_send()`.
- Call the `clnt_send()` function directly, as described in the `clnt_send(3NSL)` man page.

For one-way messaging, use version 1.1 of the `rpcgen` command.

When declaring the `oneway` keyword, follow the RPC language specification using the following syntax:

```
"oneway" function-ident "(" type-ident-list ")" "=" value;
```

See Appendix B for details on RPC language specifications.

When you declare the `oneway` attribute for an operation, no result is created on the server side and no message is returned to the client.

The following information on the `oneway` attribute must be added to the RPC Language Definition Table as described in “RPC Language Specification” on page 263:

```
type-ident procedure-ident (type-ident) = value
oneway procedure-ident (type-ident) = value
```

One-way call using a simple counter service

This section describes how to use a one-way procedure on a simple counter service. In this counter service the `ADD()` function is the only function available. Each remote call sends an integer and this integer is added to a global counter managed by the server. For this service, you must declare the `oneway` attribute in the RPC language definition.

In this example, you generate stubs using the `-M`, `-N` and `-C` `rpcgen` options. These options ensure that the stubs are multithread safe, accept multiple input parameters and that generated headers are ANSI C++ compatible. Use these `rpcgen` options even if the client and server applications are mono-threaded as the semantic to pass arguments is clearer and adding threads in applications is easier since the stubs do not change.

1. First, you write the service description in the `counter.x`.

```
/* counter.x: Remote counter protocol */
program COUNTERPROG {
    version COUNTERVERS {
        oneway ADD(int) = 1;
    } = 1;
} = 0x20000001;
```

The service has a program number, (COUNTERPROG) 0x20000001, and a version number, (COUNTERVERS) 1.

2. Next, call `rpcgen` on the `counter.x` file.

```
rpcgen -M -N -C counter.x
```

This call generates the client and server stubs, `counter.h`, `counter_clnt.c` and `counter_svc.c`.

3. As shown in the `server.c` file below, write the service handler for the server side and the `counterprog_1_freeresult()` function used to free memory areas allocated to the handler. The RPC library calls this function when the server sends a reply to the client.

```
#include <stdio.h>
#include "counter.h"

int counter = 0;

bool_t
add_1_svc(int number, struct svc_req *rqstp)
{
    bool_t retval = TRUE;
```

```

        counter = counter + number;

        return retval;
    }
    int
counterprog_1_freeresult(SVCXPRT *transp, xdrproc_t xdr_result, caddr_t
                        result)
{
    (void) xdr_free(xdr_result, result);

    /*
     * Insert additional freeing code here, if needed
     */

    return TRUE;
}

```

You build the server by compiling and linking the service handler to the `counter_svc.c` stub. This stub contains information on the initialization and handling of TI-RPC.

4. Next, you write the client application, `client.c`.

```

#include <stdio.h>
#include "counter.h"

main(int argc, char *argv[])
{
    CLIENT *clnt;
    enum clnt_stat result;
    char *server;
    int number;

    if(argc !=3) {
        fprintf(stderr, "usage: %s server_name number\n", argv[0];
        exit(1);
    }
    server = argv[1];
    number = atoi(argv[2]);

    /*
     * Create client handle
     */
    clnt = clnt_create(server, COUNTERPROG, COUNTERVERS, "tcp");

    if(clnt == (CLIENT *)NULL) {
        /*
         * Couldn't establish connection
         */
        clnt_pcreateerror(server);
        exit(1);
    }

    result = add_1(number, clnt);
    if (result !=RPC_SUCCESS) {

```

```

        clnt_perror(clnt, "call failed");
    }

    clnt_destroy(clnt);
    exit(0);
}

```

The `add_1()` client function is the `counter_clnt.c` stub generated for the remote function.

To build the client, compile and link the client main and the `counter_clnt.c`.

5. To launch the server that you built, type `./server`
6. Finally, to invoke the service in another shell, type: `./client servername23`.
23 is the number being added to the global counter.

Non-Blocking I/O

Non-blocking I/O avoids the client being blocked while waiting for a request to be accepted by the transport layer during one-way messaging for connection-oriented protocols.

For connection-oriented protocols, there is a limit to the amount of data that can be put in a network protocol queue. The limit depends on the transport protocols used. When a client sending a request reaches the data limit, this client is blocked from processing until its request has entered the queue. You cannot determine how long a message will wait before being added to the queue.

In non-blocking I/O, when the transport queue is full, there is an additional buffer available between the client and the transport layer. As requests not accepted by the transport queue can be stored in this buffer, the client is not blocked. The client is free to continue processing as soon as it has put the request in the buffer. The client does not wait until the request is put in the queue and does not receive information on the status of the request after the buffer accepts the request.

By using non-blocking I/O you gain further processing time as compared to two-way and one-way messaging. The client can send requests in succession without being blocked from processing.

The following figure shows a case where you choose the non-blocking argument of the I/O mode and the transport layer queue is full.

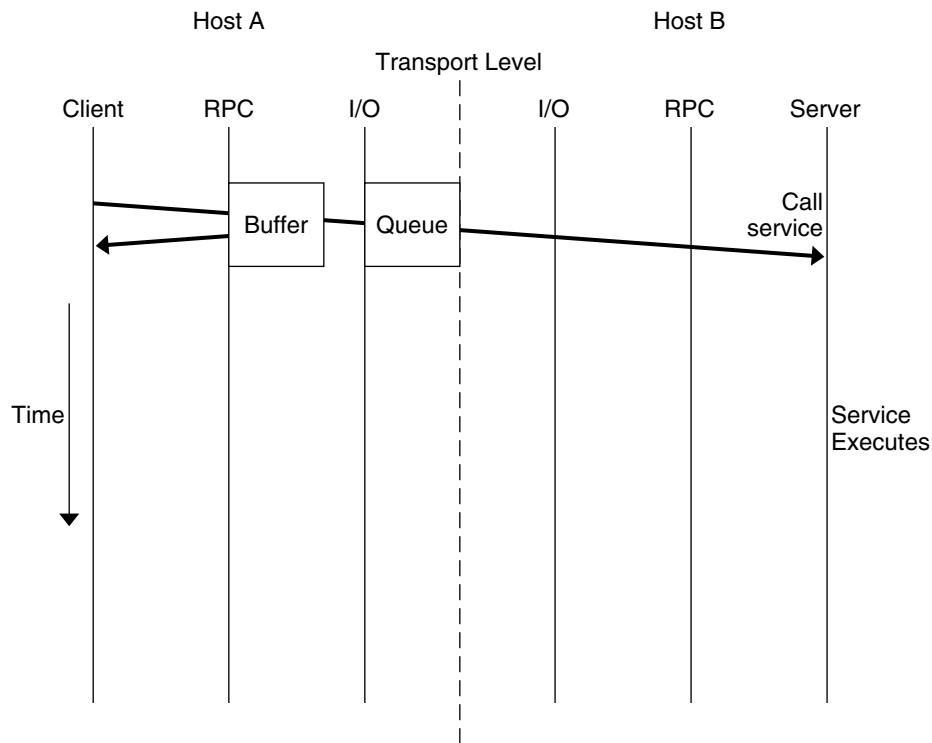

FIGURE 8-3 Non-Blocking Messaging

Using Non-Blocking I/O

To use non-blocking I/O, configure a client handle using the `CLSET_IO_MODE` `rpciomode_t*` option of the `clnt_control()` function with the `RPC_CL_NONBLOCKING` argument. See the `clnt_control(3NSL)` man page for further information.

When the transport queue is full, the buffer is used. The buffer continues to be used until two criteria are fulfilled:

- The buffer is empty
- The queue can immediately accept a request

Requests then go directly to the transport queue until the queue is full. The default size of the buffer is 16 kbytes.

Note that the buffer is not emptied automatically. You must flush the buffer when it contains data.

When you chose the `RPC_CL_NONBLOCKING` argument of `CLSET_IO_MODE`, you have a choice of flush modes. You can specify either the `RPC_CLBESTEFFORT_FLUSH` or `RPC_CL_BLOCKING_FLUSH` argument to `CLSET_FLUSH_MODE`. You can also empty the buffer by sending a synchronous call, such as `clnt_call()`. See the `clnt_control(3NSL)` man page for further information.

If the buffer is full, an `RPC_CANTSTORE` error is returned to the client and the request is not sent. The client must send the message again later. You can find out or change the size of the buffer by using the `CLSET_CONNMAXREC` and `CLGET_CONNMAXREC` commands. To determine the size of all pending request stored in the buffer, use the `CLGET_CURRENT_REC_SIZE` command. For further information on these commands see the `clnt_control(3NSL)` man page.

The server does not confirm whether the request is received or processed. After a request enters a buffer, you can use `clnt_control()` to obtain information on the status of the request.

Using a simple counter with non-blocking I/O

The `client.c` file in the one-way messaging example is modified in this section to demonstrate how to use the non-blocking I/O mode. In this new file, `client_nonblo.c`, the I/O mode is specified as non-blocking with the `RPC_CL_NONBLOCKING` argument, the flush mode is chosen to be blocking by use of the `RPC_CL_BLOCKING_FLUSH`. The I/O mode and flush mode are invoked with `CLSET_IO_MODE`. When an error occurs `RPC_CANT_STORE` is returned to the client and the program tries to flush the buffer. To choose a different method of flush consult the `clnt_control(3NSL)` man page.

```
#include <stdio.h>
#include "counter.h"

main(int argc, char *argv[])
{
    CLIENT* clnt;
    enum clnt_stat result;
    char *server;
    int number;
    bool_t bres;
    /*
     * Choose the I/O mode and flush method to be used.
     * The non-blocking I/O mode and blocking flush are
     * chosen in this example.
     */
    int mode = RPC_CL_NONBLOCKING;
    int flushMode = RPC_CL_BLOCKING_FLUSH;

    if (argc != 3) {
        fprintf(stderr, "usage: %s server_name number\n", argv[0]);
        exit(1);
    }
}
```

```

}
server = argv[1];
number = atoi(argv[2]);

clnt= clnt_create(server, COUNTERPROG, COUNTERVERS, "tcp");
if (clnt == (CLIENT*) NULL) {
    clnt_pcreateerror(server);
    exit(1);
}

/*
 * Use clnt_control to set the I/O mode.
 * The non-blocking I/O mode is
 * chosen for this example.
 */
bres = clnt_control(clnt, CLSET_IO_MODE, (char*)&mode);
if (bres)
    /*
     * Set flush mode to blocking
     */
    bres = clnt_control(clnt, CLSET_FLUSH_MODE, (char*)&flushMode);

if (!bres) {
    clnt_perror(clnt, "clnt_control");
    exit(1);
}

/*
 * Call the RPC services.
 */
result = add_1(number, clnt);

switch (result) {
case RPC_SUCCESS:
    fprintf(stdout, "Success\n");
    break;
/*
 * RPC_CANTSTORE is a new value returned to the
 * client when the buffer cannot store a request.
 */
case RPC_CANTSTORE:
    fprintf(stdout, "RPC_CANTSTORE error. Flushing ... \n");
    /*
     * The buffer is flushed using the blocking flush method
     */
    bres = clnt_control(clnt, CLFLUSH, NULL);
    if (!bres) {
        clnt_perror(clnt, "clnt_control");
    }
    break;
default:
    clnt_perror(clnt, "call failed");
    break;
}

/* Flush */

```

```

    bres = clnt_control(clnt, CLFLUSH, NULL);
    if (!bres) {
        clnt_perror(clnt, "clnt_control");
    }

    clnt_destroy(clnt);
    exit(0);
}

```

clnt_call() Configured as Non-Blocking

For a one-way message, use the `clnt_send()` function. No time-out is applied as the client sends a request to a server and does not wait for a reply.

For two-way messaging, use `clnt_call()`. The client remains blocked until the server sends a reply or an error status message, or until a time-out occurs at the client side.

The non-blocking feature enables you to send two-way and one-way calls together. If you use `clnt_call()` on the client side configured as non-blocking, that is, using the `RPC_CL_NONBLOCKING` I/O MODE, you get the following modified behavior. When a two-way request is sent to the buffer, all one-way requests already in the buffer are sent through the transport layer before the two-way request is processed. The time taken to empty the buffer is not counted in the two-way call timeout. For further information, see the `clnt_control(3NSL)` man page.

Client Connection Closure Callback

Client connection closure callback enables the server for connection-oriented transport to detect that the client has disconnected. The server can take the necessary action to recover from transport errors. Transport errors occur when a request arrives at the server, or when the server is waiting for a request and the connection is closed.

The connection closure callback is called when no requests are currently being executed on the connection. If the client connection is closed when a request is being executed, the server executes the request but a reply may not be sent to the client. The connection closure callback is called when all pending request are completed.

When a connection closure occurs, the transport layer sends an error message to the client. The handler is attached to a service using `svc_control()` for example as follows:

```

svc_control(service, SVCSET_RECVERRHANDLER, handler);

```

The arguments of `svc_control()` are:

1. A service or an instance of this service. When this argument is a service, any new connection to the service inherits the error handler. When this argument is an instance of the service, only this connection gets the error handler.
2. The error handler callback. The prototype of this callback function is:

```
void handler(const SVCXPRT *svc, const boot_t IsAConnection);
```

For further information see the `svc_control(3NSL)` man page.

Note – For XDR unmarshalling errors, if the server is unable to unmarshal a request, the message is destroyed and an error is returned directly to the client.

Example of client connection closure callback

This example implements a message log server. A client can use this server to open a log (actually a text file), to store message log, and then to close the log.

The `log.x` file describes the log program interface.

```
enum log_severity { LOG_EMERG=0, LOG_ALERT=1, LOG_CRIT=2, LOG_ERR=3,
                   LOG_WARNING=4, LOG_NOTICE=5, LOG_INFO=6 };

program LOG {
    version LOG_VERS1 {
        int OPENLOG(string ident) = 1;

        int CLOSELOG(int logID) = 2;

        oneway WRITELOG(int logID, log_severity severity,
                        string message) = 3;
    } = 1;
} = 0x20001971;
```

The two procedures `OPENLOG` and `CLOSELOG` open and close a log that is specified by its `logID`. The `WRITELOG()` procedure, declared as `oneway` for the example, logs a message in an opened log. A log message contains a severity attribute, and a text message.

This is the makefile for the log server. Use this makefile to call the `log.x` file.

```
RPCGEN = rpcgen

CLIENT = logClient
CLIENT_SRC = logClient.c log_clnt.c log_xdr.c
CLIENT_OBJ = $(CLIENT_SRC:.c=.o)

SERVER = logServer
SERVER_SRC = logServer.c log_svc.c log_xdr.c
SERVER_OBJ = $(SERVER_SRC:.c=.o)
```



```

RPCGEN_FILES = log_clnt.c log_svc.c log_xdr.c log.h

CFLAGS += -I.

RPCGEN_FLAGS = -N -C
LIBS = -lsocket -lnsl

all: log.h ./$(CLIENT) ./$(SERVER)

$(CLIENT): log.h $(CLIENT_OBJ)
        cc -o $(CLIENT) $(LIBS) $(CLIENT_OBJ)

$(SERVER): log.h $(SERVER_OBJ)
        cc -o $(SERVER) $(LIBS) $(SERVER_OBJ)

$(RPCGEN_FILES): log.x
        $(RPCGEN) $(RPCGEN_FLAGS) log.x

clean:
        rm -f $(CLIENT_OBJ) $(SERVER_OBJ) $(RPCGEN_FILES)

```

logServer.c shows the implementation of the log server. As the log server opens a file to store the log messages, it registers a closure connection callback in `openlog_1_svc()`. This callback is used to close the file descriptor even if the client program forgets to call the `close_log()` procedure (or crashes before doing so). This example demonstrates the use of the connection closure callback feature to free up resources associated to a client in an RPC server.

```

#include "log.h"
#include <stdio.h>
#include <string.h>

#define NR_LOGS 3

typedef struct {
    SVCXPRT* handle;
    FILE* filp;
    char* ident;
} logreg_t;

static logreg_t logreg[NR_LOGS];
static char* severityname[] = {"Emergency", "Alert", "Critical", "Error",
                               "Warning", "Notice", "Information"};

static void
close_handler(const SVCXPRT* handle, const bool_t);

static int
get_slot(SVCXPRT* handle)
{

```

```

    int i;

    for (i = 0; i < NR_LOGS; ++i) {
        if (handle == logreg[i].handle) return i;
    }
    return -1;
}

static FILE*
__openlog(char* logname)
/*
 * Open a log file
 */
{
    FILE* filp = fopen(logname, "a");
    time_t t;

    if (NULL == filp) return NULL;

    time(&t);
    fprintf(filp, "Log opened at %s\n", ctime(&t));

    return filp;
}

static void
__closelog(FILE* filp)
{
    time_t t;

    time(&t);
    fprintf(filp, "Log close at %s\n", ctime(&t));
    /*
     * Close a log file
     */
    fclose(filp);
}

int*
openlog_1_svc(char* ident, struct svc_req* req)
{
    int slot = get_slot(NULL);
    FILE* filp;
    static int res;
    time_t t;

    if (-1 != slot) {
        FILE* filp = __openlog(ident);
        if (NULL != filp) {
            logreg[slot].filp = filp;
            logreg[slot].handle = req->rq_xprt;
            logreg[slot].ident = strdup(ident);

            /*
             * When the client calls clnt_destroy, or when the

```

```

    * client dies and clnt_destroy is called automatically,
    * the server executes the close_handler callback
    */
        if (!svc_control(req->rq_xprt, SVCSET_RECVERRHANDLER,
                        (void*)close_handler)) {
            puts("Server: Cannot register a connection closure callback");
            exit(1);
        }
    }

}
res = slot;
return &res;
}

int*
close_log_1_svc(int logid, struct svc_req* req)
{
    static int res;

    if ((logid >= NR_LOGS) || (logreg[logid].handle != req->rq_xprt)) {
        res = -1;
        return &res;
    }
    logreg[logid].handle = NULL;
    _close_log(logreg[logid].filp);
    res = 0;
    return &res;
}

/*
 * When there is a request to write a message to the log,
 * write_log_1_svc is called
 */
void*
write_log_1_svc(int logid, log_severity severity, char* message,
                struct svc_req* req)
{
    if ((logid >= NR_LOGS) || (logreg[logid].handle != req->rq_xprt)) {
        return NULL;
    }
    /*
     * Write message to file
     */
    fprintf(logreg[logid].filp, "%s (%s): %s\n",
            logreg[logid].ident, severityname[severity], message);
    return NULL;
}

static void
close_handler(const SVCXPRT* handle, const bool_t dummy)
{
    int i;

    /*

```

```

        * When the client dies, the log is closed with closelog
        */
for (i = 0; i < NR_LOGS; ++i) {
    if (handle == logreg[i].handle) {
        logreg[i].handle = NULL;
        _closelog(logreg[i].filp);
    }
}
}

```

The logClient.c file shows a client using the log server.

```

#include "log.h"
#include <stdio.h>

#define MSG_SIZE 128

void
usage()
{
    puts("Usage: logClient <logserver_addr>");
    exit(2);
}

void
runClient(CLIENT* clnt)
{
    char msg[MSG_SIZE];
    int logID;
    int* result;

    /*
     * client opens a log
     */
    result = openlog_1("client", clnt);
    if (NULL == result) {
        clnt_perror(clnt, "openlog");
        return;
    }
    logID = *result;
    if (-1 == logID) {
        puts("Cannot open the log.");
        return;
    }

    while(1) {
        struct rpc_err e;

        /*
         * Client writes a message in the log
         */
        puts("Enter a message in the log (\".\" to quit):");
        fgets(msg, MSG_SIZE, stdin);
        /*
         * Remove trailing CR

```

```

        */
        msg[strlen(msg)-1] = 0;

        if (!strcmp(msg, ".")) break;

        if (writelog_1(logID, LOG_INFO, msg, clnt) == NULL) {
            clnt_perror(clnt, "writelog");
            return;
        }
    }
    /*
     * Client closes the log
     */
    result = closelog_1(logID, clnt);
    if (NULL == result) {
        clnt_perror(clnt, "closelog");
        return;
    }
    logID = *result;
    if (-1 == logID) {
        puts("Cannot close the log.");
        return;
    }
}

int
main(int argc, char* argv[])
{
    char* serv_addr;
    CLIENT* clnt;

    if (argc != 2) usage();

    serv_addr = argv[1];

    clnt = clnt_create(serv_addr, LOG, LOG_VERS1, "tcp");

    if (NULL == clnt) {
        clnt_pcreateerror("Cannot connect to log server");
        exit(1);
    }
    runClient(clnt);

    clnt_destroy(clnt);
}

```

User File Descriptor Callbacks

User file descriptor callbacks enable you to register file descriptors with callbacks, specifying one or more event types. Now you can use an RPC server to handle file descriptors that were not written for the Sun RPC library.

With previous versions of the Sun RPC library, you could use a server to receive both RPC calls and non-RPC file descriptors only if you wrote your own server loop, or used a separate thread to contact the socket API.

For user file descriptor callbacks, two new functions have been added to the Sun RPC library, `svc_add_input(3NSL)` and `svc_remove_input(3NSL)`, to implement user file descriptor callbacks. These functions declare or remove a callback on a file descriptor.

When using this new callback feature you must:

- Create your `callback()` function by writing user code with the following syntax:

```
typedef void (*svc_callback_t) (svc_input_id_t id, int fd, \
                                unsigned int revents, void* cookie);
```

The four parameters passed to the `callback()` function are:

- id* Provides an identifier for each callback. This identifier can be used to remove a callback.
- fd* The file descriptor that your callback is waiting for.
- revents* An unsigned integer representing the events that have occurred. This set of events is a subset of the list given when the callback is registered.
- cookie* The cookie given when the callback is registered. This cookie can be a pointer to specific data the server needs during the callback.

- Call `svc_add_input()` to register file descriptors and associated events, such as read or write, that the server must be aware of.

```
svc_input_id_t svc_add_input (int fd, unsigned int revents, \
                               svc_callback_t callback, void* cookie);
```

A list of the events that can be specified is given in `poll(2)`.

- Specify a file descriptor. This file descriptor can be an entity such as a socket or a file.

When one of the specified events occurs, the standard server loop calls the user code through `svc_run()` and your callback performs the required operation on the file descriptor, socket or file.

When you no longer need a particular callback, call `svc_remove_input()` with the corresponding identifier to remove the callback.

Example of User File Descriptors

This example shows you how to register a user file descriptor on an RPC server and how to provide user defined callbacks. With this example you can monitor the time of day on both the server and the client.

The makefile for this example is shown below.

```
RPCGEN = rpcgen

CLIENT = todClient
CLIENT_SRC = todClient.c timeofday_clnt.c
CLIENT_OBJ = $(CLIENT_SRC:.c=.o)

SERVER = todServer
SERVER_SRC = todServer.c timeofday_svc.c
SERVER_OBJ = $(SERVER_SRC:.c=.o)

RPCGEN_FILES = timeofday_clnt.c timeofday_svc.c timeofday.h

CFLAGS += -I.

RPCGEN_FLAGS = -N -C
LIBS = -lsocket -lnsl

all: ./$(CLIENT) ./$(SERVER)

$(CLIENT): timeofday.h $(CLIENT_OBJ)
    cc -o $(CLIENT) $(LIBS) $(CLIENT_OBJ)

$(SERVER): timeofday.h $(SERVER_OBJ)
    cc -o $(SERVER) $(LIBS) $(SERVER_OBJ)

timeofday_clnt.c: timeofday.x
    $(RPCGEN) -l $(RPCGEN_FLAGS) timeofday.x > timeofday_clnt.c

timeofday_svc.c: timeofday.x
    $(RPCGEN) -m $(RPCGEN_FLAGS) timeofday.x > timeofday_svc.c

timeofday.h: timeofday.x
    $(RPCGEN) -h $(RPCGEN_FLAGS) timeofday.x > timeofday.h

clean:
    rm -f $(CLIENT_OBJ) $(SERVER_OBJ) $(RPCGEN_FILES)
```

The `timeofday.x` file defines the RPC services offered by the server in this example. The services in this examples are `gettimeofday()` and `settimeofday()`.

```
program TIMEOFDAY {
    version VERS1 {
        int SENDTIMEOFDAY(string tod) = 1;
```

```

                                string GETTIMEOFDAY() = 2;
                                } = 1;
} = 0x20000090;

```

The `userfdServer.h` file defines the structure of messages sent on the sockets in this example.

```

#include "timeofday.h"
#define PORT_NUMBER 1971

/*
 * Structure used to store data for a connection.
 *   (user fds test).
 */
typedef struct {
    /*
     * Ids of the callback registration for this link.
     */
    svc_input_id_t in_id;
    svc_input_id_t out_id;

    /*
     * Data read from this connection.
     */
    char in_data[128];

    /*
     * Data to be written on this connection.
     */
    char out_data[128];
    char* out_ptr;
} Link;

void
socket_read_callback(svc_input_id_t id, int fd, unsigned int events,
                    void* cookie);

void
socket_write_callback(svc_input_id_t id, int fd, unsigned int events,
                     void* cookie);

void
socket_new_connection(svc_input_id_t id, int fd, unsigned int events,
                     void* cookie);

void
timeofday_1(struct svc_req *rqstp, register SVCXPRT *transp);

```

The `todClient.c` file shows how the time of day is set on the client. In this file, RPC is used with and without sockets.

```

#include "timeofday.h"

#include <stdio.h>
#include <netdb.h>

```



```

#define PORT_NUMBER 1971

    void
runClient();
    void
runSocketClient();

char* serv_addr;

    void
usage()
{
    puts("Usage: todClient [-socket] <server_addr>");
    exit(2);
}

    int
main(int argc, char* argv[])
{
    CLIENT* clnt;
    int sockClient;

    if ((argc != 2) && (argc != 3))
        usage();

    sockClient = (strcmp(argv[1], "-socket") == 0);

    /*
     * Choose to use sockets (sockClient).
     * If sockets are not available,
     * use RPC without sockets (runClient).
     */
    if (sockClient && (argc != 3))
        usage();

    serv_addr = argv[sockClient? 2:1];

    if (sockClient) {
        runSocketClient();
    } else {
        runClient();
    }

    return 0;
}
/*
 * Use RPC without sockets
 */
    void
runClient()
{
    CLIENT* clnt;
    char* pts;

```

```

char** serverTime;

time_t now;

clnt = clnt_create(serv_addr, TIMEOFDAY, VERS1, "tcp");
if (NULL == clnt) {
    clnt_pcreateerror("Cannot connect to log server");
    exit(1);
}

time(&now);
pts = ctime(&now);

printf("Send local time to server\n");

/*
 * Set the local time and send this time to the server.
 */
sendtimeofday_1(pts, clnt);

/*
 * Ask the server for the current time.
 */
serverTime = gettimeofday_1(clnt);

printf("Time received from server: %s\n", *serverTime);

clnt_destroy(clnt);
}

/*
 * Use RPC with sockets
 */
void
runSocketClient()
/*
 * Create a socket
 */
{
    int s = socket(PF_INET, SOCK_STREAM, 0);
    struct sockaddr_in sin;
    char* pts;
    char buffer[80];
    int len;

    time_t now;
    struct hostent* hent;
    unsigned long serverAddr;

    if (-1 == s) {
        perror("cannot allocate socket.");
        return;
    }
}

```

```

hent = gethostbyname(serv_addr);
if (NULL == hent) {
    if ((int)(serverAddr = inet_addr(serv_addr)) == -1) {
        puts("Bad server address");
        return;
    }
} else {
    memcpy(&serverAddr, hent->h_addr_list[0], sizeof(serverAddr));
}

sin.sin_port = htons(PORT_NUMBER);
sin.sin_family = AF_INET;
sin.sin_addr.s_addr = serverAddr;

/*
 * Connect the socket
 */
if (-1 == connect(s, (struct sockaddr*)&sin,
                 sizeof(struct sockaddr_in))) {
    perror("cannot connect the socket.");
    return;
}

time(&now);
pts = ctime(&now);

/*
 * Write a message on the socket.
 * The message is the current time of the client.
 */
puts("Send the local time to the server.");
if (-1 == write(s, pts, strlen(pts)+1)) {
    perror("Cannot write the socket");
    return;
}

/*
 * Read the message on the socket.
 * The message is the current time of the server
 */
puts("Get the local time from the server.");
len = read(s, buffer, sizeof(buffer));

if (len == -1) {
    perror("Cannot read the socket");
    return;
}
puts(buffer);

puts("Close the socket.");
close(s);
}

```

The `todServer.c` file shows the use of the `timeofday` service from the server side.

```

#include "timeofday.h"
#include "userfdServer.h"
#include <stdio.h>
#include <errno.h>
#define PORT_NUMBER 1971

int listenSocket;

/*
 * Implementation of the RPC server.
 */

int*
sendtimeofday_1_svc(char* time, struct svc_req* req)
{
    static int result = 0;

    printf("Server: Receive local time from client %s\n", time);
    return &result;
}

char **
gettimeofday_1_svc(struct svc_req* req)
{
    static char buff[80];
    char* pts;
    time_t now;
    static char* result = &(buff[0]);

    time(&now);
    strcpy(result, ctime(&now));

    return &result;
}

/*
 * Implementation of the socket server.
 */

int
create_connection_socket()
{
    struct sockaddr_in sin;
    int size = sizeof(struct sockaddr_in);
    unsigned int port;

    /*
     * Create a socket
     */
    listenSocket = socket(PF_INET, SOCK_STREAM, 0);

    if (-1 == listenSocket) {
        perror("cannot allocate socket.");
        return -1;
    }
}

```

```

    }

    sin.sin_port = htons(PORT_NUMBER);
    sin.sin_family = AF_INET;
    sin.sin_addr.s_addr = INADDR_ANY;

    if (bind(listenSocket, (struct sockaddr*)&sin, sizeof(sin)) == -1) {
        perror("cannot bind the socket.");
        close(listenSocket);
        return -1;
    }

    /*
     * The server waits for the client
     * connection to be created
     */
    if (listen(listenSocket, 1)) {
        perror("cannot listen.");
        close(listenSocket);
        listenSocket = -1;
        return -1;
    }

    /*
     * svc_add_input registers a read callback,
     * socket_new_connection, on the listening socket.
     * This callback is invoked when a new connection
     * is pending. */
    if (svc_add_input(listenSocket, POLLIN,
                     socket_new_connection, (void*) NULL) == -1) {
        puts("Cannot register callback");
        close(listenSocket);
        listenSocket = -1;
        return -1;
    }

    return 0;
}

/*
 * Define the socket_new_connection callback function
 */
void
socket_new_connection(svc_input_id_t id, int fd,
                     unsigned int events, void* cookie)
{
    Link* lnk;
    int connSocket;

    /*
     * The server is called when a connection is
     * pending on the socket. Accept this connection now.
     * The call is non-blocking.
     * Create a socket to treat the call.
     */

```

```

connSocket = accept(listenSocket, NULL, NULL);
if (-1 == connSocket) {
    perror("Server: Error: Cannot accept a connection.");
    return;
}

lnk = (Link*)malloc(sizeof(Link));
lnk->in_data[0] = 0;

/*
 * New callback created, socket_read_callback.
 */
lnk->in_id = svc_add_input(connSocket, POLLIN,
                          socket_read_callback, (void*)lnk);
}
/*
 * New callback, socket_read_callback, is defined
 */
void
socket_read_callback(svc_input_id_t id, int fd, unsigned int events,
                    void* cookie)
{
    char buffer[128];
    int len;
    Link* lnk = (Link*)cookie;

    /*
     * Read the message. This read call does not block.
     */
    len = read(fd, buffer, sizeof(buffer));

    if (len > 0) {
        /*
         * Got some data. Copy it in the buffer
         * associated with this socket connection.
         */
        strncat (lnk->in_data, buffer, len);

        /*
         * Test if we receive the complete data.
         * Otherwise, this is only a partial read.
         */
        if (buffer[len-1] == 0) {
            char* pts;
            time_t now;

            /*
             * Print the time of day you received.
             */
            printf("Server: Got time of day from the client: \n %s",
                  lnk->in_data);

            /*
             * Setup the reply data

```

```

        * (server current time of day).
        */
time(&now);
pts = ctime(&now);

strcpy(lnk->out_data, pts);
lnk->out_ptr = &(lnk->out_data[0]);

/*
 * Register a write callback (socket_write_callback)
 * that does not block when writing a reply.
 * You can use POLLOUT when you have write
 * access to the socket
 */
lnk->out_id = svc_add_input(fd, POLLOUT,
                          socket_write_callback, (void*)lnk);
}
} else if (len == 0) {
/*
 * Socket closed in peer. Closing the socket.
 */
close(fd);
} else {
/*
        * Has the socket been closed by peer?
        */
if (errno != ECONNRESET) {
/*
        * If no, this is an error.
        */
perror("Server: error in reading the socket");
printf("%d\n", errno);
}
close(fd);
}
}
}

/*
 * Define the socket_write_callback.
 * This callback is called when you have write
 * access to the socket.
 */
void
socket_write_callback(svc_input_id_t id, int fd, unsigned int events,
                    void* cookie)
{
    Link* lnk = (Link*)cookie;

    /*
     * Compute the length of remaining data to write.
     */
    int len = strlen(lnk->out_ptr)+1;

```

```

/*
 * Send the time to the client
 */
if (write(fd, lnk->out_ptr, len) == len) {
    /*
     * All data sent.
     */

    /*
     * Unregister the two callbacks. This unregistration
     * is demonstrated here as the registration is
     * removed automatically when the file descriptor
     * is closed.
     */
    svc_remove_input(lnk->in_id);
    svc_remove_input(lnk->out_id);

    /*
     * Close the socket.
     */
    close(fd);
}
}

void
main()
{
    int res;

    /*
     * Create the timeofday service and a socket
     */
    res = create_connection_socket();
    if (-1 == res) {
        puts("server: unable to create the connection socket.\n");
        exit(-1);
    }

    res = svc_create(timeofday_1, TIMEOFDAY, VERS1, "tcp");
    if (-1 == res) {
        puts("server: unable to create RPC service.\n");
        exit(-1);
    }

    /*
     * Poll the user file descriptors.
     */
    svc_run();
}

```

NIS+ Programming Guide

This chapter presents the fundamental principles of the NIS+ (pronounced “niss-plus”) applications programming interface and a detailed sample program. The NIS+ API is for programmers who need to build applications for Solaris networks. It provides the essential features for supporting enterprise-wide applications.

This chapter covers the following topics:

- “NIS+ Overview” on page 193
- “NIS+ API” on page 197
- “NIS+ Sample Program” on page 200

The NIS+ network name service addresses the requirements of client/server networks ranging in size from 10 clients supported by a few servers on a local area network to 10,000 multi-vendor clients supported by 20 to 100 specialized servers located in sites throughout the world and connected by several public networks.

NIS+ Overview

This section describes various aspects of the NIS+ network name service.

NIS+ Domains

NIS+ supports hierarchical domains, as illustrated in the following figure.

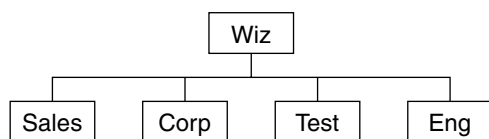

FIGURE 9-1 NIS+ Domain

A NIS+ domain is a set of data describing the workstations, users, and network services in a portion of an organization. NIS+ domains can be administered independently of each other. This independence enables NIS+ to be used in a range of networks, from small to very large.

NIS+ and Servers

Each domain is supported by a set of servers. The principal server is called the *master server*, and the backup servers are called *replicas*. Both master and replica servers run NIS+ server software. The master server stores the original tables, and the backup servers store copies.

NIS+ accepts incremental updates to the replicas. Changes are first made on the master server. Then they are automatically propagated to the replica servers and are soon available to the entire namespace.

NIS+ Tables

NIS+ stores information in tables instead of maps or zone files. NIS+ provides 16 types of predefined, or system, tables, which are shown in the following figure.

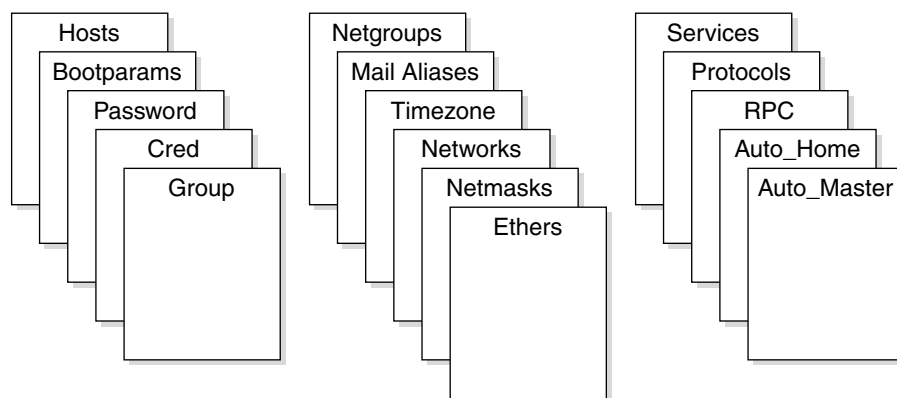

FIGURE 9-2 NIS+ Tables

Each table stores a different type of information. For instance, the Hosts table stores host name/Internet address pairs, and the Password table stores information about users of the network.

NIS+ tables have two major improvements over NIS maps. First, a NIS+ table can be accessed by any column, not just the first column, which is sometimes referred to as the “key.” This access eliminates the need for duplicate maps, such as the `hosts.byname` and `hosts.byaddr` maps of NIS. Second, access to the information in NIS+ tables can be controlled at three levels of granularity: the table level, the entry level, and the column level.

NIS+ Security

The NIS+ security model provides both authorization and authentication mechanisms. For authorization, every object in the namespace specifies the type of operation it accepts and from whom. NIS+ attempts to authenticate every requestor accessing the namespace. After it identifies the originator of the request, it determines whether the object has authorized that particular operation for that particular principal. Based on its authentication and the object’s authorization, NIS+ carries out or denies the access request.

Name Service Switch

NIS+ works in conjunction with a separate facility called the Name Service Switch. The Name Service Switch, sometimes referred to as “the Switch,” enables Solaris-based workstations to obtain their information from more than one network information service. They can get the information from local, or `/etc` files, from NIS maps, from DNS zone files, or from NIS+ tables. The Switch not only offers a choice of sources, but allows a workstation to specify different sources for different *types* of information. The name service is configured through the file `/etc/nsswitch.conf`.

NIS+ Administration Commands

NIS+ provides a full set of commands for administering a namespace, as listed in the following table.

TABLE 9-1 NIS+ Namespace Administration Commands

Command	Description
<code>nischgrp</code>	Changes the group owner of a NIS+ object.

TABLE 9-1 NIS+ Namespace Administration Commands (Continued)

Command	Description
nischmod	Changes an object's access rights.
nischown	Changes the owner of a NIS+ object.
nisgrpadm	Creates or destroys a NIS+ group, or displays a list of its members. Also adds members to a group, removes them, or tests them for membership in the group.
niscat	Displays the contents of NIS+ tables.
nisgrep	Searches for entries in a NIS+ table.
nisls	Lists the contents of a NIS+ directory.
nismatch	Searches for entries in a NIS+ table.
nisaddent	Adds information from <code>/etc</code> files or NIS maps into NIS+ tables.
nistbladm	Creates or deletes NIS+ tables, and adds, modifies, or deletes entries in a NIS+ table.
nisaddcred	Creates credentials for NIS+ principals and stores them in the Cred table.
nispasswd	Changes password information stored in the NIS+ Passwd table.
nisupdkeys	Updates the public keys stored in a NIS+ object.
nisinit	Initializes a NIS+ client or server.
nismkdir	Creates a NIS+ directory and specifies its master and replica servers.
nisrmdir	Removes NIS+ directories and replicas from the namespace.
nissetup	Creates <code>org_dir</code> and <code>groups_dir</code> directories and a complete set of (unpopulated) NIS+ tables for a NIS+ domain.
rpc.nisd	The NIS+ server process.
nis_cachemgr	Starts the NIS+ Cache Manager on a NIS+ client.
nischttl	Changes a NIS+ object's time to live value.
nisdefaults	Lists a NIS+ object's default values: domain name, group name, workstation name, NIS+ principal name, access rights, directory search path, and time-to-live.
nisln	Creates a symbolic link between two NIS+ objects.
nism	Removes NIS+ objects (except directories) from the namespace.
nisshowcache	Lists the contents of the NIS+ shared cache maintained by the NIS+ Cache Manager.

NIS+ API

The NIS+ application programming interface (API) is a group of functions that can be called by an application to access and modify NIS+ objects. The NIS+ API has 54 functions that fall into nine categories:

- Object manipulation functions (`nis_names`)
- Table access functions (`nis_tables`)
- Local name functions (`nis_local_names`)
- Group manipulation functions (`nis_groups`)
- Server related functions (`nis_server`)
- Database access functions (`nis_db`)
- Error message display functions (`nis_error`)
- Transaction log functions (`nis_admin`)
- Miscellaneous functions (`nis_subr`)

The functions in each category are summarized in the following table. The category names match the names by which they are grouped in the NIS+ man pages.

TABLE 9-2 NIS+ API Functions

Function	Description
<code>nis_names()</code>	Locates and manipulates objects.
<code>nis_lookup()</code>	Returns a copy of a NIS+ object. Can follow links. Though it cannot search for an entry object, if a link points to one, it can return an entry object.
<code>nis_add()</code>	Adds a NIS+ object to the namespace.
<code>nis_remove()</code>	Removes a NIS+ object in the namespace.
<code>nis_modify()</code>	Modifies a NIS+ object in the namespace.
<code>nis_tables</code>	Searches and updates tables.
<code>nis_list()</code>	Searches a table in the NIS+ namespace and returns entry objects that match the search criteria. Can follow links and search paths from one table to another.
<code>nis_add_entry()</code>	Adds an entry object to a NIS+ table. Can be instructed to either fail or overwrite if the entry object already exists. Can return a copy of the resulting object if the operation was successful.
<code>nis_freeresult()</code>	Frees all memory associated with a <code>nis_result</code> structure.

TABLE 9-2 NIS+ API Functions (Continued)

Function	Description
<code>nis_remove_entry()</code>	Removes one or more entry objects from a NIS+ table. Can identify the object to be removed by using search criteria or by pointing to a cached copy of the object. If using search criteria, can remove all objects that match the search criteria; therefore, with the proper search criteria, can remove all entries in a table. Can return a copy of the resulting object if the operation was successful.
<code>nis_modify_entry()</code>	Modifies one or more entry objects in a NIS+ table. Can identify the object to be modified by using search criteria or by pointing to a cached copy of the object.
<code>nis_first_entry()</code>	Returns a copy of the first entry object in a NIS+ table.
<code>nis_next_entry()</code>	Returns a copy of the “next” entry object in a NIS+ table. Because a table can be updated and entries removed or modified between calls to this function, the order of entries returned might not match the actual order of entries in the table.
<code>nis_local_names()</code>	Gets default names for the current process.
<code>nis_local_directory()</code>	Returns the name of the workstation’s NIS+ domain.
<code>nis_local_host()</code>	Returns the fully qualified name of the workstation. A fully qualified name has the form <i>host-name.domain-name</i> .
<code>nis_local_group()</code>	Returns the name of the current NIS+ group, which is specified by the environment variable NIS_GROUP.
<code>nis_local_principal()</code>	Returns the name of the NIS+ principal that has a UID associated with the calling process.
<code>nis_getnames()</code>	Returns a list of possible expansions to a particular name.
<code>nis_freenames()</code>	Frees the memory containing the list generated by <code>nis_getnames()</code> .
<code>nis_groups()</code>	Group manipulation and authorization.
<code>nis_ismember()</code>	Tests whether a principal is a member of a group.
<code>nis_addmember()</code>	Adds a member to a group. The member can be a principal, a group, or a domain.
<code>nis_removemember()</code>	Deletes a member from a group.
<code>nis_creategroup()</code>	Creates a group object.
<code>nis_destroygroup()</code>	Deletes a group object.

TABLE 9-2 NIS+ API Functions (Continued)

Function	Description
<code>nis_verifygroup()</code>	Tests whether a group object exists.
<code>nis_print_group_entry()</code>	Lists the principals that are members of a group object.
<code>nis_server</code>	Various services for NIS+ applications.
<code>nis_mkdir()</code>	Creates the databases to support service for a named directory on a specified host.
<code>nis_rmdir()</code>	Removes the directory from a host.
<code>nis_servstate()</code>	Sets and reads state variables of NIS+ servers and flushes internal caches.
<code>nis_stats()</code>	Retrieves statistics about a server's performance.
<code>nis_getservlist()</code>	Returns a list of servers that support a particular domain.
<code>nis_freeservlist()</code>	Frees the list of servers returned by <code>nis_getservlist()</code> .
<code>nis_freetags()</code>	Frees the memory associated with the results of <code>nis_servstate()</code> and <code>nis_stats()</code> .
<code>nis_db</code>	Interface between the NIS+ server and the database. Not to be used by a NIS+ client.
<code>db_first_entry()</code>	Returns a copy of the first entry of the specified table.
<code>db_next_entry()</code>	Returns a copy of the entry succeeding the specified entry.
<code>db_reset_next_entry()</code>	Terminates a first/next entry sequence.
<code>db_list_entries()</code>	Returns copies of entries that meet specified attributes.
<code>db_remove_entry()</code>	Removes all entries that meet specified attributes.
<code>db_add_entry()</code>	Replaces an entry in a table identified by specified attributes with a copy of the specified object, or adds the object to the table.
<code>db_checkpoint()</code>	Reorganizes the contents of a table to make access to the table more efficient.
<code>db_standby()</code>	Advises the database manager to release resources.
<code>nis_error()</code>	Functions that supply descriptive strings equivalent to NIS+ status values.
<code>nis_sperrno()</code>	Returns a pointer to the appropriate string constant.

TABLE 9-2 NIS+ API Functions (Continued)

Function	Description
<code>nis_perror()</code>	Displays the appropriate string constant on standard output.
<code>nis_lerror()</code>	Sends the appropriate string constant to <code>syslog</code> .
<code>nis_sperror()</code>	Returns a pointer to a statically allocated string to be used or to be copied with <code>strdup()</code> .
<code>nis_admin</code>	Transaction logging functions used by servers.
<code>nis_ping</code>	Used by the master server of a directory to timestamp it. This forces replicas of the directory to be updated.
<code>nis_checkpoint()</code>	Forces logged data to be stored in the table on disk.
<code>nis_subr</code>	Functions to help operate on NIS+ names and objects.
<code>nis_leaf_of()</code>	Returns the first label in a NIS+ name. The returned name does not have a trailing dot.
<code>nis_name_of()</code>	Removes all domain-related labels and returns only the unique object portion of the name. The name passed to the function must be either in the local domain or in one of its child domains, or the function returns NULL.
<code>nis_domain_of()</code>	Returns the name of the domain in which an object resides. The returned name ends in a dot.
<code>nis_dir_cmp()</code>	Compares any two NIS+ names. The comparison ignores case and states whether the names are the same, descendants of each other, or not related.
<code>nis_clone_object()</code>	Creates an exact duplicate of a NIS+ object.
<code>nis_destroy_object()</code>	Destroys an object created by <code>nis_clone_object()</code> .
<code>nis_print_object()</code>	Prints the contents of a NIS+ object structure to <code>stdout</code> .

NIS+ Sample Program

This sample program performs the following tasks:

- Determines the local principal and local domain
- Looks up the local directory object
- Creates a directory called `foo` under the local domain

- Creates the `groups_dir` and `org_dir` directories under domain `foo`
- Creates a group object `admins.foo`
- Adds the local principal to the `admins` group
- Creates a table under `org_dir.foo`
- Adds two entries to the `org_dir.foo` table
- Retrieves and displays the new membership list of the `admins` group
- Lists the namespace under the `foo` domain using callbacks
- Lists the contents of the table created using callbacks
- Cleans up all the objects that were created by removing the following:
 - The local principal from the `admins` group
 - The `admins` group
 - The entries in the table followed by the table
 - The `groups_dir` and `org_dir` directory objects
 - The `foo` directory object

The example program is not a typical application. In a normal situation the directories and tables would be created or removed through the command line interface, and applications would manipulate NIS+ entry objects.

Unsupported Macros

The sample program uses unsupported macros that are defined in the file `<rpcsvc/nis.h>`. These macros are not public APIs and can change or disappear in the future. They are used for illustration purposes only and if you choose to use them, you do so at your own risk. The macros used are:

- `NIS_RES_OBJECT`
- `ENTRY_VAL`
- `DEFAULT_RIGHTS`

Functions Used in the Example

The use of the following NIS+ C API functions is illustrated through this example.

<code>nis_add()</code>	<code>nis_freeresult()</code>	<code>nis_mkdir()</code>
<code>nis_add_entry()</code>	<code>nis_leaf_of()</code>	<code>nis_perror()</code>
<code>nis_addmember()</code>	<code>nis_list()</code>	<code>nis_remove()</code>
<code>nis_creategroup()</code>	<code>nis_local_directory()</code>	<code>nis_remove_entry()</code>
<code>nis_destroygroup()</code>	<code>nis_local_principal()</code>	<code>nis_removemember()</code>
<code>nis_domain_of()</code>	<code>nis_lookup()</code>	

Program Compilation

The NIS+ principal running this application has permission to create directory objects in the local domain. The program is compiled by typing:

```
% cc -o example.c example -lnsl
```

It is invoked by typing:

```
% example [dir]
```

where *dir* is the NIS+ directory in which the program creates all the NIS+ objects. Specifying no directory argument causes the objects to be created in the parent directory of the local domain. Note that for the call to `nis_lookup()`, a space and the name of the local domain are appended to the string that names the directory. The argument is the name of the NIS+ directory in which to create the NIS+ objects. The principal running this program should have create permission in the directory.

The following code example shows the routine is called by `main()` to create directory objects.

EXAMPLE 9-1 NIS+ Routine to Create Directory Objects

```
void
dir_create (dir_name, dirobj)
    nis_name      dir_name;
    nis_object    *dirobj;
{
    nis_result    *cres;
    nis_error     err;

    printf ("\n Adding Directory %s to namespace ... \n",
dir_name);
    cres = nis_add (dir_name, dirobj);

    if (cres->status != NIS_SUCCESS) {
        nis_perror (cres->status, "unable to add directory foo.");
        exit (1);
    }

    (void) nis_freeresult (cres);

    /*
     * NOTE: you need to do a nis_mkdir to create the table to
store the
     * contents of the directory you are creating.
     */
    err = nis_mkdir (dir_name,
                    dirobj->DI_data.do_servers.do_servers_val);
    if (err != NIS_SUCCESS) {
        (void) nis_remove (dir_name, 0);

        nis_perror (err,
```

EXAMPLE 9-1 NIS+ Routine to Create Directory Objects (Continued)

```
        "unable to create table for directory object foo.");
    exit (1);
}
}
```

This routine is called by `main()` to create the group object. Because `nis_creategroup()` works only on group objects, the “groups_dir” literal is not needed in the group name.

EXAMPLE 9-2 NIS+ Routine to Create Group Objects

```
void
grp_create (grp_name)
    nis_name      grp_name;
{
    nis_error      err;

    printf ("\n Adding %s group to namespace ... \n", grp_name);
    err = nis_creategroup (grp_name, 0);
    if (err != NIS_SUCCESS) {
        nis_perror (err, "unable to create group.");
        exit (1);
    }
}
```

The routine shown in the following example is called by `main()` to create a table object laid out as shown in the following table.

TABLE 9-3 NIS+ Table Objects

	Column1	Column2
Name:	id	name
Attributes:	Searchable, Text	Searchable, Text
Access Rights	---rmcdr---r---	---rmcdr---r---

The `TA_SEARCHABLE` constant indicates to the service that the column is searchable. Only `TEXT` (the default) columns are searchable. `TA_CASE` indicates to the service that the column value is to be treated in a case-insensitive manner during searches.

EXAMPLE 9-3 NIS+ Routine to Create Table Objects

```
#define      TABLE_MAXCOLS 2
#define      TABLE_COLSEP ':'
#define      TABLE_PATH 0

void
```

EXAMPLE 9-3 NIS+ Routine to Create Table Objects (Continued)

```
tbl_create (dirobj, table_name)
    nis_object      *dirobj;          /* need to use some of the fields */
    nis_name        table_name;

{
    nis_result      *cres;
    static nis_object      tblobj;
    static table_col      tbl_cols[TABLE_MAXCOLS] = {
        {"Id", TA_SEARCHABLE | TA_CASE, DEFAULT_RIGHTS},
        {"Name", TA_SEARCHABLE | TA_CASE, DEFAULT_RIGHTS}
    };

    tblobj.zo_owner = dirobj->zo_owner;
    tblobj.zo_group = dirobj->zo_group;
    tblobj.zo_access = DEFAULT_RIGHTS;      /* macro defined in nis.h */
    tblobj.zo_data.zo_type = TABLE_OBJ;    /* enumerated type in nis.h */
    tblobj.TA_data.ta_type = TABLE_TYPE;
    tblobj.TA_data.ta_maxcol = TABLE_MAXCOLS;
    tblobj.TA_data.ta_sep = TABLE_COLSEP;
    tblobj.TA_data.ta_path = TABLE_PATH;
    tblobj.TA_data.ta_cols.ta_cols_len =
        tblobj.TA_data.ta_maxcol;          /* ALWAYS ! */
    tblobj.TA_data.ta_cols.ta_cols_val = tbl_cols;

/*
 * Use a fully qualified table name i.e. the "org_dir" literal
 should

 * be embedded in the table name. This is necessary because
nis_add
 * operates on all types of NIS+ objects and needs the full path
name
 * if a table is created.
 */
    printf ("\n Creating table %s ... \n", table_name);
    cres = nis_add (table_name, &tblobj);
    if (cres->status != NIS_SUCCESS) {
        nis_perror (cres->status, "unable to add table.");
        exit (1);
    }
    (void) nis_freeresult (cres);
}
```

The routine shown in the following example is called by `main()` to add entry objects to the table object. Two entries are added to the table object. Note that the column width in both entries is set to include the NULL character for a string terminator.

EXAMPLE 9-4 NIS+ Routine to Add Objects to Table

```
#define          MAXENTRIES 2
void
stuff_table(table_name)
```

EXAMPLE 9-4 NIS+ Routine to Add Objects to Table (Continued)

```
    nis_name      table_name;
{
    int          i;
    nis_object   entdata;
    nis_result   *cres;
    static entry_col ent_col_data[MAXENTRIES][TABLE_MAXCOLS] = {
        {0, 2, "1", 0, 5, "John"},
        {0, 2, "2", 0, 5, "Mary"}
    };

    printf ("\n Adding entries to table ... \n");

    /*
     * Look up the table object first since the entries being added
     * should have the same owner, group owner and access rights as
     * the table they go in.
     */
    cres = nis_lookup (table_name, 0);

    if (cres->status != NIS_SUCCESS) {
        nis_perror (cres->status, "Unable to lookup table");
        exit(1);
    }
    entdata.zo_owner = NIS_RES_OBJECT (cres)->zo_owner;
    entdata.zo_group = NIS_RES_OBJECT (cres)->zo_group;
    entdata.zo_access = NIS_RES_OBJECT (cres)->zo_access;

    /* Free cres, so that it can be reused. */
    (void) nis_freeresult (cres);

    entdata.zo_data.zo_type = ENTRY_OBJ; /* enumerated type in
nis.h */
    entdata.EN_data.en_type = TABLE_TYPE;
    entdata.EN_data.en_cols.en_cols_len = TABLE_MAXCOLS;
    for (i = 0; i < MAXENTRIES; ++i) {
        entdata.EN_data.en_cols.en_cols_val = &ent_col_data[i][0];
        cres = nis_add_entry (table_name, &entdata, 0);

        if (cres->status != NIS_SUCCESS) {
            nis_perror (cres->status, "unable to add entry.");
            exit (1);
        }
        (void) nis_freeresult (cres);
    }
}
```

The routine shown in the following example is the print function for the `nis_list()` call. When `list_objs()` calls `nis_list()`, a pointer to `print_info()` is one of the calling arguments. Each time the service calls this function, it prints the contents of the entry object. The return value indicates to the library to call with the next entry from the table.

EXAMPLE 9-5 NIS+ Routine for nis_list Call

```

int
print_info (name, entry, cbdata)
    nis_name      name;          /* Unused */
    nis_object    *entry;        /* The NIS+ entry object */
    void          *cbdata;       /* Unused */
{
    static u_int      firsttime = 1;
    entry_col        *tmp;        /* only to make source more readable */
    u_int            i, terminal;

    if (firsttime) {
        printf ("\tId.\t\t\tName\n");
        printf ("\t--\t\t\t---\n");
        firsttime = 0;
    }
    for (i = 0; i < entry->EN_data.en_cols.en_cols_len; ++i) {
        tmp = &entry->EN_data.en_cols.en_cols_val[i];
        terminal = tmp->ec_value.ec_value_len;
        tmp->ec_value.ec_value_val[terminal] = '\0';
    }

    /*
     * ENTRY_VAL is a macro that returns the value of a specific
     * column value of a specified entry.
     */
    printf ("\t%s\t\t\t%s\n", ENTRY_VAL (entry, 0),
            ENTRY_VAL (entry, 1));
    return (0); /* always ask for more */
}

```

The routine shown in the following example is called by main() to list the contents of the group, table, and directory objects. The routine demonstrates the use of callbacks also. It retrieves and displays the membership of the group. The group membership list is not stored as the contents of the object. So, the list is queried through the nis_lookup() instead of the nis_list() call. You must use the "groups_dir" form of the group because nis_lookup() works on all types of NIS+ objects.

EXAMPLE 9-6 NIS+ Routine to List Objects

```

void
list_objs(dir_name, table_name, grp_name)
    nis_name      dir_name, table_name, grp_name;
{
    group_obj      *tmp;          /* only to make source more readable */
    u_int          i;
    char           grp_obj_name [NIS_MAXNAMELEN];
    nis_result      *cres;
    char           index_name [BUFFER_SIZE];

    sprintf (grp_obj_name, "%s.groups_dir.%s",
            nis_leaf_of (grp_name), nis_domain_of (grp_name));
    printf ("\nGroup %s membership is: \n", grp_name);
}

```

EXAMPLE 9-6 NIS+ Routine to List Objects *(Continued)*

```
    cres = nis_lookup(grp_obj_name, 0);

    if (cres->status != NIS_SUCCESS) {
        nis_perror (cres->status, "Unable to lookup group object.");
        exit(1);
    }

    tmp = &(NIS_RES_OBJECT(cres)->GR_data);
    for (i = 0; i < tmp->gr_members.gr_members_len; ++i)
        printf ("\t %s\n", tmp->gr_members.gr_members_val[i]);
    (void) nis_freeresult (cres);

    /*
     * Display the contents of the foo domain without using
     callbacks.
     */
    printf ("\nContents of Directory %s are: \n", dir_name);
    cres = nis_list (dir_name, 0, 0, 0);
    if (cres->status != NIS_SUCCESS) {
        nis_perror (cres->status,
                    "Unable to list Contents of
Directory foo.");
        exit(1);
    }
    for (i = 0; i < NIS_RES_NUMOBJ(cres); ++i)
        printf ("\t%s\n", NIS_RES_OBJECT(cres)[i].zo_name);
    (void) nis_freeresult (cres);

    /*
     * List the contents of the table we created using the callback
     form
     * of nis_list().
     */
    printf ("\n Contents of Table %s are: \n", table_name);
    cres = nis_list (table_name, 0, print_info, 0);
    if(cres->status != NIS_CBRESULTS && cres->status !=
NIS_NOTFOUND){
        nis_perror (cres->status,
                    "Listing entries using callback failed");
        exit(1);
    }
    (void) nis_freeresult (cres);

    /*

     * List only one entry from the table we created. Use
     * indexed names to do this retrieval.
     */

    printf("\n Entry corresponding to id 1 is:\n");
    /*
     * The name of the column is usually extracted from the table
```

EXAMPLE 9-6 NIS+ Routine to List Objects (Continued)

```
    * object, which would have to be retrieved first.
    */
    sprintf(index_name, "[Id=1],%s", table_name);
    cres = nis_list (index_name, 0, print_info, 0);
    if (cres->status != NIS_CBRESULTS && cres->status !=
NIS_NOTFOUND) {
        nis_perror (cres->status,
            "Listing entry using indexed names and callback failed");
        exit(1);
    }
    (void) nis_freeresult (cres);
}
```

The routine in the following table is called by `cleanup()` to remove a directory object from the namespace. The routine also informs the servers serving the directory about this deletion. Note that the memory containing result structure, pointed to by `cres`, must be freed after the result has been tested.

EXAMPLE 9-7 NIS+ Routine to Remove Directory Objects

```
void
dir_remove(dir_name, srv_list, numservers)
    nis_name      dir_name;
    nis_server    *srv_list;
    u_int         numservers;
{
    nis_result    *cres;
    nis_error     err;
    u_int         i;

    printf ("\nRemoving %s directory object from namespace ...
\n",
            dir_name);
    cres = nis_remove (dir_name, 0);
    if (cres->status != NIS_SUCCESS) {
        nis_perror (cres->status, "unable to remove directory");
        exit (1);
    }
    (void) nis_freeresult (cres);

    for (i = 0; i < numservers; ++i) {
        err = nis_rmdir (dir_name, &srv_list[i]);
        if (err != NIS_SUCCESS) {
            nis_perror (err,
                "unable to remove server from directory");
            exit (1);
        }
    }
}
```

The following routine is called by `main()` to delete all the objects that were created in this example. Note the use of the `REM_MULTIPLE` flag in the call to `nis_remove_entry()`. You must delete all entries from a table before the table itself can be deleted.

EXAMPLE 9-8 NIS+ Routine to Remove All Objects

```
void
cleanup(local_princip, grp_name, table_name, dir_name, dirobj)
    nis_name          local_princip, grp_name, table_name, dir_name;
    nis_object        *dirobj;
{
    char          grp_dir_name [NIS_MAXNAMELEN];
    char          org_dir_name [NIS_MAXNAMELEN];
    nis_error      err;
    nis_result     *cres;

    sprintf(grp_dir_name, "%s.%s", "groups_dir", dir_name);
    sprintf(org_dir_name, "%s.%s", "org_dir", dir_name);

    printf("\n\nStarting to Clean up ... \n");
    printf("\n\nRemoving principal %s from group %s \n",
           local_princip, grp_name);
    err = nis_removalmember (local_princip, grp_name);

    if (err != NIS_SUCCESS) {
        nis_perror (err,
                   "unable to delete local principal from group.");
        exit (1);
    }

    /*
     * Delete the admins group. We do not use the "groups_dir" form
     * of the group name since this API is applicable to groups
only.
     * It automatically embeds the groups_dir literal in the name
of
     * the group.
     */
    printf("\n\nRemoving %s group from namespace ... \n",
           grp_name);
    err = nis_destroygroup (grp_name);
    if (err != NIS_SUCCESS) {
        nis_perror (err, "unable to delete group.");
        exit (1);
    }

    printf("\n\nDeleting all entries from table %s ... \n",
           table_name);

    cres = nis_remove_entry(table_name, 0, REM_MULTIPLE);
    switch (cres->status) {
        case NIS_SUCCESS:
        case NIS_NOTFOUND:
```

EXAMPLE 9-8 NIS+ Routine to Remove All Objects (Continued)

```
        break;
    default:
        nis_perror(cres->status, "Could not delete entries from
                               table");
        exit(1);
    }
    (void) nis_freeresult (cres);

    printf("\n Deleting table %s itself ... \n", table_name);
    cres = nis_remove(table_name, 0);

    if (cres->status != NIS_SUCCESS) {
        nis_perror(cres->status, "Could not delete table.");
        exit(1);
    }
    (void) nis_freeresult (cres);

    /* delete the groups_dir, org_dir and foo directory objects.
    */

    dir_remove (grp_dir_name,
                dirobj->DI_data.do_servers.do_servers_val,
                dirobj->DI_data.do_servers.do_servers_len);
    dir_remove (org_dir_name,
                dirobj->DI_data.do_servers.do_servers_val,
                dirobj->DI_data.do_servers.do_servers_len);
    dir_remove (dir_name, dirobj-
>DI_data.do_servers.do_servers_val,
                dirobj->DI_data.do_servers.do_servers_len);
}
```

Running the program displays on the screen, as shown in the following code example.

EXAMPLE 9-9 NIS+ Program Execution

```
myhost% domainname
sun.com
myhost% ./sample
Adding Directory foo.sun.com. to namespace ...
Adding Directory groups_dir.foo.sun.com. to namespace ...
Adding Directory org_dir.foo.sun.com. to namespace ...
Adding admins.foo.sun.com. group to namespace ...
Adding principal myhost.sun.com. to group admins.foo.sun.com. ...
Creating table test_table.org_dir.foo.sun.com. ...
Adding entries to table ...
Group admins.foo.sun.com. membership is:
    myhost.sun.com.
Contents of Directory foo.sun.com. are:
    groups_dir
    org_dir

Contents of Table test_table.org_dir.foo.sun.com. are:
```

EXAMPLE 9-9 NIS+ Program Execution (Continued)

```

      Id.                Name
      ---                ----
      1                  John
      2                  Mary

Entry corresponding to id 1 is:
      1                  John

Starting to Clean up ...

Removing principal myhost.sun.com. from group admins.foo.sun.com.
Removing admins.foo.sun.com. group from namespace ...
Deleting all entries from table test_table.org_dir.foo.sun.com. ...
Deleting table test_table.org_dir.foo.sun.com. itself ...
Removing groups_dir.foo.sun.com. directory object from namespace ...
Removing org_dir.foo.sun.com. directory object from namespace ...
Removing foo.sun.com. directory object from namespace ...
myhost%
```

As a debugging aid, the same operations are performed by the following command sequence. The first command displays the name of the master server.

Substitute the master server name where the variable *master* appears in the following.

```
% niscat -o `domainname`

% nismkdir -m master foo.`domainname`.

# Create the org_dir.foo subdirectory with the specified master
% nismkdir -m master org_dir.foo.`domainname`.
# Create the groups_dir.foo subdirectory with the specified master
% nismkdir -m master groups_dir.foo.`domainname`.
# Create the "admins" group
% nisgrpadm -c admins.foo.`domainname`.

# Add yourself as a member of this group
% nisgrpadm -a admins.foo.`domainname`. `nisdefaults -p`

# Create a test_table with two columns : Id and Name
% nistbladm -c test_data id=SI Name=SI \
test_table.org_dir.foo.`domainname`

# Add one entry to that table.
% nistbladm -a id=1 Name=John test_table.org_dir.foo.`domainname`.
# Add another entry to that table.
% nistbladm -a id=2 Name=Mary test_table.org_dir.foo.`domainname`.

# List the members of the group admins
% nisgrpadm -l admins.foo.`domainname`.
# List the contents of the foo directory
% nisls foo.`domainname`.
# List the contents of the test_table along with its header
```

```
% niscat -h test_table.org_dir.foo.'domainname'.

# Get the entry from the test_table where id = 1
% nismatch id=1 test_table.org_dir.foo.'domainname'.

# Delete all we created.
# First, delete yourself from the admins group
% nisgrpadm -r admins.foo.'domainname'. 'nisdefaults -p'
# Delete the admins group
% nisgrpadm -d admins.foo.'domainname'.
# Delete all the entries from the test_table
% nistbladm -r "[],test_table.org_dir.foo.'domainname'."
# Delete the test_table itself.
% nistbladm -d test_table.org_dir.foo.'domainname'.
# Delete all three directories that we created
% nisrmdir groups_dir.foo.'domainname'.
% nisrmdir org_dir.foo.'domainname'.
% nisrmdir foo.'domainname'.
```

XDR Technical Note

This appendix is a technical note on the Sun Microsystems implementation of the external data representation (XDR) standard, which is a set of library routines that enable C programmers to describe arbitrary data structures in a machine-independent manner.

What Is XDR?

XDR is the backbone of the Sun Microsystems Remote Procedure Call package. Data for RPCs are transmitted using this standard. XDR library routines should be used to transmit data accessed (read or written) by more than one type of machine.

XDR works across different languages, operating systems, and machine architectures. Most users (particularly RPC users) only need the information in the sections on number filters, floating point filters, and enumeration filters. Programmers who want to implement RPC and XDR on new machines should read this technical note and the protocol specification.

You can use `rpcgen` to write XDR routines even in cases where no RPC calls are being made.

C programs that use XDR routines must include the file `<rpc/xdr.h>`, which contains all the necessary interfaces to the XDR system. Because the library `libns1.a` contains all the XDR routines, you compile it by typing:

```
example% cc program.c
```

In many environments, several criteria must be observed to accomplish porting. The ramifications of a small programmatic change are not always apparent, but they can often have far-reaching implications. Consider the program to read/write a line of text that is shown in the next two code examples.

EXAMPLE A-1 Writer Example (initial)

```
#include <stdio.h>

main()          /* writer.c */
{
    int i;

    for (i = 0; i < 8; i++) {
        if (fwrite((char *) &i, sizeof(i), 1, stdout) != 1) {
            fprintf(stderr, "failed!\n");
            exit(1);
        }
    }
    exit(0);
}
```

EXAMPLE A-2 Reader Example (initial)

```
#include <stdio.h>

main()          /* reader.c */
{
    int i, j;

    for (j = 0; j < 8; j++) {
        if (fread((char *) &i, sizeof(i), 1, stdin) != 1) {
            fprintf(stderr, "failed!\n");
            exit(1);
        }
        printf("%ld ", i);
    }
    printf("\n");
    exit(0);
}
```

The two programs appear to be portable because they:

- Pass lint checking
- Exhibit the same behavior when executed locally on any hardware architecture

Piping the output of the `writer` program to the `reader` program gives identical results on a SPARC or Intel machine.

```
sun% writer | reader
0 1 2 3 4 5 6 7
sun%
intel% writer | reader
0 1 2 3 4 5 6 7
intel%
```

With the advent of local area networks and 4.2BSD came the concept of “network pipes,” which is a process that produces data on one machine and a second process that consumes data on another machine. You can construct a network pipe with `writer` and `reader`. Here are the results if the `writer` produces data on a SPARC system, and the `reader` consumes data on Intel architecture.

```
sun% writer | rsh intel reader
0 16777216 33554432 50331648 67108864 83886080 100663296
117440512
sun%
```

Executing `writer` on the Intel and `reader` on the SPARC system produces identical results. These results occur because the byte ordering of data differs between the Intel and the SPARC, even though the word size is the same.

Note – 16777216 is 2^{24} . When 4 bytes are reversed, the 1 is placed in the 24th bit.

Whenever data is shared by two or more machine types, a need exists for portable data. You can make data portable by replacing the `read()` and `write()` calls with calls to an XDR library routine, `xdr_int()`, a filter that knows the standard representation of an `int` integer in its external form. The revised versions of `writer` are shown in the following code example.

EXAMPLE A-3 Writer Example (XDR modified)

```
#include <stdio.h>

#include <rpc/rpc.h> /* xdr is a sub-library of rpc */

main() /* writer.c */
{
    XDR xdrs;
    int i;

    xdrstdio_create(&xdrs, stdout, XDR_ENCODE);

    for (i = 0; i < 8; i++) {
        if (!xdr_int(&xdrs, &i)) {
            fprintf(stderr, "failed!\n");
            exit(1);
        }
    }
    exit(0);
}
```

The following code example shows the revised versions of `reader`.

EXAMPLE A-4 Reader Example (XDR modified)

```
#include <stdio.h>
```

EXAMPLE A-4 Reader Example (XDR modified) (Continued)

```
#include <rpc/rpc.h>    /* xdr is a sub-library of rpc */

main()                  /* reader.c */
{
    XDR xdrs;
    int i, j;

    xdrstdio_create(&xdrs, stdin, XDR_DECODE);

    for (j = 0; j < 8; j++) {
        if (!xdr_int(&xdrs, &i)) {
            fprintf(stderr, "failed!\n");
            exit(1);
        }
        printf("%ld ", i);
    }
    printf("\n");
    exit(0);
}
```

The new programs were executed on a SPARC system, on an Intel, and from a SPARC to an Intel. The results follow.

```
sun% writer | reader
0 1 2 3 4 5 6 7
sun%
intel% writer | reader
0 1 2 3 4 5 6 7
intel%
sun% writer | rsh intel reader
0 1 2 3 4 5 6 7
sun%
```

Note – Arbitrary data structures can create portability issues, particularly with respect to alignment and pointers. Alignment on word boundaries cause the size of a structure to vary from machine to machine. Pointers, which are very convenient to use, have no meaning outside the machine where they are defined.

Canonical Standard

The XDR approach to standardizing data representations is canonical. That is, XDR defines a single byte order, a single floating-point representation (IEEE), and so on. Any program running on any machine can use XDR to create portable data by

translating its local representation to the XDR standard representations. Similarly, any program running on any machine can read portable data by translating the XDR standard representations to its local equivalents.

The single standard completely decouples programs that create or send portable data from those that use or receive portable data. A new machine learns how to convert the standard representations and its local representations. The local representations of other machines are irrelevant. Conversely, the local representations of the new machine are also irrelevant to existing programs running on other machines. Such programs can immediately read portable data produced by the new machine because such data conforms to the canonical standards that they already understand.

Strong precedents are in place for XDR's canonical approach. For example, TCP/IP, UDP/IP, XNS, Ethernet, and, indeed, all protocols below layer five of the ISO model, are canonical protocols. The advantage of any canonical approach is simplicity. In the case of XDR, a single set of conversion routines is written once and is never touched again.

The canonical approach has the disadvantage of unnecessary conversion to and from the XDR standard when data is transferred between two machines with identical byte order. Suppose two Intel machines are transferring integers according to the XDR standard. The sending machine converts the integers from Intel host byte order to XDR byte order. The receiving machine performs the reverse conversion. Because both machines observe the same byte order, their conversions are unnecessary.

The time spent converting to and from a canonical representation is insignificant, especially in distributed applications. Most of the time required to prepare a data structure for transfer is not spent in conversion but in traversing the elements of the data structure.

To transmit a tree, for example, each leaf must be visited and each element in a leaf record must be copied to a buffer and aligned there. Storage for the leaf might have to be de-allocated as well. Similarly, to receive a tree, you must allocate storage for each leaf, move data from the buffer to the leaf and properly align it, and construct pointers to link the leaves together.

Every machine pays the cost of traversing and copying data structures whether or not conversion is required. In distributed applications, communications overhead, which is the time required to move the data down the sender's protocol layers, across the network, and up the receiver's protocol layers, dwarfs conversion overhead.

XDR Library

The XDR library solves data portability problems, and also enables you to write and read arbitrary C constructs in a consistent, specified, well-documented manner. Thus, using the library can be helpful even when the data is not shared among machines on a network.

The XDR library has filter routines for strings (null-terminated arrays of bytes), structures, unions, and arrays, to name a few. Using more primitive routines, you can write your own specific XDR routines to describe arbitrary data structures, including elements of arrays, arms of unions, or objects pointed at from other structures. The structures themselves might contain arrays of arbitrary elements, or pointers to other structures.

Look closely at Example A-3 and Example A-4. A family of XDR stream-creation routines has each member treat the stream of bits differently. In the example, data is manipulated using standard I/O routines, so you use `xdrstdio_create()`. The parameters to XDR stream-creation routines vary according to their function. In the example, `xdrstdio_create()` takes a pointer to an XDR structure that it initializes, a pointer to a `FILE` that the input or output is performed on, and the operation. The operation might be `XDR_ENCODE` for serializing in the writer program, or `XDR_DECODE` for deserializing in the reader program.

Note – RPC users never need to create XDR streams. The RPC system itself creates these streams, which are then passed to the users.

The `xdr_int()` primitive is characteristic of most XDR library primitives and all client XDR routines. First, the routine returns `FALSE` (0) if it fails, and `TRUE` (1) if it succeeds. Second, for each data type, `xxx`, there is an associated XDR routine of the form:

```
xdr_xxx(xdrs, xp)
    XDR *xdrs;
    xxx *xp;
{
}
```

In this case, `xxx` is `int`, and the corresponding XDR routine is a primitive, `xdr_int()`. The client could also define an arbitrary structure `xxx`, in which case the client would also supply the routine `xdr_xxx()`, describing each field by calling XDR routines of the appropriate type. In all cases the first parameter, `xdrs`, can be treated as an opaque handle and passed to the primitive routines.

An XDR routine is direction independent. That is, the same routine is called to serialize or deserialize data. This feature is critical to software engineering of portable data. The idea is to call the same routine for either operation. This practice almost guarantees that serialized data can also be deserialized.

This one routine is used by both producer and consumer of networked data. This concept is implemented by always passing the address of an object rather than the object itself. Only in the case of deserialization is the object modified. This feature is not shown in the example, but its value becomes obvious when nontrivial data structures are passed among machines. If needed, the user can obtain the direction of the XDR operation. For details, see the section “Operation Directions” on page 234.

A slightly more complicated example follows. Assume that a person’s gross assets and liabilities are to be exchanged among processes. Also assume that these values are important enough to warrant their own data type.

```
struct gnumbers {
    int g_assets;
    int g_liabilities;
};
```

The corresponding XDR routine describing this structure is as follows.

```
bool_t                /* TRUE is success, FALSE is failure */
xdr_gnumbers(xdrs, gp)
    XDR *xdrs;
    struct gnumbers *gp;
{
    if (xdr_int(xdrs, &gp->g_assets) &&
        xdr_int(xdrs, &gp->g_liabilities))
        return(TRUE);
    return(FALSE);
}
```

Note that the parameter *xdrs* is never inspected or modified. It is only passed on to the subcomponent routines. The routine must inspect the return value of each XDR routine call, and to halt immediately and return FALSE if the subroutine fails.

This example also shows that the type `bool_t` is declared as an integer that has only the values TRUE (1) and FALSE (0). This document uses the following definitions:

```
#define bool_t int
#define TRUE 1
#define FALSE 0
```

By observing these conventions, you can rewrite `xdr_gnumbers()` as follows:

```
xdr_gnumbers(xdrs, gp)
    XDR *xdrs;
    struct gnumbers *gp;
{
    return(xdr_int(xdrs, &gp->g_assets) &&
           xdr_int(xdrs, &gp->g_liabilities));
}
```

This document uses both coding styles.

XDR Library Primitives

This section provides a synopsis of each XDR primitive. It starts with memory allocation and the basic data types, then moves on to constructed data types. Finally, XDR utilities are discussed. The interface to these primitives and utilities is defined in the include file `<rpc/xdr.h>`, automatically included by `<rpc/rpc.h>`.

Memory Requirements for XDR Routines

When using XDR routines, you sometimes need to pre-allocate memory, or to determine memory requirements. When you need to control the allocation and de-allocation of memory for XDR conversion routines, you can use a routine, `xdr_sizeof()`. This routine returns the number of bytes needed to encode and decode data with one of the XDR filter functions (`func()`). The output of the `xdr_sizeof()` function does not include RPC headers or record markers. You must add them to get a complete accounting of the memory required. `xdr_sizeof()` returns a zero on error.

```
xdr_sizeof(xdrproc_t func, void *data)
```

Use `xdr_sizeof()` for the allocation of memory in applications that use XDR outside of the RPC environment, to select between transport protocols, and at the lower levels of RPC to perform client and server creation functions.

The next two code examples illustrate two uses of `xdr_sizeof()`.

EXAMPLE A-5 `xdr_sizeof` Example #1

```
#include <rpc/rpc.h>

/*
 * This function takes as input a CLIENT handle, an XDR function
and
 * a pointer to data to be XDR'd. It returns TRUE if the amount of
 * data to be XDR'd may be sent using the transport associated
with
 * the CLIENT handle, and false otherwise.
 */
bool_t
cansend(cl, xdrfunc, xdrdata)
    CLIENT *cl;
    xdrproc_t xdrfunc;
    void *xdrdata;
```

EXAMPLE A-5 xdr_sizeof Example #1 (Continued)

```
{
    int fd;
    struct t_info tinfo;

    if (clnt_control(cl, CLGET_FD, &fd) == -1) {
        /* handle clnt_control() error */
        return (FALSE);
    }

    if (t_getinfo(fd, &tinfo) == -1) {
        /* handle t_getinfo() error */
        return (FALSE);
    } else {
        if (tinfo.servtype == T_CLTS) {
            /*
             * This is a connectionless transport. Use xdr_sizeof()
             * to compute the size of this request to see whether it
             * is too large for this transport.
             */
            switch(tinfo.tsdu) {
                case 0: /* no concept of TSDUs */
                case -2: /* can't send normal data */
                    return (FALSE);
                    break;
                case -1: /* no limit on TSDU size */
                    return (TRUE);
                    break;
                default:
                    if (tinfo.tsdu < xdr_sizeof(xdrfunc, xdrdata))
                        return (FALSE);
                    else
                        return (TRUE);
            }
        } else
            return (TRUE);
    }
}
```

The second xdr_sizeof() example follows.

EXAMPLE A-6 xdr_sizeof Example #2

```
#include <sys/statvfs.h>

#include <sys/sysmacros.h>

/*
 * This function takes as input a file name, an XDR function, and
 * a
 * pointer to data to be XDR'd. It returns TRUE if the filesystem
 * on which the file resides has room for the additional amount
 * of
```

EXAMPLE A-6 xdr_sizeof Example #2 (Continued)

```
*   data to be XDR'd. Note that since the information statvfs(2)
*   returns about the filesystem is in blocks you must convert the
*   value returned by xdr_sizeof() from bytes to disk blocks.
*/
bool_t
canwrite(file, xdrfunc, xdrdata)
    char      *file;
    xdrproc_t xdrfunc;
    void      *xdrdata;
{
    struct statvfs s;

    if (statvfs(file, &s) == -1) {
        /* handle statvfs() error */
        return (FALSE);
    }

    if (s.f_bavail >= btod(xdr_sizeof(xdrfunc, xdrdata)))
        return (TRUE);
    else
        return (FALSE);
}
```

Number Filters

The XDR library provides primitives to translate between numbers and their corresponding external representations. Primitives cover the set of numbers in the types:

```
[signed, unsigned] * [short, int, long]
```

Specifically, the eight primitives are:

```
bool_t xdr_char(xdrs, op)
    XDR *xdrs;
    char *cp;
bool_t xdr_u_char(xdrs, ucp)
    XDR *xdrs;
    unsigned char *ucp;
bool_t xdr_int(xdrs, ip)
    XDR *xdrs;
    int *ip;
bool_t xdr_u_int(xdrs, up)
    XDR *xdrs;
    unsigned *up;
bool_t xdr_long(xdrs, lip)
    XDR *xdrs;
    long *lip;
bool_t xdr_u_long(xdrs, lup)
    XDR *xdrs;
```

```

    u_long *lup;
bool_t xdr_short(xdrs, sip)
    XDR *xdrs;
    short *sip;
bool_t xdr_u_short(xdrs, sup)
    XDR *xdrs;
    u_short *sup;

```

The first parameter, *xdrs*, is an XDR stream handle. The second parameter is the address of the number that provides data to the stream or receives data from it. All routines return `TRUE` if they complete successfully, and `FALSE` otherwise.

Floating-Point Filters

The XDR library also provides primitive routines for C floating-point types.

```

bool_t xdr_float(xdrs, fp)
    XDR *xdrs;
    float *fp;
bool_t xdr_double(xdrs, dp)
    XDR *xdrs;
    double *dp;

```

The first parameter, *xdrs*, is an XDR stream handle. The second parameter is the address of the floating-point number that provides data to the stream or receives data from it. Both routines return `TRUE` if they complete successfully, and `FALSE` otherwise.

Note – Because the numbers are represented in IEEE floating point, routines might fail when decoding a valid IEEE representation into a machine-specific representation, or the reverse.

Enumeration Filters

The XDR library provides a primitive for generic enumerations. The primitive assumes that a C enum has the same representation inside the machine as a C integer. The Boolean type is an important instance of the enum. The external representation of a Boolean is always `TRUE` (1) or `FALSE` (0).

```

#define bool_t int
#define FALSE 0
#define TRUE 1
#define enum_t int
bool_t xdr_enum(xdrs, ep)
    XDR *xdrs;
    enum_t *ep;
bool_t xdr_bool(xdrs, bp)

```

```
XDR *xdrs;  
bool_t *bp;
```

The second parameters *ep* and *bp* are addresses of the associated type that provides data to or receives data from the stream *xdrs*.

No-Data Routine

Occasionally, an XDR routine must be supplied to the RPC system, even when no data is passed or required. The library provides such a routine.

```
bool_t xdr_void(); /* always returns TRUE */
```

Constructed Data Type Filters

Constructed or compound data type primitives require more parameters and perform more complicated functions than the primitives discussed previously. This section includes primitives for strings, arrays, unions, and pointers to structures.

Constructed data type primitives can use memory management. In many cases, memory is allocated when deserializing data with `XDR_DECODE`. Therefore, the XDR package must provide a means to de-allocate memory. The XDR operation, `XDR_FREE` provides this means. To review, the three XDR directional operations are `XDR_ENCODE`, `XDR_DECODE`, and `XDR_FREE`.

Strings

In the C language, a string is defined as a sequence of bytes terminated by a null byte, which is not considered when calculating string length. However, when a string is passed or manipulated, a pointer to it is employed. Therefore, the XDR library defines a string to be a `char *`, and not a sequence of characters. The external representation of a string is drastically different from its internal representation.

Externally, strings are represented as sequences of ASCII characters. Internally, strings are represented with character pointers. Conversion between the two representations is accomplished with the routine `xdr_string()`:

```
bool_t xdr_string(xdrs, sp, maxlength)  
    XDR *xdrs;  
    char **sp;  
    u_int maxlength;
```

The first parameter *xdrs* is the XDR stream handle. The second parameter *sp* is a pointer to a string (type `char **`). The third parameter *maxlength* specifies the maximum number of bytes allowed during encoding or decoding. Its value is usually

specified by a protocol. For example, a protocol specification might say that a file name can be no longer than 255 characters. The routine returns `FALSE` if the number of characters exceeds *maxlength*, and `TRUE` if it doesn't.

The behavior of `xdr_string()` is similar to the behavior of other routines discussed in this section. For example, in the direction `XDR_ENCODE`, the parameter *sp* points to a string of a certain length. If the string does not exceed *maxlength*, the bytes are serialized.

The effect of deserializing a string is subtle. First the length of the incoming string is determined; it must not exceed *maxlength*. Next *sp* is dereferenced. If the value is `NULL`, a string of the appropriate length is allocated and **sp* is set to this string. If the original value of **sp* is nonnull, the XDR package assumes that a target area has been allocated that can hold strings no longer than *maxlength*. In either case, the string is decoded into the target area. The routine then appends a null character to the string.

In the `XDR_FREE` operation the string is obtained by dereferencing *sp*. If the string is not `NULL`, it is freed and **sp* is set to `NULL`. In this operation `xdr_string()` ignores the *maxlength* parameter.

Note that you can use XDR on an empty string ("") but not on a `NULL` string.

Byte Arrays

Often variable-length arrays of bytes are preferable to strings. Byte arrays differ from strings in the following three ways:

- The length of the array, the byte count, is explicitly located in an unsigned integer.
- The byte sequence is not terminated by a null character.
- The external representation of the bytes is the same as their internal representation.

The primitive `xdr_bytes()` converts between the internal and external representations of byte arrays:

```
bool_t xdr_bytes(xdrs, bpp, lp, maxlength)
    XDR *xdrs;
    char **bpp;
    u_int *lp;
    u_int maxlength;
```

The usage of the first, second, and fourth parameters is identical to the first, second, and third parameters of `xdr_string()`. The length of the byte area is obtained by dereferencing *lp* when serializing; **lp* is set to the byte length when deserializing.

Arrays

The XDR library package provides a primitive for handling arrays of arbitrary elements. The `xdr_bytes()` routine treats a subset of generic arrays, in which the size of array elements is known to be 1, and the external description of each element is built in. The generic array primitive, `xdr_array()` requires parameters identical to those of `xdr_bytes()` plus two more: the size of array elements, and an XDR routine to handle each of the elements. This routine is called to encode or decode each element of the array.

```
bool_t
xdr_array(xdrs, ap, lp, maxlength, elementsize, xdr_element)
    XDR *xdrs;
    char **ap;
    u_int *lp;
    u_int maxlength;
    u_int elementsize;
    bool_t (*xdr_element)();
```

The parameter *ap* is the address of the pointer to the array. If *ap* is NULL when the array is being deserialized, XDR allocates an array of the appropriate size and sets *ap* to that array. The element count of the array is obtained from *lp* when the array is serialized; *lp* is set to the array length when the array is deserialized. The parameter *maxlength* is the maximum number of elements that the array is allowed to have; *elementsiz* is the byte size of each element of the array (the C function `sizeof()` can be used to obtain this value). The `xdr_element()` routine is called to serialize, deserialize, or free each element of the array.

Before defining more constructed data types, three examples are presented.

Array Example 1

A user on a networked machine can be identified by

- The machine name.
- The user's UID. See the `getuid(2)` man page.
- The group numbers to which the user belongs. See the `getgroups(2)` man page.

A structure with this information and its associated XDR routine could be coded as in the following code example.

EXAMPLE A-7 Array Example #1

```
struct netuser {
    char *nu_machinename;
    int nu_uid;
    u_int nu_glen;
    int *nu_gids;
};
#define NLEN 255 /* machine names < 256 chars */
```

EXAMPLE A-7 Array Example #1 (Continued)

```
#define NGRPS 20      /* user can't be in > 20 groups */

bool_t
xdr_netuser(xdrs, nup)
    XDR *xdrs;
    struct netuser *nup;
{
    return(xdr_string(xdrs, &nup->nu_machinename, NLEN) &&
           xdr_int(xdrs, &nup->nu_uid) &&
           xdr_array(xdrs, &nup->nu_gids, &nup->nu_glen, NGRPS,
                     sizeof (int), xdr_int));
}
```

Array Example 2

You could implement a party of network users as an array of `netuser` structure. The declaration and its associated XDR routines are as shown in the following code example.

EXAMPLE A-8 Array Example #2

```
struct party {

    u_int p_len;
    struct netuser *p_nusers;
};
#define PLEN 500 /* max number of users in a party */
bool_t
xdr_party(xdrs, pp)
    XDR *xdrs;
    struct party *pp;
{
    return(xdr_array(xdrs, &pp->p_nusers, &pp->p_len, PLEN,
                    sizeof (struct netuser), xdr_netuser));
}
```

Array Example 3

You can combine the well-known parameters to `main`, `argc` and `argv`, into a structure. An array of these structures can make up a history of commands. The declarations and XDR routines might look like the following example.

EXAMPLE A-9 Array Example #3

```
struct cmd {
    u_int c_argc;
    char **c_argv;
};
```

EXAMPLE A-9 Array Example #3 (Continued)

```
#define ALEN 1000          /* args cannot be > 1000 chars */
#define NARGC 100        /* commands cannot have > 100 args */

struct history {
    u_int h_len;
    struct cmd *h_cmds;
};
#define NCMS 75          /* history is no more than 75 commands */

bool_t
xdr_wrapstring(xdrs, sp)

    XDR *xdrs;
    char **sp;
{
    return(xdr_string(xdrs, sp, ALEN));
}

bool_t
xdr_cmd(xdrs, cp)

    XDR *xdrs;
    struct cmd *cp;
{
    return(xdr_array(xdrs, &cp->c_argv, &cp->c_argc, NARGC,
        sizeof (char *), xdr_wrapstring));
}

bool_t
xdr_history(xdrs, hp)

    XDR *xdrs;
    struct history *hp;
{
    return(xdr_array(xdrs, &hp->h_cmds, &hp->h_len, NCMS,
        sizeof (struct cmd), xdr_cmd));
}
```

Some confusion in this example is that you need the routine `xdr_wrapstring()` to package the `xdr_string()` routine, because the implementation of `xdr_array()` passes only two parameters to the array element description routine. `xdr_wrapstring()` supplies the third parameter to `xdr_string()`.

By now, the recursive nature of the XDR library should be obvious. A discussion follows of more constructed data types.

Opaque Data

In some protocols, handles are passed from a server to the client. The client passes the handle back to the server at some later time. Handles are never inspected by clients; they are obtained and submitted. That is, handles are opaque. The `xdr_opaque()` primitive is used for describing fixed-sized opaque bytes.

```
bool_t
xdr_opaque(xdrs, p, len)
    XDR *xdrs;
    char *p;
    u_int len;
```

The parameter *p* is the location of the bytes, *len* is the number of bytes in the opaque object. By definition, the actual data contained in the opaque object is not machine portable.

In the SunOS/SVR4 system is another routine for manipulating opaque data. This routine, the `xdr_netobj`, sends counted opaque data, much like `xdr_opaque()`. The following code example illustrates the syntax of `xdr_netobj()`.

EXAMPLE A-10 `xdr_netobj` Routine

```
struct netobj {
    u_int    n_len;
    char    *n_bytes;
};
typedef struct netobj netobj;

bool_t
xdr_netobj(xdrs, np)
    XDR *xdrs;
    struct netobj *np;
```

The `xdr_netobj()` routine is a filter primitive that translates between variable-length opaque data and its external representation. The parameter *np* is the address of the `netobj` structure containing both a length and a pointer to the opaque data. The length may be no more than `MAX_NETOBJ_SZ` bytes. This routine returns `TRUE` if it succeeds, `FALSE` otherwise.

Fixed-Length Arrays

The XDR library provides a primitive, `xdr_vector()`, for fixed-length arrays, shown in the following code example.

EXAMPLE A-11 `xdr_vector` Routine

```
#define NLEN 255    /* machine names must be < 256 chars */
#define NGRPS 20   /* user belongs to exactly 20 groups */
```

EXAMPLE A-11 xdr_vector Routine (Continued)

```
struct netuser {
    char *nu_machinename;
    int nu_uid;
    int nu_gids[NGRPS];
};

bool_t
xdr_netuser(xdrs, nup)
    XDR *xdrs;
    struct netuser *nup;
{
    int i;

    if (!xdr_string(xdrs, &nup->nu_machinename, NLEN))
        return(FALSE);
    if (!xdr_int(xdrs, &nup->nu_uid))
        return(FALSE);
    if (!xdr_vector(xdrs, nup->nu_gids, NGRPS, sizeof(int),
        xdr_int))
        return(FALSE);
    return(TRUE);
}
```

Discriminated Unions

The XDR library supports discriminated unions. A discriminated union is a C union and an `enum_t` value that selects an “arm” of the union.

```
struct xdr_discrim {
    enum_t value;
    bool_t (*proc)();
};

bool_t
xdr_union(xdrs, dscmp, unp, arms, defaultarm)
    XDR *xdrs;
    enum_t *dscmp;
    char *unp;
    struct xdr_discrim *arms;
    bool_t (*defaultarm)(); /* may equal NULL */
```

First the routine translates the discriminant of the union located at **dscmp*. The discriminant is always an `enum_t`. Next the union located at **unp* is translated. The parameter *arms* is a pointer to an array of `xdr_discrim` structures. Each structure contains an ordered pair of [*value,proc*]. If the union’s discriminant is equal to the associated *value*, then the *proc* is called to translate the union. The end of the `xdr_discrim` structure array is denoted by a routine of value `NULL` (0). If the discriminant is not found in the *arms* array, then the `defaultarm()` procedure is called if it is nonnull. Otherwise the routine returns `FALSE`.

Discriminated Union Example

Suppose the type of a union is integer, character pointer (a string), or a `gnumbers` structure. Also, assume the union and its current type are declared in a structure. The declaration is:

```
enum utype {INTEGER=1, STRING=2, GNUMBERS=3};
struct u_tag {
    enum utype utype;    /* the union's discriminant */
    union {
        int ival;
        char *pval;
        struct gnumbers gn;
    } uval;
};
```

The following code example constructs an XDR procedure to deserialize the discriminated union.

EXAMPLE A-12 XDR Discriminated Union

```
struct xdr_discrim u_tag_arms[4] = {
    {INTEGER, xdr_int},
    {GNUMBERS, xdr_gnumbers},
    {STRING, xdr_wrapstring},
    {__dontcare__, NULL}
    /* always terminate arms with a NULL xdr_proc */
}

bool_t
xdr_u_tag(xdrs, utp)
XDR *xdrs;
struct u_tag *utp;
{
    return(xdr_union(xdrs, &utp->utype, &utp->uval,
        u_tag_arms, NULL));
}
```

The routine `xdr_gnumbers()` was presented previously in “XDR Library” on page 218. The default *arm* parameter to `xdr_union()`, the last parameter, is `NULL` in this example. Therefore, the value of the union’s discriminant can legally take on only values listed in the `u_tag_arms` array. Example A-12 also demonstrates that the elements of the arm’s array do not need to be sorted.

The values of the discriminant can be sparse, though in Example A-12 they are not. Make a practice of assigning explicitly integer values to each element of the discriminant’s type. This practice both documents the external representation of the discriminant and guarantees that different C compilers emit identical discriminant values.

Pointers

In C, putting pointers to another structure within a structure is often convenient. The `xdr_reference()` primitive makes it easy to serialize, deserialize, and free these referenced structures.

```
bool_t
xdr_reference(xdrs, pp, size, proc)
    XDR *xdrs;
    char **pp;
    u_int ssize;
    bool_t (*proc)();
```

Parameter *pp* is the address of the pointer to the structure; parameter *ssize* is the size in bytes of the structure (use the C function `sizeof()` to obtain this value); and `proc()` is the XDR routine that describes the structure. When decoding data, storage is allocated if *pp* is `NULL`.

A primitive `xdr_struct()` does not need to describe structures within structures because pointers are always sufficient.

Pointer Example

Suppose you have a structure containing a person's name and a pointer to a `gnumbers` structure containing the person's gross assets and liabilities. The construct is:

```
struct pgn {
    char *name;
    struct gnumbers *gnp;
};
```

The corresponding XDR routine for this structure is:

```
bool_t
xdr_pgn(xdrs, pp)
    XDR *xdrs;
    struct pgn *pp;
{
    return(xdr_string(xdrs, &pp->name, NLEN) &&
        xdr_reference(xdrs, &pp->gnp, sizeof(struct gnumbers),
            xdr_gnumbers));
}
```

Pointer Semantics

In many applications, C programmers attach double meaning to the values of a pointer. Typically the value `NULL` (or zero) means data is not needed, yet some application-specific interpretation applies. In essence, the C programmer is encoding a discriminated union efficiently by overloading the interpretation of the value of a

pointer. For instance, a NULL pointer value for *gnp* could indicate that the person's assets and liabilities are unknown. That is, the pointer value encodes two things: whether the data is known and, if it is known, where it is located in memory. Linked lists are an extreme example of the use of application-specific pointer interpretation.

The primitive `xdr_reference()` cannot and does not attach any special meaning to a null-value pointer during serialization. That is, passing an address of a pointer that has a value of value of NULL to `xdr_reference()` when serializing data most likely causes a memory fault and, on the UNIX system, a core dump.

`xdr_pointer()` correctly handles NULL pointers.

Nonfilter Primitives

You can manipulate XDR streams with the primitives discussed in this section.

```
u_int xdr_getpos(xdrs)
      XDR *xdrs;

bool_t xdr_setpos(xdrs, pos)
      XDR *xdrs;
      u_int pos;

xdr_destroy(xdrs)
      XDR *xdrs;
```

The routine `xdr_getpos()` returns an unsigned integer that describes the current position in the data stream.



Caution – In some XDR streams, the value returned by `xdr_getpos()` is meaningless; the routine returns a -1 in this case (though -1 should be a legitimate value).

The routine `xdr_setpos()` sets a stream position to *pos*. In some XDR streams, setting a position is impossible; in such cases, `xdr_setpos()` returns `FALSE`. This routine also fails if the requested position is out-of-bounds. The definition of bounds varies from stream to stream.

The `xdr_destroy()` primitive destroys the XDR stream. Usage of the stream after calling this routine is undefined.

Operation Directions

At times, you might want to optimize XDR routines by taking advantage of the direction of the operation: `XDR_ENCODE`, `XDR_DECODE` or `XDR_FREE`. The value `xdrs->x_op` always contains the direction of the XDR operation. An example in “Linked Lists” on page 238 demonstrates the usefulness of the `xdrs->x_op` field.

Stream Access

An XDR stream is obtained by calling the appropriate creation routine. These creation routines take arguments that are tailored to the specific properties of the stream. Streams currently exist for deserialization of data to or from standard I/O FILE streams, record streams, memory, and UNIX files.

Standard I/O Streams

XDR streams can be interfaced to standard I/O using the `xdrstdio_create()` routine.

```
#include <stdio.h>
#include <rpc/rpc.h> /* xdr is part of rpc */

void
xdrstdio_create(xdrs, fp, xdr_op)
    XDR *xdrs;
    FILE *fp;
    enum xdr_op x_op;
```

The routine `xdrstdio_create()` initializes an XDR stream pointed to by `xdrs`. The XDR stream interfaces to the standard I/O library. Parameter `fp` is an open file, and `x_op` is an XDR direction.

Memory Streams

Memory streams allow the streaming of data into or out of a specified area of memory:

```
#include <rpc/rpc.h>

void
xdrmem_create(xdrs, addr, len, x_op)
    XDR *xdrs;
    char *addr;
    u_int len;
    enum xdr_op x_op;
```

The routine `xdrmem_create()` initializes an XDR stream in local memory. The memory is pointed to by parameter *addr*. Parameter *len* is the length in bytes of the memory. The parameters *xdrs* and *x_op* are identical to the corresponding parameters of `xdrstdio_create()`. Currently, the datagram implementation of RPC uses `xdrmem_create()`. Complete call or result messages are built in memory before calling the `t_sndndata()` TLI routine.

Record TCP/IP Streams

A record stream is an XDR stream built on top of a record-marking standard that is built on top of the UNIX file or 4.2 BSD connection interface.

```
#include <rpc/rpc.h>      /* xdr is part of rpc */

xdrrec_create(xdrs, sendsize, recvsize, iohandle, readproc,
              writeproc)
    XDR *xdrs;
    u_int sendsize, recvsize;
    char *iohandle;
    int (*readproc)(), (*writeproc)();
```

The routine `xdrrec_create()` provides an XDR stream interface that allows for a bidirectional, arbitrarily long sequence of records. The contents of the records are meant to be data in XDR form. The stream's primary use is for interfacing RPC to TCP connections. However, it can be used to stream data into or out of normal UNIX files.

The parameter *xdrs* is similar to the corresponding parameter described previously. The stream does its own data buffering similar to that of standard I/O. The parameters *sendsize* and *recvsize* determine the size in bytes of the output and input buffers respectively. If their values are zero (0), then predetermined defaults are used.

When a buffer needs to be filled or flushed, the routine `readproc()` or `writeproc()` is called respectively. The usage and behavior of these routines are similar to the UNIX system calls `read()` and `write()`. However, the first parameter to each of these routines is the opaque parameter *iohandle*. The other two parameters, and *nbytes* and the results, byte count, are identical to the system routines. If `xxx()` is `readproc()` or `writeproc()`, then it has the following form:

```
/* returns the actual number of bytes transferred. -1 is an error */int
xxx(iohandle, buf, len)
    char *iohandle;
    char *buf;
    int nbytes;
```

The XDR stream provides a means for delimiting records in the byte stream. Abstract data types needed to implement the XDR stream mechanism are discussed in "XDR Stream Implementation" on page 236. The protocol RPC uses to delimit XDR stream records is discussed in "Record-Marking Standard" on page 252.

The primitives that are specific to record streams are:

```

bool_t
xdrrec_endofrecord(xdrs, flushnow)
    XDR *xdrs;
    bool_t flushnow;

```

```

bool_t
xdrrec_skiprecord(xdrs)
    XDR *xdrs;

```

```

bool_t
xdrrec_eof(xdrs)
    XDR *xdrs;

```

The routine `xdrrec_endofrecord()` causes the current outgoing data to be marked as a record. If the parameter *flushnow* is TRUE, then the stream's `writproc()` is called. Otherwise, `writproc()` is called when the output buffer is full.

The routine `xdrrec_skiprecord()` causes an input stream's position to be moved past the current record boundary and onto the beginning of the next record in the stream.

If no more data is in the stream's input buffer, then the routine `xdrrec_eof()` returns TRUE. That does not mean that no more data is in the underlying file descriptor.

XDR Stream Implementation

This section provides the abstract data types needed to implement new instances of XDR streams.

XDR Object

The structure in the following code example defines the interface to an XDR stream.

EXAMPLE A-13 XDR Stream Interface Example

```

enum xdr_op {XDR_ENCODE=0, XDR_DECODE=1, XDR_FREE=2};
typedef struct {
    enum xdr_op x_op;
    struct xdr_ops {
        bool_t (*x_getlong)();           /* get long from stream */
        bool_t (*x_putlong)();          /* put long to stream */
        bool_t (*x_getbytes)();         /* get bytes from stream */
        bool_t (*x_putbytes)();         /* put bytes to stream */
        u_int (*x_getpostn)();          /* return stream offset */
    };
};

```

EXAMPLE A-13 XDR Stream Interface Example (Continued)

```
bool_t (*x_setpostn)(); /* reposition offset */
caddr_t (*x_inline)(); /* ptr to buffered data */
VOID (*x_destroy)(); /* free private area */
bool_t (*x_control)(); /* change, retrieve client info */
bool_t (*x_getint32)(); /* get int from stream */
bool_t (*x_putint32)(); /* put into stream */
} *x_ops;
caddr_t x_public; /* users' data */
caddr_t x_private; /* pointer to private data */
caddr_t x_base; /* private for position info */
int x_handy; /* extra private word */
} XDR;
```

The `x_op` field is the current operation being performed on the stream. This field is important to the XDR primitives, but should not affect a stream's implementation. That is, a stream's implementation should not depend on this value. The fields `x_private`, `x_base`, and `x_handy` are private to the particular stream's implementation. The field `x_public` is for the XDR client and should never be used by the XDR stream implementations or the XDR primitives. `x_getpostn()`, `x_setpostn()`, and `x_destroy()` are macros for accessing operations.

The operation `x_inline()` has two parameters: an XDR *, and an unsigned integer, which is a byte count. The routine returns a pointer to a piece of the stream's internal buffer. The caller can then use the buffer segment for any purpose. The stream's interpretation is that the bytes in the buffer segment have been consumed. The routine can return NULL if it cannot return a buffer segment of the requested size.



Caution – The `x_inline()` routine is used to squeeze cycles, and the resulting buffer is not data portable. Do not use this feature.

The operations `x_getbytes()` and `x_putbytes()` routinely get and put sequences of bytes from or to the underlying stream. They return TRUE if they are successful, and FALSE otherwise. The routines have identical parameters (replace `xxx` with the same string in each case.)

```
bool_t
xxxbytes(xdrs, buf, bytecount)
    XDR *xdrs;
    char *buf;
    u_int bytecount;
```

The operations `x_getint32()` and `x_putint32()` receive and put int numbers from and to the data stream. These routines are responsible for translating the numbers between the machine representation and the (standard) external representation. The UNIX primitives `htonl()` and `ntohl()` can be helpful in accomplishing this objective. The higher-level XDR implementation assumes that

signed and unsigned integers contain the same number of bits, and that nonnegative integers have the same bit representations as unsigned integers. The routines return TRUE if they succeed, and FALSE otherwise.

The `x_getint()` and `x_putint()` functions make use of these operations. They have identical parameters:

```
bool_t
xxxint(xdrs, ip)
    XDR *xdrs;
    int32_t *ip;
```

The long version of these operations (`x_getlong()` and `x_putlong()`) also call `x_getint32()` and `x_putint32()`, ensuring that a 4-byte quantity is operated on, no matter what machine the program is running on.

Implementors of new XDR streams must make an XDR structure with new operation routines available to clients, using some kind of create routine.

Advanced XDR Topics

This section describes techniques for passing data structures that are not covered in the preceding sections. Such structures include linked lists of arbitrary lengths. Unlike the simpler examples covered in the previous sections, the following examples are written using both the XDR C library routines and the XDR data description language. Appendix C describes this language in detail.

Linked Lists

The “Pointer Example” on page 232 presented a C data structure and its associated XDR routines for an individual’s gross assets and liabilities. The following code example uses a linked list to duplicate the pointer example.

EXAMPLE A-14 Linked List

```
struct gnumbers {
    int g_assets;
    int g_liabilities;
};

bool_t
xdr_gnumbers(xdrs, gp)
    XDR *xdrs;
    struct gnumbers *gp;
{
```

EXAMPLE A-14 Linked List (Continued)

```
        return(xdr_int(xdrs, &(gp->g_assets) &&
                    xdr_int(xdrs, &(gp->g_liabilities)));
    }
```

Now assume that you want to implement a linked list of such information. A data structure could be constructed as follows.

```
struct gnumbers_node {
    struct gnumbers gn_numbers;
    struct gnumbers_node *gn_next;
};
typedef struct gnumbers_node *gnumbers_list;
```

Think of the head of the linked list as the data object. That is, the head is not merely a convenient shorthand for a structure. Similarly, the `gn_next` field is used to indicate whether the object has terminated. Unfortunately, if the object continues, the `gn_next` field is also the address of where it continues. The link addresses carry no useful information when the object is serialized.

The XDR data description of this linked list is described by the recursive declaration of `gnumbers_list`.

```
struct gnumbers {
    int g_assets;
    int g_liabilities;
};
struct gnumbers_node {
    gnumbers gn_numbers;
    gnumbers_node *gn_next;
};
```

In this description, the Boolean indicates more data follows. If the Boolean is `FALSE`, it is the last data field of the structure. If it is `TRUE`, it is followed by a `gnumbers` structure and, recursively, by a `gnumbers_list`. Note that the C declaration has no Boolean explicitly declared in it, though the `gn_next` field implicitly carries the information. The XDR data description has no pointer explicitly declared in it.

Hints for writing the XDR routines for a `gnumbers_list` follow easily from the preceding XDR description. Note how the primitive `xdr_pointer()` is used to implement the preceding XDR union.

EXAMPLE A-15 `xdr_pointer`

```
bool_t
xdr_gnumbers_node(xdrs, gn)
    XDR *xdrs;
    gnumbers_node *gn;
{
    return(xdr_gnumbers(xdrs, &gn->gn_numbers) &&
        xdr_gnumbers_list(xdrs, &gn->gn_next));
}
```

EXAMPLE A-15 xdr_pointer (Continued)

```
}

bool_t
xdr_gnumbers_list(xdrs, gnp)
    XDR *xdrs;
    gnumbers_list *gnp;
{
    return(xdr_pointer(xdrs, gnp, sizeof(struct gnumbers_node),
                      xdr_gnumbers_node));
xdr_pointer}
```

The side effect of using XDR on a list with these routines is that the C stack grows linearly with respect to the number of nodes in the list. This growth is due to the recursion. The following example collapses the last two mutually recursive routines into a single, nonrecursive one.

EXAMPLE A-16 Nonrecursive Stack in XDR

```
bool_t
xdr_gnumbers_list(xdrs, gnp)
    XDR *xdrs;
    gnumbers_list *gnp;
{
    bool_t more_data;
    gnumbers_list *nextp;

    for(;;) {
        more_data = (*gnp != NULL);
        if (!xdr_bool(xdrs, &more_data))
            return(FALSE);
        if (! more_data)
            break;
        if (xdrs->x_op == XDR_FREE)
            nextp = &(*gnp)->gn_next;
        if (!xdr_reference(xdrs, gnp,
                          sizeof(struct gnumbers_node), xdr_gnumbers))
            return(FALSE);
        gnp = (xdrs->x_op == XDR_FREE) ? nextp : &(*gnp)->gn_next;
    }
    *gnp = NULL;
    return(TRUE);
}
```

The first task is to find out whether more data exists, so that this Boolean information can be serialized. Notice that this statement is unnecessary in the XDR_DECODE case, because the value of more_data is not known until you deserialize it in the next statement.

The next statement implements XDR on the *more_data* field of the XDR union. Then if no more data exists, you set this last pointer to NULL to indicate the end of the list, and return TRUE because you are done. Note that setting the pointer to NULL is only important in the XDR_DECODE case, because the pointer is already NULL in the XDR_ENCODE and XDR_FREE cases.

Next, if the direction is XDR_FREE, set the value of *nextp* to indicate the location of the next pointer in the list. You set this value now because you need to dereference *gnp* to find the location of the next item in the list. After the next statement, the storage pointed to by *gnp* is freed up and no longer valid. You cannot set this value for all directions, though, because in the XDR_DECODE direction the value of *gnp* is not set until the next statement.

Next, you use XDR on the data in the node using the primitive `xdr_reference()`. `xdr_reference()` is like `xdr_pointer()`, which you used before, but it does not send over the Boolean indicating whether more data exists. You use `xdr_reference()` instead of `xdr_pointer()` because you have already used XDR on this information yourself.

Notice that the XDR routine passed is not the same type as an element in the list. The routine passed is `xdr_gnumbers()`, but each element in the list is actually of type `gnumbers_node`. You don't pass `xdr_gnumbers_node()` because it is recursive. Instead, use `xdr_gnumbers()`, which uses XDR on all of the nonrecursive part. Note that this trick works only if the *gn_numbers* field is the first item in each element, so that their addresses are identical when passed to `xdr_reference()`.

Finally, you update *gnp* to point to the next item in the list. If the direction is XDR_FREE, you set it to the previously saved value. Otherwise, you can dereference *gnp* to get the proper value. Though harder to understand than the recursive version, this nonrecursive routine runs more efficiently because much of the procedure call overhead has been removed. Most lists are small, in the hundreds of items or less, and the recursive version should be sufficient for them.

RPC Protocol and Language Specification

This appendix specifies a message protocol used in implementing the RPC package. The message protocol is specified with the XDR language. The companion appendix to this one is Appendix C.

This appendix covers the following topics:

- “Protocol Overview” on page 243
- “Program and Procedure Numbers” on page 246
- “Authentication Protocols” on page 252
- “RPC Language Specification” on page 263

Protocol Overview

The RPC protocol provides for the following:

- Unique specification of a procedure to be called.
- Provisions for matching response messages to request messages.
- Provisions for authenticating the caller to service and the reverse. In addition, the RPC package provides features that detect the following:
 - RPC protocol mismatches
 - Remote program protocol version mismatches
 - Protocol errors, such as incorrect specification of a procedure’s parameters
 - Reasons why remote authentication failed

Consider a network file service composed of two programs. One program might handle high-level applications such as file-system access control and locking. The other might handle low-level file I/O and have procedures like read and write. A

client machine of the network file service would call the procedures associated with the two programs of the service on behalf of some user on the client machine. In the client-server model, a remote procedure call is used to call the service.

RPC Model

The RPC model is similar to the local procedure call model. In the local case, the caller places arguments to a procedure in some well-specified location. The caller then transfers control to the procedure, and eventually regains control. At that point, the results of the procedure are extracted from a well-specified location, and the caller continues execution.

The RPC model is similar, in that one thread of control logically winds through two processes. One is the caller's process, the other is a server's process. Conceptually, the caller process sends a call message to the server process and waits for a reply message. The call message contains the procedure's parameters, among other information. The reply message contains the procedure's results, among other information. After the reply message is received, the results of the procedure are extracted, and the caller's execution is resumed.

On the server side, a process is dormant awaiting the arrival of a call message. When one arrives, the server process extracts the procedure's parameters, computes the results, sends a reply message, and then awaits the next call message.

Note that in this description only one of the two processes is active at any given time. However, the RPC protocol makes no restrictions on the concurrency model implemented. For example, an implementation might choose to have RPC calls be asynchronous, so that the client can do useful work while waiting for the reply from the server. Another possibility is to have the server create a task to process an incoming request so that the server is free to receive other requests.

Transports and Semantics

The RPC protocol is independent of transport protocols. That is, RPC disregards how a message is passed from one process to another. The protocol handles only specification and interpretation of messages.

RPC does not attempt to ensure transport reliability. Therefore, you must supply the application with information about the type of transport protocol used under RPC. If you tell the RPC service that it is running on top of a reliable transport such as TCP, most of the work is already done for the service. On the other hand, if RPC is running on top of an unreliable transport such as UDP, the service must devise its own retransmission and time-out policy. RPC does not provide this service.

Because of transport independence, the RPC protocol does not attach specific semantics to the remote procedures or their execution. Semantics can be inferred from, but should be explicitly specified by, the underlying transport protocol. For example,

suppose RPC is running on top of an unreliable transport. If an application retransmits RPC messages after short timeouts receiving no reply, it can infer only that the procedure was executed zero or more times. If the application does receive a reply, it can infer that the procedure was executed at least once.

A server might choose to remember previously granted requests from a client and not regrant them to ensure some degree of execute-at-most-once semantics. A server can do this by using the transaction ID that is packaged with every RPC request. The main use of this transaction ID is by the RPC client for matching replies to requests. However, a client application can choose to reuse its previous transaction ID when retransmitting a request. The server application, checking this fact, can choose to remember this ID after granting a request and not regrant requests with the same ID. The server is not allowed to examine this ID in any other way except as a test for equality.

On the other hand, if using a reliable transport such as TCP, the application can infer from a reply message that the procedure was executed exactly once. If the application receives no reply message, it cannot assume the remote procedure was not executed. Note that even if a connection-oriented protocol like TCP is used, an application still needs timeouts and reconnection to handle server crashes.

Binding and Rendezvous Independence

The act of binding a client to a service is not part of the remote procedure call specification. This important and necessary function is left up to some higher-level software. The software can use RPC itself. See “`rpcbind` Protocol” on page 272.

Implementers should think of the RPC protocol as the jump-subroutine (JSR) instruction of a network. The loader makes JSR useful, and the loader itself uses JSR to accomplish its task. Likewise, the network makes RPC useful, enabling RPC to accomplish this task.

The RPC protocol provides the fields necessary for a client to identify itself to a service and the reverse. Security and access control mechanisms can be built on top of the message authentication. Several different authentication protocols can be supported. A field in the RPC header specifies the protocol being used. You can find more information on authentication protocols in the section “Record-Marking Standard” on page 252.

Program and Procedure Numbers

The RPC call message has three unsigned fields that uniquely identify the procedure to be called:

- Remote program number
- Remote program version number
- Remote procedure number

Program numbers are administered by a central authority, as described in “Program Number Registration” on page 248.

The first implementation of a program most likely has version number 1. Most new protocols evolve into better, stable, and mature protocols. Therefore, a version field of the call message identifies the version of the protocol that the caller is using. Version numbers make speaking old and new protocols through the same server process possible.

The procedure number identifies the procedure to be called. These numbers are documented in the individual program’s protocol specification. For example, a file service’s protocol specification might state that its procedure number 5 is read and procedure number 12 is write.

Just as remote program protocols can change over several versions, the RPC message protocol itself can change. Therefore, the call message also has in it the RPC version number, which is always equal to 2 for the version of RPC described here.

The reply message to a request message has enough information to distinguish the following error conditions:

- The remote implementation of RPC does not speak protocol version 2. The lowest and highest supported RPC version numbers are returned.
- The remote program is not available on the remote system.
- The remote program does not support the requested version number. The lowest and highest supported remote program version numbers are returned.
- The requested procedure number does not exist. This result is usually a caller-side protocol or programming error.
- The server interprets the parameters to the remote procedure as garbage. Again, this result is usually caused by a disagreement about the protocol between client and service.

Provisions for authentication of caller to service and the reverse are provided as a part of the RPC protocol. The call message has two authentication fields, the credentials and verifier. The reply message has one authentication field, the response verifier. The RPC protocol specification defines all three fields to be the following opaque type.

```

enum auth_flavor {
    AUTH_NONE = 0,
    AUTH_SYS = 1,
    AUTH_SHORT = 2,
    AUTH_DES = 3,
    AUTH_KERB = 4
    /* and more to be defined */
};
struct opaque_auth {
    enum auth_flavor; /* style of credentials */
    caddr_t oa_base; /* address of more auth stuff */
    u_int oa_length; /* not to exceed MAX_AUTH_BYTES */
};

```

An `opaque_auth` structure is an `auth_flavor` enumeration followed by bytes that are opaque to the RPC protocol implementation.

The interpretation and semantics of the data contained within the authentication fields are specified by individual, independent authentication protocol specifications. See “Record-Marking Standard” on page 252 for definitions of the various authentication protocols.

If authentication parameters are rejected, the response message contains information stating why they are rejected.

Program Number Assignment

Program numbers are distributed in groups of `0x20000000`, as shown in the following table.

TABLE B-1 RPC Program Number Assignment

Program Numbers	Description
00000000 - 1ffffff	Defined by host
20000000 - 3ffffff	Defined by user
40000000 - 5ffffff	Transient (reserved for customer-written applications)
60000000 - 7ffffff	Reserved
80000000 - 9ffffff	Reserved
a0000000 - bffffff	Reserved
c0000000 - dffffff	Reserved
e0000000 - fffffff	Reserved

Sun Microsystems administers the first group of numbers, which should be identical for all customers. If a customer develops an application that might be of general interest, that application should be given an assigned number in the first range.

The second group of numbers is reserved for specific customer applications. This range is intended primarily for debugging new programs.

The third group is reserved for applications that generate program numbers dynamically.

The final groups are reserved for future use, and should not be used.

Program Number Registration

To register a protocol specification, send a request by email to rpc@sun.com, or write to: RPC Administrator, Sun Microsystems, 901 San Antonio Road, Palo Alto, CA 94043

Include a compilable `rpcgen .x` file describing your protocol. You are given a unique program number in return.

You can find the RPC program numbers and protocol specifications of standard RPC services in the include files in `/usr/include/rpcsvc`. These services, however, constitute only a small subset of those that have been registered.

Other Uses of the RPC Protocol

The intended use of this protocol is for calling remote procedures. That is, each call message is matched with a response message. However, the protocol itself is a message-passing protocol with which other non-RPC protocols can be implemented. Some of the non-RPC protocols supported by the RPC package are batching and broadcasting.

Batching

Batching enables a client to send an arbitrarily large sequence of call messages to a server. Batching typically uses reliable byte-stream protocols like TCP for its transport. In batching, the client never waits for a reply from the server, and the server does not send replies to batch requests. A sequence of batch calls is usually finished by a non-batch RPC call to flush the pipeline with positive acknowledgement. For more information, see "Batching" on page 113.

Broadcast RPC

In broadcast RPC, the client sends a broadcast packet to the network and waits for numerous replies. Broadcast RPC uses connectionless, packet-based protocols like UDP as its transports. Servers that support broadcast protocols only respond when the

request is successfully processed, and are silent in the face of errors. Broadcast RPC uses the `rpcbind` service to achieve its semantics. See “Broadcast RPC” on page 111 and “`rpcbind` Protocol” on page 272 for further information.

RPC Message Protocol

This section defines the RPC message protocol in the XDR data description language. The message is defined in a top-down style, as shown in the following code example.

EXAMPLE B-1 RPC Message Protocol

```
enum msg_type {
    CALL = 0,
    REPLY = 1
};

/*
 * A reply to a call message can take on two forms: The message was
 * either accepted or rejected.
 */
enum reply_stat {
    MSG_ACCEPTED = 0,
    MSG_DENIED = 1
};

/*
 * Given that a call message was accepted, the following is the
 * status of an attempt to call a remote procedure.
 */
enum accept_stat {
    SUCCESS = 0,          /* RPC executed successfully */
    PROG_UNAVAIL = 1,    /* remote service hasn't exported prog */
    PROG_MISMATCH = 2,  /* remote service can't support versn # */
    PROC_UNAVAIL = 3,   /* program can't support proc */
    GARBAGE_ARGS = 4   /* procedure can't decode params */
};

/*
 * Reasons a call message was rejected:
 */
enum reject_stat {
    RPC_MISMATCH = 0, /* RPC version number != 2 */
    AUTH_ERROR = 1   /* remote can't authenticate caller */
};

/*
 * Why authentication failed:
 */
enum auth_stat {
    AUTH_BADCRED = 1,      /* bad credentials */
    AUTH_REJECTEDCRED = 2, /* clnt must do new session */
    AUTH_BADVERF = 3,     /* bad verifier */
    AUTH_REJECTEDVERF = 4, /* verfif expired or replayed */
};
```

EXAMPLE B-1 RPC Message Protocol (Continued)

```
        AUTH_TOOWEAK = 5          /* rejected for security */
};

/*
 * The RPC message:
 * All messages start with a transaction identifier, xid, followed
 * by a two-armed discriminated union. The union's discriminant is
 * a msg_type which switches to one of the two types of the
 * message.
 * The xid of a REPLY message always matches that of the
 * initiating CALL message. NB: The xid field is only used for
 * clients matching reply messages with call messages or for servers
 * detecting retransmissions; the service side cannot treat this id as
 * any type of sequence number.
 */
struct rpc_msg {
    unsigned int xid;
    union switch (msg_type mtype) {
        case CALL:
            call_body cbody;
        case REPLY:
            reply_body rbody;
    } body;
};

/*
 * Body of an RPC request call:
 * In version 2 of the RPC protocol specification, rpcvers must be
 * equal to 2. The fields prog, vers, and proc specify the remote
 * program, its version number, and the procedure within the
 * remote program to be called. After these fields are two
 * authentication parameters: cred (authentication credentials) and
 * verf (authentication verifier). The two authentication parameters
 * are followed by the parameters to the remote procedure, which are
 * specified by the specific program protocol.
 */
struct call_body {
    unsigned int rpcvers; /* must be equal to two (2) */
    unsigned int prog;
    unsigned int vers;
    unsigned int proc;
    opaque_auth cred;
    opaque_auth verf;
    /* procedure specific parameters start here */
};

/*
 * Body of a reply to an RPC request:
 * The call message was either accepted or rejected.
 */
union reply_body switch (reply_stat stat) {
    case MSG_ACCEPTED:
        accepted_reply areply;
};
```

EXAMPLE B-1 RPC Message Protocol (Continued)

```
        case MSG_DENIED:
            rejected_reply rreply;
    } reply;

/*
 * Reply to an RPC request that was accepted by the server: there
 * could be an error even though the request was accepted. The
 * first field is an authentication verifier that the server
 * generates in order to validate itself to the caller. It is
 * followed by a union whose discriminant is an enum accept_stat.
 * The SUCCESS arm of the union is protocol specific.
 * The PROG_UNAVAIL, PROC_UNAVAIL, and GARBAGE_ARGP arms of
 * the union are void. The PROG_MISMATCH arm specifies the lowest
 * and highest version numbers of the remote program supported by
 * the server.
 */
struct accepted_reply {
    opaque_auth verf;
    union switch (accept_stat stat) {
        case SUCCESS:
            opaque results[0];
            /* procedure-specific results start here */
        case PROG_MISMATCH:
            struct {
                unsigned int low;
                unsigned int high;
            } mismatch_info;
        default:
            /*
             * Void. Cases include PROG_UNAVAIL, PROC_UNAVAIL, and
             * GARBAGE_ARGS.
             */
            void;
    } reply_data;
};

/*
 * Reply to an RPC request that was rejected by the server:
 * The request can be rejected for two reasons: either the server
 * is not running a compatible version of the RPC protocol
 * (RPC_MISMATCH), or the server refuses to authenticate the
 * caller AUTH_ERROR). In case of an RPC version mismatch,
 * the server returns the lowest and highest supported RPC
 * version numbers. In case of refused authentication, failure
 * status is returned.
 */
union rejected_reply switch (reject_stat stat) {
    case RPC_MISMATCH:
        struct {
            unsigned int low;
            unsigned int high;
        } mismatch_info;
    case AUTH_ERROR:
```

EXAMPLE B-1 RPC Message Protocol (Continued)

```
        auth_stat stat;  
};
```

Record-Marking Standard

When RPC messages are passed on top of a byte-stream transport like TCP, you should try to delimit one message from another to detect and possibly recover from user protocol errors. This is called record marking (RM). One RPC message fits into one RM record.

A record is composed of one or more record fragments. A record fragment is a 4-byte header followed by 0 to $(2^{31}) - 1$ bytes of fragment data. The bytes encode an unsigned binary number. As with XDR integers, the byte order is the network byte order.

The header encodes two values:

- A Boolean that specifies whether the fragment is the last fragment of the record. Bit value 1 implies the fragment is the last fragment.
- A 31-bit unsigned binary value that is the length in bytes of the fragment's data. The Boolean value is the highest-order bit of the header. The length is the 31 low-order bits. This record specification is not in XDR standard form.

Authentication Protocols

Authentication parameters are opaque but open-ended to the rest of the RPC protocol. This section defines some flavors of authentication that have already been implemented. Other sites are free to invent new authentication types, with the same rules of flavor number assignment for program number assignment. Sun Microsystems maintains and administers a range of authentication flavors. To have authentication numbers like RPC program numbers allocated or registered to them, contact the Sun RPC Administrator.

AUTH_NONE

Calls are often made in which the caller does not authenticate itself and the server disregards who the caller is. In these cases, the *flavor* value of the RPC message's credentials, verifier, and response verifier is AUTH_NONE. The flavor value is the "discriminant" of the `opaque_auth` "union." The body length is zero when AUTH_NONE authentication flavor is used.

AUTH_SYS

`AUTH_SYS` This is the same as the authentication flavor previously known as `AUTH_UNIX`. The caller of a remote procedure might wish to identify itself using traditional UNIX process permissions authentication. The *flavor* of the `opaque_auth` of such an RPC call message is `AUTH_SYS`. The bytes of the body encode the following structure:

```
struct auth_sysparms {
    unsigned int stamp;
    string machinename<255>;
    uid_t uid;
    gid_t gid;
    gid_t gids<10>;
};
```

stamp is an arbitrary ID that the caller machine can generate.

machinename is the name of the caller's machine.

uid is the caller's effective user ID.

gid is the caller's effective group ID.

gids is a counted array of groups in which the caller is a member.

The *flavor* of the verifier accompanying the credentials should be `AUTH_NONE`.

AUTH_SHORT Verifier

When using `AUTH_SYS` authentication, the *flavor* of the response verifier received in the reply message from the server might be `AUTH_NONE` or `AUTH_SHORT`.

If `AUTH_SHORT`, the bytes of the response verifier's string encode a `short_hand_verf` structure. This opaque structure can now be passed to the server instead of the original `AUTH_SYS` credentials.

The server keeps a cache that maps the shorthand opaque structures to the original credentials of the caller. These structures are passed back by way of an `AUTH_SHORT` style response verifier. The caller can save network bandwidth and server CPU cycles by using the new credentials.

The server can flush the shorthand opaque structure at any time. If a flush occurs, the remote procedure call message is rejected because of an authentication error. The reason for the failure is `AUTH_REJECTEDCRED`. At this point, the caller might try the original `AUTH_SYS` style of credentials, as shown in the following figure.

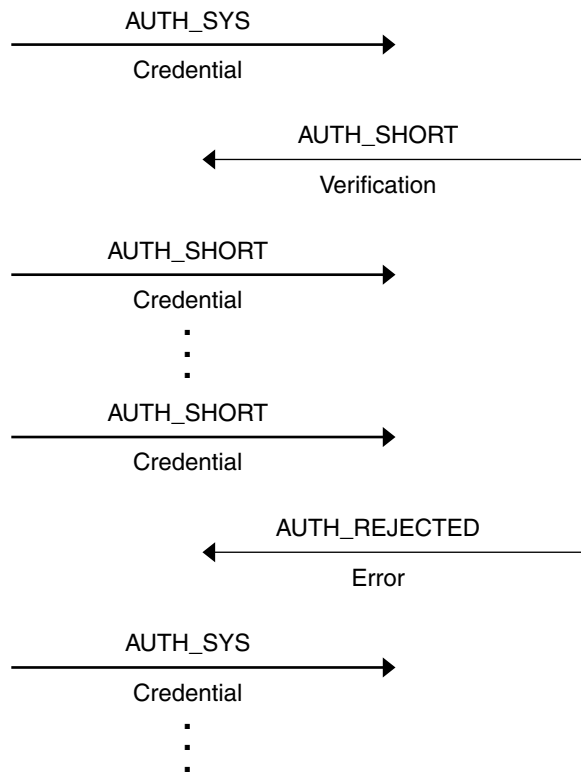

FIGURE B-1 Authentication Process Map

AUTH_DES Authentication

You might encounter the following situations with `AUTH_SYS` authentication:

- Caller identification cannot be guaranteed to be unique if machines with differing operating systems are on the same network.
- No verifier exists, so credentials can easily be faked.

`AUTH_DES` authentication attempts to fix these two problems.

The first issue is handled by addressing the caller by a simple string of characters instead of by an operating system-specific integer. This string of characters is known as the net name or network name of the caller. The server should not interpret the caller's name in any way other than as the identity of the caller. Thus, net names should be unique for every caller in the naming domain.

Each operating system's implementation of AUTH_DES authentication generates net names for its users that ensure this uniqueness when they call remote servers. Operating systems already distinguish users local to their systems. Extending this mechanism to the network is usually a simple matter.

For example, a user with a user ID of 515 might be assigned the following net name: UNIX.515@sun.com. This net name contains three items that serve to ensure it is unique. Backtracking, only one naming domain is called sun.com in the Internet. Within this domain, only one UNIX user has the user ID 515. However, there might be another user on another operating system, for example VMS, within the same naming domain who, by coincidence, happens to have the same user ID. To ensure that these two users can be distinguished, you add the operating system name. So one user is UNIX.515@sun.com and the other is VMS.515@sun.com.

The first field is actually a naming method rather than an operating system name. It just happens that almost a one-to-one correspondence exists between naming methods and operating systems. If there was a common worldwide naming standard, the first field could be a name from that standard, instead of an operating system name.

AUTH_DES Authentication Verifiers

Unlike AUTH_SYS authentication, AUTH_DES authentication does have a verifier so the server can validate the client's credential, and the reverse. The contents of this verifier are primarily an encrypted timestamp. The server can decrypt this timestamp, and if it is close to its current real time, then the client must have encrypted it correctly. The only way the client could encrypt the timestamp correctly is to know the conversation key of the RPC session. If the client knows the conversation key, it must be the real client.

The conversation key is a DES [5] key that the client generates and notifies the server of in its first RPC call. The conversation key is encrypted using a public-key scheme in this first transaction. The particular public-key scheme used in AUTH_DES authentication is Diffie-Hellman [3] with 192-bit keys. The details of this encryption method are described in "Diffie-Hellman Encryption" on page 258.

The client and the server need the same notion of the current time for the verification to work. If network time synchronization cannot be guaranteed, then the client can synchronize with the server before beginning the conversation. `rpcbind` provides a procedure, `RPCBPROC_GETTIME`, which can be used to obtain the current time.

A server can determine if a client timestamp is valid. For any transaction after the first, the server checks for two things:

- The timestamp is greater than the one previously seen from the same client.

- The timestamp has not expired. A timestamp is expired if the server's time is later than the sum of the client's timestamp plus what is known as the client's window. The window is an encrypted number the client passes to the server in its first transaction. The window can be thought of as a lifetime for the credential.

For the first transaction, the server checks that the timestamp has not expired. As an added check, the client sends an encrypted item in the first transaction known as the window verifier. This verifier must be equal to the window minus 1, or the server rejects the credential.

The client must check the verifier returned from the server to be sure it is legitimate. The server sends back to the client the encrypted timestamp it received from the client, minus one second. If the client gets any result other than this one, the verifier is rejected.

Nicknames and Clock Synchronization

After the first transaction, the server's AUTH_DES authentication subsystem returns in its verifier to the client an integer nickname. The client can use this nickname in its further transactions instead of passing its net name, encrypted DES key, and window every time. The nickname is most likely an index into a table on the server that stores for each client its net name, decrypted DES key, and window. It should however be treated as opaque data by the client.

Though originally synchronized, client and server clocks can get out of sync. If this situation occurs, the client RPC subsystem most likely receives an RPC_AUTHERROR at which point it should resynchronize.

A client can still get the RPC_AUTHERROR error even though it is synchronized with the server. The server's nickname table is a limited size, and it can flush entries as needed. The client should resend its original credential and the server gives the client a new nickname. If a server crashes, the entire nickname table is flushed, and all clients have to resend their original credentials.

DES Authentication Protocol (in XDR language)

Credentials are explained in the following example:

EXAMPLE B-2 AUTH_DES Authentication Protocol

```
/*
 * There are two kinds of credentials: one in which the client
 * uses its full network name, and one in which it uses its
 * "nickname" (just an unsigned integer) given to it by the
 * server. The client must use its full name in its first
```

EXAMPLE B-2 AUTH_DES Authentication Protocol (Continued)

```
* transaction with the server, in which the server returns
* to the client its nickname. The client may use its nickname
* in all further transactions with the server. There is no
* requirement to use the nickname, but it is wise to use it for
* performance reasons.
*/
enum authdes_namekind {
    ADN_FULLNAME = 0,
    ADN_NICKNAME = 1
};

/*
 * A 64-bit block of encrypted DES data
 */
typedef opaque des_block[8];

/*
 * Maximum length of a network user's name
 */
const MAXNETNAMELEN = 255;

/*
 * A fullname contains the network name of the client, an
 * encrypted conversation key and the window. The window
 * is actually a lifetime for the credential. If the time
 * indicated in the verifier timestamp plus the window has
 * passed, then the server should expire the request and
 * not grant it. To insure that requests are not replayed,
 * the server should insist that timestamps be greater
 * than the previous one seen, unless it is the first transaction.
 * In the first transaction, the server checks instead that the
 * window verifier is one less than the window.
 */
struct authdes_fullname {
    string name<MAXNETNAMELEN>; /* name of client */
    des_block key; /* PK encrypted conversation key */
    unsigned int window; /* encrypted window */
}; /* NOTE: PK means "public key" */

/*
 * A credential is either a fullname or a nickname
 */
union authdes_credswitch(authdes_namekind adc_namekind) {
    case ADN_FULLNAME:
        authdes_fullname adc_fullname;
    case ADN_NICKNAME:
        unsigned int adc_nickname;
};

/*
 * A timestamp encodes the time since midnight, January 1, 1970.
 */
```

EXAMPLE B-2 AUTH_DES Authentication Protocol (Continued)

```
struct timestamp {
    unsigned int seconds;    /* seconds */
    unsigned int useconds;  /* and microseconds */
};

/*
 * Verifier: client variety
 */
struct authdes_verf_clnt {
    timestamp adv_timestamp; /* encrypted timestamp */
    unsigned int adv_winverf; /* encrypted window verifier */
};

/*
 * Verifier: server variety
 * The server returns (encrypted) the same timestamp the client gave
 * it minus one second. It also tells the client its nickname to be
 * used in future transactions (unencrypted).
 */
struct authdes_verf_svr {
    timestamp adv_timeverf; /* encrypted verifier */
    unsigned int adv_nickname; /* new nickname for clnt */};
```

Diffie-Hellman Encryption

In this scheme are two constants, PROOT and HEXMODULUS. The particular values chosen for these constants for the DES authentication protocol are:

```
const PROOT = 3;
const HEXMODULUS = /* hex */
    "d4a0ba0250b6fd2ec626e7efd637df76c716e22d0944b88b";
```

The way this scheme works is best explained by an example. Suppose there are two people, A and B, who want to send encrypted messages to each other. A and B each generate a random secret key that they do not disclose to anyone. Let these keys be represented as SK(A) and SK(B). They also publish in a public directory their public keys. These keys are computed as follows:

```
PK(A) = (PROOT ** SK(A)) mod HEXMODULUS
PK(B) = (PROOT ** SK(B)) mod HEXMODULUS
```

The ** notation is used here to represent exponentiation.

Now, both A and B can arrive at the common key between them, represented here as CK(A, B), without disclosing their secret keys.

A computes:

```
CK(A, B) = (PK(B) ** SK(A)) mod HEXMODULUS
```

while B computes:

$$CK(A, B) = (PK(A) ** SK(B)) \text{ mod } \text{HEXMODULUS}$$

These two computations can be shown to be equivalent: $(PK(B) ** SK(A)) \text{ mod } \text{HEXMODULUS} = (PK(A) ** SK(B)) \text{ mod } \text{HEXMODULUS}$. Drop the $\text{mod } \text{HEXMODULUS}$ parts and assume modulo arithmetic to simplify the process:

$$PK(B) ** SK(A) = PK(A) ** SK(B)$$

Then replace $PK(B)$ by what B computed earlier and likewise for $PK(A)$.

$$((\text{PROOT} ** SK(B)) ** SK(A)) = (\text{PROOT} ** SK(A)) ** SK(B)$$

which leads to:

$$\text{PROOT} ** (SK(A) * SK(B)) = \text{PROOT} ** (SK(A) * SK(B))$$

This common key $CK(A, B)$ is not used to encrypt the timestamps used in the protocol. It is used only to encrypt a conversation key that is then used to encrypt the timestamps. This approach uses the common key as little as possible, to prevent a break. Breaking the conversation key is a far less serious compromise, because conversations are comparatively short lived.

The conversation key is encrypted using 56-bit DES keys, yet the common key is 192 bits. To reduce the number of bits, 56 bits are selected from the common key as follows. The middle-most 8 bytes are selected from the common key, and then parity is added to the lower-order bit of each byte, producing a 56-bit key with 8 bits of parity.

AUTH_KERB Authentication

To avoid compiling Kerberos code into the operating system kernel, the kernel used in the S implementation of AUTH_KERB uses a proxy RPC daemon called `kerbd`. The daemon exports three procedures.

- `KGETKCRED` is used by the server-side RPC to check the authenticator presented by the client.
- `KSETKCRED` returns the encrypted ticket and DES session key, given a primary name, instance, and realm.
- `KGETUCRED` is UNIX specific. It returns the user's ID, the group ID, and groups list, assuming that the primary name is mapped to a user name known to the server.

The best way to describe how Kerberos works is to use an example based on a service currently implementing Kerberos: the network file system (NFS). The NFS service on server *s* is assumed to have the well-known principal name `nfs.s`. A privileged user on

client *c* is assumed to have the primary name *root* and an instance *c*. Note that, unlike `AUTH_DES`, when the user's ticket-granting ticket has expired, `kinit()` must be reinvoked. NFS service for Kerberos mounts fail until a new ticket-granting ticket is obtained.

NFS Mount Example

This section follows an NFS mount request from start to finish using `AUTH_KERB`. Because mount requests are executed as `root`, the user's identity is `root.c`.

Client *c* makes a `MOUNTPROC_MOUNT` request to the server *s* to obtain the file handle for the directory to be mounted. The client mount program makes an NFS mount system call, handing the client kernel the file handle, mount flavor, time synchronization address, and the server's well-known name, *nfs.s*. Next the client kernel contacts the server at the time synchronization host to obtain the client-server time bias.

The client kernel makes the following RPC calls.

1. `KSETKCREDCRED` to the local `kerbd` to obtain the ticket and session key,
2. `NFSPROC_GETATTR` to the server's NFS service, using the full name credential and verifier. The server receives the calls and makes the `KGETKCREDCRED` call to its local `kerbd` to check the client's ticket.

The server's `kerbd` and the Kerberos library decrypt the ticket and return, among other data, the principal name and DES session key. The server checks that the ticket is still valid, uses the session key to decrypt the DES-encrypted portions of the credential and verifier, and checks that the verifier is valid.

The possible Kerberos authentication errors returned at this time are:

- `AUTH_BADCRED` is returned if the verifier is invalid because the decrypted *win* in the credential and *win + 1* in the verifier do not match, or the timestamp is not within the window range.
- `AUTH_REJECTEDCRED` is returned if a replay is detected.
- `AUTH_BADVERF` is returned if the verifier is garbled.

If no errors are received, the server caches the client's identity and allocates a nickname, which is a small integer, to be returned in the NFS reply. The server then checks if the client is in the same realm as the server. If so, the server calls `KGETUCREDCRED` to its local `kerbd` to translate the principal's primary name into UNIX credentials. If the previous name is not translatable, the user is marked anonymous. The server checks these credentials against the file system's export information. Consider these three cases:

1. If the `KGETUCREDCRED` call fails and anonymous requests are allowed, the UNIX credentials of the anonymous user are assigned.

2. If the KGETUCRED call fails and anonymous requests are not allowed, the NFS call fails with the AUTH_TOOWEAK.
3. If the KGETUCRED call succeeds, the credentials are assigned, and normal protection checking follows, including checking for root permission.

Next, the server sends an NFS reply, including the nickname and server's verifier. The client receives the reply, decrypts and validates the verifier, and stores the nickname for future calls. The client makes a second NFS call to the server, and the calls to the server described previously are repeated. The client kernel makes an NFSPROC_STATVFS call to the server's NFS service, using the nickname credential and verifier described previously. The server receives the call and validates the nickname. If it is out of range, the error AUTH_BADCRED is returned. The server uses the session key just obtained to decrypt the DES-encrypted portions of the verifier and validates the verifier.

The possible Kerberos authentication errors returned at this time are:

- AUTH_REJECTEDVERF, which is returned if the timestamp is invalid, a replay is detected, or if the timestamp is not within the window range
- AUTH_TIMEEXPIRE, which is returned if the service ticket is expired

If no errors are received, the server uses the nickname to retrieve the caller's UNIX credentials. Then it checks these credentials against the file system's export information, and sends an NFS reply that includes the nickname and the server's verifier. The client receives the reply, decrypts and validates the verifier, and stores the nickname for future calls. Last, the client's NFS mount system call returns, and the request is finished.

KERB Authentication Protocol

The following example of AUTH_KERB has many similarities to the one for AUTH_DES, shown in the following code example. Note the differences.

EXAMPLE B-3 AUTH_KERB Authentication Protocol

```
#define AUTH_KERB 4
/*
 * There are two kinds of credentials: one in which the client
 * sends the (previously encrypted)
Kerberos ticket, and one in
 * which it uses its "nickname" (just an unsigned integer)
 * given to it by the server. The client must use its full name
 * in its first transaction with the server, in which the server
 * returns to the client its nickname. The client may use
 * its nickname in all further transactions with the server
 * (until the ticket expires). There is no requirement to use
 * the nickname, but it is wise to use it for performance reasons.
 */
enum authkerb_namekind {
```

EXAMPLE B-3 AUTH_KERB Authentication Protocol (Continued)

```
    AKN_FULLNAME = 0,
    AKN_NICKNAME = 1
};

/*
 * A fullname contains the encrypted service ticket and the
 * window. The window is actually a lifetime
 * for the credential. If the time indicated in the verifier
 * timestamp plus the window has passed, then the server should
 * expire the request and not grant it. To insure that requests
 * are not replayed, the server should insist that timestamps be
 * greater than the previous one seen, unless it is the first
 * transaction. In the first transaction, the server checks
 * instead that the window verifier is one less than the window.
 */
struct authkerb_fullname {
    KTEXT_ST ticket;           /* Kerberos service ticket */
    unsigned long window;     /* encrypted window */
};
/*
 * A credential is either a fullname or a nickname
 */
union authkerb_credswitch(authkerb_namekind akc_namekind){
    case AKN_FULLNAME:
        authkerb_fullname akc_fullname;
    case AKN_NICKNAME:
        unsigned long akc_nickname;
};

/*
 * A timestamp encodes the time since midnight, January 1, 1970.
 */
struct timestamp {
    unsigned long seconds;     /* seconds */
    unsigned long useconds;   /* and microseconds */
};

/*
 * Verifier: client variety
 */
struct authkerb_verf_clnt {
    timestamp akv_timestamp;   /* encrypted timestamp */
    unsigned long akv_winverf; /* encrypted window verifier */
};

/*
 * Verifier: server variety
 * The server returns (encrypted) the same timestamp the client
 * gave it minus one second. It also tells the client its
 * nickname to be used
 * in future transactions (unencrypted).
 */
```

EXAMPLE B-3 AUTH_KERB Authentication Protocol (Continued)

```
*/
struct authkerb_verf_svr {
    timestamp akv_timeverf; /* encrypted verifier */
    unsigned long akv_nickname; /* new nickname for clnt */
};
```

RPC Language Specification

Just as the XDR data types needed to be described in a formal language, the procedures that operate on these XDR data types in a formal language needed to be described. The RPC Language, an extension to the XDR language, serves this purpose. The following example is used to describe the essence of the language.

Example Service Described in the RPC Language

The following code example shows the specification of a simple ping program.

EXAMPLE B-4 ping Service Using RPC Language

```
/*
 * Simple ping program
 */
program PING_PROG {
    version PING_VERS_PINGBACK {
        void
        PINGPROC_NULL(void) = 0;
        /*
         * ping the caller, return the round-trip time
         * in milliseconds. Return a minus one (-1) if
         * operation times-out
         */
        int
        PINGPROC_PINGBACK(void) = 1;
        /* void - above is an argument to the call */
    } = 2;
/*
 * Original version
 */
    version PING_VERS_ORIG {
        void
        PINGPROC_NULL(void) = 0;
    } = 1;
} = 200000;
```

EXAMPLE B-4 ping Service Using RPC Language (Continued)

```
const PING_VERS = 2; /* latest version */
```

The first version described is `PING_VERS_PINGBACK` with two procedures, `PINGPROC_NULL` and `PINGPROC_PINGBACK`.

`PINGPROC_NULL` takes no arguments and returns no results, but it is useful for such things as computing round-trip times from the client to the server and back again. By convention, procedure 0 of any RPC program should have the same semantics, and never require authentication.

The second procedure returns the amount of time in microseconds that the operation used.

The next version, `PING_VERS_ORIG`, is the original version of the protocol and does not contain the `PINGPROC_PINGBACK` procedure. It is useful for compatibility with old client programs.

RPCL Syntax

The RPC language (RPCL) is similar to C. This section describes the syntax of the RPC language, and includes examples. It also shows how RPC and XDR type definitions are compiled into C type definitions in the output header file.

An RPC language file consists of a series of definitions.

```
definition-list:  
  definition;  
  definition; definition-list
```

The file recognizes six types of definitions:

```
definition:  
  enum-definition  
  const-definition  
  typedef-definition  
  struct-definition  
  union-definition  
  program-definition
```

Definitions are not the same as declarations. No space is allocated by a definition, only the type definition of a single or series of data elements. This behavior means that variables still must be declared.

The RPC language is identical to the XDR language, except for the added definitions described in the following table.

TABLE B-2 RPC Language Definitions

Term	Definition
program-definition	program program-ident {version-list} = value
version-list	version; version; version-list
version	version version-ident {procedure-list} = value
procedure-list	procedure; procedure; procedure-list
procedure	type-ident procedure-ident (type-ident) = value

In the RPC language:

- The following keywords are added and cannot be used as identifiers:
program version.
- Neither version name nor a version number can occur more than once within the scope of a program definition.
- Neither a procedure name nor a procedure number can occur more than once within the scope of a version definition.
- Program identifiers are in the same namespace as constant and type identifiers.
- Only unsigned constants can be assigned to programs, versions, and procedures.

RPCL Enumerations

RPC/XDR enumerations have a similar syntax to C enumerations.

```
enum-definition:
    "enum" enum-ident "{"
        enum-value-list
    "}"
enum-value-list:
    enum-value
    enum-value "," enum-value-list
enum-value:
    enum-value-ident
    enum-value-ident "=" value
```

Here is an example of an XDR enum and the C enum to which it gets compiled.

```
enum colortype {
    RED = 0,
    GREEN = 1,
    BLUE = 2
};

enum colortype {
    RED = 0,
    GREEN = 1,
    BLUE = 2,
};
```

```
typedef enum colortype colortype;
```

RPCL Constants

You can use XDR symbolic constants wherever an integer constant is used. A typical use might be in array size specifications:

```
const-definition:  
const const-ident = integer
```

The following example defines a constant, DOZEN, as equal to 12.

```
const DOZEN = 12; --> #define DOZEN 12
```

RPCL Type Definitions

XDR typedefs have the same syntax as C typedefs.

```
typedef-definition:  
typedef declaration
```

This example defines an `fname_type` used for declaring file-name strings that have a maximum length of 255 characters.

```
typedef string fname_type<255>; --> typedef char *fname_type;
```

RPCL Declarations

XDR has four kinds of declarations. These declarations must be a part of a struct or a typedef. They cannot stand alone.

```
declaration:  
  simple-declaration  
  fixed-array-declaration  
  variable-array-declaration  
  pointer-declaration
```

RPCL Simple Declarations

Simple declarations are just like simple C declarations.

```
simple-declaration:  
  type-ident variable-ident
```

Example:

```
colortype color; --> colortype color;
```

RPCL Fixed-Length Array Declarations

Fixed-length array declarations are just like C array declarations.

```
fixed-array-declaration:  
    type-ident variable-ident [value]
```

Example:

```
colortype palette[8]; --> colortype palette[8];
```

Many programmers confuse variable declarations with type declarations. Note that `rpcgen` does not support variable declarations. The following example is a program that does not compile.

```
int data[10];  
program P {  
    version V {  
        int PROC(data) = 1;  
    } = 1;  
} = 0x200000;
```

The previous example does not compile because of the variable declaration:

```
int data[10]
```

Instead use:

```
typedef int data[10];
```

or

```
struct data {int dummy [10]};
```

RPCL Variable-Length Array Declarations

Variable-length array declarations have no explicit syntax in C. The XDR language does have a syntax, using angle brackets:

```
variable-array-declaration:  
    type-ident variable-ident <value>  
    type-ident variable-ident < >
```

The maximum size is specified between the angle brackets. You can omit the size, indicating that the array can be of any size.

```
int heights<12>; /* at most 12 items */  
int widths<>; /* any number of items */
```

Because variable-length arrays have no explicit syntax in C, these declarations are compiled into `struct` declarations. An example is the `heights` declaration compiled into the following `struct`.

```
struct {
    u_int heights_len;           /* # of items in array */
    int *heights_val;          /* pointer to array */
} heights;
```

The number of items in the array is stored in the `_len` component and the pointer to the array is stored in the `_val` component. The first part of each component name is the same as the name of the declared XDR variable, *heights*.

RPCL Pointer Declarations

Pointer declarations are made in XDR exactly as they are in C. Address pointers are not really sent over the network. Instead, XDR pointers are useful for sending recursive data types such as lists and trees. The type is called *optional-data*, not *pointer*, in XDR language.

```
pointer-declaration:
    type-ident *variable-ident
```

Example:

```
listitem *next; --> listitem *next;
```

RPCL Structures

An RPC/XDR `struct` is declared almost exactly like its C counterpart. It looks like the following.

```
struct-definition:
    struct struct-ident "{"
        declaration-list
    "}"

declaration-list:
    declaration ";"
    declaration ";" declaration-list
```

The following XDR structure is an example of a 2-D coordinate and the C structure that it compiles into.

```
struct coord {
    int x;
    int y;
};

--> struct coord {
    int x;
    int y;
};
typedef struct coord coord;
```

The output is identical to the input, except for the added typedef at the end of the output. This typedef enables you to use `coord` instead of `struct coord` when declaring items.

RPCL Unions

XDR unions are discriminated unions, and do not look like C unions. They are more similar to Pascal variant records.

```
union-definition:
    "union" union-ident "switch" "("("simple declaration")" "{"
        case-list
    "}"
case-list:
    "case" value ":" declaration ";"
    "case" value ":" declaration ";" case-list
    "default" ":" declaration ";"
```

The following example is of a type returned as the result of a “read data” operation: if no error occurs, return a block of data. Otherwise, don’t return anything.

```
union read_result switch (int errno) {
    case 0:
        opaque data[1024];
    default:
        void;
};
```

This union compiles into the following:

```
struct read_result {
    int errno;
    union {
        char data[1024];
    } read_result_u;
};
typedef struct read_result read_result;
```

Notice that the union component of the output `struct` has the same name as the type name, except for the trailing `_u`.

RPCL Programs

You declare RPC programs using the following syntax:

```
program-definition:
    "program" program-ident "{"
        version-list
    "}" "=" value;
version-list:
```

```

        version ";"
        version ";" version-list
version:
    "version" version-ident "{"
        procedure-list
    }" "=" value;
procedure-list:
    procedure ";"
    procedure ";" procedure-list
procedure:
    type-ident procedure-ident "(" type-ident ")" "=" value;

```

When the `-N` option is specified, `rpcgen` also recognizes the following syntax.

```

procedure:
    type-ident procedure-ident "(" type-ident-list ")" "=" value;
type-ident-list:
    type-ident
    type-ident "," type-ident-list

```

Example:

```

/*
 * time.x: Get or set the time. Time is represented as seconds
 * since 0:00, January 1, 1970.
 */
program TIMEPROG {
    version TIMEEVERS {
        unsigned int TIMEGET(void) = 1;
        void TIMESET(unsigned) = 2;
    } = 1;
} = 0x20000044;

```

Note that the `void` argument type means that no argument is passed.

The following file compiles into these `#define` statements in the output header file.

```

#define TIMEPROG 0x20000044
#define TIMEEVERS 1
#define TIMEGET 1
#define TIMESET 2

```

RPCL Special Cases

Several exceptions to the RPC language rules follow.

RPCL C-style Mode

The features of the C-style mode of `rpcgen` have implications for the passing of `void` arguments. No arguments need be passed if their value is `void`.

RPCL Booleans

C has no built-in Boolean type. However, the RPC library uses a Boolean type called `bool_t` that is either `TRUE` or `FALSE`. Parameters declared as type `bool` in XDR language are compiled into `bool_t` in the output header file.

Example:

```
bool married; --> bool_t married;
```

RPCL Strings

The C language has no built-in string type, but instead uses the null-terminated `char *` convention. In C, strings are usually treated as null-terminated single-dimensional arrays.

In XDR language, strings are declared using the `string` keyword, and compiled into type `char *` in the output header file. The maximum size contained in the angle brackets specifies the maximum number of characters allowed in the strings, not counting the `NULL` character. You can omit the maximum size, indicating a string of arbitrary length.

Examples:

```
string name<32>; --> char *name;
string longname<>; --> char *longname;
```

`NULL` strings cannot be passed; however, a zero-length string (that is, just the terminator or `NULL` byte) can be passed.

RPCL Opaque Data

Opaque data is used in XDR to describe untyped data, that is, sequences of arbitrary bytes. You can declare opaque data either as a fixed-length or variable-length array.

Examples:

```
opaque diskblock[512]; --> char diskblock[512];
opaque filedata<1024>; --> struct {
    u_int filedata_len;
    char *filedata_val;
} filedata;
```

RPCL Voids

In a void declaration, the variable is not named. The declaration is just `void` and nothing else. Void declarations can only occur in two places: union definitions and program definitions as the argument or result of a remote procedure; for example, no arguments are passed.

rpcbind Protocol

rpcbind maps RPC program and version numbers to universal addresses, thus making dynamic binding of remote programs possible.

rpcbind is bound to a well-known address of each supported transport, and other programs register their dynamically allocated transport addresses with it. rpcbind then makes those addresses publicly available. Universal addresses are string representations of the transport-dependent address. They are defined by the addressing authority of the given transport.

rpcbind also aids in broadcast RPC. RPC programs have different addresses on different machines, so direct broadcasts to all these programs are not possible. rpcbind, however, has a well-known address. So, to broadcast to a given program, the client sends its message to the rpcbind process on the machine it chooses to reach. rpcbind picks up the broadcast and calls the local service specified by the client. When rpcbind gets a reply from the local service, it passes the reply on to the client.

The following code example shows the rpcbind Protocol Specification in RPC Language.

EXAMPLE B-5 rpcbind Protocol Specification in RPC Language

```
/*
 * rpcb_prot.x
 * RPCBIND protocol in rpc language
 */
/*
 * A mapping of (program, version, network ID) to universal
 address
 */
struct rpcb {
    rpcproc_t r_prog;           /* program number */
    rpcvers_t r_vers;          /* version number */
    string r_netid<>;          /* network id */
    string r_addr<>;           /* universal address */
    string r_owner<>;          /* owner of this service */ };
/* A list of mappings */
struct rpcblist {
    rpcb rpcb_map;
    struct rpcblist *rpcb_next;
};

/* Arguments of remote calls */
struct rpcb_rmtcallargs {
    rpcprog_t prog;           /* program number */
    rpcvers_t vers;           /* version number */
    rpcproc_t proc;           /* procedure number */
    opaque args<>;           /* argument */
};

/* Results of the remote call */
```

EXAMPLE B-5 rpcbind Protocol Specification in RPC Language (Continued)

```
struct rpcb_rmtcallres {
    string addr<>;          /* remote universal address */
    opaque results<>;      /* result */
};

/*
 * rpcb_entry contains a merged address of a service on a
 * particular
 * transport, plus associated netconfig information. A list of
 * rpcb_entries is returned by RPCBPROC_GETADDRLIST. See
 * netconfig.h
 * for values used in r_nc_* fields.
 */
struct rpcb_entry {
    string      r_maddr<>;    /* merged address of service */
    string      r_nc_netid<>; /* netid field */
    unsigned int r_nc_semantics; /* semantics of transport */
    string      r_nc_protofmly<>; /* protocol family */
    string      r_nc_proto<>; /* protocol name */
};

/* A list of addresses supported by a service. */
struct rpcb_entry_list {
    rpcb_entry rpcb_entry_map;
    struct rpcb_entry_list *rpcb_entry_next;
};

typedef rpcb_entry_list *rpcb_entry_list_ptr;

/* rpcbind statistics */
const rpcb_highproc_2 = RPCBPROC_CALLIT;
const rpcb_highproc_3 = RPCBPROC_TADDR2UADDR;
const rpcb_highproc_4 = RPCBPROC_GETSTAT;
const RPCBSTAT_HIGHPROC = 13; /* # of procs in rpcbind V4 plus
one */
const RPCBVERS_STAT = 3; /* provide only for rpcbind V2, V3 and
V4 */
const RPCBVERS_4_STAT = 2;
const RPCBVERS_3_STAT = 1;
const RPCBVERS_2_STAT = 0;

/* Link list of all the stats about getport and getaddr */
struct rpcbs_addrlist {
    rpcprog_t prog;
    rpcvers_t vers;
    int success;
    int failure;
    string netid<>;
    struct rpcbs_addrlist *next;
};

/* Link list of all the stats about rmtcall */
struct rpcbs_rmtcalllist {
```

EXAMPLE B-5 rpcbind Protocol Specification in RPC Language (Continued)

```
    rpcprog_t prog;
    rpcvers_t vers;
    rpcproc_t proc;
    int success;
    int failure;
    int indirect; /* whether callit or indirect */
    string netid<>;
    struct rpcbs_rmtcalllist *next;
};

typedef int rpcbs_proc[RPCBSTAT_HIGHPROC];
typedef rpcbs_addrlist *rpcbs_addrlist_ptr;
typedef rpcbs_rmtcalllist *rpcbs_rmtcalllist_ptr;

struct rpcb_stat {
    rpcbs_proc          info;
    int                 setinfo;
    int                 unsetinfo;
    rpcbs_addrlist_ptr addrinfo;
    rpcbs_rmtcalllist_ptr rmtinfo;
};

/*
 * One rpcb_stat structure is returned for each version of rpcbind
 * being monitored.
 */
typedef rpcb_stat rpcb_stat_byvers[RPCBVERS_STAT];
/* rpcbind procedures */
program RPCBPROG {
    version RPCBVERS {
        void
        RPCBPROC_NULL(void) = 0;

        /*
         * Registers the tuple [r_prog, r_vers, r_addr, r_owner,
         * r_netid]. The rpcbind server accepts requests for this
         * procedure on only the loopback transport for security
         * reasons. Returns TRUE if successful, FALSE on failure.
         */
        bool
        RPCBPROC_SET(rpcb) = 1;

        /*
         * Unregisters the tuple [r_prog, r_vers, r_owner, r_netid].
         * If vers is zero, all versions are
         * unregistered. The rpcbind
         * server accepts requests for this procedure on only the
         * loopback transport for security reasons. Returns TRUE if
         * successful, FALSE on failure.
         */
        bool
```

EXAMPLE B-5 rpcbind Protocol Specification in RPC Language (Continued)

```
RPCBPROC_UNSET(rpcb) = 2;

/*
 * Returns the universal address where the triple [r_prog,
 * r_vers, r_netid] is registered. If r_addr specified,
 * return a universal address merged on r_addr. Ignores
 * r_owner. Returns FALSE on failure.
 */
string
RPCBPROC_GETADDR(rpcb) = 3;

/* Returns a list of all mappings. */

rpcblist
RPCBPROC_DUMP(void) = 4;

/*
 * Calls the procedure on the remote machine. If it is not
 * registered, this procedure IS quiet; that is, it DOES NOT
 * return error information.
 */
rpcb_rmtcallres
RPCBPROC_CALLIT(rpcb_rmtcallargs) = 5;

/*
 * Returns the time on the rpcbind server's system.
 */
unsigned int
RPCBPROC_GETTIME(void) = 6;

struct netbuf
RPCBPROC_UADDR2TADDR(string) = 7;

string
RPCBPROC_TADDR2UADDR(struct netbuf) = 8;

} = 3;
version RPCBVERS4 {
bool
RPCBPROC_SET(rpcb) = 1;

bool
RPCBPROC_UNSET(rpcb) = 2;

string
RPCBPROC_GETADDR(rpcb) = 3;

rpcblist_ptr
RPCBPROC_DUMP(void) = 4;
```

EXAMPLE B-5 rpcbind Protocol Specification in RPC Language (Continued)

```
/*
 * NOTE: RPCBPROC_BCAST has the same functionality as CALLIT;
 * the new name is
intended to indicate that this procedure
 * should be used for broadcast RPC, and RPCBPROC_INDIRECT
 * should be used for indirect calls.
 */
rpcb_rmtcallres
RPCBPROC_BCAST(rpcb_rmtcallargs) = RPCBPROC_CALLIT;

unsigned int
RPCBPROC_GETTIME(void) = 6;

struct netbuf
RPCBPROC_UADDR2TADDR(string) = 7;

string
RPCBPROC_TADDR2UADDR(struct netbuf) = 8;

/*
 * Same as RPCBPROC_GETADDR except that if the given version
 * number is not available, the address is not returned.
 */
string
RPCBPROC_GETVERSADDR(rpcb) = 9;

/*
 * Calls the procedure on the remote machine. If it is not
 * registered, this procedure IS NOT quiet; that is, it DOES
 * return error information.
 */
rpcb_rmtcallres
RPCBPROC_INDIRECT(rpcb_rmtcallargs) = 10;

/*
 * Same as RPCBPROC_GETADDR except that it returns a list of
 * addresses registered for the combination (prog, vers).
 */
rpcb_entry_list_ptr
RPCBPROC_GETADDRLIST(rpcb) = 11;

/*
 * Returns statistics about the rpcbind server's activity.
 */
rpcb_stat_byvers
```

EXAMPLE B-5 rpcbind Protocol Specification in RPC Language (Continued)

```
        RPCBPROC_GETSTAT(void) = 12;  
    } = 4;  
} = 100000;
```

rpcbind Operation

rpcbind is contacted by way of an assigned address specific to the transport being used. For TCP/IP and UDP/IP, for example, it is port number 111. Each transport has such an assigned well-known address. This section describes a description of each of the procedures supported by rpcbind.

RPCBPROC_NULL	This procedure does no work. By convention, procedure zero of any program takes no parameters and returns no results.
RPCBPROC_SET	<p>When a program first becomes available on a machine, it registers itself with the rpcbind program running on the same machine. The program passes its program number <i>prog</i>, version number <i>vers</i>, network identifier <i>netid</i>, and the universal address <i>uaddr</i>; on which it awaits service requests.</p> <p>The procedure returns a Boolean response with the value TRUE if the procedure successfully established the mapping and FALSE otherwise. The procedure refuses to establish a mapping if one already exists for the ordered set (<i>prog</i>, <i>vers</i>, <i>netid</i>).</p> <p>Neither <i>netid</i> nor <i>uaddr</i> can be NULL, and that <i>netid</i> should be a valid network identifier on the machine making the call.</p>
RPCBPROC_UNSET	<p>When a program becomes unavailable, it should unregister itself with the rpcbind program on the same machine.</p> <p>The parameters and results have meanings identical to those of RPCBPROC_SET. The mapping of the (<i>prog</i>, <i>vers</i>, <i>netid</i>) tuple with <i>uaddr</i> is deleted.</p> <p>If <i>netid</i> is NULL, all mappings specified by the ordered set (<i>prog</i>, <i>vers</i>, *) and the corresponding universal addresses are deleted. Only the owner of the service or the superuser is allowed to unset a service.</p>

RPCBPROC_GETADDR	<p>Given a program number <i>prog</i>, version number <i>vers</i>, and network identifier <i>netid</i>, this procedure returns the universal address on which the program is awaiting call requests.</p> <p>The <i>netid</i> field of the argument is ignored and the <i>netid</i> is inferred from the <i>netid</i> of the transport on which the request came in.</p>
RPCBPROC_DUMP	<p>This procedure lists all entries in <code>rpcbind</code>'s database.</p> <p>The procedure takes no parameters and returns a list of program, version, <i>netid</i>, and universal addresses. Call this procedure using a stream rather than a datagram transport to avoid the return of a large amount of data.</p>
RPCBPROC_CALLIT	<p>This procedure enables a caller to call another remote procedure on the same machine without knowing the remote procedure's universal address.</p> <p><code>RPCBPROC_CALLIT</code> support broadcasts to arbitrary remote programs through <code>rpcbind</code>'s universal address.</p> <p>The parameters <i>prog</i>, <i>vers</i>, <i>proc</i>, and the <i>args_ptr</i> are the program number, version number, procedure number, and parameters of the remote procedure.</p> <p>This procedure sends a response only if the procedure was successfully executed, and is silent (no response) otherwise.</p> <p>The procedure returns the remote program's universal address, and the results of the remote procedure.</p>
RPCBPROC_GETTIME	<p>This procedure returns the local time on its own machine in seconds since midnight of January 1, 1970.</p>
RPCBPROC_UADDR2TADDR	<p>This procedure converts universal addresses to transport (<code>netbuf</code>) addresses.</p> <p><code>RPCBPROC_UADDR2TADDR</code> is equivalent to <code>uaddr2taddr()</code>. See the <code>netdir(3NSL)</code> man page. Only processes that cannot link to the name-to-address library modules should use <code>RPCBPROC_UADDR2TADDR</code>.</p>
RPCBPROC_TADDR2UADDR	<p>This procedure converts transport (<code>netbuf</code>) addresses to universal addresses. <code>RPCBPROC_TADDR2UADDR</code> is equivalent to <code>taddr2uaddr()</code>. See the <code>netdir(3NSL)</code></p>

	man page. Only processes that cannot link to the name-to-address library modules should use <code>RPCBPROC_TADDR2UADDR</code> .
Version 4 <code>rpcbind</code>	Version 4 of the <code>rpcbind</code> protocol includes all of the previous procedures, and adds several others.
<code>RPCBPROC_BCAST</code>	This procedure is identical to the version 3 <code>RPCBPROC_CALLIT</code> procedure. The new name indicates that the procedure should be used for broadcast RPCs only. <code>RPCBPROC_INDIRECT</code> , defined in the following text, should be used for indirect RPC calls.
<code>RPCBPROC_GETVERSADDR</code>	This procedure is similar to <code>RPCBPROC_GETADDR</code> . The difference is that the <code>r_vers</code> field of the <code>rpcb</code> structure can be used to specify the version of interest. If that version is not registered, no address is returned.
<code>RPCBPROC_INDIRECT</code>	This procedure is similar to <code>RPCBPROC_CALLIT</code> . Instead of being silent about errors, such as the program not being registered on the system, this procedure returns an indication of the error. Do not use this procedure for broadcast RPC. Use it with indirect RPC calls only.
<code>RPCBPROC_GETADDRLIST</code>	This procedure returns a list of addresses for the given <code>rpcb</code> entry. The client might be able to use the results to determine alternate transports that it can use to communicate with the server.
<code>RPCBPROC_GETSTAT</code>	This procedure returns statistics on the activity of the <code>rpcbind</code> server. The information lists the number and kind of requests the server has received.

All procedures except `RPCBPROC_SET` and `RPCBPROC_UNSET` can be called by clients running on a machine other than a machine on which `rpcbind` is running. `rpcbind` accepts only `RPCPROC_SET` and `RPCPROC_UNSET` requests on the loopback transport.

XDR Protocol Specification

This appendix contains the XDR Protocol Language Specification. It covers the following topics:

- “XDR Protocol Introduction” on page 281
- “XDR Data Type Declarations” on page 282
- “XDR Language Specification” on page 295

XDR Protocol Introduction

External data representation (XDR) is a standard for the description and encoding of data. The XDR protocol is useful for transferring data between different computer architectures and has been used to communicate data between very diverse machines. XDR fits into the ISO reference model’s presentation layer (layer 6) and is roughly analogous in purpose to X.409, ISO Abstract Syntax Notation. The major difference between the two is that XDR uses implicit typing, while X.409 uses explicit typing.

XDR uses a language to describe data formats and can only be used to describe data. It is not a programming language. This language enables you to describe intricate data formats in a concise manner. The XDR language is similar to the C language. Protocols such as RPC and NFS use XDR to describe the format of their data.

The XDR standard assumes that bytes, or octets, are portable and that a byte is defined to be 8 bits of data.

Graphic Box Notation

This appendix uses graphic box notation for illustration and comparison. In most illustrations, each box depicts a byte. The representation of all items requires a multiple of 4 bytes (or 32 bits) of data. The bytes are numbered 0 through $n - 1$. The

bytes are read or written to some byte stream such that byte m always precedes byte $m+1$. The n bytes are followed by enough (0 to 3) residual zero bytes, r , to make the total byte count a multiple of four. Ellipses (. . .) between boxes show zero or more additional bytes where required, as shown in the following illustration.

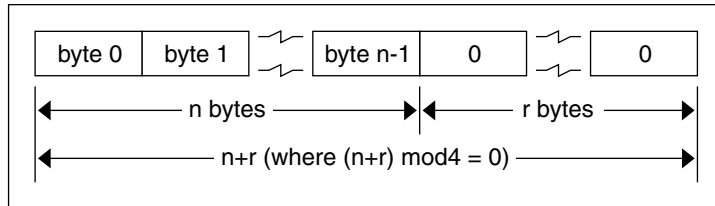

Basic Block Size

Choosing the XDR block size requires a tradeoff. Choosing a small size such as 2 makes the encoded data small, but causes alignment problems for machines that are not aligned on these boundaries. A large size such as 8 means the data is aligned on virtually every machine, but causes the encoded data to grow too large. Four was chosen as a compromise. Four is big enough to support most architectures efficiently.

This basic block size of 4 does not mean that the computers cannot utilize standard XDR, just that they do so at a greater overhead per data item than 4-byte (32-bit) architectures. Four is also small enough to keep the encoded data restricted to a reasonable size.

The same data should encode into an equivalent result on all machines so that encoded data can be compared or checksummed. So, variable-length data must be padded with trailing zeros.

XDR Data Type Declarations

Each of the sections that follow:

- Describes a data type defined in the XDR standard
- Shows how that data type is declared in the language
- Includes a graphic illustration of the encoding

For each data type in the language a general paradigm declaration is shown. Note that angle brackets (< and >) denote variable-length sequences of data and square brackets ([and]) denote fixed-length sequences of data. n , m , and r denote integers. For the full language specification, refer to "XDR Language Specification" on page 295.

Some data types include specific examples. A more extensive example is given in the section “XDR Data Description” on page 298.

Signed Integer

An XDR signed integer is a 32-bit datum that encodes an integer in the range $[-2147483648, 2147483647]$. The integer is represented in two’s complement notation; the most and least significant bytes are 0 and 3, respectively.

Declaration

Integers are declared:

```
int identifier;
```

Signed Integer Encoding

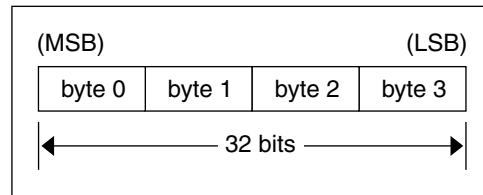

Unsigned Integer

An XDR unsigned integer is a 32-bit datum that encodes a nonnegative integer in the range $[0, 4294967295]$. The integer is represented by an unsigned binary number that has most- and least-significant bytes of 0 and 3 respectively.

Declaration

An unsigned integer is declared as follows.

```
unsigned int identifier;
```

Unsigned Integer Encoding

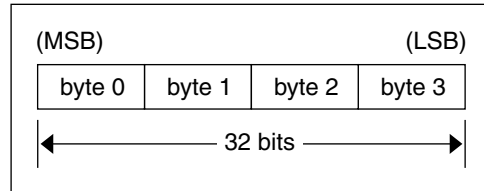

Enumerations

Enumerations have the same representation as signed integers and are handy for describing subsets of the integers. The encoding for enumerations is the same as shown in “Signed Integer Encoding” on page 283.

Enumerated data is declared as follows.

```
enum {name-identifier = constant, ... } identifier;
```

For example, an enumerated type could represent the three colors red, yellow, and blue as follows.

```
enum {RED = 2, YELLOW = 3, BLUE = 5} colors;
```

Do not assign to an enum an integer that has not been assigned in the enum declaration.

Booleans

Booleans are important enough and occur frequently enough to warrant their own explicit type in the standard. Booleans are integers of value 0 or 1. The encoding for Booleans is the same as show in “Signed Integer Encoding” on page 283.

Booleans are declared as follows.

```
bool identifier;
```

This is equivalent to:

```
enum {FALSE = 0, TRUE = 1} identifier;
```

Hyper Integer and Unsigned Hyper Integer

The standard defines 64-bit (8-byte) numbers called hyper int and unsigned hyper int with representations that are the obvious extensions of integer and unsigned integer, defined previously. They are represented in two's complement notation; the most-significant and least-significant bytes are 0 and 7, respectively.

Declaration

Hyper integers are declared as follows.

```
hyper int identifier;  
unsigned hyper int identifier;
```

Hyper Integer Encoding

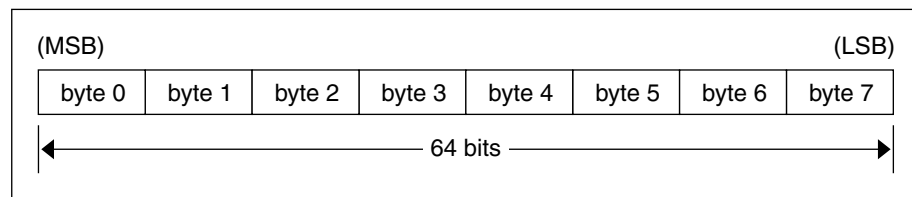

Floating Point

The standard defines the floating-point data type float (32 bits or 4 bytes). The encoding used is the IEEE standard for normalized single-precision floating-point numbers [1]. The following three fields describe the single-precision floating-point number:

S: The sign of the number. Values 0 and 1 represent positive and negative respectively. One bit.

E: The exponent of the number, base 2. Eight bits are in this field. The exponent is biased by 127.

F: The fractional part of the number's mantissa, base 2. Twenty-three bits are in this field.

Therefore, the floating-point number is described by.

$$(-1)^{S} * 2^{(E-Bias)} * 1.F$$

Declaration

Single-precision floating-point data is declared as follows.

```
float identifier;
```

Double-precision floating-point data is declared as follows.

```
double identifier;
```

Double-Precision Floating Point Encoding

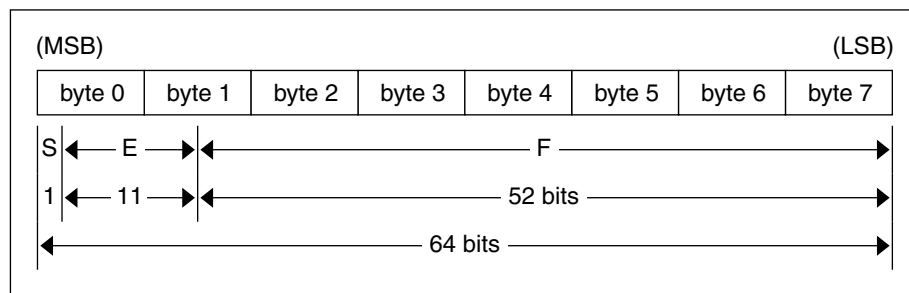

Just as the most and least significant bytes of an integer are 0 and 3, the most-significant and least-significant bits of a double-precision floating-point number are 0 and 63. The beginning bit, and most significant bit, offsets of S, E, and F are 0, 1, and 12 respectively.

These offsets refer to the logical positions of the bits, not to their physical locations, which vary from medium to medium.

Consult the IEEE specifications about the encoding for signed zero, signed infinity (overflow), and de-normalized numbers (underflow) [1]. According to IEEE specifications, the NaN (not a number) is system dependent and should not be used externally.

Quadruple-Precision Floating Point

The standard defines the encoding for the quadruple-precision floating-point data type quadruple (128 bits or 16 bytes). The encoding used is the IEEE standard for normalized quadruple-precision floating-point numbers [1]. The standard encodes the following three fields, which describe the quadruple-precision floating-point number.

S: The sign of the number. Values 0 and 1 represent positive and negative respectively. One bit.

E: The exponent of the number, base 2. Fifteen bits are in this field. The exponent is biased by 16383.

F: The fractional part of the number's mantissa, base 2. One hundred eleven bits are in this field.

Therefore, the floating-point number is described by:

$$(-1)^{S} * 2^{(E-Bias)} * 1.F$$

Declaration

```
quadruple identifier;
```

Quadruple-Precision Floating Point Encoding

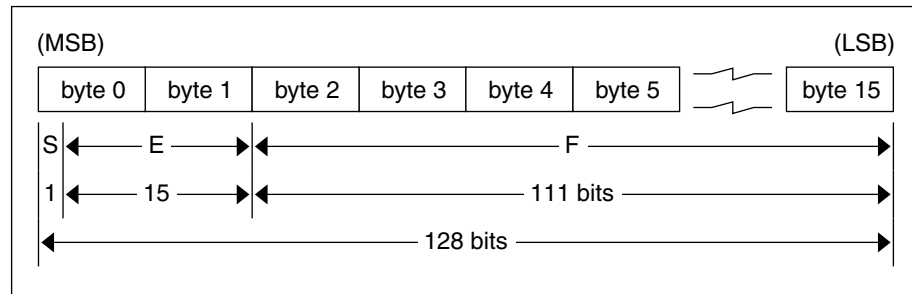

Just as the most-significant and least-significant bytes of an integer are 0 and 3, the most-significant and least-significant bits of a quadruple-precision floating-point number are 0 and 127. The beginning bit, and most-significant bit, offsets of S, E, and F are 0, 1, and 16 respectively. These offsets refer to the logical positions of the bits, not to their physical locations, which vary from medium to medium.

Consult the IEEE specifications about the encoding for signed zero, signed infinity (overflow), and de-normalized numbers (underflow) [1]. According to IEEE specifications, the NaN (not a number) is system dependent and should not be used externally.

Fixed-Length Opaque Data

At times, fixed-length uninterpreted data needs to be passed among machines. This data is called opaque.

Declaration

Opaque data is declared as follows.

```
opaque identifier[n];
```

In this declaration, the constant n is the static number of bytes necessary to contain the opaque data. The n bytes are followed by enough (0 to 3) residual zero bytes r to make the total byte count of the opaque object a multiple of four.

Fixed-Length Opaque Encoding

The n bytes are followed by enough (0 to 3) residual zero bytes r to make the total byte count of the opaque object a multiple of four.

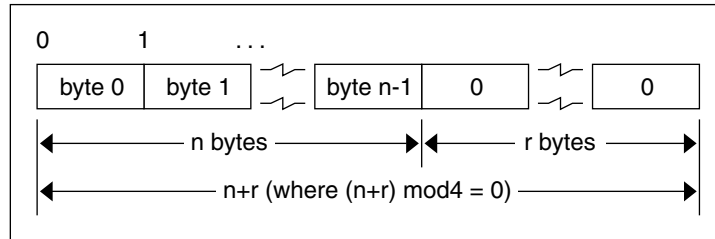

Variable-Length Opaque Data

The standard also provides for variable-length counted opaque data. Such data is defined as a sequence of n (numbered 0 through $n-1$) arbitrary bytes to be the number n encoded as an unsigned integer, as described subsequently, and followed by the n bytes of the sequence.

Byte b of the sequence always precedes byte $b+1$ of the sequence, and byte 0 of the sequence always follows the sequence's length. The n bytes are followed by enough (0 to 3) residual zero bytes, r , to make the total byte count a multiple of four.

Declaration

Variable-length opaque data is declared in the following way.

```
opaque identifier<m>;
```

or

```
opaque identifier<>;
```

The constant m denotes an upper bound of the number of bytes that the sequence can contain. If m is not specified, as in the second declaration, it is assumed to be $(2^{**32}) - 1$, the maximum length. For example, a filing protocol might state that the maximum data transfer size is 8192 bytes, as follows.

```
opaque filedata<8192>;
```

Variable-Length Opaque Encoding

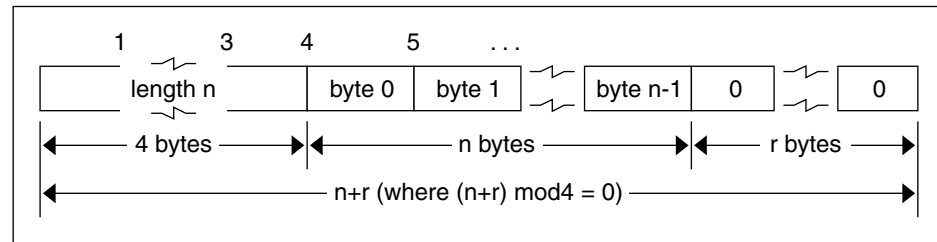

Do not encode a length greater than the maximum described in the specification.

Counted Byte Strings

The standard defines a string of n (numbered 0 through $n-1$) ASCII bytes to be the number n encoded as an unsigned integer, as described previously, and followed by the n bytes of the string. Byte b of the string always precedes byte $b+1$ of the string, and byte 0 of the string always follows the string's length. The n bytes are followed by enough (0 to 3) residual zero bytes r to make the total byte count a multiple of four.

Declaration

Counted byte strings are declared as follows.

```
string object<m>;
```

or

```
string object<>;
```

The constant m denotes an upper bound of the number of bytes that a string can contain. If m is not specified, as in the second declaration, it is assumed to be $(2^{**32}) - 1$, the maximum length. The constant m would normally be found in a protocol specification. For example, a filing protocol might state that a file name can be no longer than 255 bytes, as follows.

```
string filename<255>;
```

String Encoding

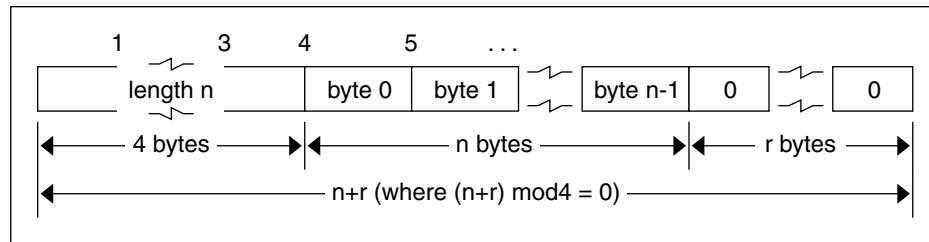

Do not encode a length greater than the maximum described in the specification.

Fixed-Length Array

Fixed-length arrays of elements numbered 0 through $n-1$ are encoded by individually encoding the elements of the array in their natural order, 0 through $n-1$. Each element's size is a multiple of 4 bytes. Though all elements are of the same type, the elements might have different sizes. For example, in a fixed-length array of strings, all elements are of type string, yet each element varies in its length.

Declaration

Declarations for fixed-length arrays of homogenous elements are in the following form.

```
type-name identifier[n];
```

Fixed-Length Array Encoding

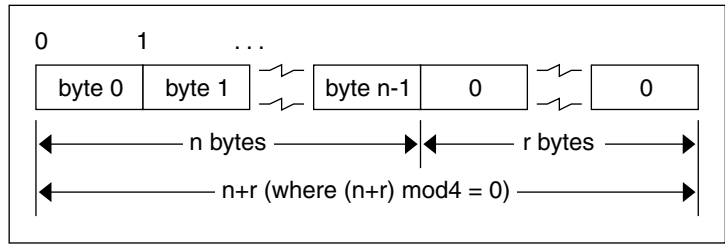

Variable-Length Array

Counted arrays enable variable-length arrays to be encoded as homogeneous elements. The element count n , an unsigned integer, is followed by each array element, starting with element 0 and progressing through element $n-1$.

Declaration

The declaration for variable-length arrays follows this form.

```
type-name identifier<m>;
```

or

```
type-name identifier<>;
```

The constant m specifies the maximum acceptable element count of an array. If m is not specified, it is assumed to be $(2^{32}) - 1$.

Counted Array Encoding

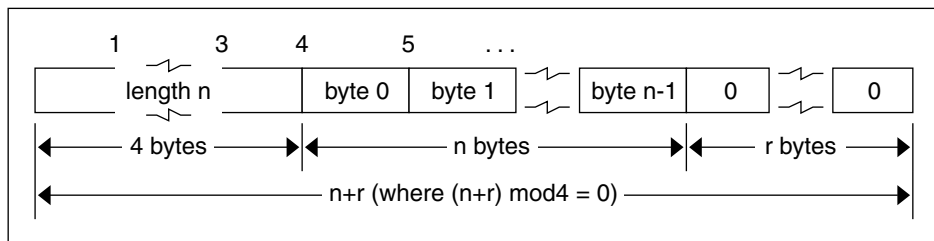

Do not encode a length greater than the maximum described in the specification.

Structure

The components of the structure are encoded in the order of their declaration in the structure. Each component's size is a multiple of 4 bytes, though the components might be different sizes.

Declaration

Structures are declared as follows.

```
struct {  
    component-declaration-A;  
    component-declaration-B;  
    ...  
} identifier;
```

Structure Encoding

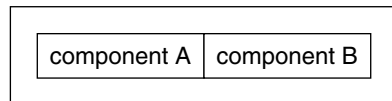

Discriminated Union

A discriminated union is a type composed of a discriminant followed by a type selected from a set of prearranged types according to the value of the discriminant. The type of discriminant is either int, unsigned int, or an enumerated type, such as bool. The component types are called "arms" of the union, and are preceded by the value of the discriminant that implies their encoding.

Declaration

Discriminated unions are declared as follows.

```
union switch (discriminant-declaration) {  
    case discriminant-value-A:  
        arm-declaration-A;  
    case discriminant-value-B:  
        arm-declaration-B;  
    ...  
    default:  
        default-declaration;
```

```
} identifier;
```

Each `case` keyword is followed by a legal value of the discriminant. The default arm is optional. If the arm is not specified, then a valid encoding of the union cannot take on unspecified discriminant values. The size of the implied arm is always a multiple of 4 bytes.

The discriminated union is encoded as its discriminant followed by the encoding of the implied arm.

Discriminated Union Encoding

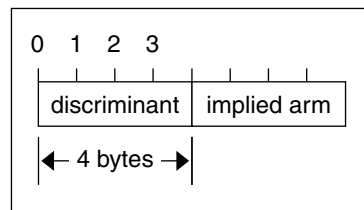

Void

An XDR void is a 0-byte quantity. Voids are useful for describing operations that take no data as input or no data as output. They are also useful in unions, in which some arms might contain data and others do not.

Declaration

The declaration is simply as follows.

```
void;
```

Constant

`const` is used to define a symbolic name for a constant. It does not declare any data. The symbolic constant can be used anywhere a regular constant can be used.

The following example defines a symbolic constant `DOZEN`, equal to 12.

```
const DOZEN = 12;
```

Declaration

The declaration of a constant follows this form.

```
const name-identifier = n;
```

Typedef

Typedef does not declare any data either, but serves to define new identifiers for declaring data. The syntax is:

```
typedef declaration;
```

The new type name is actually the variable name in the declaration part of the typedef. The following example defines a new type called `eggbox` using an existing type called `egg` and the symbolic constant `DOZEN`.

```
typedef egg eggbox[DOZEN];
```

Variables declared using the new type name have the same type as the new type name would have in the typedef, if it were considered a variable. For example, the following two declarations are equivalent in declaring the variable *fresheggs*:

```
eggbox fresheggs;  
egg fresheggs[DOZEN];
```

When a typedef involves a struct, enum, or union definition, you can use another (preferred) syntax to define the same type. In general, a typedef of the following form:

```
typedef <<struct, union, or enum definition>> identifier;
```

can be converted to the alternative form by removing the typedef part and placing the identifier after the struct, enum, or union keyword instead of at the end. For example, here are the two ways to define the type `bool`.

```
typedef enum { /* using typedef */  
    FALSE = 0,  
    TRUE = 1  
} bool;  
enum bool { /* preferred alternative */  
    FALSE = 0,  
    TRUE = 1  
};
```

This syntax is preferred because you do not have to go to the end of a declaration to learn the name of the new type.

Optional-Data

The optional-data union occurs so frequently that it is given a special syntax of its own for declaring it. It is declared as follows.

```
type-name *identifier;
```

This syntax is equivalent to the following union:

```
union switch (bool opted) {  
    case TRUE:  
        type-name element;  
    case FALSE:  
        void;  
} identifier;
```

The optional-data syntax is also equivalent to the following variable-length array declaration, because the Boolean `opted` can be interpreted as the length of the array.

```
type-name identifier<1>;
```

Optional data is useful for describing recursive data-structures, such as linked lists and trees.

XDR Language Specification

This section contains the XDR language specification.

Notational Conventions

This specification uses a modified Backus-Naur Form notation for describing the XDR language. Here is a brief description of the notation:

- The characters `|`, `(`, `)`, `[`, `]`, and `*` are special.
- Terminal symbols are strings of any characters embedded in quotes (`"`).
- Nonterminal symbols are strings of nonspecial italic characters.
- Alternative items are separated by a vertical bar (`|`).
- Optional items are enclosed in brackets.
- Items are grouped by enclosing them in parentheses.
- A `*` following an item means 0 or more occurrences of the item.

For example, consider the following pattern:

```
"a " "very" (" " "very")* [" cold " "and"] " rainy "  
    ("day" | "night")
```

An infinite number of strings match this pattern. A few of them are:

```
a very rainy day  
a very, very rainy day  
a very cold and rainy day
```

a very, very, very cold and rainy night

Lexical Notes

The following conventions are used in the specification.

- Comments begin with `/*` and end with `*/`.
- White space serves to separate items and is otherwise ignored.
- An identifier is a letter followed by an optional sequence of letters, digits, or underbars (`_`). The case of identifiers is not ignored.
- A constant is a sequence of one or more decimal digits, optionally preceded by a minus sign (`-`), as seen in the following code example.

EXAMPLE C-1 XDR Specification

Syntax Information

declaration:

```
type-specifier identifier
| type-specifier identifier "[" value "]"
| type-specifier identifier "<" [ value ] ">"
| "opaque" identifier "[" value "]"
| "opaque" identifier "<" [ value ] ">"
| "string" identifier "<" [ value ] ">"
| type-specifier "*" identifier
| "void"
```

value:

```
constant
| identifier
```

type-specifier:

```
[ "unsigned" ] "int"
| [ "unsigned" ] "hyper"
| "float"
| "double"
| "quadruple"
| "bool"
| enum-type-spec
| struct-type-spec
| union-type-spec
| identifier
```

enum-type-spec:

```
"enum" enum-body
```

enum-body:

```
"{"
( identifier "=" value )
( "," identifier "=" value ) *
"}"
```

EXAMPLE C-1 XDR Specification (Continued)

```
struct-type-spec:
    "struct" struct-body

struct-body:
    "{"
    ( declaration ";" )
    ( declaration ";" )*
    "}"

union-type-spec:
    "union" union-body

union-body:
    "switch" "(" declaration ")" "{"
    ( "case" value ":" declaration ";" )
    ( "case" value ":" declaration ";" )*
    [ "default" ":" declaration ";" ]
    "}"

constant-def:
    "const" identifier "=" constant ";"

type-def:
    "typedef" declaration ";"
    | "enum" identifier enum-body ";"
    | "struct" identifier struct-body ";"
    | "union" identifier union-body ";"

definition:
    type-def
    | constant-def

specification:
    definition *
```

Syntax Notes

The following are keywords and cannot be used as identifiers:

bool	enum	string
cas	float	struct
chas	hyper	switch
const	int	typedef
default	opaque	union
double	quadruple	unassigned
		void

Only unsigned constants can be used as size specifications for arrays. If an identifier is used, it must have been declared previously as an unsigned constant in a const definition.

Constant and type identifiers within the scope of a specification are in the same namespace and must be declared uniquely within this scope.

Similarly, variable names must be unique within the scope of struct and union declarations. Nested struct and union declarations create new scopes.

The discriminant of a union must be of a type that evaluates to an integer. That is, it must be an int, an unsigned int, a bool, an enum type, or any typedef that evaluates to one of these. Also, the case values must be legal discriminant values. Finally, a case value cannot be specified more than once within the scope of a union declaration.

XDR Data Description

The following example is a short XDR data description of a file data structure that might be used to transfer files from one machine to another.

EXAMPLE C-2 XDR File Data Structure

```
const MAXUSERNAME = 32; /* max length of a user name */
const MAXFILELEN = 65535; /* max length of a file */
const MAXNAMELEN = 255; /* max length of a file name */

/* Types of files: */
enum filekind {
    TEXT = 0, /* ascii data */
    DATA = 1, /* raw data */
    EXEC = 2 /* executable */
};

/* File information, per kind of file: */
union filetype switch (filekind kind) {
    case TEXT:
        void; /* no extra information */
    case DATA:
        string creator<MAXNAMELEN>; /* data creator */
    case EXEC:
        string interpreter<MAXNAMELEN>; /*proginterp*/
};

/* A complete file: */
struct file {
    string filename<MAXNAMELEN>; /* name of file */
    filetype type; /* info about file */
    string owner<MAXUSERNAME>; /* owner of file */
    opaque data<MAXFILELEN>; /* file data */
};
```

Suppose now that a user named `linda` wants to store her LISP program `sillyprog` that contains just the data "quit." Her file would be encoded as listed in the following table.

TABLE C-1 XDR Data Description Example

Offset	Hex Bytes	ASCII	Description
0	00 00 00 09	-	Length of file name = 9
4	73 69 6c 6c	sill	File name characters
8	79 70 72 6f	ypro	More characters
12	67 00 00 00	g	3 zero-bytes of fill
16	00 00 00 02	-	Filekind is EXEC = 2
20	00 00 00 04	-	Length of interpreter = 4
24	6c 69 73 70	lisp	Interpreter characters
28	00 00 00 04	-	Length of owner = 4
32	6a 6f 68 6e	linda	Owner characters
36	00 00 00 06	-	Length of file data = 6
40	28 71 75 69	(qu	File data bytes
44	74 29 00 00	t)	2 zero-bytes of fill

RPC Language Reference

The RPC language is an extension of the XDR language. The sole extension is the addition of the program and version types.

For a description of the RPC extensions to the XDR language, see Appendix B.

RPC Code Examples

This appendix contains copies of the complete live code modules used in the `rpcgen` and RPC chapters of this book. They are compilable as they are written and will run, unless otherwise noted to be pseudo-code or the like. These examples are provided for informational purposes only. Sun Microsystems assumes no liability from their use.

Directory Listing Program and Support Routines (`rpcgen`)

EXAMPLE D-1 `rpcgen` Program: `dir.x`

```
/*
 *   dir.x: Remote directory listing
 *   protocol
 *
 *   This source module is a rpcgen source module
 *   used to demonstrate the functions of the rpcgen
 *   tool.
 *
 *   It is compiled with the rpcgen -h -T switches to
 *   generate both the header (.h) file and the
 *   accompanying data structures.
 */
const MAXNAMELEN = 255;    /*maxlengthofadirectoryentry*/

typedef string nametype<MAXNAMELEN>; /* directory entry */
typedef struct namenode *namelist;  /*linkinthelisting*/
/*
 * A node in the directory listing
 */
struct namenode {
```

EXAMPLE D-1 rpcgen Program: dir.x (Continued)

```
        nametype name;          /* name of directory entry */
        namelist next;          /* next entry */
    };

/*
 * The result of a READDIR operation:
 * a truly portable application would use an agreed upon list of
 * error codes rather than, as this sample program does, rely
upon
 * passing UNIX errno's back. In this example the union is used
to
 * discriminate between successful and unsuccessful remote
calls.
 */
union readdir_res switch (int errno) {
    case 0:
        namelist list; /*no error: return directory listing*/
    default:
        void;          /*error occurred: nothing else to return*/
};

/*
 * The directory program definition
 */
program DIRPROG {
    version DIRVERS {
        readdir_res
        READDIR(nametype) = 1;
    } = 1;
} = 0x20000076;
```

EXAMPLE D-2 Remote dir_proc.c

```
/*
 * dir_proc.c: remote readdir implementation
 */
#include <rpc/rpc.h>          /* Always needed */
#include <dirent.h>
#include "dir.h"             /* Created by rpcgen */

extern int errno;
extern char *malloc();
extern char *strdup();

/* ARGSUSED1*/
readdir_res *
readdir_1(dirname, req)
    nametype *dirname;
    struct svc_req *req;
{
    DIR *dirp;
    struct dirent *d;
```

EXAMPLE D-2 Remote dir_proc.c (Continued)

```

    namelist nlp;
    namelist *nlp;
    static readdir_res res; /* must be static! */

    /*
     * Open directory
     */
    dirp = opendir(*dirname);
    if (dirp == (DIR *)NULL) {
        res.errno = errno;
        return (&res);
    }
    /*
     * Free previous result
     */
    xdr_free(xdr_readdir_res, &res);
    /*
     * Collect directory entries. Memory allocated here is freed
    by
     * xdr_free the next time readdir_1 is called.
     */

    nlp = &res.readdir_res_u.list;
    while (d = readdir(dirp)) {
        nlp = *nlp = (namenode *) malloc(sizeof(namenode));
        if (nlp == (namenode *) NULL) {
            res.errno = EAGAIN;
            closedir(dirp);
            return(&res);
        }
        nlp->name = strdup(d->d_name);
        nlp = &nlp->next;
    }
    *nlp = (namelist)NULL;
    /* Return the result */
    res.errno = 0;
    closedir(dirp);
    return (&res);
}

```

EXAMPLE D-3 rls.c Client

```

/*
 * rls.c: Remote directory listing client
 */

#include <stdio.h>
#include <rpc/rpc.h> /* always need this */
#include "dir.h" /* generated by rpcgen */

extern int errno;

```

EXAMPLE D-3 rls.c Client (Continued)

```
main(argc, argv)
    int argc;
    char *argv[];
{
    CLIENT *cl;
    char *server;
    char *dir;
    readdir_res *result;
    namelist nl;

    if (argc != 3) {
        fprintf(stderr, "usage: %s host directory\n",
            argv[0]);
        exit(1);
    }
    server = argv[1];
    dir = argv[2];
/*
 * Create client "handle" used for calling MESSAGEPROG on the
server
 * designated on the command line.
 */
    cl = clnt_create(server, DIRPROG, DIRVERS, "visible");
    if (cl == (CLIENT *)NULL) {
        clnt_pcreateerror(server);
        exit(1);
    }

    result = readdir_1(&dir, cl);
    if (result == (readdir_res *)NULL) {
        clnt_perror(cl, server);
        exit(1);
    }

/* Okay, we successfully called the remote procedure. */

    if (result->errno != 0) {
/*
 * A remote system error occurred. Print error message and
die.
 */
    }
    if (result->errno < sys_nerr)
        fprintf (stderr, "%s : %s\n", dir,
            sys_enlist[result->errno]);
        errno = result->errno;
        perror(dir);
        exit(1);
    }

/* Successfully got a directory listing. Print it out. */
    for(nl = result->readdir_res_u.list; nl != NULL; nl = nl-
>next) {
```

EXAMPLE D-3 rls.c Client (Continued)

```
        printf("%s\n", nl->name);
    }
    exit(0);
```

Time Server Program (rpcgen)

EXAMPLE D-4 rpcgen Program: time.x

```
/*
 * time.x: Remote time protocol
 */
program TIMEPROG {
    version TIMEVERS {
        unsigned int TIMEGET(void) = 1;
    } = 1;
} = 0x20000044;

#ifdef RPC_SVC
%int *
%timeget_1()
%{
%    static int thetime;
%
%    thetime = time(0);
%    return (&thetime);
%}
#endif
```

Add Two Numbers Program (rpcgen)

EXAMPLE D-5 rpcgen program: Add Two Numbers

```
/* This program contains a procedure to add 2 numbers to
demonstrate
 * some of the features of the new rpcgen. Note that add() takes 2
 * arguments in this case.
 */
program ADDPROG {
    version ADDVER {
        int add ( int, int )
            = 1;
    } = 1;
} /* program number */
/* version number */
/* procedure */
```

EXAMPLE D-5 rpcgen program: Add Two Numbers (Continued)

```
} = 199;
```

Spray Packets Program (rpcgen)

Refer to the notes section on the `spray(1M)` man page for information about using this tool.

EXAMPLE D-6 rpcgen program: `spray.x`

```
/*
 * Copyright (c) 1987, 1991 by Sun Microsystems, Inc.
 */

/* from spray.x */

#ifdef RPC_HDR
#pragma ident "@(#)spray.h 1.2 91/09/17 SMI"
#endif

/*
 * Spray a server with packets
 * Useful for testing flakiness of network interfaces
 */

const SPRAYMAX = 8845; /* max amount can spray */

/*
 * GMT since 0:00, 1 January 1970
 */
struct spraytimeval {
    unsigned int sec;
    unsigned int usec;
};

/*
 * spray statistics
 */
struct spraycumul {
    unsigned int counter;
    spraytimeval clock;
};

/*
 * spray data
 */
typedef opaque sprayarr<SPRAYMAX>;
```

EXAMPLE D-6 rpcgen program: spray.x (Continued)

```
program SPRAYPROG {
    version SPRAYVERS {
        /*
         * Just throw away the data and increment the counter. This
         * call never returns, so the client should always time it
out.
        */
        void
        SPRAYPROC_SPRAY(sprayarr) = 1;

        /*
         * Get the value of the counter and elapsed time since last
         * CLEAR.
        */
        spraycumul
        SPRAYPROC_GET(void) = 2;

        /*
         * Clear the counter and reset the elapsed time
        */
        void
        SPRAYPROC_CLEAR(void) = 3;
    } = 1;
} = 100012;
```

Print Message Program With Remote Version

EXAMPLE D-7 printmesg.c

```
/* printmesg.c: print a message on the console */
#include <stdio.h>

main(argc, argv)
    int argc;
    char *argv[];
{
    char *message;

    if (argc != 2) {
        fprintf(stderr, "usage: %s <message>\n", argv[0]);
        exit(1);
    }
    message = argv[1];
    if( !printmessage(message) ) {
        fprintf(stderr, "%s: couldn't print your message\n",
```

EXAMPLE D-7 printmesg.c (Continued)

```
        argv[0]);
        exit(1);
    }
    printf("Message Delivered!\n");
    exit(0);
}

/* Print a message to the console. */

/*
 * Return a boolean indicating whether the message was actually
 * printed.
 */
printmessage(msg)
    char *msg;
{
    FILE *f;

    if = fopen("/dev/console", "w");
        if (f == (FILE *)NULL)
            return (0);
    fprintf(f, "%sen", msg);
    fclose(f);
    return (1);
}
```

EXAMPLE D-8 Remote Version of printmesg.c

```
/* * rprintmsg.c: remote version of "printmsg.c" */
#include <stdio.h>
#include <rpc/rpc.h> /* always needed */
#include "msg.h" /* msg.h generated by rpcgen */

main(argc, argv)
    int argc;
    char *argv[];
{
    CLIENT *cl;
    int *result;
    char *server;
    char *message;
    extern int sys_nerr;
    extern char *sys_errlist[];

    if (argc != 3) {
        fprintf(stderr, "usage: %s host messagen", argv[0]);
        exit(1);
    }
    /*
     * Save values of command line arguments
     */
    server = argv[1];
```

EXAMPLE D-8 Remote Version of printmesg.c (Continued)

```

    message = argv[2];
/*
 * Create client "handle" used for calling
 * MESSAGEPROG on the server
 * designated on the command line.
 */
    cl = clnt_create(server, MESSAGEPROG, PRINTMESSAGEEVERS,
                    "visible");
    if (cl == (CLIENT *)NULL) {
        /*
         * Couldn't establish connection with server.
         * Print error message and die.
         */
        clnt_pcreateerror(server);
        exit(1);
    }
    /* Call the remote procedure "printmessage" on the server */
    result = printmessage_1(&message, cl);
    if (result == (int *)NULL) {
        /*
         * An error occurred while calling the server.
         * Print error message and die.
         */
        clnt_perror(cl, server);
        exit(1);
    }
    /* Okay, we successfully called the remote procedure. */
    if (*result == 0) {
        /*
         * Server was unable to print our message.
         * Print error message and die.
         */
        fprintf(stderr, "%s"
        }
    /* The message got printed on the server's console */
    printf("Message delivered to %s!\n", server);
    exit(0);
}

```

EXAMPLE D-9 rpcgen Program: msg.x

```

/* msg.x: Remote message printing protocol */
program MESSAGEPROG {
    version MESSAGEEVERS {
        int PRINTMESSAGE(string) = 1;
    } = 1;
} = 0x20000001;

```

EXAMPLE D-10 mesg_proc.c

```

/*
 * mesg_proc.c: implementation of the remote
 * procedure "printmessage"

```

EXAMPLE D-10 `mesg_proc.c` (Continued)

```
*/

#include <stdio.h>
#include <rpc/rpc.h> /* always needed */
#include "msg.h" /* msg.h generated by rpcgen */

/*
 * Remote version of "printmessage"
 */
/*ARGSUSED1*/
int printmessage_1(msg, req)
    char **msg;
    struct svc_req *req;
{
    static int result; /* must be static! */
    FILE *f;

    f = fopen("/dev/console", "w");
    if (f == (FILE *)NULL) {
        result = 0;
        return (&result);
    }
    fprintf(f, "%s\n", *msg);
    fclose(f);
    result = 1;
    return (&result);
}
```

Batched Code Example

EXAMPLE D-11 Batched Client Program

```
#include <stdio.h>
#include <rpc/rpc.h>
#include "windows.h"

main(argc, argv)
    int      argc;
    char     **argv;
{
    struct timeval total_timeout;
    register CLIENT *client;
    enum clnt_stat clnt_stat;
    char        buf[1000], *s = buf;

    if ((client = clnt_create(argv[1], WINDOWPROG, WINDOWVERS,
        "CIRCUIT_V")) == (CLIENT *) NULL) {
```

EXAMPLE D-11 Batched Client Program (Continued)

```

        clnt_pcreateerror("clnt_create");
        exit(1);
    }

    timerclear(&total_timeout);
    while (scanf("%s", s) != EOF) {
        clnt_call(client, RENDERSTRING_BATCHED, xdr_wrapstring,
            &s, xdr_void, (caddr_t) NULL, total_timeout);
    }

    /* Now flush the pipeline */
    total_timeout.tv_sec = 20;
    clnt_stat = clnt_call(client, NULLPROC, xdr_void,
        (caddr_t) NULL, xdr_void, (caddr_t) NULL,
total_timeout);
    if (clnt_stat != RPC_SUCCESS) {
        clnt_perror(client, "rpc");
        exit(1);
    }
    clnt_destroy(client);
    exit(0);
}

```

EXAMPLE D-12 Batched Server Program

```

#include <stdio.h>
#include <rpc/rpc.h>
#include "windows.h"

void        windowdispatch();
main()
{
    int num;

    num = svc_create(windowdispatch, WINDOWPROG, WINDOWVERS,
        "CIRCUIT_V");
    if (num == 0) {
        fprintf(stderr, "can't create an RPC server\n");
        exit(1);
    }
    svc_run();                /* Never returns */
    fprintf(stderr, "should never reach this point\n");
}

void
windowdispatch(rqstp, transp)
    struct svc_req *rqstp;
    SVCXPRT      *transp;
{
    char          *s = NULL;

    switch (rqstp->rq_proc) {

```

EXAMPLE D-12 Batched Server Program (Continued)

```
case NULLPROC:
    if (!svc_sendreply(transp, xdr_void, 0))
        fprintf(stderr, "can't reply to RPC call\n");
    return;
case RENDERSTRING:
    if (!svc_getargs(transp, xdr_wrapstring, &s)) {
        fprintf(stderr, "can't decode arguments\n");
        /* Tell caller an error occurred */
        svcerr_decode(transp);
        break;
    }
    /* Code here to render the string s */
    if (!svc_sendreply(transp, xdr_void, (caddr_t) NULL))
        fprintf(stderr, "can't reply to RPC call\n");
    break;
case RENDERSTRING_BATCHED:
    if (!svc_getargs(transp, xdr_wrapstring, &s)) {
        fprintf(stderr, "can't decode arguments\n");
        /* Be silent in the face of protocol errors */
        break;
    }
    /* Code here to render string s, but send no reply! */
    break;
default:
    svcerr_noproc(transp);
    return;
}
/* Now free string allocated while decoding arguments */
svc_freeargs(transp, xdr_wrapstring, &s);
}
```

Non-Batched Example

This example is included for reference only. It is a version of the batched client string rendering service, written as a non-batched program.

EXAMPLE D-13 Unbatched Version of Batched Client

```
#include <stdio.h>
#include <rpc/rpc.h>
#include "windows.h"

main(argc, argv)
    int      argc;
    char    **argv;
{
    struct timeval  total_timeout;
```

EXAMPLE D-13 Unbatched Version of Batched Client *(Continued)*

```
register CLIENT *client;
enum clnt_stat clnt_stat;
char          buf[1000], *s = buf;

if ((client = clnt_create(argv[1], WINDOWPROG, WINDOWVERS,
                          "CIRCUIT_V")) == (CLIENT *) NULL) {
    clnt_pcreateerror("clnt_create");
    exit(1);
}
total_timeout.tv_sec = 20;
total_timeout.tv_usec = 0;
while (scanf("%s", s) != EOF) {
    if (clnt_call(client, RENDERSTRING, xdr_wrapstring, &s,
                 xdr_void, (caddr_t) NULL, total_timeout) != RPC_SUCCESS) {
        clnt_perror(client, "rpc");
        exit(1);
    }
}
clnt_destroy(client);
exit(0);}
```

portmap Utility

The `rpcbind` utility replaces the `portmap` utility available in previous releases of the Solaris environment. This appendix is included to help you understand the history of port and network address resolution using the `portmap` utility.

Solaris RPC-based services use `portmap` as a system registration service. It manages a table of correspondences between ports (logical communications channels) and the services registered at them. It provides a standard way for a client to look up the TCP/IP or UDP/IP port number of an RPC program supported by the server.

System Registration Overview

For client programs to find distributed services on a network, they need a way to look up the network addresses of server programs. Network transport (protocol) services do not provide this function. Their task is to provide process-to-process message transfer across a network, that is, a message is sent to a transport-specific network address. A network address is a logical communications channel. By listening on a specific network address, a process receives messages from the network.

The way a process waits on a network address varies from one operating system to the next, but all provide mechanisms by which a process can synchronize its activity with arriving messages. Messages are not sent across networks to receiving processes, but rather to the network address at which receiving processes pick them up.

Network addresses are valuable because they allow message receivers to be specified in a way that is independent of the conventions of the receiving operating system. TI-RPC, being transport independent, makes no assumptions about the structure of a network address. It uses a universal address. This universal address is specified as a null-terminated string of characters. Such a universal address is translated into a local transport address by a routine specific to the transport provider.

The `rpcbind` protocol defines a network service that provides a standard way for clients to look up the network address of any remote program supported by a server. Because this protocol can be implemented on any transport, it provides a single solution to a general problem that works for all clients, all servers, and all networks.

portmap Protocol

The `portmap` program maps RPC program and version numbers to transport-specific port numbers. This program makes dynamic binding of remote programs possible.

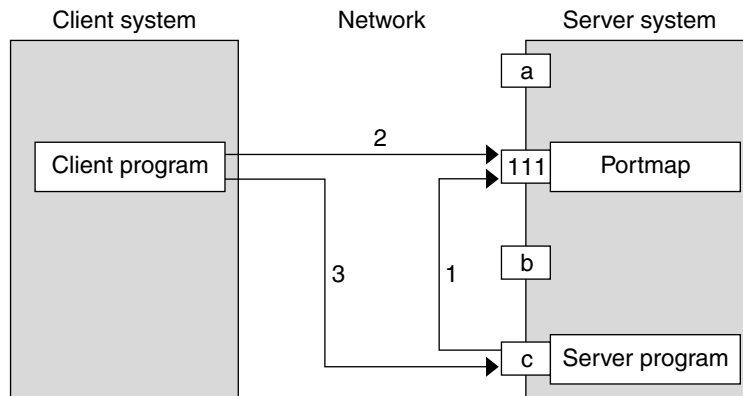

FIGURE E-1 Typical Portmap Sequence (For TCP/IP Only)

The figure illustrates the following process:

1. The server registers with `portmap`.
2. The client gets the server's port from `portmap`.
3. The client calls the server.

The range of reserved port numbers is small and the number of potential remote programs is very large. By running only the port mapper on a well-known port, the port numbers of other remote programs can be ascertained by querying the port mapper. In Figure E-1, `a`, `111`, `b`, and `c` represent port numbers, and `111` is the assigned port-mapper port number.

The port mapper also aids in broadcast RPC. A given RPC program usually has different port number bindings on different machines, so no direct broadcasts are possible to all of these programs. The port mapper, however, does have a fixed port number. So, to broadcast to a given program, the client sends its message to the port

mapper located at the broadcast address. Each port mapper that receives the broadcast then calls the local service specified by the client. When portmap gets the reply from the local service, it returns the reply to the client. The portmap protocol specification is shown in the following code example.

EXAMPLE E-1 portmap Protocol Specification (in RPC Language)

```

const PMAP_PORT = 111;          /* portmapper port number */
/*
 * A mapping of (program, version, protocol) to port number
 */
struct pmap {
    rpcprog_t prog;
    rpcvers_t vers;
    rpcprot_t prot;
    rpcport_t port;
};
/*
 * Supported values for the "prot" field
 */
const IPPROTO_TCP = 6; /* protocol number for TCP/IP */
const IPPROTO_UDP = 17; /* protocol number for UDP/IP */
/*
 * A list of mappings
 */
struct pmaplist {
    pmap map;
    pmaplist *next;
};
/*
 * Arguments to callit
 */
struct call_args {
    rpcprog_t prog;
    rpcvers_t vers;
    rpcproc_t proc;
    opaque args<>;
};
/*
 * Results of callit
 */
struct call_result {
    rpcport_t port;
    opaque res<>;
};
/*
 * Port mapper procedures
 */
program PMAP_PROG {
    version PMAP_VERS {
        void
        PMAPPROC_NULL(void) = 0;
        bool
        PMAPPROC_SET(pmap) = 1;
        bool
    }
};

```

EXAMPLE E-1 portmap Protocol Specification (in RPC Language) (Continued)

```
PMAPPROC_UNSET(pmap) = 2;
unsigned int
PMAPPROC_GETPORT(pmap) = 3;
pmaplist
PMAPPROC_DUMP(void) = 4;
call_result
PMAPPROC_CALLIT(call_args) = 5;
} = 2;
} = 100000;
```

portmap Operation

portmap currently supports two protocols (UDP/IP and TCP/IP). portmap is contacted by talking to it on assigned port number 111 (SUNRPC (5)) on either of these protocols. The following sections describe each of the port-mapper procedures.

PMAPPROC_NULL

This procedure does no work. By convention, procedure zero of any protocol takes no parameters and returns no results.

PMAPPROC_SET

When a program first becomes available on a machine, it registers itself with the local port map program. The program passes its program number *prog*, version number *vers*, transport protocol number *prot*, and the port *port* on which it receives service requests. The procedure refuses to establish a mapping if one already exists for the specified *port* and it is bound. If the mapping exists and the *port* is not bound, portmap unregisters the *port* and performs the requested mapping. The PMAPPROC_SET procedure returns TRUE if the procedure successfully established the mapping and FALSE otherwise. See also the `pmap_set()` function in the `rpc_soc(3NSL)` man page.

PMAPPROC_UNSET

When a program becomes unavailable, it should unregister itself with the port-mapper program on the same machine. The parameters and results of PMAPPROC_UNSET have meanings identical to those of PMAPPROC_SET. The *protocol* and *port number* fields of the argument are ignored. See also the `pmap_unset()` function in the `rpc_soc(3NSL)` man page.

PMAPPROC_GETPORT

Given a program number *prog*, version number *vers*, and transport protocol number *prot*, the `PMAPPROC_GETPORT` procedure returns the `port` number on which the program is awaiting call requests. A `port` value of zeroes means the program has not been registered. The *port* field of the argument is ignored. See also the `pmap_getport()` function in the `rpc_soc(3NSL)` man page.

PMAPPROC_DUMP

The `PMAPPROC_DUMP` procedure enumerates all entries in the port mapper's database. The procedure takes no parameters and returns a list of `program`, `version`, `protocol`, and `port` values. See also the `pmap_getmaps()` function in the `rpc_soc(3NSL)` man page.

PMAPPROC_CALLIT

The `PMAPPROC_CALLIT` procedure enables a caller to call another remote procedure on the same machine without knowing the remote procedure's port number. It supports broadcasts to arbitrary remote programs by using the well-known port mapper's port. The parameters *prog*, *vers*, *proc*, and the bytes of *args* are the program number, version number, procedure number, and parameters of the remote procedure. See also the `pmap_rmtcall()` function in the `rpc_soc(3NSL)` man page.

This procedure only sends a response if the procedure was successfully executed and is silent (no response) otherwise. It also returns the remote program's `port` number, and the bytes of *results* are the results of the remote procedure.

The port mapper communicates with the remote program using UDP/IP only.

Writing a Port Monitor With the Service Access Facility (SAF)

This appendix gives a brief description of the functions a port monitor must perform to run under the service access facility (SAF) and service access controller (SAC).

The appendix covers the following topics:

- “What Is the SAF?” on page 321
- “What Is the SAC?” on page 322
- “SAF Files” on page 325
- “SAC/Port Monitor Interface” on page 326
- “Port Monitor Administrative Interface” on page 328
- “Configuration Files and Scripts” on page 335
- “Sample Port Monitor Code ” on page 340
- “Logic Diagram and Directory Structure ” on page 345

What Is the SAF?

The service access facility (SAF) generalizes the procedures for service access so that login access on the local system and network access to local services are managed in similar ways. Under the SAF, systems can access services using a variety of port monitors, including `ttymon`, the listener, and port monitors written expressly for a user’s application.

The manner in which a port monitor observes and manages access ports is specific to the port monitor and not to any component of the SAF. Users can therefore extend their systems by developing and installing their own port monitors. This ability to extend the SAF is one of its important features.

Relative to the SAF, a service is a process that is started. No restrictions are on the functions a service can provide.

The SAF consists of a controlling process, the service access controller (SAC), and two administrative levels corresponding to two levels in the supporting directory structure. The top administrative level is concerned with port monitor administration, the lower level with service administration.

From an administrative point of view, the SAF consists of the following components:

- The SAC
- A per-system configuration script
- The SAC administrative file
- The SAC administrative command `sacadm`
- Port monitors
- Optional per-port monitor configuration scripts
- An administrative file for each port monitor
- The administrative command `pmadm`
- Optional per-service configuration scripts

What Is the SAC?

The service access controller (SAC) is the SAF's controlling process. The SAC is started by `init()` by means of an entry in `/etc/inittab`. Its function is to maintain the port monitors on the system in the state specified by the system administrator.

Use the administrative command `sacadm` to tell the SAC to change the state of a port monitor. `sacadm` can also be used to add or remove a port monitor from SAC supervision and to list information about port monitors known to the SAC.

The SAC's administrative file contains a unique tag for each port monitor known to the SAC and the path name of the command used to start each port monitor.

The SAC performs three main functions:

- Customizes its own environment
- Starts the appropriate port monitors
- Polls its port monitors and initiates recovery procedures when necessary

Basic Port Monitor Functions

A *port monitor* is a process that is responsible for monitoring a set of homogeneous, incoming ports on a machine. A port monitor's major purpose is to detect incoming service requests and to dispatch them appropriately.

A *port* is an externally seen access point on a system. A port can be an address on a network (TSAP or PSAP), a hardwired terminal line, an incoming phone line, and so on. The definition of what constitutes a port is strictly a function of the port monitor itself.

A port monitor performs certain basic functions. Some of these functions are required to conform to the SAF. Other functions can be specified by the requirements and design of the port monitor itself.

Port monitors have two main functions:

- Managing ports
- Monitoring ports for indications of activity

Port Management

The first function of a port monitor is to manage a port. The actual details of how a port is managed are defined by the person who defines the port monitor. A port monitor can handle multiple ports simultaneously.

Some examples of port management are setting the line speed on incoming phone connections, binding an appropriate network address, reinitializing the port when the service terminates, outputting a prompt, and so on.

Activity Monitoring

The second function of a port monitor is to monitor the port or ports for which it is responsible for indications of activity. Two types of activity can be detected.

1. The first activity is an indication to the port monitor to take some port monitor-specific action. Pressing the Break key to indicate that the line speed should be cycled is an example of a port monitor activity. Not all port monitors need to recognize and respond to the same indications. The indication used to attract the attention of the port monitor is defined by the person who defines the port monitor.
2. The second activity is an incoming service request. When a service request is received, a port monitor must be able to determine which service is being requested from the port on which the request is received. Note that the same service can be available on more than one port.

Other Port Monitor Functions

This section briefly describes other port monitor functions.

Restricting Access to the System

A port monitor must be able to restrict access to the system without disturbing services that are still running. In order to do so, a port monitor must maintain two internal states: enabled and disabled. The port monitor starts in the state indicated by the `ISTATE` environment variable provided by the SAC. See “SAC/Port Monitor Interface” on page 326.

Enabling or disabling a port monitor affects all ports for which the port monitor is responsible. If a port monitor is responsible for a single port, only that port is affected. If a port monitor is responsible for multiple ports, the entire collection of ports is affected.

Enabling or disabling a port monitor is a dynamic operation. It causes the port monitor to change its internal state. The effect does not persist across new invocations of the port monitor.

Enabling or disabling an individual port is a static operation. It causes a change to an administrative file. The effect of this change persists across new invocations of the port monitor.

Creating `utmpx` Entries

Port monitors are responsible for creating `utmpx` entries with the `type` field set to `USER_PROCESS` for services they start, if this action has been specified, that is, if `-fu` was specified in the `pmadm` line that added the service. These `utmpx` entries can in turn be modified by the service. When the service terminates, the `utmpx` entry must be set to `DEAD_PROCESS`.

Port Monitor Process IDs and Lock Files

When a port monitor starts, it writes its process ID into a file named `_pid` in the current directory and places an advisory lock on the file.

Changing the Service Environment: Running `doconfig()`

Before invoking the service designated in the port monitor administrative file, `_pmtab`, a port monitor must arrange for the per-service configuration script to be run, if one exists, by calling the library function `doconfig()`. Because the per-service configuration script can specify the execution of restricted commands, as well as for other security reasons, port monitors are invoked with `root` permissions. The details of how services are invoked are specified by the person who defines the port monitor.

Terminating a Port Monitor

A port monitor must terminate itself gracefully on receipt of the signal `SIGTERM`. The termination sequence is as follows:

1. The port monitor enters the `stopping` state. No further service requests are accepted.
2. Any attempt to re-enable the port monitor is ignored.
3. The port monitor yields control of all ports for which it is responsible. A new instantiation of the port monitor must be able to start correctly while a previous instantiation is stopping.
4. The advisory lock on the process ID file is released. After this lock is released, the contents of the process ID file are undefined and a new invocation of the port monitor can be started.

SAF Files

This section briefly covers the files used by the SAF.

Port Monitor Administrative File

A port monitor's current directory contains an administrative file named `_pmtab`. `_pmtab` is maintained by the `pmadm` command in conjunction with a port monitor-specific administrative command.

The port monitor administrative command for a `listen` port monitor is `nlsadmin()`; the port monitor administrative command for `ttymon` is `ttymadm()`. Any port monitor written by a user must be provided with an administrative command specific to that port monitor to perform similar functions.

Per-Service Configuration Files

A port monitor's current directory also contains the per-service configuration scripts, if they exist. The names of the per-service configuration scripts correspond to the service tags in the `_pmtab` file.

Private Port Monitor Files

A port monitor can create private files in the directory `/var/saf/tag`, where *tag* is the name of the port monitor. Examples of private files are log files or temporary files.

SAC/Port Monitor Interface

The SAC creates two environment variables for each port monitor it starts:

- `PMTAG`
- `ISTATE`

This variable is set to a unique port monitor tag by the SAC. The port monitor uses this tag to identify itself in response to sac messages. `ISTATE` is used to indicate to the port monitor what its initial internal state should be. `ISTATE` is set to `enabled` or `disabled` to indicate that the port monitor is to start in the enabled or disabled state respectively. The SAC performs a periodic sanity poll of the port monitors.

The SAC communicates with port monitors through FIFOs. A port monitor should open `_pmpipe`, in the current directory, to receive messages from the SAC and `../_sacpipe` to send return messages to the SAC.

Message Formats

This section describes the messages that can be sent from the SAC to a port monitor (SAC messages), and from a port monitor to the SAC (port monitor messages). These messages are sent through FIFOs and are in the form of C structures. See Example F-2.

SAC Messages

The format of messages from the SAC is defined by the structure `sacmsg`:

```
struct sacmsg {
    int sc_size; /* size of optional data portion */
    char sc_type; /* type of message */
};
```

The SAC can send four types of messages to port monitors. The type of message is indicated by setting the `sc_type` field of the `sacmsg` structure to one of the following:

- `SC_STATUS` status request.
- `SC_ENABLE` enable message.

- `SC_DISABLE` disable message.
- `SC_READDB` message indicating that the port monitor's `_pmtab` file should be read.
- `sc_size` indicates the size of the optional data part of the message. See "Message Classes" on page 328. For the Solaris environment, `sc_size` should always be set to 0.

A port monitor must respond to every message sent by the SAC.

Port Monitor Messages

The format of messages from a port monitor to the SAC is defined by the structure `pmmsg`.

```
struct pmmsg {
    char pm_type;           /* type of message */
    uchar pm_state;        /* current state of port monitor */
    char pm_maxclass;      /* maximum message class this port
                           monitor understands */
    char pm_tag[PMTAGSIZE + 1]; /* port monitor's tag */
    int pm_size;           /* size of optional data portion */
};
```

Port monitors can send two types of messages to the SAC. The type of message is indicated by setting the `pm_type` field of the `pmmsg` structure to one of the following values:

- `PM_STATUS` state information
- `PM_UNKNOWN` negative acknowledgement

For both types of messages, set the `pm_tag` field to the port monitor's tag and the `pm_state` field to the port monitor's current state. Valid states are:

- `PM_STARTING` starting
- `PM_ENABLED` enabled
- `PM_DISABLED` disabled
- `PM_STOPPING` stopping

The current state reflects any changes caused by the last message from the SAC.

The status message is the normal return message. The negative acknowledgement should be sent only when the message received is not understood.

`pm_size` indicates the size of the optional-data part of the message. `pm_maxclass` is used to specify a message class. Both fields are discussed in "Message Classes" on page 328. In the Solaris environment, always set `pm_maxclass` to 1 and `sc_size` to 0.

Port monitors can never initiate messages; they can only respond to messages that they receive.

Message Classes

The concept of message class has been included to accommodate possible SAF extensions. The preceding messages are all `class 1` messages. None of these messages contains a variable data portion. All pertinent information is contained in the message header.

If new messages are added to the protocol, they are defined as new message classes, for example, `class 2`. The first message that the SAC sends to a port monitor is always a `class 1` message. Because all port monitors by definition understand `class 1` messages, the first message that the SAC sends is guaranteed to be understood. In its response to the SAC, the port monitor sets the `pm_maxclass` field to the maximum message class number for that port monitor. The SAC does not send messages to a port monitor from a class with a larger number than the value of `pm_maxclass`. Requests fail if they require messages of a higher class than the port monitor can understand. For the Solaris environment, always set `pm_maxclass` to 1.

For any given port monitor, messages of class `pm_maxclass` and messages of all classes with values lower than `pm_maxclass` are valid. Thus, if the `pm_maxclass` field is set to 3, the port monitor understands messages of classes 1, 2, and 3. Port monitors cannot generate messages; they can only respond to messages. A port monitor's response must be of the same class as the originating message.

Because only the SAC can generate messages, this protocol function— even if the port monitor is capable of dealing with messages of a higher class than the SAC can generate.

`pm_size` is an element of the `pmmsg` structure. `sc_size` is an element of the `sacmsg` structure. These elements indicate the size of the optional-data part of the message. The format of this part of the message is undefined. Its definition is inherent in the type of message. For the Solaris environment, always set both `sc_size` and `pm_size` to 0.

Port Monitor Administrative Interface

This section discusses the administrative files available under the SAC.

SAC Administrative File `_sactab`

The service access controller's administrative file contains information about all the port monitors for which the SAC is responsible. This file exists on the delivered system. Initially, the file is empty except for a single comment line that contains the

version number of the SAC. You add port monitors to the system by making entries in the SAC's administrative file. These entries should be made using the administrative command `sacadm` with a `-a` option. `sacadm` is also used to remove entries from the SAC's administrative file.

Each entry in the SAC's administrative file contains the information shown in the following table.

TABLE F-1 Service Access Controller `_sactab` File

Fields	Description
PMTAG	A unique tag that identifies a particular port monitor. The system administrator is responsible for naming a port monitor. This tag is then used by the SAC to identify the port monitor for all administrative purposes. PMTAG can consist of up to 14 alphanumeric characters.
PMTYPE	The type of the port monitor. In addition to its unique tag, each port monitor has a type designator. The type designator identifies a group of port monitors that are different invocations of the same entity. <code>ttymon</code> and <code>listen</code> are examples of valid port monitor types. The type designator is used to facilitate the administration of groups of related port monitors. Without a type designator, the system administrator has no way of knowing which port monitor tags correspond to port monitors of the same type. PMTYPE can consist of up to 14 alphanumeric characters.
FLGS	The flags that are currently defined are: <ul style="list-style-type: none"> -d When it is started, do not enable the port monitor. -x Do not start the port monitor. If no flag is specified, the default action is taken. By default, a port monitor is started and enabled.
RCNT	The number of times a port monitor can fail before being placed in a failed state. After a port monitor enters the failed state, the SAC does not try to restart it. If a count is not specified when the entry is created, this field is set to 0. A restart count of 0 indicates that the port monitor is not to be restarted when it fails.
COMMAND	A string representing the command that starts the port monitor. The first component of the string, the command itself, must be a full path name.

Port Monitor Administrative File `_pmtab`

Each port monitor has two directories for its exclusive use. The current directory contains files defined by the SAF (`_pmtab`, `_pid`) and the per-service configuration scripts, if they exist. The directory `/var/saf/pmtag`, where `pmtag` is the tag of the port monitor, is available for the port monitor's private files.

Each port monitor has its own administrative file. Use the `pmadm` command to add, remove, or modify service entries in this file. Each time a change is made using `pmadm`, the corresponding port monitor rereads its administrative file. Each entry in a port monitor's administrative file defines how the port monitor treats a specific port and what service is to be invoked on that port.

Some fields must be present for all types of port monitors. Each entry must include a service tag to identify the service uniquely and an identity to be assigned to the service when it is started, for example, `root`.

The combination of a service tag and a port monitor tag uniquely define an instance of a service. You can use the same service tag to identify a service under a different port monitor. The record must also contain port monitor-specific data (for example, for a `ttymon` port monitor, this data includes the prompt string which is meaningful to `ttymon`). Each type of port monitor must provide a command that takes the necessary port monitor-specific data as arguments and outputs this data in a form suitable for storage in the file. The `ttymax` command provides the formatting for `ttymon`, `nlsadmin` for `listen`. For a user-defined port monitor, you also must supply a similar administrative command.

Each service entry in the port monitor administrative file must have the following format and contain the following information:

```
svctag:flgs:id:reserved:reserved:reserved:pmspecific# comment
```

SVCTAG is a unique tag that identifies a service. This tag is unique only for the port monitor through which the service is available. Other port monitors can offer the same or other services with the same tag. A service requires both a port monitor tag and a service tag to identify it uniquely.

SVCTAG may consist of up to 14 alphanumeric characters. The service entries are defined in the following table.

TABLE F-2 SVCTAG Service Entries

Service Entries	Description
FLGS	Flags with the following meanings might currently be included in this field: -x Do not enable this port. By default, the port is enabled. -u Create a <code>utmpx</code> entry for this service. By default, no <code>utmpx</code> entry is created for the service.
ID	The identity under which the service is to be started. The identity has the form of a login name as it appears in <code>/etc/passwd</code> .

TABLE F-2 SVCTAG Service Entries (Continued)

Service Entries	Description
PMSPECIFIC	Examples of port monitor information are addresses, the name of a process to execute, or the name of a STREAMS pipe through which to pass a connection. This information varies to meet the needs of each different type of port monitor.
COMMENT	A comment associated with the service entry.

Note – Port monitors might ignore the `-u` flag if creating a `utmpx` entry for the service is not appropriate to the manner in which the service is to be invoked. Some services might not start properly unless `utmpx` entries have been created for them, for example, `login`.

Each port monitor administrative file must contain one special comment of the form:

```
# VERSION=value
```

In this case, *value* is an integer that represents the port monitor's version number. The version number defines the format of the port monitor administrative file. This comment line is created automatically when a port monitor is added to the system. It appears on a line by itself, before the service entries.

SAC Administrative Command `sacadm`

`sacadm` is the administrative command for the upper level of the SAF hierarchy, that is, for port monitor administration. See the `sacadm(1M)` man page. Under the SAF, port monitors are administered by using the `sacadm` command to make changes in the SAC's administrative file. `sacadm` performs the following functions:

- Prints requested port monitor information from the SAC administrative file
- Adds or removes a port monitor
- Enables or disables a port monitor
- Starts or stops a port monitor
- Installs or replaces a per-system configuration script
- Installs or replaces a per-port monitor configuration script
- Asks the SAC to reread its administrative file

Port Monitor Administrative Command `pmadm`

`pmadm` is the administrative command for the lower level of the SAF hierarchy, that is, for service administration. See the `pmadm(1M)` man page. A port can have only one service associated with it, although the same service might be available through more than one port. `pmadm` performs the following functions:

- Prints service status information from the port monitor's administrative file
- Adds or removes a service
- Enables or disables a service
- Installs or replaces a per-service configuration script

In order to identify an instance of a service uniquely, the `pmadm` command must identify both the service (`-s`) and the port monitor or port monitors through which the service is available (`-p` or `-t`).

Monitor-Specific Administrative Command

In the previous section, two pieces of information included in the `_pmtab` file were described: the port monitor's version number and the port monitor part of the service entries in the port monitor's `_pmtab` file. When you add a new port monitor, the version number must be known so that the `_pmtab` file can be correctly initialized. When you add a new service, the port monitor part of the `_pmtab` entry must be formatted correctly.

Each port monitor must have an administrative command to perform these two tasks. The person who defines the port monitor must also define such an administrative command and its input options. When the command is invoked with these options, the information required for the port monitor part of the service entry must be correctly formatted for inclusion in the port monitor's `_pmtab` file and must be written to the standard output. To request the version number, the command must be invoked with a `-v` option. When it is invoked in this way, the port monitor's current version number must be written to the standard output.

If the command fails for any reason during the execution of either of these tasks, no data should be written to standard output.

Port Monitor/Service Interface

The interface between a port monitor and a service is determined solely by the service. Two mechanisms for invoking a service are presented here as examples.

New Service Invocations

The first interface is for services that are started anew with each request. This interface requires the port monitor to first `fork()` a child process. The child eventually becomes the designated service by performing an `exec()`. Before the `exec()` happens, the port monitor might take some port monitor-specific action. However, one action that must occur is the interpretation of the per-service configuration script, if one is present. This interpretation is done by calling the library routine `doconfig()`.

Standing Service Invocations

The second interface is for invocations of services that are actively running. To use this interface, a service must have one end of a stream pipe open and be prepared to receive connections through it.

Port Monitor Requirements

To implement a port monitor, several generic requirements must be met. This section summarizes these requirements. In addition to the port monitor itself, you must supply an administrative command.

Initial Environment

When a port monitor is started, it expects an initial execution environment in which:

- It has no file descriptors open.
- It cannot be a process group leader.
- It has an entry in `/var/adm/utmpx` of type `LOGIN_PROCESS`.
- An environment variable, `ISTATE`, is set to `enabled` or `disabled` to indicate the port monitor's correct initial state.
- An environment variable, `PMTAG`, is set to the port monitor's assigned tag.
- The directory that contains the port monitor's administrative files is its current directory.
- The port monitor is able to create private files in the directory `/var/saf/tag`, where `tag` is the port monitor's tag.
- The port monitor is running with user id 0 (root).

Important Files

Relative to its current directory, the key files listed in the following table exist for a port monitor.

TABLE F-3 Key Port Monitor Files

File	Description
<code>_config</code>	The port monitor's configuration script. The port monitor configuration script is run by the SAC. The SAC is started by <code>init()</code> as a result of an entry in <code>/etc/inittab</code> that calls the SAC.
<code>_pid</code>	The file into which the port monitor writes its process ID.
<code>_pmtab</code>	The port monitor's administrative file. This file contains information about the ports and services for which the port monitor is responsible.
<code>_pmpipe</code>	The FIFO through which the port monitor receives messages from the SAC.
<code>svctag</code>	The per-service configuration script for the service with the tag <code>svctag</code> .
<code>../_sacpipe</code>	The FIFO through which the port monitor sends messages to the SAC.

Port Monitor Responsibilities

A port monitor is responsible for performing the following tasks in addition to its port monitor function:

- Writing its process ID into the file `_pid` and place an advisory lock on the file
- Terminating gracefully on receipt of the signal `SIGTERM`
- Following the protocol for message exchange with the SAC

A port monitor must perform the following tasks during service invocation:

- Creating a `utmp` entry if the requested service has the `"-u"` flag set in `_pmtab`

Note – Port monitors might ignore this flag if creating a `utmp` entry for the service does not make sense because of the manner in which the service is to be invoked. On the other hand, some services might not start properly unless `utmp` entries have been created for them.

- Interpreting the per-service configuration script for the requested service, if it exists, by calling the `doconfig()` library routine

Configuration Files and Scripts

This section describes configuration files and scripts.

Interpreting Configuration Scripts With `doconfig()`

The library routine `doconfig()`, defined in `libnsl.so`, interprets the configuration scripts contained in the files `/etc/saf/_sysconfig`, the per-system configuration file, `/etc/saf/pmtag/_config`, the per-port monitor configuration files, and `/etc/saf/pmtag/svctag`, the per-service configuration files. Its syntax is:

```
# include <sac.h>
int doconfig (int fd, char *script, long rflag);
```

- *script* is the name of the configuration script.
- *fd* is a file descriptor that designates the stream to which stream manipulation operations are to be applied.
- *rflag* is a bitmask that indicates the mode in which *script* is to be interpreted.

rflag takes two values, `NORUN` and `NOASSIGN`, which may be OR'd. If *rflag* is zero, all commands in the configuration script are eligible to be interpreted. If *rflag* has the `NOASSIGN` bit set, the `assign` command is considered illegal and generates an error return. If *rflag* has the `NORUN` bit set, the `run` and `runwait` commands are considered illegal and generates error returns.

If a command in the script fails, the interpretation of the script ceases at that point and a positive integer is returned. This number indicates which line in the script failed. If a system error occurs, a value of `-1` is returned.

If a script fails, the process with the environment being established should *not* be started.

In the following example, `doconfig()` is used to interpret a per-service configuration script.

```
...
    if ((i = doconfig (fd, svctag, 0)) != 0){
        error ("doconfig failed online %d of script %s",i,svctag);
    }
}
```

Per-System Configuration File

The per-system configuration file, `/etc/saf/_sysconfig`, is delivered empty. You can use it to customize the environment for all services on the system by writing a command script in the interpreted language. This language is described in this chapter and on the `doconfig(3NSL)` man page. When the SAC is started, it calls the `doconfig()` function to interpret the per-system configuration script. The SAC is started when the system enters multiuser mode.

Per-Port Monitor Configuration Files

Per-port monitor configuration scripts (`/etc/saf/pmtag/_config`) are optional. They enable you to customize the environment for any given port monitor and for the services that are available through the ports for which that port monitor is responsible. Per-port monitor configuration scripts are written in the same language that is used for per-system configuration scripts.

The per-port monitor configuration script is interpreted when the port monitor is started. The port monitor is started by the SAC after the SAC has itself been started and after it has run its own configuration script, `/etc/saf/_sysconfig`.

The per-port monitor configuration script might override defaults provided by the per-system configuration script.

Per-Service Configuration Files

Per-service configuration files enable you to customize the environment for a specific service. For example, a service might require special privileges that are not available to the general user. Using the language described in the `doconfig(3NSL)` man page, you can write a script that grants or limits such special privileges to a particular service offered through a particular port monitor.

The per-service configuration might override defaults provided by higher-level configuration scripts. For example, the per-service configuration script might specify a set of STREAMS modules other than the default set.

Configuration Language

The language in which configuration scripts are written consists of a sequence of commands, each of which is interpreted separately. The following reserved keywords are defined: `assign`, `push`, `pop`, `runwait`, and `run`. The comment character is `#`. Blank lines are not significant. No line in a command script can exceed 1024 characters.

assign Keyword

The `assign` keyword is used to define environment variables.

```
assign variable=value
```

variable is the name of the environment variable and *value* is the value to be assigned to it. The value assigned must be a string constant. No form of parameter substitution is available. *value* can be quoted. The quoting rules are those that the shell uses for defining environment variables. `assign` fails if space cannot be allocated for the new variable or if any part of the specification is invalid.

push Keyword

The `push` keyword is used to push STREAMS modules onto the stream designated by *fd*. See the `doconfig(3NSL)` man page.

```
push module1 [, module2, module3, ...]
```

module1 is the name of the first module to be pushed, *module2* is the name of the second module to be pushed, and so on. The command fails if any of the named modules cannot be pushed. If a module cannot be pushed, the subsequent modules on the same command line are ignored and modules that have already been pushed are popped.

pop Keyword

The `pop` keyword is used to pop STREAMS modules off the designated stream.

```
pop [module]
```

If `pop` is invoked with no arguments, the top module on the stream is popped. If an argument is given, modules are popped one at a time until the named module is at the top of the stream. If the named module is not on the designated stream, the stream is left as it was and the command fails. If *module* is the special keyword `ALL`, then all modules on the stream are popped. Note that only modules above the topmost driver are affected.

runwait Keyword

The `runwait` keyword runs a command and waits for it to complete.

```
runwait command
```

command is the path name of the command to be run. The command is run with `/bin/sh -c` prepended to it. Shell scripts can thus be executed from configuration scripts. The `runwait` command fails if *command* cannot be found or cannot be executed, or if *command* exits with a nonzero status.

run Keyword

The `run` keyword is identical to `runwait` except that it does not wait for *command* to complete.

```
run command
```

command is the path name of the command to be run. `run` does not fail unless it is unable to create a child process to execute the command.

Although they are syntactically indistinguishable, some of the commands available to `run` and `runwait` are interpreter built-in commands. Interpreter built-ins are used when it is necessary to alter the state of a process within the context of that process. The `doconfig()` interpreter built-in commands are similar to the shell special commands and, like these commands, they do not spawn another process for execution. See the `sh(1)` man page. The initial set of built-in commands is:

```
cd ulimit umask
```

Printing, Installing, and Replacing Configuration Scripts

This section describes the form of the SAC and port monitor administrative commands used to install the three types of configuration scripts. Per-system and per-port monitor configuration scripts are administered using the `sacadm` command. Per-service configuration scripts are administered using the `pmadm` command.

Per-System Configuration Scripts

Per-system configuration scripts are administered by using the `sacadm` command.

```
sacadm -G [ -z script ]
```

The `-G` option is used to print or replace the per-system configuration script. The `-G` option by itself prints the per-system configuration script. The `-G` option in combination with a `-z` option replaces `/etc/saf/_sysconfig` with the contents of the file *script*. Other combinations of options with a `-G` option are invalid.

The `_sysconfig` file in the following example sets the time zone variable, *TZ*.

```
assign TZ=EST5EDT # set TZ
runwait echo SAC is starting > /dev/console
```

Per-Port Monitor Configuration Scripts

Per-port monitor configuration scripts are administered by using the `sacadm` command.

```
sacadm -g -p pmtag [ -z script ]
```

The `-g` option is used to print, install, or replace the per-port monitor configuration script. A `-g` option requires a `-p` option. The `-g` option with only a `-p` option prints the per-port monitor configuration script for port monitor *pmtag*. The `-g` option with a `-p` option and a `-z` option installs the file *script* as the per-port monitor configuration script for port monitor *pmtag*. Or, if `/etc/saf/pmtag/_config` exists, these options replace `_config` with the contents of *script*. Other combinations of options with `-g` are invalid.

In the `_config` file, the command `/usr/bin/daemon` is assumed to start a daemon process that builds and holds together a STREAMS multiplexor. By installing this configuration script, the command can be executed just before starting the port monitor that requires it.

```
# build a STREAMS multiplexor
run /usr/bin/daemon
runwait echo $PMTAG is starting > /dev/console
```

Per-Service Configuration Scripts

Per-service configuration scripts are interpreted by the port monitor before the service is invoked.

```
pmadm -g -p pmtag -s svctag [ -z script ]
pmadm -g -s svctag -t type -z script
```

Note – The SAC interprets both its own configuration file, `_sysconfig`, and the port monitor configuration files. Only the per-service configuration files are interpreted by the port monitors.

The `-g` option is used to print, install, or replace a per-service configuration script. The `-g` option with a `-p` option and a `-s` option prints the per-service configuration script for service *svctag* available through port monitor *pmtag*. The `-g` option with a `-p` option, a `-s` option, and a `-z` option installs the per-service configuration script contained in the file *script* as the per-service configuration script for service *svctag* available through port monitor *pmtag*. The `-g` option with a `-s` option, a `-t` option, and a `-z` option installs the file *script* as the per-service configuration script for service *svctag* available through any port monitor of type *type*. Other combinations of options with `-g` are invalid.

The following per-service configuration script controls two settings: It specifies the maximum file size for files created by a process by setting the process's *ulimit* to 4096. It also specifies the protection mask to be applied to files created by the process by setting *umask* to 077.

```
runwait ulimit 4096
runwait umask 077
```

Sample Port Monitor Code

The following code example is a “null” port monitor that simply responds to messages from the SAC.

EXAMPLE F-1 Sample Port Monitor

```
# include <stdlib.h>
# include <stdio.h>
# include <unistd.h>
# include <fcntl.h>
# include <signal.h>
# include <sac.h>

char Scratch[BUFSIZ]; /* scratch buffer */
char Tag[PMTAGSIZE + 1]; /* port monitor's tag */
FILE *Fp; /* file pointer for log file */
FILE *Tfp; /* file pointer for pid file */
char State; /* port monitor's current state*/

main(argc, argv)
    int argc;
    char *argv[];
{
    char *istate;
    strcpy(Tag, getenv("PMTAG"));
    /*
     * open up a log file in port monitor's private directory
     */
    sprintf(Scratch, "/var/saf/%s/log", Tag);
    Fp = fopen(Scratch, "a+");
    if (Fp == (FILE *)NULL)
        exit(1);
    log(Fp, "starting");
    /*
     * retrieve initial state (either "enabled" or "disabled") and set
     * State accordingly
     */
    istate = getenv("ISTATE");
    sprintf(Scratch, "ISTATE is %s", istate);
    log(Fp, Scratch);
    if (!strcmp(istate, "enabled"))
        State = PM_ENABLED;
    else if (!strcmp(istate, "disabled"))
        State = PM_DISABLED;
    else {
        log(Fp, "invalid initial state");
        exit(1);
    }
    sprintf(Scratch, "PMTAG is %s", Tag);
    log(Fp, Scratch);
    /*
```

EXAMPLE F-1 Sample Port Monitor (Continued)

```
* set up pid file and lock it to indicate that we are active
*/
Tfp = fopen("_pid", "w");
if (Tfp == (FILE *)NULL) {
    log(Fp, "couldn't open pid file");
    exit(1);
}
if (lockf(fileno(Tfp), F_TEST, 0) < 0) {
    log(Fp, "pid file already locked");
    exit(1);
}
fprintf(Tfp, "%d", getpid());
fflush(Tfp);
log(Fp, "locking file");
if (lockf(fileno(Tfp), F_LOCK, 0) < 0) {
    log(Fp, "lock failed");
    exit(1);
}
}
/*
 * handle poll messages from the sac ... this function never
returns
*/
handlepoll();
pause();
fclose(Tfp);
fclose(Fp);
}

handlepoll()
{
    int pfd; /* file descriptor for incoming pipe */
    int sfd; /* file descriptor for outgoing pipe */
    struct sacmsg sacmsg; /* incoming message */
    struct pmmsg pmmsg; /* outgoing message */
/*
 * open pipe for incoming messages from the sac
 */
    pfd = open("_pmpipe", O_RDONLY|O_NONBLOCK);
    if (pfd < 0) {
        log(Fp, "_pmpipe open failed");
        exit(1);
    }
/*
 * open pipe for outgoing messages to the sac
 */
    sfd = open("../_sacpipe", O_WRONLY);
    if (sfd < 0) {
        log(Fp, "_sacpipe open failed");
        exit(1);
    }
/*
 * start to build a return message; we only support class 1
messages
*/
}
```

EXAMPLE F-1 Sample Port Monitor (Continued)

```
*/
    strcpy(pmmsg.pm_tag, Tag);
    pmmsg.pm_size = 0;
    pmmsg.pm_maxclass = 1;
/*
* keep responding to messages from the sac
*/
    for (;;) {
        if (read(pfd, &sacmsg, sizeof(sacmsg)) != sizeof(sacmsg)) {
            log(Fp, "_pmpipe read failed");
            exit(1);
        }
    }
/*
* determine the message type and respond appropriately
*/
    switch (sacmsg.sc_type) {
        case SC_STATUS:
            log(Fp, "Got SC_STATUS message");
            pmmsg.pm_type = PM_STATUS;
            pmmsg.pm_state = State;
            break;
        case SC_ENABLE:
            /*note internal state change below*/
            log(Fp, "Got SC_ENABLE message");
            pmmsg.pm_type = PM_STATUS;
            State = PM_ENABLED;
            pmmsg.pm_state = State;
            break;
        case SC_DISABLE:
            /*noteinternalstatechangebelow*/
            log(Fp, "Got SC_DISABLE message");
            pmmsg.pm_type = PM_STATUS;
            State = PM_DISABLED;
            pmmsg.pm_state = State;
            break;
        case SC_READDB:
            /*
            * if this were a fully functional port monitor it
            * would read _pmtab here and take appropriate action
            */
            log(Fp, "Got SC_READDB message");
            pmmsg.pm_type = PM_STATUS;
            pmmsg.pm_state = State;
            break;
        default:
            sprintf(Scratch, "Got unknown message <%d>",
                sacmsg.sc_type);
            log(Fp, Scratch);
            pmmsg.pm_type = PM_UNKNOWN;
            pmmsg.pm_state = State;
            break;
    }
/*
```

EXAMPLE F-1 Sample Port Monitor (Continued)

```
* send back a response to the poll
* indicating current state
*/
        if (write(sfd, &pmmsg, sizeof(pmmsg)) != sizeof(pmmsg))
            log(Fp, "sanity response failed");
    }
}
/*
* general logging function
*/
log(fp, msg)
    FILE *fp;
    char *msg;
{
    fprintf(fp, "%d; %s\n", getpid(), msg);
    fflush(fp);
}
```

The following code example shows the `sac.h` header file.

EXAMPLE F-2 `sac.h` Header File

```
/* length in bytes of a utmpx id */
# define IDLEN 4
/* wild character for utmpx ids */
# define SC_WILDC 0xff
/* max len in bytes for port monitor tag */
# define PMTAGSIZE 14
/*
* values for rflag in doconfig()
*/
/* don't allow assign operations */
# define NOASSIGN 0x1
/* don't allow run or runwait operations */
# define NORUN 0x2
/*
* message to SAC (header only). This header is forever fixed. The
* size field (pm_size) defines the size of the data portion of
the
* message, which follows the header. The form of this optional
data
* portion is defined strictly by the message type (pm_type).
*/
struct pmmsg {
    char pm_type;           /* type of message */
    uchar pm_state;        /* current state of pm */
    char pm_maxclass;      /* max message class this port
monitor
                           understands */
    char pm_tag[PMTAGSIZE + 1]; /* pm's tag */
    int pm_size;           /* size of opt data portion */
};
```

EXAMPLE F-2 sac.h Header File (Continued)

```
/*
 * pm_type values
 */
# define PM_STATUS 1 /* status response */
# define PM_UNKNOWN 2 /* unknown message was received */
/*
 * pm_state values
 */
/*
 * Class 1 responses
 */
# define PM_STARTING 1 /* monitor in starting state */
# define PM_ENABLED 2 /* monitor in enabled state */
# define PM_DISABLED 3 /* monitor in disabled state */
# define PM_STOPPING 4 /* monitor in stopping state */
/*
 * message to port monitor
 */
struct sacmsg {
    int sc_size; /* size of optional data portion */
    char sc_type; /* type of message */
};
/*
 * sc_type values
 * These represent commands that the SAC sends to a port monitor.
 * These commands are divided into "classes" for extensibility.
Each
 * subsequent "class" is a superset of the previous "classes" plus
 * the new commands defined within that "class". The header for
all
 * commands is identical; however, a command may be defined such
that
 * an optional data portion may be sent in addition to the header.
 * The format of this optional data piece is self-defining based
on
 * the command. Important note:the first message sent by the SAC
is
 * always be a class 1 message. The port monitor response
indicates
 * the maximum class that it is able to understand. Another note
is
 * that port monitors should only respond to a message with an
 * equivalent class response (i.e. a class 1 command causes a
class 1
 * response).
 */
/*
 * Class 1 commands (currently, there are only class 1 commands)
 */
# define SC_STATUS 1 /* status request */
# define SC_ENABLE 2 /* enable request */
# define SC_DISABLE 3 /* disable request */
# define SC_READDB 4 /* read pmtab request */
```

EXAMPLE F-2 sac.h Header File (Continued)

```
/*
 * 'errno' values for Saferrno, note that Saferrno is used by both
 * pmadm and sacadm and these values are shared between them
 */
# define E_BADARGS 1 /* bad args/ill-formed cmd line */
# define E_NOPRIV 2 /* user not priv for operation */
# define E_SAFERR 3 /* generic SAF error */
# define E_SYSERR 4 /* system error */
# define E_NOEXIST 5 /* invalid specification */
# define E_DUP 6 /* entry already exists */
# define E_PMRUN 7 /* port monitor is running */
# define E_PMNOTRUN 8 /* port monitor is not running */
# define E_RECOVER 9 /* in recovery */
```

Logic Diagram and Directory Structure

Figure F-1 is a logical diagram of the SAF. It illustrates how a single service access controller can spawn a number of port monitors on a per-system basis. This technique means that several monitors can run concurrently, providing for the simultaneous operation of several different protocols.

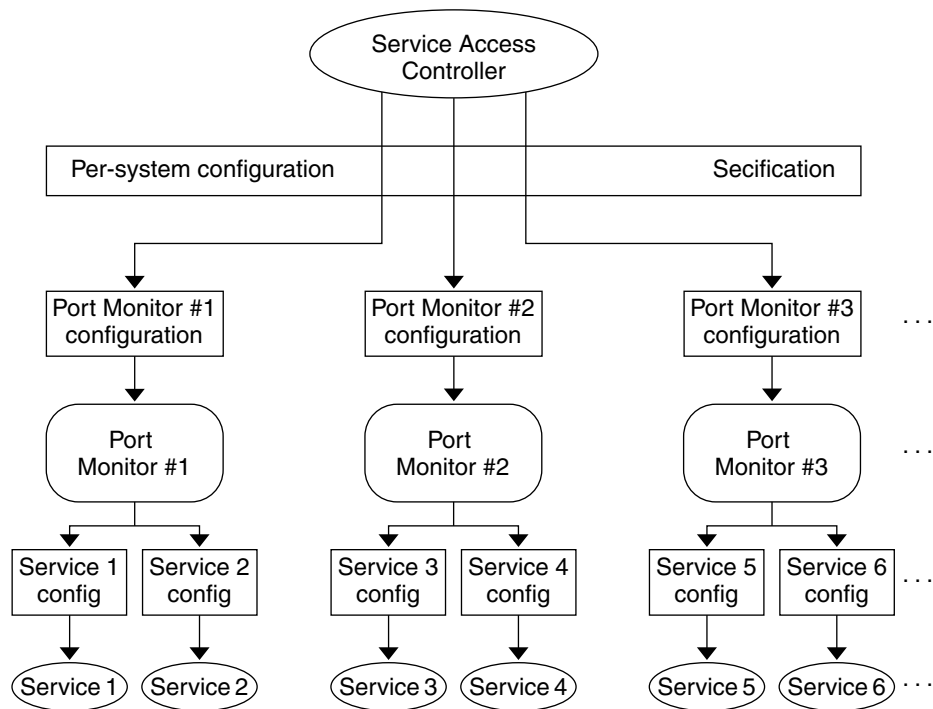

FIGURE F-1 SAF Logical Framework

The following figure shows is the corresponding directory structure diagram. Following the diagram is a description of the files and directories.

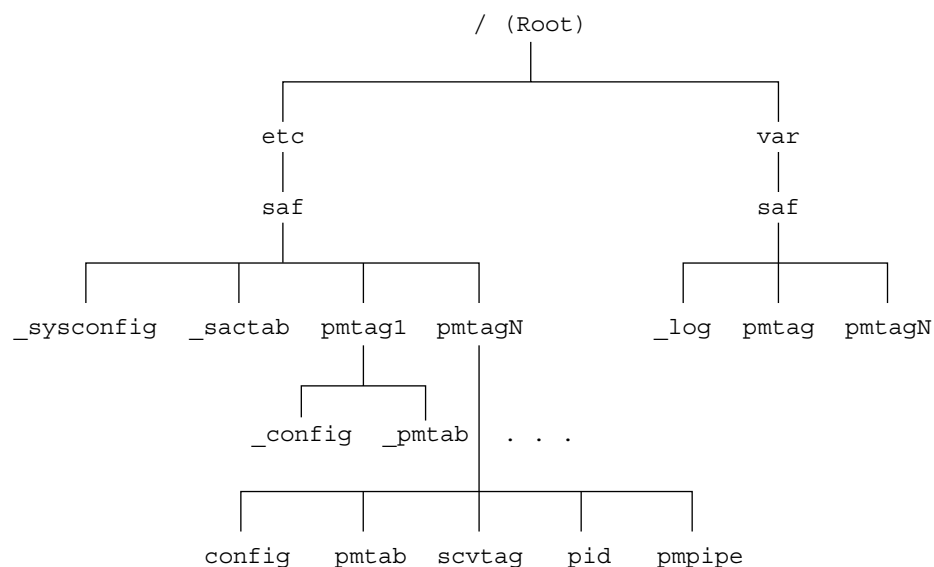

FIGURE F-2 SAF Directory Structure

The scripts and files in the SAF directory structure are:

- `/etc/saf/_sysconfig` The per-system configuration script.
- `/etc/saf/_sactab` The SAC's administrative file. Contains information about the port monitors for which the SAC is responsible.
- `/etc/saf/pmtag` The home directory for port monitor *pmtag*.
- `/etc/saf/pmtag/_config` The per-port monitor configuration script for port monitor *pmtag*.
- `/etc/saf/pmtag/_pmtab` Port monitor *pmtag*'s administrative file. Contains information about the services for which *pmtag* is responsible.
- `/etc/saf/pmtag/svctag` The file in which the per-service configuration script for service *svctag*, available through port monitor *pmtag*, is placed.
- `/etc/saf/pmtag/_pid` The file in which a port monitor writes its process ID in the current directory and places an advisory lock on the file.
- `/etc/saf/pmtag/_pmpipe` The file in which the port monitor receives messages from the SAC and `../_sacpipe` and sends return messages to the SAC.
- `/var/saf/_log` The SAC's log file.
- `/var/saf/pmtag` The directory for files created by port monitor *pmtag*, for example its log file.

Glossary

RPC Programming Terms

The following terms define the RPC concepts used throughout this manual.

client	A process that remotely accesses resources of a computer server
client handle	A client process data structure that represents the binding of the client to a particular server's RPC program.
connectionless transport	Characteristic of the model of interconnection in which communication takes place without first establishing a connection. See <i>datagram transport</i> .
connection-oriented transport	Characteristic of the model of interconnection in which communication proceeds through three well-defined phases: connection establishment, data transfer, and connection release. See <i>stream transport</i> .
datagram transport	A message and the Internet source and destination addresses that are associated with it. Datagram transports have less overhead than connection-oriented transports but are considered less reliable. Data transmissions are limited by buffer size.
deserialize	To convert data from XDR format to a machine-specific representation.
handle	An abstraction used by the service libraries to refer to a file or a file-like object such as a socket.
host	A computer system that is accessed by computers and/or workstations at remote locations. Usually the host contains the data, but in networks, the remote locations can be the host and provide information to the network.

MT hot	Characteristic of an interface in which the library or call automatically creates threads.
MT safe	Characteristic of an interface that can be called in a threaded environment. An MT-safe interface can be invoked concurrently for multiple threads.
network client	A process that makes remote procedure calls to services.
network server	A network device that manages resources and supplies services to a client.
network service	A collection of one or more remote service programs.
ping	A service that verifies activity on a remote system. A computer sends a small program to a host and notes time on its return path.
remote program	A program that implements one or more remote procedures.
RPC language (RPCL)	A C-like programming language translated by the <code>rpcgen</code> compiler. RPCL is a superset of XDR Language.
RPC library	The network services library, <code>libnsl</code> , specified to the link editor at compile time. Also known as the RPC package.
RPC protocol	The message-passing protocol that is the basis of the RPC package.
RPC/XDR	A standard for machine-independent data structures. See <i>RPC language</i> .
serialize	To convert data from a machine representation to XDR format.
server	A network device that manages resources and supplies services to a client.
transport	The fourth layer of the Open Systems Interconnection (OSI) Reference Model.
transport handle	An abstraction used by the RPC libraries to refer to the transport's data structures.
TI-RPC	Transport-independent RPC. The version of RPC supported in SunOS 5.0 and compatible versions.
TS-RPC	Transport-specific RPC. The version of RPC supported in SunOS 4.0 and compatible versions. TS-RPC is also supported in SunOS 5.0 and compatible versions.
universal address	A hexadecimal address of a type of network, such as TCP/IP, that configures the port monitor to check for print requests from print clients on a network.
virtual circuit transport	An apparent connection between processes that is facilitated by transmission control protocol (TCP). A virtual circuit enables applications to "talk" to each other as if they had a physical circuit.

XDR Language

A data description language and data representation protocol.

Index

Numbers and Symbols

_1 suffix, 46, 80
32-bit system, 72
64-bit system, 74

A

access control
 authentication, 119
 port monitors and, 324
add
 NIS+ database entries, 199
add.x source file, 56
add.x source file, 57, 62, 65
adding
 port monitor services, 330
 port monitors, 322
addition
 of address registrations, 37
 of NIS+ group members, 198
 of NIS+ table entry objects, 197
addition of
 NIS+ table entry objects, 204
ADDPORG program, 305
addresses
 information reporting for, 39
 look-up services, 37
 management functions, 148
 mapping RPC services, 21
 name-to-address translation routines, 37
 network, 315
 overview, 315

addresses (*continued*)
 pass server's address to client, 92
 pass user's bind address, 95
 passing arguments as, 45, 80
 registering, 21
 transport (netbuf), 38
 universal, 37, 277, 315
 unregistering, 318
ah_cred field, 99
ah_key field, 121
ah_verf field, 99
allocating memory, 21
ANSI C standards
 rpcgen tool, 42, 55, 66
application programming interface (API)
 NIS+, 197, 200
applications
 porting from TS-RPC to TI-RPC, 143
arguments (remote procedures)
 pass arbitrary data types, 81, 85
 pass open TLI file descriptors, 92, 95
 pass server's address to client, 92
 pass user's bind address, 95
 passing by address, 45, 80
 passing by value, 57, 59
 void, 270
arrays, 21
 convert to XDR format, 84, 106
 declarations
 RPC language, 267
 XDR language, 290, 298
 XDR code examples, 225, 228
asynchronous mode, 109, 111

- AUTH_BADCRED error, 261
- AUTH_DES authentication, 120, 254, 259
 - common key, 258
 - conversation key, 255, 257, 259
 - credentials, 120, 256
 - Diffie-Hellman encryption, 121, 258
 - errors, 256
 - handle, 120
 - nicknames, 256
 - protocol in XDR language, 256, 259
 - server, 121
 - time synchronization, 121, 256
 - verifiers, 255, 258
- AUTH_KERB authentication, 122
 - and NFS, 261
 - credentials, 122, 260, 262
 - encryption, 122
 - errors, 260
 - NFS, 260
 - nicknames, 123, 260
 - protocol in XDR language, 261, 263
 - time synchronization, 122, 262
 - verifiers, 122, 261
- AUTH_NONE authentication, 252
- AUTH_REJECTEDVERF error, 261
- AUTH_SHORT verifier, 253
- AUTH_SYS authentication, 253
- AUTH_TIMEEXPIRE error, 261
- AUTH_TOOWEAK error, 261
- AUTH_UNIX (AUTH_SYS)
 - authentication, 254
- authentication
 - access control, 119
 - allocating authentication numbers, 252
 - AUTH_DES, 120, 259
 - AUTH_KERB, 122, 263
 - AUTH_NONE, 252
 - AUTH_SHORT, 253
 - AUTH_SYS (AUTH_UNIX), 253
 - credentials
 - AUTH_DES, 120, 256
 - AUTH_KERB, 122, 260, 262
 - window, 120, 122, 256
 - window (lifetime) of, 257, 262
 - destroying an, 117
 - errors
 - AUTH_DES, 256
 - AUTH_KERB, 260

- authentication (*continued*)
 - handles, 99, 120
 - low-level data structures and, 99
 - methods supported, 116
 - nicknames, 123
 - AUTH_DES, 256
 - AUTH_KERB, 123, 260
 - NIS+, 195
 - overview, 252
 - registering authentication numbers, 252
 - RPC protocol and, 246
 - rpcgen tool, 70
 - servers, 117, 119, 121
 - service-dispatch and routine, 117
 - service-dispatch routine, 117
 - time synchronization
 - AUTH_DES authentication, 121, 255
 - AUTH_KERB authentication, 122, 262
 - verifiers
 - AUTH_DES, 255
 - AUTH_KERB, 122, 261
 - AUTH_SYS, 253
- authorization, 21
 - NIS+, 195
- Automatic MT mode, 21

B

- batched, 116, 248, 310, 313
- bcast.c program, 111
- binding, 21
 - dynamic, 316
 - TI-RPC, 245
- Booleans
 - RPC language, 271
 - XDR language, 284
- bottom-level interface routines (RPC), 96
- broadcast RPC, 111
- broadcast RPC, 33, 68, 112, 147
 - overview, 249
 - routines, 113
 - server response, 112
- buffer size
 - specify send and receive, 92, 95
- byte arrays, 21
 - XDR, 225

C

C

- rpcgen tool, 66
 - ANSI C compliance, 42, 55, 66
 - C-style mode, 42, 55, 57, 59
 - preprocessing directives, 54, 68
- rpcgen tool and
 - C-style mode, 270
- C-style mode
 - rpcgen tool, 42, 55, 57, 59, 270
- caching
 - NIS+, 196
 - server, 98
- call semantics
 - TI-RPC, 31, 245
- callback procedures, 140
 - and transient RPC program numbers, 140
 - NIS+, 206
 - RPCSEC_GSS, 132
 - uses, 140
- CBC (cipher block chaining) mode, 122
- cd command, 338
- change
 - NIS+ table entry objects, 198
- changes
 - port monitor configuration scripts, 338
- changing
 - port monitor configuration scripts, 339
 - port monitor services, 330
- cipher block chaining (CBC) mode, 122
- circuit-oriented transports
 - when to use, 36
- circuit_v transport type, 36
- cl_auth field, 99
- classes of messages, 328
- client authentication, 21
- client handles, 33
 - creating, 86
 - expert-level interface, 92, 95
 - intermediate level interface, 90
 - top-level interface, 47, 88
 - top-level level interface, 33
 - creation
 - bottom-level interface, 97
 - top-level interface, 47
 - destroying
 - top-level interface, 47
- client handles (*continued*)
 - destruction
 - expert-level interface, 95
 - top-level interface, 87
 - low-level data structures, 99
 - low-level data structures for, 98
- client programs
 - and rpcgen tool, 49
 - directory listing service, 305
 - remote copy, 104
 - rpcgen tool
 - ANSI C-compliance, 66
 - complex data structure passing, 51, 53
 - debugging, 74
 - directory listing service, 51, 53
 - message printing code example, 46, 49
 - MT-safety, 42, 62, 64
 - overview, 42, 46
 - simplified interface, 80
- client stub routines
 - rpcgen tool, 41, 47
 - C-style mode, 57
 - MT Auto mode, 65
 - MT-safe, 60
 - MT-unsafe, 61
 - preprocessing directive, 54
- client templates
 - rpcgen tool, 42, 55
- client time-out periods, 33
 - creation of timed clients, 88, 91
 - rpcgen tool, 70
- clients
 - batched, 113, 115, 310
 - multiple versions, 139
 - multithreaded, 153
 - safety, 59, 61, 64, 77
 - User mode, 160, 163
 - NIS+, 196
 - transaction IDs and, 245
 - TS-RPC and TI-RPC, 149
- _clnt.c suffix, 48
- clnt_create routine
 - code example, 47
- clnt_perror routine, 75
- clnt_sperror routine, 75
- clock synchronization, 21
- comments
 - XDR language, 296

- compatibility
 - library functions, 146, 148
- compilation
 - NIS+, 202
 - rpcgen tool, 42, 57, 59
- complex data structures, 21
 - packing with xdr_inline, 55, 67
 - rpcgen tool, 49, 53
- compound data type filters
 - XDR, 84, 224
- _config file, 335, 339
- config file, 334
- configuration scripts, 21
 - configuration scripts
 - printing, 339
- connection-oriented endpoints, 100
- connection-oriented transports, 21
 - and port monitors, 135
 - client handle creation for, 35
 - nettype parameters for, 36
 - remote copy code example, 103, 106
 - server handle creation for, 35
- connectionless transports, 21
 - client handle creation for, 35
 - nettype parameters for, 36
 - server handle creation for, 35
 - UDP, 21, 277
- constants
 - RPC language, 266
 - XDR language, 293, 296, 298
- constructed data type filters
 - XDR, 84, 224
- conversation key
 - AUTH_DES authentication, 255, 257, 259
- conversion
 - of local procedures to remote
 - procedures, 43, 49
 - to XDR format, 49, 53, 218
- convert
 - addresses, 145
 - from XDR format, 81, 89, 106, 219
 - to XDR format, 85, 106, 215, 220
- converting
 - addresses, 37
 - to XDR format, 81
- copy
 - NIS+ database entries, 199
 - NIS+ objects, 200

- copy (*continued*)
 - NIS+ table entry objects, 198
- copying
 - remote, 103, 106
- counted byte strings, 21
- cpp directive
 - rpcgen tool, 55
- crashes
 - server, 245, 256
- create
 - NIS+ databases, 199
 - NIS+ directory objects, 202
 - NIS+ group objects, 203
 - NIS+ table objects, 203
- creating
 - utmpx entries, 324, 331, 334
- creation
 - of NIS+ group objects, 198
- creation of
 - NIS+ table objects, 205
- credentials
 - AUTH_DES, 256
 - AUTH_DES, 120, 257
 - AUTH_KERB, 122, 260, 262
 - window, 120, 122
 - window (lifetime) of, 256, 262

D

- daemons
 - kerbd, 260
 - rpcbind, 38
- data representation, 21
 - TI-RPC, 31
- data structures, 21
 - conversion to XDR format, 85
 - converting to XDR format, 216
 - low-level, 98
 - MT safe, 160
 - packing with xdr_inline, 55, 67
 - recursive, 238, 241, 295
 - rpcgen tool, 49, 53
 - structure declarations, 21
- data types
 - pass arbitrary, 85
 - passing arbitrary, 81
- database access functions (NIS+), 197, 199

- datagram_ntransport type, 36
- datagram transports, 21
 - and broadcast RPC, 111
 - nettype parameters, 35
 - when to use, 36
- datagram_vtransport type, 36
- date service
 - intermediate level client for, 90
 - intermediate level server for, 91
 - top-level client for trivial, 86, 88
 - top-level server for, 88
- deallocating memory, 21
- debug
 - raw mode, 103
- debugging
 - and rpcgen tool, 75
 - rpcgen tool, 68, 74
- declarations
 - RPC language, 266, 271
 - XDR language, 282, 295
- defaults
 - maximum number of threads, 157
 - rpcgen tool, 21
 - single-threaded mode, 155
- define statements, command line, rpcgen tool, 68
- delete
 - NIS+ directory from host, 199
 - NIS+ group objects, 212
 - NIS+ table entry objects, 212
- deleting, 21
 - address registrations, 21
 - port monitor services, 330
 - port monitors, 322
- memory, releasing, 21
- deletion
 - of associations, 34
 - of mappings, 34
 - of NIS+ group members, 198
 - of NIS+ group objects, 198
 - of NIS+ table entry objects, 198
- deletion of
 - NIS+ group objects, 209
 - NIS+ objects from namespace, 208
 - NIS+ table entry objects, 209
- DES encryption, 121, 255
- deserial, 219
- deserializing, 21

- destroy
 - NIS+ objects, 200
- destroying, 21
 - client handles, 47
- destruction
 - of client handles, 95
 - XDR streams, 233
- destruction of
 - client authentication handles, 117
 - client handles, 87
 - server handles, 147
- Diffie-Hellman encryption, 121, 255, 258
- dir_proc.c routine, 50
- dir_proc.c routine, 51
- dir.x program, 49, 301
- dir.x program, 50
- directories
 - remote directory listing service, 49, 53, 301, 305
 - SAF, 347
- disabling port monitors, 21, 324, 326
- discriminated unions
 - declarations
 - RPC language, 269
 - XDR language, 269, 292, 298
 - XDR code samples, 230
- dispatch tables
 - rpcgen tool, 71
- doconfig function, 324, 333, 335
- domains (NIS+), 194, 196
 - functions, 198, 200
- dynamic binding, 316
- dynamic program numbers, 140, 247

E

- ECB (electronic code book) mode, 122
- electronic code book (ECB) mode, 122
- enabling
 - port monitors, 324, 326
 - server caching, 98
- encryption
 - AUTH_DES authentication
 - (Diffie-Hellman), 121, 255, 258
 - AUTH_KERB authentication, 122
 - privacy service, 124

- endpoints
 - connection-oriented, 100
- enumeration filters
 - XDR primitives, 223
- enumerations
 - RPC language, 50, 265
 - XDR language, 284
- errors
 - authentication
 - AUTH_DES, 256
 - AUTH_KERB, 260
 - client handle creation, 87
 - multiple client version, 139
 - NIS+ error message display functions, 197, 199
 - RPC, 48, 75, 246
 - /etc/gss/mech, 134
 - /etc/gss/qop, 134
 - /etc/inet/inetd.conf file, 135
 - /etc/netconfig database, 35, 146
 - /etc/netconfig database, 68
 - /etc/rpc database, 32
 - /etc/saf/_pid file, 324, 334, 341
 - /etc/saf/_config file, 334, 339
 - /etc/saf/_pmpipe file, 326, 334
 - /etc/saf/_pmtab file, 325, 329, 331, 334
 - /etc/saf/_svctag file, 331, 334
 - _pmtab, 330
 - /etc/saf/_sactab files, 329
 - /etc/saf/_sysconfig file, 335, 338
- expert-level interface routines (RPC), 92, 96
 - client, 95
 - overview, 92
 - server, 96
- external data representation, 21

F

- file data structure
 - XDR language, 298
- file descriptors, pass open TLI, 95
- file descriptors, passing open TLI, 92
- file system, 21
- filters (XDR)
 - arrays, 225, 228
 - constructed (compound) data type, 84, 224
 - enumeration, 223

- filters (XDR) (*continued*)
 - floating point, 223
 - number, 82, 222
 - opaque data, 229
 - strings, 84, 224
 - unions, 230
- fixed-length arrays, 21
 - declarations
 - RPC language, 267
 - XDR language, 290
 - XDR code sample, 229
- fixed-length opaque data
 - XDR language, 287
- flags, *See* rpcgen tool, flags
- floating point
 - XDR language, 285, 287
- floating point filters
 - XDR primitives, 223
- free routine, 53
- freeing resources, 21

G

- groups (NIS+), 195
 - manipulation functions, 197
 - sample programs, 203, 209, 212

H

- handles, 21
 - authentication, 99, 120
- transport handles, 21
- header files
 - rpcgen tool, 48, 54

I

- I/O streams
 - XDR, 234
- .isuffix, 71
- identification
 - of remote procedures, 246
 - remote procedures, 245, 248
- identifiers
 - XDR language, 296

- identifying, 21
 - port monitor services, 330
 - remote procedures, 32
- naming, 21
- index table
 - rpcgen tool, 54
- indirect RPC, 276
- inetd port monitor, 135
 - RPC services, 136
- inetd port monitor
 - rpcgen tool, 48
- inetd port monitor
 - rpcgen tool, 69
- information
 - remote host status, 154
- information reporting
 - addresses, 39
 - NIS+, 198
 - RPC, 39
 - server callbacks, 140
- installing port monitor configuration
 - scripts, 338
- integers, 21
 - XDR language, 215
- integrity, 123
- interfaces, *See* RPC (remote procedure call),
 - interface routines
- intermediate level interface routines, 33
- intermediate level interface routines (RPC), 89
- Internet protocols, *See* TCP (Transport Control Protocol)
- ISTATE environment variable, 324, 326, 333
- IXDR_GET_LONG, 74
- IXDR_PUT_LONG, 74

K

- kerbd daemon, 259
- Kerberos authentication, 21
- keywords
 - RPC language, 50
 - XDR language, 297
- KGETKCRED procedure, 259
- KGETUCRED procedure, 259
- KSETKCRED procedure, 259

L

- lib library, 53
- libc library, 145
- libnsl library, 48, 145
- libnsl library, 50
- libraries
 - and rpcgen tool
 - libnsl, 146
 - lib, 53
 - libc, 145
 - libnsl, 48, 50, 145
 - librpcsvc, 77
 - lthread, 154
 - RPC functions, 146, 148
 - rpcgen tool, 145
 - libnsl, 48, 50
 - selecting TI-RPC or TS-RPC library, 42, 55, 66
 - XDR, 21, 218, 220
- librpcsvc library, 77
- lifetime of credentials, *See* window of credentials
- limits
 - broadcast request size, 111
 - maximum number of threads, 157
- linked lists
 - XDR, 238, 241, 295
- list
 - NIS+ objects, 200, 206, 208
 - NIS+ principals, 199
 - NIS+ servers, 199
 - NIS+ table objects, 205, 208
- listen port monitor, 135
 - administrative command for, 325
 - rpcgen tool, 48, 69
 - using, 136
- listing, 21
 - portmap mappings, 319
 - remote directory listing service, 49, 53, 301, 305
 - rpcbind mappings, 275
 - rpcbind mappings, 32
- live code examples, 301, 305, 313
 - batched code, 310, 313
 - directory listing program, 301, 305
 - print message program, 307, 310
 - spray packets program, 306
 - time server program, 305

loading, *See* binding
local procedures
 conversion to remote procedures, 43, 49
locks
 mutex, multithreaded mode and, 155
 port monitor IDs and lock files, 324, 334
log functions
 NIS+ transaction, 197, 200
low-level data structures, 98
lthread library, 154

M

main server function, 69
makefile templates
 rpcgen tool, 42, 56
map, 34
mapping, 21
rpcbind routine, 21
master servers
 NIS+, 194, 196, 211
maximums
 broadcast request size, 111
 number of threads, 157
mechanism, security, 124
memory, 220
 allocating with XDR, 106
 releasing, 62, 85
 `clnt_destroy` routine, 47
 `free` routine, 53
 NIS+, 197
 XDR_FREE operation, 224
 `xdr_free` routine, 53
 XDR primitive requirements, 222, 224
memory streams
 XDR, 234
message classes, 328
message interface (SAF), 326, 328, 334, 340, 345
modifying, *See* changing
`msg_clnt.c` routine, 48
`msg.h` header file, 48
`msg_svc.c` program, 48
`msg_svc.c` routine, 48
`msg.x` program, 59
MT Auto mode, 155, 157, 160
 code examples, 158, 160
 rpcgen tool, 42, 55, 65

MT Auto mode (*continued*)
 service transport handle, 156
MT RPC programming, *See* multithreaded RPC programming
MT-safe code, 21
 clients, 42, 59, 61, 64, 77
 rpcgen tool, 42, 55, 59, 65
 servers, 41, 61, 64, 77, 155
MT User mode, 21, 155, 160
multiple client versions, 139
multiple server versions, 137
multithreaded Auto mode, *See* MT Auto mode
multithreaded RPC program
 clients, 153
 User mode, 160, 163
 library, 154
 maximum number of threads, 157
 performance enhancement, 158, 163
 servers, 156
 Auto mode, 155, 160
 timing diagram, 156
 User mode, 155, 160, 163
multithreaded RPC programming, 21, 153
 clients
 safety, 42, 59, 61, 64, 77
 rpcgen tool, 42, 55, 59, 66
 servers, 153, 155
 Auto mode, 42, 55, 65
 safety, 41, 61, 64, 77, 155
multithreaded-safe code, *See* MT-safe code
multithreaded user mode, 155
multithreaded User mode, 156, 160
mutex locks
 and multithreaded mode, 155

N

Name Service Switch, 195
name-to-address translation, 37, 145
names
 netnames, 120
naming
 client stub programs by rpcgen, 48
 netnames, 254
 programs by version number, 137
 remote procedure calls by rpcgen, 46
 server programs by rpcgen, 48

- naming (*continued*)
 - standard for, 255
 - template files for rpcgen, 56
- NIS+ (Network Information Services Plus), 21
- naming service, *See* NIS+ (Network Information Services Plus)
- netconfig database, 35, 68, 146
- netnames, 120, 254
- NETPATH environment variable, 35, 68, 87
- nettype parameters, 35
- network addresses, 21
- network file system, *See* NFS (network file system)
- Network Information Services Plus, *See* NIS+ (Network Information Services Plus)
- network names, 120, 254
- network pipes, 215
- network selection
 - RPC, 35
 - rpcgen tool, 68
- Newstyle (C-style) mode
 - rpcgen tool, 42, 55, 57, 59
- NFS
 - Kerberos authentication, 260
 - NFSPROC_GETATTR procedure, 260
 - NFSPROC_STATVFS procedure, 261
- nicknames
 - AUTH_DES, 257
 - AUTH_DES, 256, 258
 - AUTH_KERB, 261
 - AUTH_KERB, 123, 260, 262
- NIS+, 196, 212
 - application programming interface (API), 197, 200
 - compilation, 202
 - database access functions, 197, 199
 - domains, 194, 196
 - functions, 198
 - error message display functions, 197, 199
 - groups, 195
 - sample programs, 203, 209, 212
 - local name functions, 197, 200
 - miscellaneous functions, 197, 200
 - Name Service Switch, 195
 - namespace administration commands, 195
 - objects, 196
 - manipulation functions, 197
 - sample programs, 202, 212
- NIS+ (*continued*)
 - overview, 27
 - sample program, 200, 212
 - security, 195
 - servers, 194
 - functions, 197, 199
 - sample program, 211
 - tables, 194
 - access functions, 197
 - sample programs, 203, 205
 - time synchronization, 200
 - transaction log functions, 197, 200
 - unsupported macros, 201
- NIS+ (
 - groups
 - manipulation functions, 197
- NIS+ Information
 - objects, 195
- NIS+ Plus
 - groups
 - manipulation functions, 198
- nlsadmin command, 325
- NULL arguments, 80
- NULL pointers, 233
- NULL strings, 271
- NULL transport type, 35
- number filters, XDR, 21, 82, 222
- number of users
 - on a network, 119
 - on a remote host, 77
- numbers, 21
- version numbers, 21

O

- objects (NIS+), 196
 - manipulation functions, 197, 200
 - sample programs, 202, 212
- ONC+ overview, 25, 27
- opaque data
 - declarations
 - RPC language, 271
 - XDR language, 287, 289
 - XDR code examples, 229
- open TLI file descriptors
 - passing, 92, 95

optional-data unions
XDR language, 294

P

parameters, *See* arguments
passing parameters, *See* arguments
_pid file, 324, 334, 341
ping program, 263
pipes
network, 215
_pmpipe file, 326, 334
_sacpipe file, 326, 334
pm_maxclass field, 328
pm_size field, 327
pmadm command, 137, 325, 330, 332, 339
PMAPPROC_CALLIT procedure, 319
PMAPPROC_DUMP procedure, 319
PMAPPROC_GETPORT procedure, 319
PMAPPROC_NULL procedure, 318
PMAPPROC_SET procedure, 318
PMAPPROC_UNSET procedure, 318
pmmmsg structure, 327
_pmpipe file, 326, 334
_pmtab file, 325, 329, 331, 334
/ directory, 326, 329
PMTAG environment variable, 326, 333
pointers
remote procedures, 45
RPC language, 268
XDR code examples, 232
poll routine, 109, 111
pop configuration-script keyword, 337
port monitors, 135
activity monitoring, 323
adding, 322
adding services, 330
administrative commands
monitor-specific command, 332
pmadm, 136, 325, 330, 332, 339
sacadm, 136, 322, 329, 331, 338
administrative files
_pmtab, 331
_pmtab, 325, 329, 334
_sactab, 329
administrative interface, 328, 334
changing port monitor services, 330

port monitors (*continued*)
configuration scripts, 335, 339
installation, 339
installing, 338
language for writing, 336, 338
per-port monitor, 334, 339
per-service, 324, 333, 339
per-system, 335, 338
printing, 338
replacement, 339
replacing, 338
deleting services, 330
disabling, 324, 326
enabling, 324, 326
files
administrative, 325, 329, 331, 333
key, 333
per-port monitor configuration, 334, 339
per-service configuration, 324, 333, 339
per-system configuration, 335, 338
private, 326, 329
process ID, 324, 334
functions, 322, 324, 334
identifying services, 330
management function, 323
message interface, 326, 328, 334, 340, 345
_pmpipe file, 326, 334
private files, 326, 329
process IDs and lock files, 324, 334
removing, 322
requirements for implementing, 333
restricting access to system, 324
rpcgen tool, 48, 69
sample code, 340
service interface, 332
terminating, 325, 334
types of, 329
utmpx entry creation, 324, 331, 334
version numbers, 331
writing with service access facility,
See SAF (service access facility)
port numbers, 21
getting for registered services, 315
TCP/IP protocol, 277, 318
UDP/IP protocol, 277, 318
porting data, *See* XDR (external data
representation)
porting TS-RPC to TI-RPC, 143

- port numbers (*continued*)
 - and name-to-address mapping, 145
 - and old interfaces, 145
 - applications, 143
 - benefits, 144
 - code comparison examples, 149
 - differences between TI-RPC and TS-RPC, 145, 149
 - function compatibility lists, 146, 148
 - libc library, 145
 - libnsl library, 145
 - preprocessing directives
 - rpcgen tool, 54, 68
 - printing, 21
 - message to system console, 43, 49, 307, 310
 - port monitor configuration scripts, 338
 - printmsg.c program
 - remote version, 44, 49
 - printmsg.c program
 - remote version, 308, 310
 - printmsg.c program
 - single process version, 44
 - printmsg.c program
 - single process version, 43, 307
 - privacy, 123
 - procedure-lists
 - RPC language, 265
 - procedure numbers, 21
 - error conditions, 246
 - procedures
 - registering as RPC programs, 33
 - registration as RPC programs, 81
 - RPC language, 265
 - program declarations
 - RPC language, 269
 - program definitions
 - RPC language, 265
 - program numbers, 21, 246, 248
 - assigning, 247
 - error conditions, 246
 - mapping
 - See* portmap routine
 - registering, 248
 - transient (dynamically assigned), 140, 247
 - PROGVERS_ORIG program name, 137
 - PROGVERS program name, 137
 - protocols, 21
 - AUTH_DES, 256
 - protocols (*continued*)
 - AUTH_DES, 259
 - specifying in RPC language, 44
 - XDR language, 21, 282
 - push configuration-script keyword, 336
- Q**
- quadruple-precision floating point
 - XDR language, 286
- R**
- raw RPC
 - testing programs using low-level, 103
 - REaddir procedure, 49, 53, 301, 305
 - record-marking standard, 252
 - record streams
 - XDR, 235, 252
 - recursive data structures, 238, 241, 295
 - registering
 - addresses
 - See* portmap routine
 - authentication numbers, 252
 - procedures as RPC programs, 33, 80
 - program numbers, 248
 - registration, 147
 - hand-coded registration routine, 81
 - procedures as RPC programs, 81
 - program version numbers, 137
 - releasing memory, *See* memory, releasing
 - remote directory listing service, 49, 53
 - remote procedure call, *See* RPC
 - remote procedures
 - conversion of local procedures, 49
 - conversion of local procedures to, 43
 - identification, 245
 - identifying, 32, 248
 - Remote Time Protocol, 54, 65
 - removing, 21
 - rendezvousing
 - TI-RPC, 245
 - replacing, *See* changing
 - replica servers
 - NIS+, 194, 196

- reporting, *See* information reporting
- r1s.c routine, 53
- RPC, 21
 - address look-up services, 34, 37
 - address registration, 21
 - address reporting, 39
 - address translation, 37, 145
 - asynchronous mode, 109, 111
 - batched, 113, 116, 248, 310
 - batching, 313
 - broadcast
 - See* broadcast RPC
 - errors, 75, 246
 - identification of remote procedures, 245
 - identifying remote procedures, 32, 246
 - indirect, 276
 - information report, 140
 - information reporting, 39
 - interface routines, 32, 77, 85
 - See* TI-RPC interface routines
 - bottom-level, 96
 - caching servers, 98
 - expert-level, 92, 96
 - intermediate level, 33, 89
 - low-level data structures, 98
 - simplified, 85
 - standard, 85
 - top-level, 47
 - multiple client versions, 139
 - multiple server versions, 137
 - name-to-address translation, 37, 145
 - network selection, 35
 - poll routine, 109, 111
 - port monitor usage, 137
 - protocol
 - See* TI-RPC protocol
 - record-marking standard, 252
 - standards, 30, 252
 - transient RPC program numbers, 140, 247
 - transport selection, 36
 - transport types, 35
- RPC (
 - identifying remote procedures, 248
- RPC (remote procedure call)
 - errors, 48
 - failure of, 48
 - interface routines
 - top-level, 48
- rpcgen tool, 21, 41, 72, 75, 305
- RPC_AUTHERROR error, 256
- RPC call
 - record-marking standard, 252
- RPC_CLNT preprocessing directive, 54
- rpc_createerr global variable, 87
- rpc_gss_principal_t principal name
 - structure, 129
- rpc_gss_principal_t principal structure
 - name, 129
- RPC_HDR preprocessing directive, 54
- RPC language
 - reference, 299
- RPC language (RPCL), 21, 263, 271
 - arrays, 267
 - Booleans, 271
 - C, 41
 - C-style mode and, 270
 - constants, 266
 - declarations, 266, 268
 - definitions, 265
 - discriminated unions, 50, 269
 - enumerations, 50, 265
 - example protocol described in, 44
 - fixed-length arrays, 267
 - keywords, 50
 - opaque data, 271
 - overview, 299
 - pointers, 268
 - portmap protocol specification, 317
 - program declarations, 269
 - simple declarations, 266
 - special cases, 270
 - specification, 263, 271
 - strings, 44, 271
 - structures, 50, 268
 - syntax, 264
 - type definitions, 266
 - unions, 50, 269
 - variable-length arrays, 267
 - voids, 271
 - XDR language, 263
 - XDR language vs., 264, 299
- RPC_SVC preprocessing directive, 54
- RPC_TBL preprocessing directive, 54
- RPC/XDR, *See* RPC language (RPCL)
- RPC_XDR preprocessing directive, 54

- rpcbind daemons
 - registering addresses with, 38
- rpcbind routine, 21
- rpcbind routine
 - time service, 255
- RPCBPROC_CALLIT procedure, 38
- RPCBPROC_GETTIME procedure, 255
- rpcgen tool
 - advantages, 42
 - arguments, 45, 57, 59, 80, 85, 270
 - authentication, 67, 70, 120, 123
 - batched code example, 310, 313
 - broadcast call server response, 68
 - C and, 66
 - ANSI C compliance, 42, 55, 66
 - C-style mode, 42, 55, 57, 59, 270
 - preprocessing directives, 54, 68
 - client handles and
 - See* client handles
 - client programs and
 - See* client programs
 - client stub routines and
 - See* client stub routines
 - compilation modes, 42, 57, 59
 - complex data structure passing, 49, 53
 - conversion of local procedures to remote
 - procedures, 43, 49
 - cpp directive, 55
 - debugging, 67, 74
 - defaults
 - argument passing mode, 57
 - C preprocessor, 55
 - client time-out period, 70
 - compilation mode, 42
 - library selection, 66
 - MT-safety, 42, 59
 - output, 41
 - server exit interval, 69
 - define statements on command line, 68
 - directory listing program, 49, 53, 301, 305
 - dispatch tables, 71
 - failure of remote procedure calls, 48
 - flags, 55
 - listed, 55
 - A (MT Auto mode), 55, 65
 - a (templates), 55
 - b (TS-RPC library), 55, 66
 - i (xdr_inline () count), 67
- rpcgen tool, flags (*continued*)
 - M (MT-safe code), 55, 59
 - N (C-style mode), 55, 57
 - Sc (templates), 55
 - Sm (templates), 55
 - Ss (templates), 55
- hand-coding vs., 81
- handles and
 - See* client handles
- libraries
 - libnsl, 48, 50, 145
 - selecting TI-RPC or TS-RPC library, 42, 55, 66
- MT (multithread) Auto mode, 42, 55, 65, 157, 160
- MT (multithread)-safe code, 42, 55, 59, 65
- naming remote procedure calls, 46
- network types/transport selection, 68
- Newstyle (C-style) mode, 42, 55, 57, 59
- optional output, 41
- pointers, 45
- port monitor support, 48, 69
- preprocessing directives, 54, 67
- print message program, 43, 49, 307, 310
- programming techniques, 67, 75
- server handles and
 - See* server handles
- server programs and
 - See* server programs
- server stub routines and
 - See* server stub routines
- socket functions, 66
- spray packets program, 306
- stub routines and
 - See* client stub routines
- templates, 42, 55
- TI-RPC and TS-RPC library selection, 66
- TI-RPC vs. TS-RPC, 145
- TI-RPC vs. TS-RPC library selection, 42, 55
- time-out changes, 70
- time server program, 54, 65, 305
- tutorial, 42, 55
- variable declarations and, 267
- xdr_inline () count, 67
- xdr_inline count, 55
- XDR routine generation, 49, 53, 213
- RPCPROGVERSISMATCH error, 139

- RPCSEC_GSS security flavor
 - /etc/gss/qop file, 134
 - etc/gss/mech/ file, 134
 - service
 - integrity, 123
- /rpcsvc directory, 248
- rstat program
 - multithreaded, 154
- run configuration-script keyword, 338
- runwait configuration-script keyword, 337

S

- SAC
 - key files, 329, 333
 - message interface, 326, 328, 334, 340
 - _sacpipe file, 326, 334
 - _sactab file, 329
 - sac.h header file, 343, 345
 - sacadm command, 137, 329, 331, 338
 - starting, 334, 336
- SAC (service access controller)
 - sacadm command, 322
- sac.h header file, 343, 345
- sacadm command, 137, 322, 329, 331, 338
- _sacpipe file, 326, 334
- _sactab file, 329
- SAF, 21
 - administrative interface, 334, 338
 - key files, 333
 - monitor-specific command, 332
 - pmadm command, 136, 325, 330, 332, 339
 - port monitor implementation
 - requirements, 333
 - port monitor responsibilities, 334
 - sacadm command, 137, 329, 331, 338
 - _pmtab file, 334
 - _pmtab file, 325, 331
 - _sactab file, 329
 - service interface, 332
 - configuration scripts, 335, 339
 - installing, 338
 - language for writing, 336, 338
 - per-port monitor, 334, 339
 - per-service, 324, 333, 339
 - per-system, 335, 338

- SAF, configuration scripts (*continued*)
 - printing, 338
 - replacing, 338
 - directory structure, 347
 - files used by, 325, 329, 331, 333
 - logic diagram, 345
 - message interface, 326, 328, 334, 340
 - overview, 324
 - port monitor functions and, 324, 334
 - SAC (service access controller) and, 324, 326, 328
 - sample code, 340
 - terminating port monitors, 325, 334
- SAF)
 - configuration scripts
 - per-service, 339
- SAF (service access facility)
 - administrative interface
 - _pmtab file, 329
- SAF (service access facility), 321
 - administrative interface, 328
 - sacadm command, 322
 - overview, 321
 - port monitor functions and, 322
 - SAC (service access controller) and, 322
- sc_size field, 328
- security, 21
 - mechanism, 124
 - NIS+, 195
 - service, 123
- authentication, 21, 123, 148, 252, 263
- semantics
 - TI-RPC call, 31, 245
- serialize, 106, 215, 220
- serialized, 85
- serializing, 21, 49, 53, 81, 218
- server handles, 21, 34
 - creating, 33, 35
 - expert-level interface, 96
 - intermediate level interface, 91
 - top-level interface, 89
 - creation, 147
 - expert-level interface, 95
 - top-level interface, 88
 - destruction, 147
 - low-level data structures, 99

- server programs
 - and rpcgen tool
 - client authentication, 117
 - debugging, 75
 - directory listing service, 303
 - remote copy, 105
 - rpcgen tool, 48
 - broadcast call response, 67
 - C-style mode, 58
 - client authentication, 67, 70
 - complex data structure passing, 50
 - debugging, 74
 - directory listing service, 50
 - MT Auto mode, 65
 - MT-safety, 41, 64
 - network type/transport selection, 68
 - overview, 42, 48
 - rpcgen tool and
 - client authentication, 117
 - directory listing service, 301
 - simplified interface, 80
 - transient RPC program, 140
- server stub routines, 21
 - rpcgen tool, 41, 48
 - ANSI C-compliant, 66
 - MT Auto mode, 65
 - MT-safe, 41, 61
 - preprocessing directive, 54
- server templates
 - rpcgen tool, 42, 55, 58
- server transport handle, 99
- servers, 21
 - and port monitors, 135, 137
 - authentication, 117, 119, 121
 - batched, 115, 310, 312
 - caching, 98
 - crashes, 245, 256
 - dispatch tables, 67, 71
 - exit interval, rpcgen tool, 69
 - multiple versions, 137
 - multithreaded, 153, 155
 - Auto mode, 42, 55, 65, 155, 160
 - safety, 41, 61, 64, 77, 155
 - User mode, 156, 160, 163
 - user mode, 155
 - NIS+, 194, 199
 - poll routine, 109, 111
 - transaction IDs and, 245
- service, 123
- service access controller, *See* SAC
- service access facility, *See* SAF
- service-dispatch routine
 - authentication, 117
- service transport handle (SVCXPRT), 156
- simple declarations
 - RPC language, 266
- simplified interface routines, 32
- simplified interface routines (RPC), 77, 85
 - hand-coded registration routine, 81
 - server, 80
 - XDR conversion, 85
 - XDR convert, 81
- single-threaded mode
 - as default, 155
 - poll routine, 111
 - poll routine and, 109
- socket functions, *See* TS-RPC (transport-specific remote procedure call)
- spray.x (spray packets) program, 306
- standard interface routines, 33
 - intermediate level routines, 33
- standard interface routines (RPC), 33, 85
 - bottom-level routines, 96
 - expert-level routines, 92, 96
 - intermediate level routines, 89
 - low-level data structures, 98
 - MT safety of, 77
 - top-level routines, 47, 86, 89
- standards
 - ANSI C standard, rpcgen tool, 42, 55, 66
 - naming standard, 255
 - record-marking standard, 252
 - RPC, 30, 252
 - XDR canonical standard, 217
- statistics, *See* information reporting
- status reporting, *See* information reporting
- stream transports, 21
- streams, *See* XDR (external data representation), streams
- STREAMS modules
 - and port monitor configuration, 337
 - port monitor configuration and, 339
- string declarations
 - RPC language, 44, 271
 - XDR language, 289
- string representation, 21

- string declarations (*continued*)
 - XDR routines, 84, 224
- structure declarations, 21
 - RPC language, 50, 268
 - XDR language, 292, 298
- stub routines, *See* client stub routines
- Sun RPC, *See* TI-RPC (transport-independent remote procedure call)
- _svc.c suffix, 48
- _svc suffix, 66
- svctag file, 331, 334
- SVCXPRT service transport handle, 135, 156
- synchronization, *See* time synchronization
- syntax
 - RPC language, 264
 - XDR language, 297
- _sysconfig file, 335, 338

T

- tables (NIS+), 194
 - access functions, 197
 - sample programs, 203, 205
- /tag directory, 21
- TCP, 21
 - porting TCP applications from TS-RPC to TI-RPC, 143
 - portmap port number, 318
 - portmap sequence, 316
 - server crashes and, 245
- TCP (
 - nettype parameter for, 36
- TCP (Transport Control Protocol)
 - RPC protocol and, 244
- TCP/IP protocol, *See* TCP (Transport Control Protocol)
- TCP/IP streams
 - XDR, 235, 252
- tcp transport type, 36
- templates
 - rpcgen tool, 42, 55
- terminating port monitors, 325, 334
- test
 - NIS+ groups, 199
 - programs using low-level raw RPC, 103
- thread.h file, 160

- thread library
 - thread, 154
- threads, *See* MT Auto mode
- TI-RPC, 21
 - address look-up services, 34, 37
 - address reporting, 39
 - address translation, 37, 145
 - call semantics, 31
 - data representation, 31
 - identifying remote procedures, 32, 245, 248
 - information report, 140
 - information reporting, 39, 140
 - interface routines, 32, 77, 85
 - bottom-level, 96
 - caching servers, 98
 - expert-level, 92
 - intermediate level, 33, 89
 - low-level data structures, 98
 - simplified, 77, 85
 - standard, 33, 85
 - top-level, 89
 - library selection, rpcgen tool, 66
 - name-to-address translation, 37, 145
 - network selection, 35
 - protocol, 31, 243, 245, 252
 - and authentication, 247
 - authentication, 246
 - binding and rendezvous
 - independence, 245
 - identification of procedures, 246
 - identification procedures, 248
 - identifying procedures, 32
 - in XDR language, 249, 252
 - record-marking standard, 252
 - transport protocols and semantics
 - and, 244
 - version number, 246
 - raw, test low-level programs, 103
 - transient RPC program numbers, 140, 247
 - transport selection, 36
 - transport types, 35
- TI-RPC (
 - protocol
 - identifying procedures, 245
- TI-RPC (transport-independent remote procedure call)
 - and library selection, rpcgen tool, 42

- TI-RPC (transport-independent remote procedure call) (*continued*)
 - interface routines
 - top-level, 47
 - library selection, rpcgen tool, 55
- time
 - obtaining current, 255
 - ping program, 263
- time-out periods
 - rpcgen tool, 67, 70
- time server program, 54, 65, 305
- time service
 - intermediate level client for, 90
 - intermediate level server for, 91
 - rpcbind routine, 255
 - top-level client for, 86, 88
 - top-level server for, 89
 - toplevel server for, 88
- time synchronization
 - AUTH_DES authentication, 121, 256
 - AUTH_KERB authentication, 262
 - AUTH_KERB authentication, 122, 262
 - NIS+, 200
- time.x program, 54, 65
- time.x program, 305
- timed client creation, 33
 - intermediate level interface, 91
 - top-level interface, 88
- TLI file descriptors
 - passing open, 92, 95
- top-level interface routines (RPC), 47, 86, 89
 - client, 47, 86, 88
 - overview, 86
 - server, 88
- top-level interface routines, 33
- transaction IDs, 32, 245
- transaction log functions (NIS+), 197
- transient program numbers, 140, 247
- transport handles
 - server, 99
 - SVCXPRT] service, 156
 - SVCXPRT service, 135
- transport-level interface file descriptors
 - passing open, 92, 95
- transport protocols, 21
 - RPC protocol and, 244
- transport selection
 - RPC, 36
- transport selection (*continued*)
 - rpcgen tool, 68
- transport-specific remote procedure call, 21
- transport types, 21
 - interfaces, 86
 - rpcgen tool, 68
- trees, 295
- TS-RPC (transport-specific remote procedure call)
 - library selection, rpcgen tool, 55
- ttyadm command, 325
- ttymon port monitor, 325
- tutorials
 - rpcgen tool, 42, 55
- type definitions
 - RPC language, 266
 - XDR language, 294, 298

U

- UDP, 21
 - broadcast RPC and, 111
 - nettype parameter for, 36
 - porting UDP applications from TS-RPC to TI-RPC, 143
 - portmap port number, 318
 - server creation routines for, 96
- UDP (user datagram protocol)
 - client creating routines for, 95
- UDP (User Datagram Protocol)
 - RCP protocol and, 244
- UDP (user datagram protocol)
 - server creation routines for, 98
- UDP/IP protocol, *See* UDP
- udp transport type, 36
- ulimit command, 338
- umask command, 338
- unions
 - declarations
 - RPC language, 50, 269
 - XDR language, 292, 294, 298
 - XDR code samples, 230
- universal addresses, 37, 277, 315
- unregistration, 147
- unsigned integers
 - XDR language, 283
- User MT mode, 155, 160

- user's bind address
 - pass, 95
- users
 - number of, 77
 - on a network, 119
- /usr/include/rpcsvc directory, 248
- /usr/share/lib directory, 53
- utmpx entries
 - creating, 324, 331, 334

V

- /var/saf/ directory, 326, 329
- variable declarations, 267
- variable-length array declarations, 21
 - RPC language, 267
 - XDR language, 291
- variable-length opaque data, 21
 - XDR language, 288
- verifiers
 - AUTH_DES, 255, 258
 - AUTH_KERB, 263
 - AUTH_KERB, 122, 261
 - AUTH_SYS, 253
- version-lists
 - RPC language, 265
- version numbers
 - assigning, 137
 - error conditions, 246
 - mapping, 21
 - message protocol, 246
 - multiple client versions, 139
 - multiple server versions, 137
 - port monitors, 331
 - registration of, 137
- versions, 21
 - library functions,, 148
 - library functions compatibility, 146
 - RPC language, 265
- visible transport type, 36
- void arguments, 270
- void declarations
 - RPC language, 271
 - XDR language, 293

W

- window of credentials
 - AUTH_DES authentication, 120, 257
 - AUTH_KERB authentication, 122, 262
 - window verifiers, 256

X

- .x suffix, 50
- XDR, 21
 - block size, 282
 - canonical standard, 217
 - conversion from (deserializing), 81, 107
 - conversion to (serializing), 49, 53, 81
 - convert from (deserialize), 220
 - convert from (deserializing), 106
 - convert to (serialize), 107, 220
 - convert to (serializing), 106
 - converting from (deserializing), 219
 - converting to (serializing), 218
 - cost of conversion, 217
 - direction determination for operations, 234
 - graphic box notation, 282
 - library, 21, 218, 220
 - linked lists, 238
 - optimizing routines, 234
 - primitive routines, 82, 218
 - arrays, 228, 230
 - byte arrays, 225
 - discriminated unions, 230
 - fixed-length arrays, 230
 - nonfilter, 233
 - opaque data, 229
 - pointers, 232
 - strings, 224
 - unions, 230
 - protocol
 - See XDR language
 - rpcgen tool, 49, 53
 - streams
 - accessing, 234
 - creation by RPC system, 218
 - implementing new instances, 236
 - implementing new instances of, 238
 - interface, 236, 238
 - memory, 234
 - nonfilter primitives, 233

- XDR, streams (*continued*)
 - record (TCP/IP), 236, 252
 - standard I/O, 234
 - treams
 - record (TCP/IP), 235
 - with memory allocation, 106
- XDR (external data representation)
 - file data structure in, 298
 - linked lists, 295
 - rpcgen tool, 54
- xdr_prefix, 50
- xdr_array routine, 228
- xdr_bytes routine, 225
- XDR_DECODE operation, 224
- XDR_ENCODE operation, 224
- XDR_FREE operation, 224
- xdr_inline count, 55, 67
- XDR language
 - authentication protocol, 259
 - arrays, 290, 298
 - AUTH_DES authentication protocol, 256
 - Booleans, 284
 - comments, 296
 - constants, 293, 296, 298
 - counted byte strings, 289
 - declarations, 282, 295
 - discriminated unions, 292, 294, 298
 - enumerations, 284
 - fixed-length arrays, 290
 - fixed-length opaque data, 287
 - floating point, 285, 287
 - identifiers, 296
 - keywords, 297
 - opaque data, 287, 289
 - optional-data unions, 294
 - overview, 281
 - quadruple-precision floating point, 286
 - RPC language, 263
 - RPC language vs., 299
 - RPC message protocol, 249, 252
 - specification for, 295
 - strings, 289
 - structures, 292, 298
 - syntax, 297
 - type definitions, 294, 298
 - unions, 292, 294, 298
 - unsigned integers, 283
 - variable-length arrays, 291
- XDR language (*continued*)
 - variable-length opaque data, 288
 - voids, 293
 - xdr_type (object) notation, 122
 - xdrs-x_op field, 234

